



1

-  S1 | 5.8 mm | x1
15/64" | x1
-  x1
-  x1



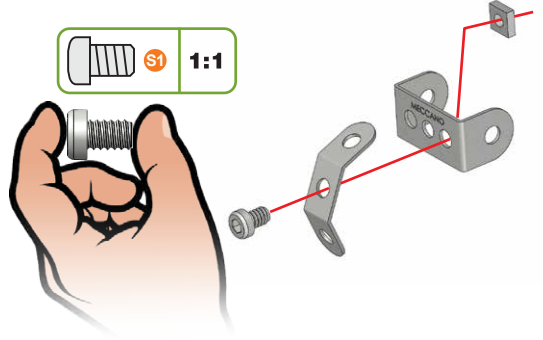

2

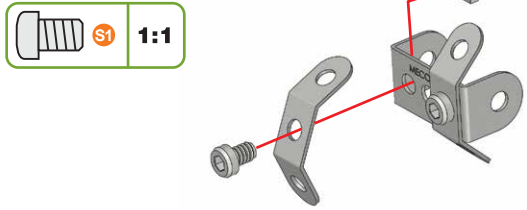
-  S1 | 5.8 mm | x1
15/64" | x1
-  x1





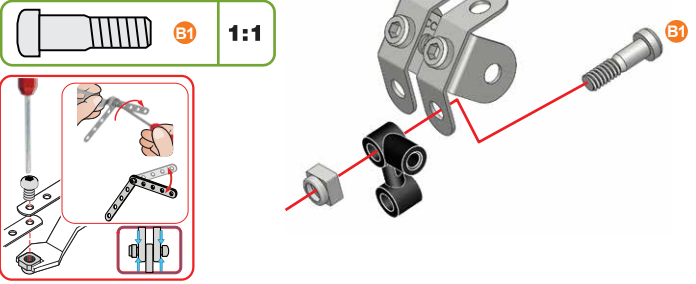

3

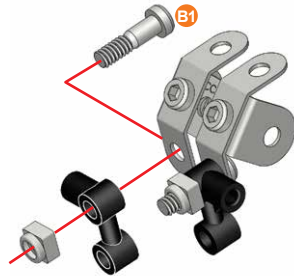
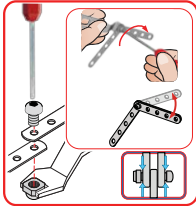
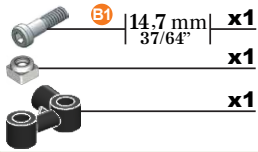
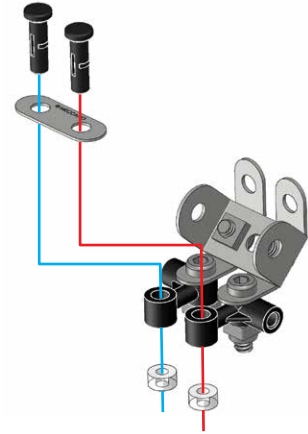
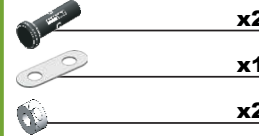
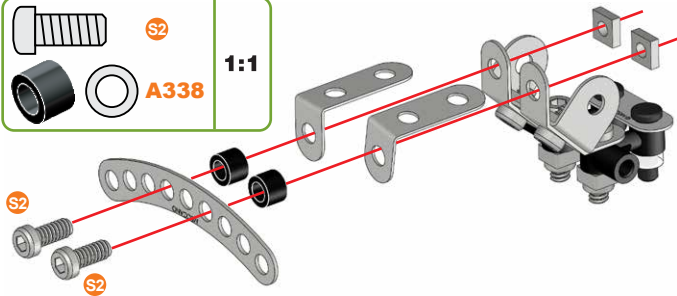
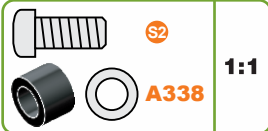
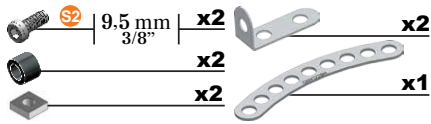
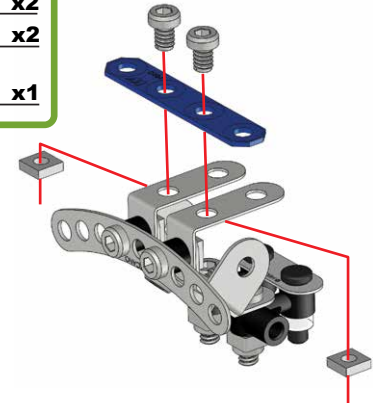
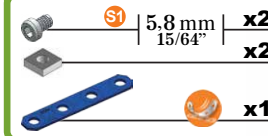
-  B1 | 14.7 mm | x1
37/64" | x1
-  x1
-  x1



4**5****6****7**



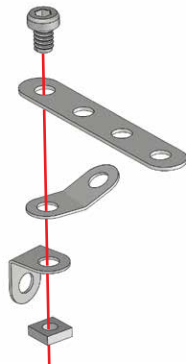

8

 S1	5.8 mm 15/64"	x1
		x1
		x1
		x1
		x1

 S1	1:1
---	------------



9

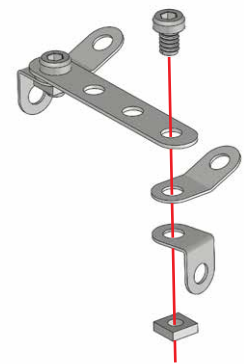

 S1	5.8 mm 15/64"	x1
		x1
		x1
		x1

 S1	1:1
---	------------



10



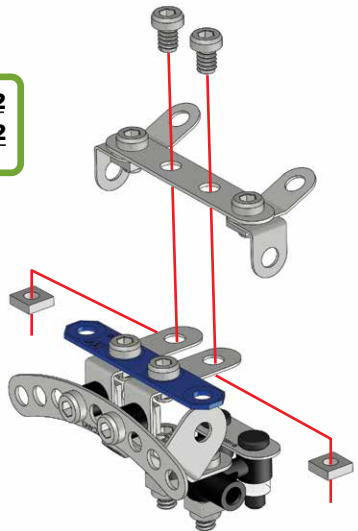

(7)+(9)+

 S1	5.8 mm 15/64"	x2
		x2

 S1	1:1
---	------------





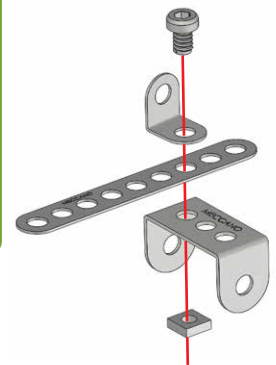

11

 S1	5.8 mm 15/64"	x1
		x1
		x1
		x1
		x1

 S1	1:1
---	------------





12

-  5.8 mm | x1
15/64"
-  x1
-  x1
-  x1

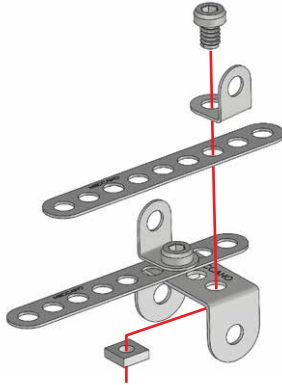
-  1:1





13

-  5.8 mm | x1
15/64"
-  x1
-  x1

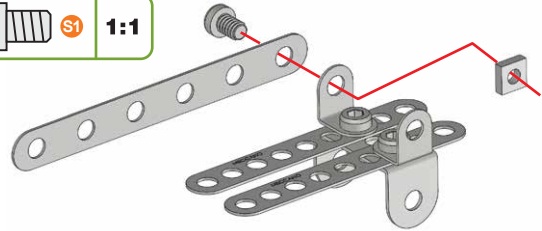
-  1:1





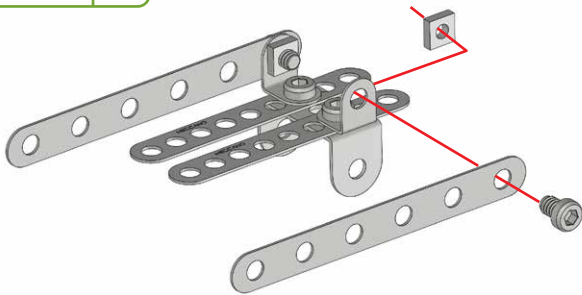

14

-  5.8 mm | x1
15/64"
-  x1
-  x1

-  1:1





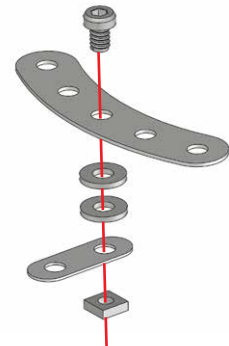

15

-  5.8 mm | x1
15/64"
-  x1
-  x2
-  x1
-  x1

-  1:1



16

-  5.8 mm | 15/64" | **x2**
-  **x2**
-  **x2**
-  **x2**

-  **1:1**

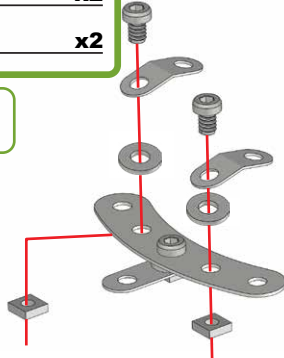

17

⑭+⑰+

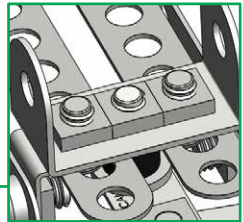
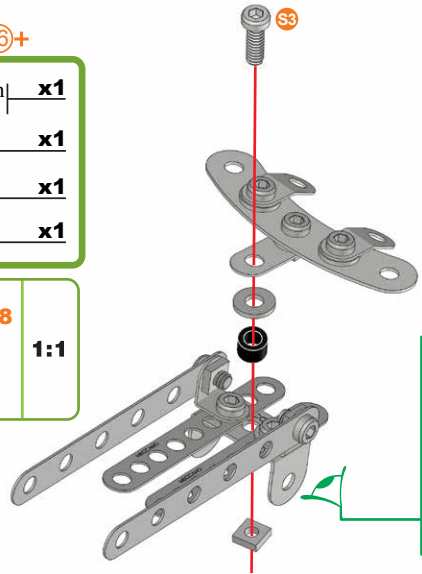

-  12 mm | 1/2" | **x1**
-  **x1**
-  **x1**
-  **x1**

-   **A338**
-  **1:1**



18

⑩+⑰+

-  5.8 mm | 15/64" | **x1**
-  **x1**

-  **1:1**

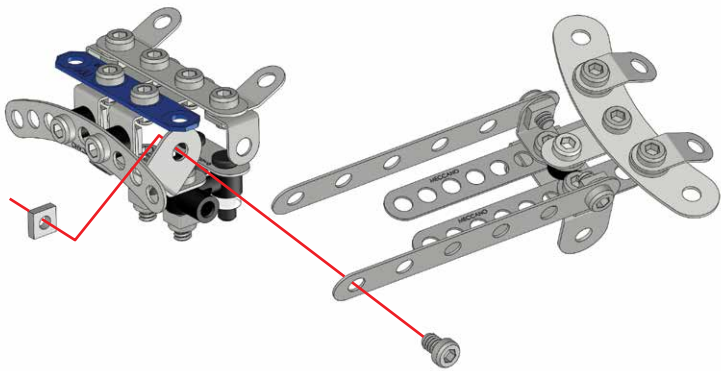

19

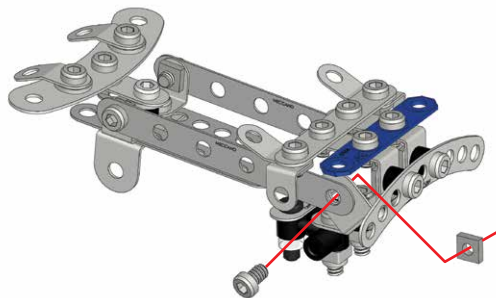

 S1 | 5.8 mm | x1
15/64" | x1

 S1 | 1:1



20

 S1 | 5.8 mm | x2
15/64" | x2

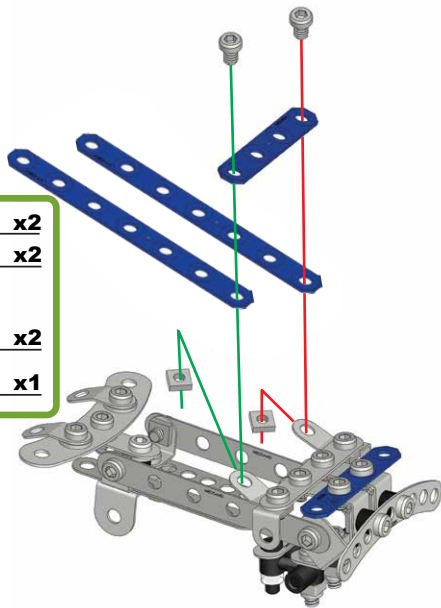

 x2
 x2
 x1

 S1 | 1:1



21



 S1 | 5.8 mm | x2
15/64" | x2

 x2
 x2
 x1

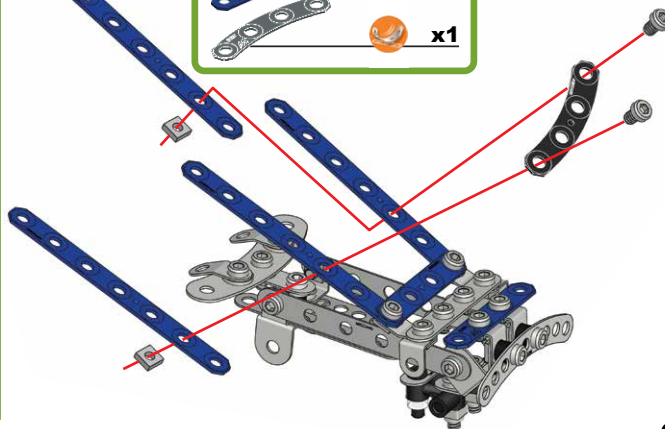
 S1 | 1:1



22

-  **S1** | 5.8 mm | **x2**
15/64" | **x2**
-  **x1**
-  **x1**

-  **S1** | **1:1**

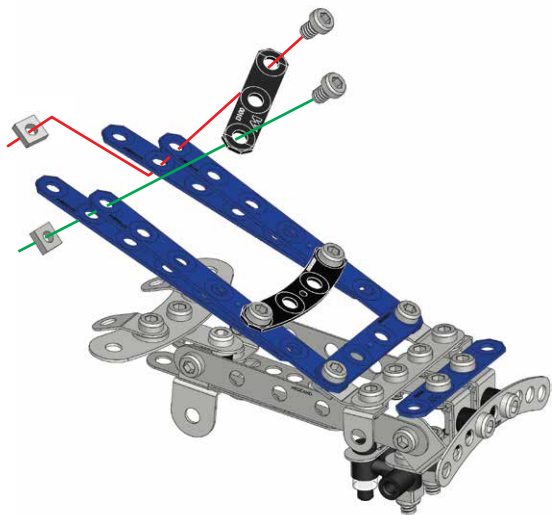

23

-  **S1** | 5.8 mm | **x2**
15/64" | **x2**

-  **S1** | **1:1**

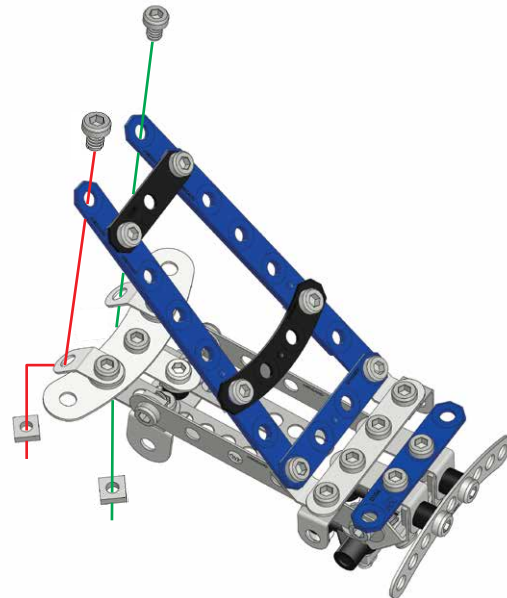



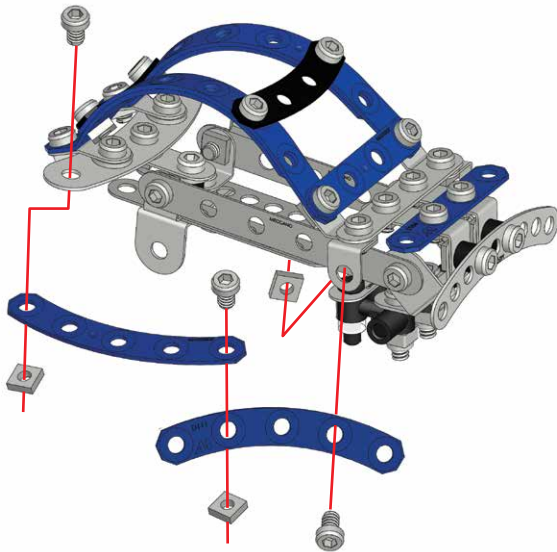

24

-  5.8 mm | $\frac{15}{64}$ " | x3
-  x3
-   x2

-  1:1



25

-  5.8 mm | $\frac{15}{64}$ " | x3
-  x3
-   x2

-  1:1

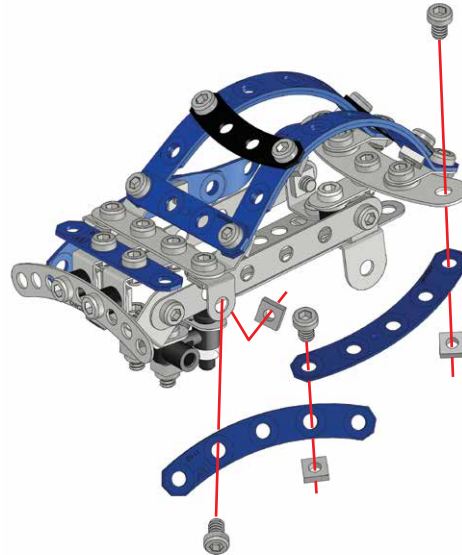

26



x4

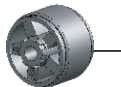

x4

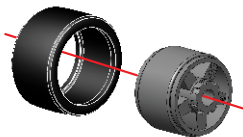

x4

27

(25)+(26)+

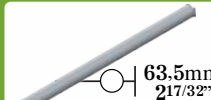

63.5mm
2 17/32"

x1



x2



x2

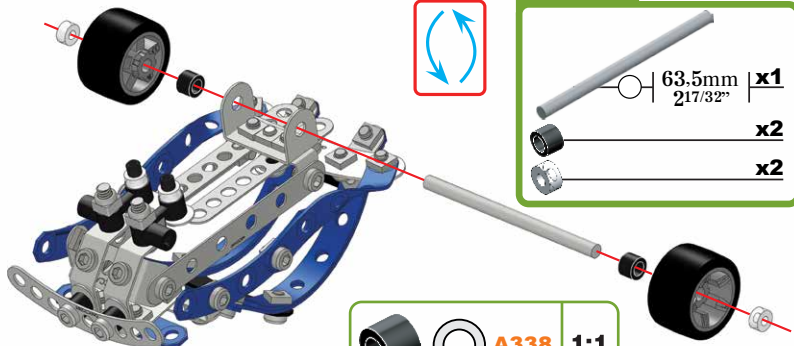

A338

1:1

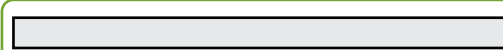

1:1

28

(26)+(27)+

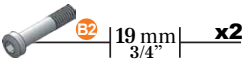

19 mm
3/4"

x2



x2



B2

1:1

