

16301

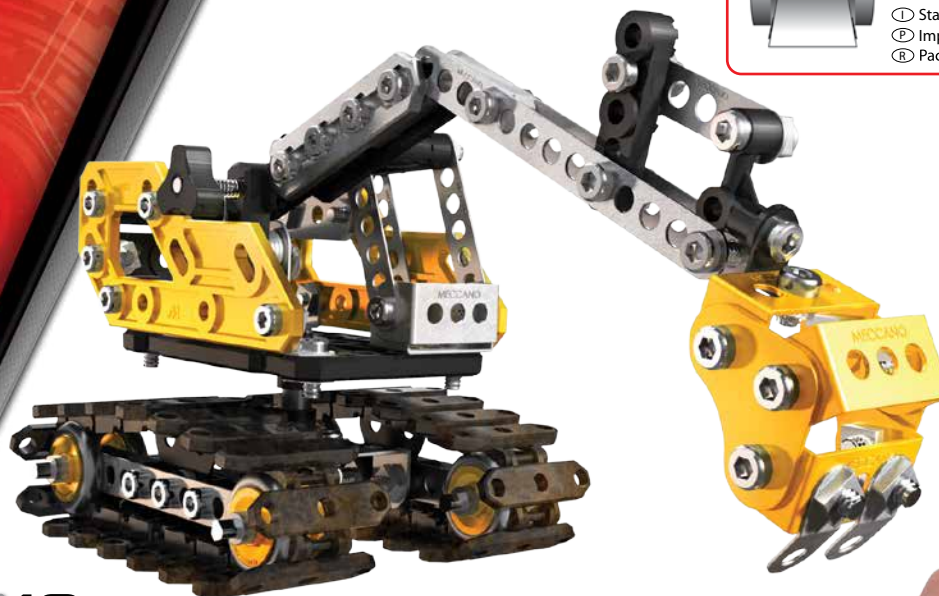

- Ⓢ Please print at scale 1 without the printer margins.
- ⓕ Merci d'imprimer à l'échelle 1 sans les marges de l'imprimante.
- ⓔ Imprimir a escala 1 sin márgenes de impresión.
- ⓓ Maßstab 1 bitte randlos drucken.
- Ⓝ Print op schaal 1 zonder de printermarges.
- Ⓛ Stampare in scala 1 senza i margini della stampante.
- Ⓟ Imprima em escala 1 sem as margens da impressora.
- Ⓡ Распечатать в масштабе 1:1 без полей.

 **10+**

Instructions  
Notice de montage  
Instrucciones de construcción  
Bauanleitung

Bouwinstructie  
Istruzioni  
Instruções  
Инструкции



**CONSTRUCTION TIPS / ASTUCES DE CONSTRUCTION**  
 TIPS DE CONSTRUCCIÓN / TIPPS ZUM BAUEN  
 MONTAGETIPS / SUGGERIMENTI PER COSTRUIRE  
 DICAS DE MONTAGEM / РЕКОМЕНДАЦИИ ПО СБОРКЕ

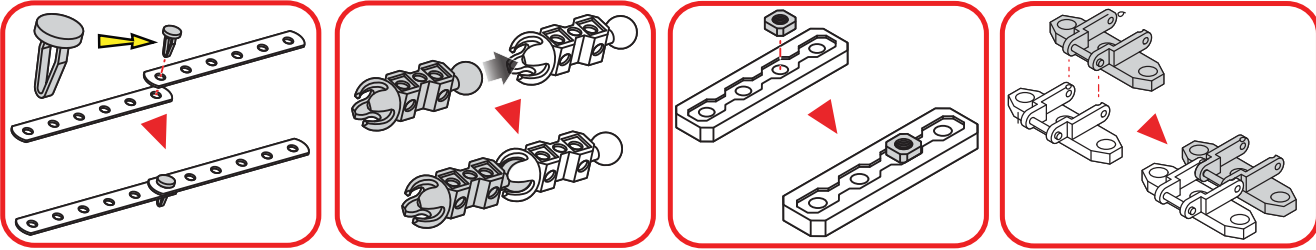
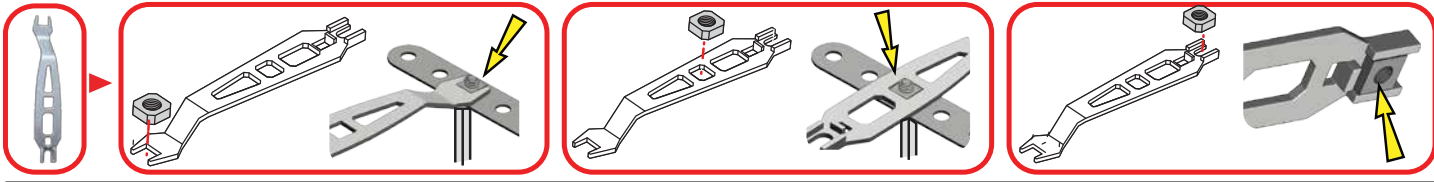
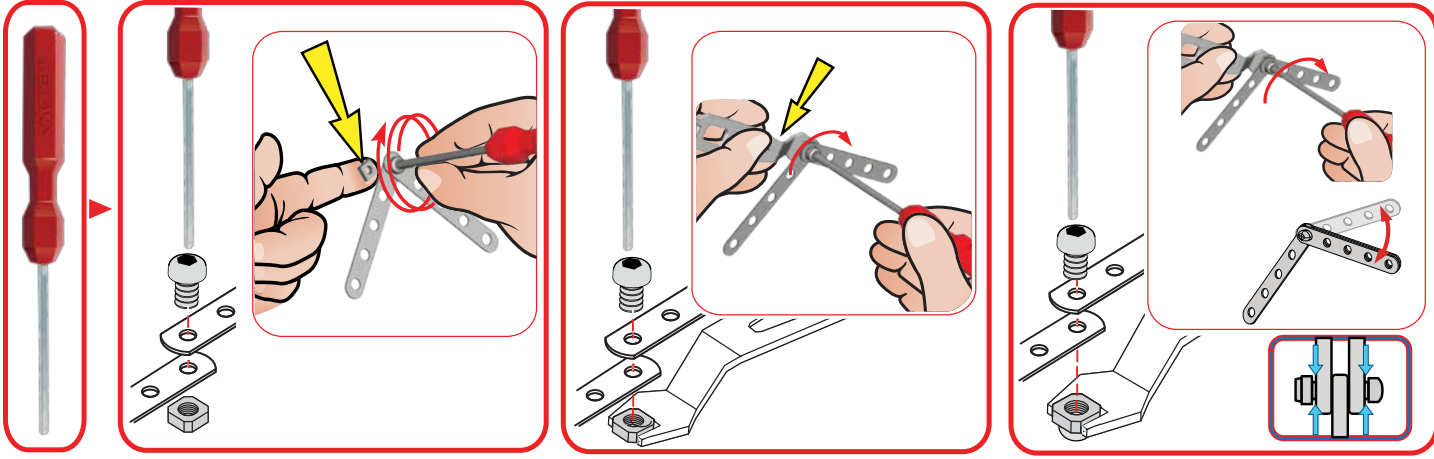

# TABLE OF CONTENTS / SOMMAIRE

## ÍNDICE / INHALTSVERZEICHNIS / INHOUD / INDICE / ÍNDICE / СОДЕРЖАНИЕ



4

**AVAILABLE ONLINE / DISPONIBLES EN LIGNE**  
**DISPONIBLES EN LÍNEA / ONLINE VERFÜGBAR /**  
**ONLINE VERKRIJGBAAR / DISPONIBILI ONLINE /**  
**DISPONÍVEL ONLINE / ДОСТУПНЫ В**  
**ОНЛАЙН-МАГАЗИНЕ**









**GB.** Content: 254 parts, 2 real tools, 1 instruction sheet for model #1.  
**F.** Contenu : 254 pièces, 2 vrais outils, 1 notice de montage pour le modèle 1.  
**E.** Contenido: 254 piezas, 2 herramientas reales, 1 guía de instrucciones para el modelo 1.  
**D.** Inhalt: 254 Teile, 2 echte Werkzeuge, 1 Bauanleitung für Modell Nr. 1.  
**NL.** Inhoud: 254 onderdelen, 2 stuks gereedschap, 1 bouw instructie voor model 1.  
**I.** Contenuto: 254 pezzi, 2 attrezzi, 1 guida per l'uso per il modello 1.  
**P.** Conteúdo: 254 peças, 2 ferramentas reais, 1 folha de instruções para o modelo 1.  
**R.** В коробке: 254 детали, 2 настоящих инструмента, 1 инструкция по сборке модели №1.

**GB.** Building instructions for model #2 are available at [www.meccano.com](http://www.meccano.com).  
**F.** La notice de montage du modèle 2 est disponible sur [www.meccano.com](http://www.meccano.com).  
**E.** Hay instrucciones de construcción disponibles para el modelo 2 en [www.meccano.com](http://www.meccano.com).  
**D.** Die Bauanleitung für Modell Nr. 2 ist auf [www.meccano.com](http://www.meccano.com) zu finden.  
**NL.** Bouwinstructies voor model 2 zijn beschikbaar op [www.meccano.com](http://www.meccano.com).  
**I.** Le istruzioni di montaggio del modello 2 sono disponibili alla pagina [www.meccano.com](http://www.meccano.com).  
**P.** As instruções de montagem para o modelo 2 estão disponíveis em [www.meccano.com](http://www.meccano.com).  
**R.** Инструкции по сборке модели №2 можно найти на сайте [www.meccano.com](http://www.meccano.com).

**GB.** Only one model can be built at a time. **F.** Les pièces fournies ne permettent de monter qu'un seul modèle à la fois. **E.** Solo es posible construir un modelo a la vez. **D.** Jeweils nur eins der Modelle baubar. **NL.** Er kan maar een model tegelijk worden gebouwd. **I.** Permette di realizzare un solo modello per volta. **P.** Só é possível montar um modelo de cada vez. **R.** Одновременно можно построить только одну модель.



1

-  x4
-  x2
-  x2
-  x8
-  B2 | 19 mm | 3/4" | x2
-  x2

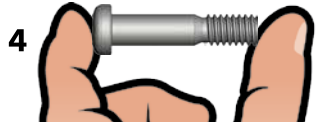
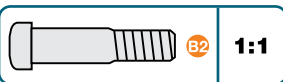
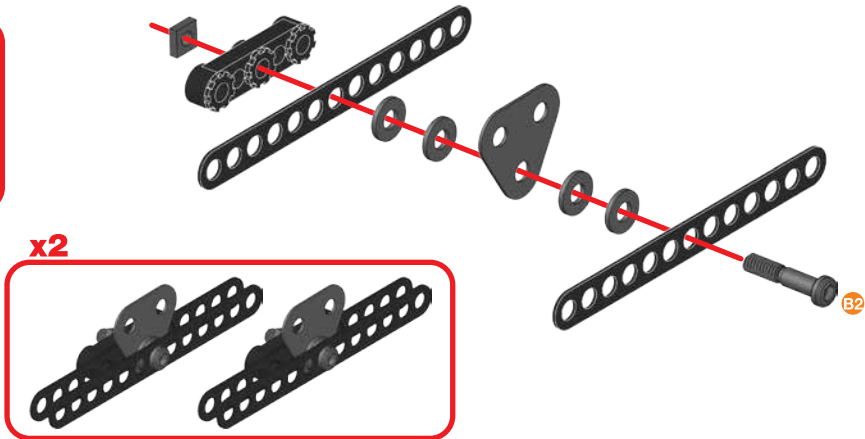

2

-  **x8**
-  **x8**

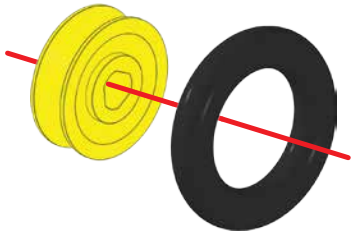



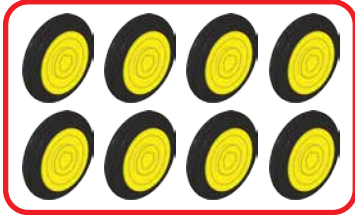

x8



3

①+②+

-  32 mm  $1\frac{1}{4}$ " | **x1**
-  **x1**
-  **x1**
-  **x2**





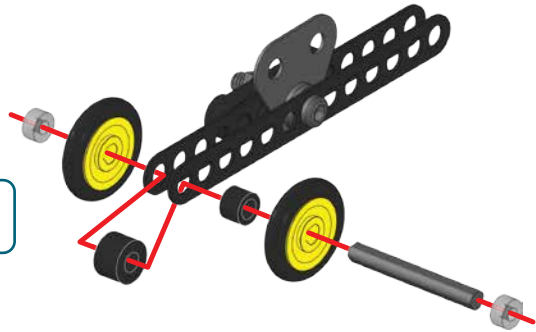

1:1



4

②+③+

-  32 mm  $1\frac{1}{4}$ " | **x1**
-  **x1**
-  **x1**
-  **x2**



1:1

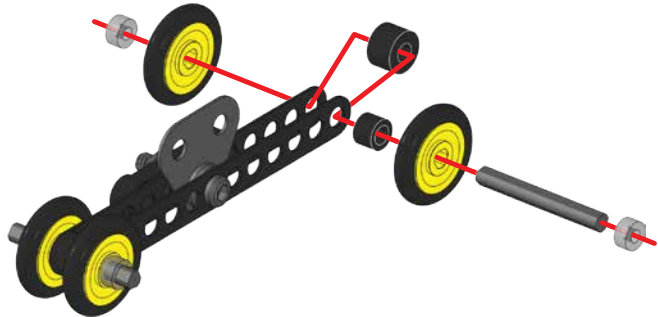





5

③ ~ ④

2x



6

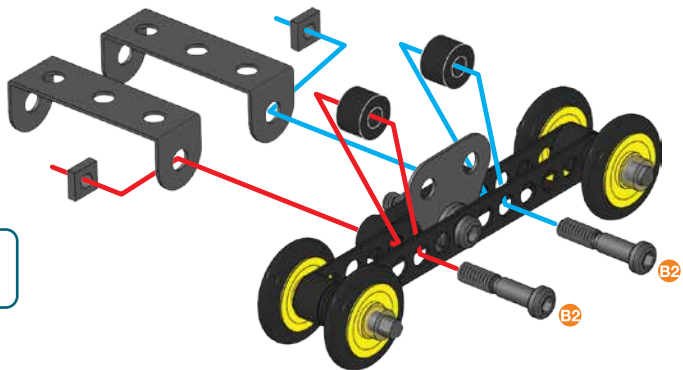

-  x2
-  x2
-  19 mm | 3/4" x2
-  x2

-  B2 1:1



7



⑤ + ⑥ +

-  x2
-  19 mm | 3/4" x2
-  x2

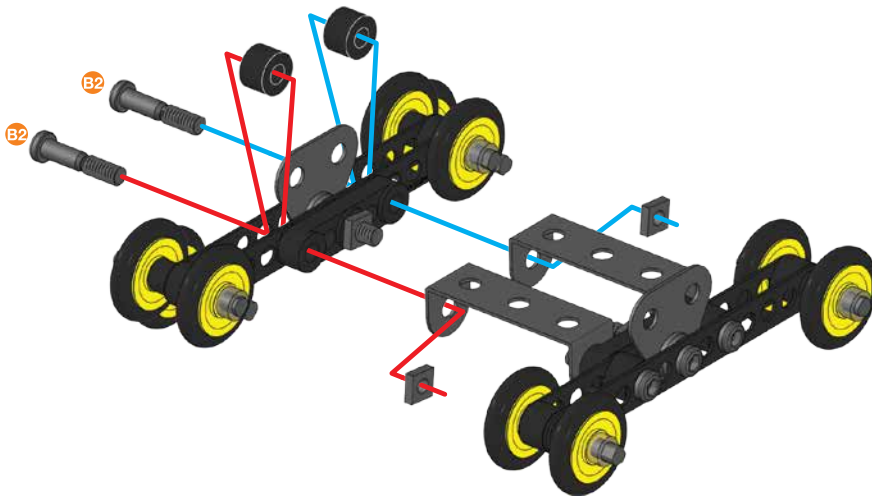
-  B2 1:1



8

-  **x1**
-  **x2** 5,8 mm | 15/64"
-  **x2**

-  **x1** 1:1

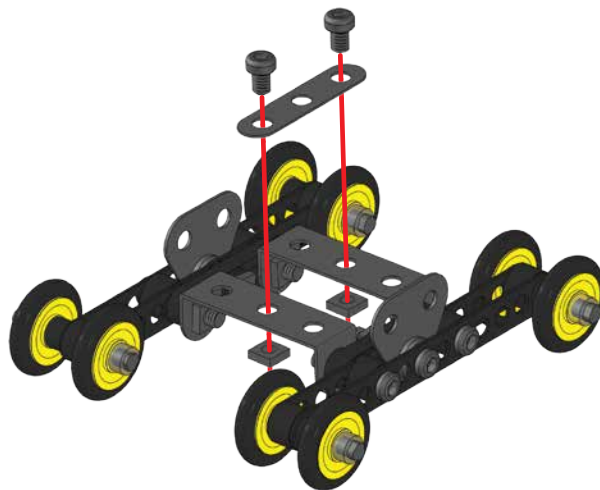

9

-  **x34**

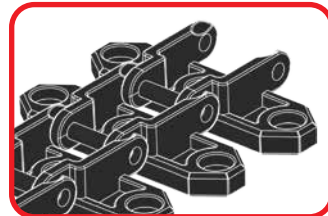
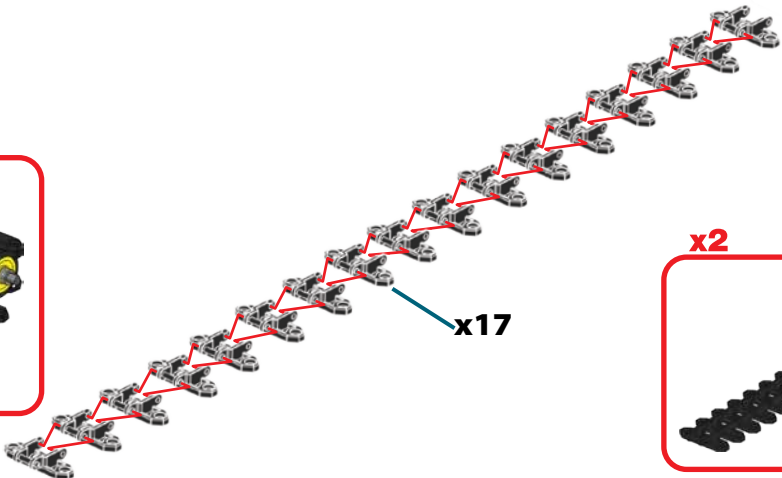

x2



10

⑧ + ⑨ +

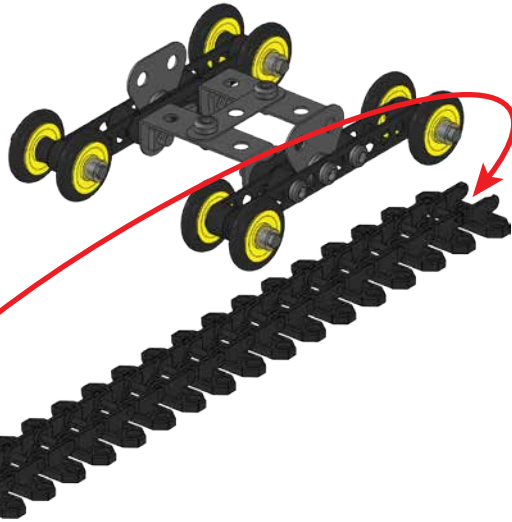

11

⑨ + ⑩ +

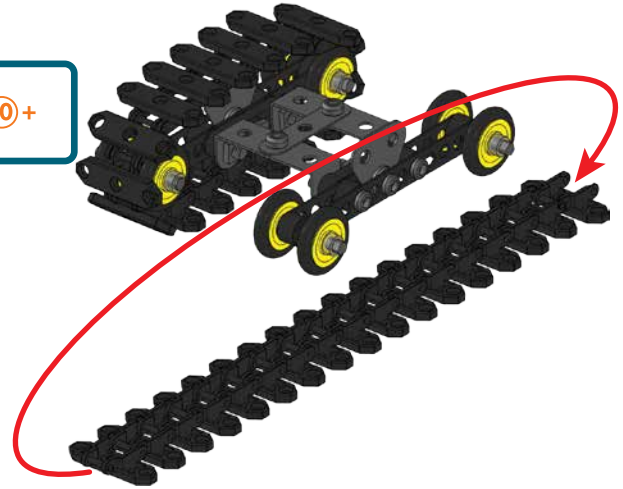





12

-  x1
-  x1
-  9,5 mm | 3/8" x1
-  x1

-  1:1



13

-  x2
-  x1
-  x1
-  23 mm | 15/16" x1



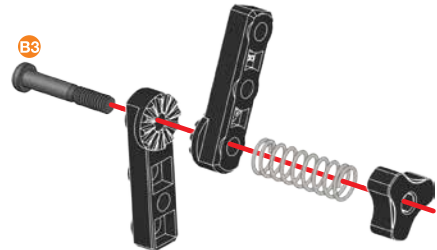

-  1:1





14

(11) + (12) +

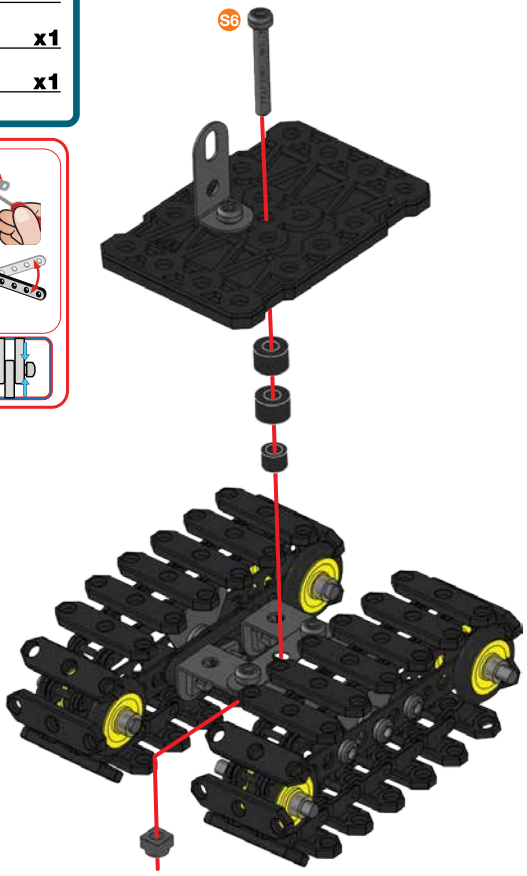
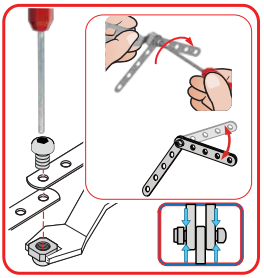

-  **x2**
-  **x1**
-  28 mm | 1 1/8" | **x1**
-  **x1**

-  S6 | **1:1**



15



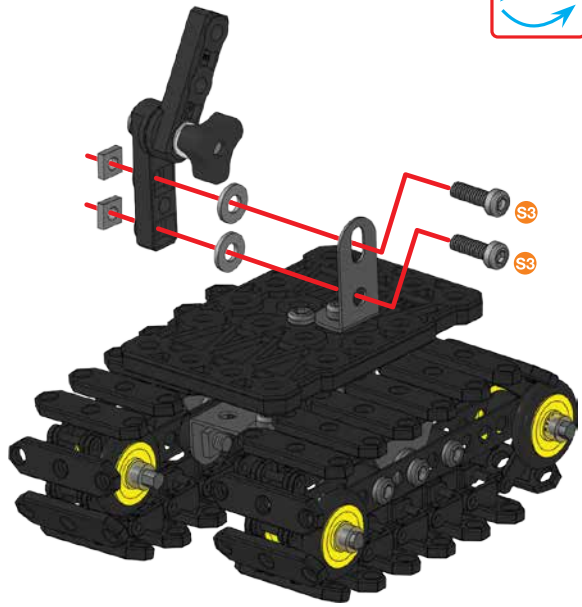
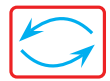

(13) + (14) +

-  **x2**
-  S3 | 12 mm | 1/2" | **x2**
-  **x2**

-  S3 | **1:1**





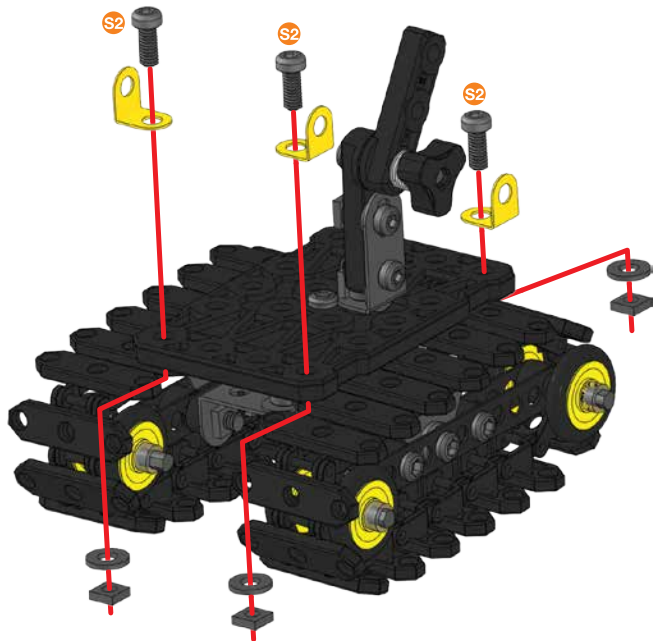

# 16

-  **x3**
-  **x3**
-  9,5 mm | 3/8" **x3**
-  **x3**

-  **S2** **1:1**



# 17

-  **x1**
-  **x1**
-  9,5 mm | 3/8" **x1**
-  **x1**

-  **S2** **1:1**

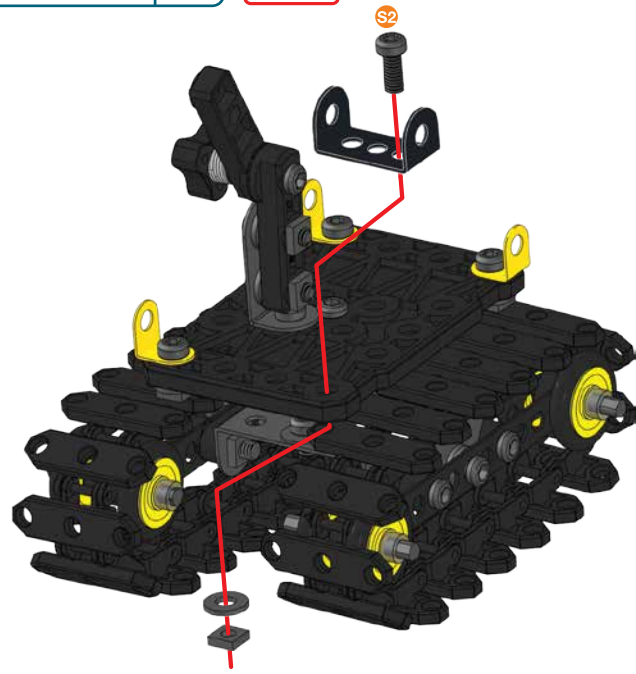

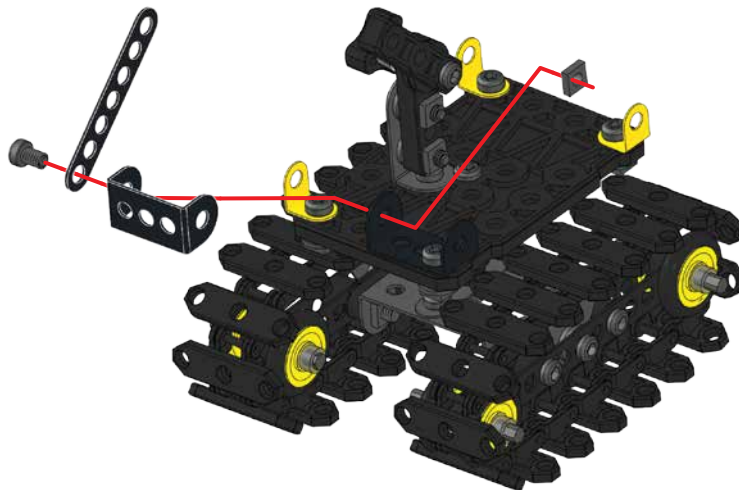
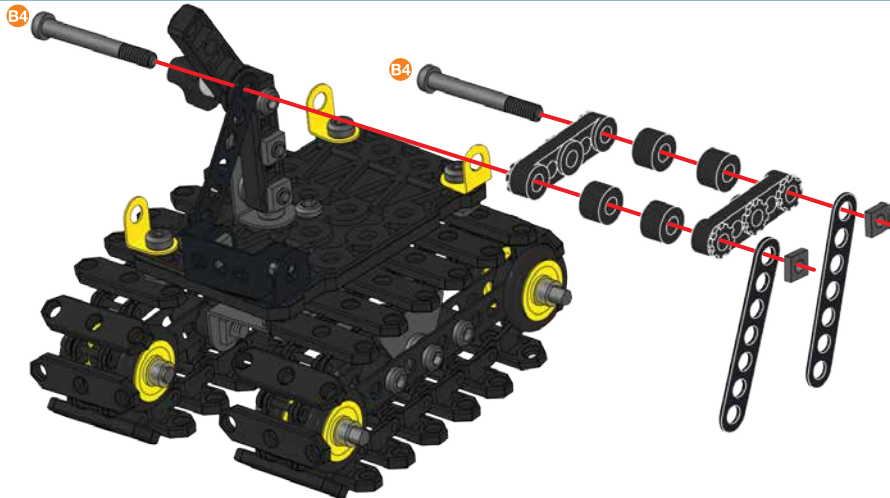
**18****x1****x1**
**S1** | 5,8 mm  
 15/64"
**x1****x1****S1****1:1****19****x2****x2**
**B4** | 32 mm  
 1 1/4"
**x2****x2****x4****B4****1:1**

20



x1



5,8 mm  
15/64"

x2



x2



S1

1:1

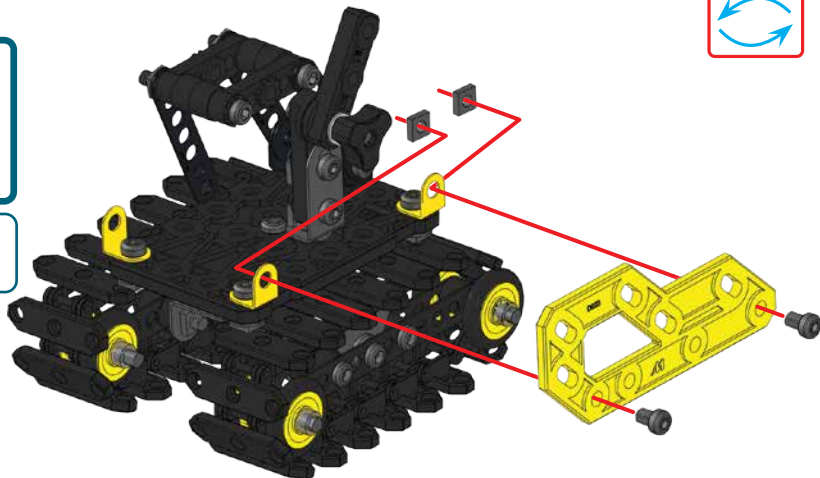

21



x1



x2



5,8 mm  
15/64"

x2



x2



S1

1:1

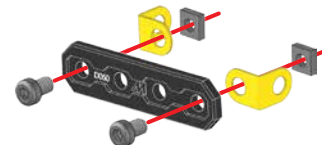

22

②0 + ②1 +



5,8 mm  
15/64"

x1



x1





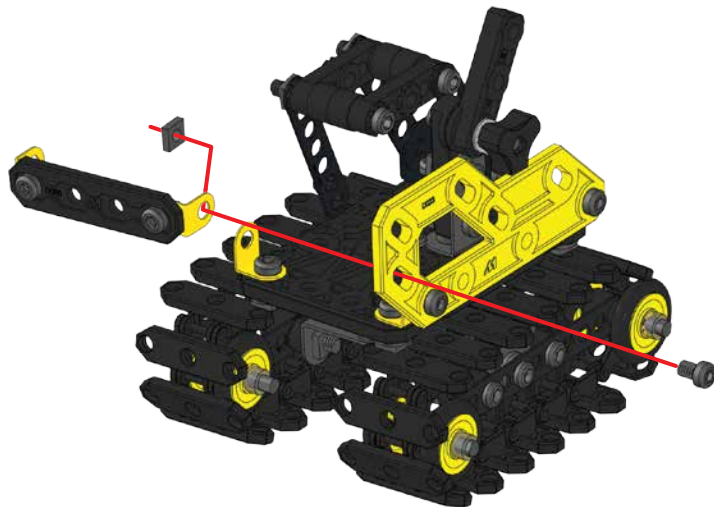

S1

1:1





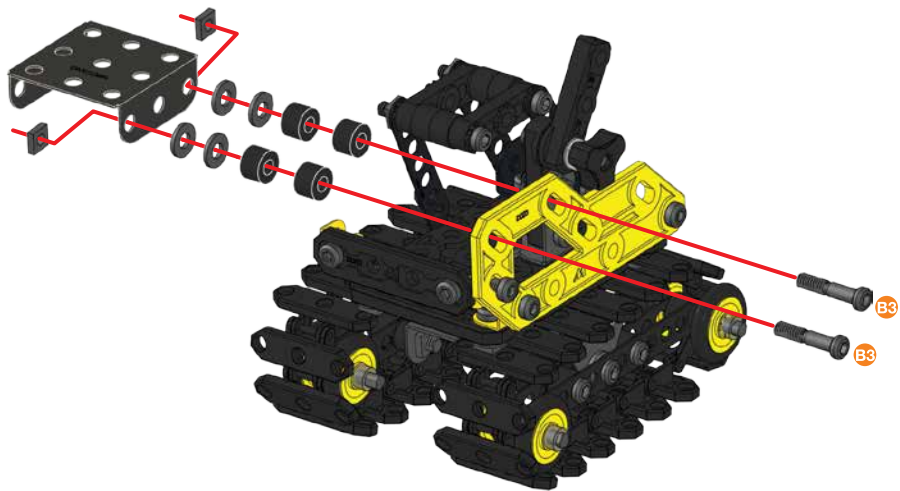

23

-  **x1**
-  **x4**
-  **x4**
-  **23 mm** | **x2**  
1 5/16"
-  **x2**

-  **B3** **1:1**



24



-  **x1**
-  **9,5 mm** | **x1**  
3/8"
-  **5,8 mm** | **x2**  
15/64"
-  **x3**

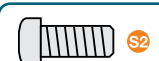

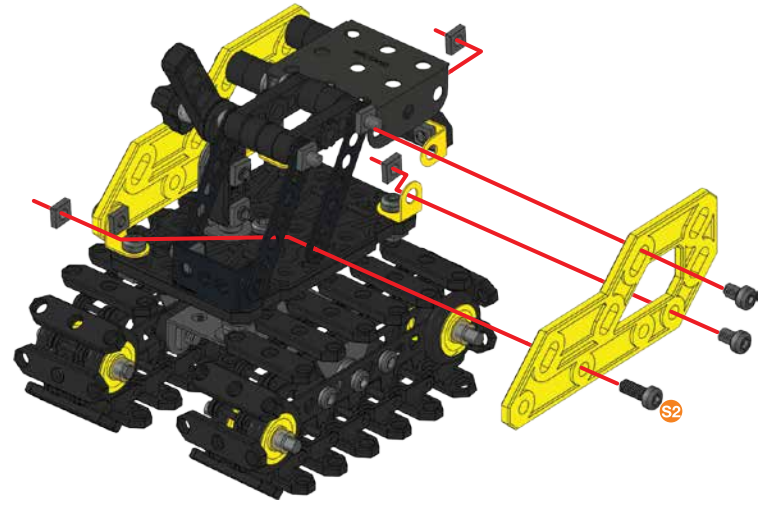
-  **S2**
-  **S1**
- 1:1**





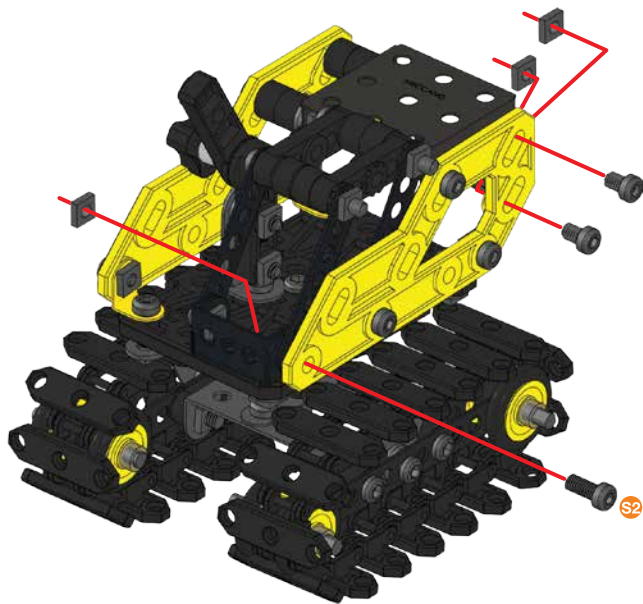

25

-  **S2** | 9,5 mm | **x1**  
3/8"
-  **S1** | 5,8 mm | **x2**  
15/64"
-  | **x3**



26

-  | **x2**
-  | **x2**
-  **B1** | 14,7 mm | **x2**  
37/64"
-  | **x2**

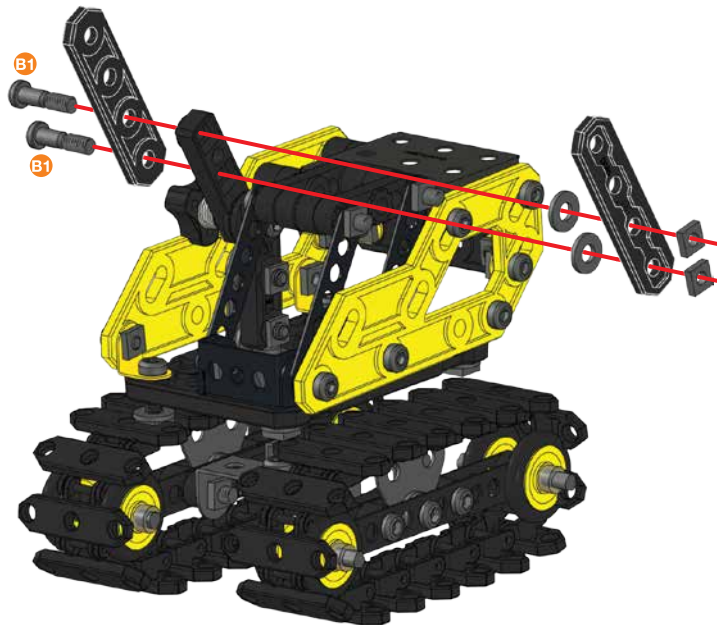





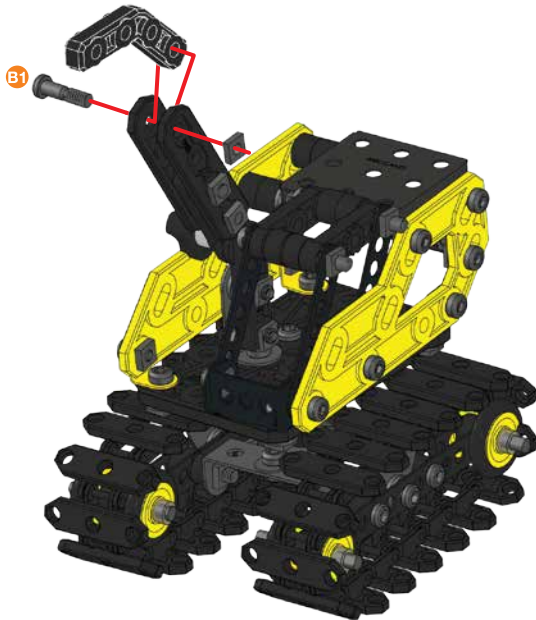

27

-  **x1**
-  **14,7 mm** **x1**  
37/64"
-  **x1**



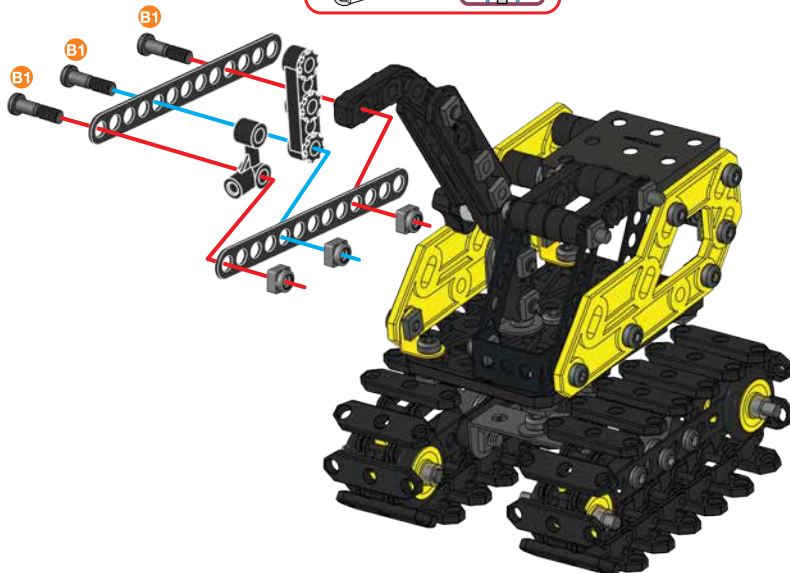
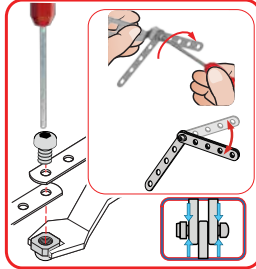

28

-  **x2**
-  **x1**
-  **x1**
-  **14,7 mm** **x3**  
37/64"
-  **x3**





29

-  **x1**
-  | 12 mm | **x2**
-  | **x2**

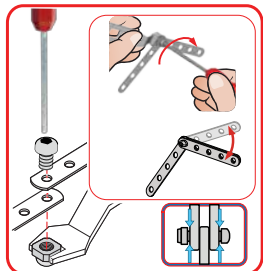
-  | **x1**





30

-  **x1**
-  | 5,8 mm | **x1**
-  | 15/64" | **x1**

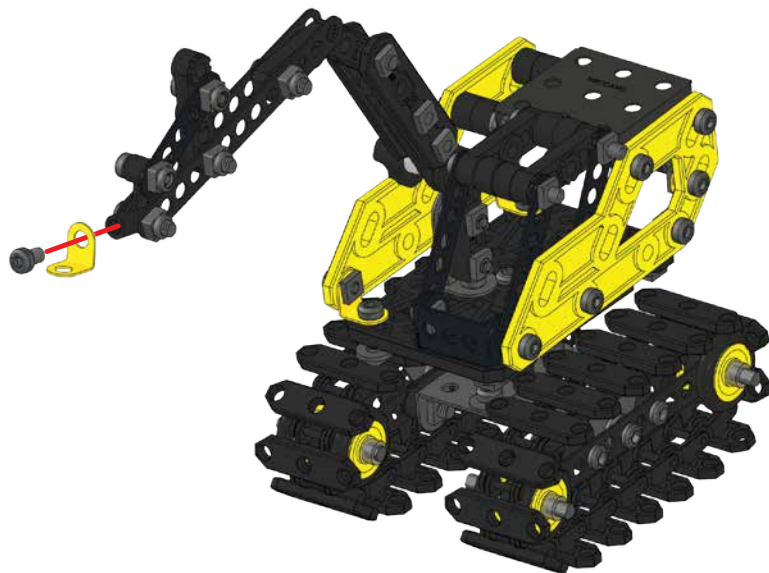
-  | **x1**





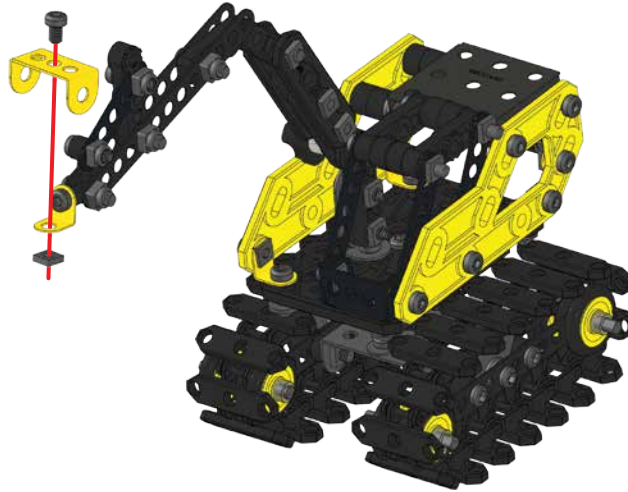

31

	<b>x1</b>
 5,8 mm 15/64"	<b>x1</b>
	<b>x1</b>

	<b>S1</b>	<b>1:1</b>
-----------------------------------------------------------------------------------	-----------	------------



32

	<b>x2</b>
	<b>x1</b>
 5,8 mm 15/64"	<b>x3</b>
	<b>x3</b>

	<b>S1</b>	<b>1:1</b>
------------------------------------------------------------------------------------	-----------	------------

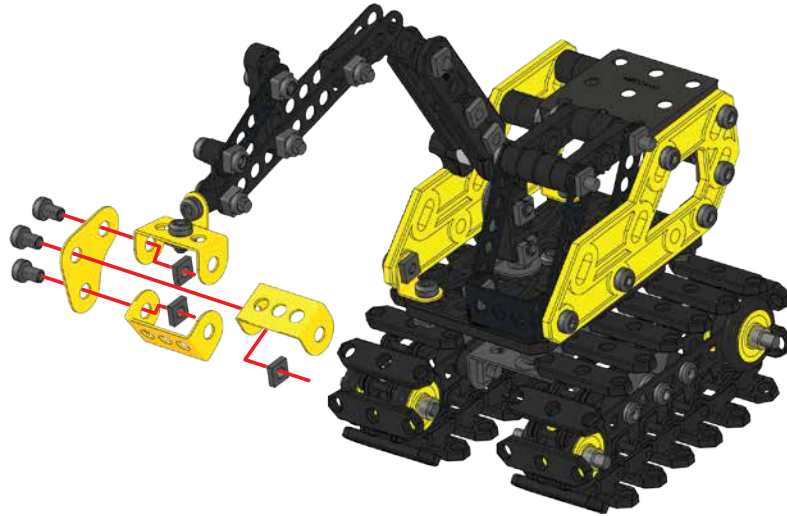

33

 **x1**

 **S1** | 5,8 mm | **x3**  
15/64"

 **x3**

 **S1** | **1:1**

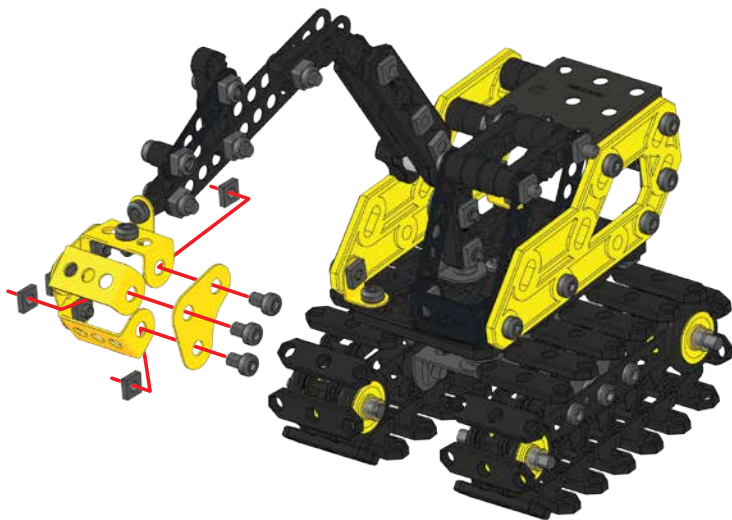

34

 **x2**

 **S1** | 5,8 mm | **x2**  
15/64"

 **x2**

 **S1** | **1:1**

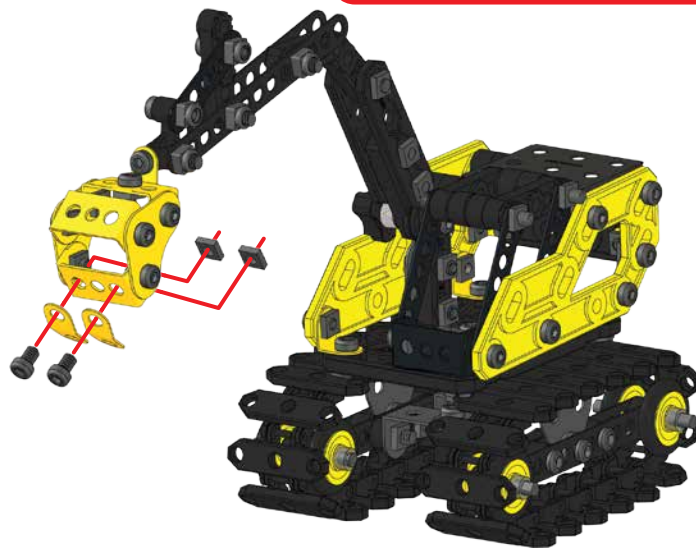



**D024 x1**



**D023 x2**



**A551 (0051B) x1**



**A248 (0048) x2**



**A548 (0048E) x2**



**A548 (0048E) x3**



**D050 x3**



**D040 x2**



**D038 x1**



**D021 x34**



**C881 x1**



**C992 x8**



**A523 x8**

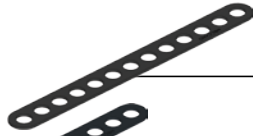

**C773 x6**



**C769 x3**



**C768 x1**



**A416 (02356) x1**



**A420 (0260C) x5**



**A512 (0012B) x1**

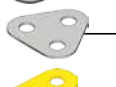

**A277 (0077) x2**



**A133 (0133A) x2**



**A352 (0120B) x1**



**A423 (0260F) x1**



**A238 (0038A) x18**



**A338 (0038B) x5**



**A259 (0059C) x8**



**C483 x2**



**C330 x6**



32 mm **A430 (0318C) x4**  
1 1/4"



32 mm **C935 x2**  
1 1/4"



28 mm **A611 (0111D) x1**  
1 1/8"

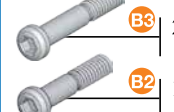

23 mm **A347 (0147G) x3**  
15/16"

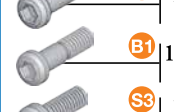

19 mm **A447 (0147F) x6**  
3/4"



14.7 mm **A247 (0147D) x6**  
37/64"



12 mm **A411 (0111A) x4**  
1/2"

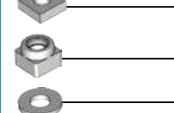

9.5 mm **A511 (0111C) x7**  
3/8"



5.8 mm **A637 (0037B) x22**  
15/64"



**A337 (0037A) x43**



**A737 (0037H) x6**



**A138 (0038) x20**



**C994 x1**



**C993 x1**

**GB.** Remove all packaging before use. Retain this information, addresses and phone numbers for future reference. Content may vary from pictures. Meccano reserves the right to discontinue the website [www.meccano.com](http://www.meccano.com) at any time. An adult should periodically check this toy to ensure no damage or hazards exist, if so, remove from use. Children should be supervised during play.

**F.** Retirer tout l'emballage avant utilisation. Conserver les informations, adresses et numéros de téléphone pour consultation ultérieure. Le contenu peut différer des images. Meccano se réserve le droit de supprimer le site Internet [www.meccano.com](http://www.meccano.com) à tout moment. Un adulte doit régulièrement examiner ce jouet afin de s'assurer qu'il ne présente pas de dommage ni de risque. En cas de problème, ne plus l'utiliser. Les enfants doivent être surveillés lorsqu'ils jouent.

**E.** Retire todo el embalaje antes de utilizar el producto. Conserve toda la información, las direcciones y los números de teléfono para futuras referencias. El contenido del paquete puede no corresponder con las imágenes. Meccano se reserva el derecho a suspender el sitio web [www.meccano.com](http://www.meccano.com) en cualquier momento. Un adulto debe revisar de forma periódica el juguete para asegurarse de que no supone un riesgo o peligro para el niño; si así fuera el caso, interrumpa su uso. Supervise a los niños mientras juegan con el producto.

- ⚠ Warning: CHOKING HAZARD – Small parts.
- ⚠ Attention ! RISQUE D'ETOUFFEMENT – Contient de petits éléments.
- ⚠ Advertencia: PELIGRO DE ASFIXIA – Contiene piezas pequeñas. No conveniente para niños menores de 3 años.
- ⚠ Achtung: ERSTICKUNGSGEFAHR – Kleinteile.
- ⚠ Waarschuwing: VERSTIKKINGSGEVAAR – Kleine onderdelen.
- ⚠ Attenzione: RISCHIO DI SOFFOCAMENTO – Pezzi piccoli.
- ⚠ Aviso: PERIGO DE ASFIXIA – Peças pequenas.
- ⚠ Осторожно! ОПАСНОСТЬ УДУШЬЯ – Мелкие детали.



**NORTH AMERICA** - 1-800-622-8339, [customercare@spinmaster.com](mailto:customercare@spinmaster.com)  
**UK** – 0800 206 1191, [serviceuk@spinmaster.com](mailto:serviceuk@spinmaster.com)  
**IRELAND:** 1800 992 249  
**FRANCE** – 0800 909 150, [servicefr@spinmaster.com](mailto:servicefr@spinmaster.com)  
**DEUTSCHLAND** – 00800 0101 0222, [Kundenservice@spinmaster.com](mailto:Kundenservice@spinmaster.com)  
**SCHWEIZ** – 0800 561 350 • **ÖSTERREICH** – 0800 297 267  
**NEDERLAND** – 0800 022 3683, [klantenservice@spinmaster.com](mailto:klantenservice@spinmaster.com)  
**BELGIË/BELGIQUE** – 0800 77 688 • **LUXEMBOURG** – 800 2 8044  
**ITALIA** – 800 788 532, [servizio@spinmaster.com](mailto:servizio@spinmaster.com)  
**MEXICO** – 55 4160 7947, [servicio@spinmaster.com](mailto:servicio@spinmaster.com)  
**WWW.SPINMASTER.COM**

**D.** Entfernen Sie vor der Benutzung sämtliche Verpackungsmaterialien. Alle Informationen, Adressen und Telefonnummern bitte für mögliche Rückfragen aufbewahren. Der Packungsinhalt kann von den Bildern abweichen. Meccano behält sich das Recht vor, den Betrieb der Website [www.meccano.com](http://www.meccano.com) jederzeit einzustellen. Ein Erwachsener sollte regelmäßig sicherstellen, dass das Spielzeug keine Gefahr darstellt, und es gegebenenfalls entfernen. Kinder sollten beim Spielen beaufsichtigt werden.

**NL.** Verwijder de verpakking voor gebruik. Bewaar deze informatie, adressen en telefoonnummers voor toekomstig gebruik. Inhoud kan afwijken van illustraties. Meccano behoudt zich het recht voor de website [www.meccano.com](http://www.meccano.com) wanneer gewenst buiten gebruik te stellen. Een volwassene dient dit speelgoed regelmatig te controleren. In geval van schade of gevaaren het speelgoed niet meer gebruiken. Houd toezicht als kinderen spelen.

**I.** Rimuovere l'imballo prima dell'uso. Conservare informazioni, indirizzi e numeri di telefono per riferimento futuro. Il prodotto potrebbe essere differente dalle immagini. Meccano si riserva il diritto di rimuovere il sito [www.meccano.com](http://www.meccano.com) in qualsiasi momento. Il giocattolo deve essere periodicamente controllato da un adulto per prevenire eventuali danni o rischi; in caso di danno, sospendere l'uso. I bambini devono essere sorvegliati durante il gioco.

**P.** Remova totalmente a embalagem antes de utilizar. Guarde todos os endereços, números de telefone e demais informações para consulta e referência. O conteúdo poderá ser diferente das ilustrações. A Meccano reserva-se o direito de descontinuar o site [www.meccano.com](http://www.meccano.com) a qualquer altura. Um adulto deve verificar o brinquedo periodicamente para garantir que não há danos ou riscos. Se houver, é necessário que o brinquedo seja retirado de uso. Crianças devem ser supervisionadas enquanto brincam.

**R.** Снимите все упаковочные материалы перед использованием. Запишите указанные на упаковке адреса и номера телефонов, чтобы у вас была возможность связаться с нами. Содержимое упаковки может отличаться от иллюстрации. Компания Meccano оставляет за собой право прекратить использование сайта [www.meccano.com](http://www.meccano.com) в любое время. Взрослым следует время от времени проверять игру и следить за тем, чтобы она не была сломана и не представляла опасности для ребенка. В противном случае ее не следует использовать. Во время игры дети должны находиться под присмотром взрослых.

SPIN MASTER LTD., 450 FRONT STREET WEST, TORONTO, ON M5V 1B6 CANADA.  
DISTRIBUTED IN EU BY SPIN MASTER INTERNATIONAL, S.A.R.L.,  
16 AVENUE PASTEUR, L-2310, Luxembourg. [www.spinmaster.com](http://www.spinmaster.com)



TM & © 2015 MECCANO for packaging, instructions and models built with this set. / TM & © 2015 MECCANO pour l'emballage, les notices et modèles de ce coffret. / ® MECCANO is an exclusive trademark of MECCANO. Spin Master logo is a trademark of Spin Master Ltd. / ® MECCANO est une marque de commerce exclusive de MECCANO. Le logo de Spin Master est une marque de commerce de Spin Master Ltd. / All rights reserved. / Tous droits réservés.

T91806\_0002\_20071487\_GML\_IB\_R1 W1\_MEC\_Excavator