

MECCANO™

ENGINEERING & ROBOTICS

17202



MOTORCYCLES
MOTOS

5 IN **1**

MODELS • MODÈLES

 **8+**

Instructions
Notice de montage
Instrucciones de construcción
Bauanleitung

Bouwinstructie
Istruzioni
Instruções
Инструкции

Instrukcja
Pokyny
Útmutató
Instrucțiuni





CONSTRUCTION TIPS / ASTUCES DE CONSTRUCTION

TIPS DE CONSTRUCCIÓ / TIPPS ZUM BAUEN / MONTAGETIPS / SUGGERIMENTI PER COSTRUIRE
DICAS DE MONTAGEM / РЕКОМЕНДАЦИИ ПО СБОРКЕ / WSKAZÓWKI BUDOWANIA
ONSTRUKČNÍ TIPY / TIPY NA MONTÁŽ / ÖSSZESZERELÉSI TIPPEK / SFATURI PENTRU CONSTRUIRE

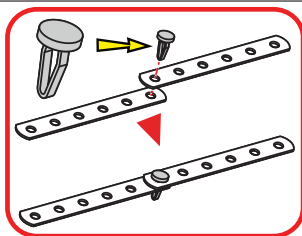
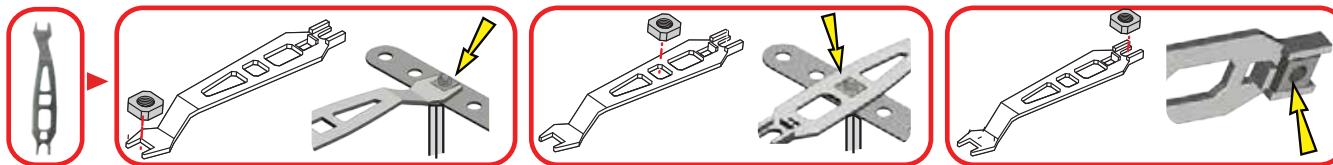
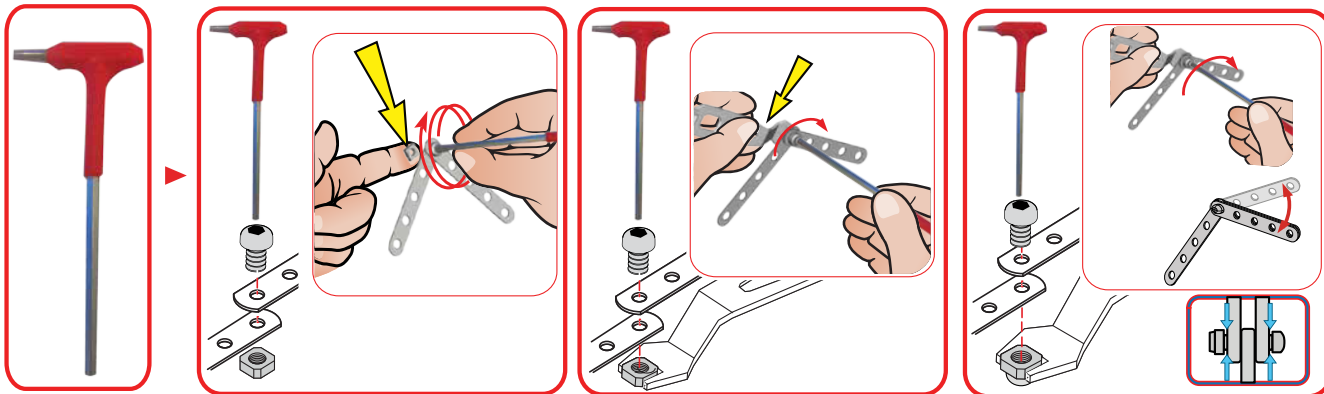

TABLE OF CONTENTS / SOMMAIRE

ÍNDICE / INHALTSVERZEICHNIS / INHOUD / INDICE / ÍNDICE / СОДЕРЖАНИЕ

SPIS TREŚCI / OBSAH / TARTALOMJEGYZÉK / CUPRINS



4



14



20

EN. Content: 174 parts, 2 real tools and 1 instruction sheet for 3 models.
FR. Contenu : 174 pièces, 2 vrais outils et 1 notice de montage pour 3 modèles.
ES. Contenido: 174 piezas, 2 herramientas reales y 1 guía de instrucciones para 3 modelos.
DE. Inhalt: 174 Teile, 2 echte Werkzeuge und 1 Bauanleitung für 3 Modelle.
NL. Inhoud: 174 onderdelen, 2 stuks gereedschap en 1 bouw instructie voor 3 modellen.
IT. Contenuto: 174 pezzi, 2 attrezzi e 1 guida per l'uso per 3 modelli.
PT. Conteúdo: 174 peças, 2 ferramentas reais e 1 folha de instruções para 3 modelos.
RU. В комплекте: 174 детали, 2 настоящих инструмента и 1 инструкция по сборке 3 моделей.
PL. Zawartość: 174 części, 2 prawdziwe narzędzia, 1 karta z instrukcjami dla 3 modeli.
CZ. Obsah: 174 dílů, 2 skutečné nástroje a 1 list s pokyny pro 3 modely.
SK. Obsah: 174 dielov, 2 skutočné nástroje a 1 hárok s pokynmi pre 3 modely.
HU. Tartalom: 174 db alkatrész, 2 db valódi szerszám és 1 db 3 modellhez tartozó felhasználói útmutató.
RO. Conținut: 174 de piese, 2 instrumente reale, 1 fișă cu instrucțiuni pentru 3 modele.

EN. Only one model can be built at a time. / **FR.** Les pièces fournies ne permettent de monter qu'un seul modèle à la fois. / **ES.** Solo es posible construir un modelo a la vez. / **DE.** Jeweils nur eins der Modelle baubar. / **NL.** Er kan maar een model tegelijk worden gebouwd. / **IT.** Permette di realizzare un solo modello per volta. / **PT.** Só é possível montar um modelo de cada vez. / **RU.** Одновременно можно построить только одну модель. / **PL.** Jednocześnie można zbudować tylko jeden model. / **CZ.** Najednou lze sestavit pouze jeden model. / **SK.** Modely sa dajú vytvoriť len po jednom. / **HU.** Egyszerre csak egy modellt rakható össze. / **RO.** Nu pot fi construite mai multe modele în același timp.

AVAILABLE ONLINE / DISPONIBLES EN LIGNE
DISPONIBLES EN LÍNEA / ONLINE VERFÜGBAR
ONLINE VERKRIJGBAAR / DISPONIBILI ONLINE
DISPONÍVEL ONLINE / ДОСТУПНЫ В ОНЛАЙН-МАГАЗИНЕ
DOSTĘPNE W INTERNECIE / K DISPOZICI ONLINE
DOSTUPNÝ ONLINE / ONLINE ELÉRHETŐ / DISPONIBILE ONLINE



EN. Building instructions for the 2 other models are available at www.meccano.com.
FR. Les notices de montage des 2 autres modèles sont disponibles sur www.meccano.com.
ES. Hay instrucciones de construcción disponibles para los otros 2 modelos en www.meccano.com.
DE. Bauanleitungen für die anderen 2 Modelle sind auf www.meccano.com zu finden.
NL. Bouwinstructies voor de andere 2 modellen zijn beschikbaar op www.meccano.com.
IT. Le istruzioni di montaggio degli altri 2 modelli sono disponibili alla pagina www.meccano.com.
PT. Instruções de montagem dos restantes 2 modelos disponíveis em www.meccano.com.
RU. Инструкции по сборке 2 других моделей можно найти на сайте www.meccano.com.
PL. Instrukcje montażu pozostałych 2 modeli można znaleźć na stronie www.meccano.com.
CZ. Sestavovací pokyny dalších 2 modelů naleznete na webu www.meccano.com.
SK. Pokyny na stavanie ďalších 2 modelov sú dostupné na webovej lokalite www.meccano.com.
HU. A www.meccano.com weboldalon további 2 modellhez tartozó összerakási útmutatót talál.
RO. Instrucțiunile de construire pentru celelalte 2 modele sunt disponibile la adresa www.meccano.com.



2

| | |
|--|-----------|
| | x2 |
| | x1 |
| | x1 |
| | x1 |

| | | |
|--|-----------|------------|
| | B1 | 1:1 |
|--|-----------|------------|

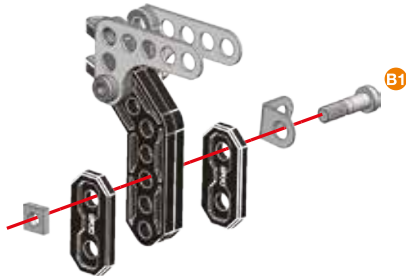

1

| | | | |
|--|-----------|--|-----------|
| | x2 | | x2 |
| | x1 | | x1 |
| | x1 | | |

| | | |
|--|-----------|------------|
| | S4 | 1:1 |
|--|-----------|------------|

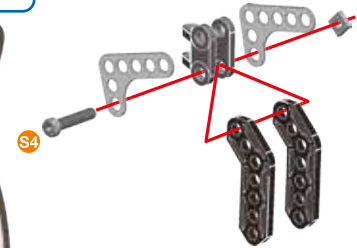

3

| | |
|--|-----------|
| | x2 |
| | x2 |
| | x2 |
| | x2 |

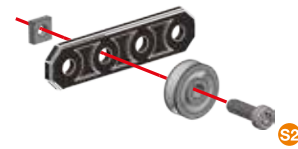

| | | |
|--|-----------|------------|
| | S2 | 1:1 |
|--|-----------|------------|



x2

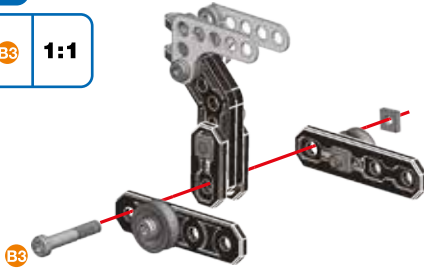
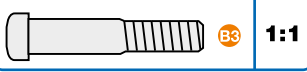
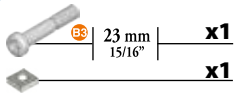
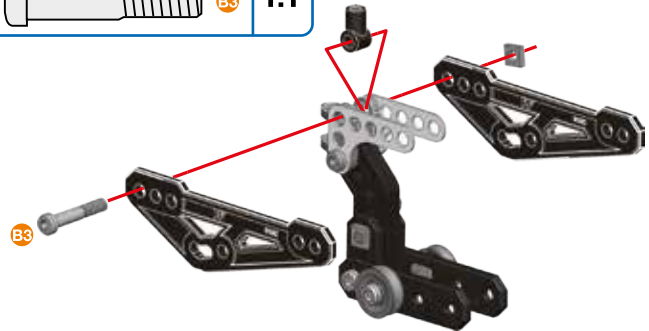
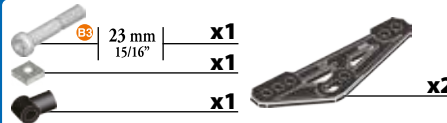
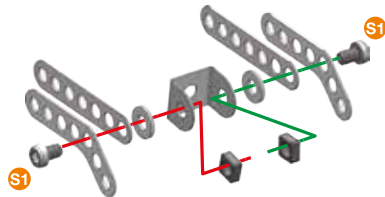
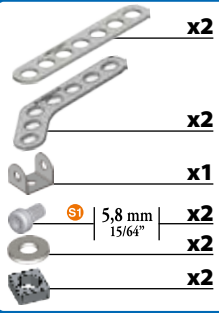
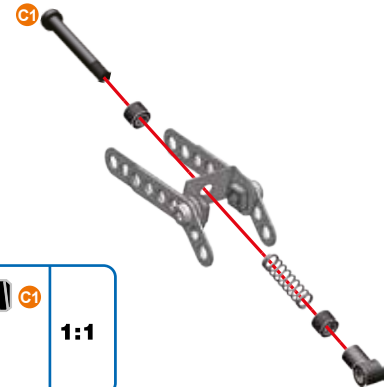
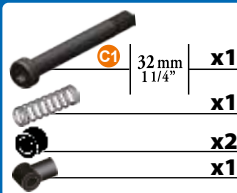



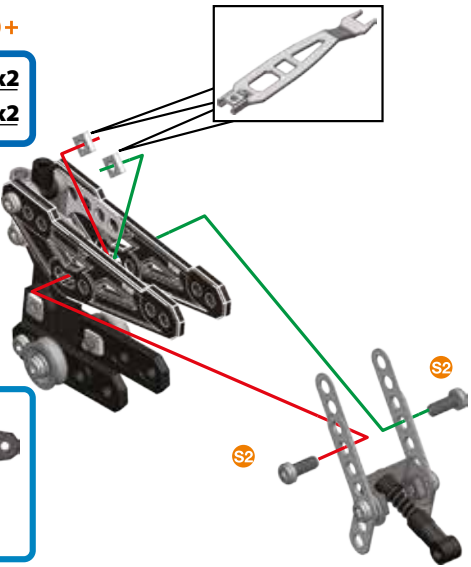

4**② + ③ +****5****6****7****5**

- 8** (5) + (7) +
- | | | |
|---|----------------|-----------|
|  | 9,5 mm 3/8" | x2 |
|  | | x2 |





- | | | |
|---|-----------|------------|
|  | S2 | 1:1 |
|---|-----------|------------|

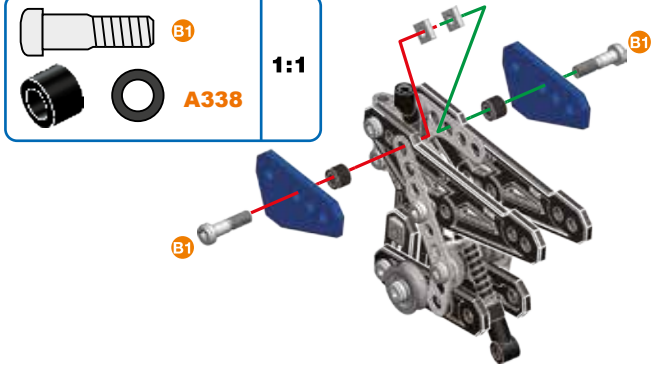

- 9**
- | | | |
|---|-------------------|-----------|
|  | 14,7 mm 37/64" | x2 |
|  | | x2 |
|  | | x2 |

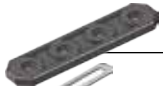
- | | | |
|---|-------------|------------|
|  | B1 | 1:1 |
|  | A338 | |





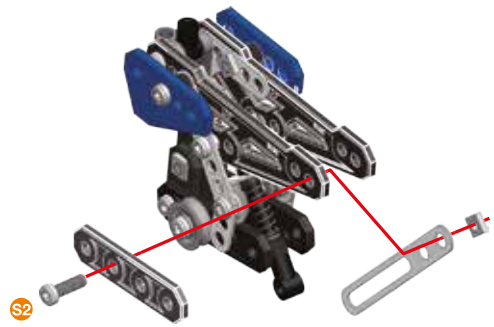

- 10**
- | | | |
|---|----------------|-----------|
|  | | x1 |
|  | | x1 |
|  | 9,5 mm 3/8" | x1 |
|  | | x1 |

- | | | |
|--|-----------|------------|
|  | S2 | 1:1 |
|--|-----------|------------|

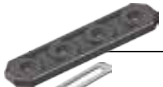



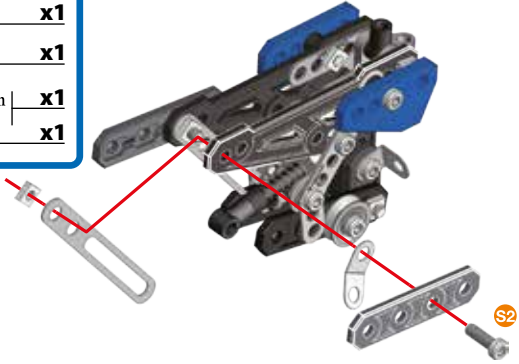

11

-  x1
-  x1
-  x1
-  9,5 mm | 3/8" | x1
-  x1

| | | |
|---|----|-----|
|  | S2 | 1:1 |
|---|----|-----|



12

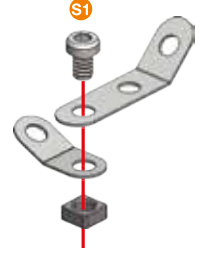

-  x1
-  x1
-  S1 | 5,8 mm | 15/64" | x1
-  x1

| | | |
|---|------|-----|
|  | S1 | 1:1 |
|  | D277 | |



13

11 + 12 +

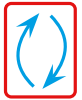

-  S2 | 9,5 mm | 3/8" | x1
-  x1

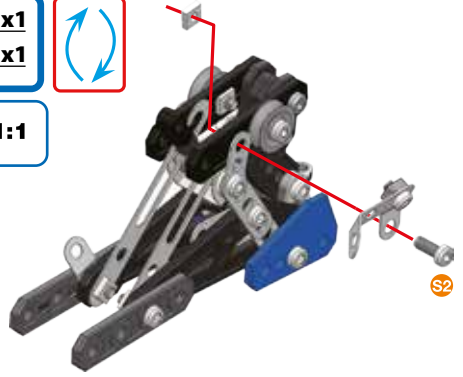

| | | |
|---|----|-----|
|  | S2 | 1:1 |
|---|----|-----|



14





-  S2 | 9,5 mm | 3/8" | x1
-  x1

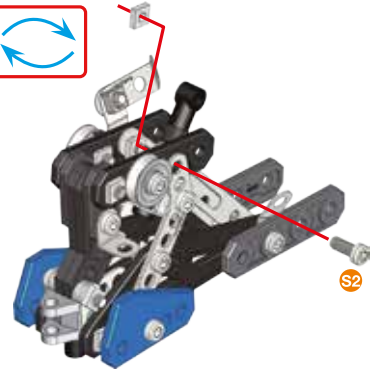

| | | |
|---|----|-----|
|  | S2 | 1:1 |
|---|----|-----|





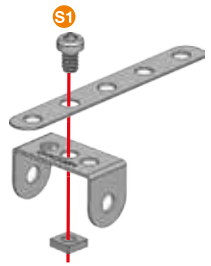

15

-  **x1**
 -  **x1**
 -  **x1**
 -  **x1**
- | | | |
|---|-----------|------------|
|  | S1 | 1:1 |
|---|-----------|------------|





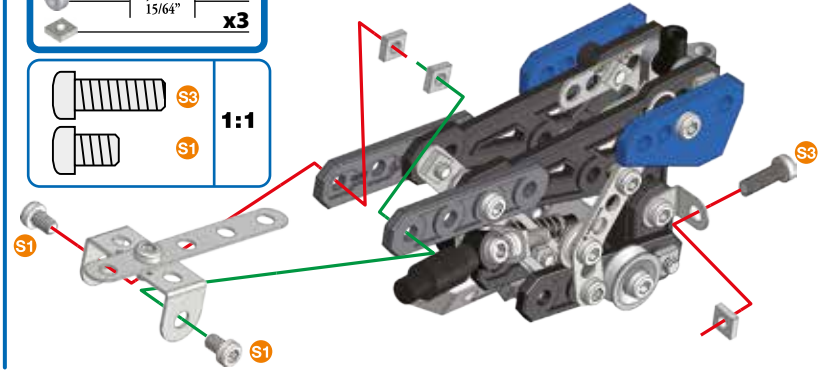

16

(14) + (15) +

-  **S3** | 12 mm | **x1**
 -  **S1** | 5,8 mm | **x2**
 -  | 15/64" | **x3**
- | | | |
|---|-----------|------------|
|  | S3 | 1:1 |
|  | S1 | |





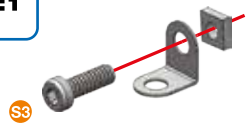

17

-  **S3** | 12 mm | **x1**
 -  | 1/2" | **x1**
 -  **x1**
- | | | |
|---|-----------|------------|
|  | S3 | 1:1 |
|---|-----------|------------|



18



-  **x2**
-  **x1**
-  **x1**
-  **x1**

- | | | |
|--|-------------|------------|
|  | A238 | 1:1 |
|  | A338 | |



19

(17) + (18) +

| | | | | | |
|---|----------------|----|---|----|-----|
|  | 9,5 mm 3/8" | x1 |  | S2 | 1:1 |
|  | | x1 | | | |

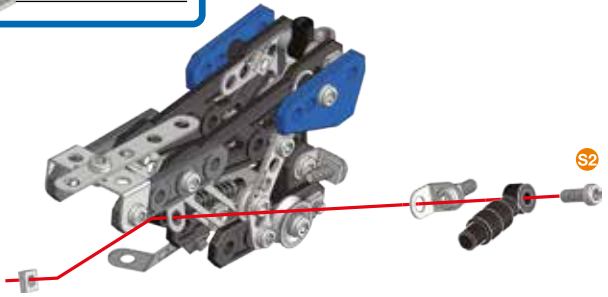



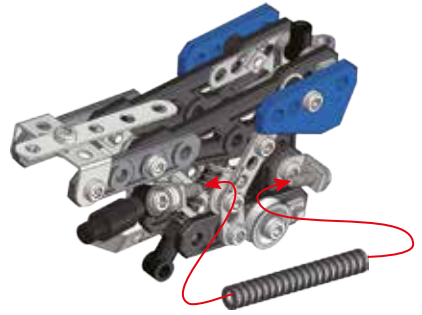

20

| | |
|--|----|
|  | x1 |
|--|----|





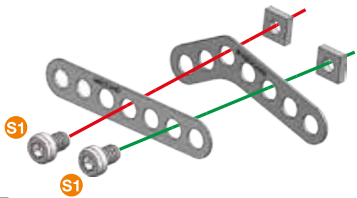

21

| | | |
|---|------------------|----|
|  | x1 | |
|  | x1 | |
|  | 5,8 mm 15/64" | x2 |
|  | | x2 |

| | | |
|---|----|-----|
|  | S1 | 1:1 |
|---|----|-----|



22



| | | |
|---|------------------|----|
|  | x1 | |
|  | x1 | |
|  | 5,8 mm 15/64" | x2 |
|  | | x2 |

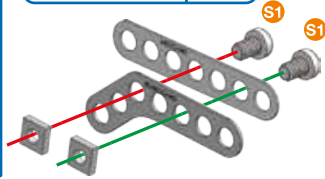

| | | |
|---|----|-----|
|  | S1 | 1:1 |
|---|----|-----|



23

(21) + (22) +

| | | |
|---|---------------|----|
|  | 25,4 mm 1" | x1 |
|  | | x1 |
|  | | x1 |

| | | |
|---|------|-----|
|  | S5 | 1:1 |
|  | D277 | |
|  | | |

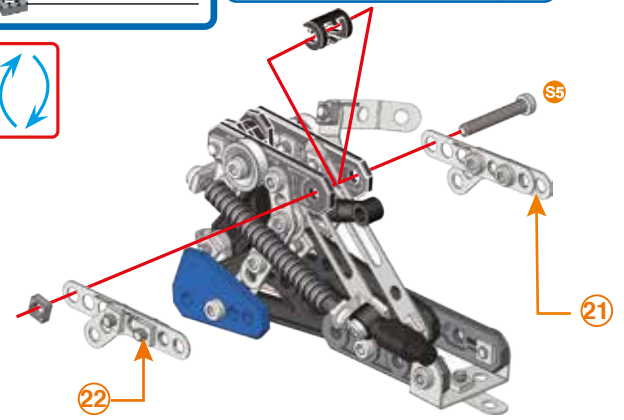
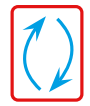

24

- 32mm | 1 1/4" | x1
- x2
- x2



A338

1:1

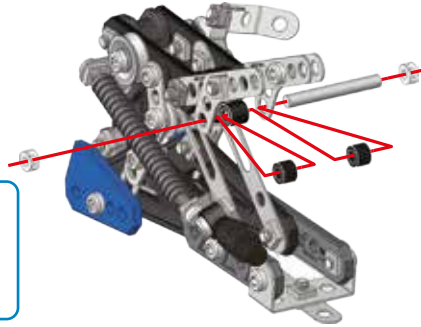

25

- x1
- x1
- S1 | 5,8 mm | 15/64" | x1
- x1



S1

1:1

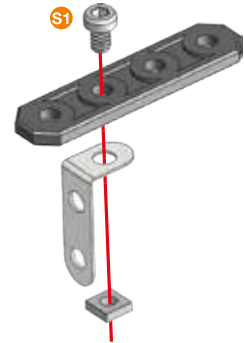

26

24 + 25 +

- S1 | 5,8 mm | 15/64" | x1



S1

1:1

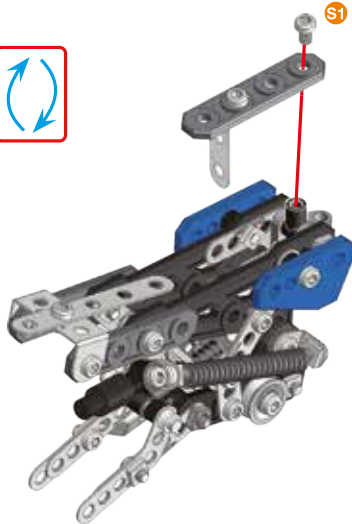

27

- x1
- x1
- x1
- x1
- S1 | 5,8 mm | 15/64" | x2
- x1



S1

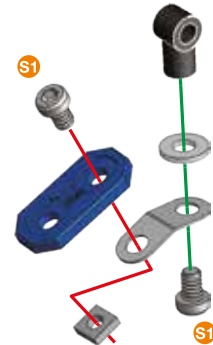

1:1

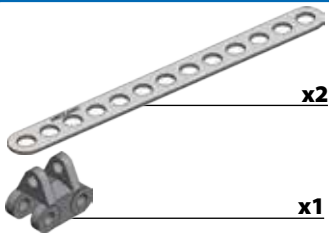
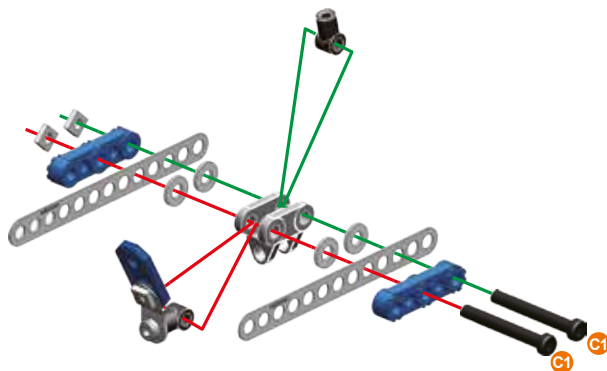
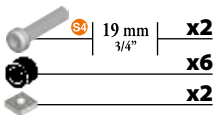
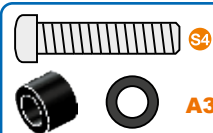
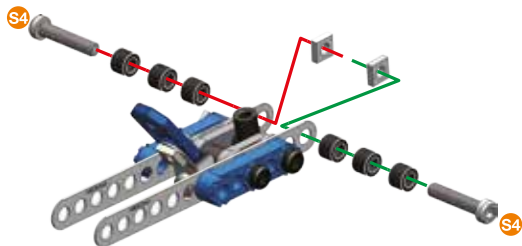
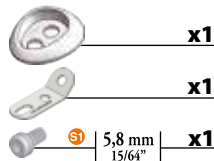

28**(27)+****x2****x2****x2****x1****x4****x2****1:1****29****x2****x6****x2****S4****A338****1:1****30****x1****x1****x1****S1****1:1**

31



(26) + (30) +

-  23 mm | **x1**
-  | **x1**

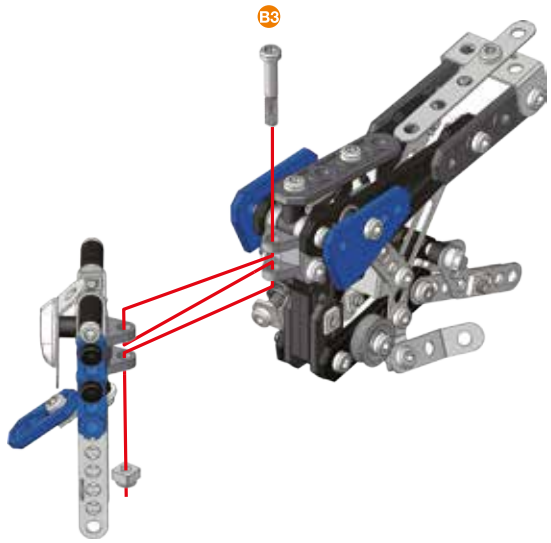
-  | **x1**







32

-  | **x2**
-  | **x2**





33

(31) + (32) +

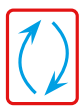

-  | **x1**
-  | **x2**
-  | **x1**
-  23 mm | **x1**
-  | **x1**



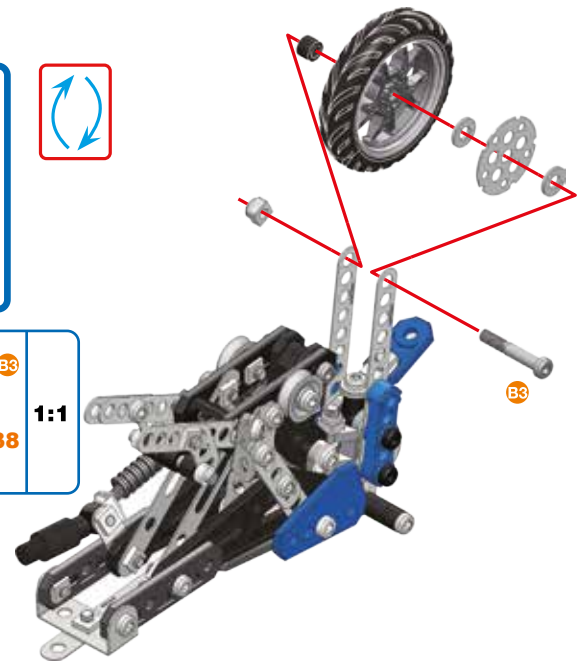

-  | **x1**
-  | **x1**
-  | **x1**
- A338**



34 32 + 33 +

-  **x2**
-  **28 mm** | **x1**
1 1/8"
-  **x1**

-  **S6**
-   **A238**
- 1:1**

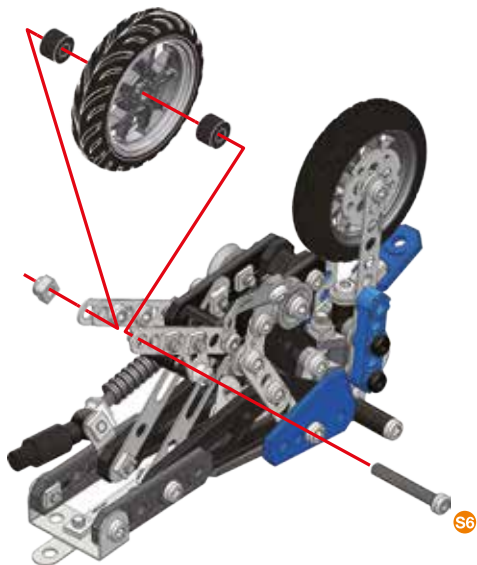

35

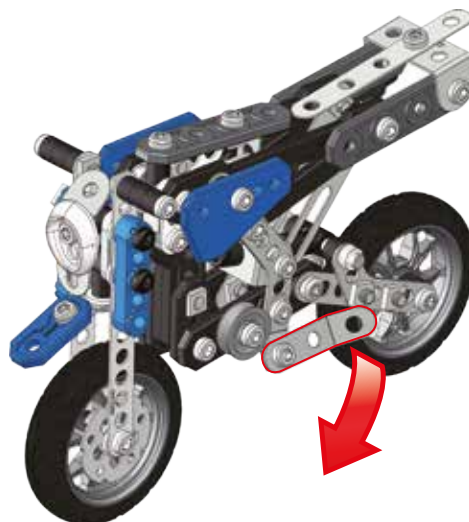



1

| | | | | |
|--|--------|----|--|----|
| | 32mm | x1 | | x1 |
| | 1 1/4" | x2 | | x2 |
| | | x1 | | |
| | | x2 | | |

| | |
|--|-----|
| | 1:1 |
|--|-----|

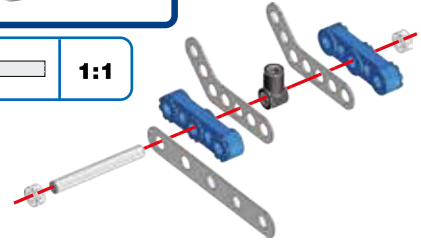



2

| | | |
|--|--------|----|
| | 25,4mm | x1 |
| | | x1 |
| | | x1 |
| | | x2 |
| | | x1 |

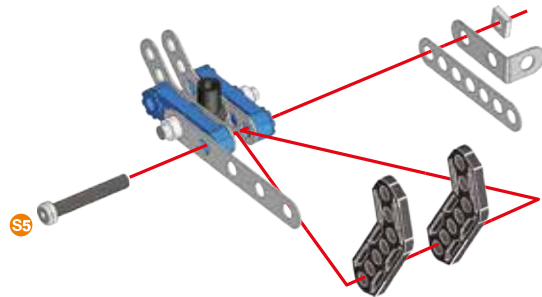
| | | |
|--|----|-----|
| | SS | 1:1 |
|--|----|-----|









3

| | | |
|---|---------------|-----------|
|  | 19 mm 3/4" | x1 |
|  | | x2 |
|  | | x1 |



| | | |
|---|-----------|------------|
|  | S4 | 1:1 |
|---|-----------|------------|

**4**

| | | |
|---|------------------|-----------|
|  | | x1 |
|  | | x1 |
|  | 12 mm 1/2" | x1 |
|  | 5,8 mm 15/64" | x1 |
|  | | x2 |
|  | | x1 |

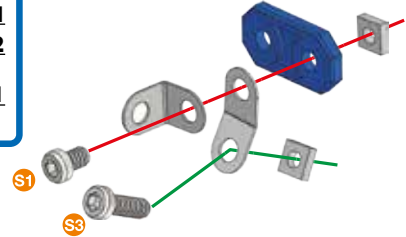



| | | |
|---|-----------|------------|
|  | S3 | 1:1 |
|  | S1 | |

**5****3 + 4 +**

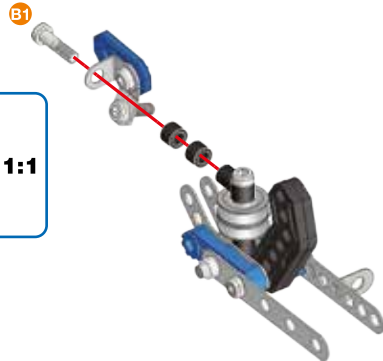
| | | |
|---|-------------------|-----------|
|  | 14,7 mm 37/64" | x1 |
|  | | x2 |

| | | |
|---|-------------|------------|
|  | B1 | 1:1 |
|  | A338 | |

**6**

| | | |
|---|---------------|-----------|
|  | | x1 |
|  | | x2 |
|  | 12 mm 1/2" | x1 |
|  | | x1 |

| | | |
|---|-----------|------------|
|  | S3 | 1:1 |
|---|-----------|------------|

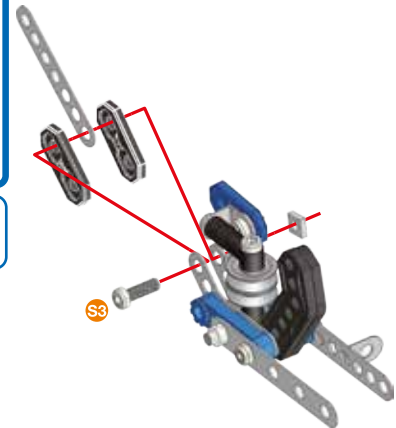

7

| | |
|--|-----------|
| | x2 |
| | x2 |
| | x2 |
| | x2 |

| | |
|--|------------|
| | 1:1 |
|--|------------|



8 (7+)

| | |
|--|-----------|
| | x2 |
| | x1 |
| | x2 |
| | x1 |

| | |
|--|------------|
| | 1:1 |
| | 1:1 |
| | 1:1 |





9 (6+)(8+)

| | |
|--|-----------|
| | x2 |
| | x1 |
| | x1 |
| | x4 |

| | |
|--|------------|
| | 1:1 |
|--|------------|

10

11

| | | | |
|---|-------------|---|------------|
|  | x1 |  S3 | 1:1 |
|  | x1 | | |
|  | x1 | | |
|  | A338 | | |

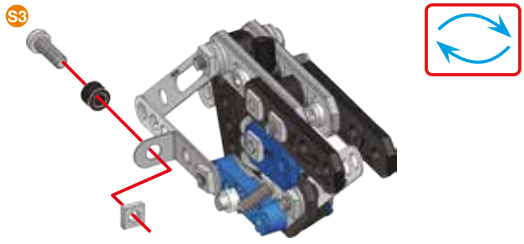





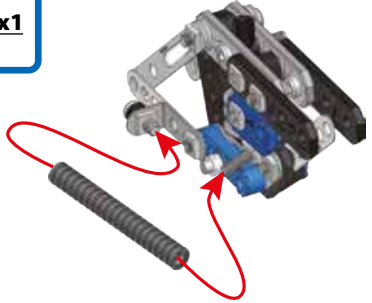

12

| | |
|--|-----------|
|  | x1 |
|--|-----------|



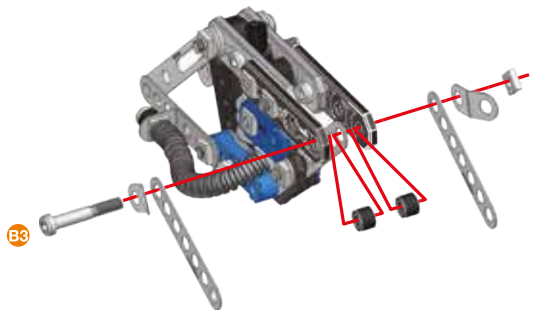

13

| | | | |
|---|-------------|---|------------|
|  | x2 |  B3 | 1:1 |
|  | x1 | | |
|  | x1 | | |
|  | x2 | | |
|  | x2 | | |
|  | A338 | | |





14

| | | |
|---|-------------------|-----------|
|  | 14,7 mm 37/64" | x2 |
|  | | x4 |

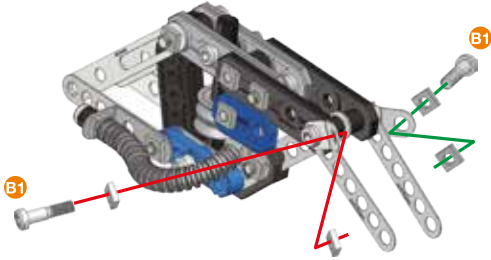
| | | |
|---|-----------|------------|
|  | B1 | 1:1 |
|---|-----------|------------|



15

| | | |
|---|----------------|-----------|
|  | | x2 |
|  | 9,5 mm 3/8" | x2 |
|  | | x1 |

| | | |
|---|-----------|------------|
|  | S2 | 1:1 |
|---|-----------|------------|

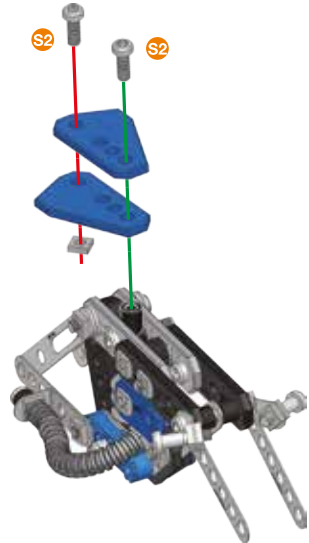

16

| | |
|---|-----------|
|  | x2 |
|---|-----------|

| | |
|---|-----------|
|  | x2 |
|---|-----------|









x2



17





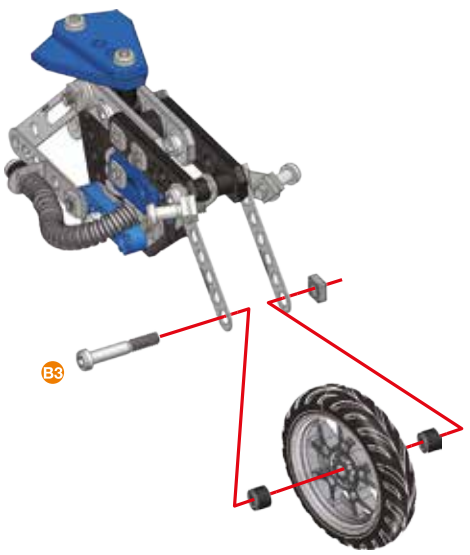

15 + 16 +

| | | | | | |
|---|------------------|----|---|----|-----|
|  | 23 mm 1 5/16" | x1 |  | B3 | 1:1 |
|  | | x2 | | | |
|  | | x1 | | | |
|  | | | | | |
|  | | | D277 | | |



18

16 + 17 +

| | | | | | |
|---|-----------------|----|---|----|-----|
|  | 28 mm 1 1/8" | x1 |  | S6 | 1:1 |
|  | | x1 | | | |
|  | | x1 | | | |
|  | | x1 | | | |
|  | | | A238 | | |
|  | | | A338 | | |

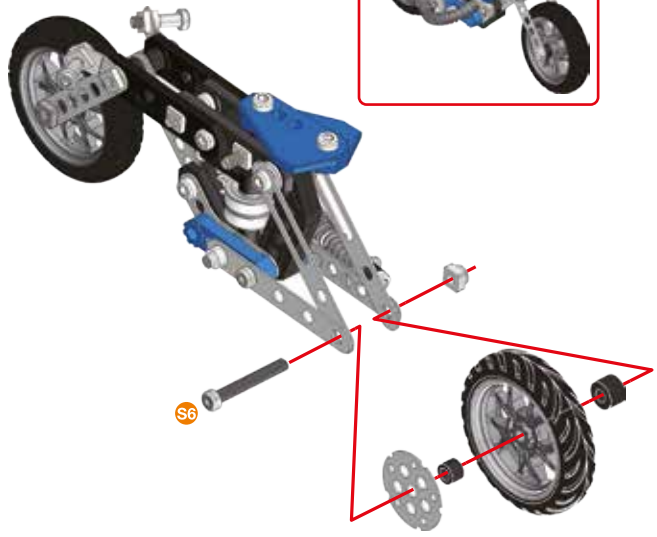



- 1**
- x1
 - x1
 - $\frac{9,5 \text{ mm}}{3/8''}$ x2
 - x2

- $\frac{1}{2''}$ x1

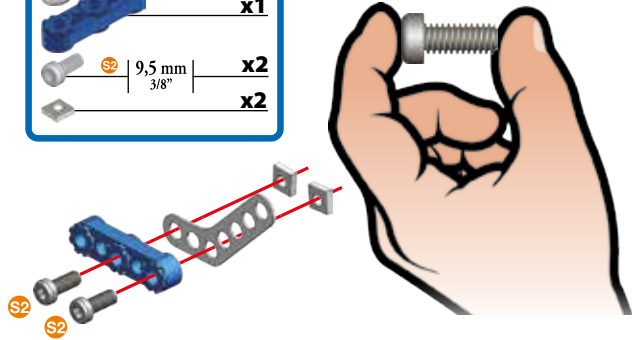

- 2**
- x1
 - x1
 - x1
 - $\frac{12 \text{ mm}}{1/2''}$ x2
 - x2

- $\frac{1}{2''}$ x1

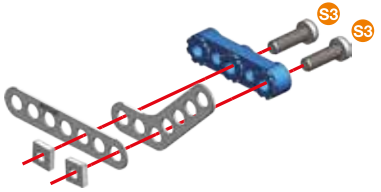

- 3** ① + ② +
- $\frac{25,4 \text{ mm}}{1''}$ x1
 - x1
 - x1
 - x2
 - x1

- $\frac{1}{2''}$ x1
- A338 x1

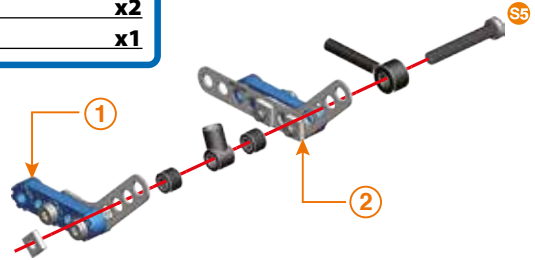

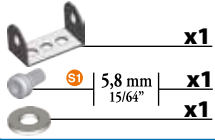
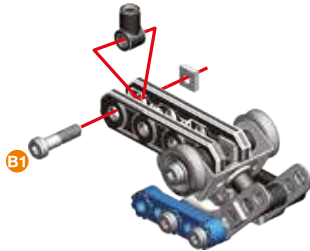
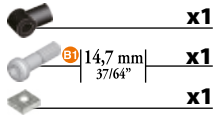
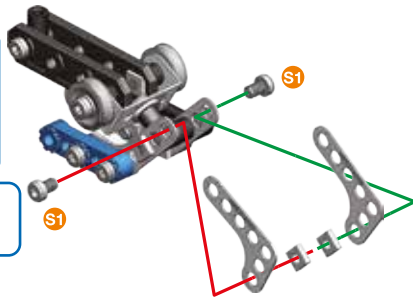
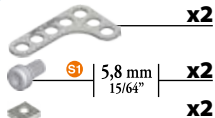
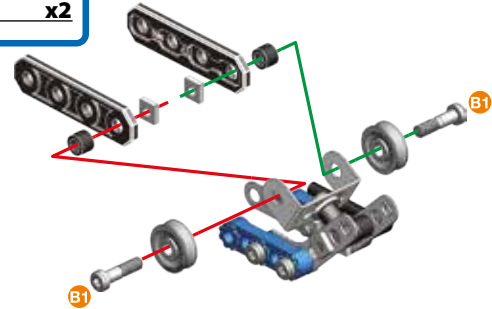
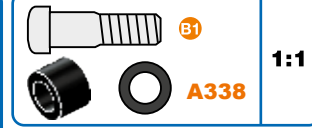
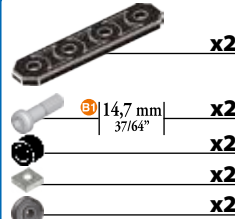
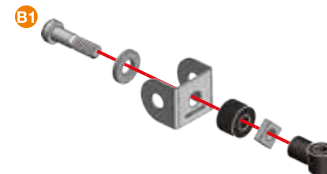
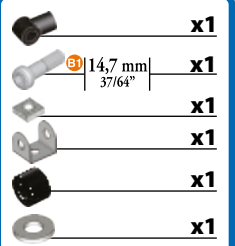
4**6****7****5****8**

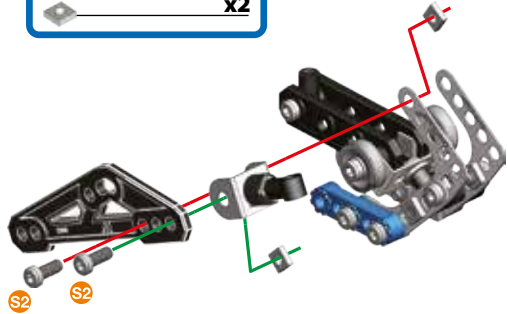
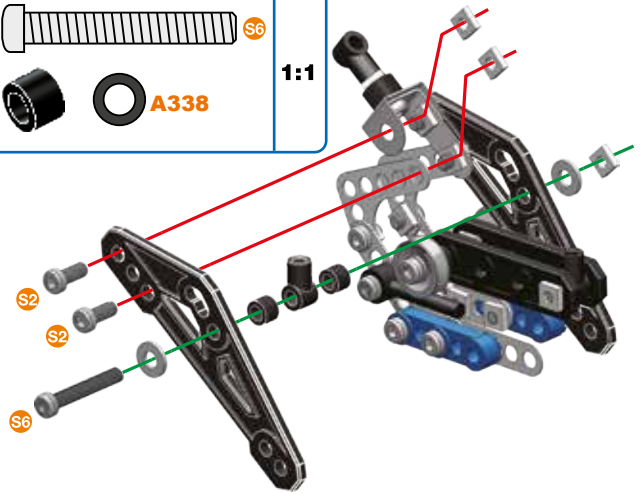
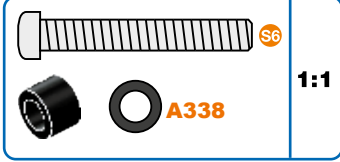
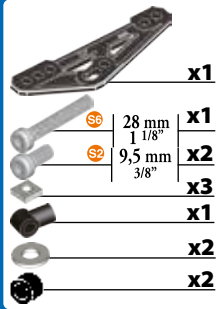
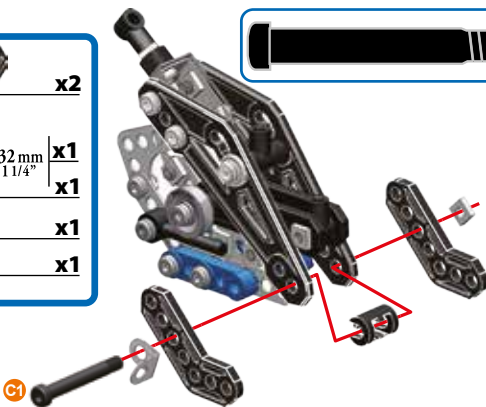
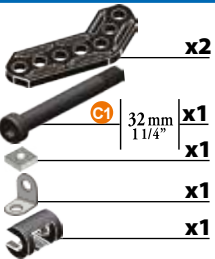
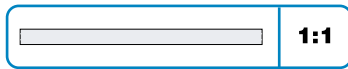
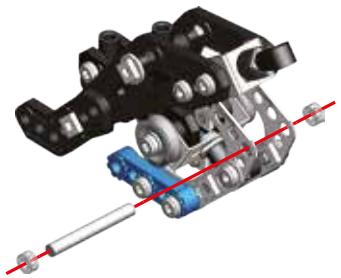
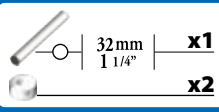
9**7 + 8 +****10****11****12**

13

| | |
|--|-----------|
| | x2 |
| | x1 |
| | x4 |
| | x2 |
| | x2 |
| | x2 |

| | | |
|--|-------------|------------|
| | S4 | 1:1 |
| | A238 | |

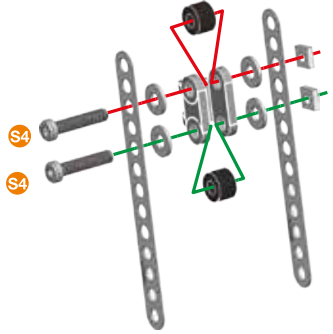

14

(11) + (12) +

| | | | |
|--|-----------|---------------|-----------|
| | B3 | 23 mm | x2 |
| | | 15/16" | x4 |
| | | | x2 |

| | | |
|--|-------------|------------|
| | B3 | 1:1 |
| | A338 | |

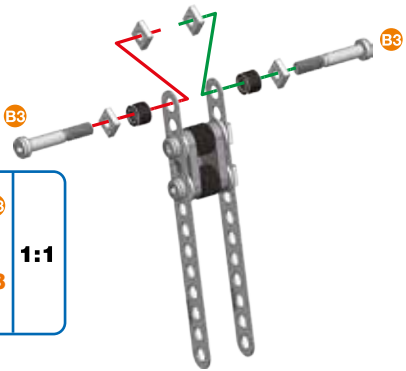

15

(12) + (14) +

| | | | |
|--|-----------|---------------|-----------|
| | C1 | 32 mm | x1 |
| | | 1 1/4" | x1 |
| | | | x1 |

| | | |
|--|-----------|------------|
| | C1 | 1:1 |
|--|-----------|------------|

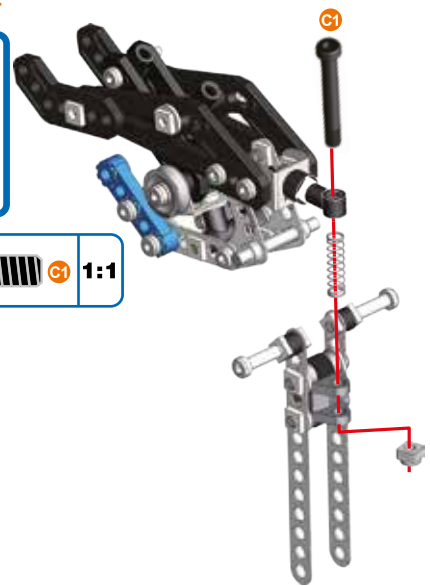



16

| | | | |
|--|-----------|---------------|-----------|
| | x2 | | |
| | x1 | | |
| | x1 | | |
| | S2 | 9,5 mm | x2 |
| | | 3/8" | x2 |

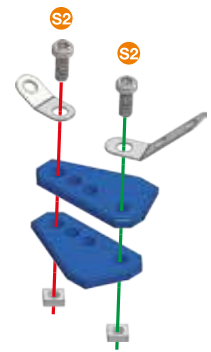
| | | |
|--|-----------|------------|
| | S2 | 1:1 |
|--|-----------|------------|





17 15+ 16+

| | |
|--|----|
|  | x1 |
|  12 mm 1/2" | x1 |

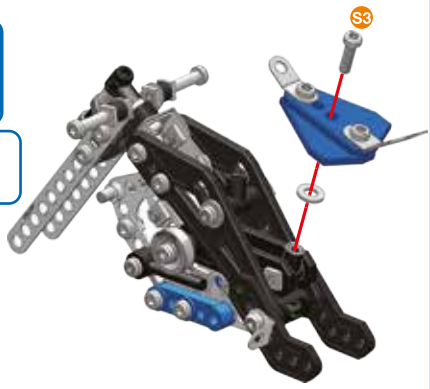
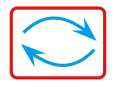
| | | |
|---|----|-----|
|  | S3 | 1:1 |
|---|----|-----|





19 17+ 18+

| | | |
|---|---------------|----|
|  | 9,5 mm 3/8" | x1 |
|  | | x1 |

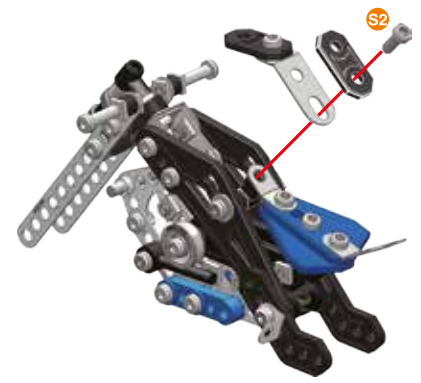
| | | |
|---|----|-----|
|  | S2 | 1:1 |
|---|----|-----|



18





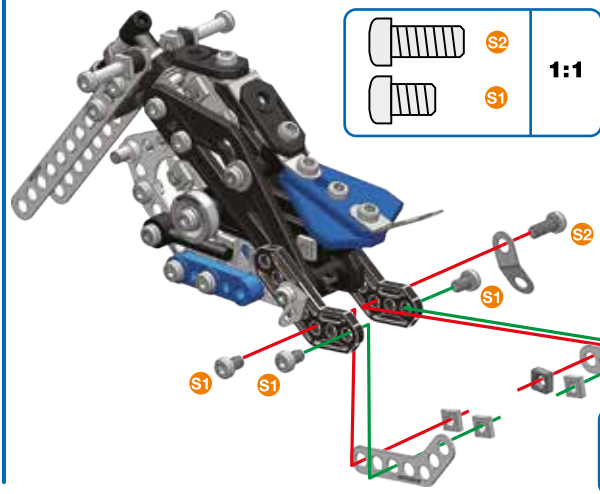

| | |
|---|----|
|  | x1 |
|  | x1 |
|  5,8 mm 15/64" | x1 |
|  | x1 |

| | | |
|---|----|-----|
|  | S1 | 1:1 |
|---|----|-----|



| | | |
|--|----|-----|
|  | S2 | 1:1 |
|  | S1 | |

20

| | |
|---|----|
|  | x2 |
|  9,5 mm 3/8" | x1 |
|  5,8 mm 15/64" | x3 |
|  | x1 |
|  | x3 |
|  | x1 |

| | | | |
|---|---|------|-----|
|  |  | D277 | 1:1 |
|---|---|------|-----|

21

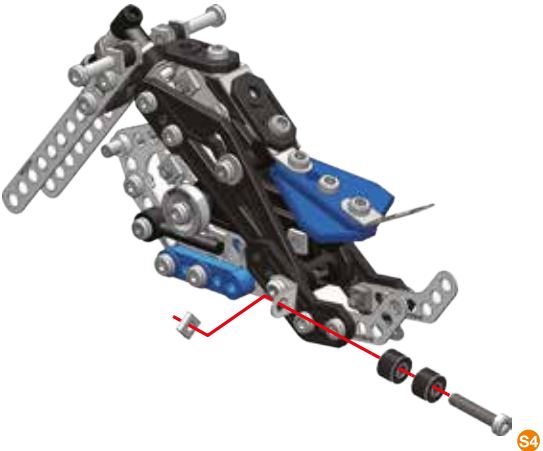
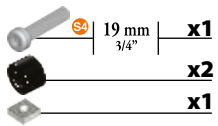

22

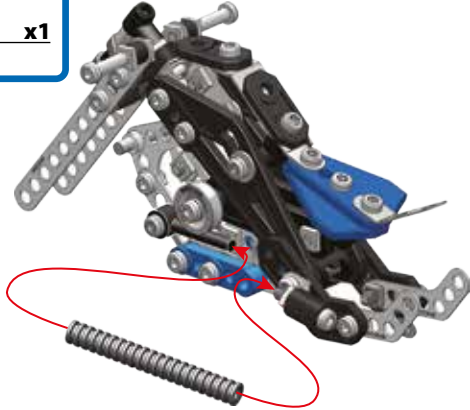

23

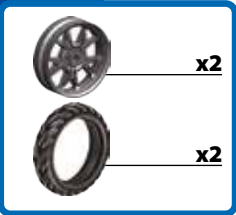



x2





24

22 + 23 +

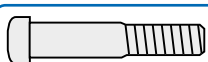
-  23 mm | x1
15/16"
-  x1
-  x2

 B3



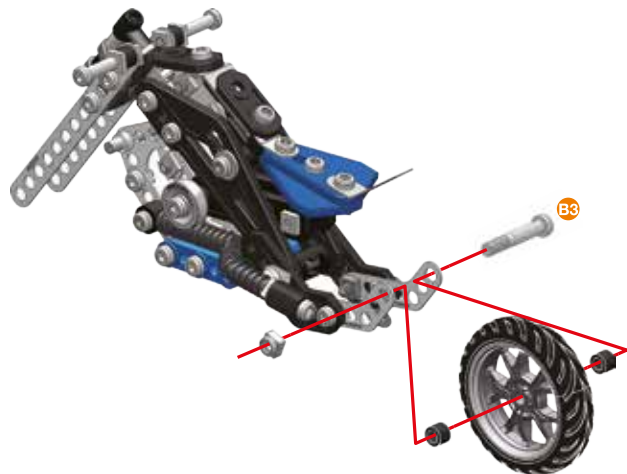

  A338

1:1





25

23 + 24 +

-  x1
-  x2
-  x1
-  23 mm | x1
15/16"
-  x1

 B3

  A338

1:1

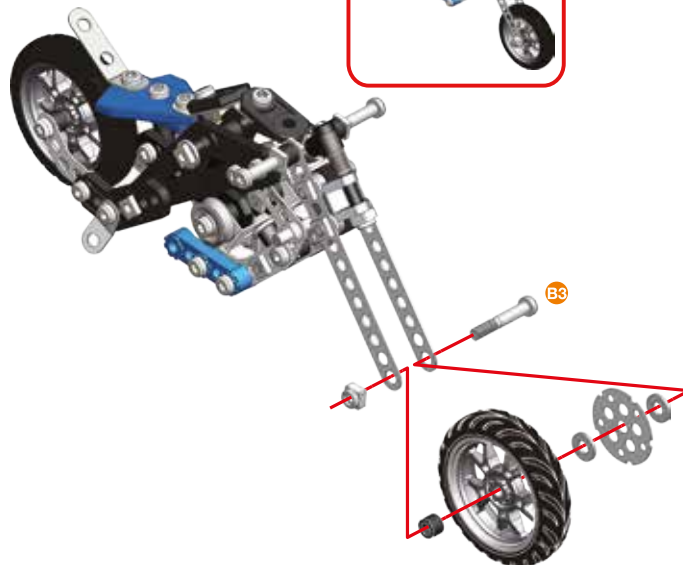



D018 x2



D050 x2



D050 x3



D077 x2



A260 x2

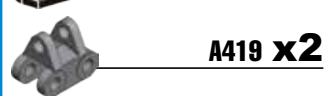

A419 x2



A420 x2



C380 x1

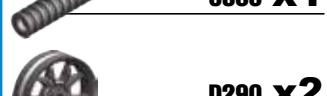

D290 x2

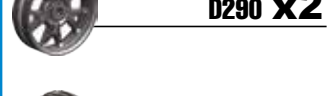

D288 x2



C773 x2



A235 x1

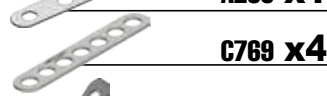

C769 x4



A437 x1

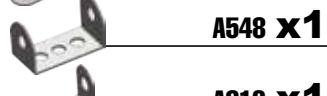

A548 x1



A812 x1

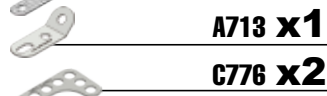

B698 x2

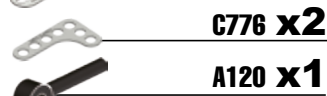

A713 x1

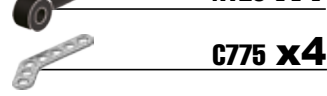

C776 x2

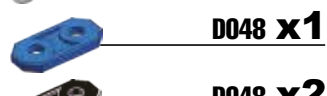

A120 x1

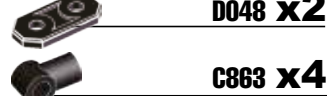

C775 x4



D048 x1



D048 x2



C863 x4



D292 x1



D291 x1



D091 x1



A737 x3

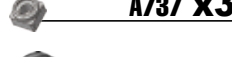

A524 x2



C483 x3



C330 x2

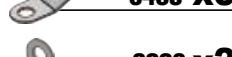

A720 x1

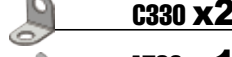

A238 x5



A338 x14



A359 x1



A337 x30



A259 x2

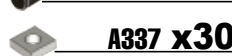

D277 x4

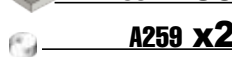

A138 x11



A353 x1



C1
32 mm
1 1/4"

C935 x3



S6
28 mm
1 1/8"

A611 x1



S5
25,4 mm
1"

A912 x1



B3
23 mm
15/16"

A347 x4

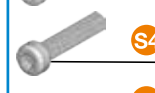

S4
19 mm
3/4"

A911 x3



B1
14,7 mm
37/64"

A247 x4



S3
12 mm
1/2"

A411 x3



S2
9,5 mm
3/8"

A511 x10

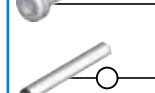

S1
5,8 mm
15/64"

A637 x15



32 mm
1 1/4"

A518 x1



C995 x1



C993 x1

EN. Remove all packaging before use. Retain this information, addresses and phone numbers for future reference. Content may vary from pictures. Meccano reserves the right to discontinue the website www.meccano.com at any time. An adult should periodically check this toy to ensure no damage or hazards exist, if so, remove from use. Children should be supervised during play.

FR. Retirer tout l'emballage avant utilisation. Conserver les informations, adresses et numéros de téléphone pour consultation ultérieure. Le contenu peut différer des images. Meccano se réserve le droit de supprimer le site Internet www.meccano.com à tout moment. Le contenu peut différer des images. Un adulte doit régulièrement examiner ce jouet afin de s'assurer qu'il ne présente pas de dommage ni de risque. En cas de problème, ne plus l'utiliser. Les enfants doivent être surveillés lorsqu'ils jouent.

ES. Retire todo el embalaje antes de utilizar el producto. Conserve toda la información, las direcciones y los números de teléfono para futuras referencias. El contenido del paquete puede no corresponder con las imágenes. Meccano se reserva el derecho a suspender el sitio web www.meccano.com en cualquier momento. Un adulto debe revisar de forma periódica el juguete para asegurarse de que no supone un riesgo para el niño, si así fuera el caso, interrumpa su uso. Supervise a los niños mientras juegan con el producto.

DE. Entfernen Sie vor der Benutzung sämtliche Verpackungsmaterialien. Alle Informationen, Adressen und Telefonnummern bitte für mögliche Rückfragen aufbewahren. Der Packungsinhalt kann von den Bildern abweichen. Meccano behält sich das Recht vor, den Betrieb der Website www.meccano.com jederzeit einzustellen. Ein Erwachsener sollte regelmäßig sicherstellen, dass das Spielzeug keine Gefahr darstellt, und es gegebenenfalls entfernen. Kinder sollten beim Spielen beaufsichtigt werden.

NL. Verwijder de verpakking voor gebruik. Bewaar deze informatie, adressen en telefoonnummers voor toekomstig gebruik. Inhoud kan afwijken van illustraties. Meccano behoudt zich het recht voor de website www.meccano.com wanneer gewenst buiten gebruik te stellen. Een volwassene dient dit speelgoed regelmatig te controleren. In geval van schade of gevaar het speelgoed niet meer gebruiken. Houd toezicht als kinderen spelen.

IT. Rimuovere l'imballo prima dell'uso. Conservare informazioni, indirizzi e numeri di telefono per riferimento futuro. Il prodotto potrebbe essere differente dalle immagini. Meccano si riserva il diritto di rimuovere il sito www.meccano.com in qualsiasi momento. Il giocattolo deve essere periodicamente controllato da un adulto per prevenire eventuali danni o rischi; in caso di danno, sospendere l'uso. I bambini devono essere sorvegliati durante il gioco.

PT. Remova totalmente a embalagem antes de utilizar. Guarde todos os endereços, números de telefone e demais informações para consulta e referência. O conteúdo poderá ser diferente das ilustrações. A Meccano reserva-se o direito de descontinuar o site www.meccano.com a qualquer altura. Um adulto deve verificar o brinquedo periodicamente para garantir que não há danos ou riscos. Se houver, é necessário que o brinquedo seja retirado de uso. Crianças devem ser supervisionadas enquanto brincam.

RU. Снимите все упаковочные материалы перед использованием. Запишите указанные на упаковке адреса и номера телефонов, чтобы у вас была возможность связаться с нами. Содержимое упаковки может отличаться от иллюстрации. Компания Meccano оставляет за собой право прекратить использование сайта www.meccano.com в любое время. Взрослым следует время от времени проверять игру и следить за тем, чтобы она не была сломана и не представляла опасности для ребенка. В противном случае ее не следует использовать. Во время игры дети должны находиться под присмотром.

PL. Przed użyciem wyjąć zabawkę z opakowania. Zachować niniejsze informacje, adresy i numery telefonów na wypadek, gdyby były potrzebne w przyszłości. Zawartość opakowania może różnić się od zabawki przedstawionej na obrazkach. Firma Meccano zastrzega sobie prawo do zaprzestania korzystania z witryny www.meccano.com w dowolnym momencie. Osoba dorosła powinna regularnie sprawdzać zabawkę pod kątem uszkodzeń oraz zagrożeń. Jeśli takowe wystąpią, należy zaprzestać używania zabawki. Dzieci nie powinny bawić się bez nadzoru.

CZ. Před použitím odstráňte veškeré balící materiály. Uložte si tyto informace, adresy a telefonní čísla pro budoucí použití. Obsah se může lišit od obrázků. Společnost Meccano si vyhrazuje právo kdykoli ukončit web www.meccano.com. Dospělá osoba by měla pravidelně kontrolovat, zda hračka není poškozena nebo zda nepředstavuje nebezpečí. Pokud ano, hračku vyhoďte. Během hry nenechávejte děti bez dozoru.

SK. Pred použitím odstráňte všetok obalový materiál. Tieto informácie, adresy a telefónne čísla si uchovajte na ďalšie použitie. Obsah sa môže líšiť od zobrazenia. Spoločnosť Meccano si vyhradzuje právo kedykoľvek ukončiť používanie webovej lokality www.meccano.com. Túto hračku musí pravidelne kontrolovať dospelá osoba, aby sa uistila, že nedošlo k jej poškodeniu a že nehrozí žiadne nebezpečenstvo. Ak áno, ukončíte jej používanie. Deti nesmú byť pri hre bez dozoru.

TM & © 2016 MECCANO for packaging, instructions and models built with this set. © MECCANO is an exclusive trademark of MECCANO. Spin Master logo is a trademark of Spin Master Ltd. All rights reserved. / TM & © 2016 MECCANO pour l'emballage, les notices et modèles de ce coffret. © MECCANO est une marque de commerce exclusive de MECCANO. Le logo de Spin Master est une marque de commerce de Spin Master Ltd. Tous droits réservés.

HU. Használat előtt távolítsa el minden csomagolóanyagot. A tudnivalókat, a címet és a telefonszámot őrizze meg későbbi használatra. A csomag tartalma eltérhet a képen látottaktól. A Meccano fenntartja magának a jogot, hogy bármikor felfüggeszesse a www.meccano.com weboldal használatát. A felhőknek rendszeresen ellenőrizniük kell, hogy a játék nem jelent-e veszélyforrást. Ha igen, ki kell vonni a használatból. A gyermekek játék közben felügyeletet igényelnek.

RO. Îndepărtați toate ambalajele înainte de utilizare. Păstrați aceste informații, adresele și numerele de telefon pentru consultare ulterioară. Conținutul poate fi diferit de imaginea din fotografii. Meccano își rezervă dreptul de a întrerupe utilizarea site-ului web www.meccano.com în orice moment. Această jucărie trebuie verificată periodic de un adult pentru a se asigura că nu există nicio deteriorare sau niciun pericol; dacă există, scoateți jucăria din uz. Copiii trebuie supravegheați în timp ce se joacă.

- ⚠ Warning: CHOKING HAZARD – Small parts.
- ⚠ Attention ! RISQUE D'ETOUFFEMENT – Contient de petits éléments.
- ⚠ Advertencia: PELIGRO DE ASFIXIA – Contiene piezas pequeñas
- ⚠ Achtung: ERSTICKUNGSGEFAHR – Kleinteile.
- ⚠ Waarschuwing: VERSTIKKINGSGEVAAR – Kleine onderdelen.
- ⚠ Attenzione: RISCHIO DI SOFFOCAMENTO – Pezzi piccoli.
- ⚠ Aviso: PERIGO DE ASFIXIA – Peças pequenas.
- ⚠ Осторожно! ОПАСНОСТЬ УДУШЬЯ – Мелкие детали.
- ⚠ Uwaga! NIEBEZPECZENSTVO ZADĚLENIA – drobne elementy.
- ⚠ Upozornění: NEBEZPEČÍ UDUŠENÍ – Obsahuje malé části.
- ⚠ Varovanie: NEBEZPEČENSTVO UDUŠENIA – Obsahuje malé predmety.
- ⚠ Figyelem! FULLADÁSVESZÉLY – Apró alkatrészek.
- ⚠ Avertisment: PERICOL DE ASFIXIERE – Piese mici.



Meets CPSC Safety Requirements.
Conforme aux exigences de sécurité de la CPSC.
Cumple con las normas de seguridad de la CPSC.

SPIN MASTER LTD., 450 FRONT STREET WEST, TORONTO, ON M5V 1B6 CANADA.
Imported into EU by SPIN MASTER INTERNATIONAL, S.A.R.L.,
16 AVENUE PASTEUR, L-2310, LUXEMBOURG. www.spinmaster.com
Made in China / Fabriqué en Chine / Hecho en China



T91785_0012_20084596_GML_IB_R1R1_MEC_Motorcycles_CN_S17

UK – 0800 206 1191, serviceuk@spinmaster.com
IRELAND – 1800 992 249
FRANCE – 0800 909 150, servicefr@spinmaster.com
DEUTSCHLAND – 00800 0101 0222, Kundenservice@spinmaster.com
SCHWEIZ – 0800 561 350 • ÖSTERREICH – 0800 297 267
NETERLAND – 0800 022 3683, klantenservice@spinmaster.com
BELGIË/BELGIQUE – 0800 77 688 • LUXEMBOURG – 800 2 8044

ITALIA – 800 788 532, servizio@spinmaster.com
MEXICO – 55 4160 7947, servicio@spinmaster.com
PÓLSKA – 800080238, poland@spinmaster.com
ČESKÁ REPUBLIKA – 800550530, czechrepublic@spinmaster.com
SLOVENSKO – 0800232800, slovakia@spinmaster.com
MAGYARORSZÁG – 080 100 052, hungary@spinmaster.com
ROMÂNIA – 0800400015, romania@spinmaster.com

NORTH AMERICA • AMÉRIQUE DU NORD 1-800-622-8339, CUSTOMERCARE@SPINMASTER.COM

WWW.SPINMASTER.COM

