

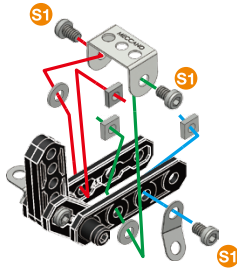

**2**

		<b>x1</b>
		<b>x1</b>
	5,8 mm 15/64"	<b>x3</b>
		<b>x3</b>
		<b>x2</b>

	<b>S1</b>	<b>1:1</b>
--	-----------	------------



**1**





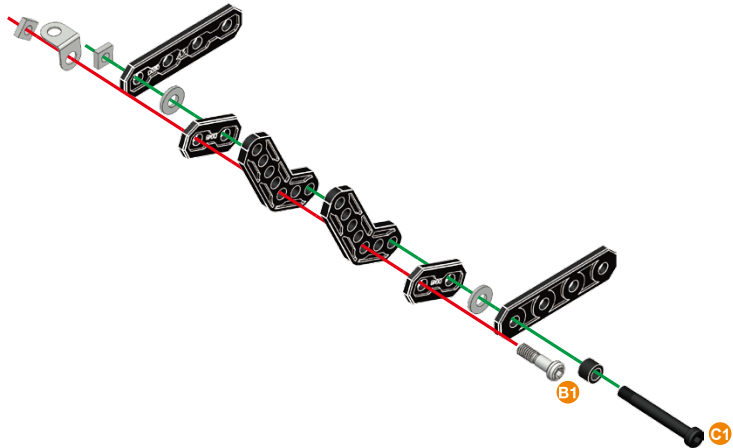
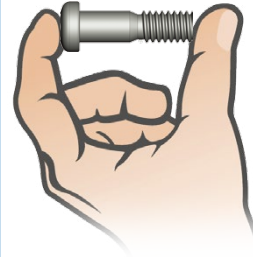

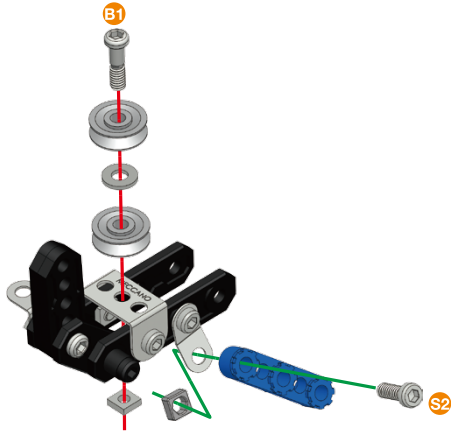
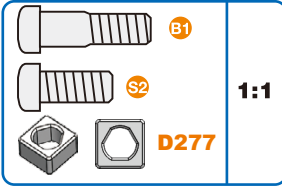
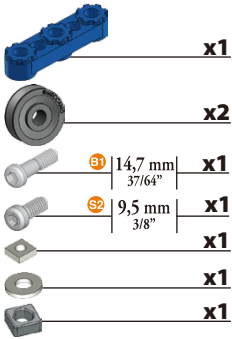
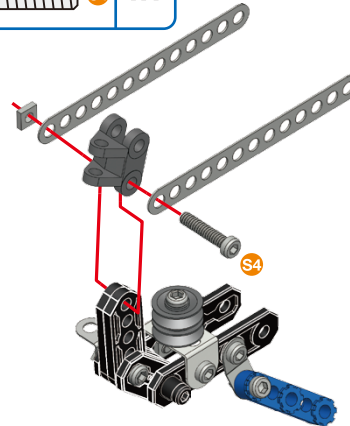
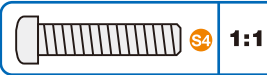
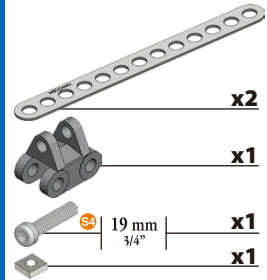
		<b>x2</b>
		<b>x2</b>
		<b>x2</b>
		<b>x1</b>
	32 mm 1 1/4"	<b>x1</b>
	14,7 mm 37/64"	<b>x1</b>
		<b>x2</b>
		<b>x1</b>
		<b>x2</b>



	<b>C1</b>	<b>1:1</b>
	<b>B1</b>	
	<b>A338</b>	



**3****4**



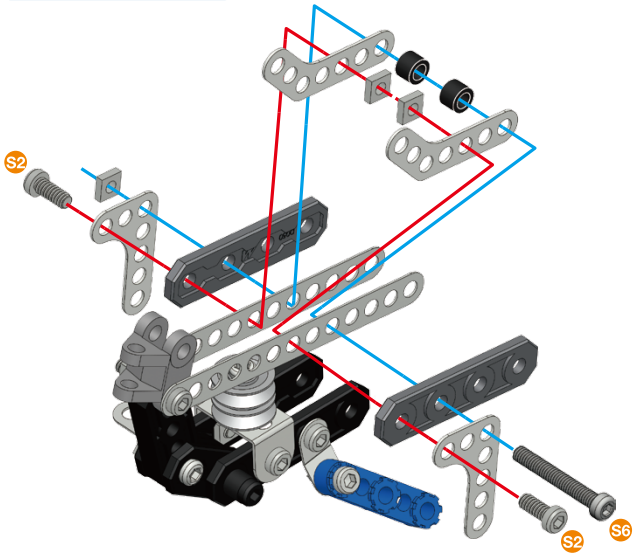

# 5

-  x2
-  x2
-  x2
-  28 mm  
1 1/8" x1
-  9,5 mm  
3/8" x2
-  x3
-  x2

	S6	<b>1:1</b>
	S2	
	<b>A338</b>	



# 6

- |   |    |                  |    |   |   |    |
|---|----|------------------|----|---|---|----|
|  | S2 | 9,5 mm<br>3/8"   | x1 |  | x2  |    |
|  | S1 | 5,8 mm<br>15/64" | x1 |   |  | x1 |
|  |    |                  | x2 |   |   |    |

	S2	<b>1:1</b>
	S1	

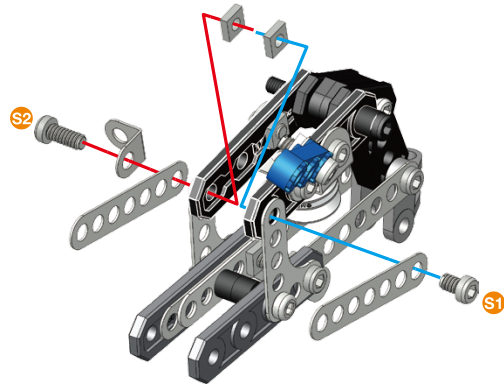

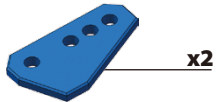
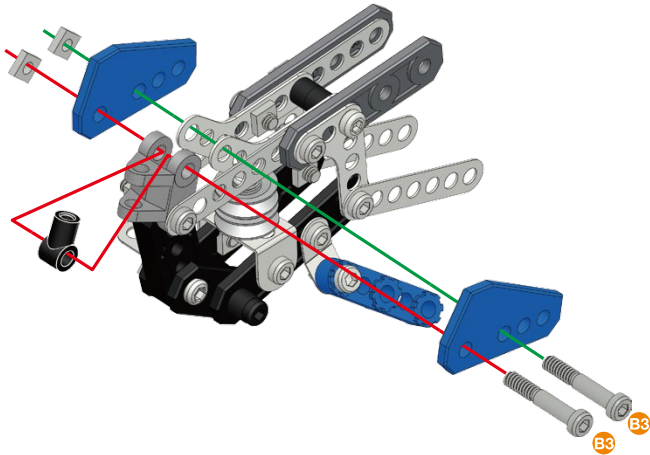
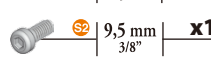
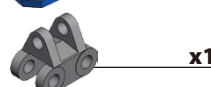
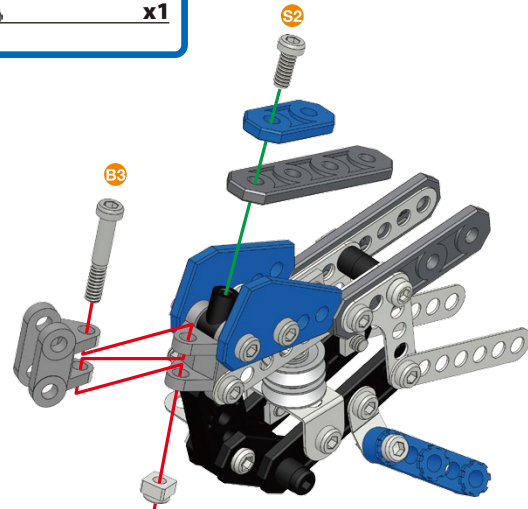
**7****1:1****8****1:1**

# 9







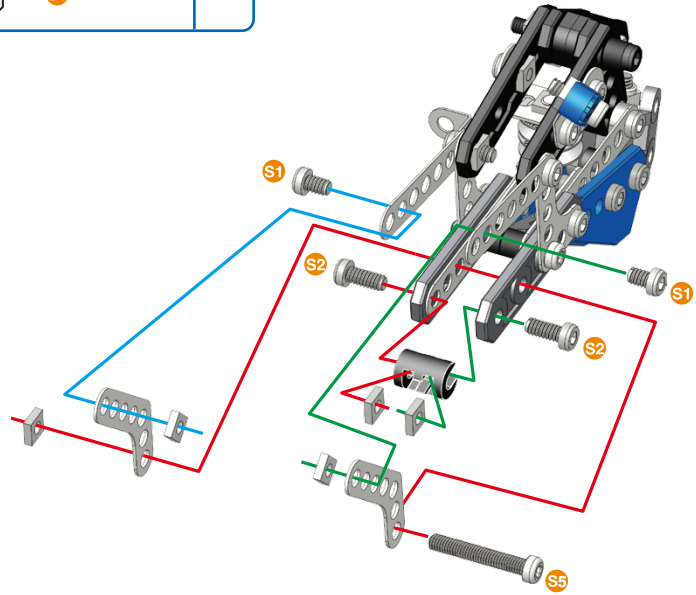

	<b>x2</b>
	<b>x1</b>
	<b>x2</b>
	<b>x2</b>
	<b>x1</b>
	<b>x5</b>

	S5
	S2
	S1





**1:1**



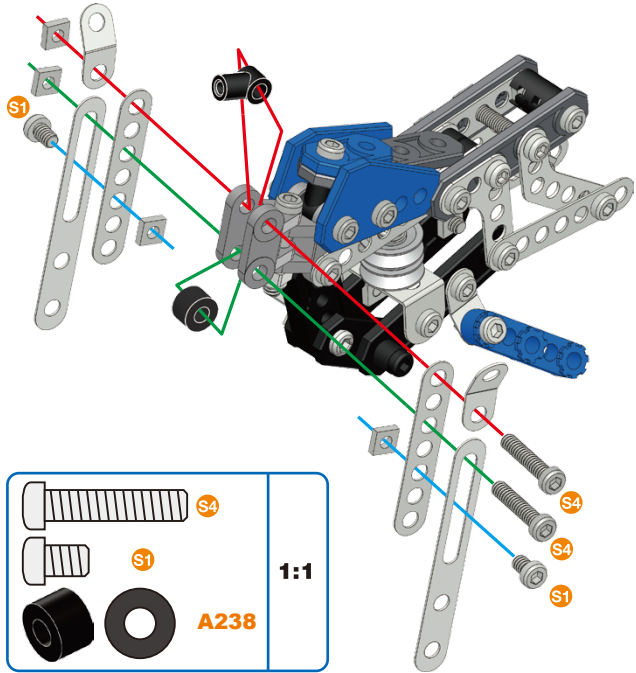



# 10





	19 mm 3/4"	<b>x2</b>		<b>x2</b>
	5,8 mm 15/64"	<b>x2</b>		<b>x2</b>
		<b>x4</b>		
		<b>x1</b>		<b>x1</b>
		<b>x2</b>		



	<b>S4</b>	<b>1:1</b>
	<b>S1</b>	
		<b>A238</b>

# 11

		<b>x1</b>
	12 mm 1/2"	<b>x2</b>
	9,5 mm 3/8"	<b>x1</b>
		<b>x1</b>
		<b>x2</b>

	<b>S3</b>	<b>1:1</b>
	<b>S2</b>	
		<b>A338</b>

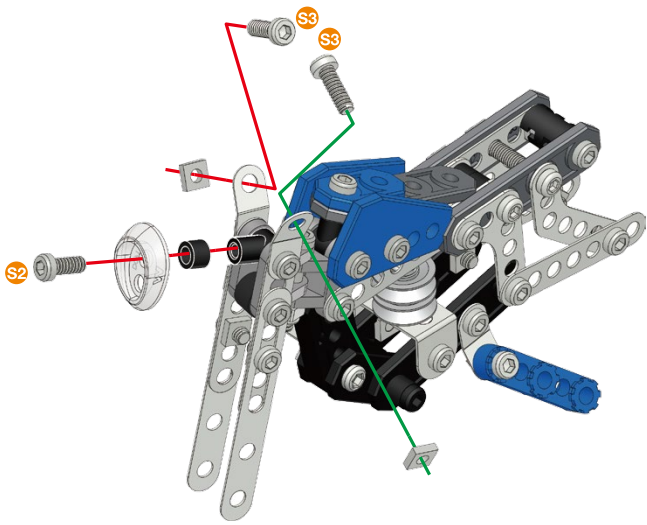

# 12

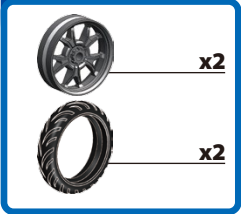

x2



# 13

11 + 12 +

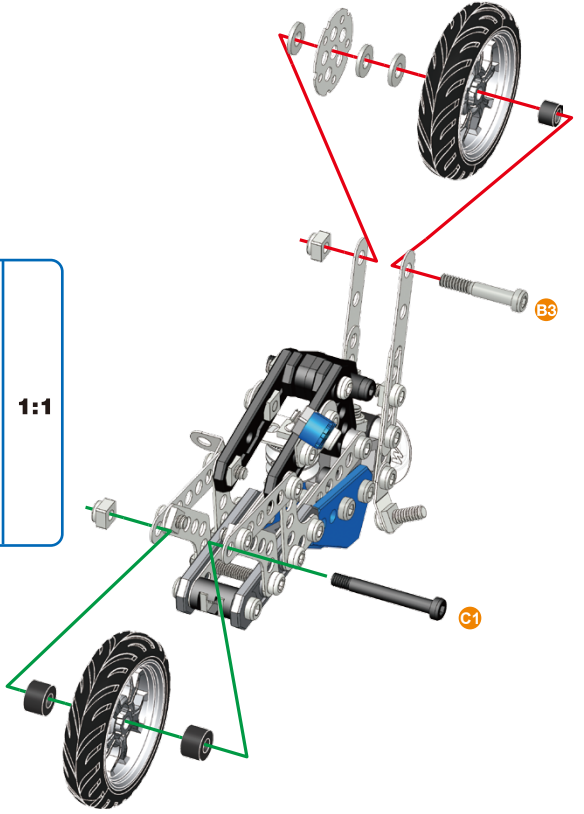
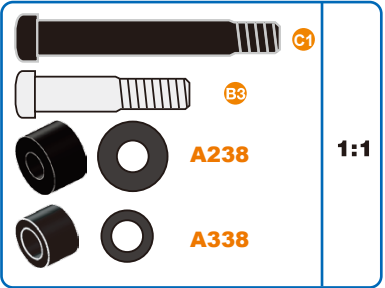
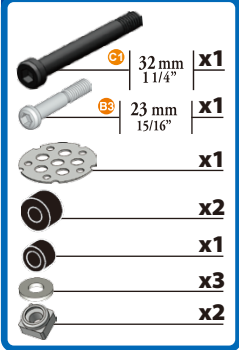

14



x1



32 mm  
1 1/4"

x1



9,5 mm  
3/8"

x1



x3



x1



x1



x1



S2

1:1



A338

