

MECCANO™

ENGINEERING & ROBOTICS

SF71H



18303



STEAM



 **10+**

Instructions
Notice de montage
Instrucciones de construcción
Bauanleitung
Bouwinstructie
Istruzioni
Instruções
Инструкции
Instrukcja
Pokyny
Útmutató
Instruțiuni





CONSTRUCTION TIPS / ASTUCES DE CONSTRUCTION

TIPS DE CONSTRUCCIÓ / TIPPS ZUM BAUEN / MONTAGETIPS / SUGGERIMENTI PER COSTRUIRE
DICAS DE MONTAGEM / РЕКОМЕНДАЦИИ ПО СБОРКЕ / WSKAZÓWKI DO BUDOWANIA
KONSTRUKČNÍ TIPY / TIPY NA MONTÁŽ / ÖSSZESZERELÉSI TIPPEK / SFATURI PENTRU CONSTRUIRE

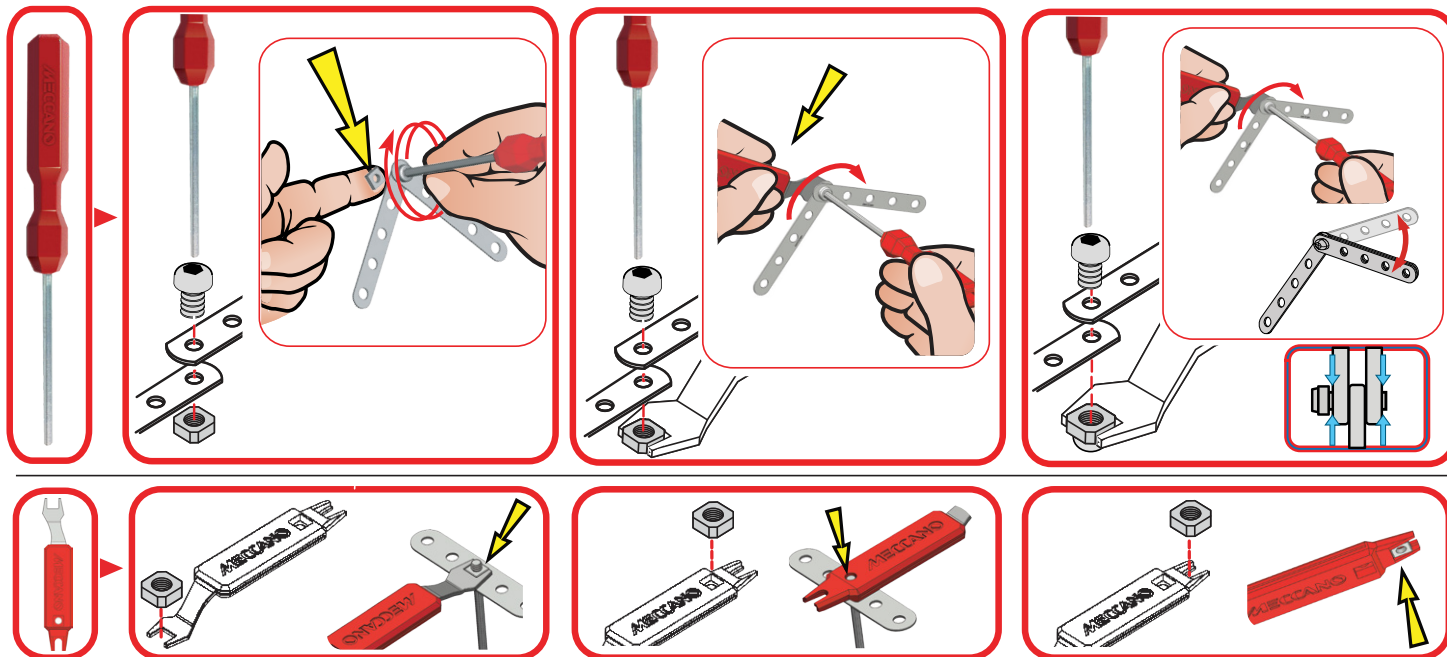

TABLE OF CONTENTS / SOMMAIRE





ÍNDICE / INHALTSVERZEICHNIS / INHOUD / INDICE / СОДЕРЖАНИЕ

SPIS TREŚCI / OBSAH / TARTALOMJEGYZÉK / CUPRINS

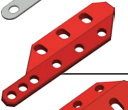

- EN.** Content: 362 parts, 2 real tools, 1 sticker sheet, 1 instruction sheet for 1 model.
FR. Contenu : 362 pièces, 2 vrais outils, 1 feuillet d'autocollants, 1 notice de montage pour 1 modèle.
ES. Contenido: 362 piezas, 2 herramientas reales, 1 hoja de calcomanías, 1 guía de instrucciones para 1 modelo.
DE. Inhalt: 362 Teile, 2 echte Werkzeuge, 1 Bogen mit Aufklebern, 1 Bauanleitung für 1 Modell.
NL. Inhoud: 362 onderdelen, 2 stuks gereedschap, 1 stickervel, 1 bouw instructie voor 1 model.
IT. Contenuto: 362 pezzi, 2 attrezzi, 1 foglio di adesivi, 1 guida per l'uso per 1 modello.
PT. Conteúdo: 362 peças, 2 ferramentas reais, 1 folha de adesivos, 1 folha de instruções para 1 modelo.
RU. В комплекте: 362 детали, 2 настоящих инструмента, 1 лист с наклейками, 1 инструкция по сборке 1 модели.
PL. Zawartość: 362 elementy, 2 prawdziwe narzędzia, 1 arkusz naklejek, 1 karta z instrukcjami dla 1 modelu.
CZ. Obsah: 362 dílů, 2 skutečné nástroje, 1 list se samolepkami, 1 list s pokyny pro 1 model.
SK. Obsah: 362 dielov, 2 skutočné nástroje, 1 hárok s nálepkami, 1 hárok s pokynmi pre 1 model.
HU. Tartalom: 362 db alkatrész, 2 db valódi szerszám, 1 db matricalap, 1 db 1 modelhez tartozó felhasználói útmutató.
RO. Conținut: 362 de piese, 2 instrumente reale, 1 foaie cu autocolante, 1 fișă cu instrucțiuni pentru 1 model.

3

	9.5 mm 3/8"	x2
		x2
		x1
		x1
		x1

		1:1
---	--	-----

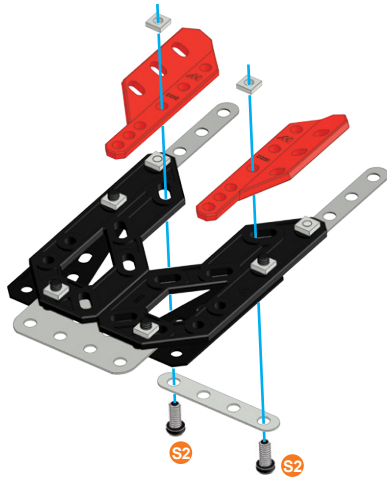



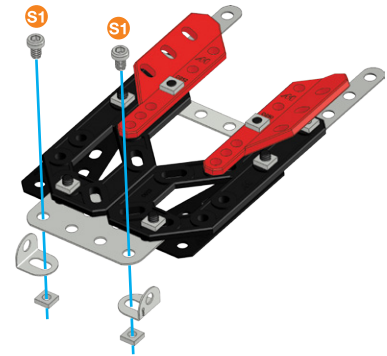

4

	5.8 mm 15/64"	x2
		x2
		x2

		1:1
--	--	-----





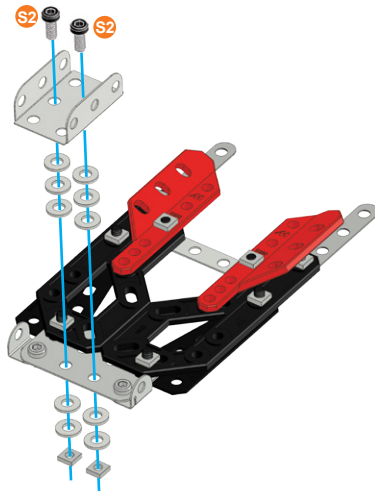

5

	9.5 mm 3/8"	x2
		x2
		x10
		x1

		1:1
---	--	-----





6

	5.8 mm 15/64"	x4
		x4
		x2
		x1

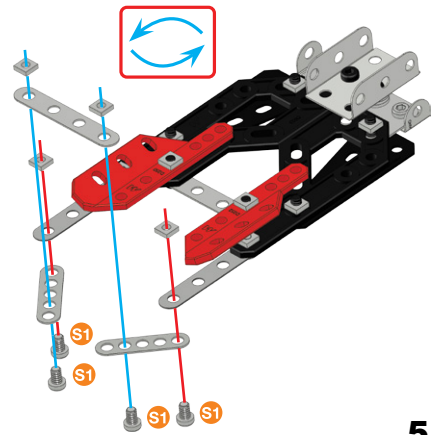
		1:1
--	--	-----



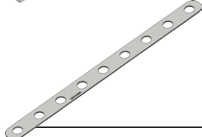

7

	S1	5.8 mm	x2
	S1	15/64"	x2
			x2

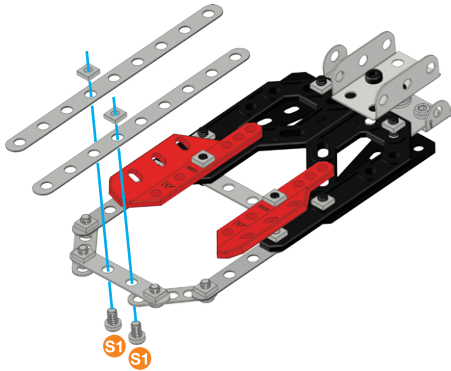
	S1	1:1
---	----	-----





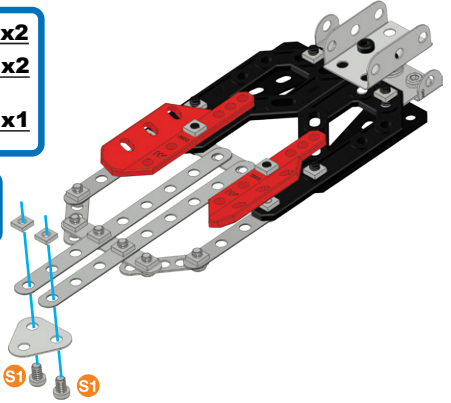

8

	S1	5.8 mm	x2
	S1	15/64"	x2
			x1

	S1	1:1
--	----	-----





9

	S2	9.5 mm	x1
	S2	3/8"	x1
			x1
			x1

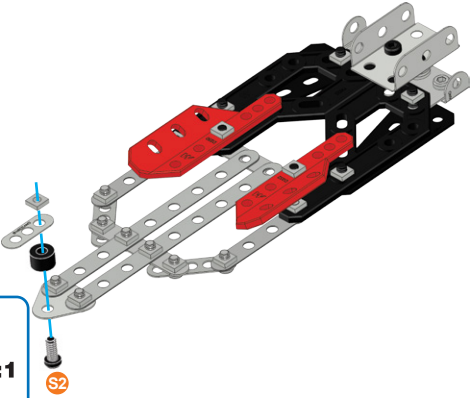
	S2	1:1	
	A238		







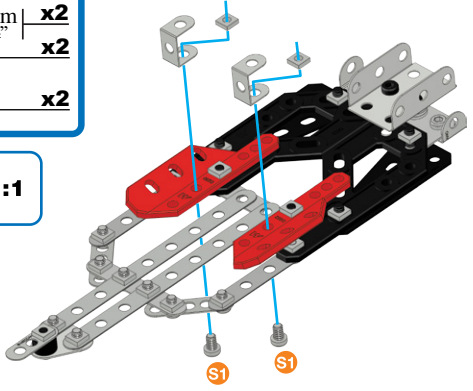

10

	S1	5.8 mm	x2
	S1	15/64"	x2
			x2

	S1	1:1
--	----	-----





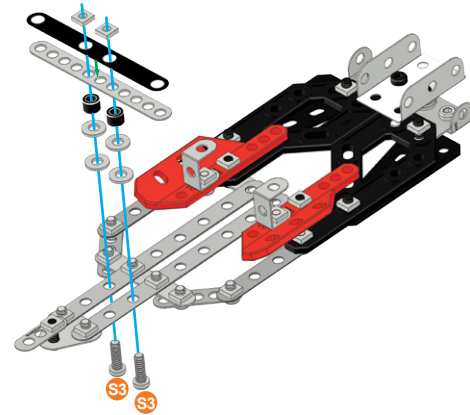

11

	12 mm 1/2"	x2
		x2
		x2
		x4
		x1
		x1

	S3	1:1
	A338	



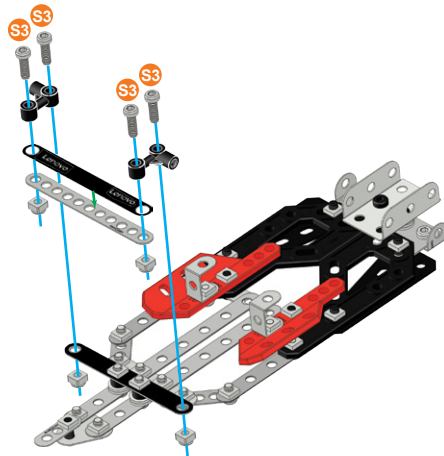

12

	12 mm 1/2"	x4
		x4
		x2
		x1
		x1



	S3	1:1
---	----	-----

13

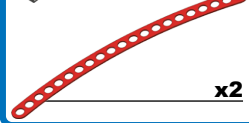

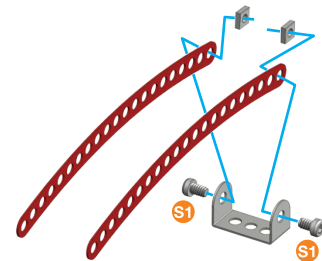
	5.8 mm 15/64"	x2
		x2
		x1
		x2



	S1	1:1
--	----	-----

14





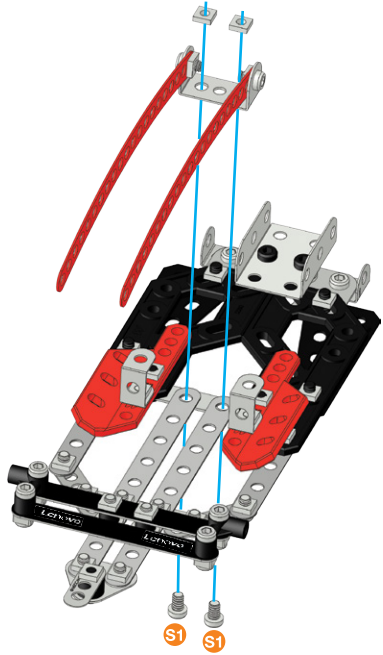

(12)+(13)+

	5.8 mm	x2
	15/64"	x2

	S1	1:1
---	----	-----





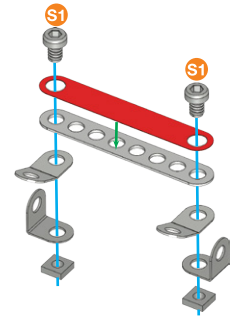

15

	5.8 mm	x2
	15/64"	x2
		x2
		x2
		x1
		x1

	S1	1:1
---	----	-----





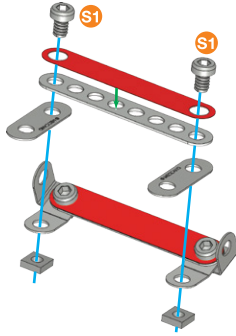

16

	5.8 mm	x2
	15/64"	x2
		x2
		x1
		x1

	S1	1:1
---	----	-----





17

	5.8 mm	x2
	15/64"	x2
		x1
		x1

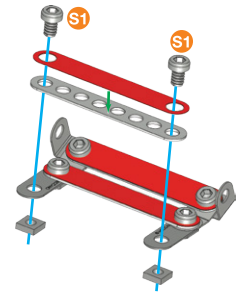
	S1	1:1
--	----	-----





18

	5.8 mm	x2
	15/64"	x2
		x2

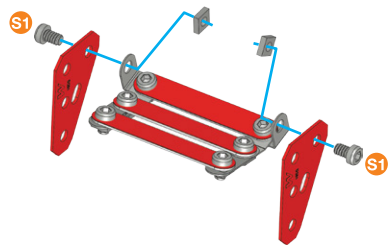
	S1	1:1
---	----	-----





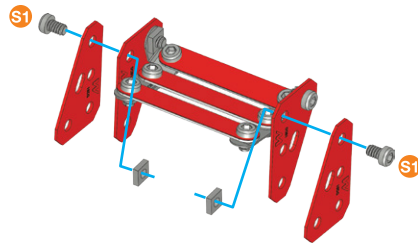

19

	5.8 mm	x2
	15/64"	x2
		x2

	S1	1:1
---	----	-----





20

	5.8 mm	x1
	15/64"	x1
		x1
		x1

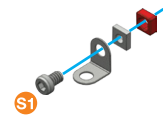
	D277	1:1
	S1	





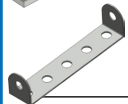

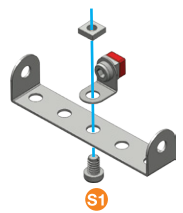
21

	5.8 mm	x1
	15/64"	x1
		x1



	S1	1:1
---	----	-----

22

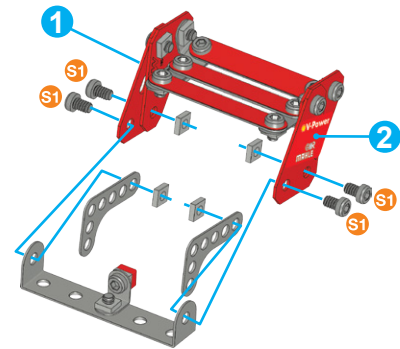

	5.8 mm	x4
	15/64"	x4
		x2
	V-Power	x1
	MAILE	

	S1	1:1
---	----	-----



23





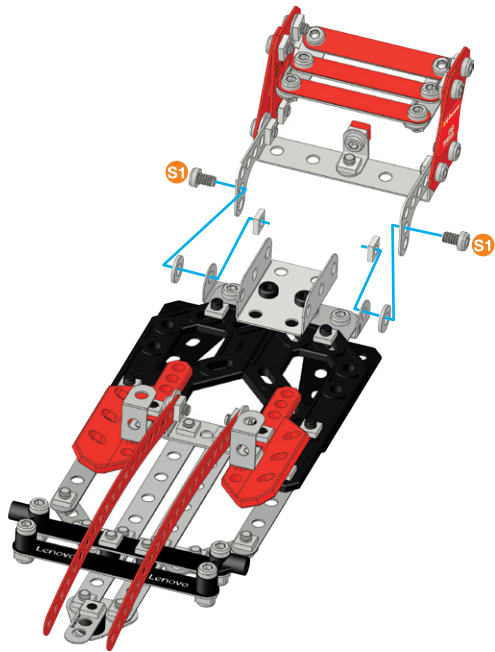

(14)+(22)+



	5,8 mm 15/64"	x2
		x2
		x2

	S1	1:1
---	----	-----





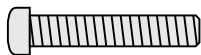

24

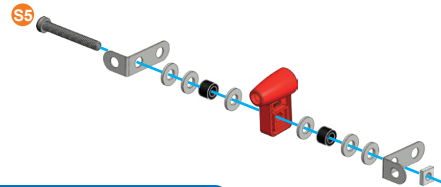
	25,4 mm 1"	x1
		x1
		x2
		x6
		x2
		x1

		A338	1:1
	S5		



25





	5,8 mm 15/64"	x4
		x4
		x2
		x1
		x1

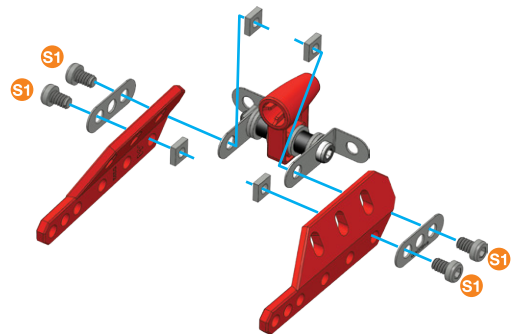

	S1	1:1
--	----	-----





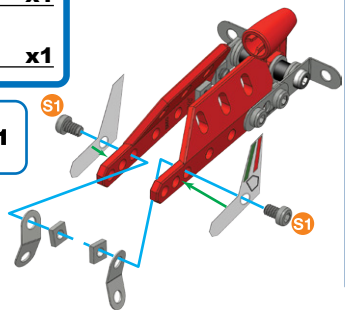

26

-  | 5,8 mm | **x2**
15/64" | **x2**
-  | **x2**
-  | **x2**
-  | **x1**
-  | **x1**



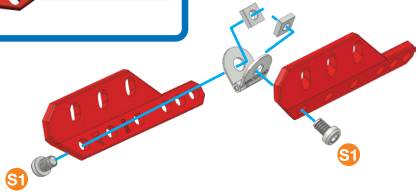

27

-  | 5,8 mm | **x2**
15/64" | **x2**
-  | **x1**
-  | **x1**
-  | **x1**



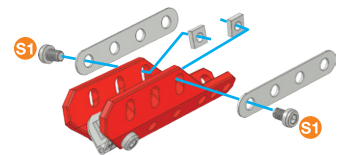

28

-  | 5,8 mm | **x2**
15/64" | **x2**
-  | **x2**
-  | **x2**



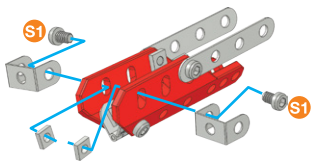

29

-  | 5,8 mm | **x2**
15/64" | **x2**
-  | **x2**
-  | **x2**





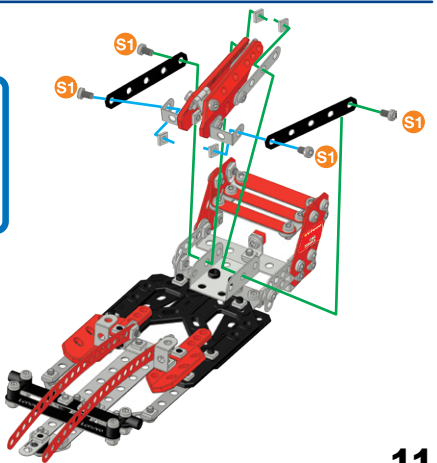

30

-  | 5,8 mm | **x4**
15/64" | **x4**
-  | **x4**
-  | **x2**







31

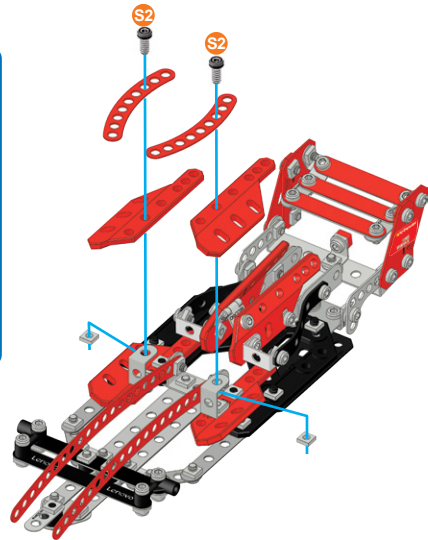

	9.5 mm 3/8"	x2
		x2
		x2
		x1
		x1

	1:1
---	-----





32 (26)+(31)+

	5.8 mm 15/64"	x2
	9.5 mm 3/8"	x2
		x4
		x2
		x2

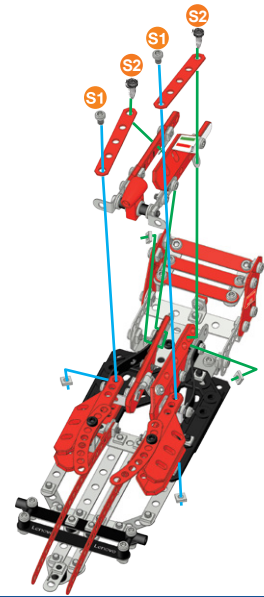
	S1	1:1
	S2	





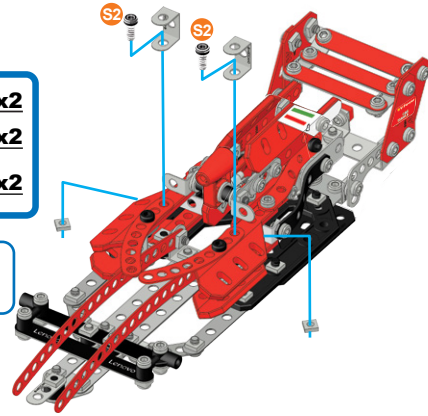

33

	9.5 mm 3/8"	x2
		x2
		x2

	1:1
---	-----



34

	5.8 mm 15/64"	x5
		x5
		x1
		x2
		x2

	S1	1:1
---	----	-----

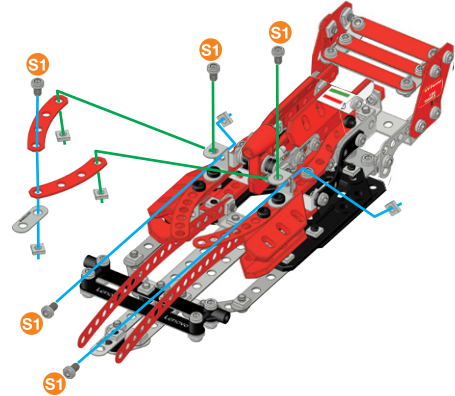

35

	B2	19 mm	x2
		3/4"	x2
			x4
			x2
			x1

	B2	1:1
	A238	

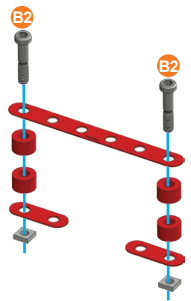

36

34+35+

	S1	5.8 mm	x4
		15/64"	x4
			x2
			x1

	S1	1:1
--	----	-----

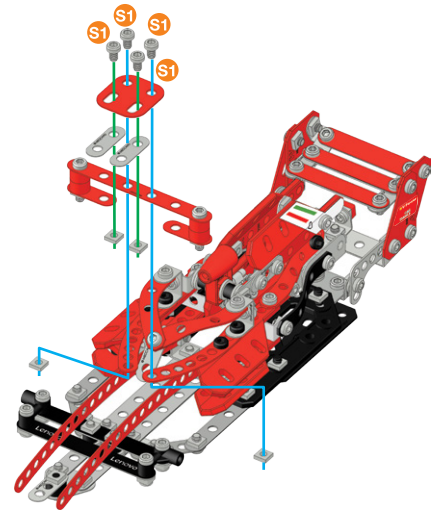





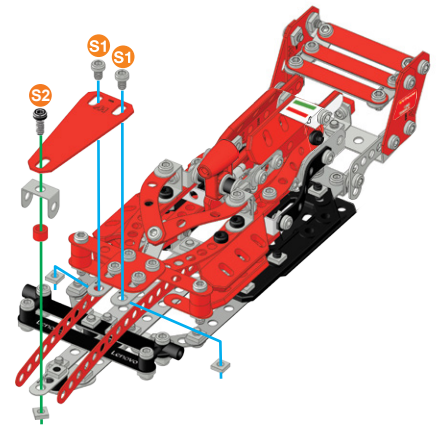

37

	S1	5.8 mm	x2
	S2	9.5 mm	x1
			x3
			x1
			x1
			x1

	S1	1:1
	S2	



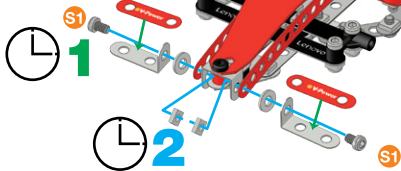
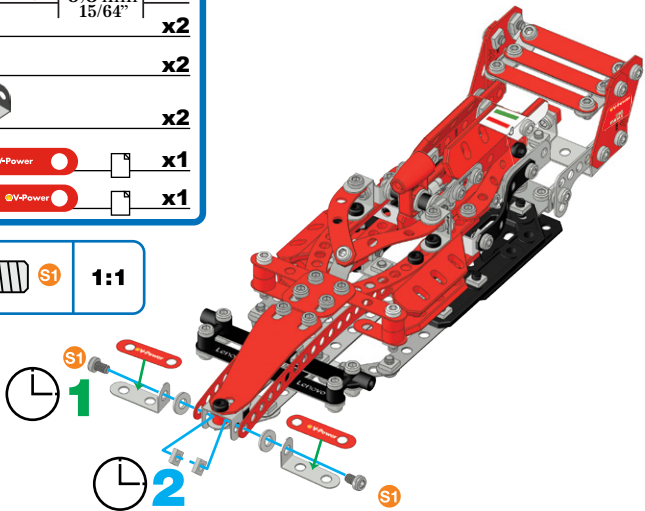

38

-  S1 | 5.8 mm | x2
15/64"
-  x2
-  x2
-  x2
-  x1
-  x1







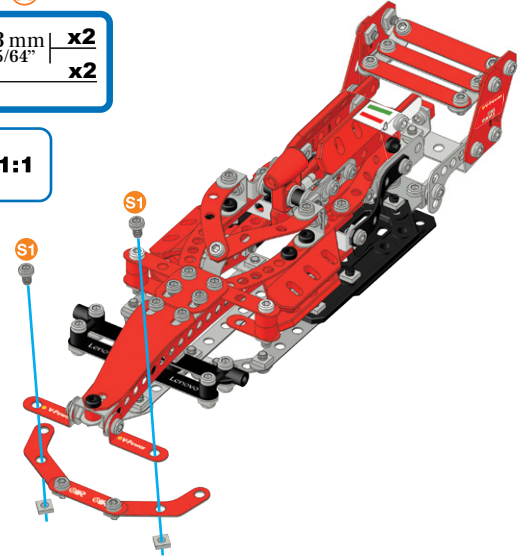

40

38+39+

-  S1 | 5.8 mm | x2
15/64"
-  x2







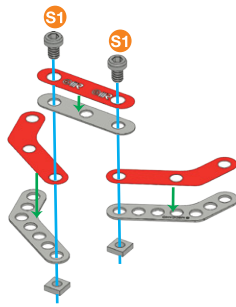

39

-  S1 | 5.8 mm | x2
15/64"
-  x2
-  x1
-  x2
-  x1
-  x1
-  x1







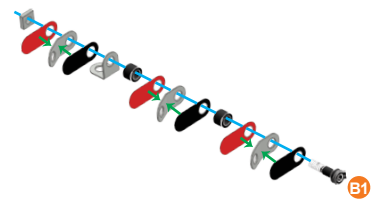
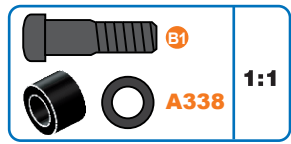



41

-  B1 | 14.7 mm | x1
37/64"
-  x1
-  x2
-  x1
-  x3
-  x3
-  x3



42

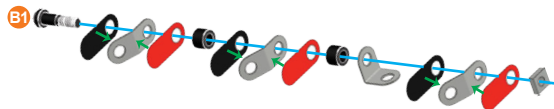

	B1	14.7 mm	x1
		37/64"	x1
			x2
			x1
			x3
			x3
			x3

	B1		1:1
	A338		



43



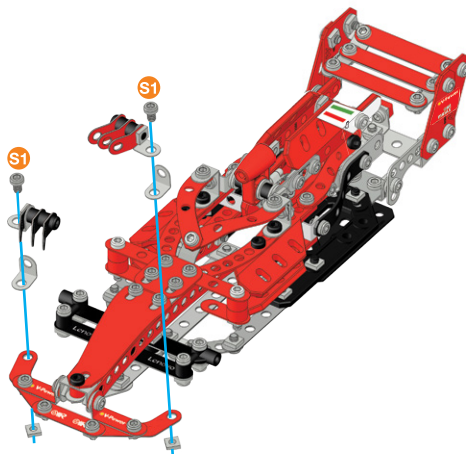

40+41+42+

	S1	5.8 mm	x2
		15/64"	x2
			x2
			x2

	S1	1:1
---	----	-----



44

	S1	5.8 mm	x2
		15/64"	x2
			x2
			x2
			x2
			x2

	S1	1:1
---	----	-----

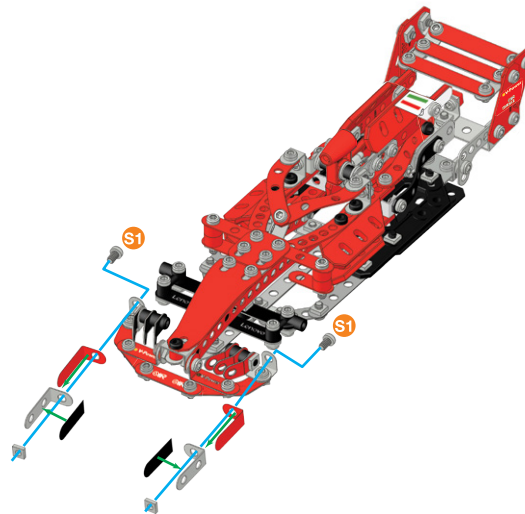

45

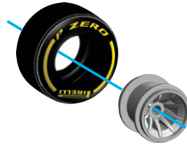

46

(44)+(45)+

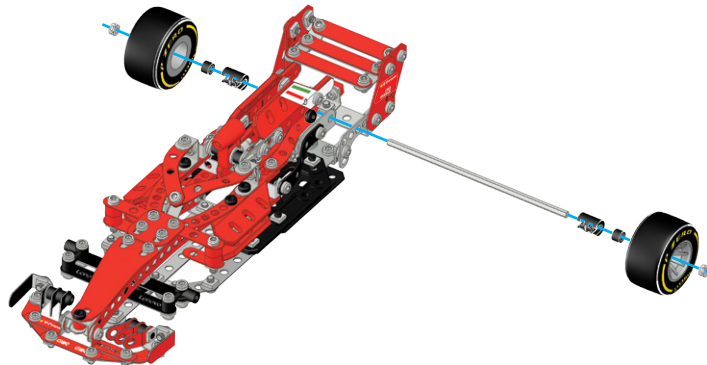
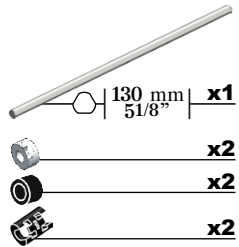

1:1

47

D560 x2

D561 x2



48 (46)+(47)+

B2 | 19 mm | **x2**
3/4"

x2

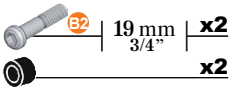

A338

1:1

B2

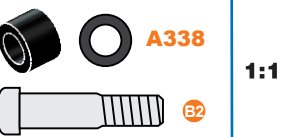
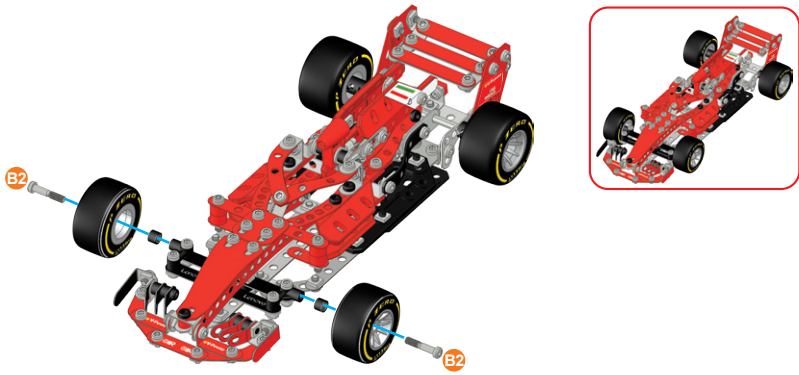
49



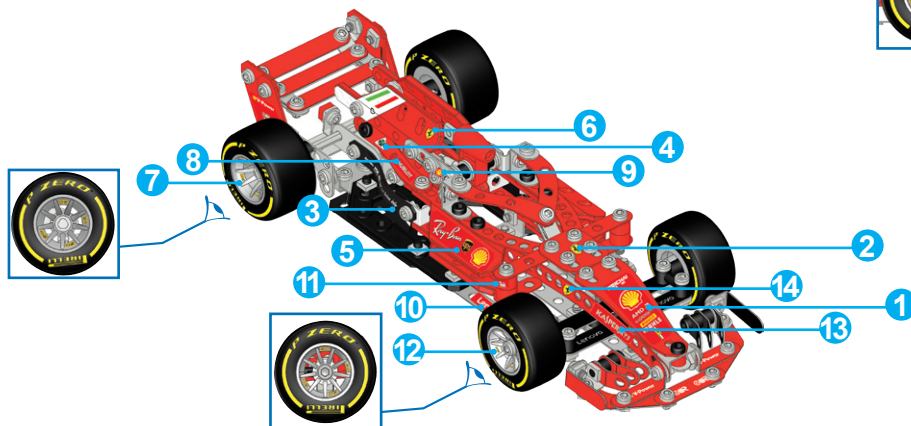
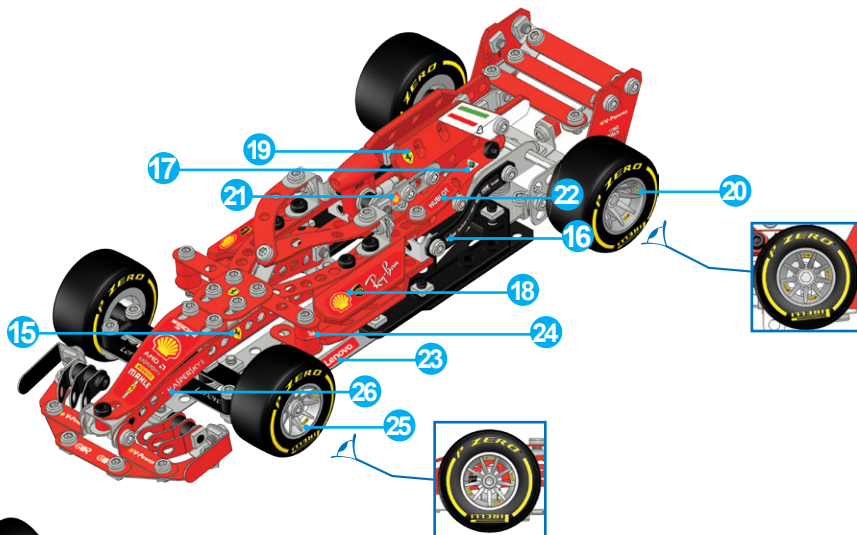
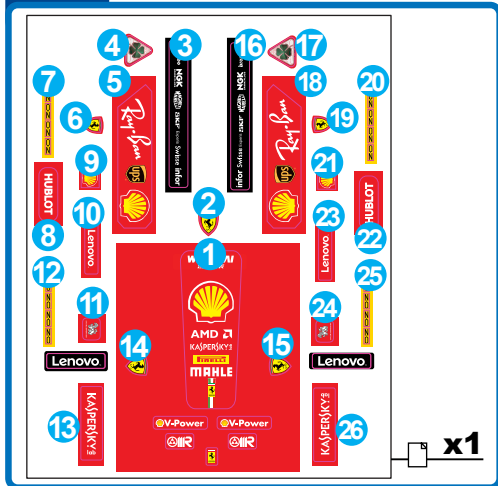

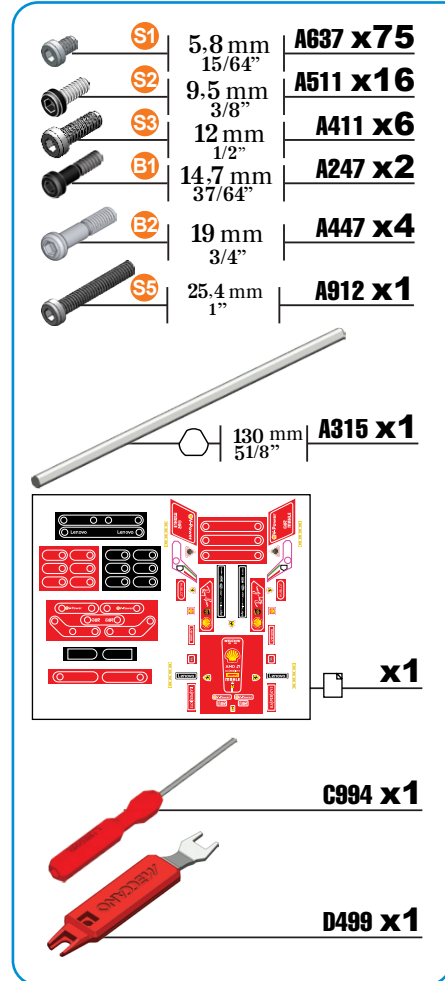
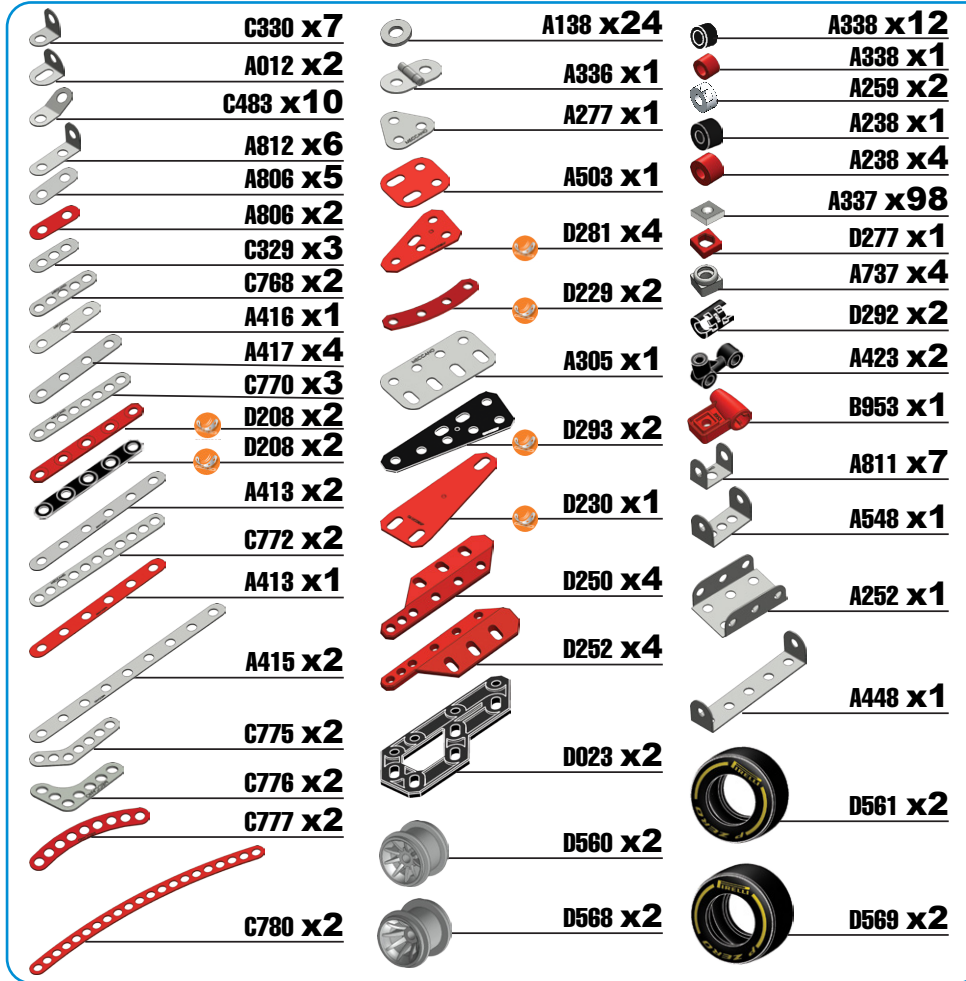
EN. Remove all packaging before use. Retain this information, addresses and phone numbers for future reference. Content may vary from pictures. Meccano reserves the right to discontinue the website www.meccano.com at any time.

FR. Retirer tout l'emballage avant utilisation. Conserver les informations, adresses et numéros de téléphone pour consultation ultérieure. Le contenu peut différer des images. Meccano se réserve le droit de supprimer le site Internet www.meccano.com à tout moment.

ES. Retire todo el embalaje antes de utilizar el producto. Conserve toda la información, las direcciones y los números de teléfono para futuras referencias. El contenido del paquete puede no corresponder con las imágenes.

DE. Entfernen Sie vor der Benutzung sämtliche Verpackungsmaterialien. Alle Informationen, Adressen und Telefonnummern bitte für mögliche Rückfragen aufbewahren. Der Packungsinhalt kann von den Bildern abweichen.

NL. Verwijder de verpakking voor gebruik. Bewaar deze informatie, adressen en telefoonnummers voor toekomstig gebruik. Inhoud kan afwijken van illustraties.

IT. Rimuovere l'imballo prima dell'uso. Conservare informazioni, indirizzi e numeri di telefono per riferimento futuro. Il prodotto potrebbe essere differente dalle immagini.

PT. Remova totalmente a embalagem antes de utilizar. Guarde todos os endereços, números de telefone e demais informações para consulta e referência. O conteúdo poderá ser diferente das ilustrações.

RU. Снимите все упаковочные материалы перед использованием. Запишите указанные на упаковке адреса и номера телефонов, чтобы у вас была возможность связаться с нами. Содержимое упаковки может отличаться от иллюстраций.

PL. Przed użyciem wyjąć zabawkę z opakowania. Zachować niniejsze informacje, adresy i numery telefonów na wypadek, gdyby były potrzebne w przyszłości. Zawartość opakowania może różnić się od zabawki przedstawionej na obrazkach.

CZ. Před použitím odstraňte veškeré balící materiály. Uložte si tyto informace, adresy a telefonní čísla pro budoucí použití. Obsah se může lišit od obrázků.

SK. Pred použitím odstráňte všetok obalový materiál. Tieto informácie, adresy a telefónne čísla si uchovajte na ďalšie použitie. Obsah sa môže líšiť od zobrazenia.

HU. Használat előtt távolítsa el minden csomagolóanyagot. A tudnivalókat, a címet és a telefonszámot őrizze meg későbbi használatra. A csomag tartalma eltérhet a képen látottaktól.

RO. Îndepărtați toate ambalajele înainte de utilizare. Păstrați aceste informații, adresele și numerele de telefon pentru consultare ulterioară. Conținutul poate fi diferit de imaginea din fotografi.

Ferrari

OFFICIAL LICENSED PRODUCT

Produced under license of Ferrari S.p.A. The name FERRARI, the PRANCING HORSE device, all associated logos and distinctive designs are property of Ferrari S.p.A. The body designs of the Ferrari cars are protected as Ferrari S.p.A. property under design, trademark and trade dress regulations.

Produit sous licence FERRARI S.p.A. La dénomination FERRARI, l'emblème du CHEVAL CABRÉ, ainsi que l'ensemble des logos et signes distinctifs associés sont la propriété intellectuelle de la société FERRARI S.p.A., de même que le design de la carrosserie des voitures FERRARI est protégé en vertu des réglementations applicables aux dessins et modèles, aux marques et aux habillages de marque.

TM & © 2018 MECCANO for packaging, instructions and models built with this set. © MECCANO is an exclusive trademark of MECCANO. Spin Master logo is a trademark of Spin Master Ltd. All rights reserved. / TM & © 2018 MECCANO pour l'emballage, les notices et modèles de ce coffret. © MECCANO est une marque de commerce exclusive de MECCANO. Le logo de Spin Master est une marque de commerce de Spin Master Ltd. Tous droits réservés.

SPIN MASTER LTD., 225 KING STREET WEST TORONTO, ON M5V 3M2 CANADA



UK – 0800 206 1191, serviceuk@spinmaster.com

IRELAND – 1800 992 249

FRANCE – 0800 909 150, servicefr@spinmaster.com

AUSTRALIA – 1800 316 982, customercare@spinmaster.com

DEUTSCHLAND – 0800 0101 0222, Kundenservice@spinmaster.com

SCHWEIZ – 0800 561 350 • **ÖSTERREICH** – 0800 297 267

NETERLAND – 0800 022 3683, klantenservice@spinmaster.com

BELGIË/BELGIQUE – 0800 77 688 • **LUXEMBOURG** – 800 2 8044

ITALIA – 800 788 532, servizio@spinmaster.com

MÉXICO – 55 4160 7947, servicio@spinmaster.com

POLSKA – 800080238, poland@spinmaster.com

ČESKÁ REPUBLIKA – 800550530, czechrepublic@spinmaster.com

SLOVENSKO – 0800232800, slovakia@spinmaster.com

MAGYARORSZÁG – 080 100 052, hungary@spinmaster.com

ROMÂNIA – 0800400015, romania@spinmaster.com

NORTH AMERICA • AMÉRIQUE DU NORD 1-800-622-8339, CUSTOMERCARE@SPINMASTER.COM

WWW.SPINMASTER.COM