

MASTER CONNECTION

0:49.2

0:32.0

0:36.4

0:75.0

0:58.3

0:63.7

6.5

0:64.1

0:92.3

0:48.6

0:78.1

0:51.3

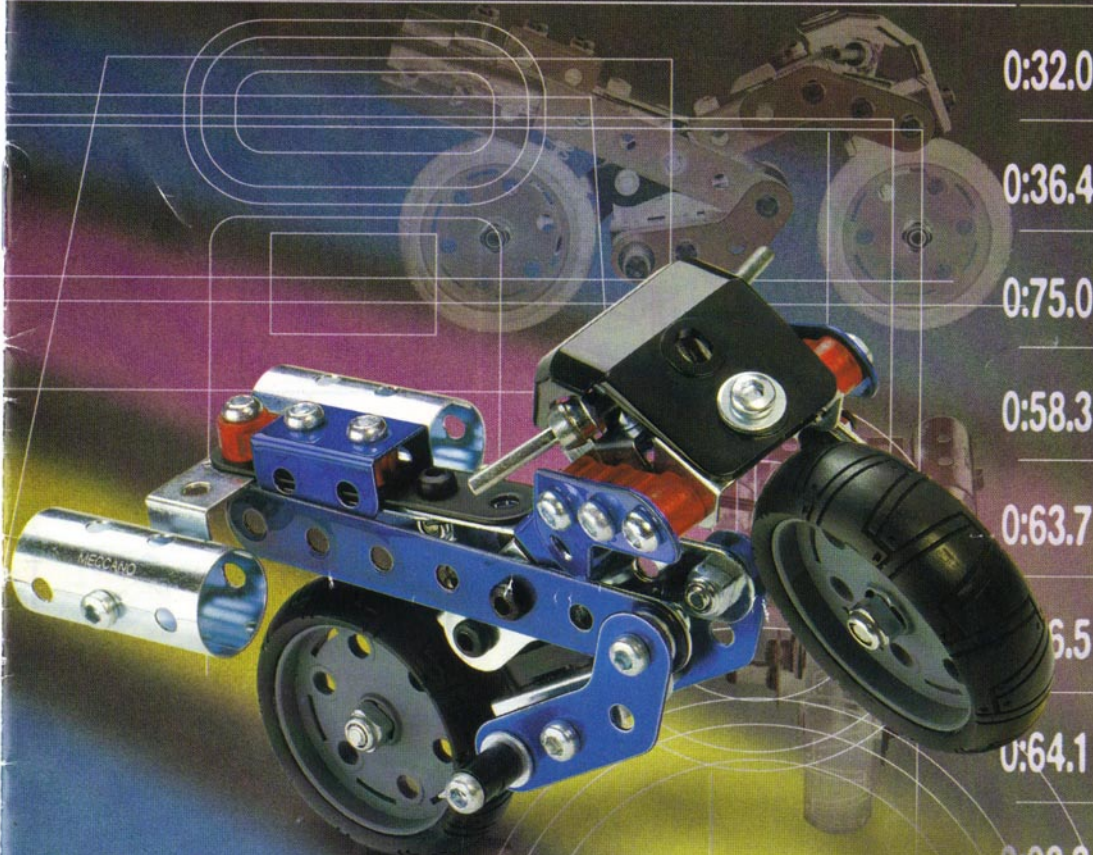

Instructions
Notice de montage
Bauanleitung
Istruzioni di montaggio
Instrucciones de montaje
Instruções de montagem
Monteringsanvisning
Kokoamisohje
Monterings instruktioner
Montageanleitung
Οδηγίες συναρμολόγησης
組立説明書

0010



8-14

0:49.2

0:32.0

0:36.4

0:75.0

0:58.3

0:63.7

0:86.5

0:64.1

0:92.3

0:48.6

0:78.1

0:51.3

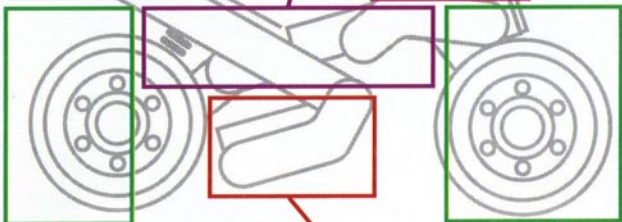

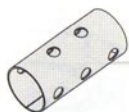

163 x2



51C x2



51C x2



133C x4



133C x4



12D x1



48E x3



48 x1



324A x1



34 x1



36C x1



3 x2



5 x1



5 x1



6 x1



235G x1



187B x2



142P x2



111D x1



111E x2



111 x1



111A x15



111C x5



147G x2



147D x1



37B x8



37A x30



37H x7



38D x2



38 x8



38A x4



38B x7



59B x5



120DF x1



120DM x3



120DR x1



260C x1



260C x3

0:49.2

0:32.0

0:36.4

0:75.0

0:58.3

0:63.7

0:86.5

0:64.1

0:92.3

0:48.6

0:78.1

0:51.3

0:49.2

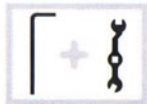

0:32.0



0:36.4

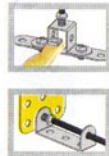
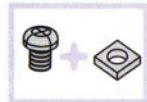

0:75.0



1

2

3

0:58.3

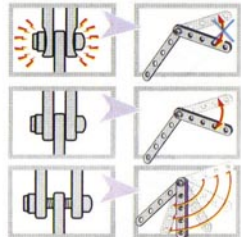
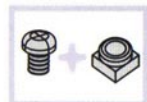

0:63.7



1

2

0:86.5

0:64.1

25,4 mm
1"



0:92.3

23 mm
29/32"



0:48.6

19 mm
3/4"



0:78.1

14,7 mm
9/16"



0:51.3

12 mm
1/2"



9,5 mm
3/8"



5,8 mm
15/64"



Scale
Échelle
Maßstab
Scala

Escala
Schaal
Escala
Skala

Mittakaava
Målestok
Κλίμακα
スケール

1:1



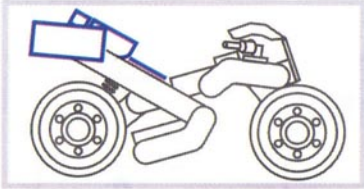

0:49.2

1

0:32.0

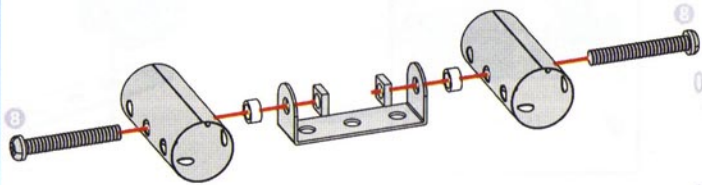
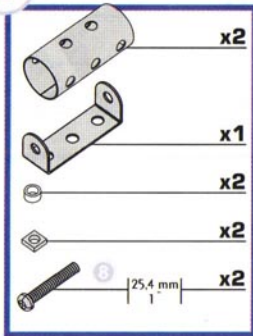

0:36.4

0:75.0

0:58.3

0:63.7

2

0:86.5

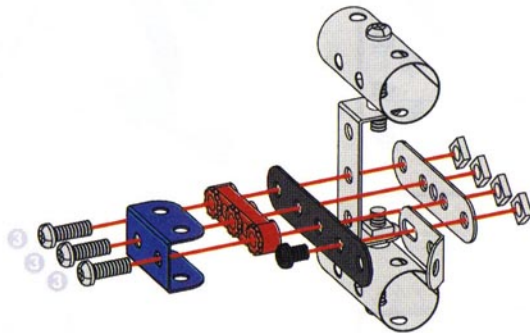
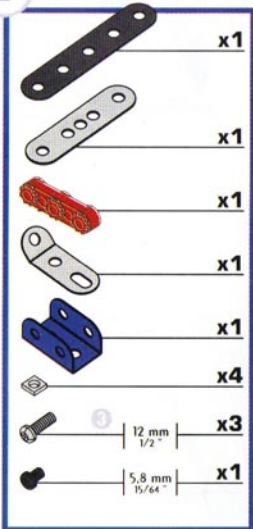

0:64.1

0:92.3

0:48.6

0:78.1

0:51.3

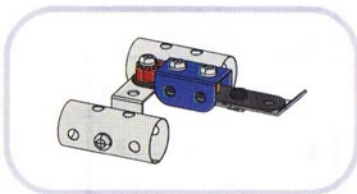

0:49.2

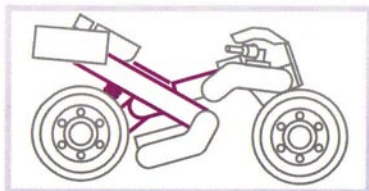

0:32.0

1

0:36.4

0:75.0

0:58.3

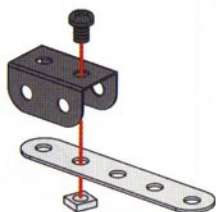
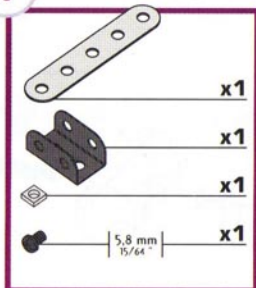

0:63.7

2

0:86.5

0:64.1

0:92.3

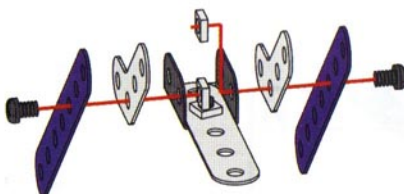
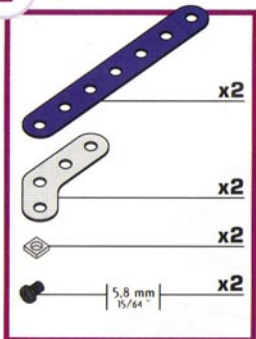

0:48.6





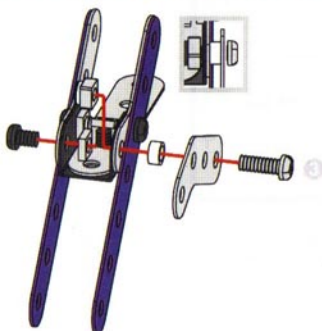
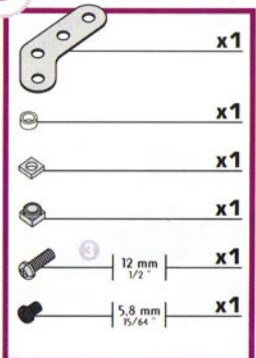

3

0:78.1

0:51.3



4

-  x1
-  x1
-  x1
-  x2
-  x1
-  $\frac{14,7 \text{ mm}}{9/16''}$ x1

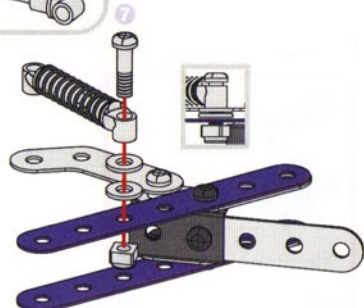
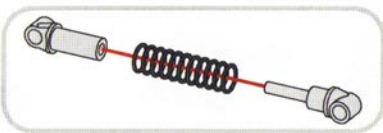

0:49.2

0:32.0

0:36.4



0:75.0

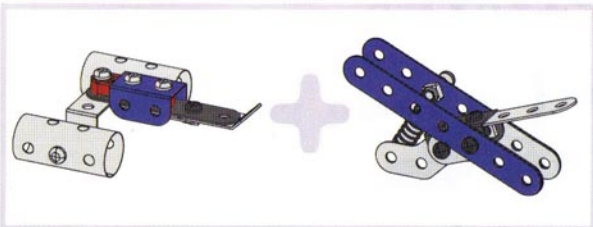

0:58.3

0:63.7



-  x1
-  x1
-  $\frac{5,8 \text{ mm}}{15/64''}$ x1

0:86.5

0:64.1

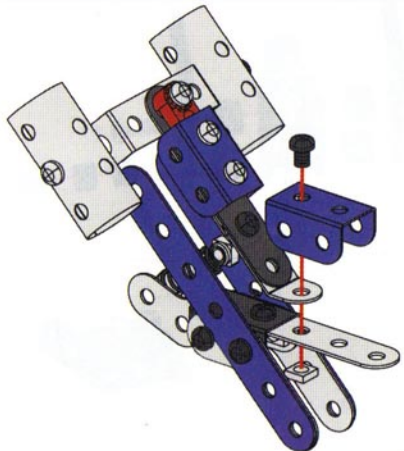

0:92.3

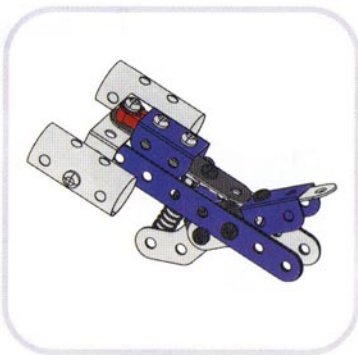

0:48.6

0:78.1

0:51.3

7

0:49.2

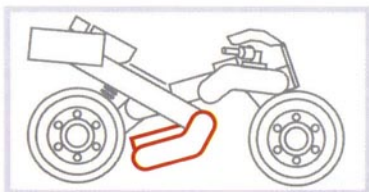

0:32.0

1

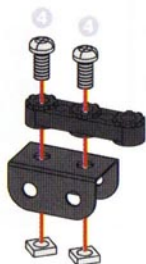
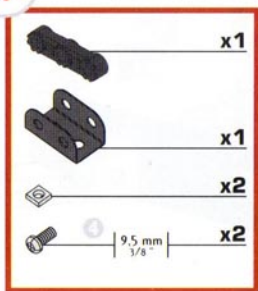

0:36.4

0:75.0

0:58.3

0:63.7

2

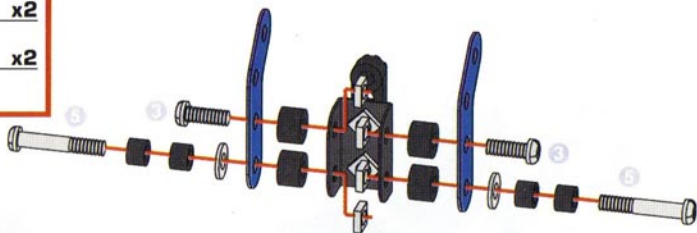
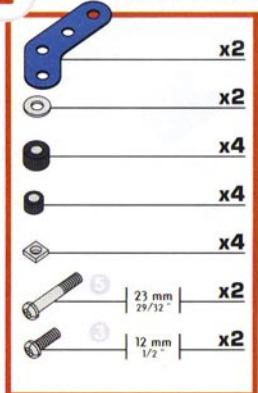

0:86.5

0:64.1

0:92.3

0:48.6

0:78.1

0:51.3



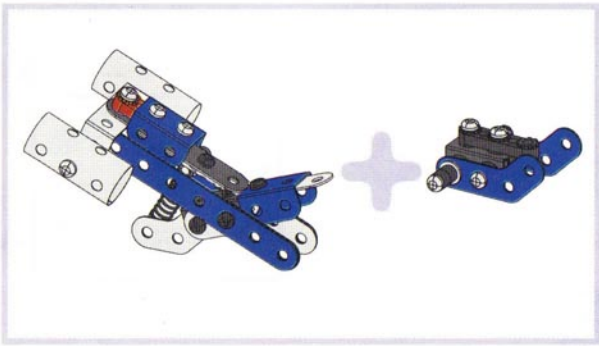

	x2
	x2
	x2
	x2
12 mm 1/2"	

0:49.2

0:32.0

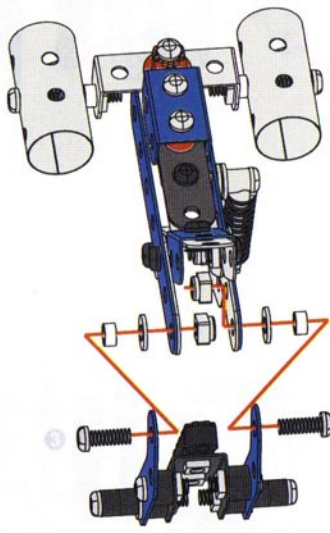

0:36.4

0:75.0

0:58.3

0:63.7

0:86.5

0:64.1

0:92.3

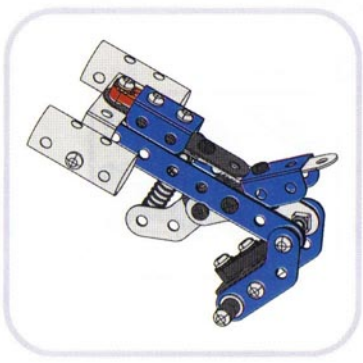

0:48.6

0:78.1

0:51.3

0:49.2

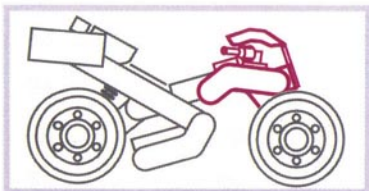

0:32.0

1

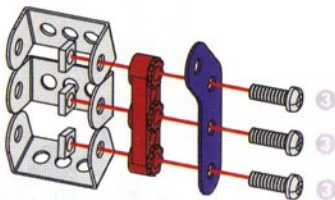
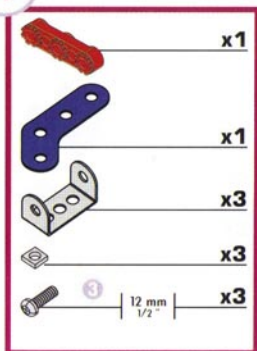

0:63.7

2

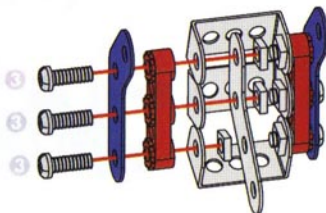
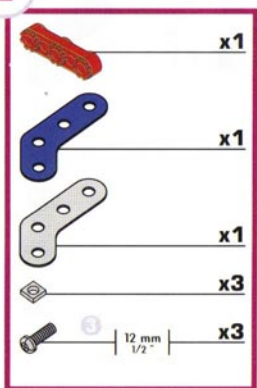

0:48.6

3

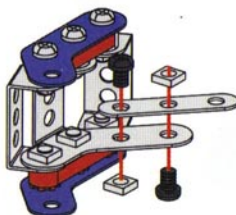
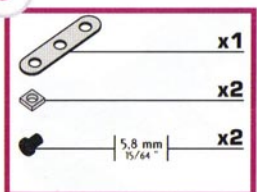

0:78.1

0:51.3

4

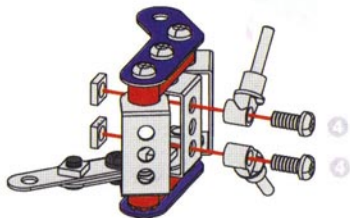
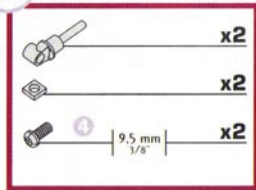

0:49.2

0:32.0

0:36.4

0:75.0

0:58.3

0:63.7

0:86.5

0:64.1

0:92.3

0:48.6

0:78.1

0:51.3

5

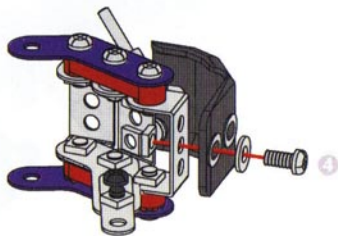
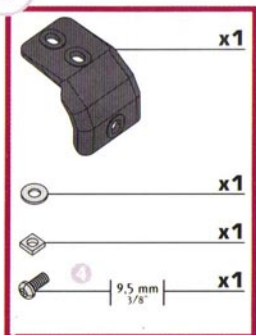

0:49.2

0:32.0

0:36.4

0:75.0

0:58.3

0:63.7

0:86.5

0:64.1



0:92.3

0:48.6

0:78.1

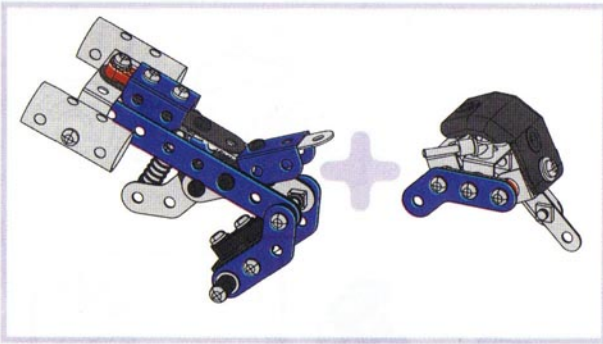
0:51.3



-  x1
-  x1
-  12 mm 1/2" x1

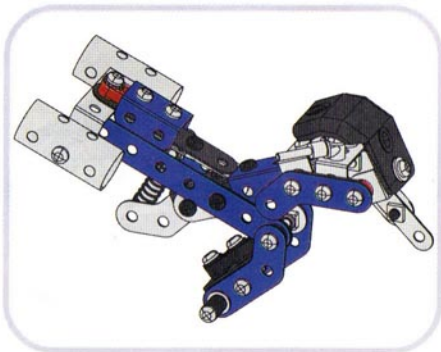
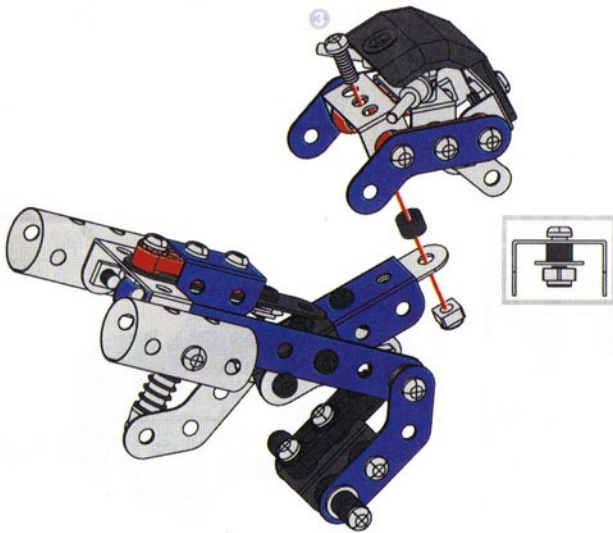

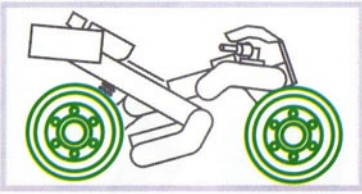

0:49.2

1

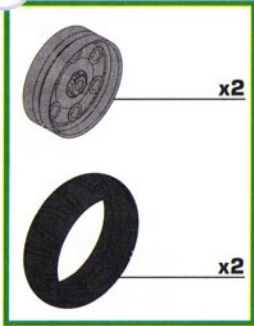

0:32.0

0:36.4

0:75.0

0:58.3



0:63.7

0:86.5

0:64.1



0:92.3

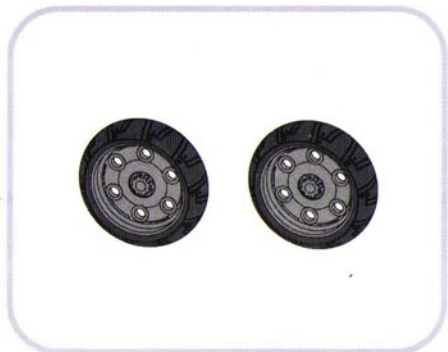







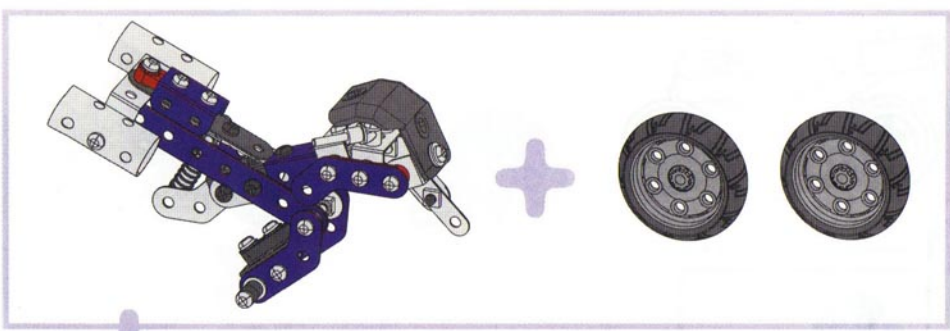

0:48.6

0:78.1

0:51.3

0:49.2
 0:32.0
 0:36.4
 0:75.0
 0:58.3
 0:63.7
 0:86.5
 0:64.1
 0:92.3
 0:48.6
 0:78.1
 0:51.3



-  **x2**
-  **x1**
-  **x2**
-  **x2**
-  **x2**
-  **x1**
-  **x1**

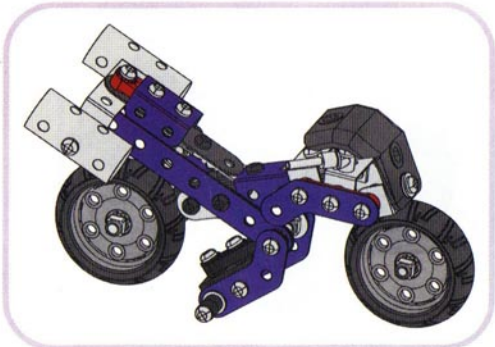
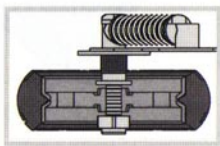
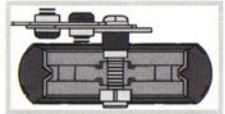
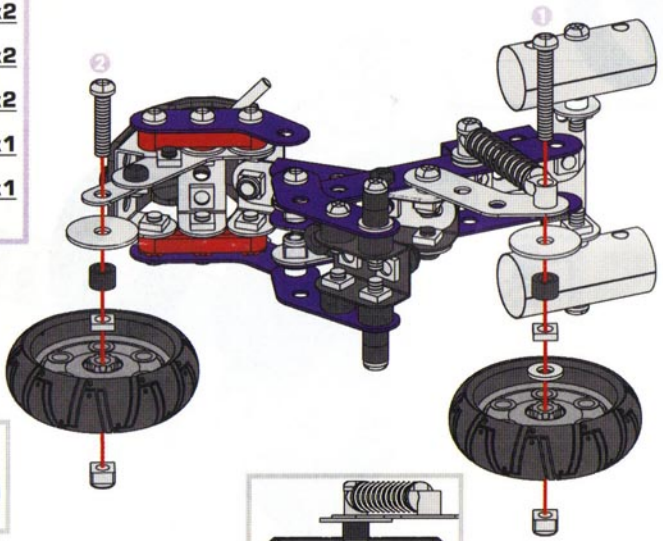

(GB) Many of the models and component parts are unique and original designs which are the property of MECCANO S.A. They are protected by national legislation as industrial designs, trademarks and/or copyrights throughout many countries. For detailed information, please contact MECCANO S.A. MECCANO S.A. accepts no responsibility for (I) failure to follow instructions, (II) use for any purpose other than as specified in the instructions (III) any alteration of any parts or components. MECCANO S.A. respects children's safety: all models are tested by children.

(F) De nombreux modèles et pièces sont des créations originales, propriétés de MECCANO S.A. et sont protégés par les législations nationales sur les dessins et modèles, marques et/ou droits d'auteurs. Pour toute information, merci de contacter : MECCANO S.A. La responsabilité de MECCANO S.A. ne saurait être engagée en cas d'accident survenu à la suite (I) du non respect des instructions de montage (II) d'une utilisation des pièces autre que celle proposée dans la notice (III) d'une altération ou de la modification des pièces. La société MECCANO respecte la sécurité des enfants : ses modèles sont testés par des enfants.

(D) Zahlreiche Modelle und Teile sind Erfindungen und Eigentum der Firma MECCANO S.A. Sie sind durch Inland-Gesetze über Zeichnungen und Modelle sowie Warenzeichen und/oder Urheberrechte geschützt. Für zusätzliche Auskünfte wenden Sie sich bitte an : MECCANO S.A. Die Firma Meccano S.A. haftet nicht für Unfälle, die aus der (I) Nichteinhaltung der Bauanleitung, der (II) Verwendung anderer als in der Bauanleitung angegebenen Teile oder der (III) Änderung oder Modifikation der Teile resultieren. Alle Modelle der Firma Meccano S.A. wurden von Kindern getestet und entsprechen den Sicherheitsnormen.

(I) Numerosi modelli e pezzi sono creazioni originali della MECCANO S.A. e sono protetti dalle legislazioni nazionali sui disegni e modelli, marche e/o diritti d'autore. Per qualsiasi informazione, vogliate prendere contatto con: MECCANO S.A. Meccano s.a. declina ogni responsabilità in caso d'incidenti sopravvenuti in seguito (I) a: non rispetto delle istruzioni di montaggio, (II), utilizzo dei pezzi per funzioni diverse da quelle previste nel manuale (III), alterazione e/o modifica dei pezzi. La società MECCANO rispetta la sicurezza dei bambini: i suoi modelli vengono testati dai bambini stessi.

(E) Numerosos modelos y piezas son creaciones originales, propiedades de MECCANO S.A. y están protegidos por las legislaciones nacionales en lo que concierne a los dibujos y modelos, marcas y/o derechos de autor. Para cualquier información, sírvase ponerse en contacto con: MECCANO S.A. MECCANO S.A. carece de responsabilidad en caso de accidente debido a: (I) el incumplimiento de las instrucciones de montaje; (II) una utilización de las piezas diferente a la que se indica en las instrucciones; (III) una alteración o modificación de las piezas. La sociedad MECCANO respeta la seguridad de los niños: sus modelos están probados por niños.

(P) Vários modelos e peças são criações originais, propriedades da MECCANO S.A. e são protegidos pelas legislações nacionais relativas aos desenhos e modelos, as marcas e/ou aos direitos de autor. Para qualquer informação, é favor contactar : MECCANO S.A. A Sociedade MECCANO S.A. não poderá ser responsabilizada pelos acidentes provocados: (I) pela falta de cumprimento das instruções de montagem; (II) pelo uso indevido das peças ou (III) pela modificação ou alteração das peças. A Sociedade MECCANO respeita a segurança das crianças: os seus modelos foram testados por crianças.

(S) Många modeller och delar bildar en unik och originell formgivning vilken är MECCANO S.A. egendom. Dessa modeller och delar är skyddade genom lagstiftning såsom industriell formgivning, varumärke och/eller upphovsmanrätt i ett flertal länder. För mer detaljerad information, var vänlig och kontakta MECCANO S.A. MECCANO S.A. fräntar sig allt ansvar i händelse av olycka till följd av (I) att monteringsinstruktionerna inte har respekterats (II) en annan användning av delarna än den som står i anvisningen (III) en förvanskning eller förändring av delarna. Företaget MECCANO respekterar barnsäkerheten: modellerna har testats av barn.

(FIN) Vore mange modeller og dele er originale fremstillinger og ejes af MECCANO S.A. Tegninger, modeller, fabrikmærker og ophavsret er lovbeskyttede i hvert land. Yderligere oplysninger kan fås hos: MECCANO S.A. MECCANO S.A. ejer vastaa ei kata seuraavista systistä sattuneita onnettomuuksia: (1) ohjeiden vastainen kokoaminen, (2) muiden kuin ohjeessa ehdotettujen osien käyttö, (3) osien vaihto tai muuntelu. MECCANO-yhtiö huolehtii lasten turvallisuudesta: lapset ovat testanneet mallimme.



(DK) Usetat mallit ja osat ovat MECCANO S.A.:n omaisuutta olevaa suunnittelua. Usetat mallit ja niiden osat ovat lailla suojattuja teollista tuotollua, tavaramerkkejä ja/tai kopiointioikeuksia useissa maissa. Tuotemerkki MECCANO. Såfremt der sker uheld forårsaget af (I) at monteringsinstruktionerne ikke er blevet overholdt, (II) at delene er blevet brugt til andre formål, end dem der er beskrevet i betjeningsvejledningen, (III) eller at delene er blevet beskadiget eller ændret, frastiger MECCANO S.A. sig ethvert ansvar for dette. MECCANO overholder sikkerhedsreglerne for børn: alle modeller testes af børn.

(NL) Veel modellen en onderdelen zijn originele ontwerpen en eigendom van MECCANO S.A. en worden beschermd door de nationale wetgevingen op tekeningen en modellen, merken en/of auteursrechten. Voor informatie gelieve contact op te nemen met MECCANO S.A. De verantwoordelijkheid van MECCANO S.A. is uitgesloten in geval van ongevalen voortvloeiend uit het niet naleven van de montage-instructies (I), uit het gebruik van andere onderdelen dan die zoals vermeld in de handleiding (II) of uit het veranderen of modificeren van de onderdelen (III). De firma MECCANO neemt de veiligheid van de kinderen in acht : de modellen zijn door kinderen getest.

(GR) Πολλά μοντέλα και ανταλλακτικά είναι αυθεντικά, ιδιοκτησία της MECCANO S.A. και προστατεύονται από τις εθνικές νομοθεσίες για τα μοντέλα ή μάρκες ή τα διπλώματα ευρεσιτεχνίας. Για κάθε πληροφορία παρακαλώ απευθυνθείτε στη MECCANO S.A. Η ευθύνη της MECCANO S.A. δεν δεσμεύεται σε περίπτωση ατυχήματος που έγινε συνέπεια (I) μη σεβασμού των οδηγιών συναρμολόγησης (II) χρήσης των τεμαχίων διαφορετικά από αυτήν που προτείνεται στις οδηγίες (III) καταστροφή ή αλλαγή των τεμαχίων. Η εταιρεία MECCANO σέβεται την ασφάλεια των παιδιών: τα μοντέλα της δοκιμάζονται από παιδιά.

(JPN) モデルならびに 部品は、その多くが MECCANO 社 所有のオリジナル・デザインで、意匠・商標および/または著作権に関する国内法によって保護されています。詳細については、当社 (MECCANO S.A.) メカノ社は (I) 組立の注意事項を守らなかった場合、(II) 使用説明書に記載されたもの以外の部品を使用した場合、(III) 部品を改変・改造した場合などに起きた事故については責任を負うことはできません。メカノ社の全モデルは事前に子供たちによりテストを行い、その安全性を確認されております。

(USA) Many models and component parts incorporate original designs which are the property of MECCANO S.A. and are protected as design and/or utility patent and/or copyrights. For detailed information, please contact MECCANO S.A. Instruction booklets are solely to assist in construction of sets. MECCANO S.A. shall have no responsibility for: 1. Failure to follow instructions. 2. Use of parts for any purpose other than as specified in the instruction booklets. 3. Any alteration of any parts or components. Meccano S.A. values children's safety: all models are tested accordingly. All models are tested by and developed in conjunction with children.

0:49.2

0:32.0

0:36.4

0:75.0

0:58.3

0:63.7

0:86.5

0:64.1

0:92.3

0:48.6

0:78.1

0:51.3

Made in France by / Fabriqué en France par / Hecho en Francia :

Meccano S.A. 363, avenue de Saint-Exupéry - F - 62100 CALAIS

0:49.2

0:32.0

0:36.4

0:75.0

0:58.3

0:63.7

0:86.5

0:64.1

0:92.3

0:48.6

0:78.1

0:51.3

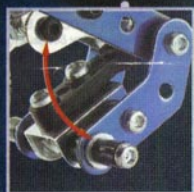

MECCANO

363, avenue de Saint-Exupéry
F - 62100 CALAIS



MECCANO® and ERECTOR® are exclusive trademarks of MECCANO S.A.

© March, 1998 MECCANO S.A.