

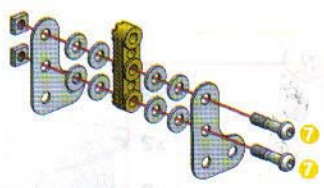

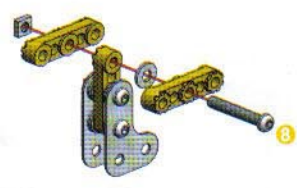

1

-  x2
-  x1
-  x8
-  x2
-  x2
-  x2







-  x2
-  x1
-  x1
-  x1
-  x1

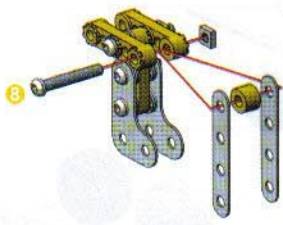







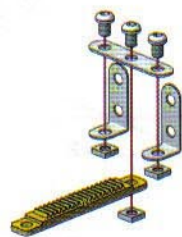

-  x2
-  x1
-  x1
-  x1
-  x1







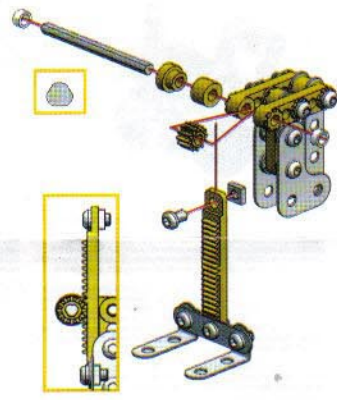

-  x1
-  x1
-  x2
-  x3
-  x3



-  x1
-  x1
-  x1
-  x1
-  x2
-  x1
-  x1
-  x1



-  x1
-  x1
-  x1
-  x1
-  x3
-  x3

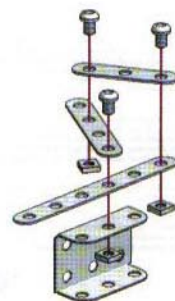

7

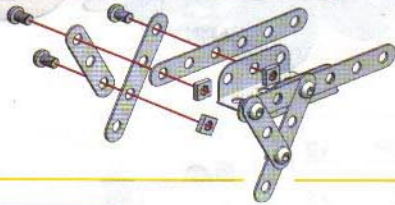
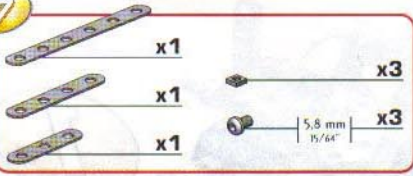

8

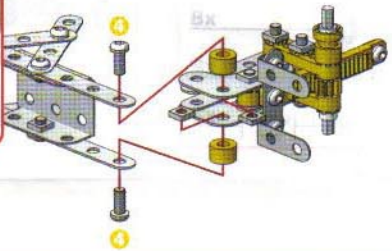
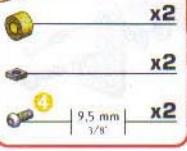

9

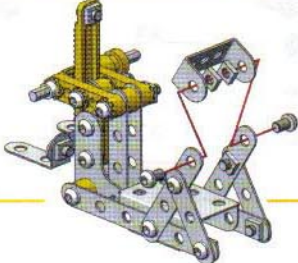
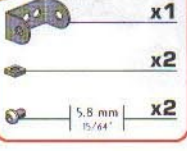

10

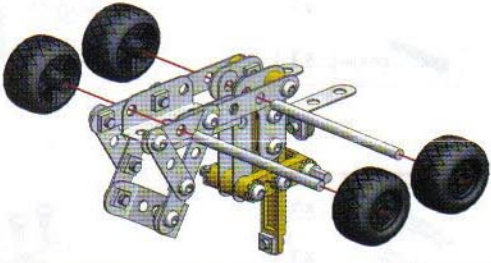
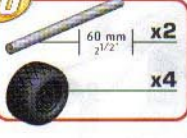

11

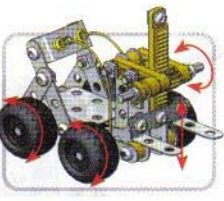
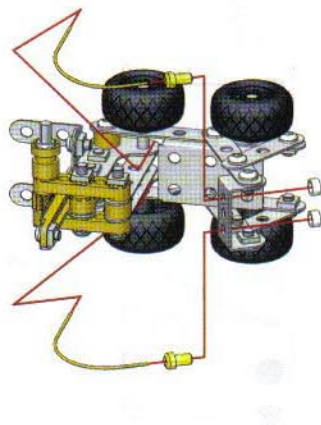
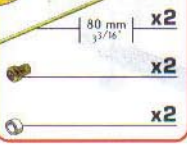

DE Many of the models and component parts are unique and original designs which are the property of MECCANO S.A. They are protected by national legislation in industrial design, trademarks and/or copyrights throughout many countries. For detailed information, please contact MECCANO S.A. MECCANO S.A. accepts no responsibility for (1) failure to follow instructions, (2) use for any purpose other than as specified in the instructions (3) any alteration of any parts or components.

F De nombreux modèles et pièces sont des créations originales, propriétés de MECCANO S.A. et sont protégés par les législations nationales sur les dessins et modèles, marques et/ou droits d'auteurs. Pour toute information, merci de contacter MECCANO S.A. La responsabilité de MECCANO S.A. ne saurait être engagée en cas d'incident survenu à la suite (1) du non respect des instructions de montage (2) de l'utilisation des pièces autre que celle prescrite dans le "notice" (3) d'une altération ou de la modification des pièces.

D Zahlreiche Modelle und Teile sind Erfindungen und Eigentum der Firma MECCANO S.A. Sie sind durch Marken-Gesetze, über Zeichnungen und Modelle sowie Verzeichnisse anderer Urheberrechte geschützt. Für zusätzliche Anmerkungen wenden Sie sich bitte an MECCANO S.A. Die Firma MECCANO S.A. haftet nicht für Unfälle, die aus der (1) Nichtbefolgung der Bauanweisung, der (2) Verwendung anderer als in der Bauanweisung angegebenen Teile oder der (3) Änderung oder Modifikation der Teile resultieren.

I Numerosi modelli e pezzi sono creazioni originali della MECCANO S.A. e sono protetti dalle legislazioni nazionali sui disegni e modelli, marchi ed altri diritti d'autore. Per qualsiasi informazione, viaggiate preferire contatto con MECCANO S.A. MECCANO S.A. declina ogni responsabilità in caso d'incidenti sopravvenuti in seguito a: (1) non rispetto delle istruzioni di montaggio; (2) l'uso non previsto per funzioni diverse da quelle previste nel manuale; (3) alterazione o modifica dei pezzi.

E Numerosos modelos y piezas son creaciones originales, propiedad de MECCANO S.A. y están protegidos por las legislaciones nacionales en lo que concierne a los dibujos y modelos, marcas y/o derechos de autor. Para cualquier información, diríjase siempre en contacto con MECCANO S.A. MECCANO S.A. no acepta responsabilidad en caso de accidente debido a: (1) el incumplimiento de las instrucciones de montaje (2) una utilización de las piezas diferente a la que se indica en las instrucciones (3) una alteración o modificación de las piezas.

P Vários modelos e peças são criações originais, propriedades da MECCANO S.A. e são protegidos pelas legislações nacionais relativas aos desenhos e modelos, às marcas e/ou aos direitos de autor. Para quaisquer informações, dirija-se sempre em contacto com MECCANO S.A. MECCANO S.A. não poderá ser responsabilizada pelas acidentes provocados: (1) pela falta de cumprimento das instruções de montagem (2) pelo uso indevido das peças ou (3) pela modificação ou alteração das peças.

S Många modeller och delar består av unika och originalt utformade delar som är MECCANO S.A. egendom. Dessa modeller och delar är skyddade genom lagstiftning såsom industriell författning, varumärkes och/eller upphovsrättigheter i ett eller flera länder. För mer detaljerad information, var vänlig och kontakta MECCANO S.A. MECCANO S.A. åtar sig inte ansvar i händelse av olycka till följd av (1) ett ickefyllnadsinstruktionerna eller (2) användning av delar som inte är avsedda för användningen (3) en modifiering eller förändring av delarna.

RU Viele meiner Modelle und Teile sind einzigartige, original gezeichnete Erfindungen der MECCANO S.A. Sie sind durch Marken-Gesetze, über Zeichnungen und Modelle sowie Verzeichnisse anderer Urheberrechte geschützt. Für zusätzliche Anmerkungen wenden Sie sich bitte an MECCANO S.A. Die Firma MECCANO S.A. haftet nicht für Unfälle, die aus der (1) Nichtbefolgung der Bauanweisung, der (2) Verwendung anderer als in der Bauanweisung angegebenen Teile oder der (3) Änderung oder Modifikation der Teile resultieren.

DK Uæstede modeller og dele er unikke, originalt tegnet og ejet af MECCANO S.A. Tegningerne, modellerne, varemærkerne og oplysningerne er beskyttet af lovgivning i mange lande. Yderligere oplysninger kan fås hos MECCANO S.A., MECCANO S.A. påtager sig ikke ansvar for ulykker, der skyldes (1) ikke at følge de angivne byggeinstruktioner, (2) anvendelse af andre dele end de der er beskrevet i byggeinstruktionerne, (3) hvis der foretages ændringer eller ændringer i konstruktionen af delene.

PL Wiele modeliów i części jest unikalnymi, oryginalnymi konstrukcjami firmy MECCANO S.A. i są one chronione prawem w wielu państwach. Wiele modeliów i części jest chronionych przez prawo w wielu państwach. Wiele modeliów i części jest chronionych przez prawo w wielu państwach. Wiele modeliów i części jest chronionych przez prawo w wielu państwach.

JP 多くのモデルと部品は、ユニークでオリジナルなデザインであり、MECCANO S.A. の財産です。これらのモデルと部品は、工業デザイン、商標、著作権法、およびその他の国の法律によって保護されています。MECCANO S.A. は、(1) 組み立て指示に従わず、(2) 指示された用途以外の目的で使用され、(3) 部品またはコンポーネントの任意の変更による事故に対して責任を負いません。

SEA Many models and component parts constitute original designs which are the property of MECCANO S.A. and are protected by design, trade, and/or patent laws in many countries. For detailed information, please contact MECCANO S.A. MECCANO S.A. accepts no responsibility for (1) failure to follow instructions, (2) use of parts for any purpose other than as specified in the instruction booklet, (3) any alteration of any parts or components.

Made in France by
FABRIKATON EN FRANCE PAR
MECCANO S.A.
MECCANO S.A. "MECCANO" is an exclusive trademark of MECCANO S.A.
© 1998 MECCANO S.A.



MECCANO
363, Avenue de Saint-Eusèpy
F - 62100 CALAIS