

MECCANO[™]
ENGINEERING & ROBOTICS

DESMOSEDICI GP



18301



Instructions
Notice de montage
Instrucciones de construcción
Bauanleitung
Bouwinstructie
Istruzioni
Instruções
Инструкции
Instrukcja
Pokyny
Útmutató
Instrucțiuni





CONSTRUCTION TIPS / ASTUCES DE CONSTRUCTION

TIPS DE CONSTRUCCIÓ / TIPPS ZUM BAUEN / MONTAGETIPS / SUGGERIMENTI PER COSTRUIRE
DICAS DE MONTAGEM / РЕКОМЕНДАЦІЇ ПО СБОРКЕ / WSKAZÓWKI DO BUDOWANIA
KONSTRUKČNÍ TIPY / TÍPY NA MONTÁŽ / ÖSSZESZERELÉSI TIPPEK / SFATURI PENTRU CONSTRUIRE

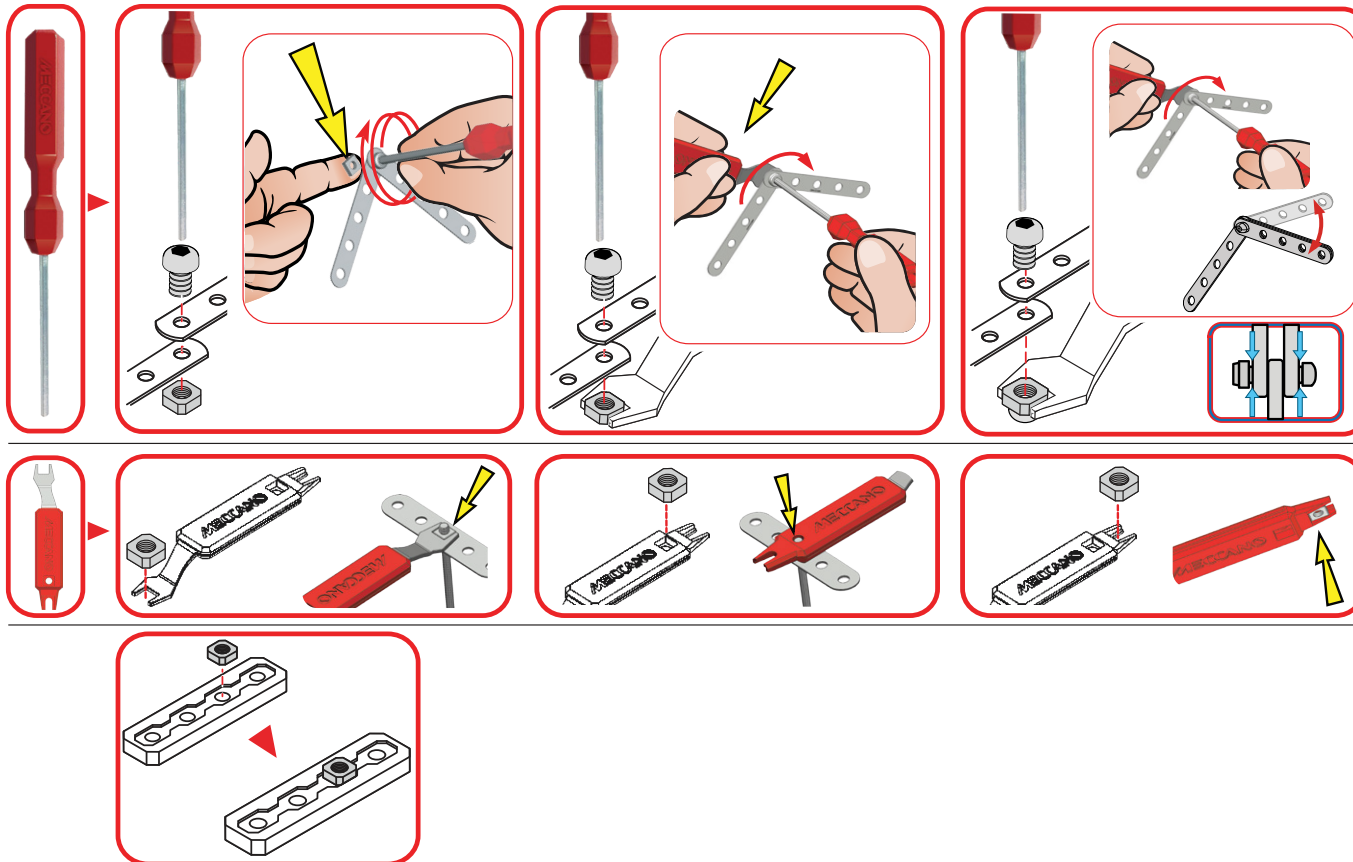

TABLE OF CONTENTS / SOMMAIRE

ÍNDICE / INHALTSVERZEICHNIS / INHOUD / INDICE / СОДЕРЖАНИЕ







SPIS TREŚCI / OBSAH / TARTALOMJEGYZÉK / CUPRINS



EN. Content: 351 parts, 2 real tools, 1 sticker sheet, 1 instruction sheet for 1 model.
FR. Contenu : 351 pièces, 2 vrais outils, 1 feuillet d'autocollants, 1 notice de montage pour 1 modèle.
ES. Contenido: 351 piezas, 2 herramientas reales, 1 hoja de calcomanías, 1 guía de instrucciones para 1 modelo.
DE. Inhalt: 351 Teile, 2 echte Werkzeuge, 1 Bogen mit Aufklebern, 1 Bauanleitung für 1 Modell.
NL. Inhoud: 351 onderdelen, 2 stuks gereedschap, 1 stickervel, 1 bouw instructie voor 1 model.
IT. Contenuto: 351 pezzi, 2 attrezzi, 1 foglio di adesivi, 1 guida per l'uso per 1 modello.
PT. Conteúdo: 351 peças, 2 ferramentas reais, 1 folha de adesivos, 1 folha de instruções para 1 modelo.
RU. В комплекте: 351 деталь, 2 настоящих инструмента, 1 лист с наклейками, 1 инструкция по сборке 1 модели.
PL. Zawartość: 351 elementów, 2 prawdziwe narzędzia, 1 arkusz naklejek, 1 karta z instrukcjami dla 1 modelu.
CZ. Obsah: 351 dílů, 2 skutečné nástroje, 1 list se samolepkami, 1 list s pokyny pro 1 model.
SK. Obsah: 351 dielov, 2 skutočné nástroje, 1 hárok s nálepkami, 1 hárok s pokynmi pre 1 model.
HU. Tartalom: 351 db alkatrész, 2 db valódi szerszám, 1 db matricalap, 1 db 1 modellhez tartozó felhasználói útmutató.
RO. Conținut: 351 de piese, 2 instrumente reale, 1 foaie cu autocolante, 1 fișă cu instrucțiuni pentru 1 model.



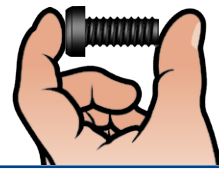
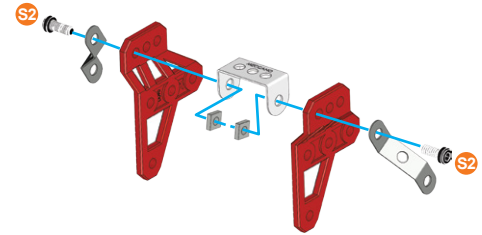

1

-  S2 | 9.5 mm | x2
3/8"
-  x2
-  x1
-  x2
-  x1
-  x1







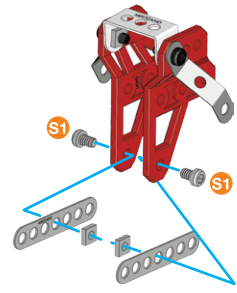

2

-  S1 | 5.8 mm | x2
15/64"
-  x2
-  x2



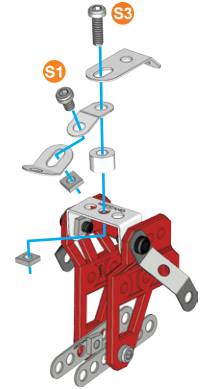
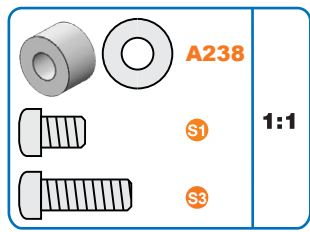

3

-  S1 | 5.8 mm | x1
15/64"
-  S3 | 12 mm | x1
1/2"
-  x1
-  x2
-  x1
-  x1





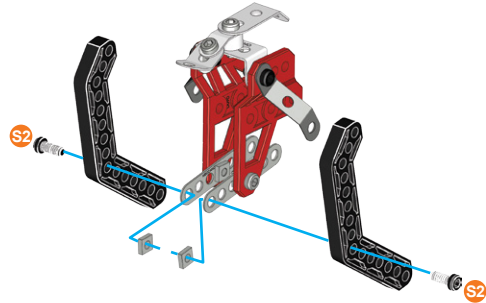

4

-  **S2** | 9.5 mm | **x2**
3/8"
-  **x2**
-  **x2**

-  **S2** | **1:1**





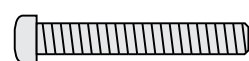

5

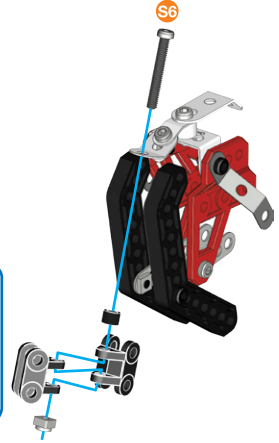

-  **S6** | 28 mm | **x1**
1 1/8"
-  **x1**
-  **x1**
-  **x2**

-  **A338**
-  **S6** | **1:1**

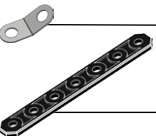

6

-  **C1** | 31.75 mm | **x1**
1 1/4"
-  **B4** | 38.1 mm | **x1**
1 1/2"
-  **x5**
-  **x2**
-  **x2**
-  **x2**

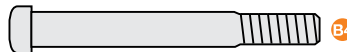
-  **A238**
-  **C1** | **1:1**
-  **B4**

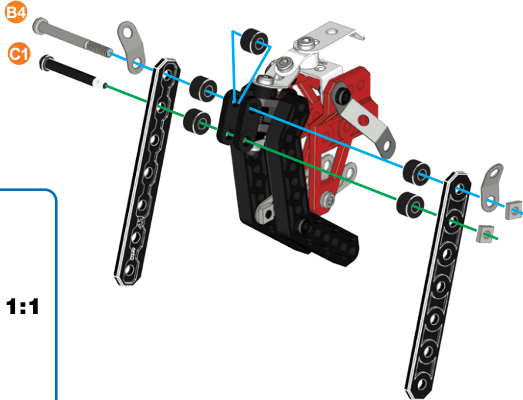

7

	38,1 mm 1 1/2"	x1
		x1
		x1
		x1
		x1
		x1

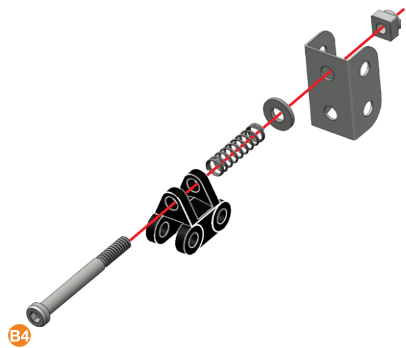

	1:1
--	-----

8

⑥+⑦+

	5,8 mm 15/64"	x2
		x2
		x2

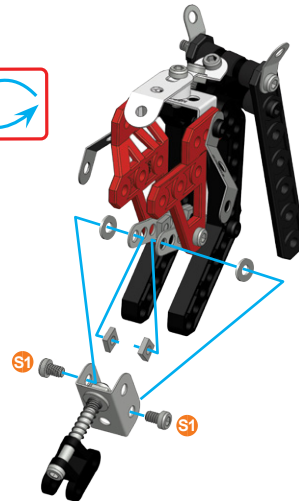

	1:1
--	-----

9

	28 mm 1 1/8"	x1
		x4
		x1
		x1

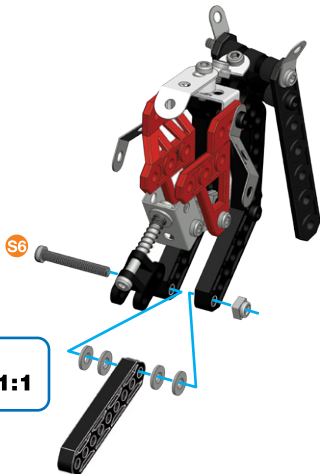

	1:1
--	-----

10

	5,8 mm 15/64"	x1
	9,5 mm 3/8"	x1
		x1
		x1

	1:1
	1:1

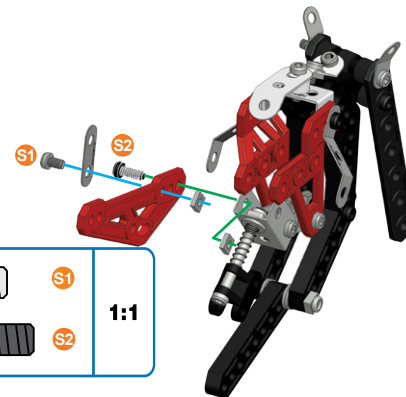

11

	31.75 mm 1 1/4"	x1
		x1
		x4
		x1
		x1



	A338	1:1
	C1	

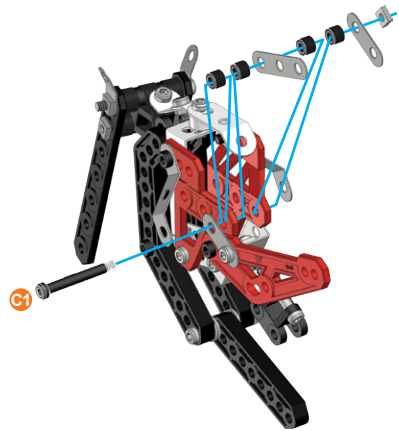

12

	9.5 mm 3/8"	x1
		x1
		x1
		x1

	S2	1:1
	A338	

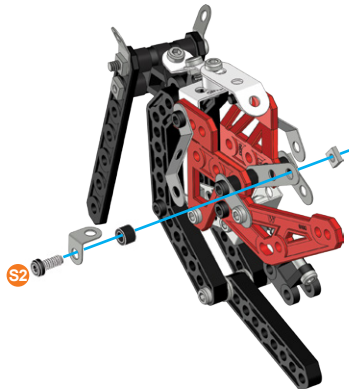





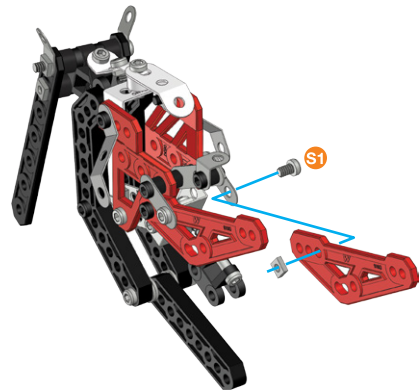

13

	5.8 mm 15/64"	x1
		x1
		x1



	S1	1:1
--	----	-----



14



-  **B2** | 19 mm | **x1**
3/4"
-  **S5** | 25,4 mm | **x1**
1"
-  | **x2**
-  | **x2**
-  | **x2**
-  | **x1**

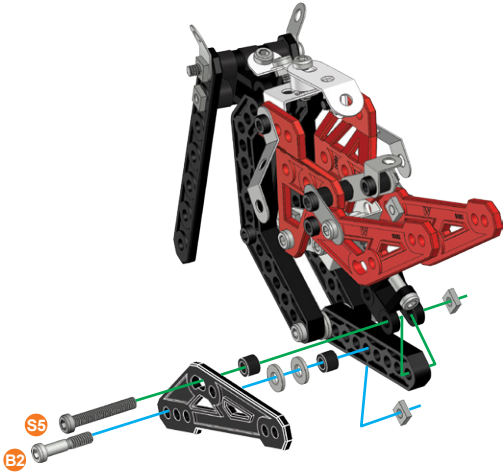

-  **A338**
-  **B2** | **1:1**
-  **S5**





15

-  **S1** | 5,8 mm | **x1**
15/64"
-  | **x1**
-  | **x1**

-  **S1** | **1:1**





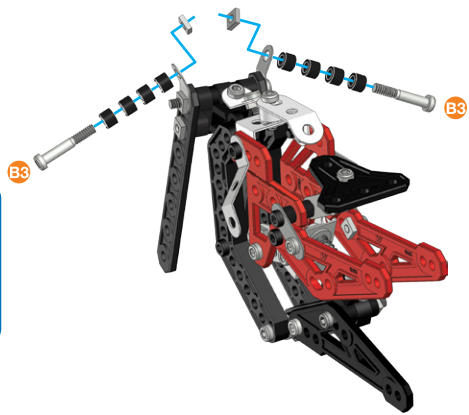

16

-  **B3** | 23 mm | **x2**
15/16"
-  | **x2**
-  | **x8**

-  **A338**
-  **B3** | **1:1**





17

	S1	5.8 mm	x2
		15/64"	x2
			x2
			x1
			x2

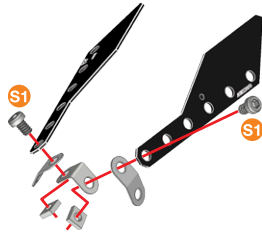
	S1	1:1
---	----	-----





18

	S1	5.8 mm	x2
		15/64"	x2
			x2

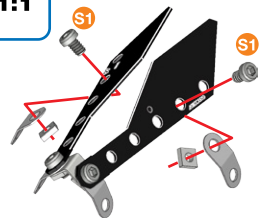
	S1	1:1
---	----	-----





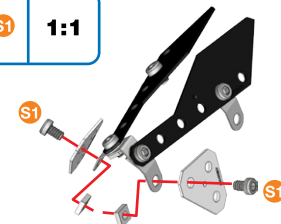

19

	S1	5.8 mm	x2
		15/64"	x2
			x2

	S1	1:1
---	----	-----





20

	S1	5.8 mm	x4
		15/64"	x4
			x2
			x2

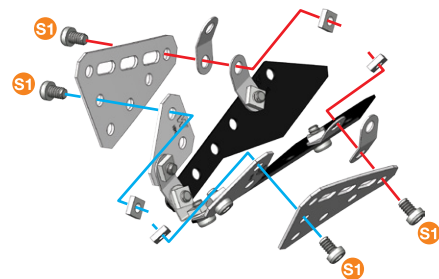
	S1	1:1
---	----	-----





21

	S1	5.8 mm	x2
		15/64"	x2
			x2

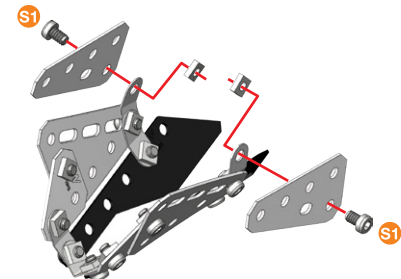
	S1	1:1
--	----	-----



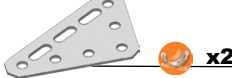

22

-  S1 | 5.8 mm | 15/64" | **x4**
-  **x4**
-  **x2**

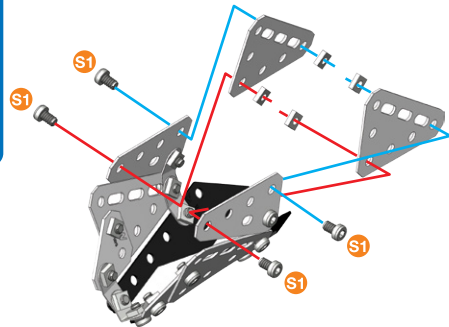
-  S1 | **1:1**



23

-  S1 | 5.8 mm | 15/64" | **x2**
-  **x2**
-  **x2**

-  S1 | **1:1**

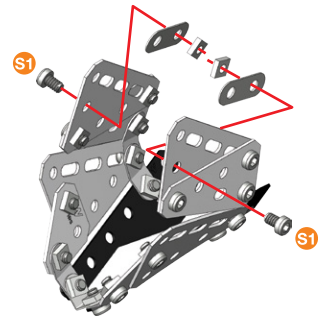

24

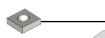
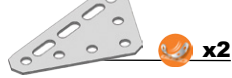

-  S1 | 5.8 mm | 15/64" | **x2**
-  **x2**
-  **x2**

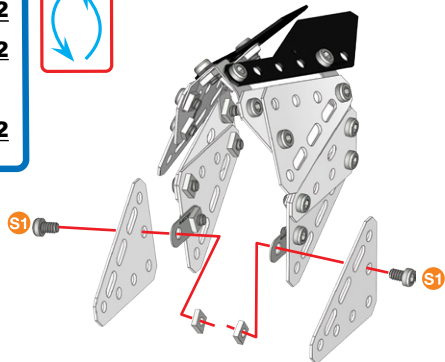

-  S1 | **1:1**



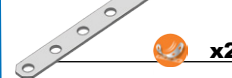

25

-  S1 | 5.8 mm | 15/64" | **x2**
-  **x2**
-  **x2**

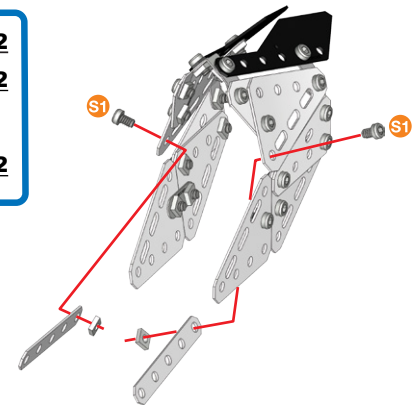
-  S1 | **1:1**





26

	S1	5.8 mm 15/64"	x4
			x4
			x2

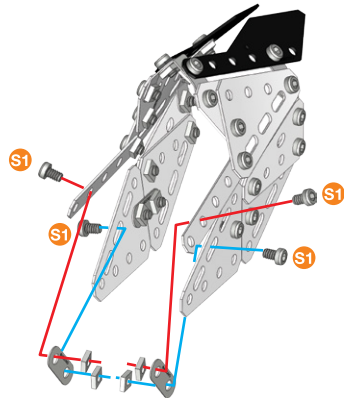
	S1	1:1
---	----	-----





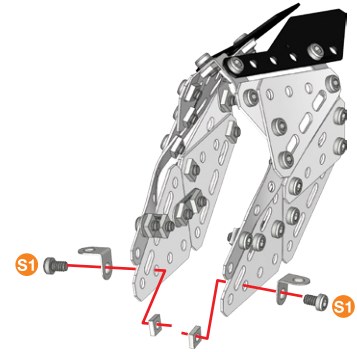

27

	S1	5.8 mm 15/64"	x2
			x2
			x2

	S1	1:1
--	----	-----







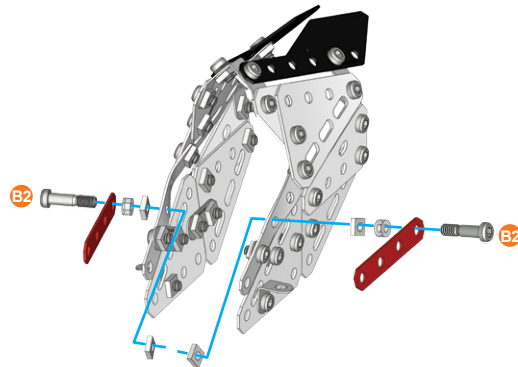

28

	B2	19 mm 3/4"	x2
			x4
			x2
			x2

	B2	1:1
--	----	-----



29**(16)+(28)+**

	S1 5,8 mm x2 15/64"
	x2
	x2
	x2
	x1
	x1





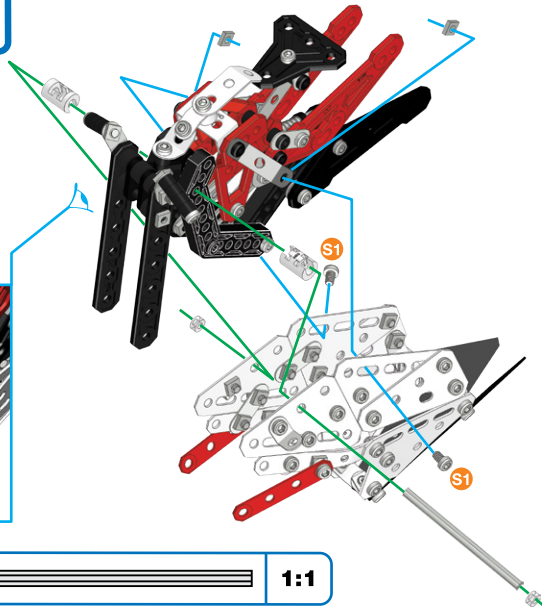
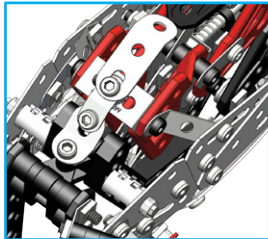

	S1 1:1
---	------------------------







	1:1
---	------------

30

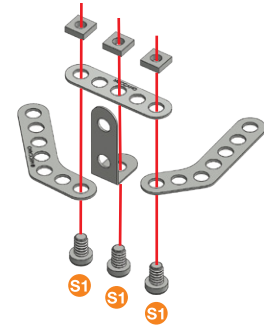
	S1 5,8 mm x3 15/64"
	x3
	x1
	x1
	x2

	S1 1:1
---	------------------------





**31**

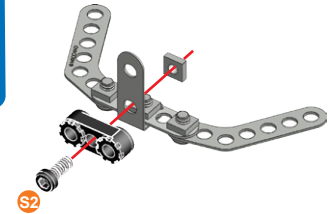

	S2 9,5 mm x1 3/8"
	x1
	x1

	S2 1:1
--	------------------------







32

	9.5 mm 3/8"	x1
		x1
		x1
		x2

		A338	1:1
		S2	







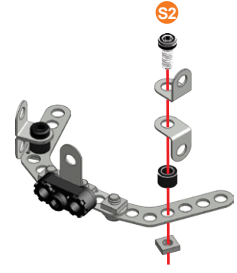

33

	9.5 mm 3/8"	x1
		x1
		x1
		x2

		A338	1:1
		S2	







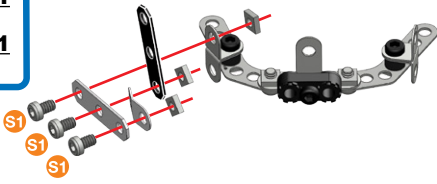

34

	5.8 mm 15/64"	x3
		x3
		x1
		x1
		x1

	S1	1:1





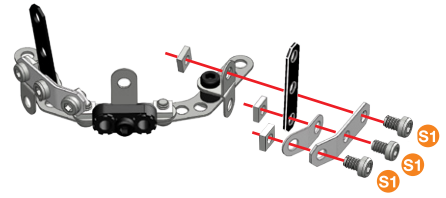

35

	5.8 mm 15/64"	x3
		x3
		x1
		x1
		x1

	S1	1:1



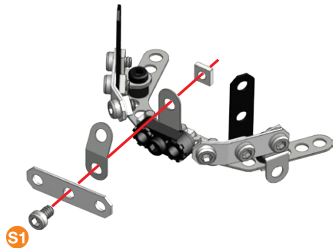

36

-  **S1** | 5.8 mm | **x1**
15/64"
-  **x1**
-  **x1**
-  **x1**



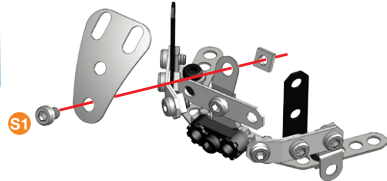

37

-  **S1** | 5.8 mm | **x1**
15/64"
-  **x1**
-  **x1**



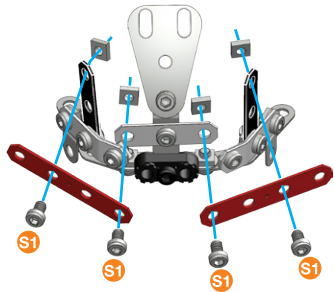

38

-  **S1** | 5.8 mm | **x4**
15/64"
-  **x4**
-  **x2**



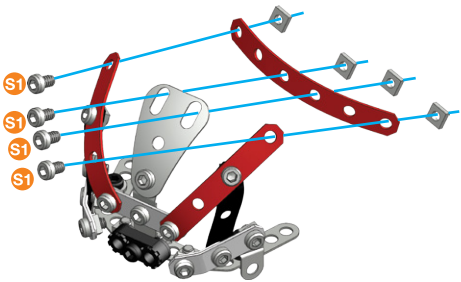

39

-  **S1** | 5.8 mm | **x4**
15/64"
-  **x4**
-  **x1**





40 (29)+(39)+

	5.8 mm 15/64"	x4
		x4
		x2

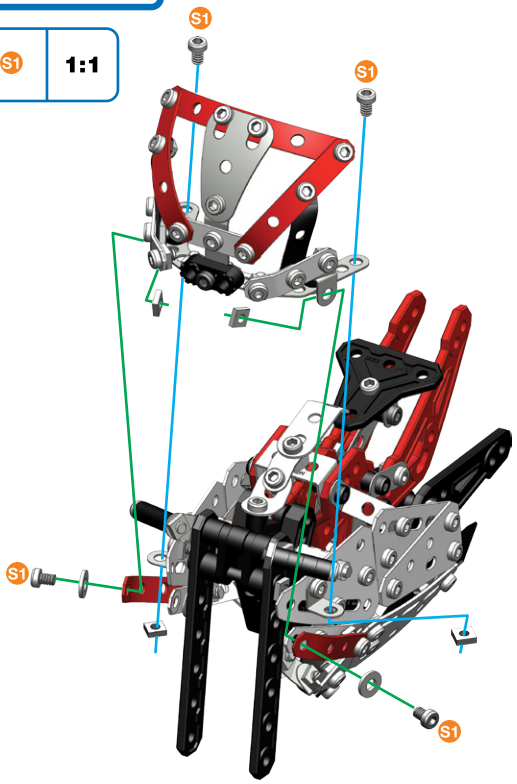
	S1	1:1
---	----	-----





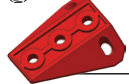

41

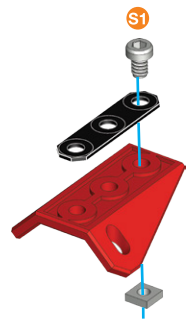
	5.8 mm 15/64"	x1
		x1
	(39)	x1
		x1

	S1	1:1
---	----	-----





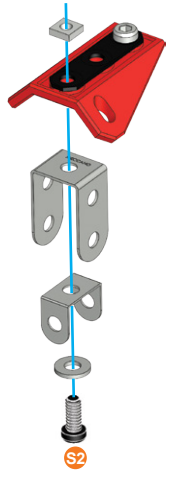

42

	9.5 mm 3/8"	x1
		x1
		x1
		x1
		x1

	S2	1:1
---	----	-----





43

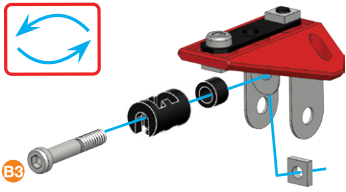

	B3 23 mm x1 15/16"
	x1
	x1
	x1





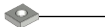

	B3	1:1
	A338	

44

	S2 9.5 mm x1 3/8"
	x1
	x1

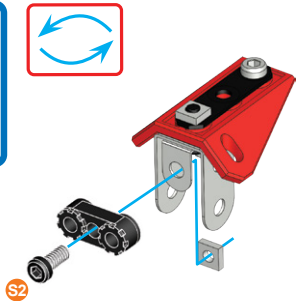





	S2	1:1
--	-----------	------------

45

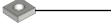
(40)+(44)+

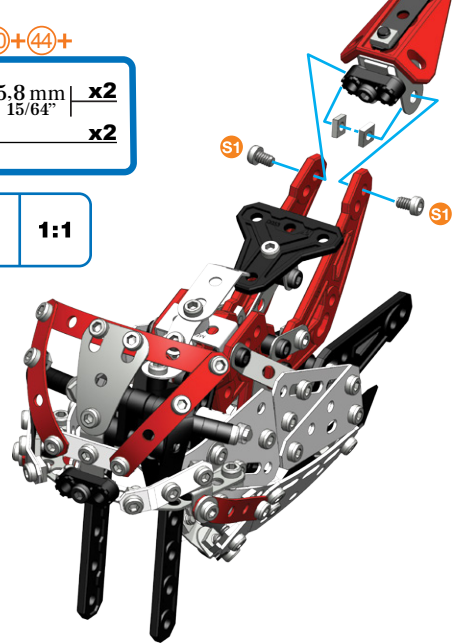

	S1 5.8 mm x2 15/64"
	x2

	S1	1:1
--	-----------	------------





46

x2

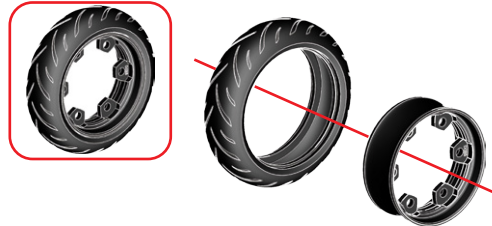
	x2
	x2





47

	9,5 mm 3/8"	x6
		x6
		x2

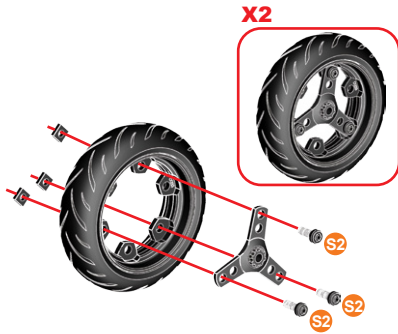
	1:1
---	------------





48

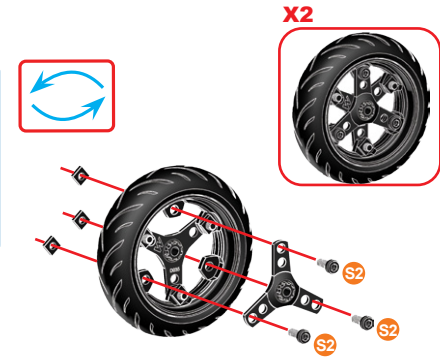

	9,5 mm 3/8"	x6
		x6
		x2

	1:1
---	------------



49 (45)+(48)+

	40 mm 1 9/16"	x1
		x2
		x2

		A238	1:1
---	---	-------------	------------

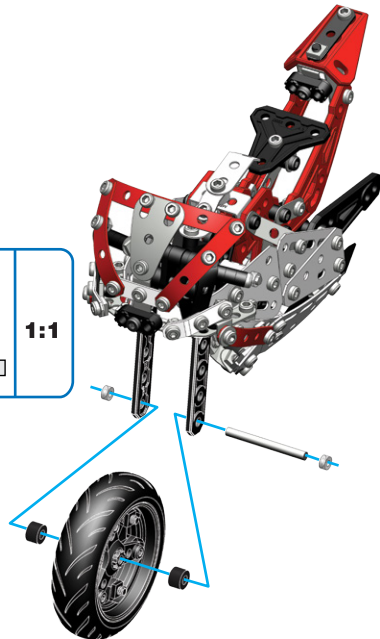

50 (48)+(49)+

	28 mm 1 1/8"	x1
		x1
		x1

		A238	1:1
---	---	-------------	------------

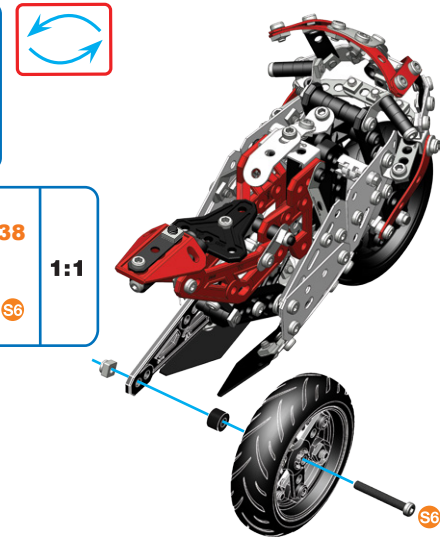

51



x1







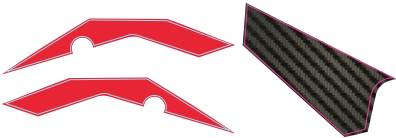



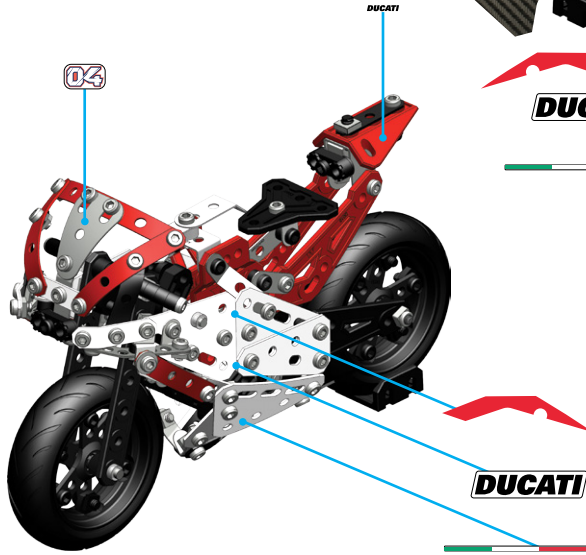
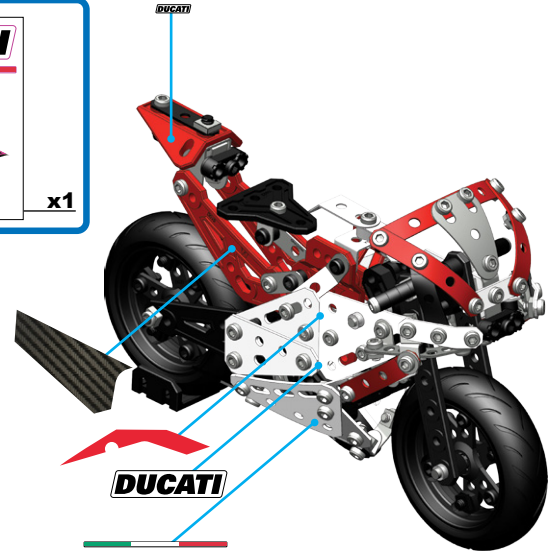

















































































































































52



















































DUCATI 04 **DUCATI** **DUCATI**





x1

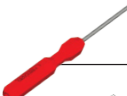

	A138 x12		C868 x2		C330 x8
	A259 x6		A419 x3		C483 x11
	A337 x88		D487 x1		C483 x1
	A337 x12		D035 x4		A806 x6
	A737 x4		D053 x1		A712 x1
	A338 x19		D018 x1		A811 x1
	A238 x8		B051 x1		A548 x1
	A238 x1		D018 x2		A721 x1
	D292 x1		D249 x2		A951 x1
	D292 x2		D228 x2		A713 x1
	A353 x1		B015 x2		A812 x1
	D100 x3		M234 x1		A416 x1
	D100 x3		D089 x1		A825 x2
	D451 x2		D090 x1		C768 x1
	B684 x1				C775 x2
	D280 x2				C769 x2
	D280 x2				D208 x2
	D298 x6				D104 x4
					D206 x1
					
					
					
					
					
					
					
					
					
					
					
					
					
					
					
					
					
					
					
					
					
					
					
					
					
					
					
					
					
					
					
					

	S1	5,8 mm 15/64"	A637 x64
	S2	9,5 mm 3/8"	A511 x23
	S3	12 mm 1/2"	A411 x1
	B2	19 mm 3/4"	A447 x3
	B3	23 mm 15/16"	A347 x3
	S5	25,4 mm 1"	A912 x1
	S6	28 mm 1 1/8"	A611 x3
	C1	31,75 mm 1 1/4"	C935 x2
	B4	38,1 mm 1 1/2"	B696 x2
		40 mm 1 1/2"	A918 x1
		60 mm 2 1/2"	A516 x1
			
			
			
			
			
			
			
			
			
			
			
			
			
			
			
			
			
			
			
			
			
			
			
			
			
			
			
			
			
			
			
			
			
			
			
			
			
			
			
			

	x1
	C994 x1
	D499 x1

EN. Remove all packaging before use. Retain this information, addresses and phone numbers for future reference. Content may vary from pictures. An adult should periodically check this toy to ensure no damage or hazards exist; if so, remove from use. Children should be supervised during play. Adult supervision advised. Meccano reserves the right to discontinue use of the www.meccano.com website at any time.

FR. Retirer tout l'emballage avant utilisation. Conserver les informations, adresses et numéros de téléphone pour consultation ultérieure. Le contenu peut différer des images. Un adulte doit régulièrement examiner ce jouet afin de s'assurer qu'il ne présente pas de dommage ni de risque. En cas de problème, ne plus l'utiliser. Les enfants doivent être surveillés lorsqu'ils jouent. Surveillance d'un adulte conseillée. Meccano se réserve le droit de supprimer le site Internet www.meccano.com à tout moment.

ES. Retire todo el embalaje antes de utilizar el producto. Conserve toda la información, las direcciones y los números de teléfono para futuras referencias. El contenido del paquete puede no corresponder con las imágenes. Un adulto debe revisar de forma periódica el juguete para asegurarse de que no supone un riesgo para el niño; si así fuera el caso, interrumpa su uso. Supervise a los niños mientras juegan con el producto. Se recomienda la vigilancia de un adulto.

DE. Entfernen Sie vor der Benutzung sämtliche Verpackungsmaterialien. Alle Informationen, Adressen und Telefonnummern bitte für mögliche Rückfragen aufbewahren. Der Packungsinhalt kann von den Bildern abweichen. Ein Erwachsener sollte regelmäßig sicherstellen, dass das Spielzeug keine Gefahr darstellt, und es gegebenenfalls entfernen. Kinder sollten beim Spielen beaufsichtigt werden. Beaufsichtigung durch Erwachsene empfohlen.

NL. Verwijder de verpakking voor gebruik. Bewaar deze informatie, adressen en telefoonnummers voor toekomstig gebruik. Inhoud kan afwijken van illustraties. Een volwassene dient dit speelgoed regelmatig te controleren. In geval van schade of gevaren het speelgoed niet meer gebruiken. Houd toezicht als kinderen spelen. Toezicht door een volwassene aanbevolen.

IT. Rimuovere l'imballo prima dell'uso. Conservare informazioni, indirizzi e numeri di telefono per riferimento futuro. Il prodotto potrebbe essere differente dalle immagini. Il giocattolo deve essere periodicamente controllato da un adulto per prevenire eventuali danni o rischi; in caso di danno, sospendere l'uso. I bambini devono essere sorvegliati durante il gioco. Si raccomanda la sorveglianza di un adulto.

PT. Remova totalmente a embalagem antes de utilizar. Guarde todos os endereços, números de telefone e demais informações para consulta e referência. O conteúdo poderá ser diferente das ilustrações. Um adulto deve verificar o brinquedo periodicamente para garantir que não há danos ou riscos. Se houver, é necessário que o brinquedo seja retirado de uso. As crianças devem ser supervisionadas enquanto brincam. Recomendada a vigilância por adultos.

RU. Снимите все упаковочные материалы перед использованием. Запишите указанные на упаковке адреса и номера телефонов, чтобы у вас была возможность связаться с нами. Содержимое упаковки может отличаться от иллюстрации. Взрослым следует время от времени проверять игру и следить за тем, чтобы она не была сломана и не представляла опасности для ребенка. В противном случае ее не следует использовать. Во время игры дети должны находиться под присмотром. Рекомендуется присмотр взрослых.

PL. Przed użyciem wyjąć zabawkę z opakowania. Zachować niniejsze informacje, adresy i numery telefonów na wypadek, gdyby były potrzebne w przyszłości. Zawartość opakowania może różnić się od zabawki przedstawionej na obrazkach. Osoba dorosła powinna regularnie sprawdzać zabawkę pod kątem uszkodzeń oraz zagrożeń. Jeśli takowe wystąpią, należy zaprzestać używania zabawki. Dzieci nie powinny bawić się bez nadzoru. Dzieci powinny być nadzorowane przez osobę dorosłą.

CZ. Před použitím odstraňte veškeré balicí materiály. Uložte si tyto informace, adresy a telefonní čísla pro budoucí použití. Obsah se může lišit od obrázků. Dospělá osoba by měla pravidelně kontrolovat, zda hračka není poškozená nebo zda nepředstavuje nebezpečí. Pokud ano, hračku vyhodte. Během hry nenechávejte děti bez dozoru. Doporučujeme dohled dospělého.

SK. Pred použitím odstráňte všetok obalový materiál. Tieto informácie, adresy a telefónne čísla si uchovajte na ďalšie použitie. Obsah sa môže líšiť od zobrazenia. Túto hračku musí pravidelne kontrolovať dospelá osoba, aby sa uistila, že nedošlo k jej poškodeniu a že nehrozí žiadne nebezpečenstvo. Ak áno, ukončíte jej používanie. Deti nesmú byť pri hre bez dozoru. Odporúča sa dozor dospelého.

HU. Használat előtt távolítson el minden csomagolóanyagot. A tudnivalókat, a címet és a telefonszámot őrizze meg későbbi használatra. A csomag tartalma eltérhet a képen látottaktól. A felnőtteknek rendszeresen ellenőrizniük kell, hogy a játékon nincs-e sérülés, illetve nem jelent-e veszélyforrást. Ha igen, ki kell vonni a használatból. A gyermekek játék közben felügyeletet igényelnek. Felnőtt felügyeletre javasolt.

RO. Îndepărtați toate ambalajele înainte de utilizare. Păstrați aceste informații, adresele și numerele de telefon pentru consultare ulterioară. Conținutul poate fi diferit de imaginea din fotografii. Această jucărie trebuie verificată periodic de un adult pentru a se asigura că nu există nicio deteriorare sau niciun pericol; dacă există, scoateți jucăria din uz. Copiii trebuie supravegheați în timp ce se joacă. Se recomandă supravegherea de către adulți.

TM & © 2018 MECCANO for packaging, instructions and models built with this set. * MECCANO is an exclusive trademark of MECCANO. Spin Master logo is a trademark of Spin Master Ltd. All rights reserved. / TM & © 2018 MECCANO pour l'emballage, les notices et modèles de ce coffret. * MECCANO est une marque de commerce exclusive de MECCANO. Le logo de Spin Master est une marque de commerce de Spin Master Ltd. Tous droits réservés.

SPIN MASTER LTD., 225 KING STREET WEST, TORONTO, ON M5V 3M2 CANADA.

Ducati Motor Holding S.p.A. official licensed product.
Ducati Prodotto ufficiale sotto licenza di Ducati Motor Holding S.p.A.



UK – 0800 206 1191, serviceuk@spinmaster.com
IRELAND – 1800 992 249
FRANCE – 0800 909 150, servicefr@spinmaster.com
AUSTRALIA – 1800 316 982, customercare@spinmaster.com
DEUTSCHLAND – 0800 0101 0222, Kundenservice@spinmaster.com
SCHWEIZ – 0800 561 350 • ÖSTERREICH – 0800 297 267
NEDERLAND – 0800 022 3683, klantenservice@spinmaster.com
BELGIË/BELGIQUE – 0800 77 688 • LUXEMBOURG – 800 2 8044

ITALIA – 800 788 532, servizio@spinmaster.com
MÉXICO – 55 4160 7947, servicio@spinmaster.com
POLSKA – 800080238, poland@spinmaster.com
ČESKÁ REPUBLIKA – 800550530, czechrepublic@spinmaster.com
SLOVENSKO – 0800232800, slovakia@spinmaster.com
MAGYARORSZÁG – 080 100 052, hungary@spinmaster.com
ROMÂNIA – 0800400015, romania@spinmaster.com

NORTH AMERICA • AMÉRIQUE DU NORD 1-800-622-8339, CUSTOMERCARE@SPINMASTER.COM

WWW.SPINMASTER.COM