

- 6**
- x1
  - x2
  - x2

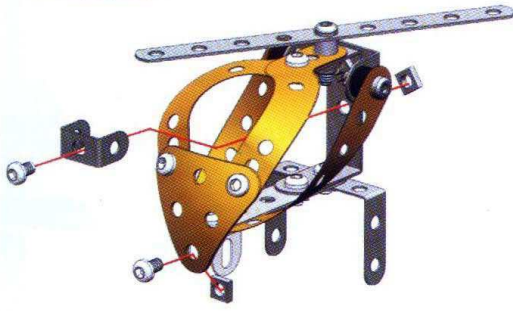

- 1**
- x2
  - x1
  - x2
  - x1
  - x1

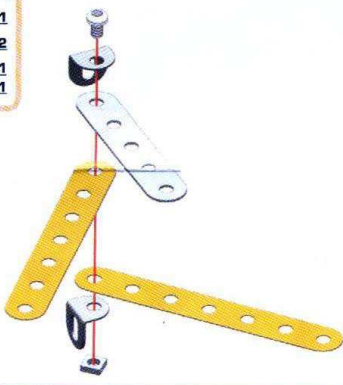

- 7**
- x2
  - x1
  - x3
  - x1
  - x1
  - x1

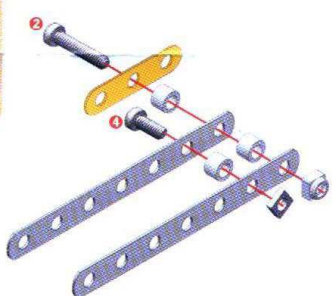

- 2**
- x1
  - x1
  - x2
  - x2

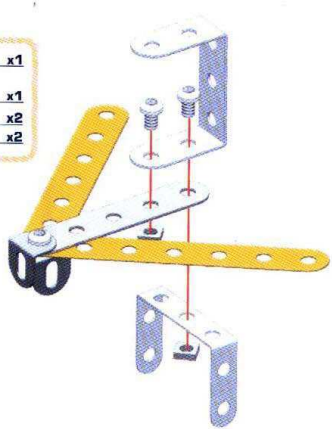

- 8** (6) + (7) +
- x2
  - x2

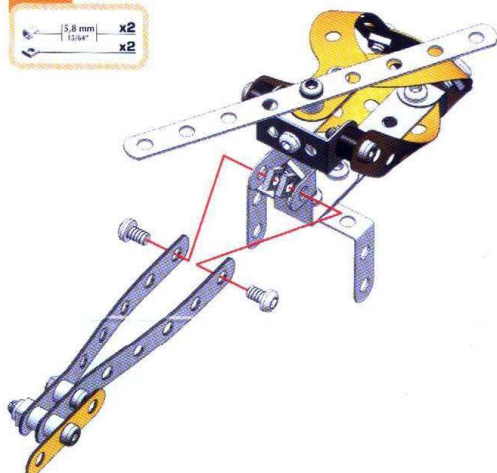

- 3**
- x1
  - x2
  - x2
  - x1
  - x3

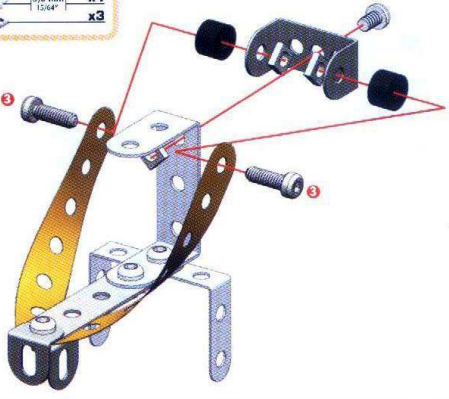

- 4**
- x2
  - x1
  - x2
  - x2

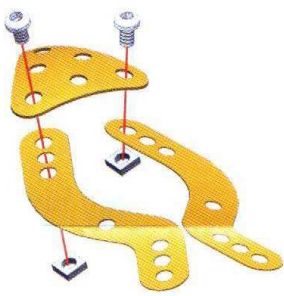

- 9**
- x1
  - x1
  - x1
  - x1
  - x2



- 5** (3) + (4) +
- x1
  - x1
  - x1
  - x1
  - x1
  - x1

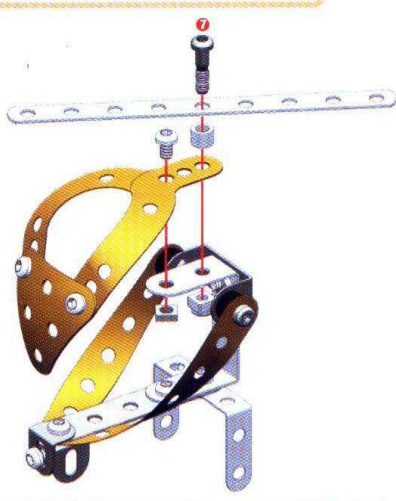

- 10** (8) + (9) +
- x1
  - x1
  - x2
  - x2
  - x1
  - x1

