

USA Many of the models and component parts are unique and original designs which are the property of MECCANO. They are protected by national legislation as industrial designs, trademarks and/or copyrights throughout many countries. For detailed information, please contact: MECCANO. MECCANO shall have no responsibility for (I) failure to follow instructions, (II) use of parts for any purpose other than as specified in the instructions (III) any alteration of any parts or components. MECCANO respects children's safety: all models are tested by children.

F De nombreux modèles et pièces sont des créations originales, propriétés de MECCANO et sont protégés par les législations nationales sur les dessins et modèles, marques et/ou droits d'auteurs. Pour toute information, merci de contacter : MECCANO. La responsabilité de MECCANO ne saurait être engagée en cas d'accident survenu à la suite (I) du non respect des instructions de montage (II) d'une utilisation des pièces autre que celle proposée dans la notice (III) d'une altération ou de la modification des pièces. La société MECCANO respecte la sécurité des enfants : ses modèles sont testés par des enfants.

D Zahlreiche Modelle und Teile sind Erfindungen und Eigentum der Firma MECCANO. Sie sind durch Inland-Gesetze über Zeichnungen und Modelle sowie Warenzeichen und/oder Urheberrechte geschützt. Für zusätzliche Auskünfte wenden Sie sich bitte an : MECCANO. Die Firma Meccano haftet nicht für Unfälle, die aus der (I) Nichtbeachtung der Bauanleitung, der (II) Verwendung anderer als in der Bauanleitung angegebenen Teile oder der (III) Änderung oder Modifikation der Teile resultieren. Alle Modelle der Firma Meccano wurden von Kindern getestet und entsprechen den Sicherheitsnormen.

I Numerosi modelli e pezzi sono creazioni originali della MECCANO e sono protetti dalle legislazioni nazionali sui disegni e modelli, marchi e/o diritti d'autore. Per qualsiasi informazione, vogliate prendere contatto con : MECCANO. Meccano declina ogni responsabilità in caso d'incidenti sopravvenuti in seguito (I) o non rispetto delle istruzioni di montaggio (II) utilizzo dei pezzi per funzioni diverse da quelle previste nel manuale (III) alterazione e/o modifica dei pezzi. La società MECCANO rispetta la sicurezza dei bambini : i suoi modelli vengono testati dai bambini stessi.

E Numerosos modelos y piezas son creaciones originales, propiedades de MECCANO y están protegidos por las legislaciones nacionales en lo que concierne a los dibujos y modelos, marcas y/o derechos de autor. Para cualquier información, sírvase ponerse en contacto con : MECCANO. MECCANO no se responsabiliza por accidentes provocados: (I) por el incumplimiento de las instrucciones de montaje (II) una utilización de las piezas diferente a la que se indica en las instrucciones (III) una alteración o modificación de las piezas. La sociedad MECCANO respeta la seguridad de los niños : sus modelos están probados por niños.

P Vários modelos e peças são criações originais, propriedades da MECCANO e são protegidos pelas legislações nacionais relativas aos desenhos e modelos, às marcas e/ou aos direitos do autor. Para qualquer informação, é favor contactar : MECCANO. A Sociedade MECCANO não poderá ser responsabilizada pelos acidentes provocados: (I) pela falta de cumprimento das instruções de montagem (II) pelo uso indevido das peças ou (III) pela modificação ou alteração das peças. A Sociedade MECCANO respeita a segurança das crianças : os seus modelos foram testados por crianças.

S Många modeller och delar bildar en unik och originell formgivning vilken är MECCANO egendom. Dessa modeller och delar är skyddade genom lagstiftning såsom industriell formgivning, varumärke och/eller upphovsrättigheter i ett flertal länder. För mer detaljerad information, var vänlig och kontakta MECCANO. MECCANO fräntar sig allt ansvar i händelse av olycka till följd av (I) att monteringsinstruktionerna inte har respekterats (II) en annan användning av delarna än den som står i anvisningen (III) en förändring eller förändring av delarna. Företaget MECCANO respekterar barnsäkerheten : modellerna har testats av barn.

FIN Useat mallit ja osat ovat MECCANO:n amsaisuutta olevaa alkuperäistä suunnittelua. Ne ovat kansallisilla lailla suojattua teollista tuotantoa, tavaramerkkejä ja/tai kopiointioikeuksia. Pyydämme ottamaan yhteyden MECCANO:hon kaikissa asioissa liittyvissä kysymyksissä. MECCANO ei vastaa eikä kata seuraavista syistä sattuneita onnettomuuksia: (I) ohjeiden vastainen kokoaminen, (II) muiden kuin ohjeissa ehdotettujen osien käyttö, (III) osien muuntelu tai eri tarkoitukseen käyttö. MECCANO-yhtiö huolehtii lasten turvallisuudesta: lapset ovat testanneet mallimme.

DK Vore mange modeller og dele er originale fremstillinger og ejes af MECCANO. Tegninger, modeller, fabrikkationsmærker og ophavsret er lovbeskyttede i hvert land. Yderligere oplysninger kan fås hos: MECCANO. MECCANO frøsger sig ethvert ansvar, såfremt der er sket uheld forårsaget af (I) at monteringsinstruktionerne ikke er blevet overholdt, (II) at delene er blevet brugt til andre formål, end dem der er beskrevet i betjeningsvejledningen, (III) eller at delene er blevet beskadiget eller ændret. MECCANO overholder sikkerhedsreglerne for børn: Alle modeller testes af børn.

NL Veel modellen en onderdelen zijn origineel ontworpen en eigendom van MECCANO en worden beschermd door de nationale wetgeving op tekeningen en modellen, merken en/of auteursrechten. Voor informatie gelieve contact op te nemen met MECCANO. De verantwoordelijkheid van MECCANO is uitgesloten in geval van ongevallen voortvloeiend uit het niet naleven van de montage-instructies (I), uit het gebruik van andere onderdelen dan die zoals vermeld in de handleiding (II) of uit het veranderen of modificeren van de onderdelen (III). De firma MECCANO neemt de veiligheid van de kinderen in acht : de modellen zijn door kinderen getest.

GR Πολλά μοντέλα και ανταλλακτικά είναι αυθεντικά, ιδιοκτησία της MECCANO και προστατευμένα από τις εθνικές νομοθεσίες για τα μοντέλα τις μάρκες ή τα διπλώματα ευρεσιτεχνίας. Για κάθε πληροφορία για κάθε πληροφορία παρακαλώ απευθυνθείτε στη MECCANO. Η ευθύνη της MECCANO δεν δεσμεύεται σε περίπτωση ατυχήματος που έγινε συνεχώς (I) μη σεβασμού των οδηγιών συναρμολόγησης (II) χρήσης των τεμαχίων διαφορετικά από αυτήν που προτείνεται στις οδηγίες (III) καταστράφι ή αλλαγή των τεμαχίων. Η εταιρεία MECCANO σεβάζεται την ασφάλεια των παιδιών: τα μοντέλα της δοκιμάζονται από παιδιά.

PL Wiele modeli i detali nabora jawniatsj unikalnymi. Ich oryginalna koncepcja jawniatsj sobstvennoju kompanii MECCANO. Modeli zaszczeni zakonodawstwem rozlicznych stran w kwestie towrowej marki przemyselnego dizajna i/lub na osnovanii zakona ob avtorskich prawach. Dla poluchienia bardziejj informacii, pozajuytsja swjazytsja s predstavitelstwom MECCANO. Meccano ne neset owestwennosti w sluchaj: (I) neoboznaweni instrukcii, (II) ispol'zowanii detaliej konstruktora ne po naznaweniju (III) modyn deformacii detaliej konstruktora. MECCANO zabojtsja o detejnoj bezopasnosti: vse modeli testirujotsja detjami.

Instructions
Notice de montage
Bauanleitung
Istruzioni di montaggio

Instrucciones de montaje
Instruções de montagem
Monteringsanvisning
Kokoamisohje

Monterings instruktioner
Montagehandleiding
Οδηγίες συναρμολόγησης.
Инструкции

3250

3251

THE LAPINS CRETINS Rabbids

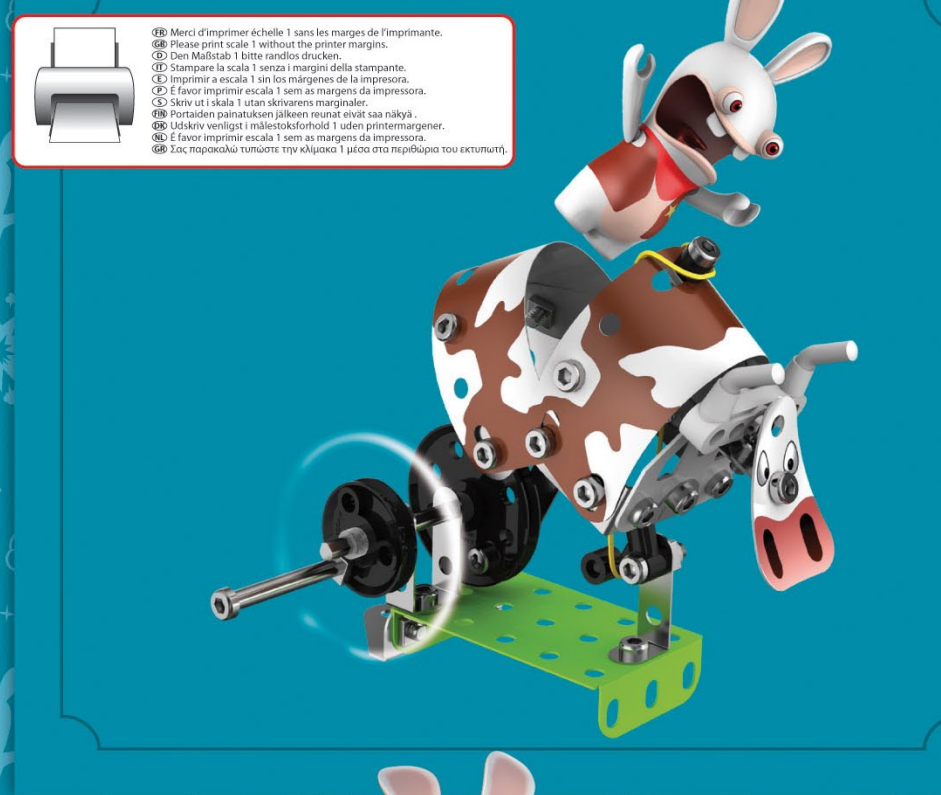

 **Ⓢ** Merci d'imprimer échelle 1 sans les marges de l'imprimante.
Ⓢ Please print scale 1 without the printer margins.
Ⓢ Den Maßstab 1 bitte randlos drucken.
Ⓢ Stampare la scala 1 senza i margini della stampante.
Ⓢ Imprimir a escala 1 sin los márgenes de la impresora.
Ⓢ E favor imprimir escala 1 sem as margens da impressora.
Ⓢ Skriv ut i skala 1 utan skrivarens marginaler.
Ⓢ Postaiden painatukseen jälkeen reunat eivät saa näkyä.
Ⓢ Ühisriikv venitrigi i mälestuskõrholdi 1 uden printermarginer.
Ⓢ E favor imprimir escala 1 sem as margens da impressora.
Ⓢ Σας παρακαλού τωπότε την κλίμακα 1 μέσα στα περιθώρια του εκτυπωτή.

Warning! Attention! Achtung! Attenzione! ¡Atención! Aviso! Varning! Varoitus!
Advarsel! Waarschuwing! Προειδοποίηση! Внимание! Varování! Tähelpanu!
!spėjimas! Figyelmeztetés! Uwaga! Atentie! Pozor! Rabhadh! Узманібу! внимание!



- GB/USA** Warning! Choking Hazard. Contains small parts which could be swallowed. Not suitable for children under 3 years.
- FR** Attention ! Danger d'étouffement. Contient des petites pièces pouvant être absorbées. Ne convient pas aux enfants de moins de 3 ans.
- D** Achtung! Verschluckungsgefahr. Enthält verschluckbare Kleinteile. Nicht für Kinder unter 3 Jahren geeignet.
- I** Attenzione, pericolo di soffocamento! Contiene pezzi piccoli che potrebbero essere ingoiati. Non adatto ai bambini sotto i 3 anni.
- E** ¡Atención! Riesgo de asfixia. Contiene piezas pequeñas que un niño podría tragarse. No conviene a los niños menores de 3 años.
- P** Aviso! Perigo de se engasgar. Contém peças pequenas que podem ser engolidas. Não aconselhável a crianças com menos de 3 anos.
- S** Varning! Risk för kvävning. Innehåller små delar som kan sväljas. Ej lämplig för barn under 3 års ålder.
- FIN** Varoitus! Tukehtumisvaara. Sisältää pieniä osia, jotka voidaan niellä. Ei soveltu alle 3-vuotiaille lapsille.
- DK** Advarsel! Fare for slugning. Indeholder små dele, som kan sluges. Ikke velegnet for børn under 3 år.
- NL** Waarschuwing! Verstikkingsgevaar. Bevat kleine onderdelen die kunnen worden ingeslikt. Niet geschikt voor kinderen onder 3 jaar.
- GR** Προειδοποίηση! Κίνδυνος πνιγμού. Περιέχει μικρά εφευρηματα που θα μπορούσαν να καταποθούν. Ακατάλληλο για παιδιά κάτω από 3 ετών.
- BULGARIAN** Внимание! Опасност от задушаване. Съдържа малки части, които могат да бъдат погълнати. Не е подходящо за деца под 3 години.
- CZECH** Varování! Nebezpečí udušení. Obsahuje malé díly, které by mohly být spolknuty. Nevhodné pro děti do 3 let.
- ESTONIAN** Tähelepanu! Lõõbumisohut. Sisaldab väikesaid osi, mida saab alla neelata. Ei sobi alla 3. aasta vanustele lastele.
- LITHUANIAN** Įspėjimas! Uždusimo pavojus. Yra smulkų dalių, kurias galima nuryti. Netinka vaikams iki 3 metų.
- HUNGARIAN** Figyelmeztetés! Fulladásveszély. Apró alkatrészeket tartalmaz, amelyeket a gyermeknek lenyelhetnek. 3 évesnél fiatalabb gyermekek számára nem alkalmas.
- MAITSE** Twissjija! Periklu li wieheld jifga. Fih partijiet zghar li jistghu jinbelghu. Mhuwiex adattat ghal tfa! izghar minn 3 snin.
- POLISH** Uwaga! Ryzyko uduszenia. Zawiera male czesci, ktore moga zostac polkniete. Produkt nieodpowiedni dla dzieci ponizej 3 lat.
- ROMANIAN** Atentie! Pericol de sufocare. Contine piese mici care pot fi inghitite. Interzis copiilor sub 3 ani.
- SLOVAK** Pozor! Nebezpečnostvo uduseniu. Obsahuje malé diely, ktoré je možné prehltnúť. Nie je vhodné pre deti mladšie ako 3 roky.
- SLOVENIAN** Pozor! Nevarnost zadušitve. Vsebuje majhne dele, ki jih je možno zaužiti. Ni primerno za otroke, mlajše od 3 let.
- IRISH** Rabhadh! Guals Tachta. Píosaí beaga an na fhéadhfadh a bheith insúite. Níl an bréagán seo oiriúnach do pháistí atá níos óige ná trí bhliain d'aois.
- LATVIAN** Uzmanību! Nosmakšanas draudi. Satur sīkas detaļas, kuras var tikt norītas. Nav piemērots bērniem, kas jaunāki par 3 gadiem.
- RUSSIA** Внимание! Возможен риск удушья. В наборе имеются мелкие детали, которые легко проглотить. Противопоказан детям младше 3 лет.



363, avenue de Saint Exupéry
62100 Calais - France
<http://www.meccano.com>
<http://www.erecator.us>
© 12/2012 MECCANO
© MECCANO and ERECTOR are exclusive trademarks of MECCANO
All rights reserved

893250 104111W





P069 X1



C243 X2

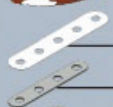

B487 X2



A417 (0235H) X1



A127 (0126A) X1

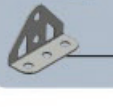

A127 (0126A) X1



C379 X1



A347 (0147G) X1



A247 (0147D) X2

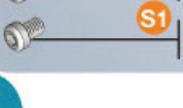

A411 (0111A) X2



A511 (0111C) X1

A637 (0037B) X18

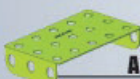

A351 (0050) X1



A621 (0021P3P) X1



A322 (0022CP3P) X1



B017 X1

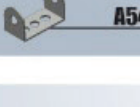

A436 (0811A) X1

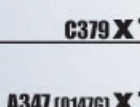

A548 (0048E) X1



50mm
2" **A317 (0317) X1**



A696 (0186H) X1



B684 X1



A512 (0012B) X2



A812 (0812B) X1

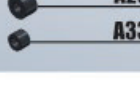

A712 (0012C) X2

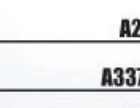

A423 (0260F) X1



A238 (0038A) X5



A338 (0038B) X2



A259 (0059C) X2



A337 (0037A) X22



A737 (0037H) X3



A138 (0038) X2



A136 (0036C) X1

C088 X1

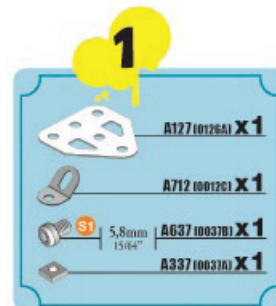

3

A512 (00120) X1

S1 5,8mm (15/64") A637 (00370) X1

A337 (00370) X1

S1 1:1

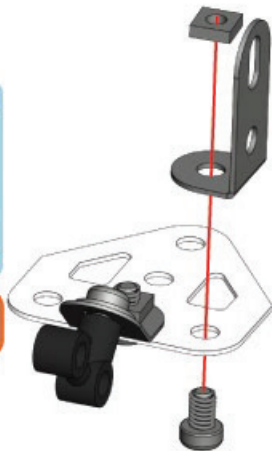

4

A512 (00120) X1

S1 5,8mm (15/64") A637 (00370) X1

A337 (00370) X1

S1 1:1



5

B017 X1

A712 (00120) X1

S3 12mm (1/2") A411 (01110) X1

A337 (00370) X1

S3 1:1

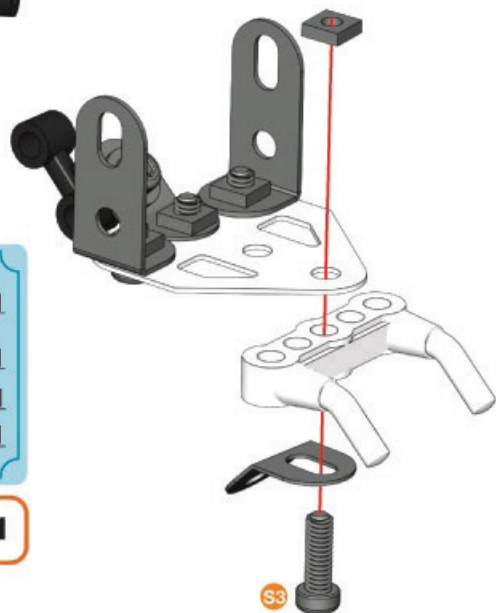

6

C243 X1

S1 5,8mm (15/64") A637 (00370) X1

A337 (00370) X1

S1 1:1

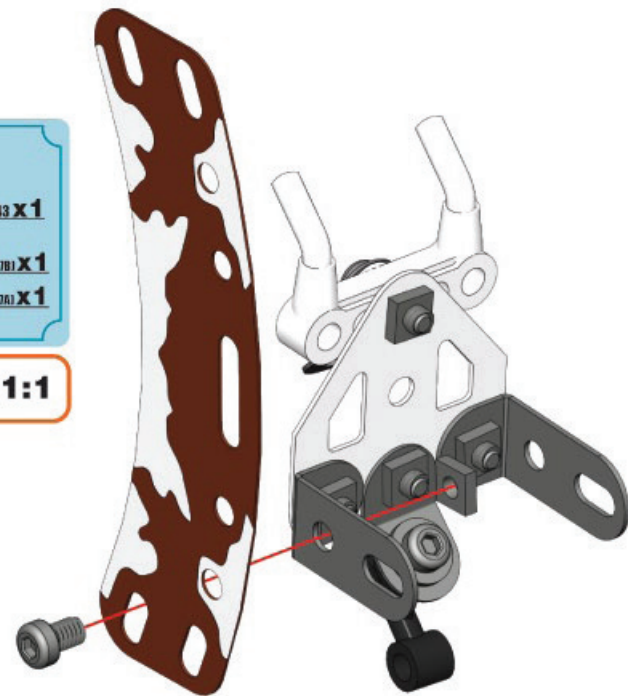

7

S1 5,8mm (15/64") A637 (00370) X1

A337 (00370) X1

S1 1:1

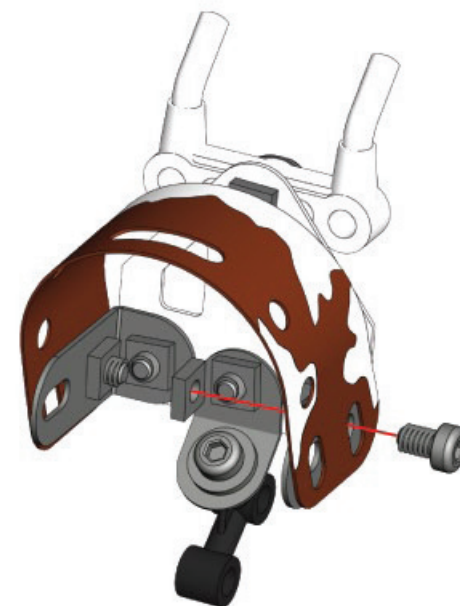

8

B487 X 1

S1 5,8mm 15/64" **A637 (0037B) X 1**
A337 (0037A) X 1

S1 **1:1**



10

C243 X 1

S1 5,8mm 15/64" **A637 (0037B) X 1**
A337 (0037A) X 1

S1 **1:1**

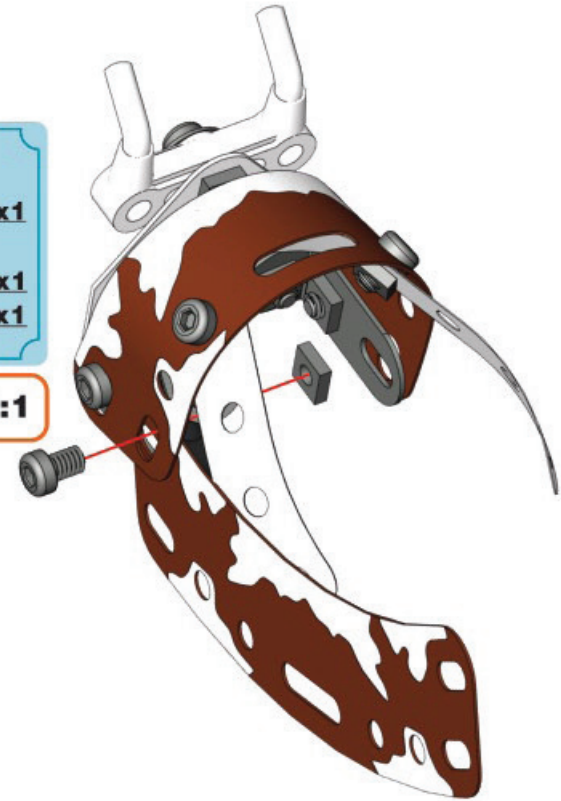

9

B487 X 1

S1 5,8mm 15/64" **A637 (0037B) X 1**
A337 (0037A) X 1

S1 **1:1**

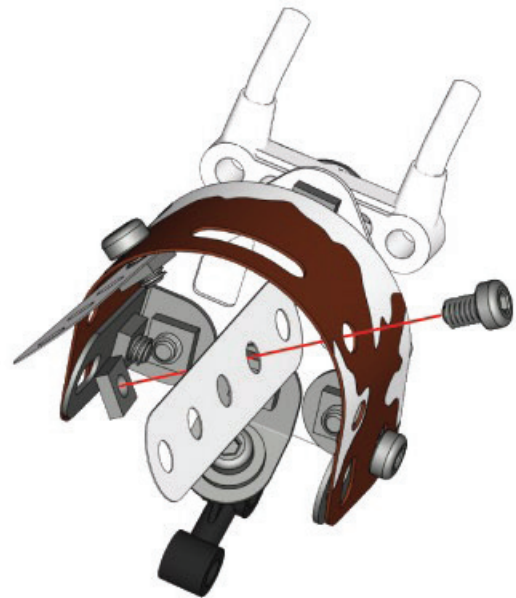

11

S1 5,8mm 15/64" **A637 (0037B) X 1**
A337 (0037A) X 1

S1 **1:1**



12

 5,8mm (15/64") **A637 (0037B) X1**
 **A337 (0037A) X1**

 **S1** **1:1**

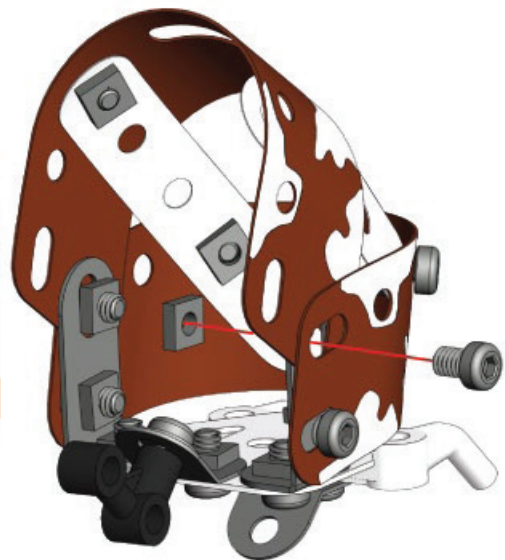





13

 5,8mm (15/64") **A637 (0037B) X1**
 **A337 (0037A) X1**

 **S1** **1:1**



14

 **A127 (0126A) X1**
 **A54B (0048E) X1**
 5,8mm (15/64") **A637 (0037B) X1**
 **A337 (0037A) X1**

 **S1** **1:1**

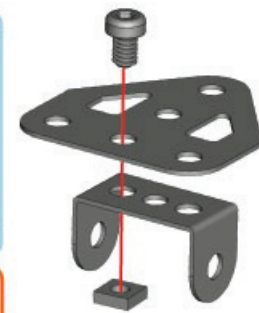

15 **13+14+**

 5,8mm (15/64") **A637 (0037B) X1**
 **A337 (0037A) X1**

 **S1** **1:1**

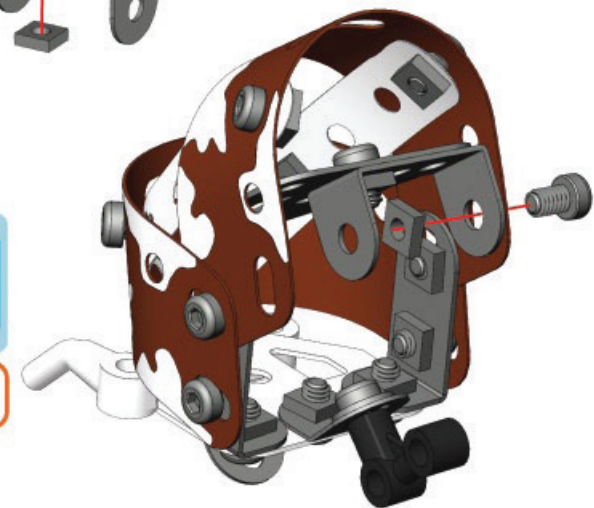

16

 **A417 (0225H) X1**
 23mm (9/32") **A347 (0147B) X1**
 **A238 (0028A) X2**
 **A737 (0037B) X1**

 **B3** **1:1**



17

- A338 (00300) X1
- 9,5mm 3/8" A511 (01192) X1
- A337 (00370) X1



18

- A621 (002030) X1
- 14,7mm 1/2" B1 A247 (01470) X1
- A238 (00300) X1
- A737 (00370) X1

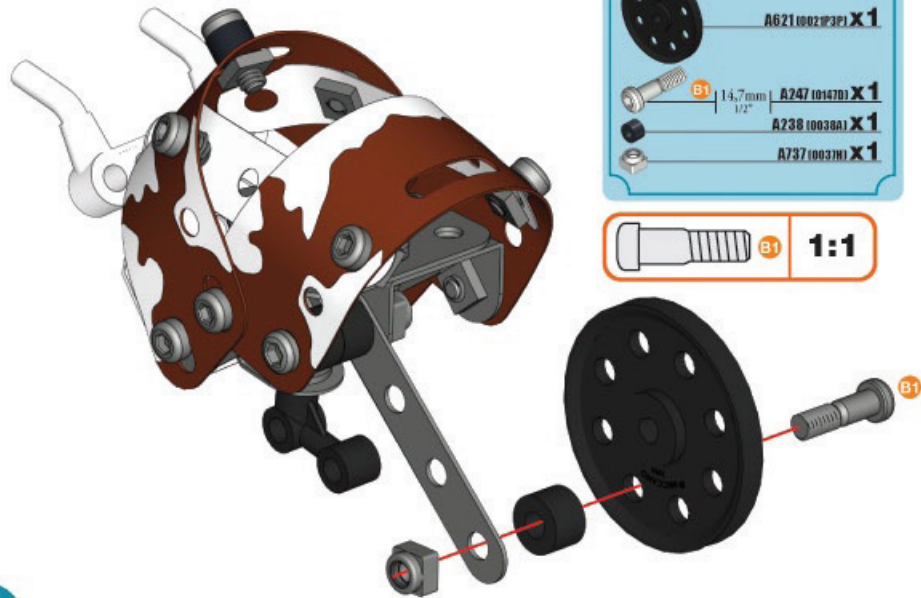

19

- A351 (00300) X1
- A812 (00120) X1
- 5,8mm 1/4" S1 A637 (00370) X1
- A337 (00370) X1

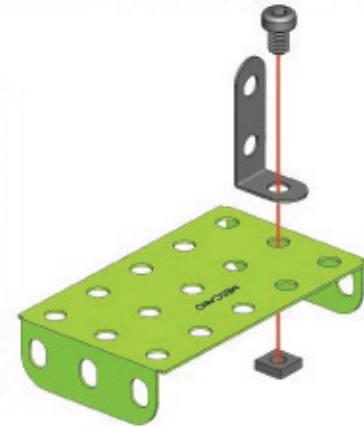

20

- A438 (00100) X1
- 5,8mm 1/4" S1 A637 (00370) X1
- A337 (00370) X1
- A138 (00300) X1

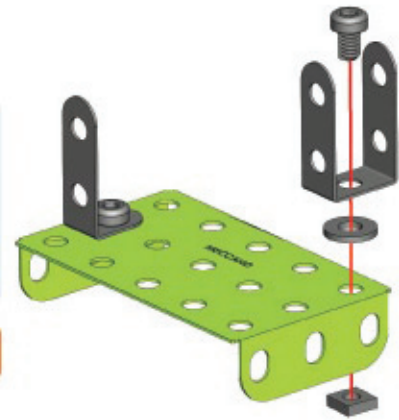

21

- A126 (00120) X1
- 5,8mm 1/4" S1 A637 (00370) X2
- A337 (00370) X2

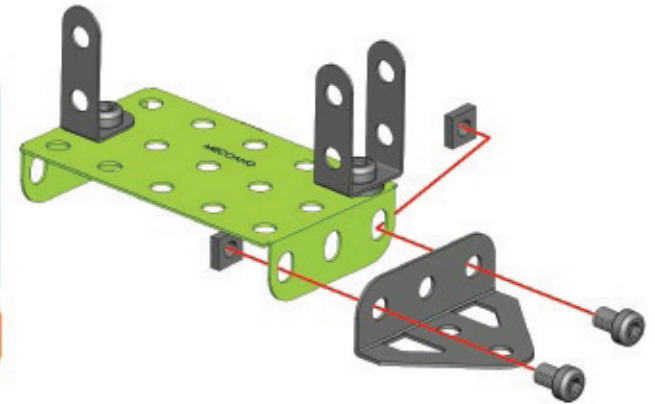

22 18+21+

-  B1 14,7mm | A247 (01470) X1
-  A737 (00370) X1

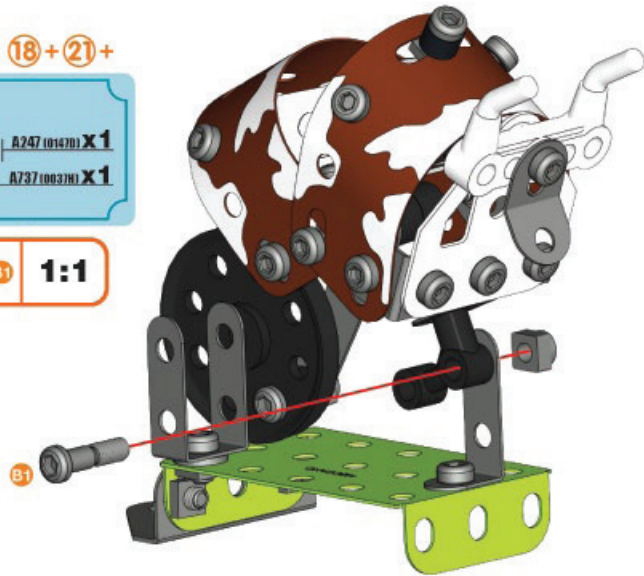



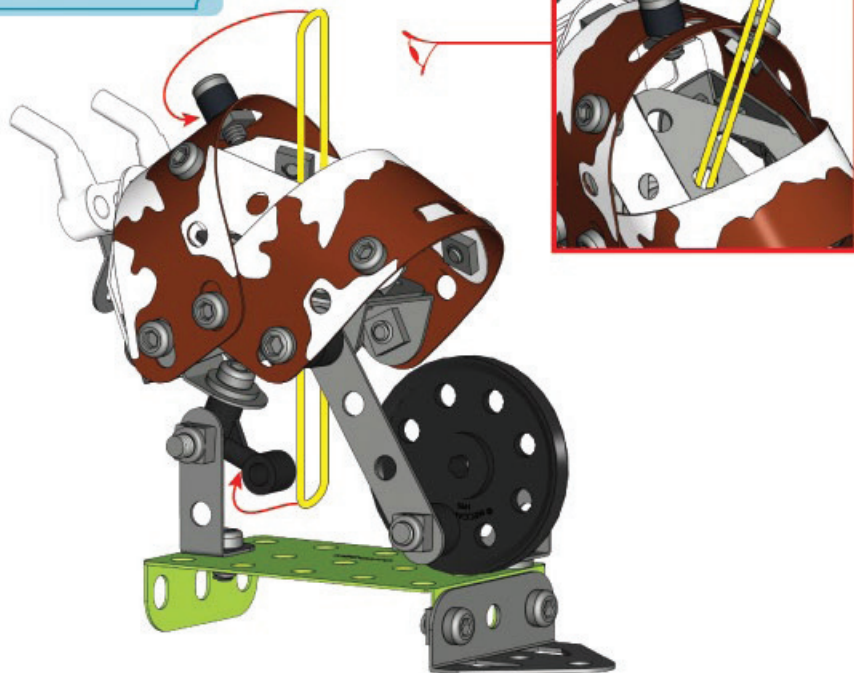

23

-  A696 (01060) X1

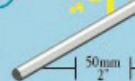

24

-  50mm | A317 (0317) X1
-  A238 (00280) X1
-  A338 (00380) X1
-  A259 (00590) X1

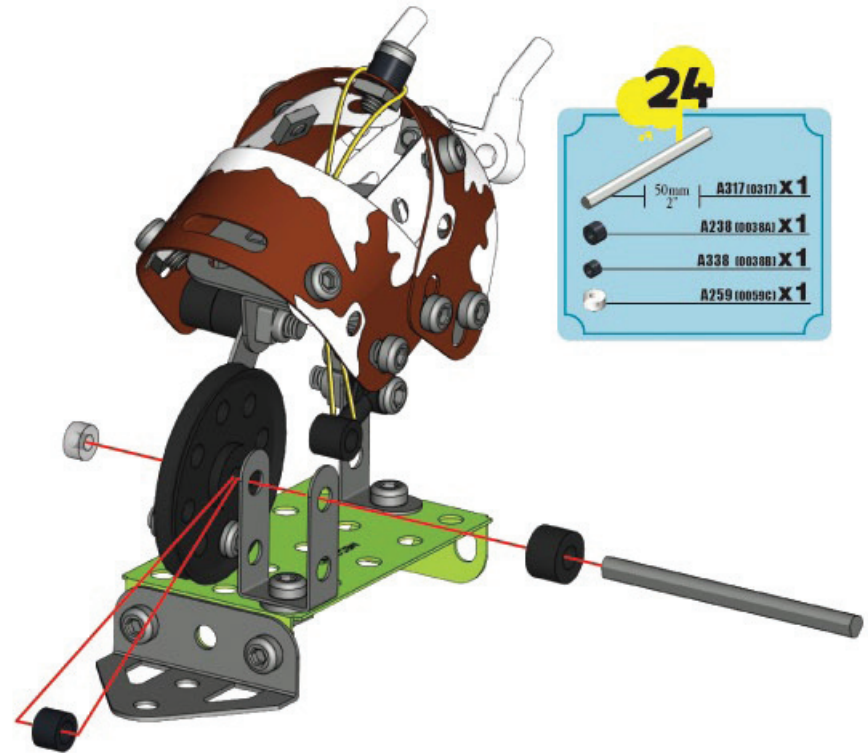

25

-  A372 (0072CP30) X1
-  44,5mm | C379 X1
-  A337 (00370) X2

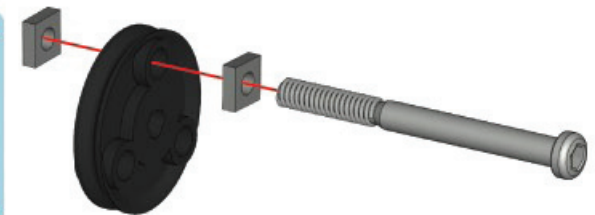

26 24+25+

A259 (0059c1) X1

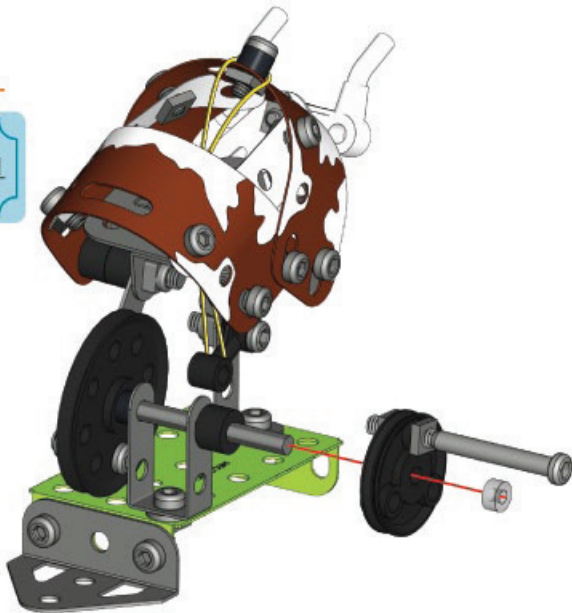

27

B684 X1
S148 X1

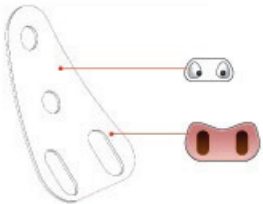

28 26+27+

A238 (0038a1) X1
S3 | 12mm | A411 (0111a1) X1
A337 (0037a1) X1

S3 1:1

