

Many of the models and component parts are unique and original designs which are the property of MECCANO. They are protected by national legislation as industrial designs, trademarks and/or copyrights throughout many countries. For detailed information, please contact: MECCANO. Meccano shall have no responsibility for (I) failure to follow instructions, (II) use of parts for any purpose other than as specified in the instructions (III) any alteration of any parts or components. MECCANO respects children's safety: all models are tested by children.

De nombreux modèles et pièces sont des créations originales, propriétés de MECCANO et sont protégés par les législations nationales sur les dessins et modèles, marques et/ou droits d'auteurs. Pour toute information, merci de contacter : MECCANO. La responsabilité de MECCANO ne saurait être engagée en cas d'accident survenu à la suite (I) du non respect des instructions de montage (II) d'une utilisation des pièces autre que celle proposée dans la notice (III) d'une altération ou de la modification des pièces. La société MECCANO respecte la sécurité des enfants : ses modèles sont testés par des enfants.

Zahlreiche Modelle und Teile sind Erfindungen und Eigentum der Firma MECCANO. Sie sind durch Inland-Gesetze über Zeichnungen und Modelle sowie Warenzeichen und/oder Urheberrechte geschützt. Für zusätzliche Auskünfte wenden Sie sich bitte an: MECCANO. Die Firma Meccano haftet nicht für Unfälle, die aus der (I) Nichtbeachtung der Bauanleitung, der (II) Verwendung anderer als in der Bauanleitung angegebenen Teile oder der (III) Änderung oder Modifikation der Teile resultieren. Alle Modelle der Firma Meccano wurden von Kindern getestet und entsprechen den Sicherheitsnormen.

Numerosi modelli e pezzi sono creazioni originali della MECCANO e sono protetti dalle legislazioni nazionali sui disegni e modelli, marchi e/o diritti d'autore. Per qualsiasi informazione, veuillez prendere contatto con: MECCANO. Meccano declina ogni responsabilità in caso d'incidenti sopravvenuti in seguito (I) al non rispetto delle istruzioni di montaggio (II) all'utilizzo dei pezzi per funzioni diverse da quelle previste nei manuali (III) all'alterazione e/o modifica dei pezzi. La società MECCANO rispetta la sicurezza dei bambini: i suoi modelli vengono testati dai bambini stessi.

Numerosas modelos y piezas son creaciones originales, propiedades de MECCANO y están protegidos por las legislaciones nacionales en lo que concierne a los dibujos y modelos, marcas y/o derechos de autor. Para cualquier información, sinsea ponerse en contacto con: MECCANO. MECCANO carece de responsabilidad en caso de accidente debido a: (I) el incumplimiento de las instrucciones de montaje (II) una utilización de las piezas diferente a la que se indica en las instrucciones (III) una alteración o modificación de las piezas. La sociedad MECCANO respeta la seguridad de los niños: sus modelos están probados por niños.

Vários modelos e peças são criações originais, propriedades da MECCANO e são protegidos pelas legislações nacionais relativas aos desenhos e modelos, às marcas e/ou aos direitos de autor. Para qualquer informação, é favor contactar: MECCANO. A Sociedade MECCANO não poderá ser responsabilizada pelos acidentes provocados: (I) pela falta do cumprimento das instruções de montagem (II) pelo uso indevido das peças ou (III) pela modificação ou alteração das peças. A Sociedade MECCANO respeita a segurança das crianças: os seus modelos foram testados por crianças.

Många modeller och delar bildar en unik och original formgivning vilken är MECCANO egendom. Dessa modeller och delar är skyddade genom lagstiftning såsom industriell formgivning, varumärke och/eller upphovsmanarätt i ett flertal länder. För mer detaljerad information, var vänlig och kontakta MECCANO. MECCANO fruktas sig allt annat i händelse av olycka till följd av (I) att monteringsinstruktionerna inte har respekterats (II) en annan användning av delarna än den som är i instruktionen (III) en förändring eller förändring av delarna. Företaget MECCANO respekterar barns säkerhet: modellerna har testats av barn.

Isolat mallit ja osat ovat MECCANO:n omaperäisiä luovia alkuperäisiä suunnitelmia. Ne ovat kansainvälillä lailla suojattuja teollista tavaramerkkejä ja/tai kopiointioikeuksia. Pyydämme ottamaan yhteyden MECCANO:han kaikissa osiaan liittyvissä kysymyksissä. MECCANO ei vastaa eikä kata seuraavista syistä sattuneita onnettomuuksia: (I) ohjeiden vastainen kokoaminen, (II) modien kein olemassa oloa muuttaminen osien käyttöä, (III) osien muuttamista tai eri tarkoituksiin käyttöä. MECCANO-yhtiön huolehtii lasten turvallisuudesta: lapset ovat testanneet mallin.

For mange modeller og dele er originale fremstillinger og ejes af MECCANO. Tegninger, modeller, fabrikationsmarkering og oplysninger er lovbeskyttet i hvert land. Yderligere oplysninger kan fås hos: MECCANO. MECCANO frægter sig alvnt ansvar, sáfremt der er sket uheld forårsaget af (I) at monteringsinstruktionerne ikke er blevet overholdt, (II) at delene er blevet brugt til andre formål, end dem der er beskrevet i beføjelsesvejledning, (III) eller at delene er blevet beskadiget eller ændret. MECCANO overholder sikkerhedsreglerne for børn. Alle modeller testes af børn.

Veel modellen en onderdelen zijn origineel ontworpen en eigendom van MECCANO en worden beschermd door de nationale wetgeving op tekeningen en modellen, merken en/of auteursrechten. Voor informatie gelieve contact op te nemen met MECCANO. De verantwoordelijkheid van MECCANO is uitgesloten in geval van ongelegen voorkomend uit het niet naleven van de montage-instructies (I), uit het gebruik van andere onderdelen dan die zoals vermeld in de handleiding (II) of uit het veranderen of modificeren van de onderdelen (III). De firma MECCANO neemt de veiligheid van de kinderen in acht: de modellen zijn door kinderen getest.

Πολλά μοντέλα και ανταλλακτικά είναι αυθεντικά, ιδιοκτησία της MECCANO και προστατεύονται από τις εθνικές νομοθεσίες για τα μοντέλα τα μάρκες ή τα δικαιώματα εφευρέτηρας Για κάθε πληροφορία παρακαλώ απευθυνθείτε στη MECCANO. Η ευθύνη της MECCANO δεν δεσμεύεται σε περίπτωση ατυχήματος που έγινε συνεχώς (I) μη σεβασμού των οδηγιών συναρμολόγησης (II) χρήσης των τεμαχίων διαφορετική από αυτήν που προτείνεται στις οδηγίες (III) καταστροφής ή αλλαγής των τεμαχίων. Η εταιρεία MECCANO σεβάζεται την ασφάλεια των παιδιών: τα μοντέλα της δοκιμάζονται από παιδιά.

モデラならびに部品は、その多くが MECCANO 社所有のオリジナル「デザイン」であり、商標および/または著作権に関する各国国内法によって保護されています。また/または (I) 組立の注意事項を守らなかった場合、(II) 使用説明書に記載されたもの以外の部品を使用し、(III) 部品を壊す、変形させた場合などによる事故については責任を負うことはできません。メカ/社の全モデルは事前に子供たちによりテストを行い、その安全性を確認してあります。

Instructions
Notice de montage
Bauanleitung
Istruzioni di montaggio
Instrucciones de montaje
Instruções de montagem
Monteringsanvisning
Kokamisohje
Monteringsinstruktioner
Montageanleitung
Οδηγίες συναρμολόγησης
組立説明書



Made in China for / Fabriqué en Chine pour / Fabricado en China por:



363, avenue de Saint Exupéry
62100 Calais - France
<http://www.meccano.com>
<http://www.erektor-sets.com>
© 03/2009 MECCANO

MECCANO and EREKTOR are exclusive trademarks of MECCANO
All rights reserved



843710 DM 111



★ 8-15

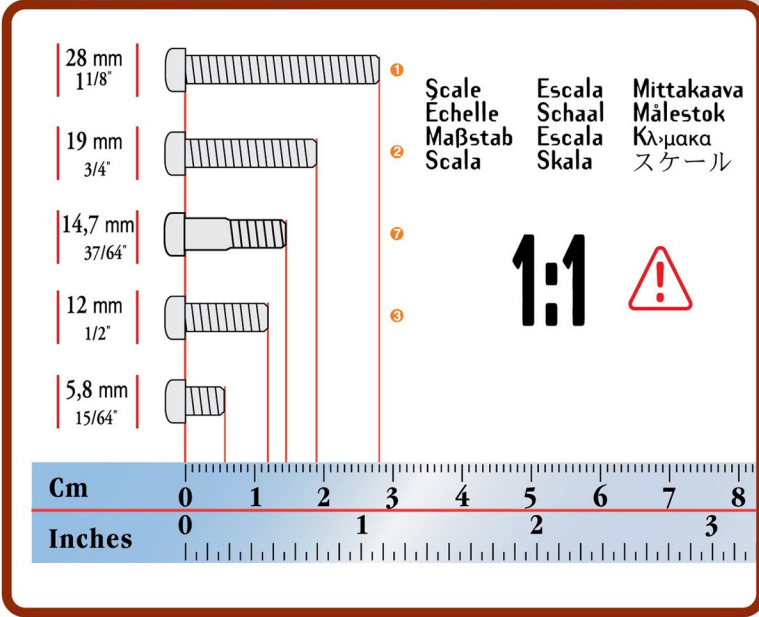
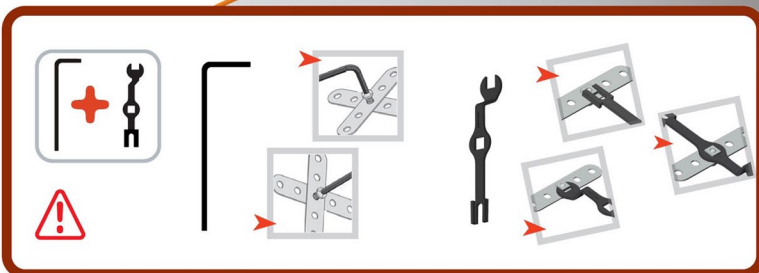

B889 x2	(B01) A801 x1
B484 x2	B884 x2
B572 x2	(12B) A512 x1
(235B) A414 x2	(B12C) A437 x1
(23B) A236 x2	(48B) A548 x1
(000B) B148 x1	(260B) A418 x1
(133C) A233 x2	(12) A012 x2
(187B) A587 x2	(12C) A712 x7
(142P) A388 x2	(38A) A238 x8
	(38B) A338 x3
	(37H) A737 x3
	(37A) A337 x30
	(3B) A138 x5

1 28 mm 1 1/8"	(111D) A611 x2	6 12 mm 1/2"	(111A) A411 x5
2 19 mm 3/4"	(111) A911 x2	7 5,8 mm 15/64"	(37B) A837 x18
7 14,7 mm 37/64"	(147D) A247 x2	8 5,8 mm 15/64"	(37B) A637 x2





1

- x1
- x1
- x1
- x1
- x1
- x2
- x1

2

- x1
- x2
- x4

3 ①+②+

- x2
- x2
- x2
- x2
- x1
- x3
- x2

4

- x1
- x1
- x1
- x1
- x2
- x2
- x1

5

- x1
- x1
- x1
- x1
- x2
- x2
- x1

6 ③+④+

- x1
- x1
- x1
- x1

8

- x2
- x1
- x2
- x2

7 ⑤+⑥+

- x1
- x1
- x1

9

- x1
- x4
- x4

10

- x1
- x2
- x1
- x1
- x2
- x2
- x1

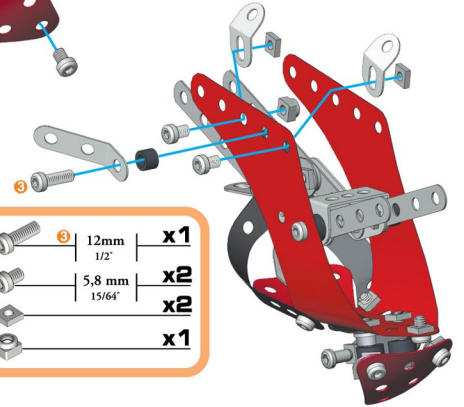
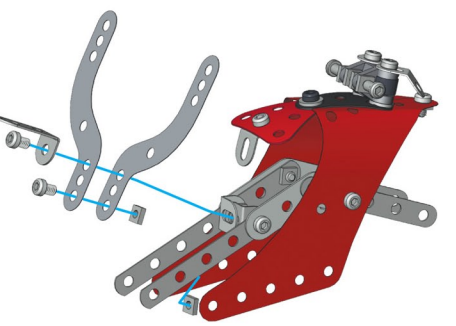
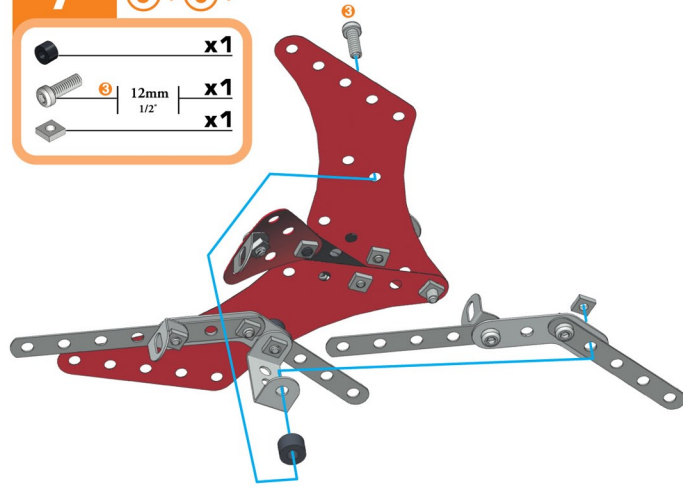

11

	x1
	x2
	x2
	x2
	x2

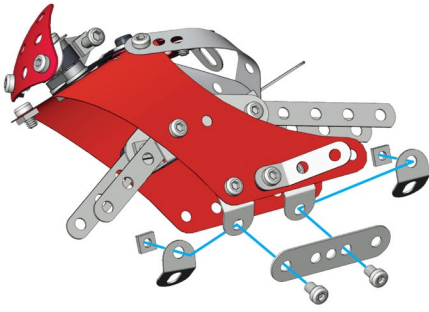

14

	x1
	x2
	x2
	x2

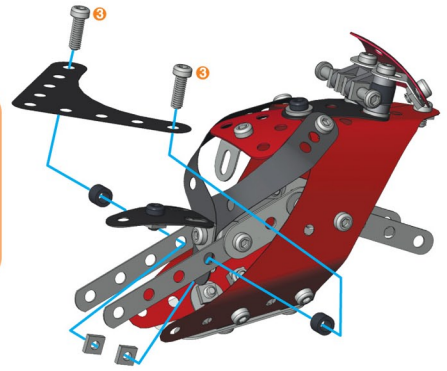

12

	x2
	x2

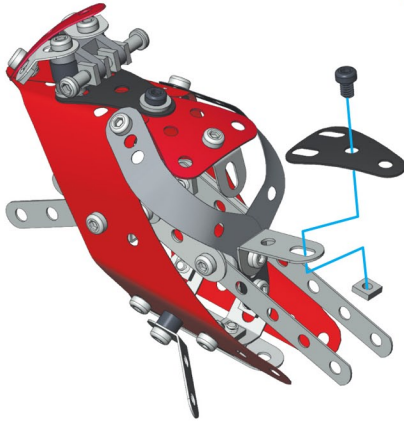
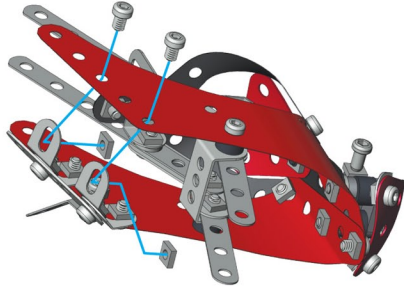

13

	x1
	x1
	x1

15

	x2
	x2
	x2
	x4
	x2

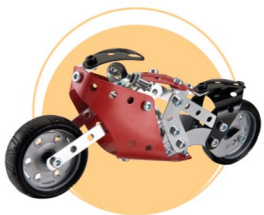
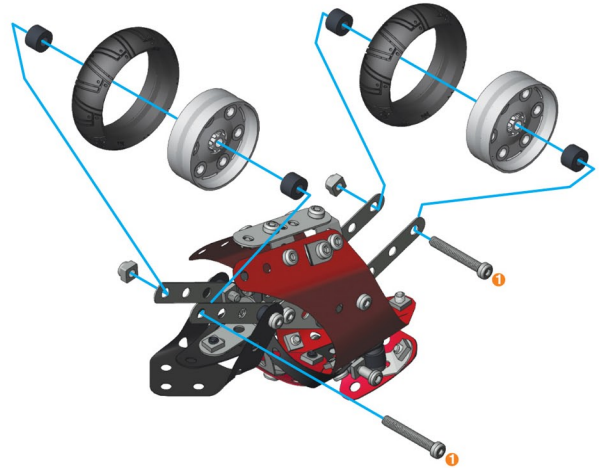

1

	x1
	x1
	x1
	x1
	x1
	x2
	x2

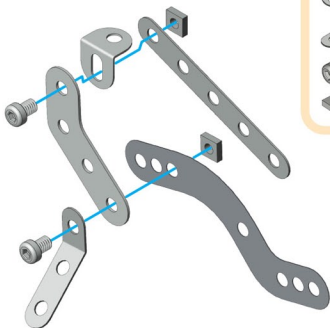

2

	x1
	x1
	x1
	x1
	x2
	x2

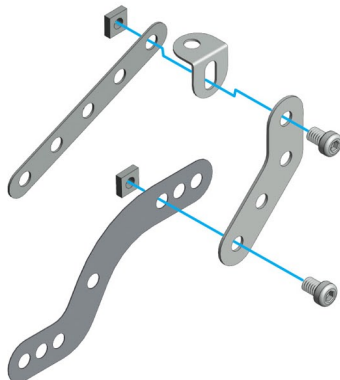

3 ①+②+

	x2
	x1
	x3
	x3

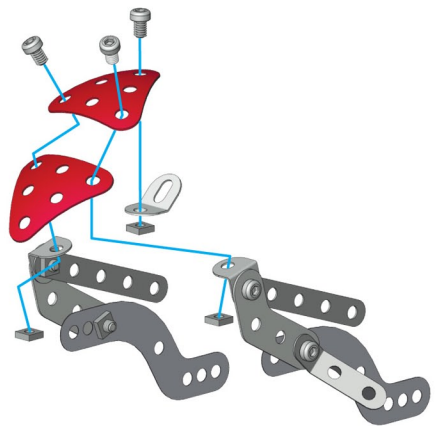



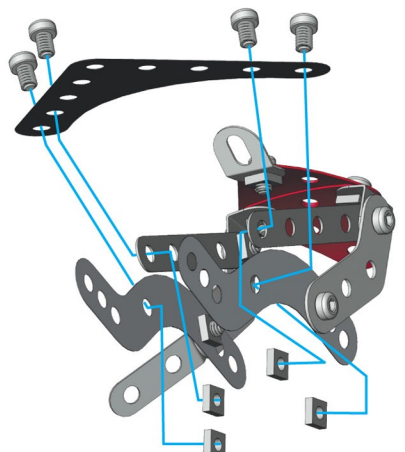
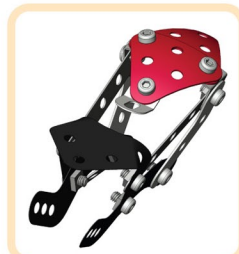

4

	x1
	x4
	x4



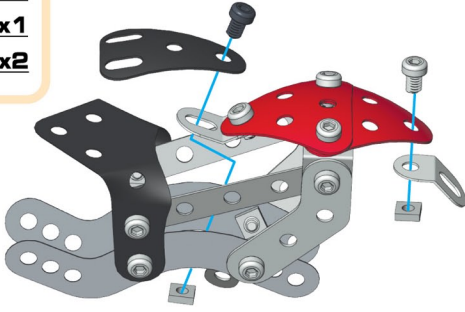

5

-  x1
-  x1
-  5,8 mm 15/64" x1
-  5,8 mm 15/64" x1
-  x2





7

5+6+

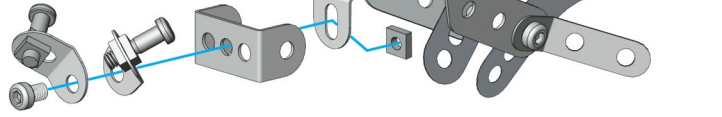
-  x1
-  5,8 mm 15/64" x1
-  x1



6







-  x2
-  14,7 mm 37/64" x2
-  x4



X2=





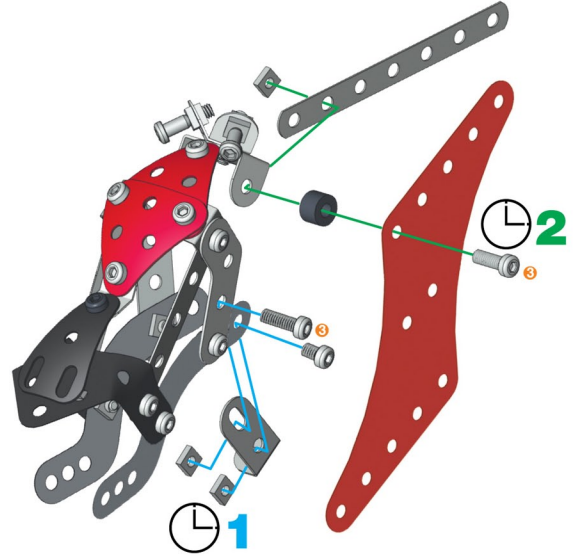

8

-  x1
-  x1
-  x1
-  x1
-  12mm 1/2" x2
-  5,8 mm 15/64" x1
-  x3





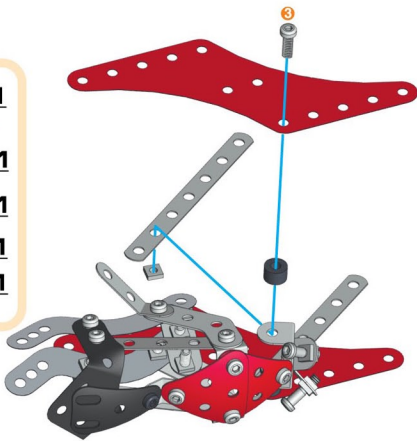

9

-  x1
-  x1
-  x1
-  12mm 1/2" x1
-  x1



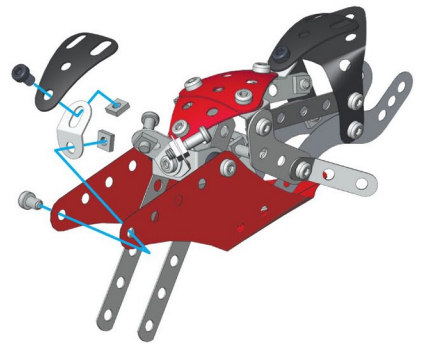

11

-  x1
-  x1
-  5,8 mm 15/64" x1
-  5,8 mm 15/64" x1
-  x2



10

-  5,8 mm 15/64" x3
-  5,8 mm 15/64" x3

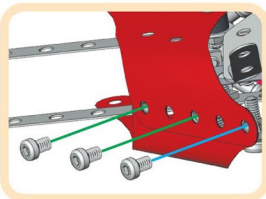
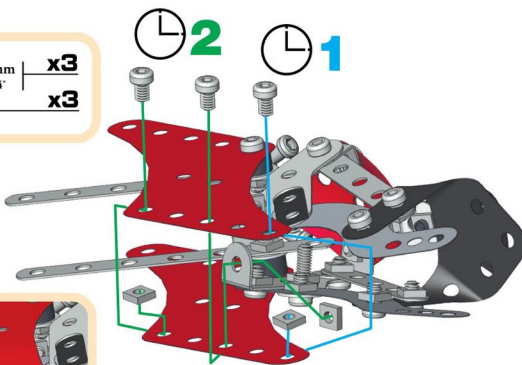

12

-  x2
-  x2
-  28mm 1 1/8" x2
-  x4
-  x2
-  x2

