

Special Edition™

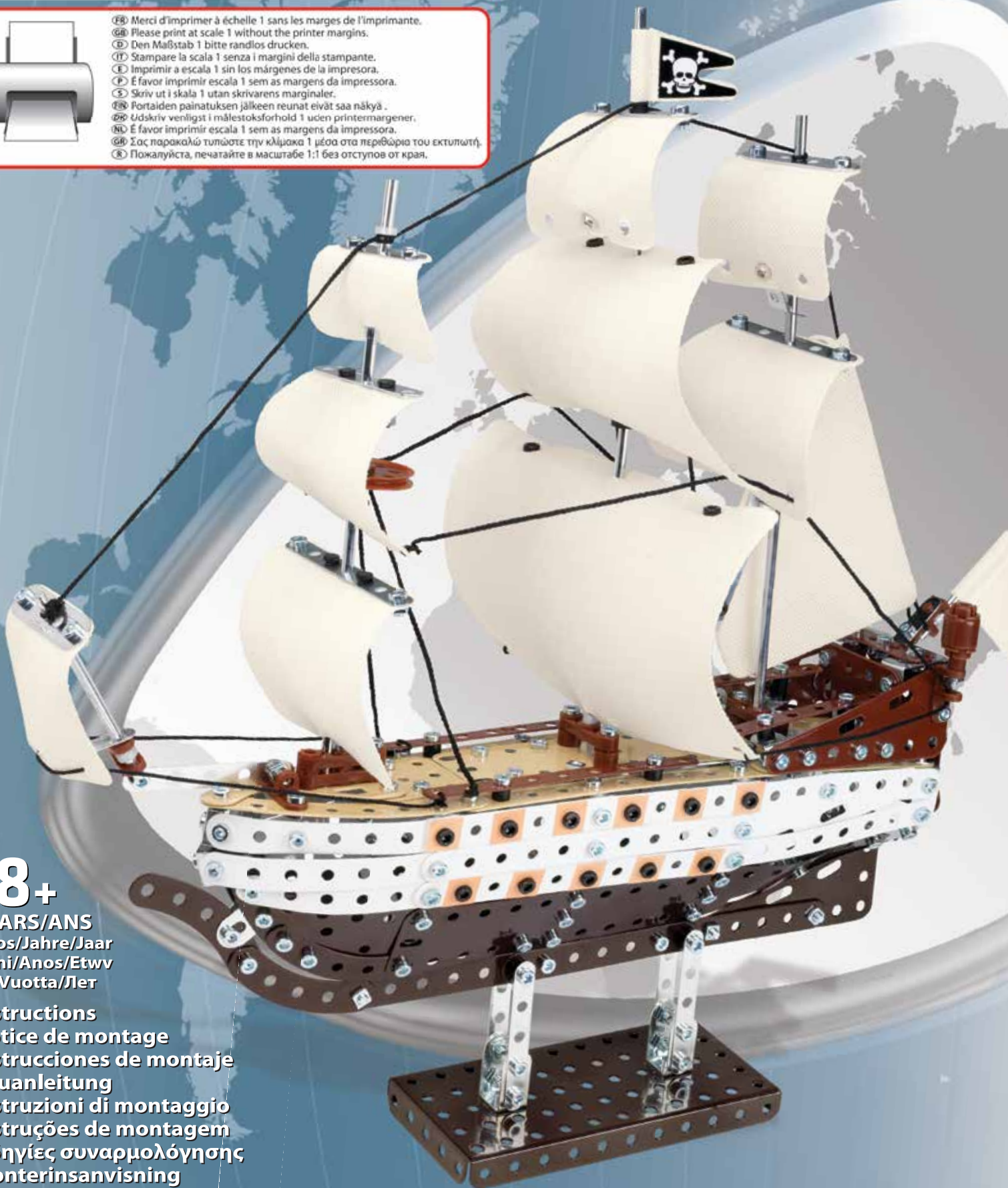

- Ⓜ Merci d'imprimer à échelle 1 sans les marges de l'imprimante.
- Ⓜ Please print at scale 1 without the printer margins.
- Ⓜ Den Maßstab 1 bitte randlos drucken.
- Ⓜ Stampare la scala 1 senza i margini della stampante.
- Ⓜ Imprimir a escala 1 sin los márgenes de la impresora.
- Ⓜ É favor imprimir escala 1 sem as margens da impressora.
- Ⓜ Skriv ut i skala 1 utan skrivarens marginaler.
- Ⓜ Portaiden painatuksen jälkeä reunat eivät saa näkyä.
- Ⓜ Udskriv venligst i målestoksforhold 1 uden printermargener.
- Ⓜ É favor imprimir escala 1 sem as margens da impressora.
- Ⓜ Σας παρακαλώ τυπώστε την κλίμακα 1 μέσα στα περιθώρια του εκτυπωτή.
- Ⓜ Пожалуйста, печатайте в масштабе 1:1 без отступов от края.



8+

YEARS/ANS

Años/Jahre/Jaar

Anni/Anos/Etwv

År/Vuotta/Лет

Instructions

Notice de montage

Instrucciones de montaje

Bauanleitung

Istruzioni di montaggio

Instruções de montagem

Οδηγίες συναρμολόγησης

Monteringsanvisning

Kokoamisohje

Monteringsinstruktioner

Montagehandleiding

Инструкции

CONSTRUCTION TIPS
ASTUCES DE CONSTRUCTION
CONSEJOS DE CONSTRUCCIÓN
TIPPS ZUM BAUEN
MONTAGETIPS
SUGGERIMENTI PER COSTRUIRE
DICAS DE MONTAGEM
ΣΥΜΒΟΥΛΕΣ ΚΑΤΑΣΚΕΥΗΣ
BYGGTIPS
BYGGTIPS
KOKOAMISONJE
РЕКОМЕНДАЦИИ ПО СБОРКЕ

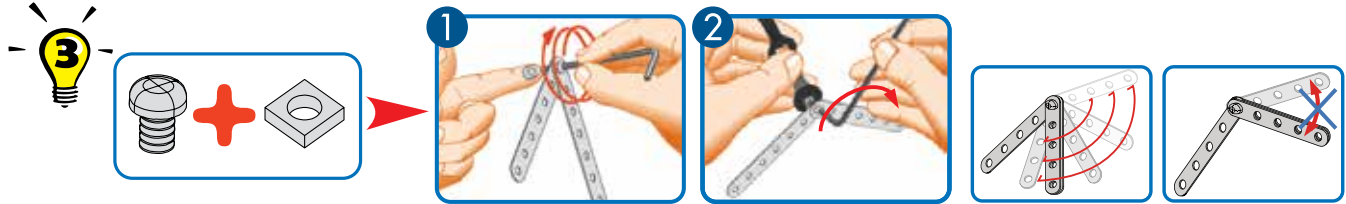
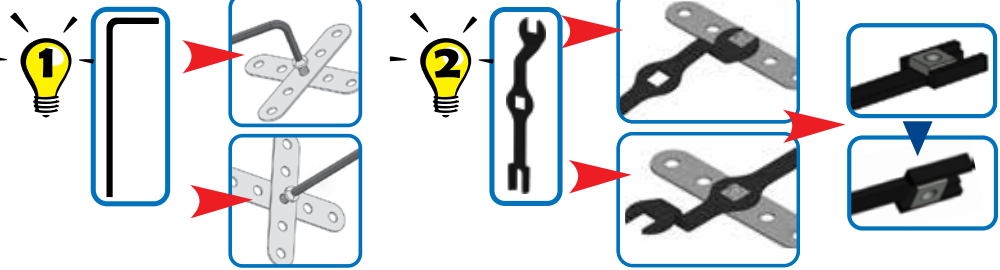

GB : Bend the spring steel parts, they will return to their original position.

F : Déforme les pièces en acier ressort, elles retrouvent leur position initiale.

D : Verbiege die Teile aus Federstahl, sie nehmen wieder ihre ursprüngliche Stellung ein.

I : Deformati i pezzi in acciaio elastico ritrovano la loro posizione iniziale.

E : Deforma las piezas de acero muelle, que recuperan su posición inicial.

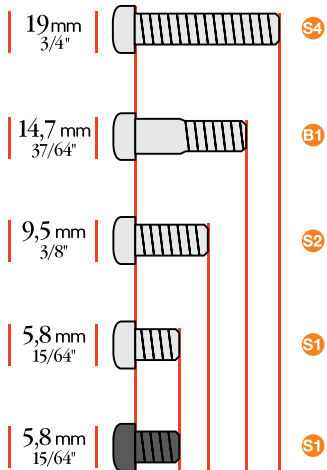

Scale 1 **Schaal 1** **Skala 1**
Échelle 1 **Scala 1** **Skala 1**
Escala 1 **Escala 1** **Mittakaava 1**
Maßstab 1 **Κλίμακα 1** **Ματρωτάβε 1**

1:1

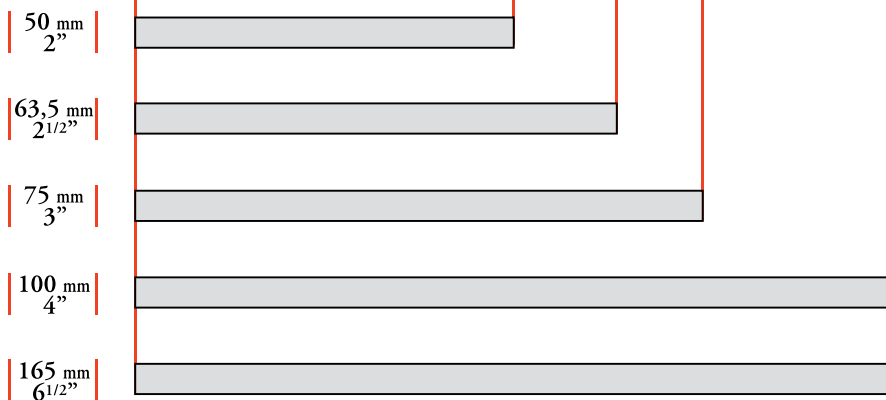

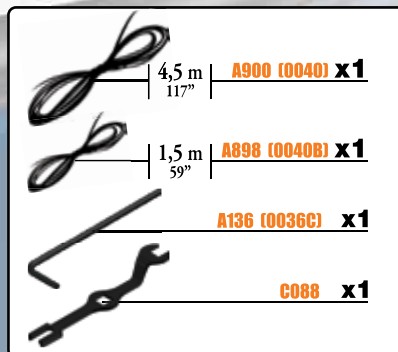
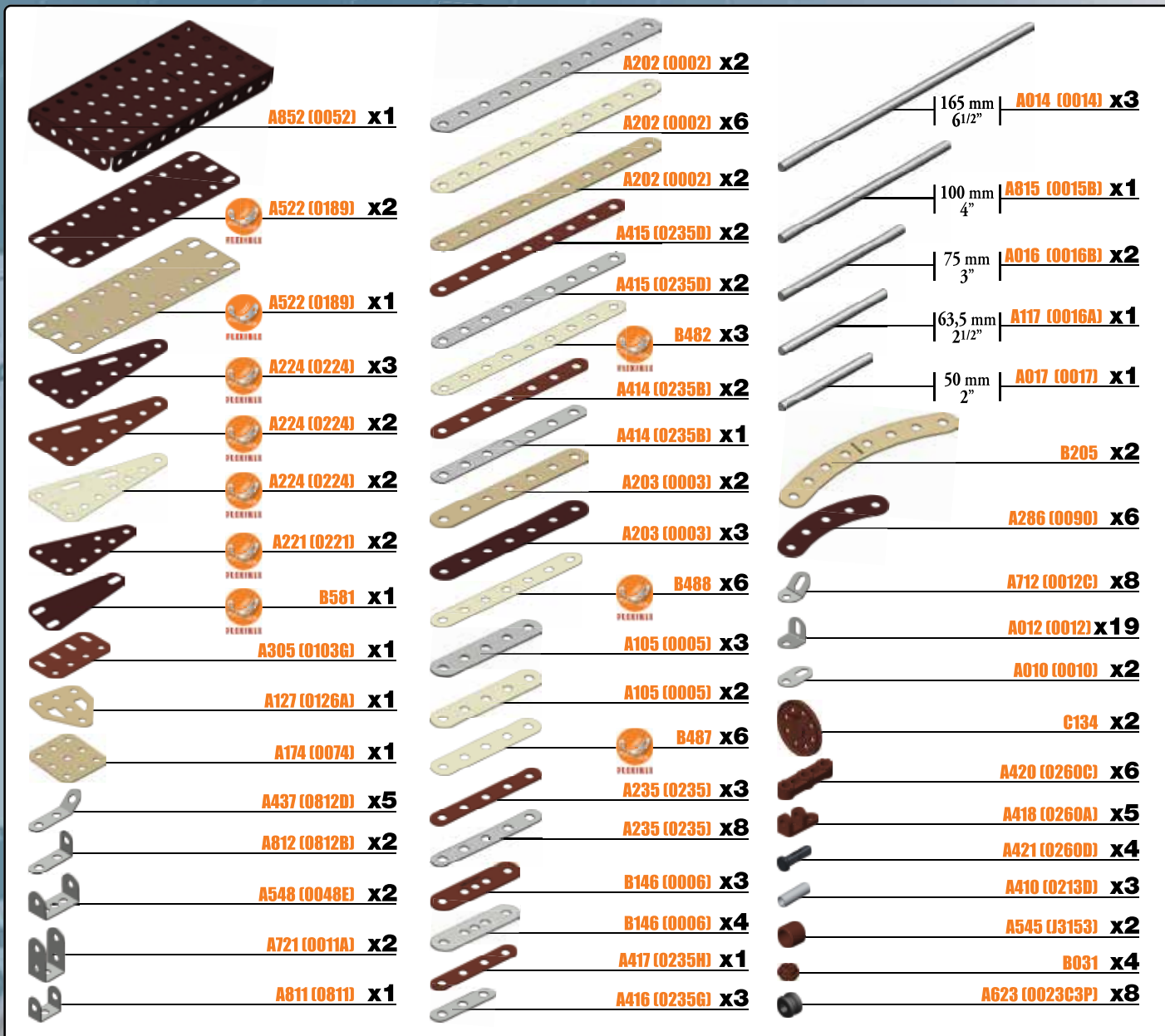



1

	x2		x2
	x2		x1
	x2		x1
	x2		x2

	1:1
	1:1

⚠ Scale 1 Schaal 1 Skala 1
 Echelle 1 Scala 1 Skala 1
 Escala 1 Escala 1 Mittakaava 1
 Maßstab 1 Μέτρο 1 Масштаб 1

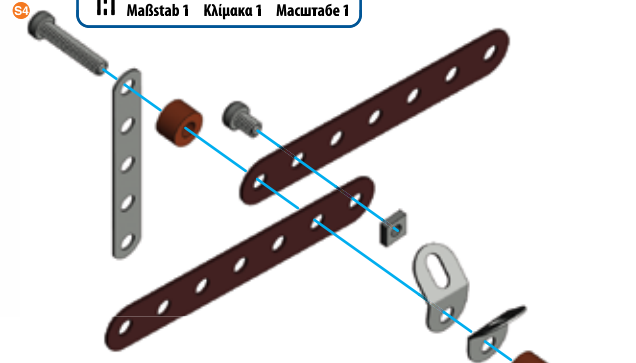

2

	x1
	x2
	x2
	x2
	x1
	x1
	x2

	1:1
	1:1

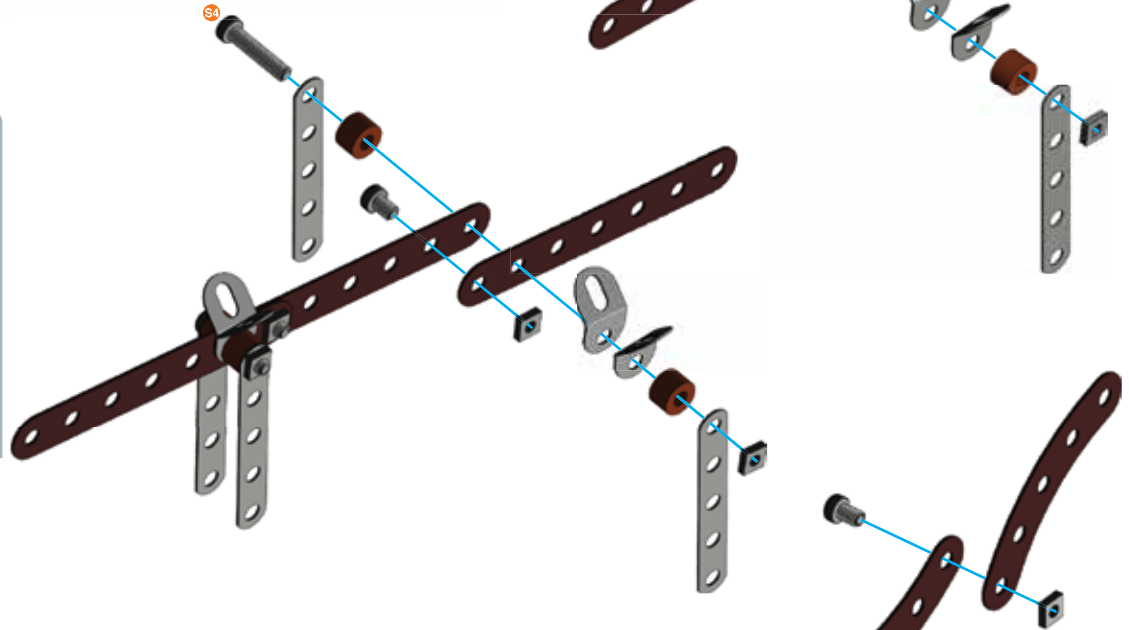

3

	x2
	x2
	x2

	1:1
--	------------



4

4

	x1
	x2
	x2
	x2

	1:1
--	------------

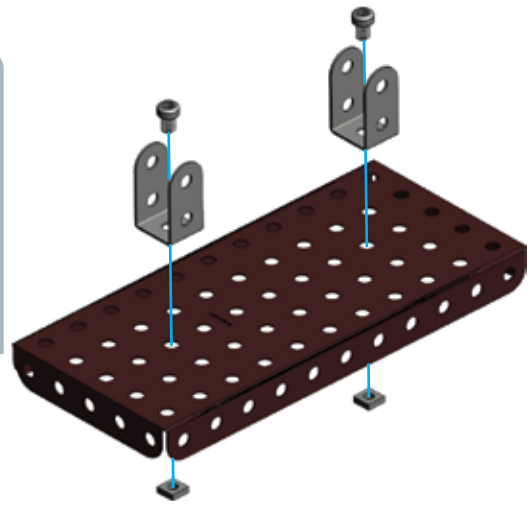

5 ③+④+

	x4
	x4

	1:1
--	------------

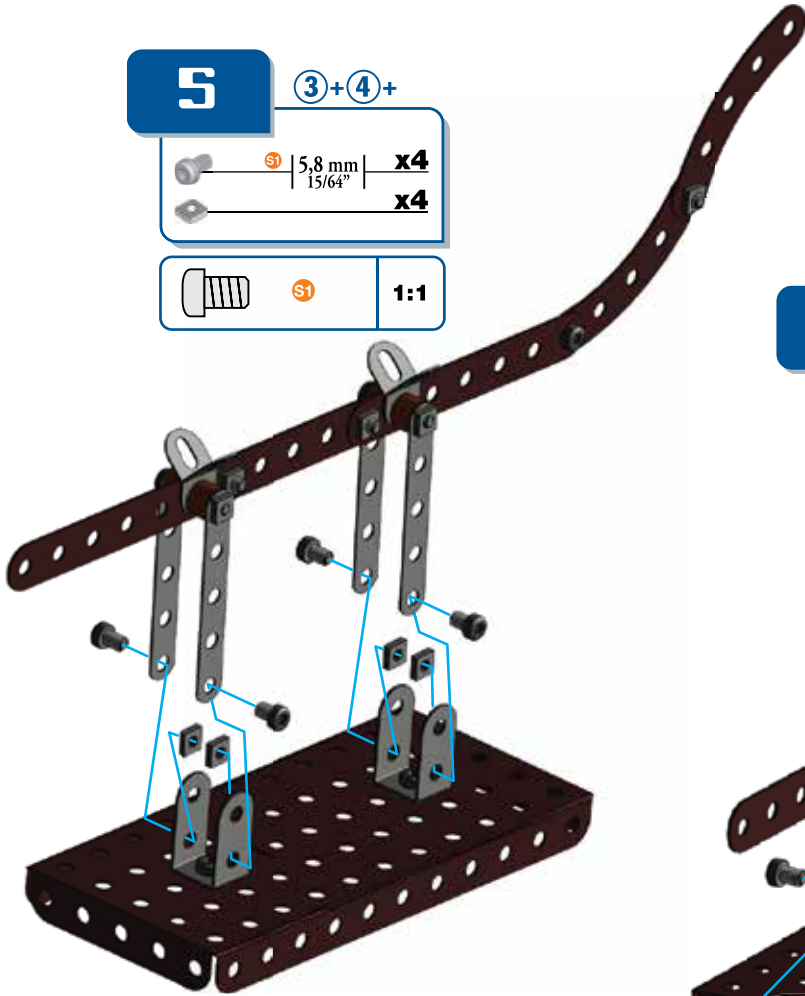

6

	x4
	x4

	1:1
--	------------

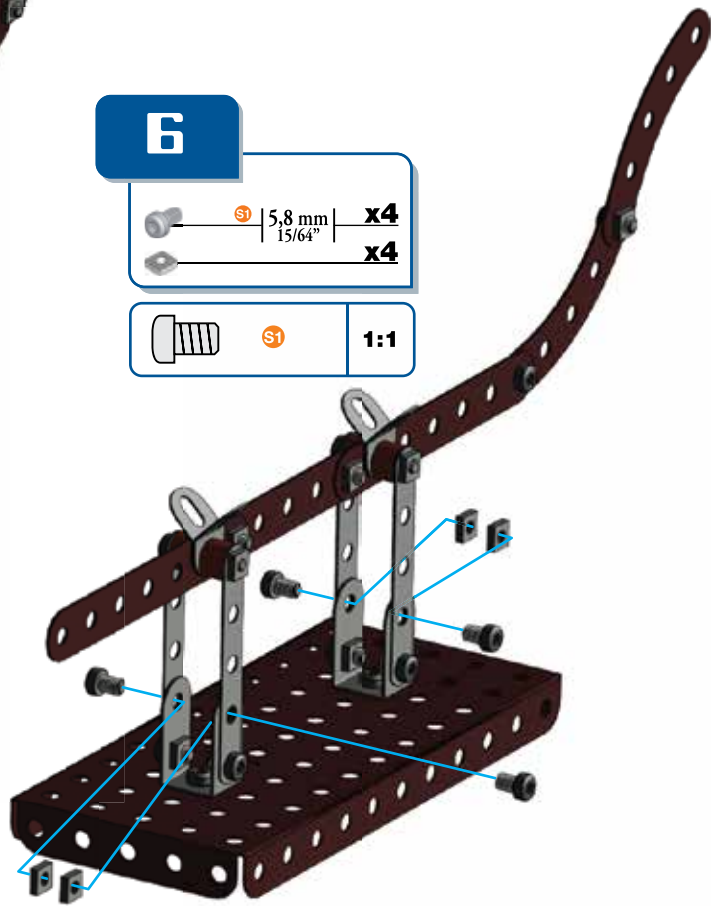

?

	x1
	x1
	x1
	x2
	x2

	1:1
--	------------

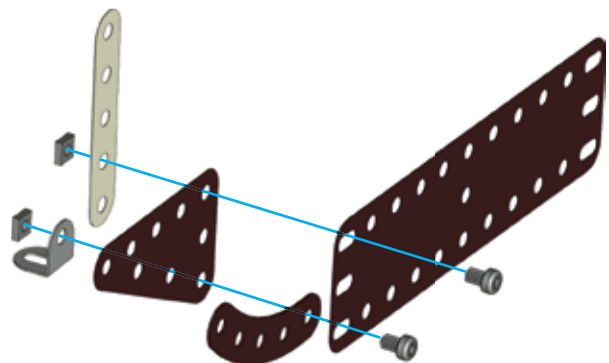

8

	x1		x1
	x1		x1
	x1		x6
		5,8 mm 15/64"	x6

	S1	1:1
--	-----------	------------

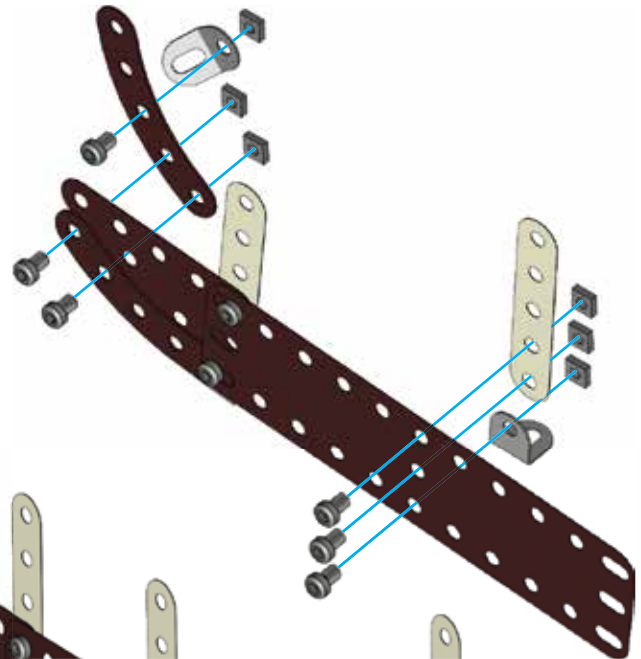
**9**

	x1		x1
	x1		x1
	x1		x4
		5,8 mm 15/64"	x4

	S1	1:1
--	-----------	------------

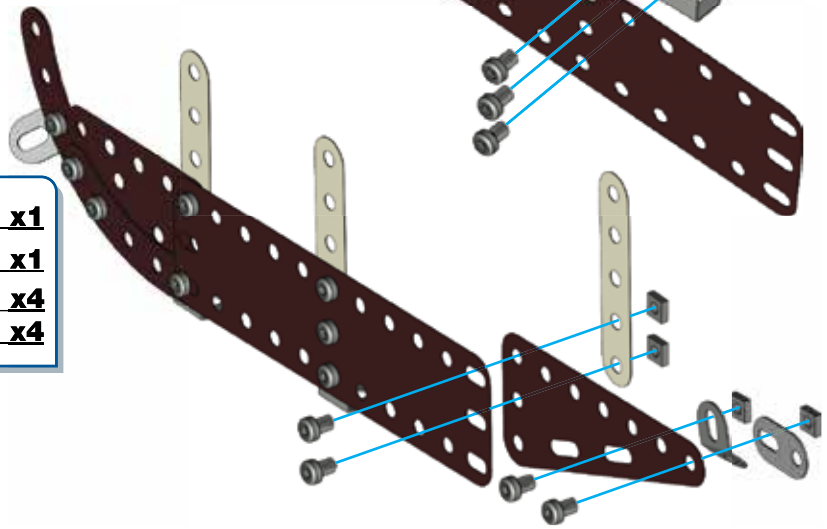
**10****6+9+**

	S1	5,8 mm 15/64"	x2
			x2

	S1	1:1
--	-----------	------------

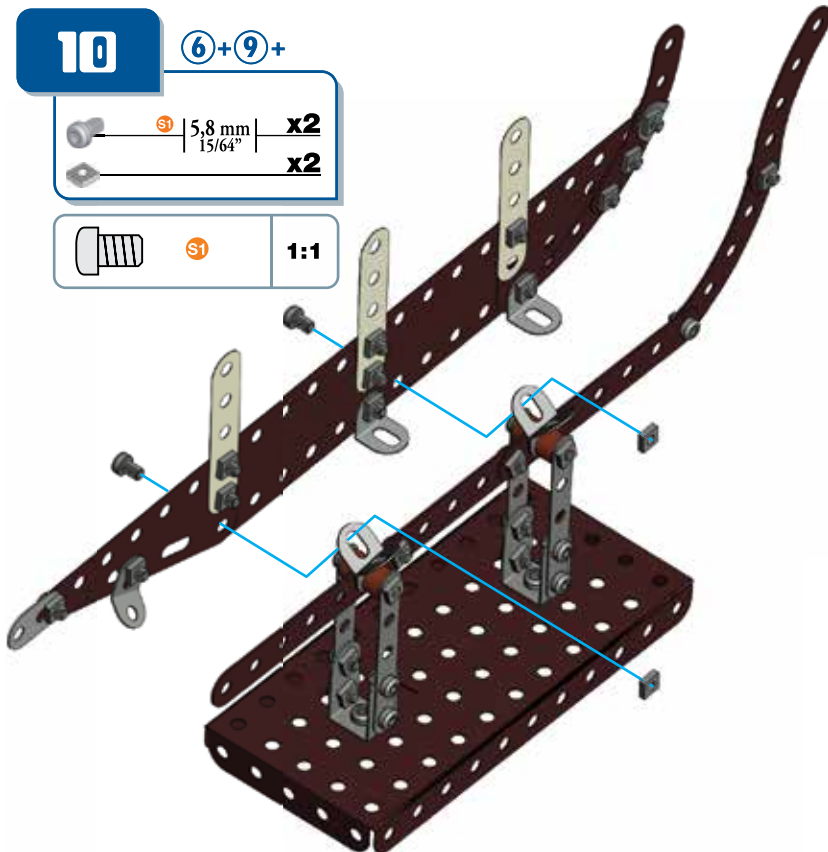
**11**

		x1
		x1
		x1
		x1
		x1
	S1	5,8 mm 15/64"
		x4
		x4

	S1	1:1
--	-----------	------------

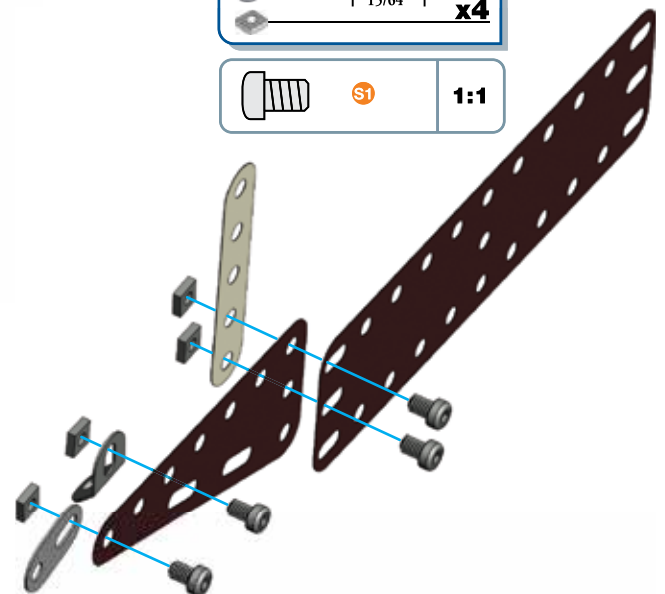
**6**

12 (10+11)+

	x1
	x1
	x1
	x3
	x3
	x3

	S1	1:1
--	----	-----

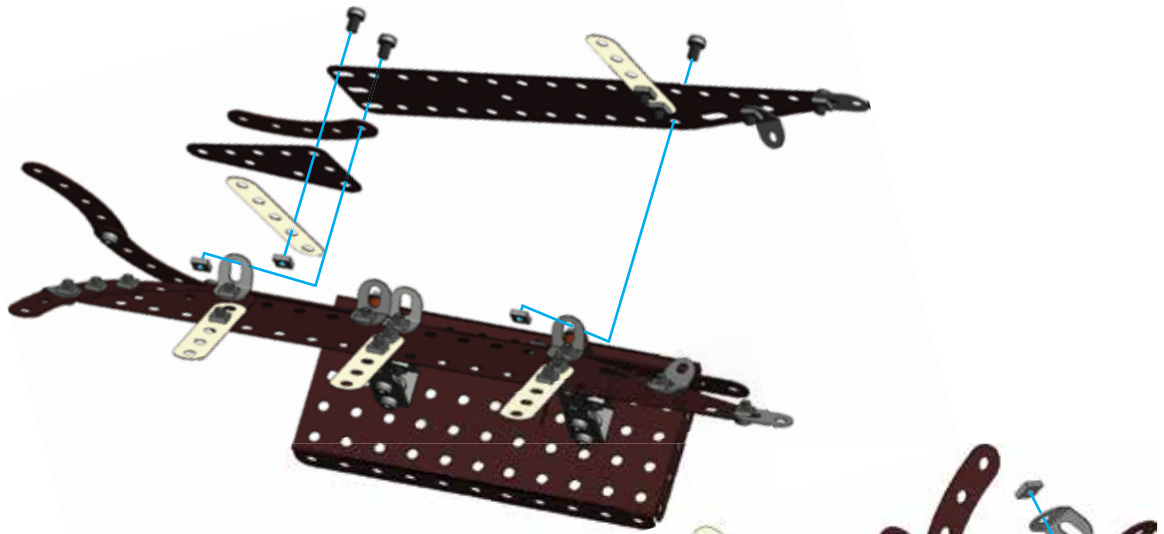

13

	x1
	x1
	x2
	x2

	S1	1:1
--	----	-----

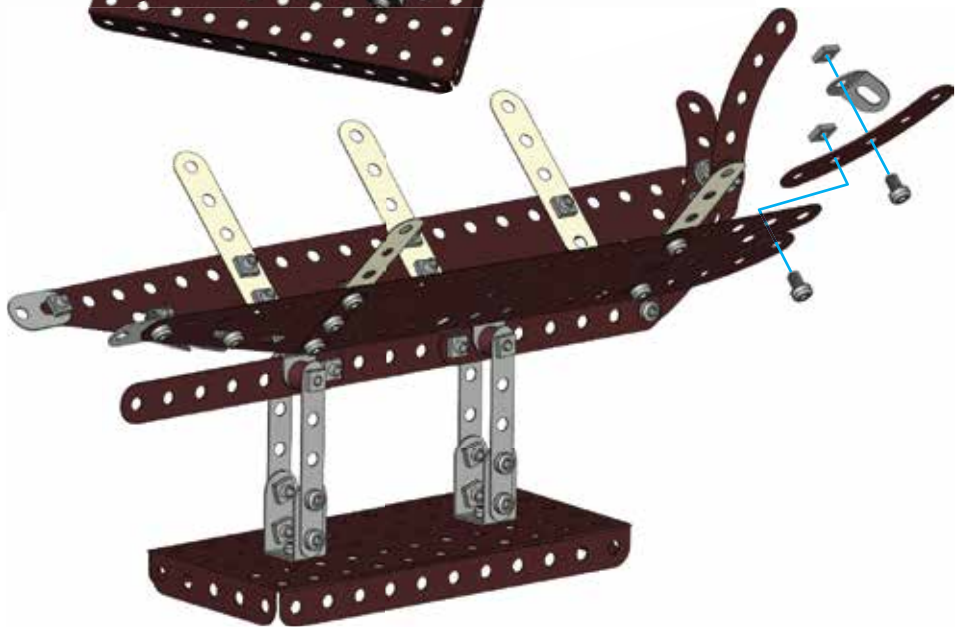

14

	x1
	x1

	S1	1:1
--	----	-----



15

	x1
	x4
	x4
	x4

	S1	1:1
--	----	-----

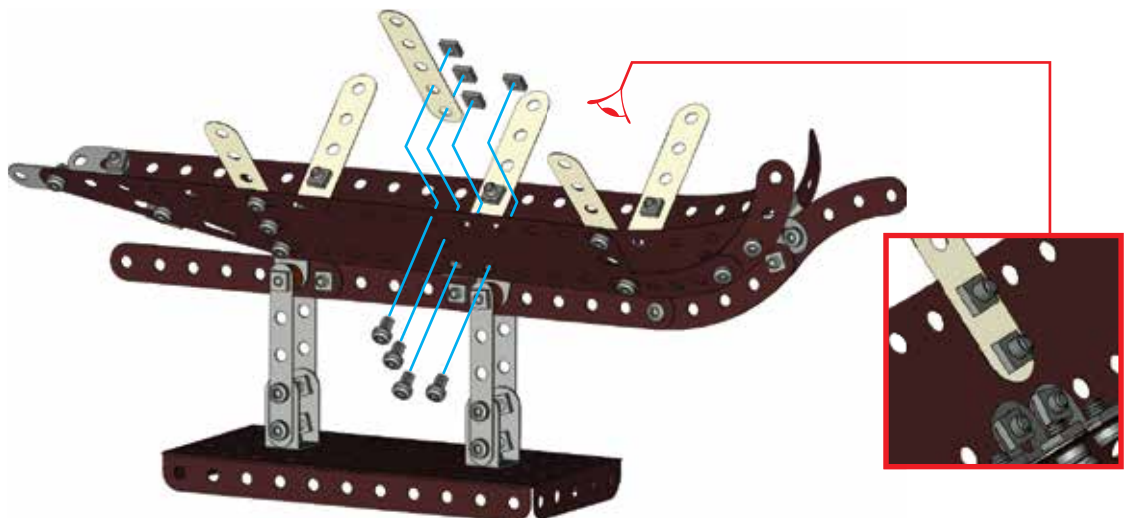

?

16

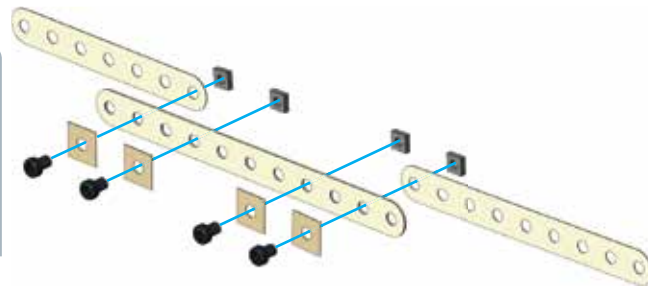
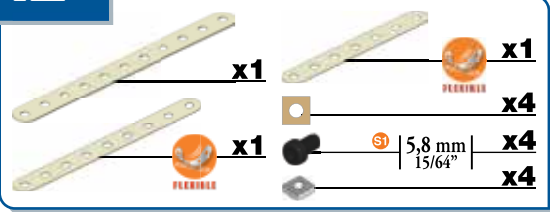

17

15+16+

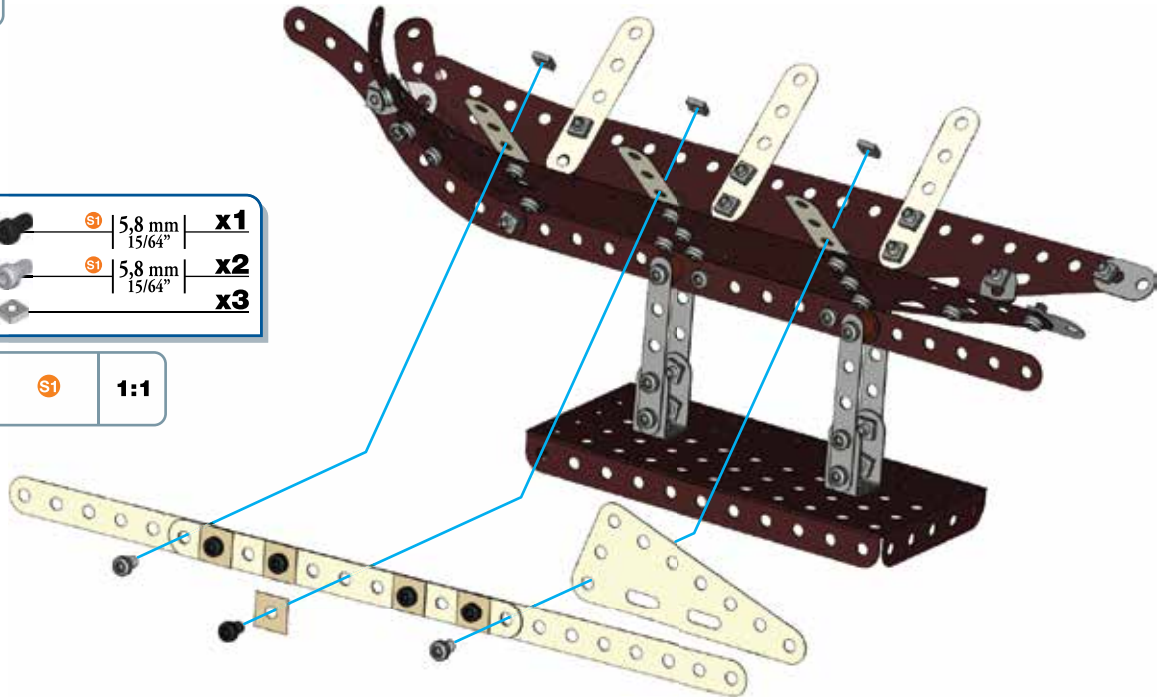
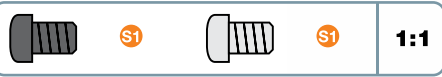
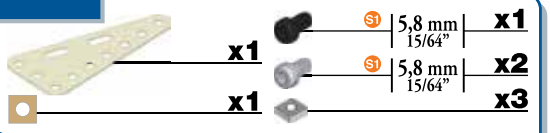

18

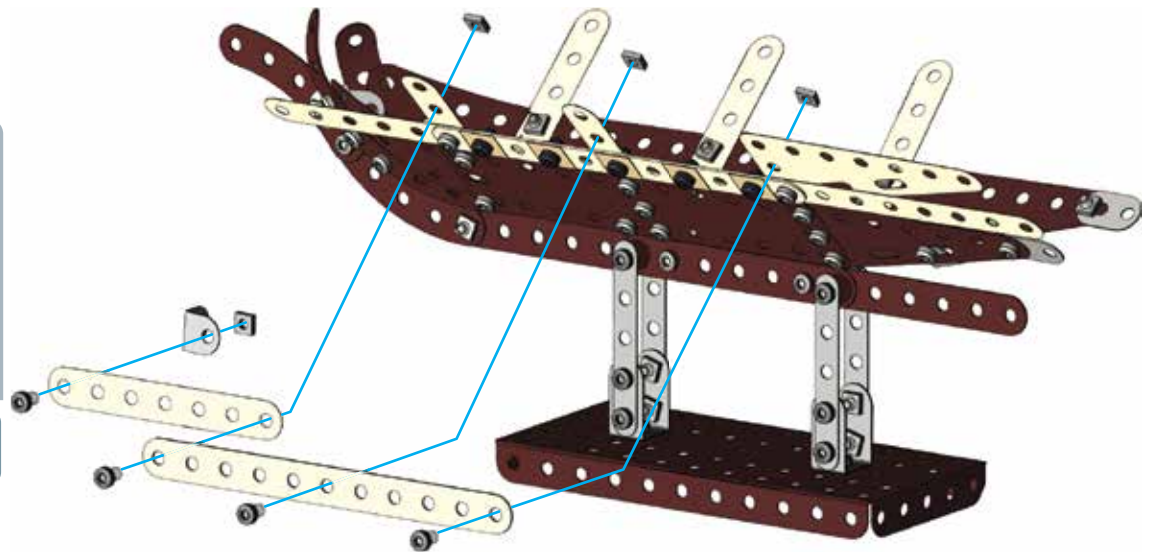
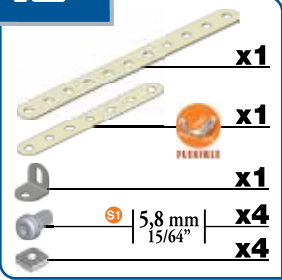



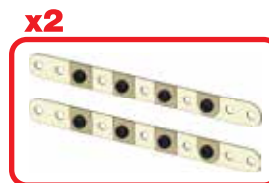
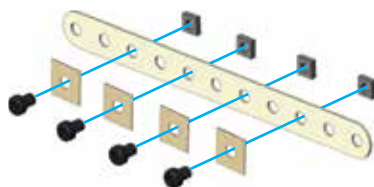
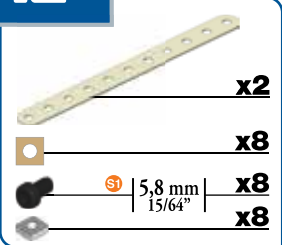

19



20

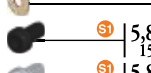

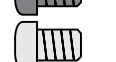

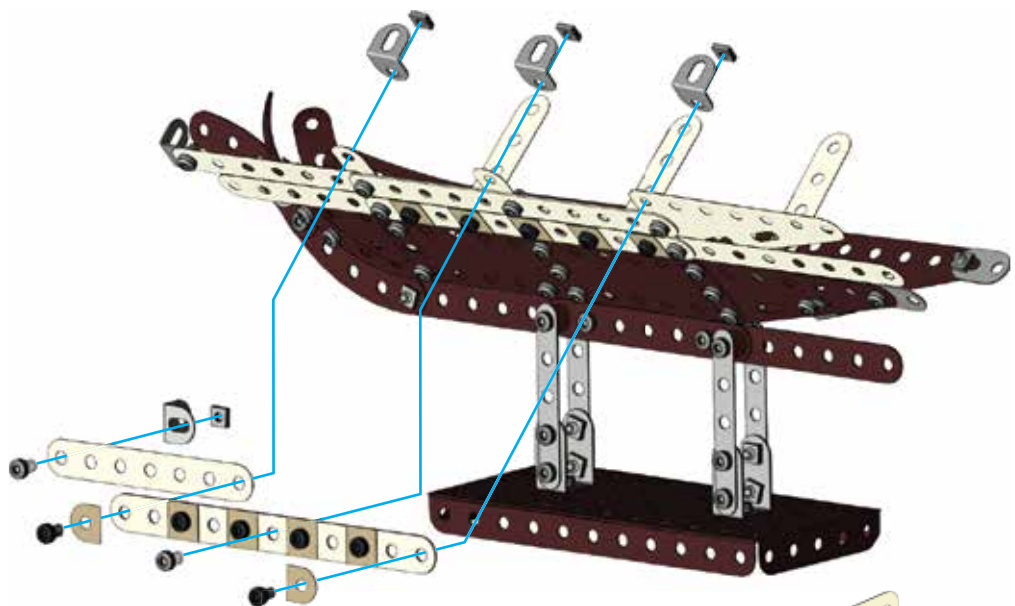

18+19+

-  **x1**
-  **x4**
-  **x2**
-  5,8 mm | 15/64" **x2**
-  5,8 mm | 15/64" **x2**
-  **x4**

-  **S1**
-  **S1**
- 1:1**



21



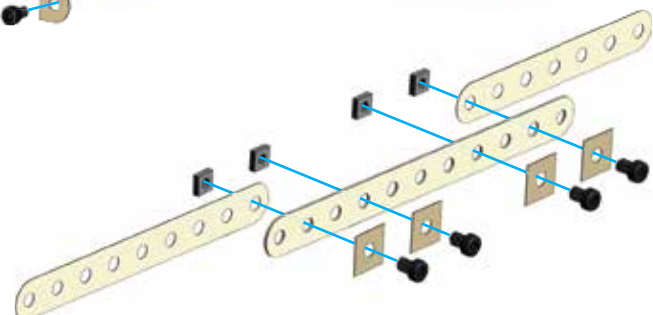

-  **x1**
-  **x1**
-  **x1**
-  **x1**
-  **x4**
-  5,8 mm | 15/64" **x4**
-  **x4**

-  **S1**
- 1:1**



22

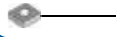

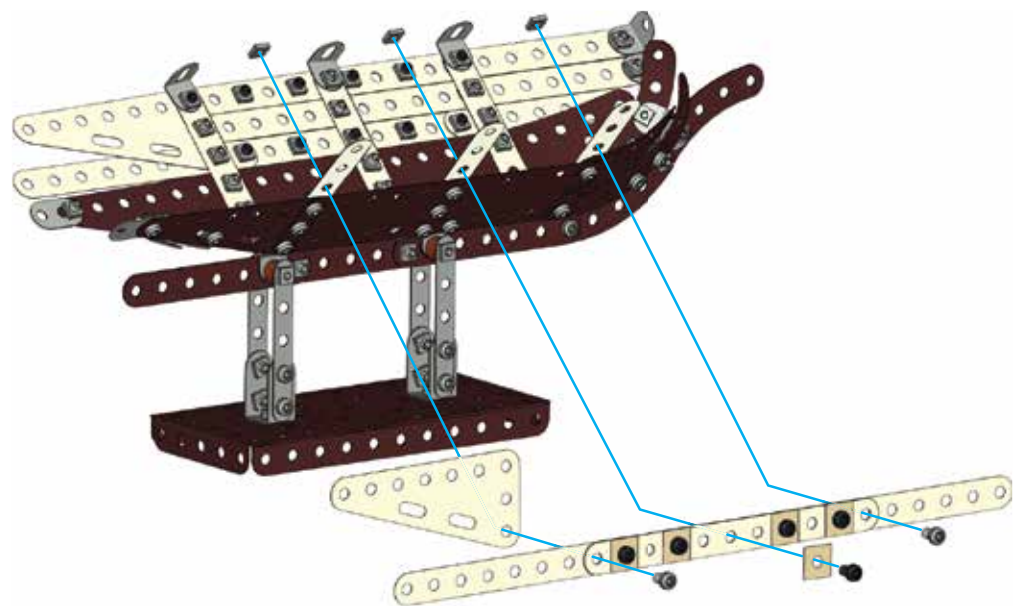

20+21

-  **x1**
-  **x1**
-  5,8 mm | 15/64" **x1**
-  5,8 mm | 15/64" **x2**
-  **x3**

-  **S1**
-  **S1**
- 1:1**



23

-  **x1**
-  **x1**
-  5,8 mm | 15/64" **x3**
-  **x3**

-  **S1**
- 1:1**

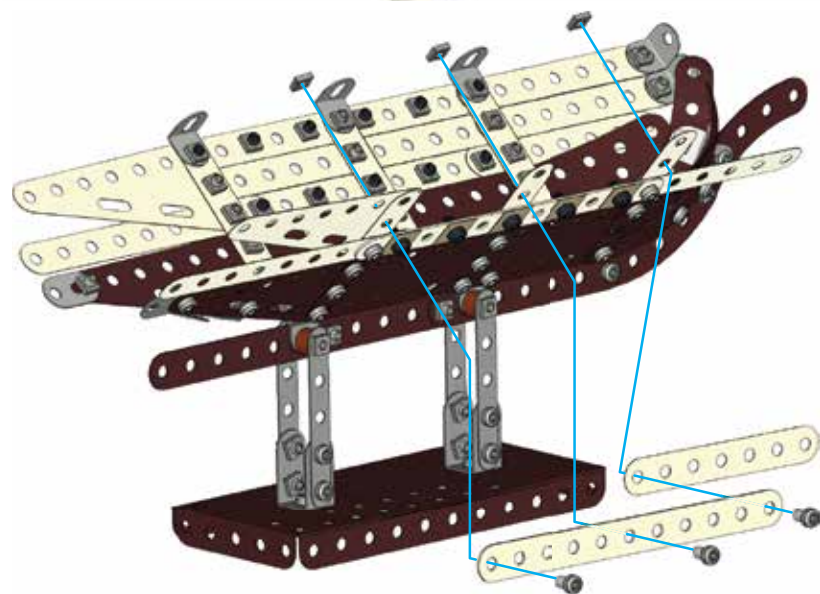

24 19+23+

	x1
	x3
	x2
	x2
	x1
	x3

	S1	1:1
	S1	

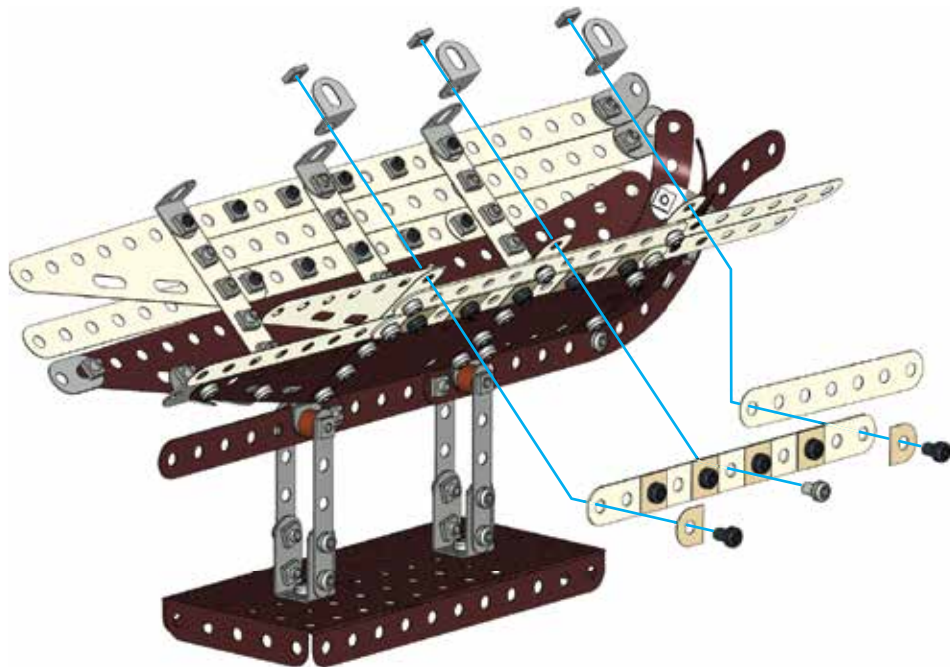

25

	x1
	x1
	x3
	x3

	S1	1:1
--	----	-----

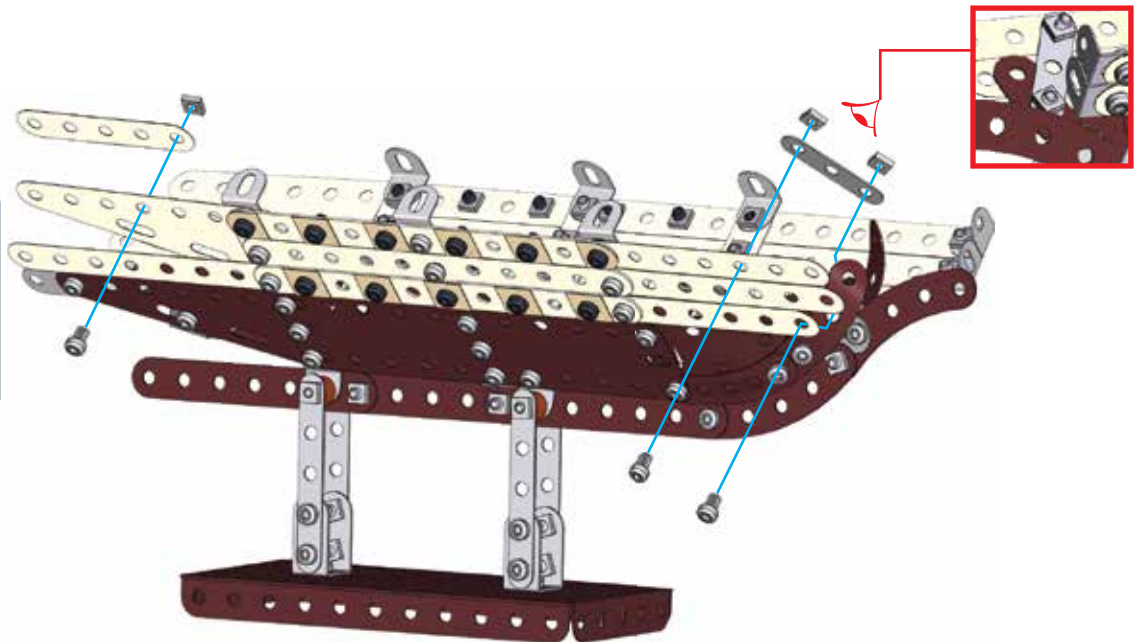



26

	x1
	x1
	x3
	x3

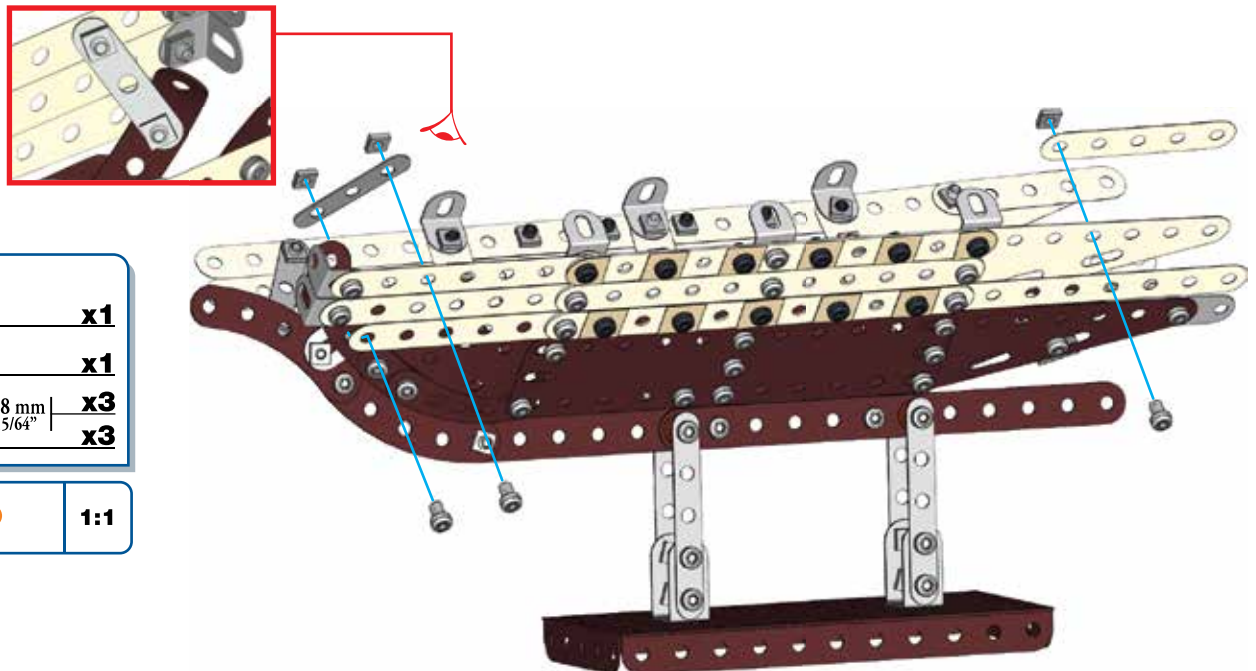
	S1	1:1
--	----	-----



27

-  | 5,8 mm | **x2**
15/64"
-  | **x2**

-  | **1:1**

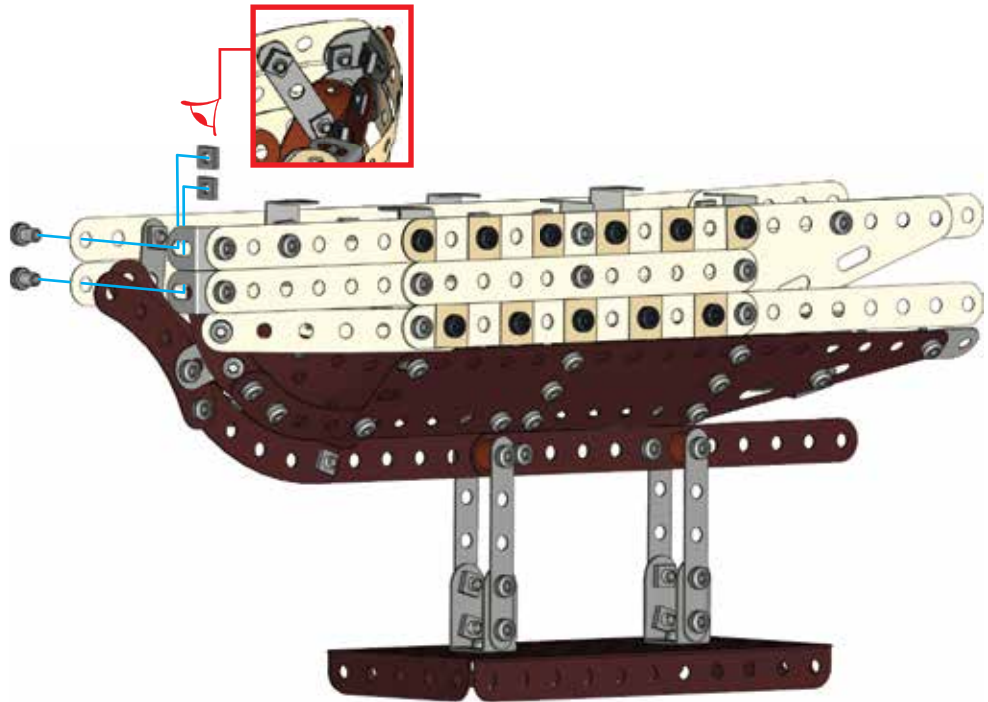



28

-  **x1**
-  **x1**
-  | 5,8 mm | **x3**
15/64"
-  | **x3**

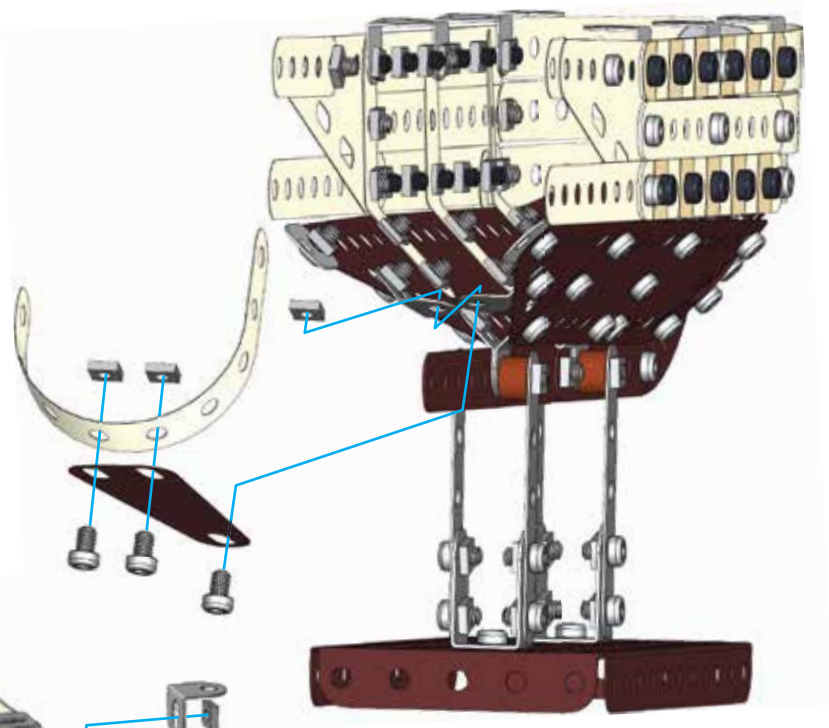
-  | **1:1**





29

-  **x1**
-  | 5,8 mm | **x3**
15/64"
-  | **x3**

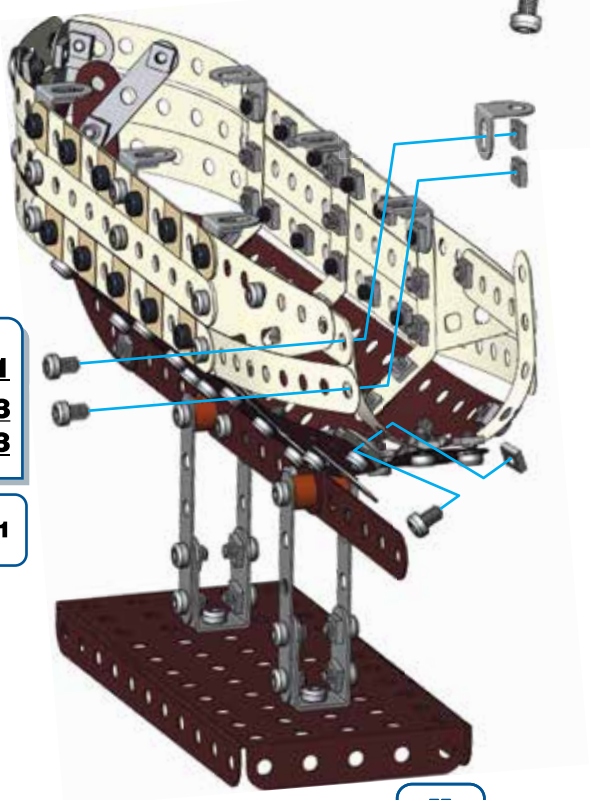
-  | **1:1**



30

-  **x1**
-  | 5,8 mm | **x3**
-  | 15/64" | **x3**

-  **S1** | **1:1**

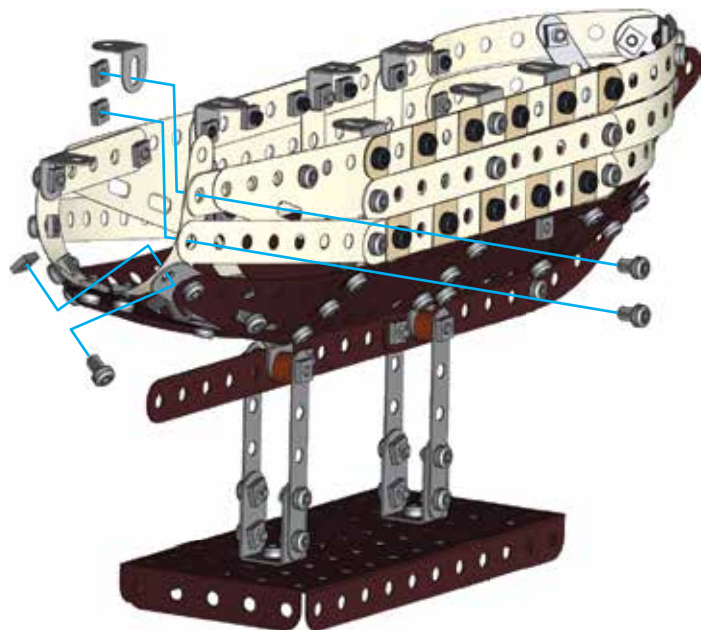

31

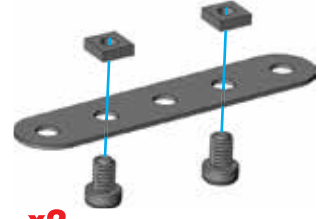

-  **x2**
-  | 5,8 mm | **x4**
-  | 15/64" | **x4**

-  **S1** | **1:1**



32



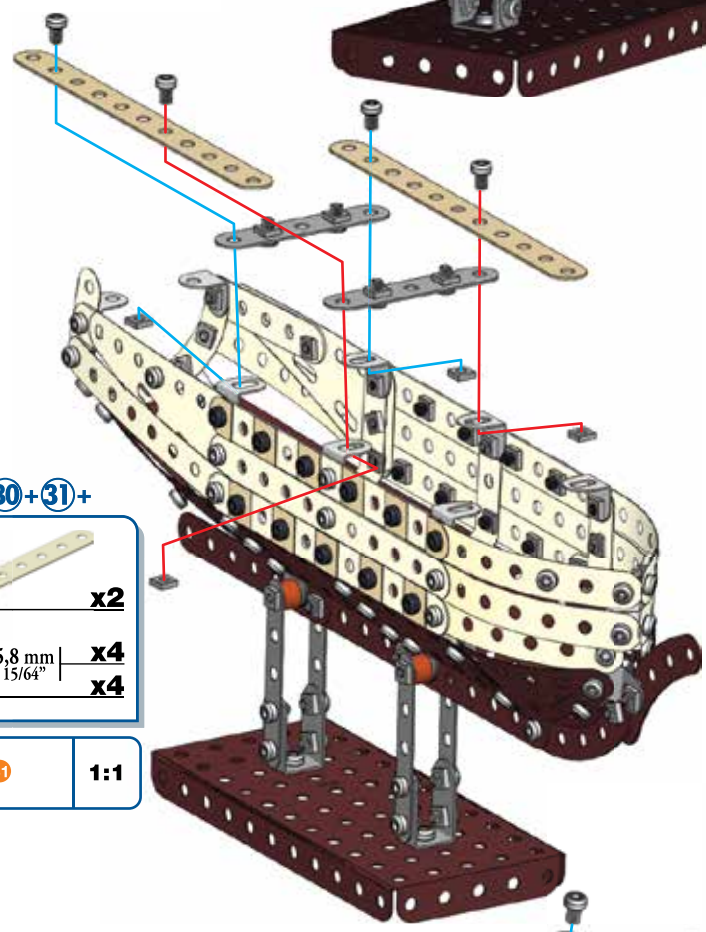

30+31+

-  **x2**
-  | 5,8 mm | **x4**
-  | 15/64" | **x4**

-  **S1** | **1:1**





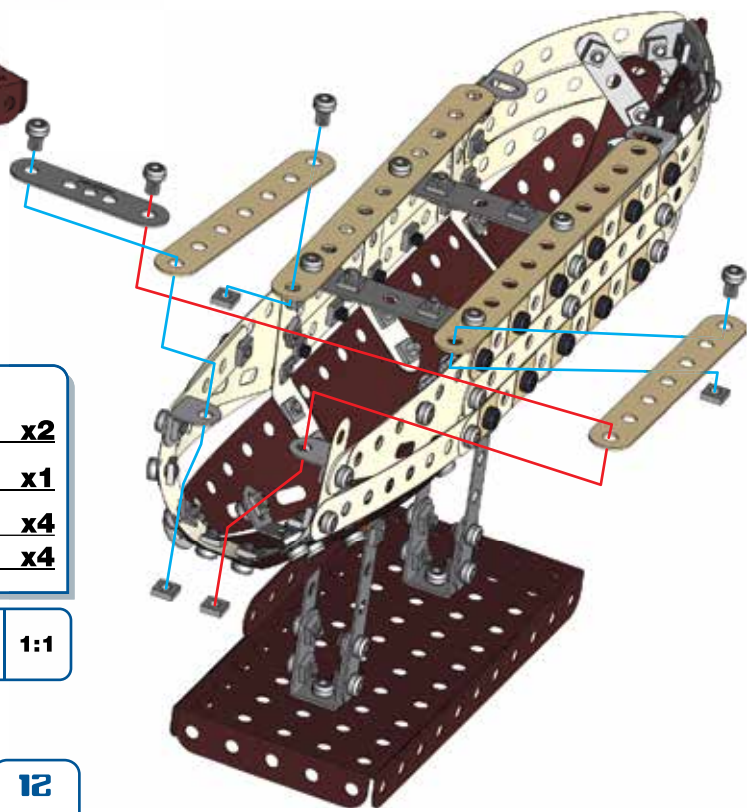

33

-  **x2**
-  **x1**
-  | 5,8 mm | **x4**
-  | 15/64" | **x4**

-  **S1** | **1:1**







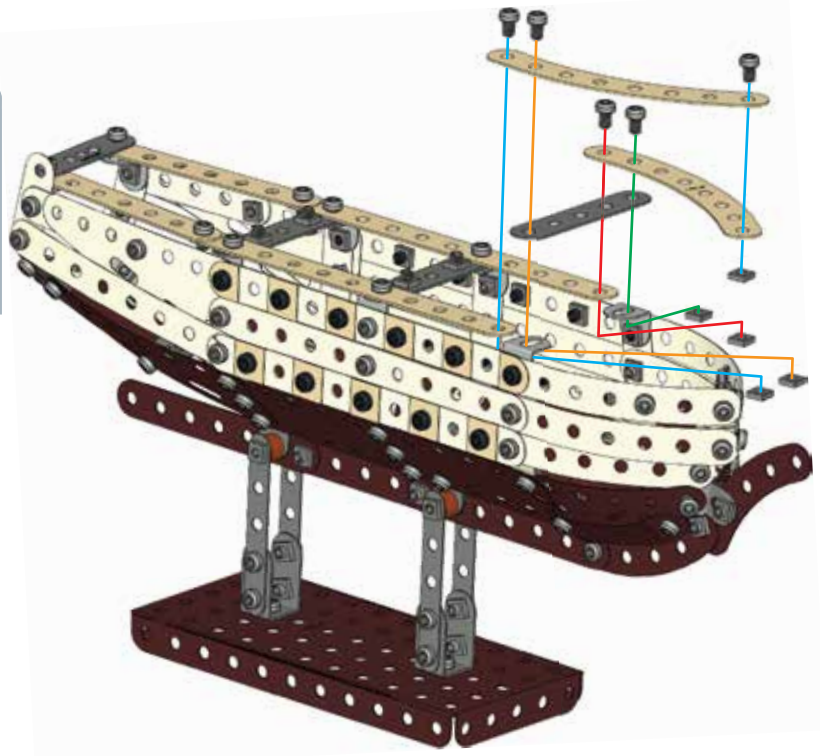

34



-  **x2**
-  **x1**
-  | 5,8 mm | **x5**
-  | 15/64" | **x5**

	S1	1:1
---	----	-----



35

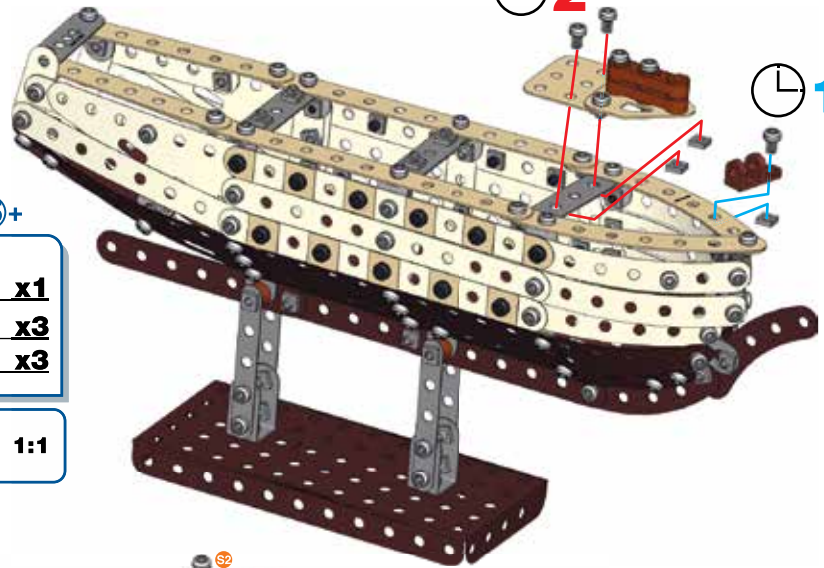
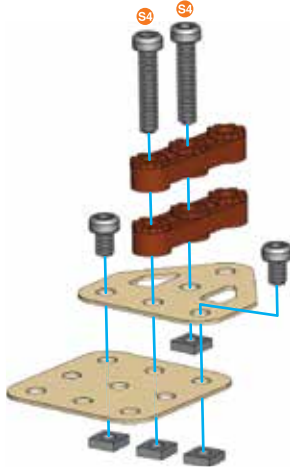

-  **x1**
-  **x1**
-  **x2**
-  | 19 mm | **x2**
-  | 5,8 mm | **x2**
-  | 15/64" | **x4**

	S4	1:1
	S1	







36

34+35+

-  **x1**
-  | 5,8 mm | **x3**
-  | 15/64" | **x3**

	S1	1:1
---	----	-----

37

-  **x2**
-  **x4**
-  | 9,5 mm | **x4**
-  | 3/8" | **x4**

	S2	1:1
---	----	-----

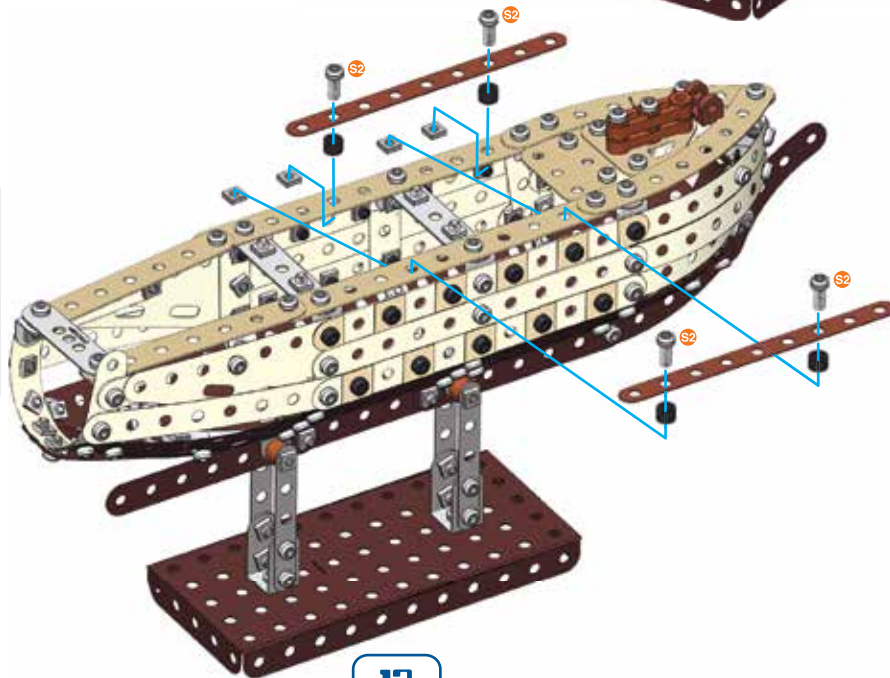

38

- x3
- 5,8 mm | 15/64" x3
- x3

- S1 1:1

40

- x3
- x1
- x2
- 5,8 mm | 15/64" x8
- x8

- S1 1:1

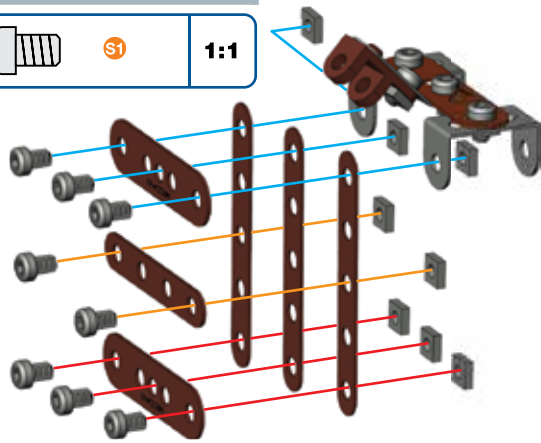

39

- x1
- x2
- x1
- 5,8 mm | 15/64" x4
- x4

- S1 1:1

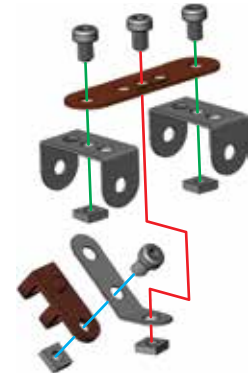

41

- x1
- x1
- x1
- x1
- 5,8 mm | 15/64" x6
- x2
- x6

- S1 1:1

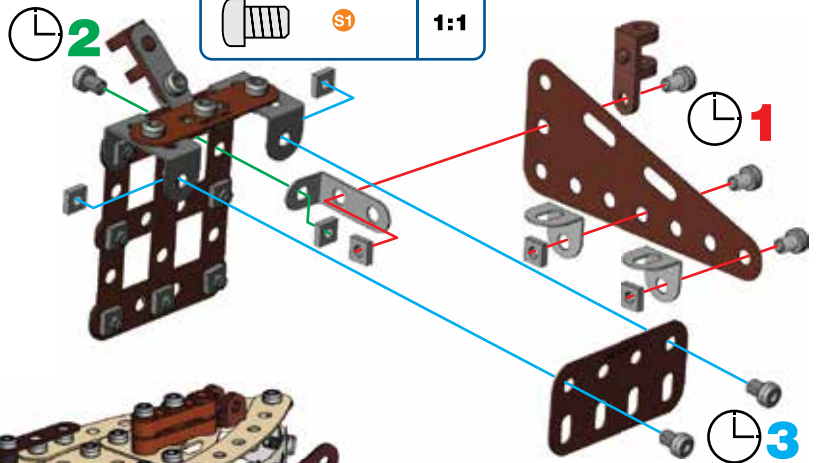

42



38+41+

- x1
- x1
- x1
- 5,8 mm | 15/64" x5
- x2
- x5
- x5

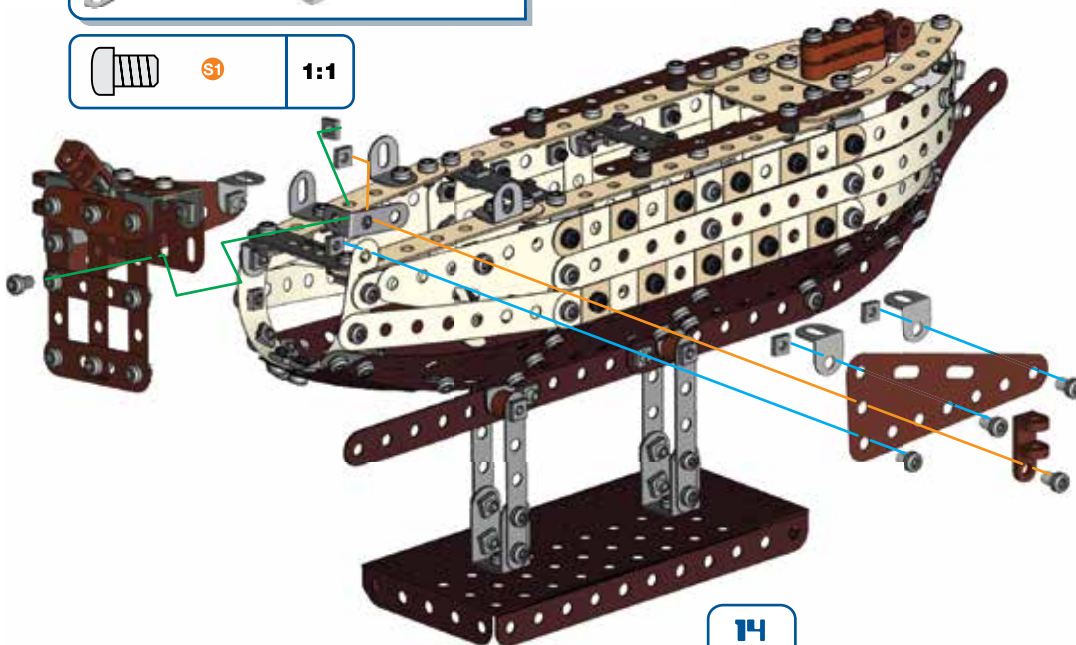
- S1 1:1





43

-  **x1**
-  | 5,8 mm | **x2**
15/64"
-  | **x2**

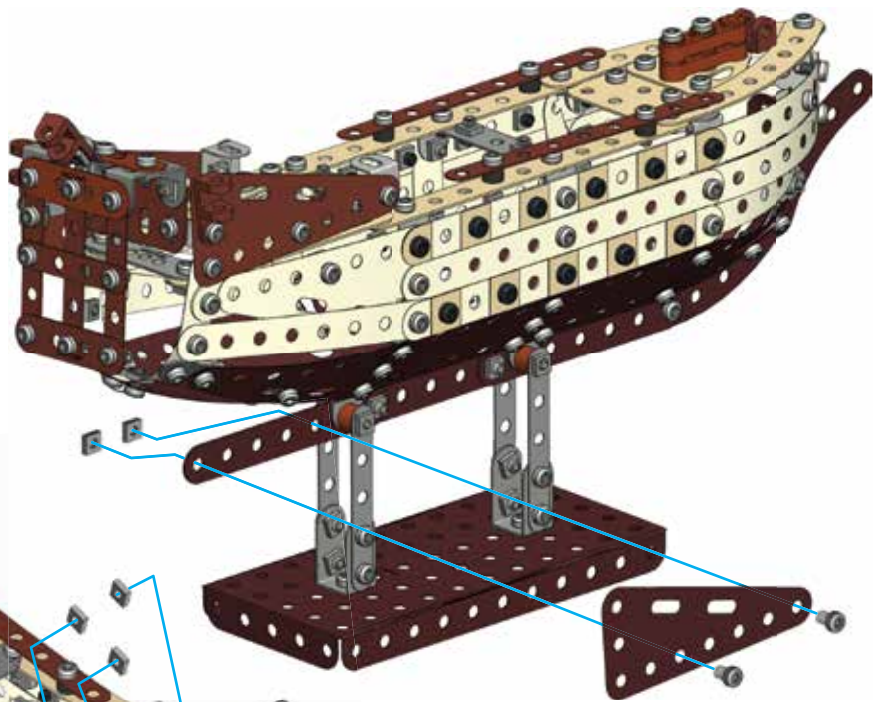
-  **1:1**









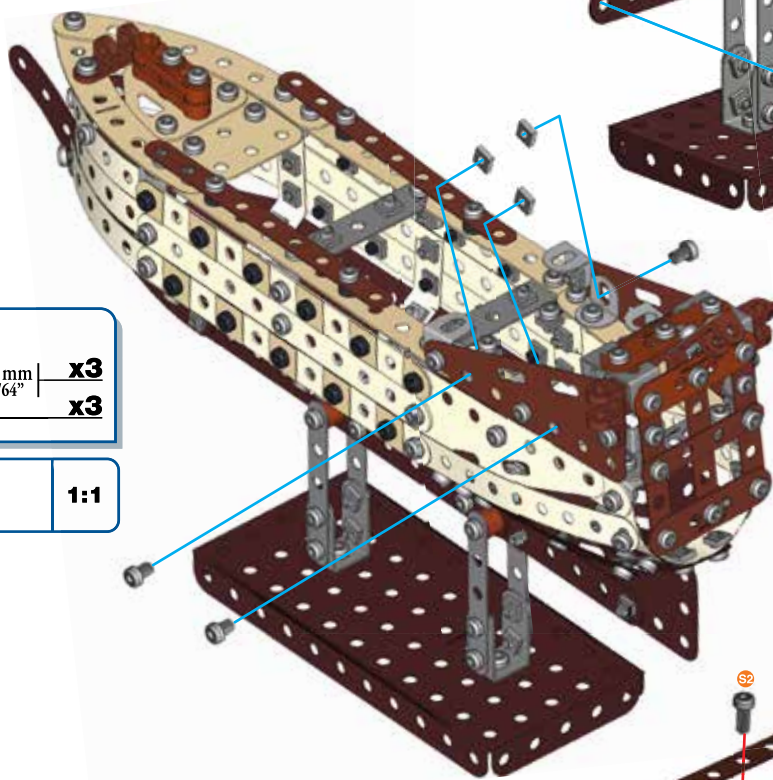

44



-  | 5,8 mm | **x3**
15/64"
-  | **x3**

-  **1:1**



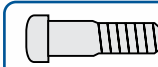
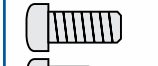

45

-  **x2**
-  **x1**
-  **x1**
-  **x6**
-  | 14,7 mm | **x2**
37/64"
-  | 9,5 mm | **x3**
3/8"
-  | 5,8 mm | **x1**
15/64"
-  | **x6**

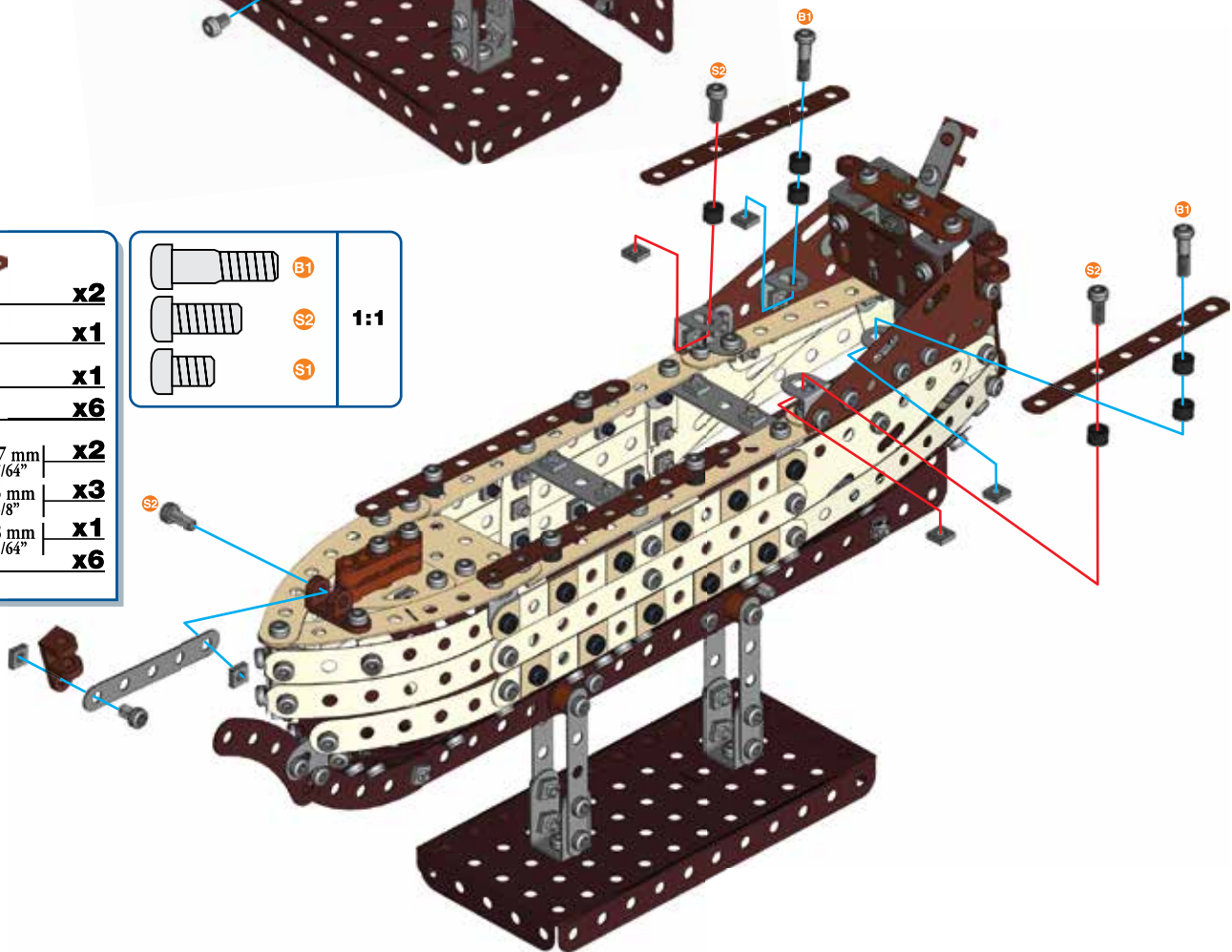
-  **B1**
 -  **S2**
 -  **S1**
- 1:1**

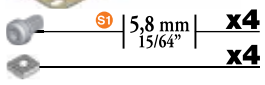

46

-  x2
-  x1
-  | 5,8 mm | 15/64" | x4
-  | 5,8 mm | 15/64" | x4

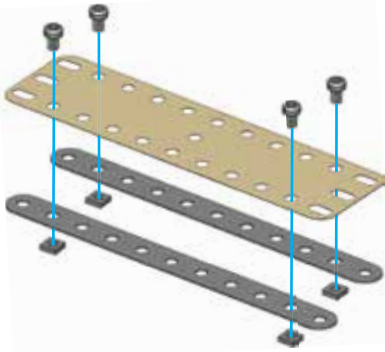

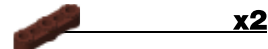
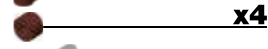
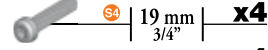
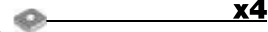

47

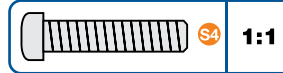
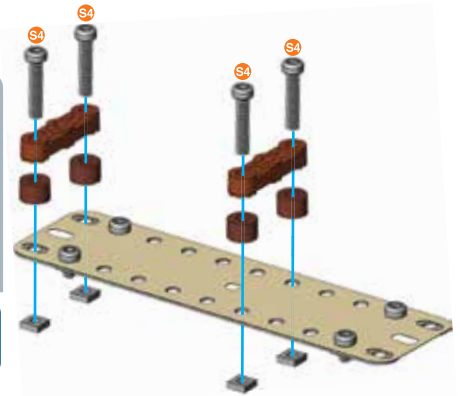
-  x2
-  x4
-  | 19 mm | 3/4" | x4
-  | 19 mm | 3/4" | x4





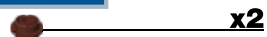
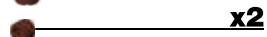

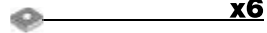

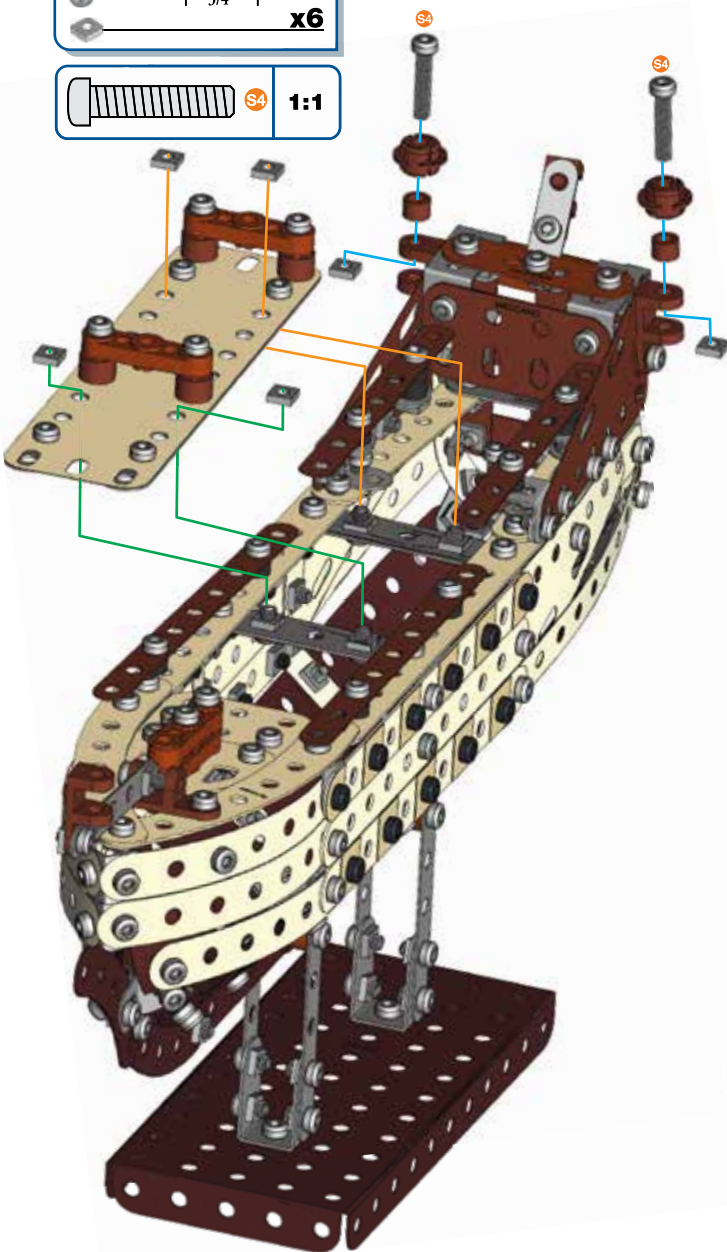











48

(45+47)+

-  x2
-  x2
-  | 19 mm | 3/4" | x2
-  | 19 mm | 3/4" | x6





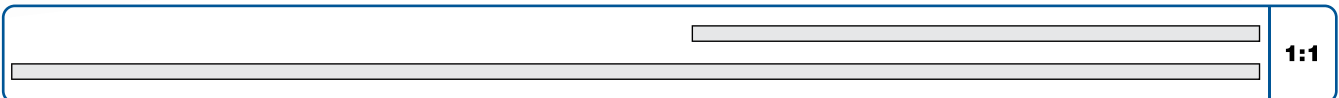
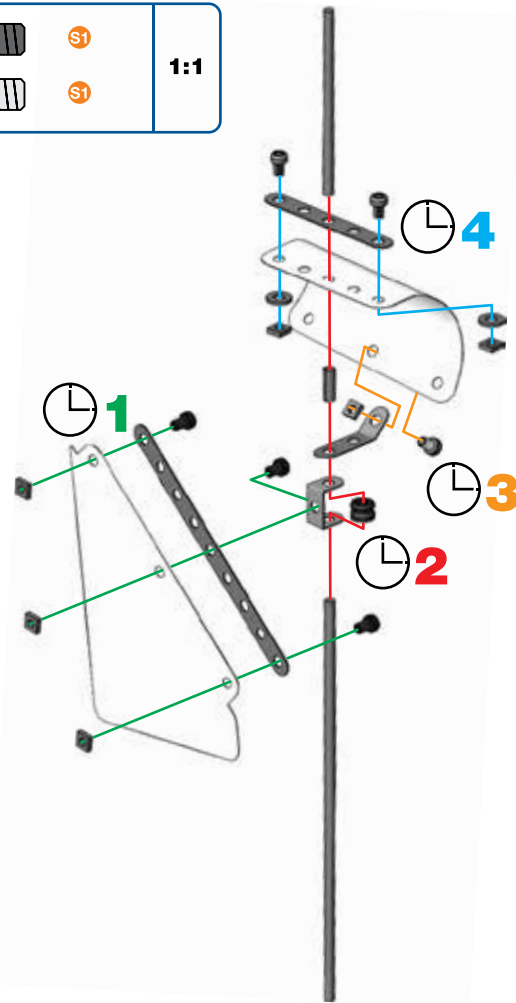

49

-  x1
-  x1
-  x1
-  x1
-  | 165 mm | 6 1/2" | x1
-  | 75 mm | 3" | x1
-  | 5,8 mm | 15/64" | x3
-  | 5,8 mm | 15/64" | x3
-  | 5,8 mm | 15/64" | x2
-  | 5,8 mm | 15/64" | x1
-  | 5,8 mm | 15/64" | x1
-  | 5,8 mm | 15/64" | x1
-  | 5,8 mm | 15/64" | x1
-  | 5,8 mm | 15/64" | x1
-  | 5,8 mm | 15/64" | x1
-  | 5,8 mm | 15/64" | x1
-  | 5,8 mm | 15/64" | x1
-  | 5,8 mm | 15/64" | x1
-  | 5,8 mm | 15/64" | x1



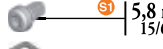
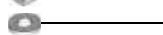

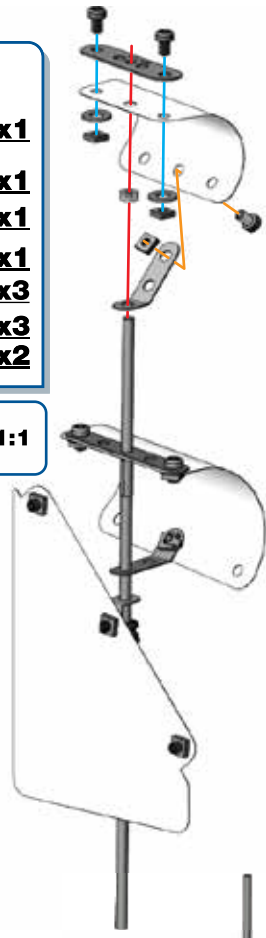

50

-  **x1**
-  **x1**
-  **x1**
-  **x1**
-  **x3**
-  **x3**
-  **x2**

-  **S1** | **1:1**

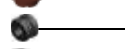



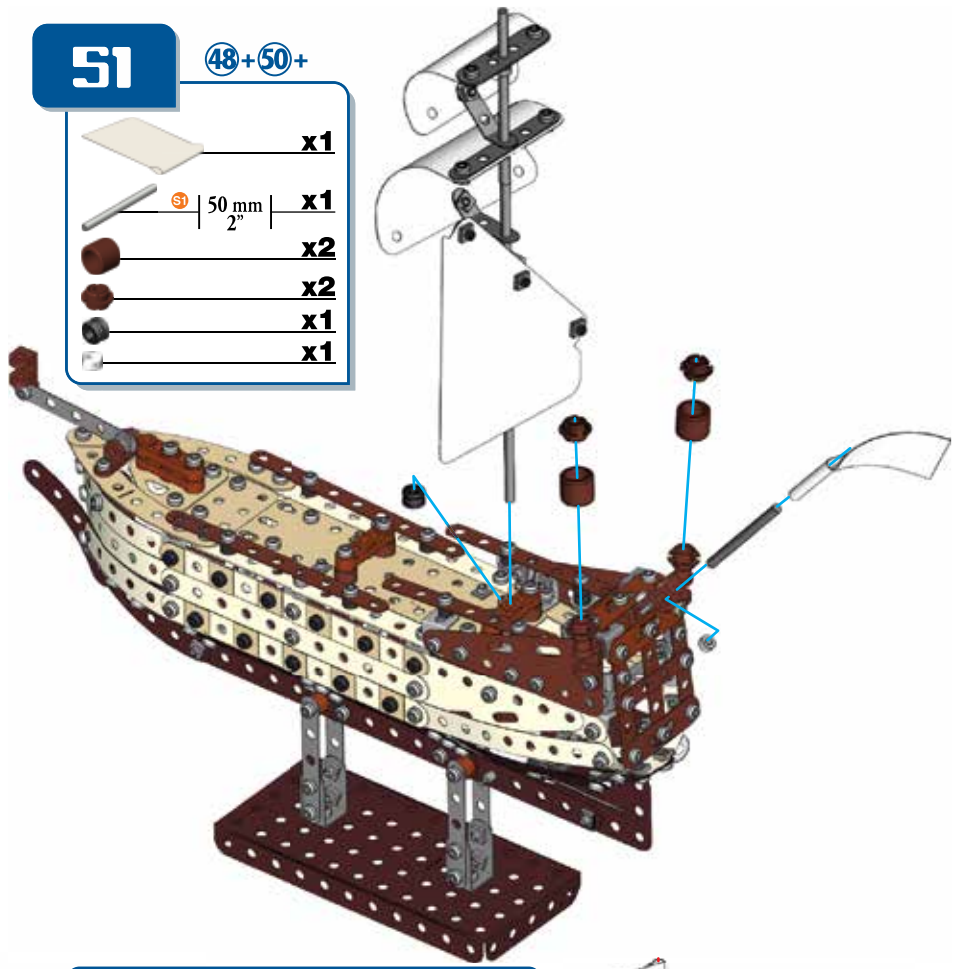

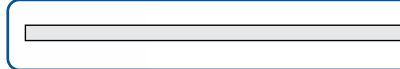
**51****48+50+**

-  **x1**
-  **S1** | **50 mm** | **x1**
-  **x2**
-  **x2**
-  **x1**
-  **x1**



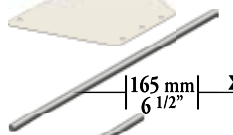
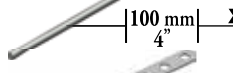

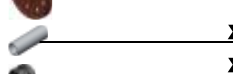
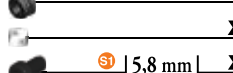
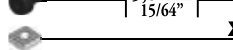

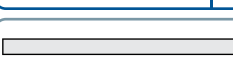

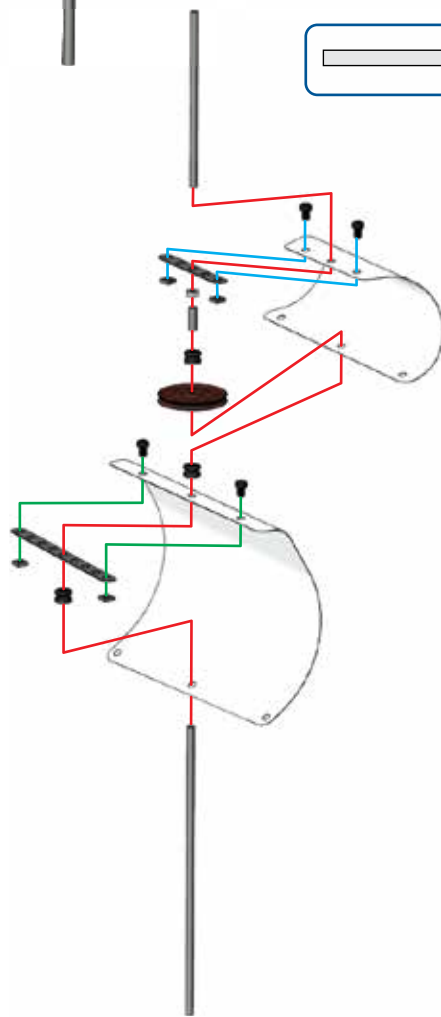

-  **1:1**

52

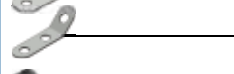
-  **x1**
-  **x1**
-  | **165 mm** | **6 1/2"** | **x1**
-  | **100 mm** | **4"** | **x1**
-  **x1**
-  **x1**
-  **x1**
-  **x3**
-  **x1**
-  | **5,8 mm** | **15/64"** | **x4**
-  **x4**

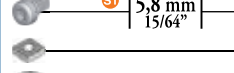

-  **S1** | **1:1**

**53**

-  **x1**
-  **x1**
-  **x1**
-  **x1**
-  **x1**
-  **x1**
-  | **5,8 mm** | **15/64"** | **x3**
-  **x3**
-  **x2**

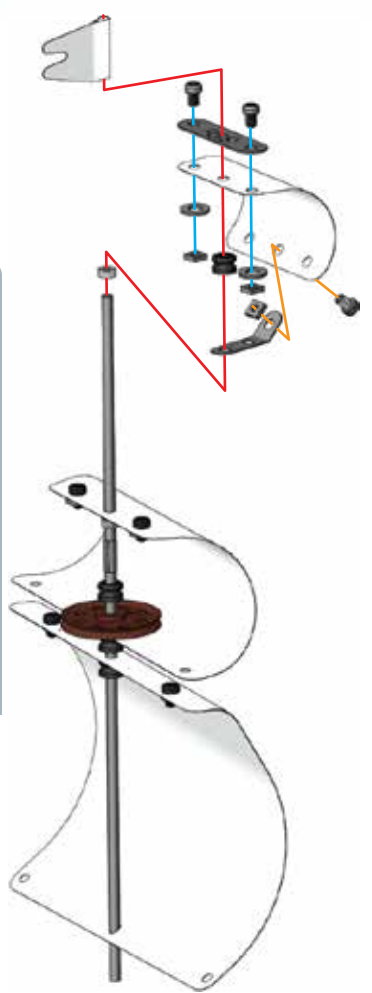
-  **S1** | **1:1**









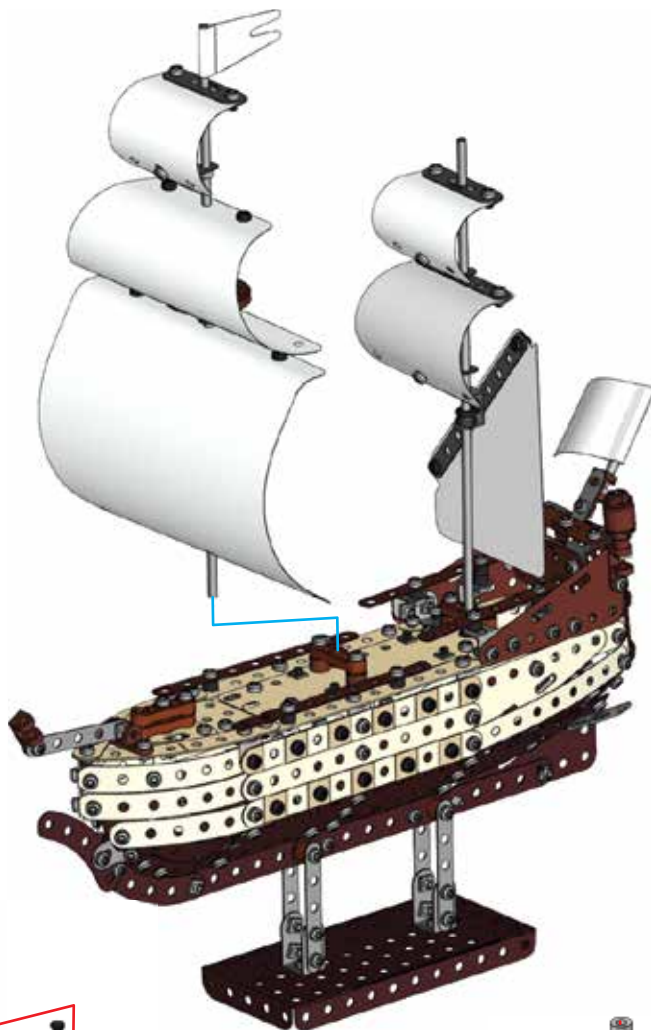







-  **1:1**
-  **1:1**

54

51+53+

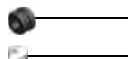

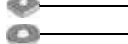

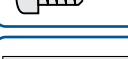

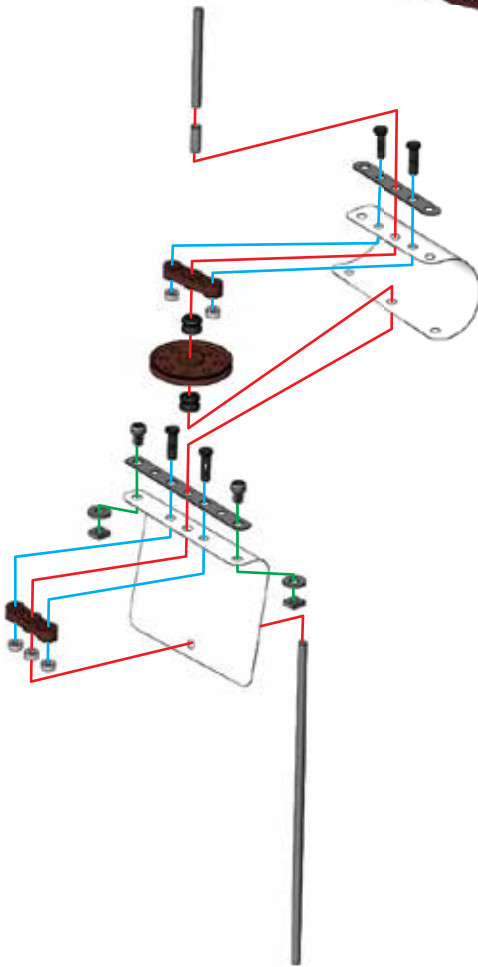

55

-  x1
-  x1
-  165 mm | 6 1/2" x1
-  63,5 mm | 2 1/2" x1
-  x1
-  x1
-  x2
-  x1
-  x4
-  x1
-  x2
-  x5
-  5,8 mm | 15/64" x2
-  x2
-  x2

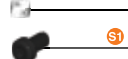



56

-  x1
-  x1
-  x1
-  5,8 mm | 15/64" x2
-  5,8 mm | 15/64" x2
-  x4
-  x4

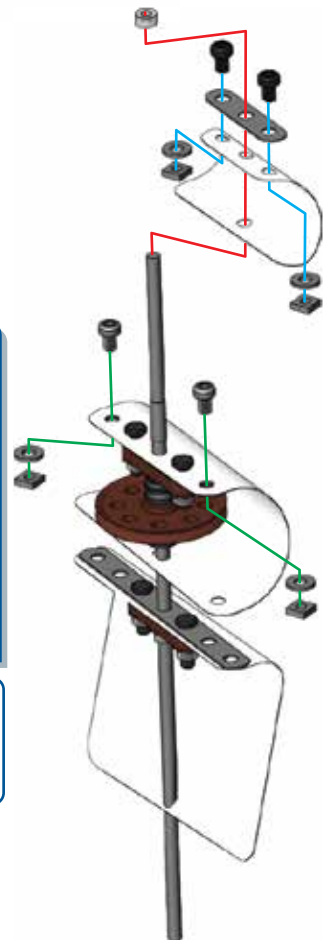





	S1	1:1
	S1	

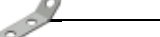

	S1	1:1
---	----	-----

	1:1
	

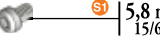
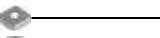
57 (54)+(56)+

	x1
	x1
	x1
	x1
	x3
	x3
	x3
	x2

1:1

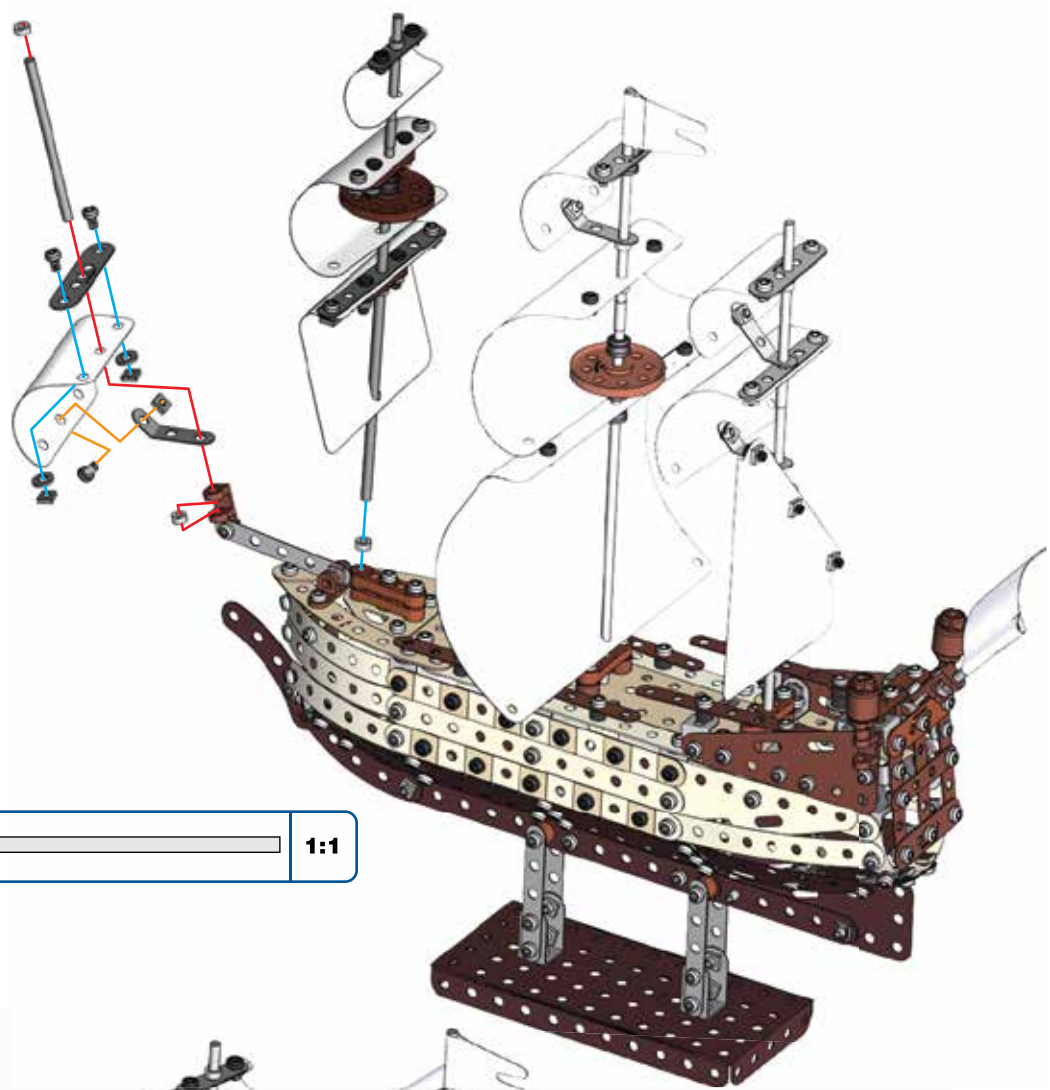

58

	x1
---	-----------

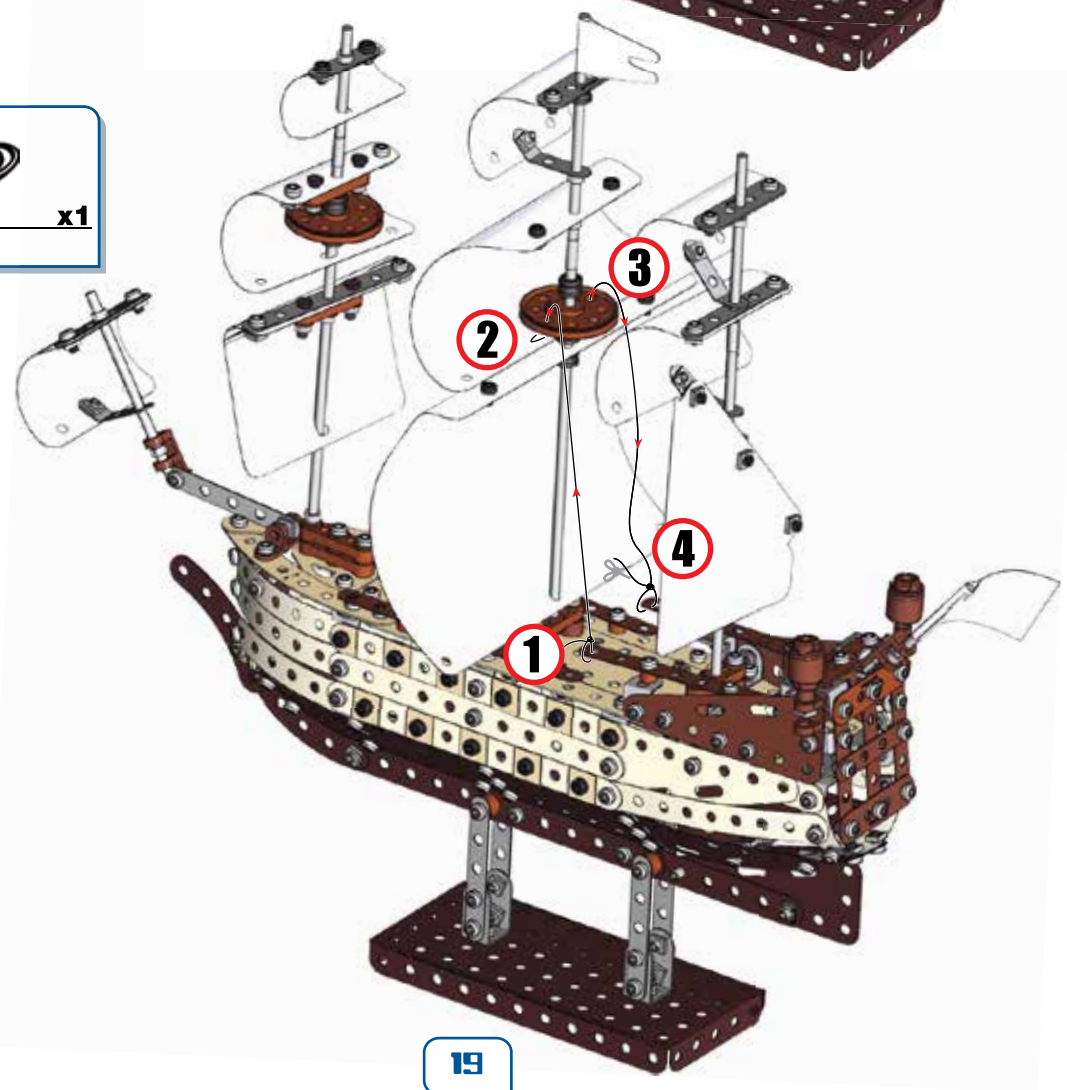

59

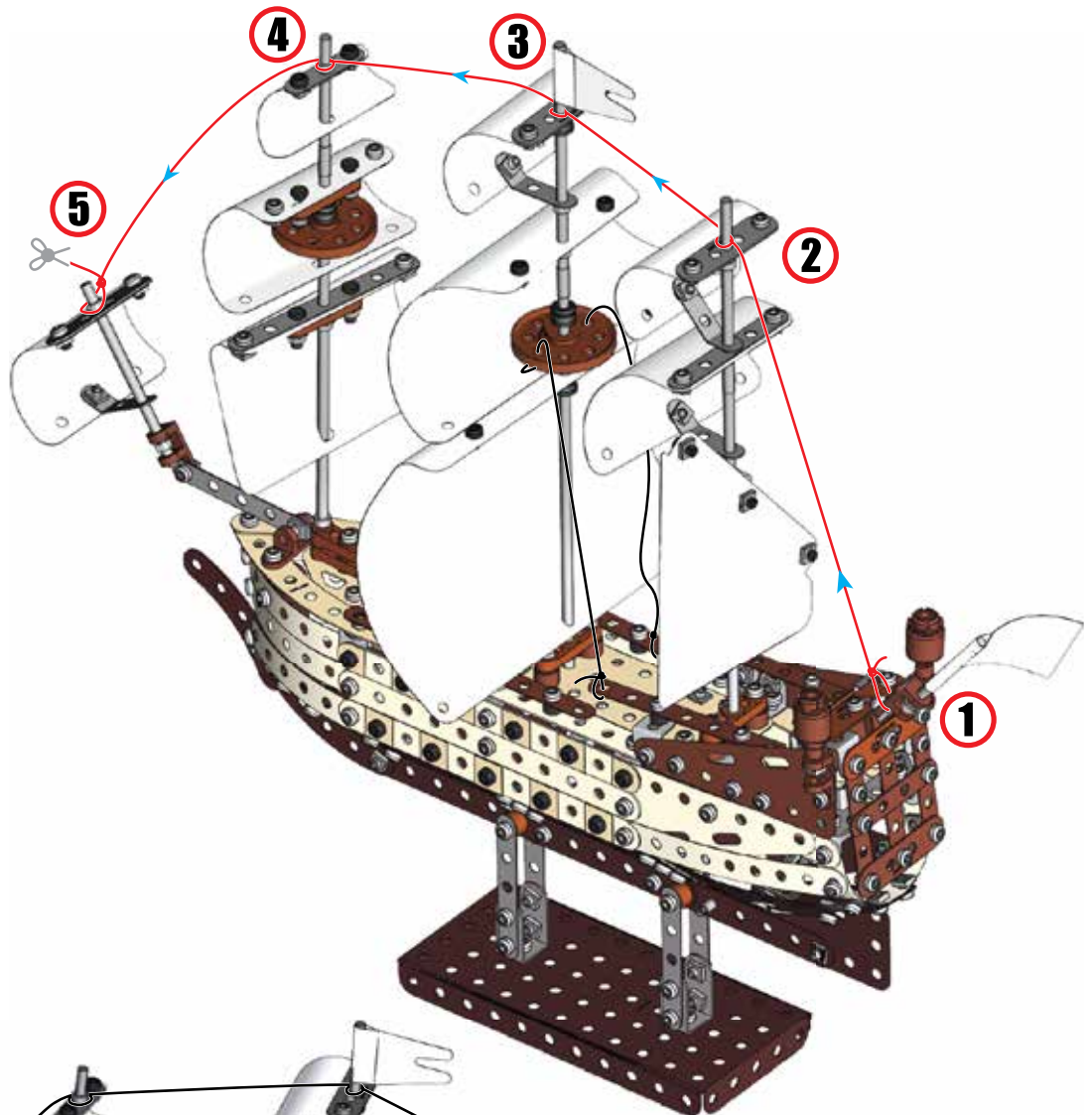

60

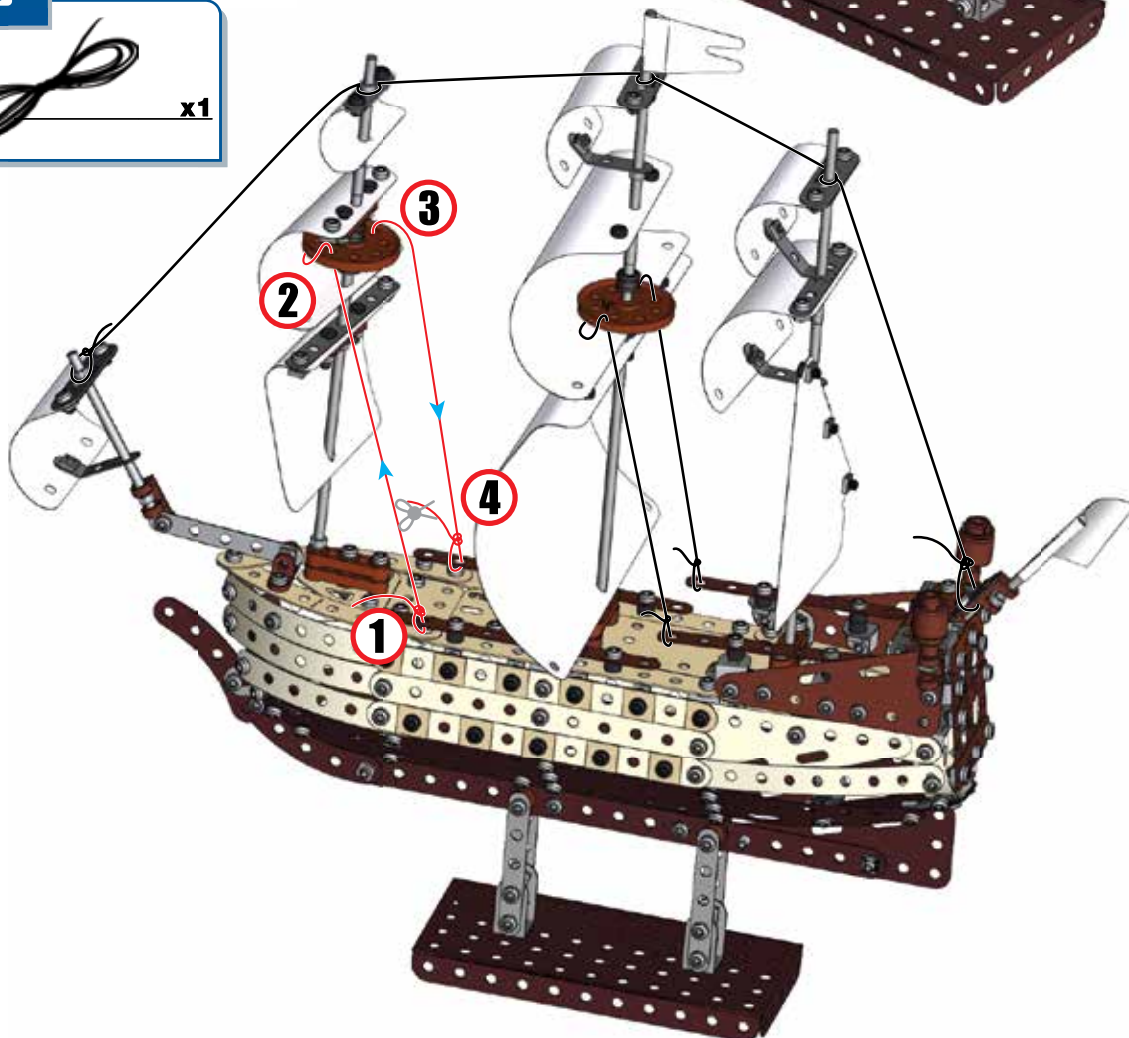

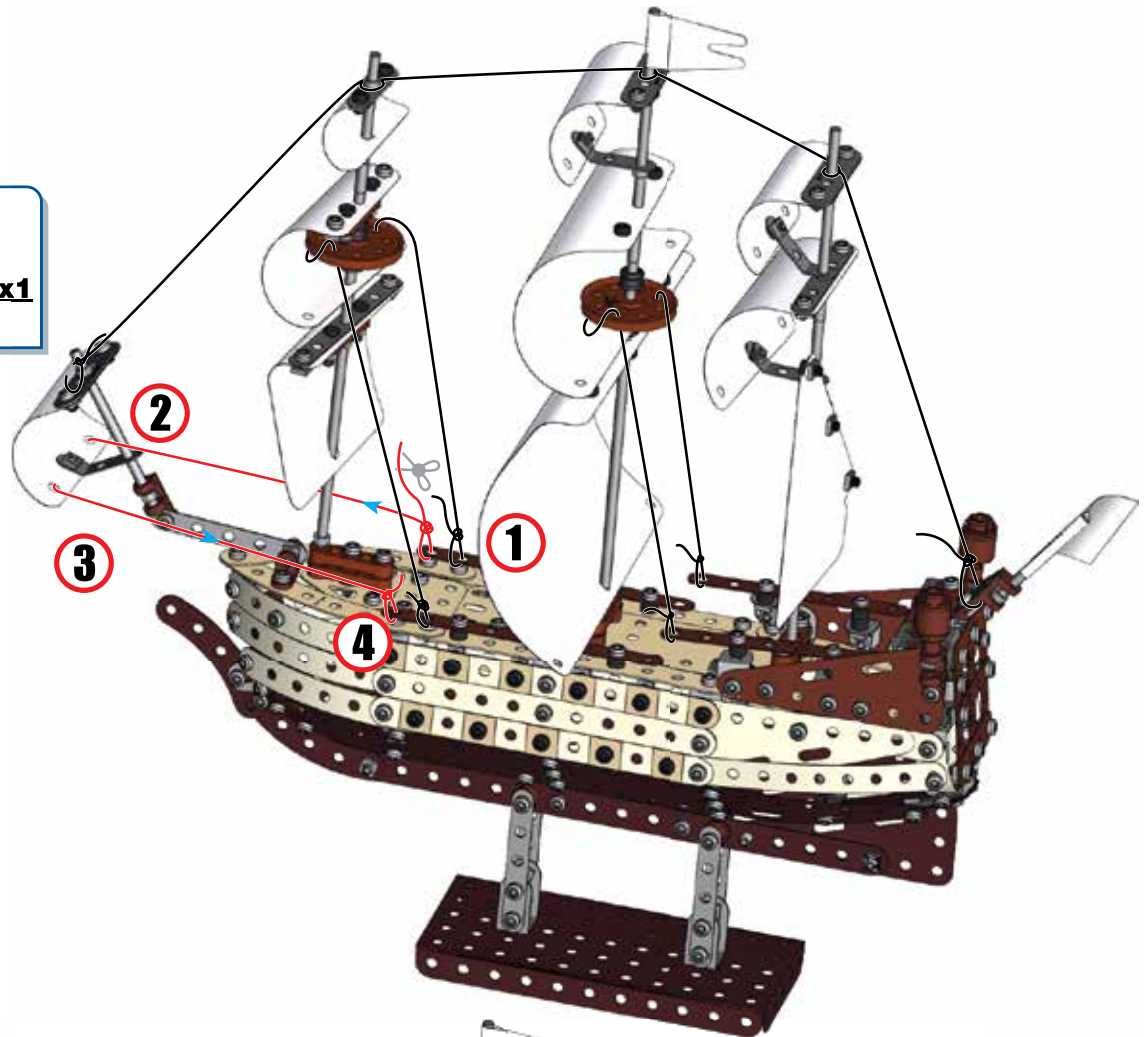

61

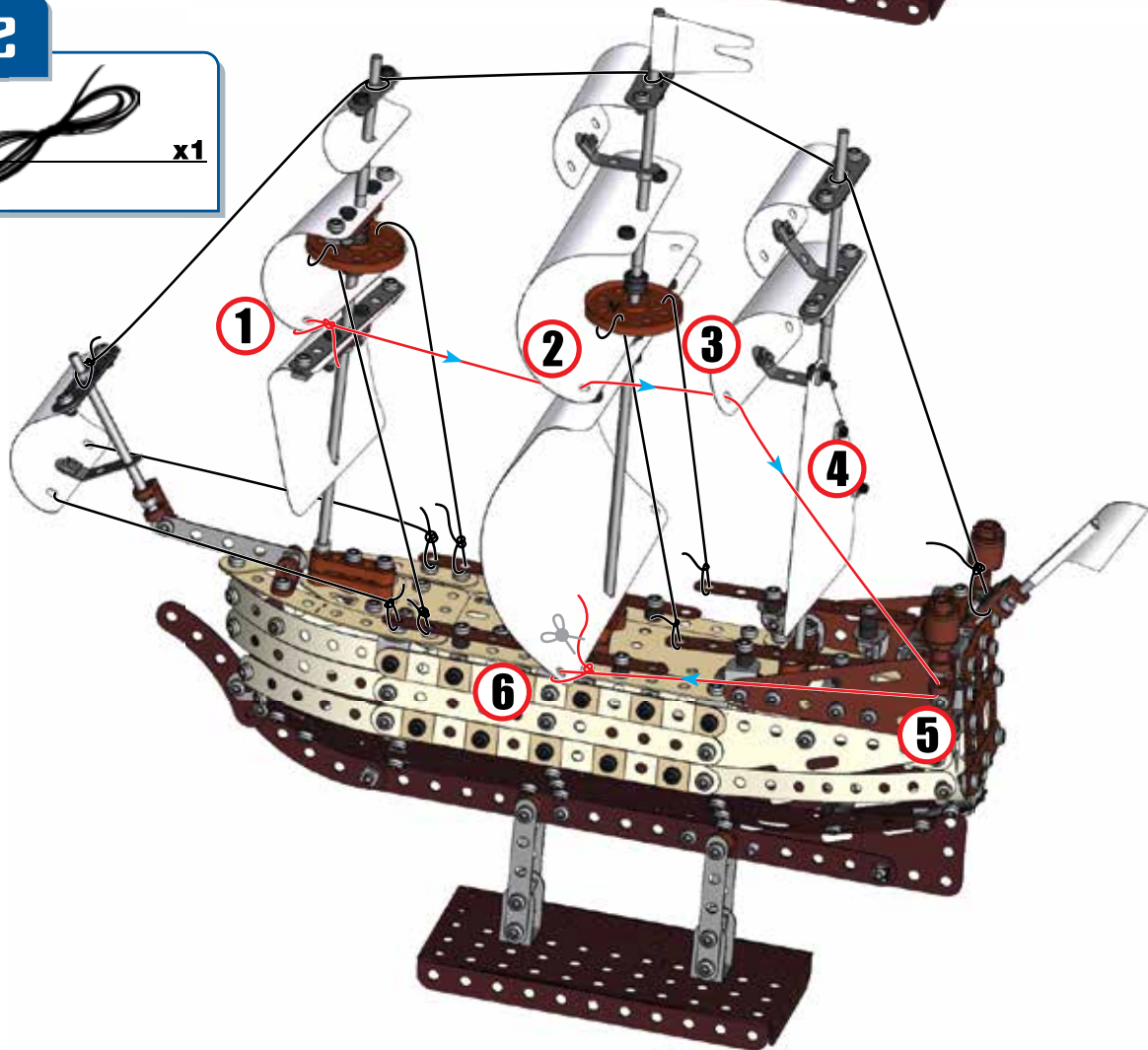

62



63

-  x1
-  x1
-  x1

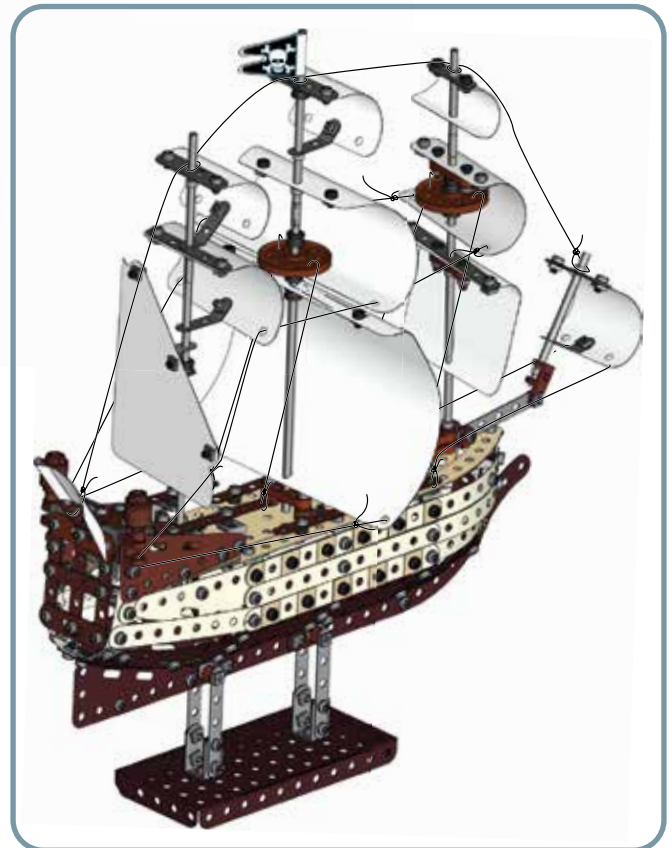
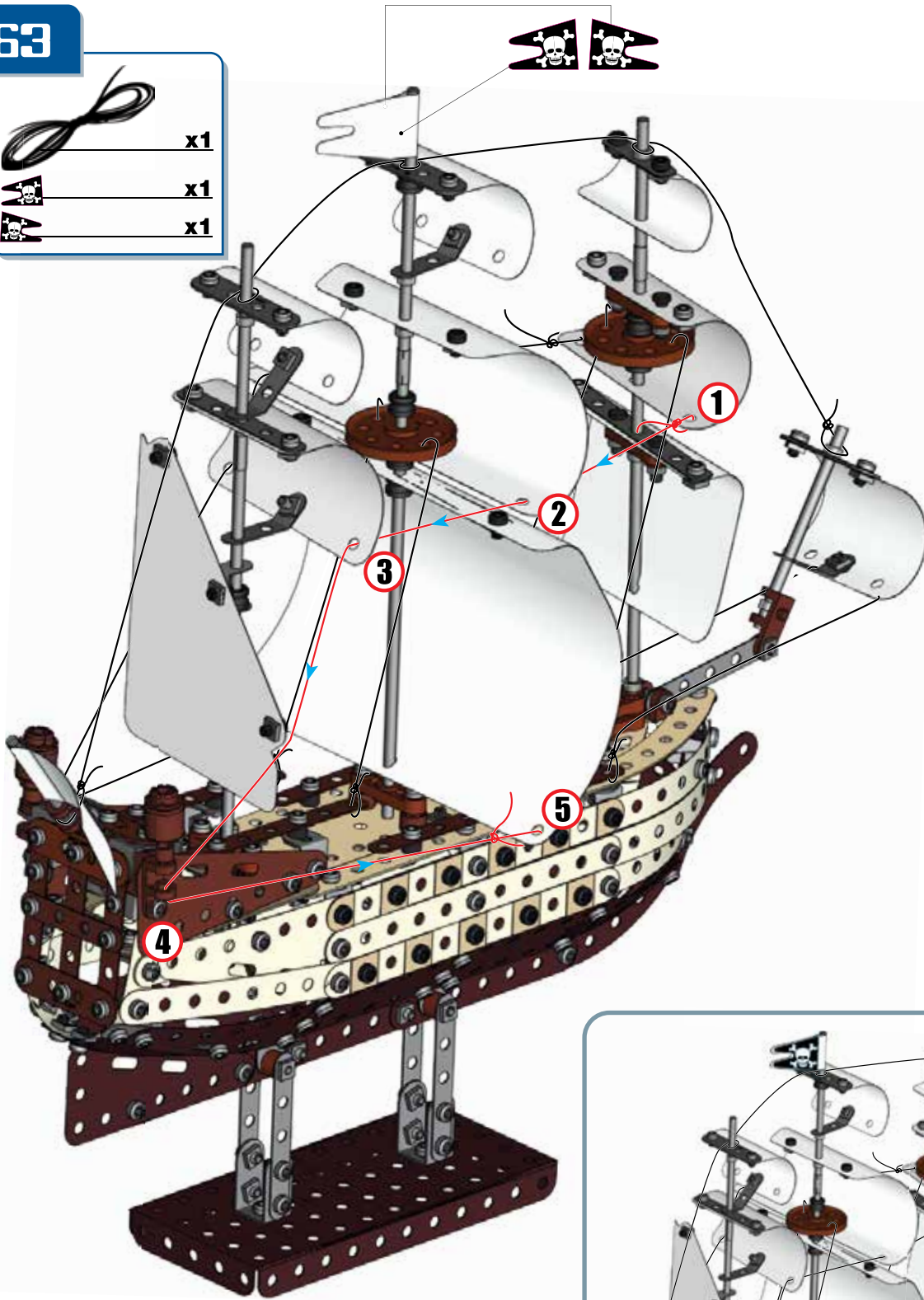

Warning! Attention! Achtung! Attenzione! ¡Atención! Aviso! Varning! Varoitus!
Advarsel! Waarschuwing! Προειδοποίηση! Внимание! Varovani! Tähelepanu!
Įspėjimas! Figyelmeztetés! Twissija! Uwaga! Atenție! Pozor! Rabhadh! Uzmanību!



GB/USA

Warning! Choking Hazard. Contains small parts which could be swallowed. Not suitable for children under 3 years.

FR

Attention ! Danger d'étouffement. Contient des petites pièces pouvant être absorbées. Ne convient pas aux enfants de moins de 3 ans.

D

Achtung! Verschluckungsgefahr. Enthält verschluckbare Kleinteile. Nicht für Kinder unter 3 Jahren geeignet.

I

Attenzione, pericolo di soffocamento! Contiene pezzi piccoli che potrebbero essere ingoiati. Non adatto ai bambini sotto i 3 anni.

E

¡Atención! Riesgo de asfixia. Contiene piezas pequeñas que un niño podría tragarse. No conviene a los niños menores de 3 años.

P

Aviso! Perigo de se engasgar. Contém peças pequenas que podem ser engolidas. Não aconselhável a crianças com menos de 3 anos.

S

Varning! Risk för kvävning. Innehåller små delar som kan sväljas. Ej lämplig för barn under 3 års ålder.

FIN

Varoitus! Tukehtumisvaara. Sisältää pieniä osia, jotka voidaan niellä. Ei sovellu alle 3-vuotiaille lapsille.

DK

Advarsel! Fare for slugning. Indeholder små dele, som kan sluges. Ikke velegnet for børn under 3 år.

NL

Waarschuwing ! Verstikkingsgevaar. Bevat kleine onderdelen die kunnen worden ingeslikt. Niet geschikt voor kinderen onder 3 jaar.

GR

Προειδοποίηση! Κίνδυνος πνιγμού. Περιέχει μικρά εξαρτήματα που θα μπορούσαν να καταποθούν. Ακατάλληλο για παιδιά κάτω από 3 ετών.

BULGARIAN

Внимание! Опасност от задушаване. Съдържа малки части, които могат да бъдат погълнати. Не е подходящо за деца под 3 години.

CZECH

Varování ! Nebezpečí udušení. Obsahuje malé díly, které by mohly být spolknuty. Nevhodné pro děti do 3 let.

ESTONIAN

Tähelepanu ! Lämbumisoh. Sisaldab väikseid osi, mida saab alla neelata. Ei sobi alla 3. aasta vanustele lastele.

LITHUANIAN

Įspėjimas! Uždusimo pavojus. Yra smulkių dalių, kurias galima nuryti. Netinka vaikams iki 3 metų.

HUNGARIAN

Figyelmeztetés! Fulladásveszély. Apró alkatrészeket tartalmaz, amelyeket a gyermekek lenyelhetnek. 3 évesnél fiatalabb gyermekek számára nem alkalmas.

MALTESE

Twissija! Periklu li wiehed jifga. Fih partijiet iżgħar li jistgħu jinbelgħu. Mhuwiex adattat għal tfal iżgħar minn 3 snin.

POLISH

Uwaga! Ryzyko uduszenia. Zawiera małe części, które mogą zostać połknięte. Produkt nieodpowiedni dla dzieci poniżej 3 lat.

ROMANIAN

Atenție! Pericol de sufocare. Conține piese mici care pot fi înghițite. Interzis copiilor sub 3 ani.

SLOVAK

Pozor ! Nebezpečnosť udusenía. Obsahuje malé diely, ktoré je možné prehltnúť. Nie je vhodné pre deti mladšie ako 3 roky.

SLOVENIAN

Pozor ! Nevarnost zadušitve. Vsebuje majhne dele, ki jih je možno zaužiti. Ni primerno za otroke, mlajše od 3 let.

IRISH

Rabhadh! Guais Tachta. Piosai beaga ann a fhéadfhadh a bheith insúite. Níl an bréagán seo oiriúnach do pháistí atá níos óige ná trí bhliain d'aois.

LATVIAN

Uzmanību! Nosmakšanas draudi. Satur sīkas detaļas, kuras var tikt norītas. Nav piemērots bērniem, kas jaunāki par 3 gadiem.

RUSSIA

Внимание! Возможен риск удушья. В наборе имеются мелкие детали, которые легко проглотить. Противопоказан детям младше 3 лет.

- GB** Remove all packaging before use. Retain this information, addresses and phone numbers for future reference. Content may vary from pictures. Meccano reserves the right to discontinue the website www.meccano.com at any time. An adult should periodically check this toy to ensure no damage or hazard exist if so remove from use. Children should be supervised during play.
- F** Retirer tout l'emballage avant utilisation. Conserver les informations, adresses et numéros de téléphone pour consultation ultérieure. Le contenu peut différer des images. Meccano se réserve le droit de supprimer le site Internet www.meccano.fr à tout moment. Un adulte doit régulièrement examiner ce jouet afin de s'assurer qu'il ne présente pas de dommage ni de risque. En cas de problème, ne plus l'utiliser. Les enfants doivent être surveillés lorsqu'ils jouent.
- E** Retire todo el embalaje antes de utilizar el producto. Conserve toda la información, las direcciones y los números de teléfono para futuras referencias. El contenido del paquete puede no corresponder con las imágenes. Meccano se reserva el derecho a suspender el sitio web www.meccano.com en cualquier momento. Un adulto debe revisar de forma periódica el juguete para asegurarse de que no supone un riesgo o peligro para el niño; si así fuera el caso, interrumpa su uso. Supervise a los niños mientras juegan con el producto.
- D** Entfernen Sie vor der Benutzung sämtliche Verpackungsmaterialien. Alle Informationen, Adressen und Telefonnummern bitte für mögliche Rückfragen aufbewahren. Der Packungsinhalt kann von den Bildern abweichen. Meccano behält sich das Recht vor, den Betrieb der Website www.meccano.com jederzeit einzustellen. Ein Erwachsener sollte regelmäßig sicherstellen, dass das Spielzeug keine Gefahr darstellt, und es gegebenenfalls entfernen. Kinder sollten beim Spielen beaufsichtigt werden.
- NL** Het voorwerp in deze verpakking wijkt mogelijk af van de foto's en/of illustraties. Bewaar deze informatie, adressen en telefoonnummers voor toekomstig gebruik. Verwijder al het verpakkingsmateriaal voordat kinderen met het product spelen. Meccano behoudt zich het recht voor de website www.meccano.com wanneer gewenst buiten gebruik te stellen. Een volwassene dient dit speelgoed regelmatig te controleren op schade en gevaren. Indien het speelgoed is beschadigd of indien er een gevaarlijke situatie kan ontstaan, dient het product te worden weggegooid. Ouderlijk toezicht is vereist als kinderen met dit speelgoed spelen.
- I** Rimuovere l'imballaggio prima dell'uso. Conservare informazioni, indirizzi e numeri di telefono per riferimento futuro. Il prodotto potrebbe differire dalle immagini. Meccano si riserva il diritto di rimuovere il sito www.meccano.com in qualsiasi momento. È consigliabile un controllo periodico del giocattolo da parte di un adulto: in caso di danni o rischi interrompere l'uso. È richiesta la supervisione di un adulto durante il gioco.
- P** Remova totalmente a embalagem antes de utilizar. Guarde estas informações, as moradas e os números de telefone para consulta futura. O conteúdo poderá ser diferente das ilustrações. A Meccano reserva-se o direito de descontinuar o sítio www.meccano.com a qualquer altura. Um adulto deve verificar o brinquedo periodicamente para garantir que não ele não apresenta danos ou riscos. Se houver, é necessário que o brinquedo seja retirado de uso. Crianças devem ser supervisionadas enquanto brincam.
- GR** Πριν την χρήση αφαιρέστε όλα τα υλικά της συσκευασίας. Διατηρήστε αυτές τις πληροφορίες, τις διευθύνσεις και τους αριθμούς τηλεφώνου για μελλοντική αναφορά. Το περιεχόμενο ενδέχεται να διαφέρει από τις εικόνες. Η Meccano διατηρεί το δικαίωμα να διακόψει τη λειτουργία της τοποθεσίας www.meccano.com ανά πάσα στιγμή. Ένας ενήλικας θα πρέπει να εξετάζει τακτικά αυτό το παιχνίδι και να διακόπτει τη χρήση του σε περίπτωση εντοπισμού βλαβών ή κινδύνων. Τα παιδιά θα πρέπει να παίζουν υπό επίτηρηση.
- S** Ta bort alla förpackningar före användning. Spara den här informationen, adresser och telefonnummer för framtida referens. Innehållet kan skilja sig från bilderna. Meccano förbehåller sig rätten att när som helst ta bort webbplatsen www.meccano.com. En vuxen ska regelbundet undersöka den här leksaken för att säkerställa att det inte finns några skador eller faror rörande den. Om det finns några ska den inte användas längre. Håll borta från hinder och elektriska risker.
- DK** Fjern al emballage før brug. Gem disse oplysninger, adresser og telefonnumre for fremtidig brug. Indholdet kan være forskelligt fra billederne. Meccano forbeholder sig ret til at nedlægge hjemmesiden www.meccano.com til enhver tid. En voksen bør med jævne mellemrum undersøge leken for å se om den er skadet, eller om det foreligger noen fare. Hvis det er tilfellet, må leken ikke lenger brukes. Barn bør holdes under oppsyn når de leker.
- FIN** Poista kaikki pakkausmateriaali ennen käyttöä. Säilytä nämä tiedot, osoitteet ja puhelinnumerot tulevia tarpeita varten. Sisältö saattaa poiketa kuvista. Meccano pidättää oikeuden lakkauttaa sivuston www.meccano.com milloin tahansa. Aikuisen tulee säännöllisesti tarkistaa, että lelu ei ole vaurioitunut ja muuttunut vaaralliseksi. Jos näin on käynyt, lelu tulee poistaa käytöstä. Lasten tulee leikkiä vain aikuisen valvonnassa.
- R** Снимите все упаковочные материалы перед использованием. Запишите указанные на упаковке адреса и номера телефонов, чтобы у вас была возможность связаться с нами. Содержимое упаковки может отличаться от иллюстрации. Компания Meccano оставляет за собой право прекратить использование сайта www.meccano.com в любое время. Регулярно проверяйте состояние игрушки на наличие повреждений и возможных рисков для ребенка. Если таковые имеются, игрушку не следует использовать. Во время игры за детьми следует присматривать.

Made in China for: / Fabriqué en Chine pour: / Hecho en China por:



© 03/2014 MECCANO for packaging, instructions and models built with this set. © 03/2014 MECCANO pour l'emballage, les notices et modèles de ce coffret. © MECCANO is an exclusive trademark of MECCANO. Spin Master logo is a trademark of Spin Master Ltd. © MECCANO est une marque de commerce exclusive de MECCANO. Le logo de Spin Master est une marque de commerce de Spin Master Ltd. All rights reserved. Tous droits réservés.

SPIN MASTER LTD., 450 FRONT STREET WEST, TORONTO, ON M5V 1B6 CANADA.
IMPORTED into EU by SPIN MASTER INTERNATIONAL, S.A.R.L.,
16 AVENUE PASTEUR, L-2310, Luxembourg. www.spinmaster.com



UK – 0800 206 1191, SERVICEUK@SPINMASTER.COM
FRANCE – 0800 909 150, SERVICEFR@SPINMASTER.COM
ESPAÑA – SERVICIO@SPINMASTER.COM
DEUTSCHLAND – 0800 0101 0222, KUNDENSERVICE@SPINMASTER.COM
SCHWEIZ – 0800 561 350 • ÖSTERREICH – 0800 29 72 67
NEDERLAND – 0800 022 36 83, KLANTENSERVICE@SPINMASTER.COM
BELGIË/BELGIQUE – 0800 77 688 • LUXEMBOURG – 800 28 044
ITALIA – 800 788 532, SERVIZIO@SPINMASTER.COM
MEXICO – 53.51.44.00
WWW.SPINMASTER.COM



NORTH AMERICA: 1-800-622-8339 customercare@spinmaster.com
AMÉRIQUE DU NORD:

- ⚠ Warning! CHOKING HAZARD - Small parts.
- ⚠ Attention ! RISQUE D'ETOUFFEMENT - Contient de petits éléments.
- ⚠ Advertencia: PELIGRO DE ASFIXIA - Contiene piezas pequeñas.
- ⚠ No conveniente para niños menores de 3 años.
- ⚠ Achtung: ERSTICKUNGSGEFAHR - Kleinteile.
- ⚠ Waarschuwing: VERSTIKKINGSGEVAAR - Kleine onderdelen.
- ⚠ Attenzione: RISCHIO DI SOFFOCAMENTO - Pezzi piccoli.
- ⚠ Aviso: PERIGO DE ASFIXIA - Peças pequenas.
- ⚠ Προειδοποίηση: ΚΙΝΔΥΝΟΣ ΠΝΙΓΜΟΥ — Μικρά μέρη.
- ⚠ Warning: RISK FOR KVAVNING - Små delar.
- ⚠ Advarsel: KVAELNINGSFARE - Små dele.
- ⚠ Varoitus: TUKEHTUMISVAARA - Pieniä osia.
- ⚠ Осторожно! ОПАСНОСТЬ УДУШЬЯ - мелкие детали.



T91739_0001_20068316_GML_IB_R1_W1