



MULTIMODELS™

CONSTRUCTION: LOADER
CHANTIER : CHARGEUSE



- Ⓜ Merci d'imprimer à échelle 1 sans les marges de l'imprimante.
- Ⓜ Please print at scale 1 without the printer margins.
- Ⓜ Don Maßstab 1 bitte randlos drucken.
- Ⓜ Stampare la scala 1 senza i margini della stampante.
- Ⓜ Imprimir a escala 1 sin los márgenes de la impresora.
- Ⓜ É favor imprimir escala 1 sem as margens da impressora.
- Ⓜ Skriv ut i skala 1 utan skrivarens marginaler.
- Ⓜ Portaiden painatuksen jälkeen reunat eivät saa näkyä.
- Ⓜ Udskriv venligst i målestoksforhold 1 uden printermarginer.
- Ⓜ É favor imprimir escala 1 sem as margens da impressora.
- Ⓜ Σας παρακαλώ τυπώστε την κλίμακα 1 μέσα στα περιθώρια του εκτυπωτή.
- Ⓜ Пожалуйста, печатайте в масштабе 1:1 без отступов от края.

8+

Instructions
Notice de montage
Instrucciones de construcción
Bauanleitung
Bouwinstructie
Istruzioni
Instruções
Οδηγίες
Instruktioner
Monteringsinstruktioner
Ohjeet
Инструкции

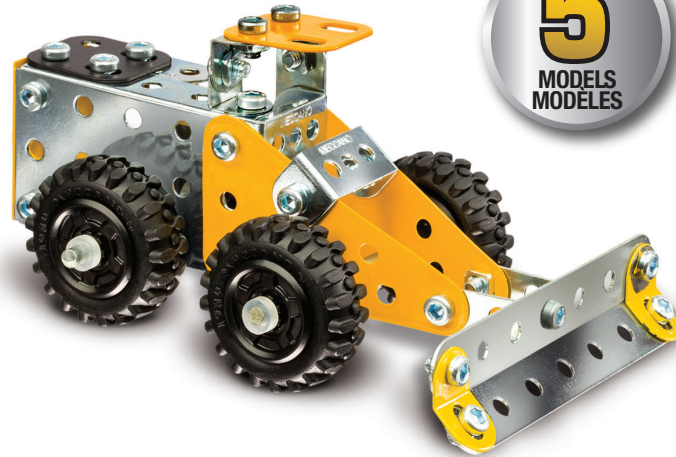

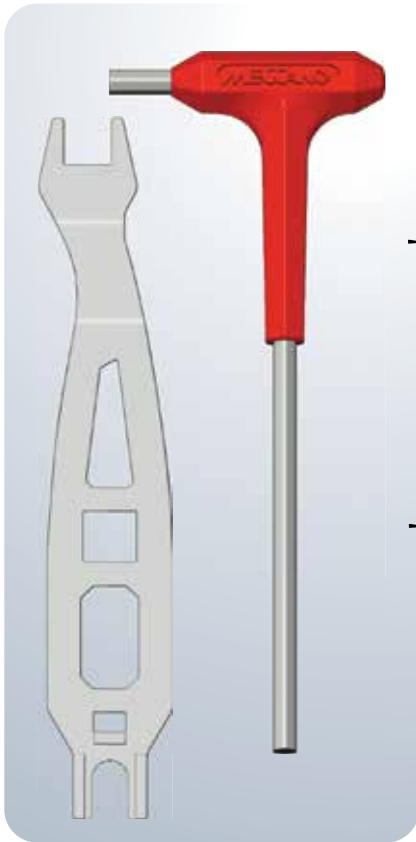

CONSTRUCTION TIPS
ASTUCES DE CONSTRUCTION
 TIPS DE CONSTRUCCIÓN
 TIPPS ZUM BAUEN
 MONTAGETIPS
 SUGGERIMENTI PER COSTRUIRE
 DICAS DE MONTAGEM
 ΣΥΜΒΟΥΛΕΣ ΚΑΤΑΣΚΕΥΗΣ
 BYGGTIPS
 BYGGTIPS
 КОКОАМІСОНІЕ
 РЕКОМЕНДАЦІЇ ПО СБОРКЕ

1

2

3

1

2

NEW TOOLS/NOUVEAUX OUTILS
 NUEVAS HERRAMIENTAS/NEUE WERKZEUGE/NIEUW GEREEDSCHAP
 NUOVI ATTREZZI/NOVAS FERRAMENTAS/NEA ΕΡΓΑΛΕΙΑ/NYA VERKTYG
 NYE VÆRKTØJER/UJEDET TYÖKALUT/НОВЫЕ ИНСТРУМЕНТЫ

TABLE OF CONTENTS/SOMMAIRE

ÍNDICE/INHALTSVERZEICHNIS/INHOUD/INDICE/ΠΙΝΑΚΑΣ ΠΕΡΙΕΧΟΜΕΝΩΝ/
INNEHÅLLSFÖRTECKNING/INDHOLDSFORTEGNELSE/SISÄLLYSLUETTELO/СОДЕРЖАНИЕ



4



11



17

AVAILABLE ONLINE / DISPONIBLES EN LIGNE

DISPONIBLES EN LÍNEA / ONLINE VERFÜGBAR / ONLINE BESCHIKBAAR /
DISPONIBILI ONLINE / DISPONÍVEL ONLINE / ΔΙΑΤΙΘΕΝΤΑΙ ΣΤΟ
ΔΙΑΔΙΚΤΥΟ / TILLGÄNGLIGA ONLINE / KAN KØBES ONLINE / SAATAVILLA
VERKOSSA / ДОСТУПНЫ В ОНЛАЙН-МАГАЗИНЕ





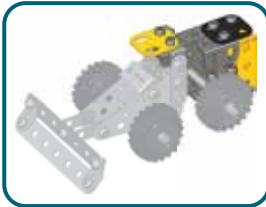

- Ⓔ Content: 95 parts, 2 real tools and 1 instruction sheet for 3 models.
- Ⓔ Contenu : 95 pièces, 2 vrais outils et 1 notice de montage pour 3 modèles.
- Ⓔ Contenido: 95 piezas, 2 herramientas reales y 1 guía de instrucciones para 3 modelos.
- Ⓔ Inhalt: 95 Teile, 2 echte Werkzeuge und 1 Bauanleitung für 3 Modelle.
- Ⓔ Inhoud: 95 onderdelen, 2 stuks gereedschap en 1 bouw instructie voor 3 modellen.
- Ⓔ Contenuto: 95 pezzi, 2 attrezzi e 1 guida per l'uso per 3 modelli.
- Ⓔ Conteúdo: 95 peças, 2 ferramentas reais e 1 folha de instruções para 3 modelos.
- Ⓔ Περιεχόμενα: 95 κομμάτια, 2 Πραγματικά εργαλεία, 1 φυλλάδιο οδηγιών για 3 μοντέλα.
- Ⓔ Innehåll: 95 delar, 2 riktiga verktyg och 1 instruktionsblad för 3 modeller.
- Ⓔ Indhold: 95 dele, 2 rigtige værktøjer og 1 instruktionsark til 3 modeller.
- Ⓔ Sisältö: 95 osaa, 2 aidot työkalut ja käyttöohje 3 mallia varten.
- Ⓔ В коробке: 95 деталей, 2 настоящих инструмента и 1 инструкция по сборке 3 моделей.

- Ⓔ Building instructions for the 2 other models are available at www.meccano.com
- Ⓔ Les notices de montage des 2 autres modèles sont disponibles sur www.meccano.fr.
- Ⓔ Hay instrucciones de construcción disponibles para los otros 2 modelos en www.meccano.com
- Ⓔ Bauanleitungen für die anderen 2 Modelle sind auf www.meccano.com zu finden.
- Ⓔ Bouwinstructies voor de andere 2 modellen zijn beschikbaar op www.meccano.com
- Ⓔ Le istruzioni di montaggio degli altri 2 modelli sono disponibili alla pagina www.meccano.com
- Ⓔ Instruções de montagem dos restantes 2 modelos disponíveis em www.meccano.com.
- Ⓔ Οι οδηγίες κατασκευής για τα υπόλοιπα 2 μοντέλα είναι διαθέσιμες στο www.meccano.com
- Ⓔ Bygganvisningar för de 2 andra modellerna finns på www.meccano.com.
- Ⓔ Vejledning til de 2 andre modeller er findes på www.meccano.com.
- Ⓔ Muiden mallien (2 kpl) kokoamisohjeet ovat saatavilla osoitteessa www.meccano.com.
- Ⓔ Инструкции по сборке 2 других моделей можно найти на сайте www.meccano.com.
- Ⓔ Building instructions for the 2 other models are available at www.erecator.us.

GB. Only one model can be built at a time. F. Les pièces fournies ne permettent de monter qu'un seul modèle à la fois. E. Solo es posible construir un modelo a la vez. D. Jeweils nur eins der Modelle baubar. NL. Er kan maar een model tegelijk worden gebouwd. I. Consente di realizzare un solo modello per volta. P. Só é possível montar um modelo de cada vez. GR. Μπορείτε να δημιουργείτε μόνο ένα μοντέλο κάθε φορά. S. Endast en modell kan byggas i taget. DK. Der kan kun bygges én model af gangen. FIN. Osista voidaan koota kerrallaan vain yksi malli. R. Одновременно можно построить только одну модель.



1

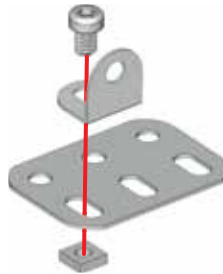

-  **x1**
-  **x1**
-  **x1**
-  **x1**



- | | | |
|--|-----------|------------|
|  | S1 | 1:1 |
|--|-----------|------------|



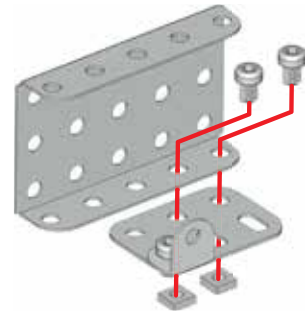

2

-  **x1**
-  **x2**
-  **x2**



- | | | |
|---|-----------|------------|
|  | S1 | 1:1 |
|---|-----------|------------|



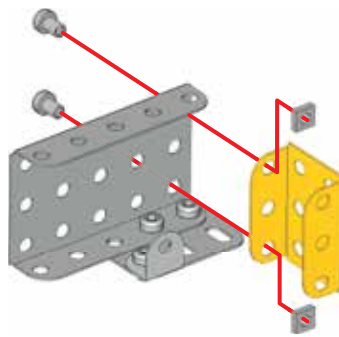

3

	x1
 5,8 mm 15/64"	x2
	x2

	1:1
---	------------





4

	x1
	x1
 5,8 mm 15/64"	x1
	x1

	1:1
--	------------





5 ③ + ④ +

 5,8 mm 15/64"	x2
	x2

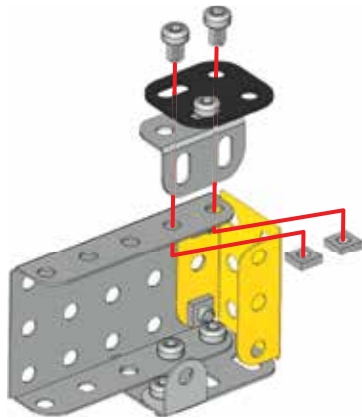
	1:1
---	------------



6

	x1
 5,8 mm 15/64"	x1
	x1

	1:1
---	------------

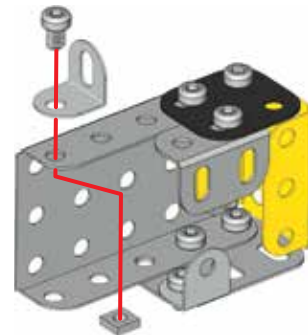

7

	x1
	x2
	x2
	x2

	S1	1:1
--	-----------	------------

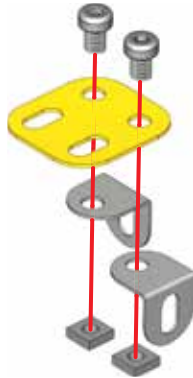

8 ⑥ + ⑦ +

	x1
	x1

	S1	1:1
--	-----------	------------

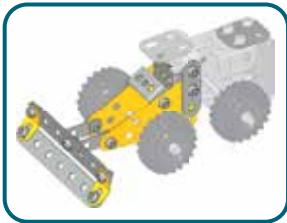
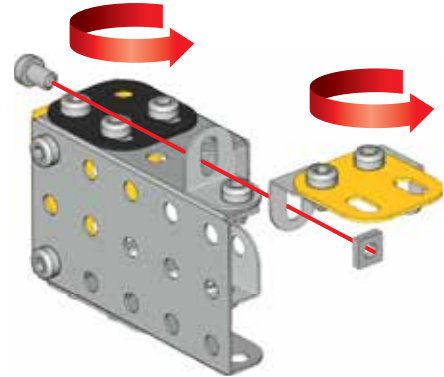



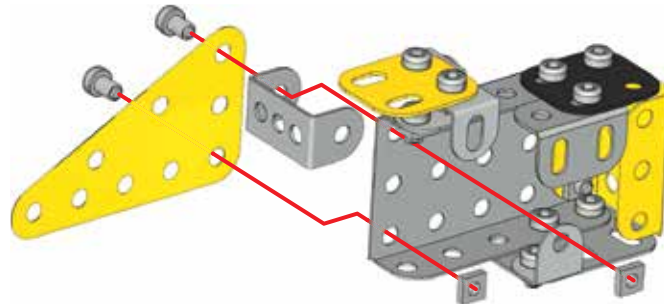

9

	x1
	x1
	x2
	x2

	S1	1:1
--	-----------	------------





10

-  **x1**
-  **x1**
-  5,8 mm | **x2**
15/64"
-  **x2**

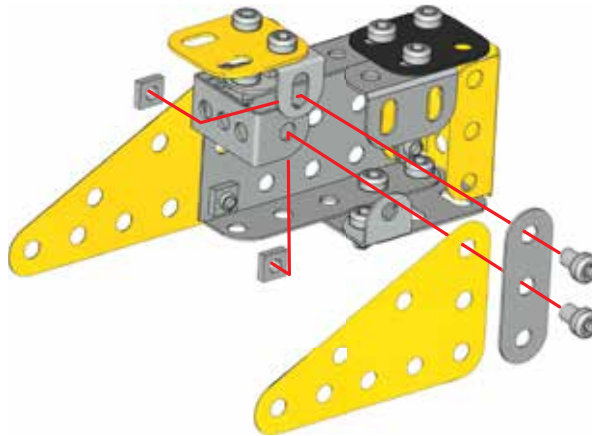
 **S1** **1:1**



11

-  **x1**
-  5,8 mm | **x2**
15/64"
-  **x2**

 **S1** **1:1**

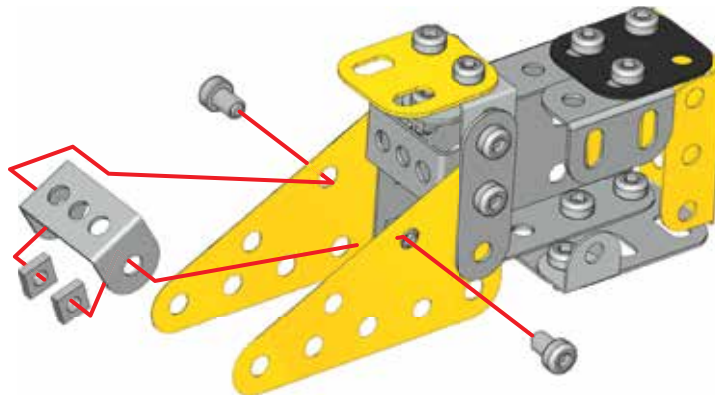

12

	x1
	x1
	x1
	x1

	S1	1:1
--	-----------	------------

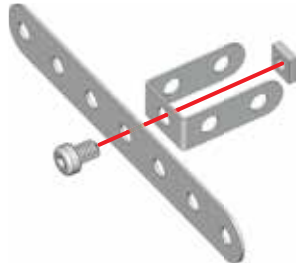

13

	x1
	x2
	x2
	x2

	S1	1:1
--	-----------	------------

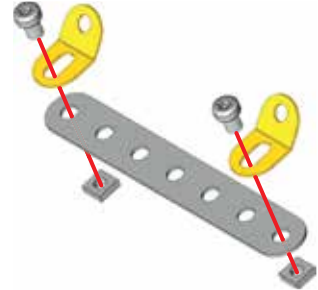

14 (12) + (13) +

	S1	x2
	x2	

	S1	1:1
--	-----------	------------

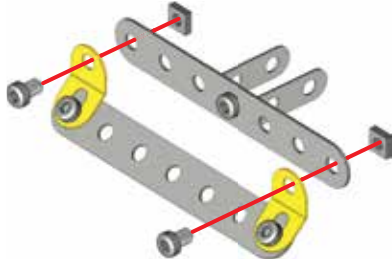

15 (11) + (14) +

	S1	x2
	x2	

	S1	1:1
--	-----------	------------

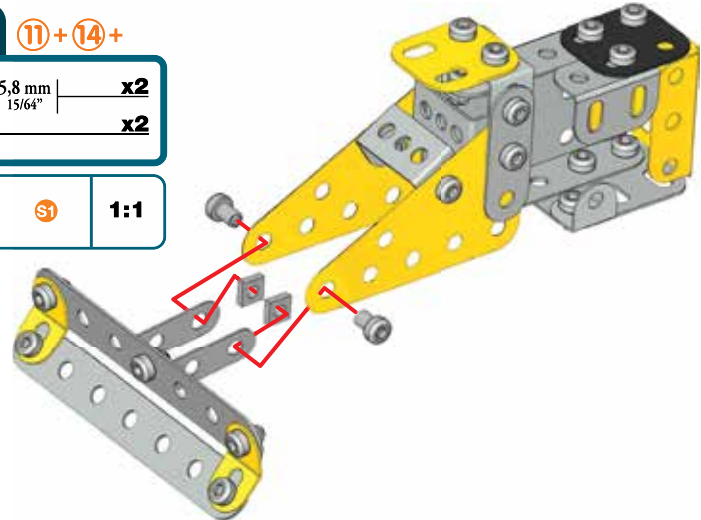

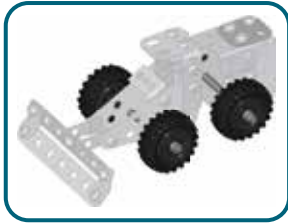

16

	x4
	x4



17 (15) + (16) +

	75 mm 3"	x1
		x4
		x2

		A238	1:1

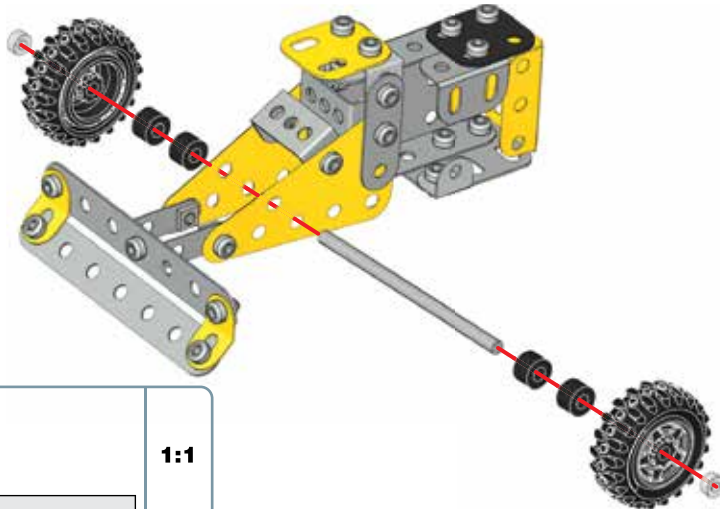

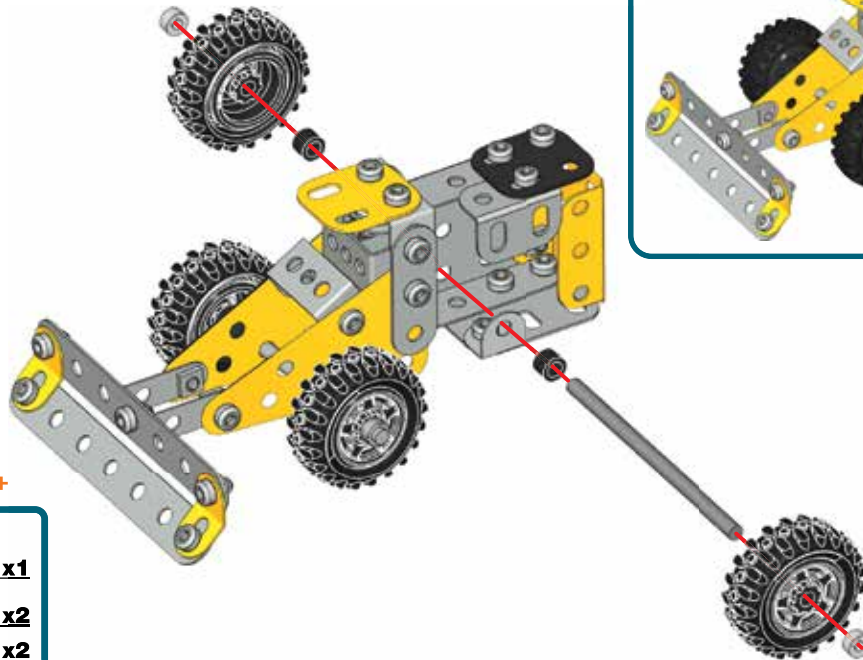

18 (16) + (17) +

	75 mm 3"	x1
		x2
		x2

	A338	1:1





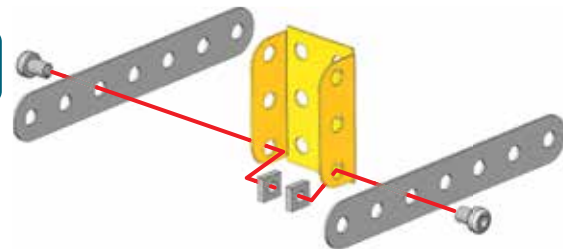

1

	x2
	x1
	x2
	x2

	S1	1:1
--	----	------------





2

	x1	
	x2	
	5,8 mm 15/64"	x2
	x2	

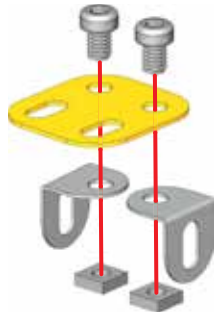
	S1	1:1
---	----	-----





3 ① + ② +

	5,8 mm 15/64"	x1
	x1	

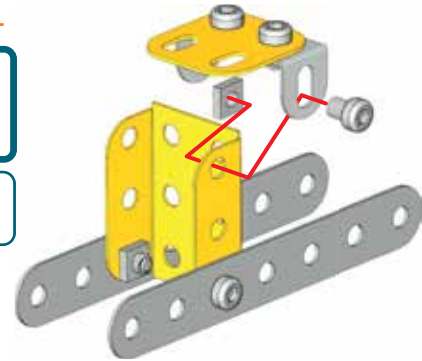
	S1	1:1
---	----	-----





4

	5,8 mm 15/64"	x1
	x1	

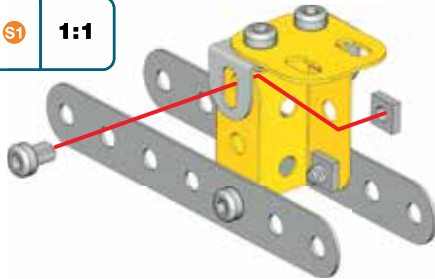
	S1	1:1
---	----	-----





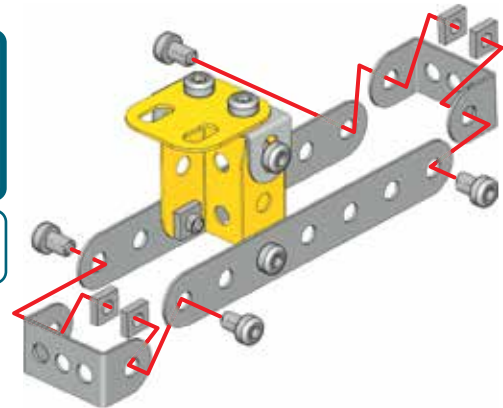

5

	x2	
	5,8 mm 15/64"	x4
	x4	

	S1	1:1
---	----	-----





6

	x1
	x1
 5,8 mm 15/64"	x2
	x2

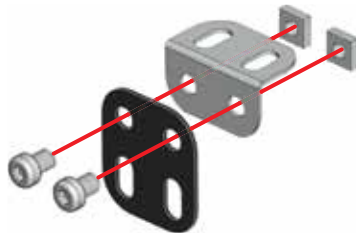
	S1	1:1
---	----	-----



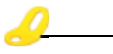

7

	x2
 5,8 mm 15/64"	x2
	x2

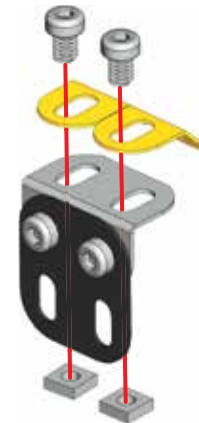
	S1	1:1
--	----	-----





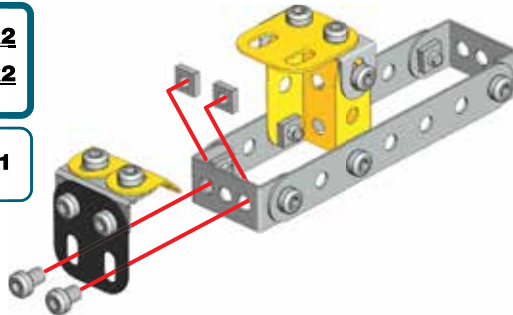

8 (5) + (7) +

 5,8 mm 15/64"	x2
	x2

	S1	1:1
---	----	-----



9

	x1
	x1
 5,8 mm 15/64"	x1
	x1

	S1	1:1
--	----	-----

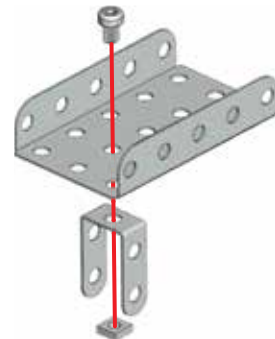

10

	x2
	x4
	x4

	S1	1:1
--	-----------	------------

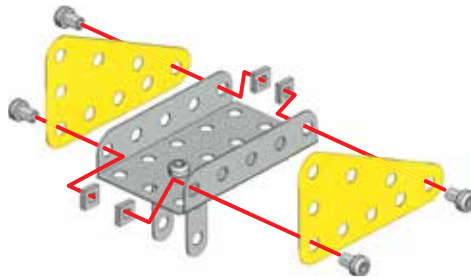

11

	x2
	x2
	x2

	S1	1:1
--	-----------	------------

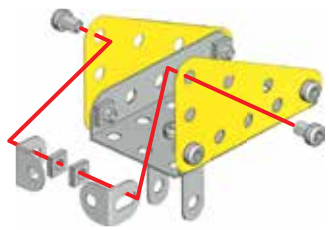

12

	x2
	x2
	x2

	S1	1:1
--	-----------	------------

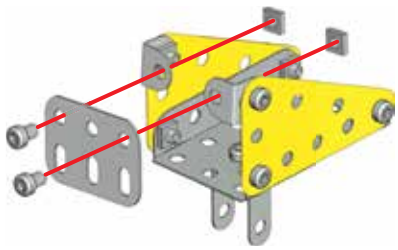

13

	x1
	x1
	x2
	x2

	S1	1:1
--	-----------	------------

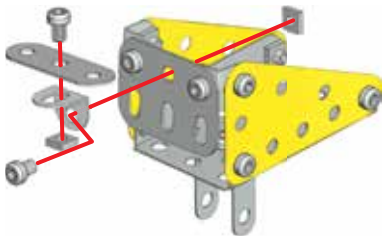

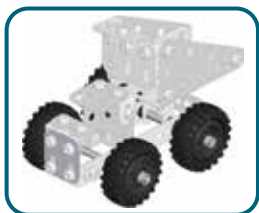



14

 **x2**

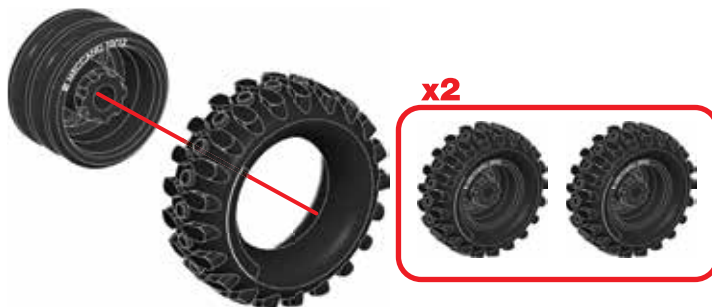
 **x2**



15

 **x2**

 **x2**

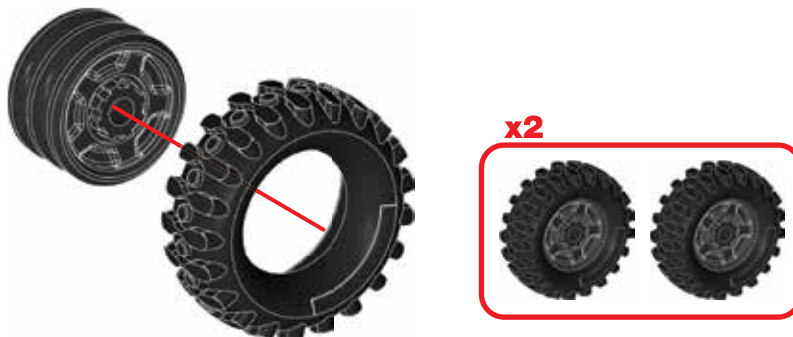

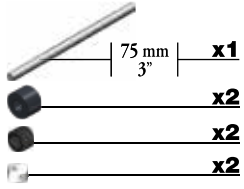
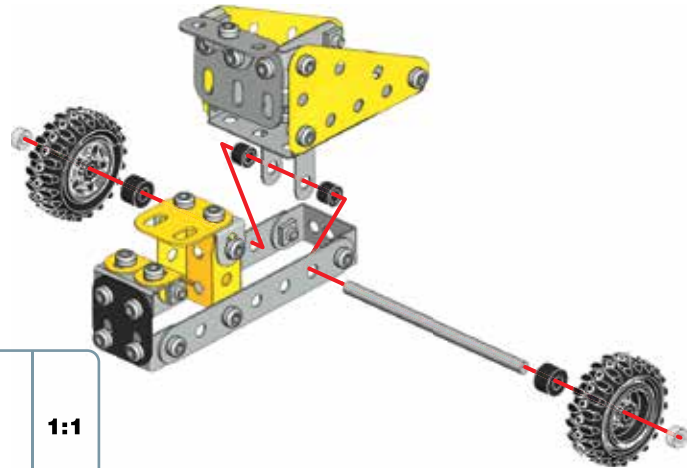
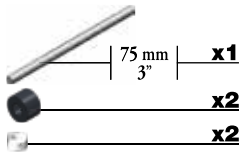
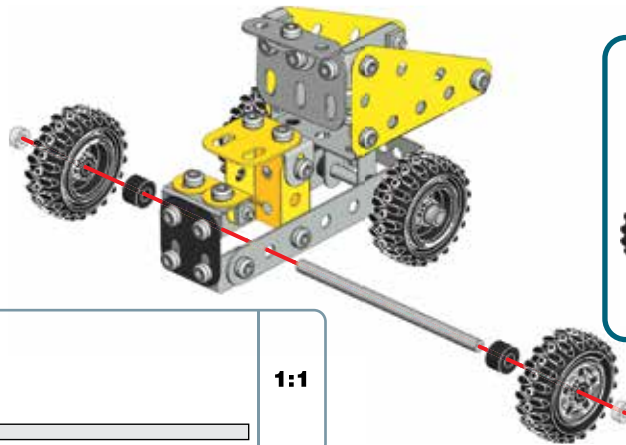
16**(8) + (13) + (14) +****1:1****17****(15) + (16) +****1:1**



1

	x1
	x2
	x2
	x2

	S1	1:1
--	-----------	------------

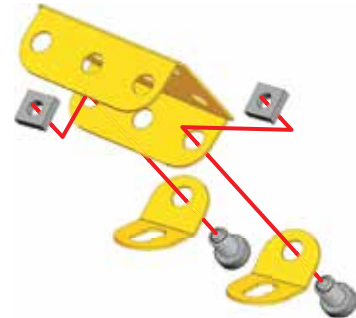

2

	x1
	x2
	x2

	S1	1:1
--	-----------	------------

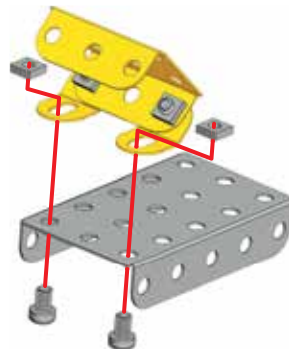

3

	x1
	x1
	x1

	S1	1:1
--	-----------	------------

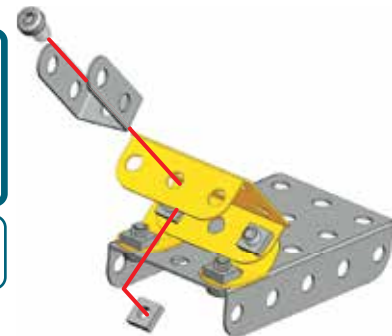

4

	x1
	x1
	x1
	x1

	S1	1:1
--	-----------	------------

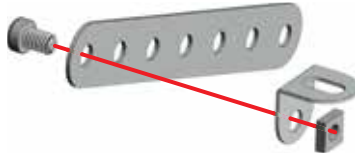

5 **3 + 4 +**

	S1	5,8 mm 15/64"	x1
			x1

	S1	1:1
--	-----------	------------

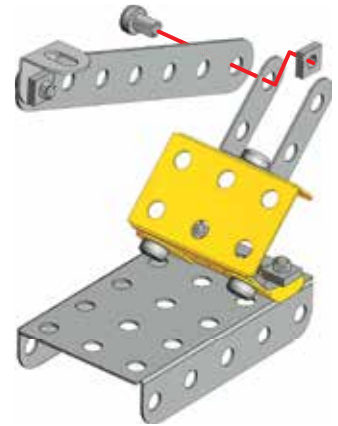

6

	x1
	x1
	x1
	x1

	S1	1:1
--	-----------	------------

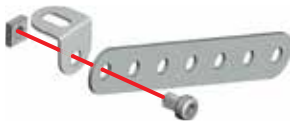



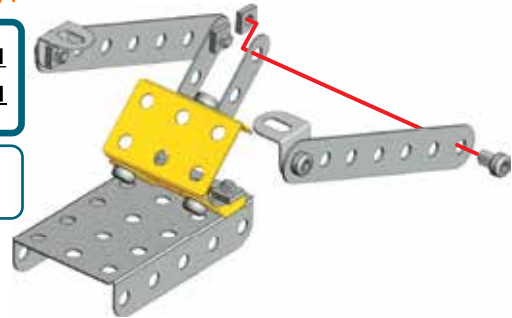

7 **5 + 6 +**

	S1	5,8 mm 15/64"	x1
			x1

	S1	1:1
--	-----------	------------





8

-  **x1**
-  **x1**
-  5,8 mm | **x2**
15/64"
-  **x2**

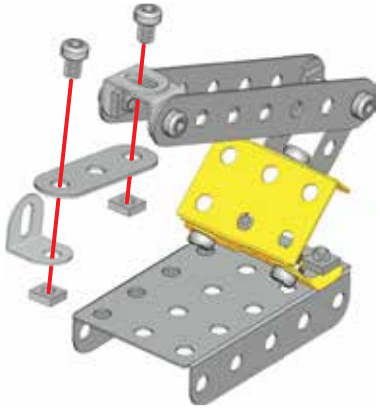
	S1	1:1
---	-----------	------------





9

-  **x1**
-  5,8 mm | **x1**
15/64"
-  **x1**

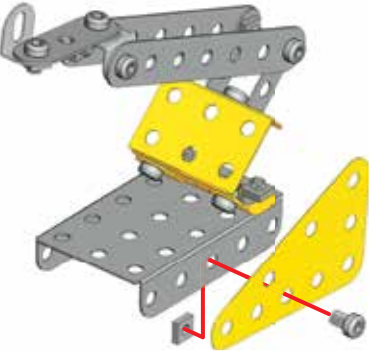
	S1	1:1
---	-----------	------------



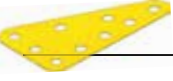

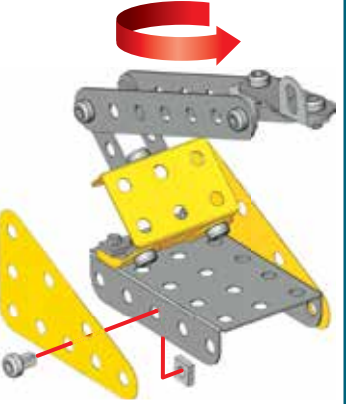

10

-  **x1**
-  5,8 mm | **x1**
15/64"
-  **x1**

	S1	1:1
--	-----------	------------





11

-  **x1**
-  **x2**
-  5,8 mm | **x2**
15/64"
-  **x2**

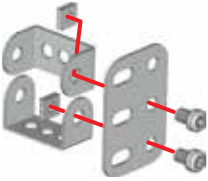
	S1	1:1
---	-----------	------------





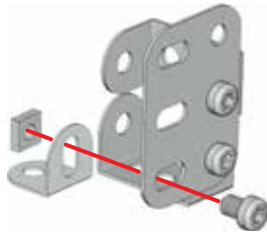

12

	x1
 5,8 mm 15/64"	x1
	x1



	 1:1
---	---

**13**

	x1
	x1
 5,8 mm 15/64"	x3
	x3

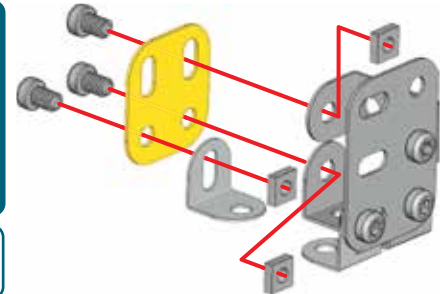

	 1:1
---	--

**14**

	x1
 5,8 mm 15/64"	x2
	x2

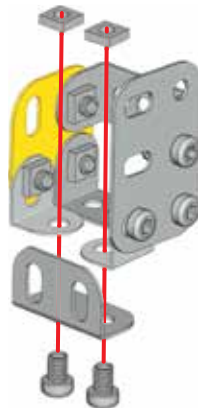
	 1:1
--	---



**15**

	x1
 5,8 mm 15/64"	x2
	x2

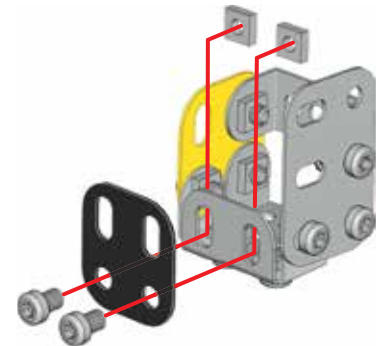
	 1:1
--	---





16 10 + 15 +

	5,8 mm 15/64"	x1
		x1

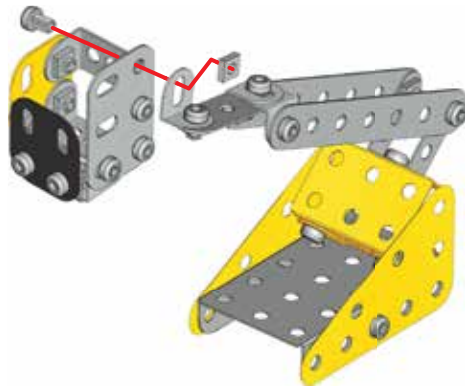
	S1	1:1
---	-----------	------------





17

	x4
	x4

x4

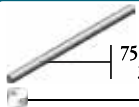

18 16 + 17 +

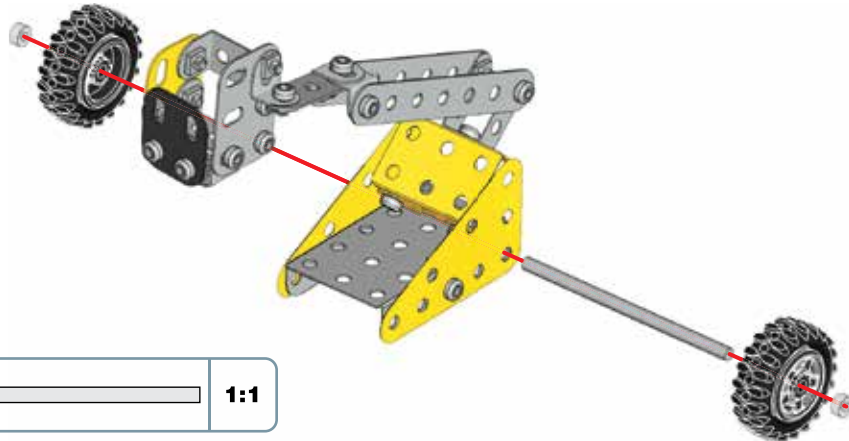

	75 mm 3"	x1
		x2

	1:1
---	------------

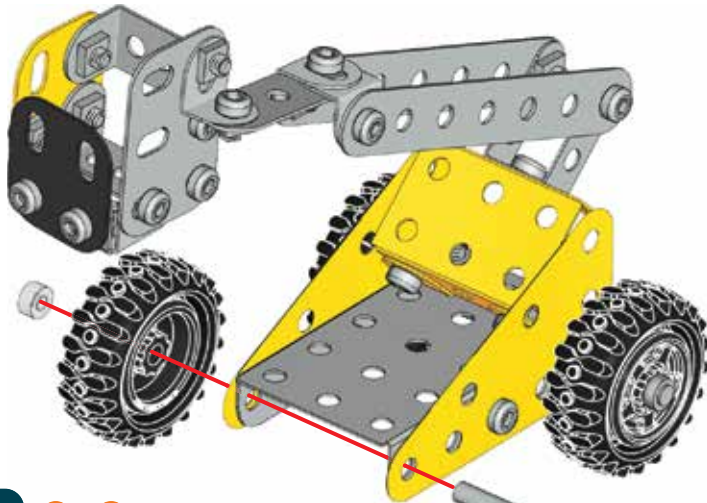



19 (17) + (18) +

	75 mm 3"	x1
		x2

	1:1
---	------------





A251 (0051F) x 1



A221 (0221) x 2



A252 (0051A) x 1



A307 (0103H) x 1



A503 (0103L) x 1



A503 (0103L) x 1



A436 (0811A) x 1



A381 (0142F) x 4



C876 x 4



A548 (0048E) x 2



A506 (0006A) x 1



A309 (0009L) x 1



A012 (0012) x 5



A712 (0012C) x 2



A203 (0003) x 2



A016 (0016B) x 2



A238 (0038A) x 4



A338 (0038B) x 2



A259 (0059C) x 4



A637 (0037B) x 27



A337 (0037A) x 27



C995 x 1



C993 x 1

GB Remove all packaging before use. Retain this information, addresses and phone numbers for future reference. Content may vary from pictures. Meccano reserves the right to discontinue the website www.meccano.com at any time. An adult should periodically check this toy to ensure no damage or hazard exist if so, remove from use. Children should be supervised during play.

F Retirer tout l'emballage avant utilisation. Conserver les informations, adresses et numéros de téléphone pour consultation ultérieure. Le contenu peut différer des images. Meccano se réserve le droit de supprimer le site Internet www.meccano.fr à tout moment. Un adulte doit régulièrement examiner ce jouet afin de s'assurer qu'il ne présente pas de dommage ni de risque. En cas de problème, ne plus l'utiliser. Les enfants doivent être surveillés lorsqu'ils jouent.

E Retire todo el embalaje antes de utilizar el producto. Conserve toda la información, las direcciones y los números de teléfono para futuras referencias. El contenido del paquete puede no corresponder con las imágenes. Meccano se reserva el derecho a suspender el sitio web www.meccano.com en cualquier momento. Un adulto debe revisar de forma periódica el juguete para asegurarse de que no supone un riesgo o peligro para el niño; si así fuera el caso, interrumpa su uso. Supervise a los niños mientras juegan con el producto.

D Entfernen Sie vor der Benutzung sämtliche Verpackungsmaterialien. Alle Informationen, Adressen und Telefonnummern bitte für mögliche Rückfragen aufbewahren. Der Packungsinhalt kann von den Bildern abweichen. Meccano behält sich das Recht vor, den Betrieb der Website www.meccano.com jederzeit einzustellen. Ein Erwachsener sollte regelmäßig sicherstellen, dass das Spielzeug keine Gefahr darstellt, und es gegebenenfalls entfernen. Kinder sollten beim Spielen beaufsichtigt werden.

- ⚠ Warning! CHOKING HAZARD - Small parts.
- ⚠ Attention ! RISQUE D'ÉTOUFFEMENT - Contient de petits éléments.
- ⚠ Advertencia: PELIGRO DE ASFIXIA - Contiene piezas pequeñas. No conveniente para niños menores de 3 años.
- ⚠ Achtung: ERSTICKUNGSGEFAHR - Kleinteile.
- ⚠ Waarschuwing: VERSTIKKINGSGEVAAR - Kleine onderdelen.
- ⚠ Attenzione: RISCHIO DI SOFFOCAMENTO - Pezzi piccoli.

NL Verwijder de verpakking voor gebruik. Bewaar deze informatie, adressen en telefoonnummers voor toekomstig gebruik. Inhoud kan afwijken van illustraties. Meccano behoudt zich het recht voor de website www.meccano.com wanneer gewenst buiten gebruik te stellen. Een volwassene dient dit speelgoed regelmatig te controleren op schade en gevaren. Ouderlijk toezicht is vereist als kinderen met dit speelgoed spelen.

I Rimuovere l'imballo prima dell'uso. Conservare informazioni, indirizzi e numeri di telefono per riferimento futuro. Il prodotto potrebbe essere differente dalle immagini. Meccano si riserva il diritto di rimuovere il sito www.meccano.com in qualsiasi momento. Il giocattolo deve essere periodicamente controllato da un adulto per prevenire eventuali danni o rischi; in caso di danno, sospendere l'uso. I bambini devono essere sorvegliati durante il gioco.

P Remova totalmente a embalagem antes de utilizar. Guarde estas informações, as moradas e os números de telefone para consulta futura. O conteúdo poderá ser diferente das ilustrações. A Meccano reserva-se o direito de descontinuar o site www.meccano.com a qualquer altura. Um adulto deve verificar o brinquedo periodicamente para garantir que ele não apresenta danos ou riscos. Se houver, é necessário que o brinquedo seja retirado do uso. Crianças devem ser supervisionadas enquanto brincam.

GR Πριν την χρήση αφαιρέστε όλα τα υλικά της συσκευασίας. Διατηρήστε αυτές τις πληροφορίες, τις διευθύνσεις και τους αριθμούς τηλεφώνου για μελλοντική αναφορά. Το περιεχόμενο ενδέχεται να διαφέρει από τις εικόνες. Η Meccano διατηρεί το δικαίωμα να διακόψει τη λειτουργία της ιστοσελίδας www.meccano.com ανά πάσα στιγμή. Ένας ενήλικας θα πρέπει να ελέγχει τακτικά αυτό το παιχνίδι και να διακόπτει τη χρήση του σε περίπτωση εντοπισμού βλαβών ή κινδύνων. Τα παιδιά θα πρέπει να παίζουν υπό επίτηρηση.

- ⚠ Aviso: PERIGO DE ASFIXIA - Peças pequenas.
- ⚠ Προειδοποίηση: ΚΙΝΔΥΝΟΣ ΠΝΙΓΜΟΥ — Μικρά μέρη.
- ⚠ Warning: RISK FÖR KVÄVNING - Små delar.
- ⚠ Advarsel: KVAELNINGSGFARE - Små dele.
- ⚠ Varoitus: TUKEHTUMISVAARA - Pieniä osia.
- ⚠ Осторожно! ОПАСНОСТЬ УДУШЬЯ - мелкие детали.

S Ta bort alla förpackningar före användning. Spara den här informationen, adresser och telefonnummer för framtida referens. Innehållet kan skilja sig från bilderna. Meccano förbehåller sig rätten att när som helst ta bort webbplatsen www.meccano.com. En vuxen ska regelbundet undersöka den här leksaken för att säkerställa att det inte finns några skador eller faror rörande den. Barn ska hållas under uppsikt när de leker.

DK Fjern al emballage før brug. Gem disse oplysninger, adresser og telefonnumre for fremtidig brug. Indholdet kan være forskellig fra billederne. Meccano forbeholder sig ret til at nedlægge hjemmesiden www.meccano.com til enhver tid. En voksen bør jævnligt tjekke dette legetøj for at sikre, at det ikke er beskadiget eller udgør nogen fare, i så fald, stop brugen af det. Barn bør overvåges, når de leger med det.

FIN Poista kaikki pakkausmateriaali ennen käyttöä.Säilytä nämä tiedot, osoitteet ja puhelinnumerot tulevia tarpeita varten.Sisältö saattaa poiketa kuvista. Meccano pitääää oikeuden lakkauttaa sivuston www.meccano.com milloin tahansa. Aikuisen tulee säännöllisesti tarkistaa, että lelu ei ole vaurioitunut ja muuttunut vaaralliseksi. Jos näin on käynyt, lelu tulee poistaa käytöstä. Lasten tulee leikkiä vain aikuisen valvonnassa.

RU Снимите все упаковочные материалы перед использованием. Запишите указанные на упаковке адреса и номера телефонов, чтобы у вас была возможность связаться с нами. Содержимое упаковки может отличаться от иллюстраций. Компания Meccano оставляет за собой право прекратить использование сайта www.meccano.com в любое время. Взрослым следует время от времени проверять игру и следить за тем, чтобы она не была сломана и не представляла опасности для ребенка. В противном случае ее не следует использовать. Во время игры за детьми следует присматривать.



Made in France by: / Fabriqué en France par: / Hecho en Francia por:



SPIN MASTER LTD., 450 FRONT STREET WEST, TORONTO, ON M5V 1B6 CANADA.
Distributed in EU SPIN MASTER INTERNATIONAL, S.A.R.L.,
16 AVENUE PASTEUR, L-2310, LUXEMBOURG.

www.spinmaster.com

Meccano : 363, avenue de Saint-Exupéry 62100 Calais - France



TM & © 2015 MECCANO for packaging, instructions and models built with this set. TM & © 2015 MECCANO pour l'emballage, les notices et modèles de ce coffret. ® MECCANO is an exclusive trademark of MECCANO. Spin Master logo is a trademark of Spin Master Ltd. ® MECCANO est une marque de commerce exclusive de MECCANO. Le logo de Spin Master est une marque de commerce de Spin Master Ltd. All rights reserved. Tous droits réservés.

T91675_0007_20068711_GML_IB_R1W1_MEC_Loader



NORTH AMERICA : AMÉRIQUE DU NORD : 1-800-622-8339 customer@spinmaster.com

UK - 0800 206 1191, SERVICEUK@SPINMASTER.COM
FRANCE - 0800 909 150, SERVICEFR@SPINMASTER.COM
ESPAÑA - SERVICIO@SPINMASTER.COM
DEUTSCHLAND - 0800 0101 0222, KUNDENSERVICE@SPINMASTER.COM
SCHWEIZ - 0800 561 350 • ÖSTERREICH - 0800 29 72 67
NEDERLAND - 0800 022 36 83, KLANTENSERVICE@SPINMASTER.COM
BELGIË/BELGIQUE - 0800 77 688 • LUXEMBOURG - 800 28 044
ITALIA - 800 788 532, SERVIZIO@SPINMASTER.COM
MEXICO - 53.51.44.00
WWW.SPINMASTER.COM