

Instructions
Notice de montage
Bauanleitung
Istruzioni di montaggio
Instrucciones de montaje
Instruções de montagem
Monteringsanvisning
Kokoamisohje
Monterings instruktioner
Montagehandleiding

Οδηγίες συναρμολόγησης.
組立説明書

DESIGN 3

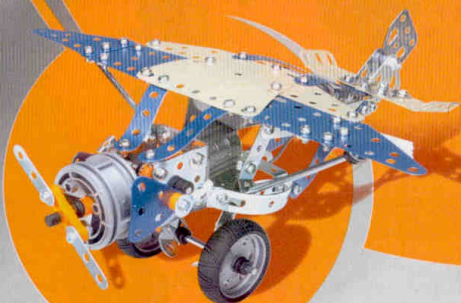

8-15



#6700

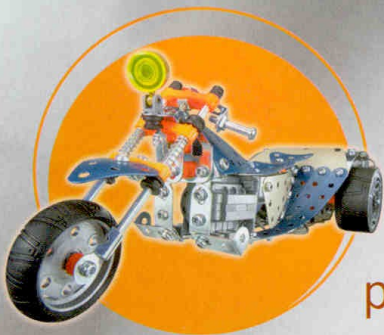

p.6

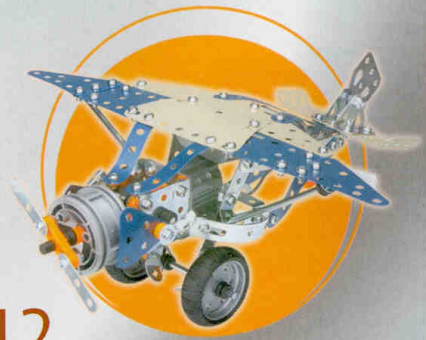

p.12



p.18



p.24



p.29

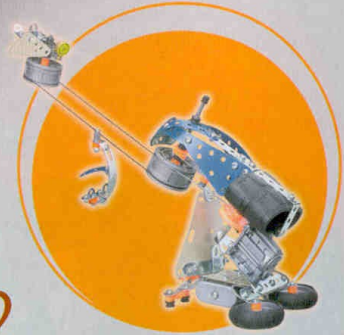

p.32

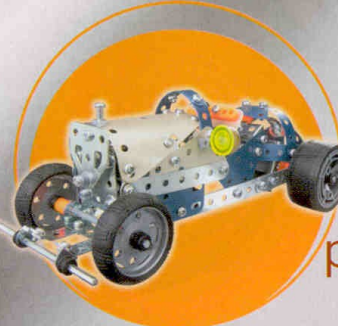

p.35



p.38



p.39

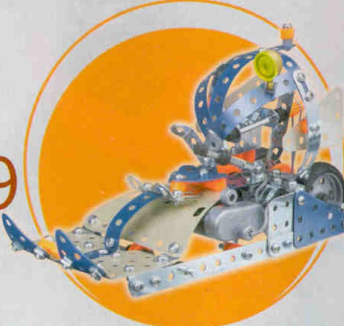

p.39



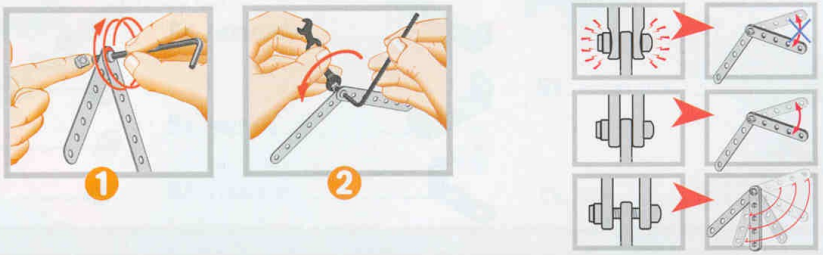
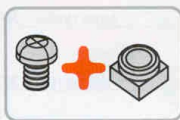
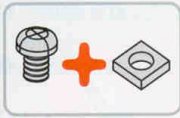
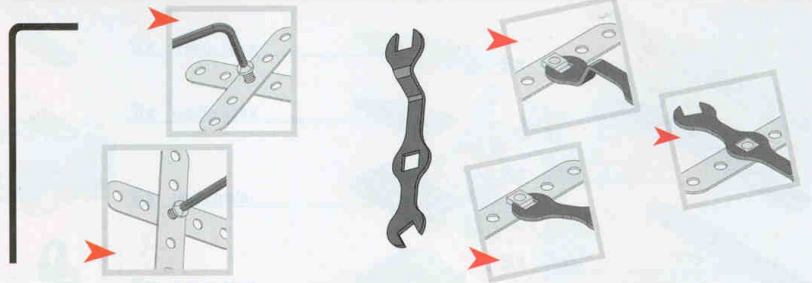
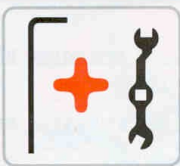

28 mm 1 1/8"		1
25,4 mm 1"		8
23 mm 29/32"		5
19,2 mm 3/4"		6
14,7 mm 9/16"		7
12 mm 1/2"		3
9,5 mm 3/8"		4
5,8 mm 15/64"		

Scale
Échelle
Maßstab
Scala

Escala
Schaal
Escala
Skala

Mittakaava
Målestok
Κλίμακα
スケール

1:1



50 mm 2"	
60 mm 2 3/8"	
100 mm 3 1/2"	
130 mm 3 1/2"	

1

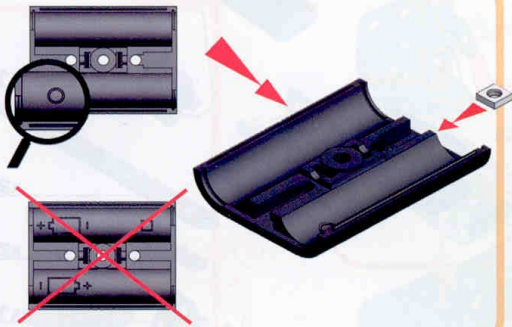

2

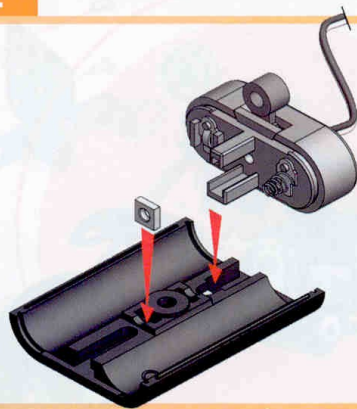

3



4



5

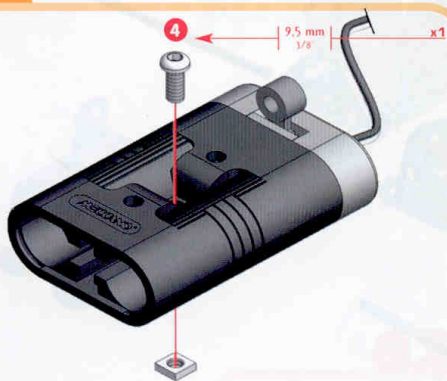

6



7



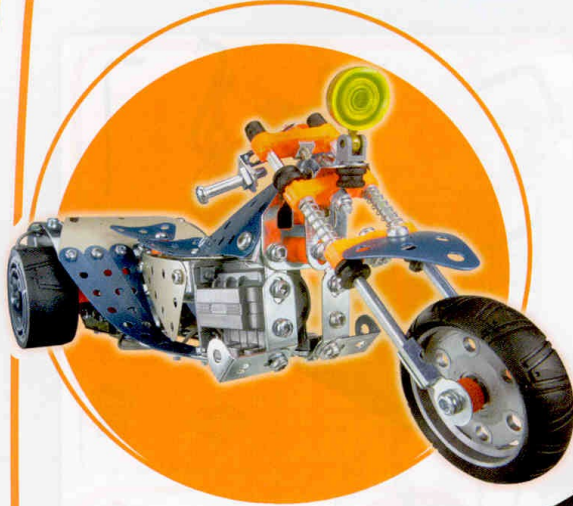

1

- x1
- x2
- x2
- x1
- x2
- 5,8 mm 15/64 x4
- x4

5

- x1
- x1

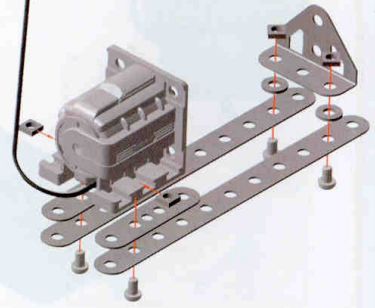

2

- 100 mm 3 1/2" x1
- x1
- x2
- x1
- x2
- 5,8 mm 15/64 x2
- x2



3

- x2
- x2
- 5,8 mm 15/64 x6
- x6

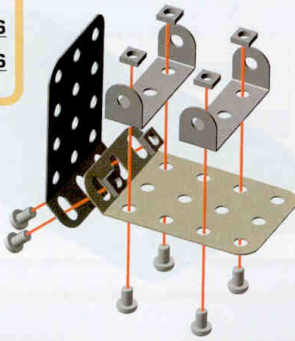

4

- x1
- x1
- x1
- x2
- x2
- 5,8 mm 15/64 x6
- x6

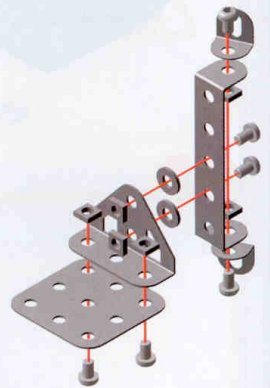

5 ② + ③ + ④ +

	x1
	x2
	x2
	x4
	x4

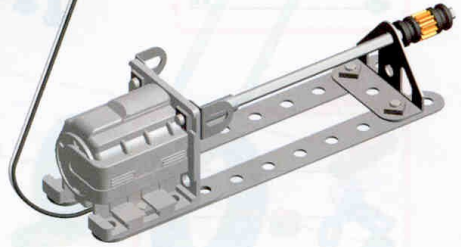
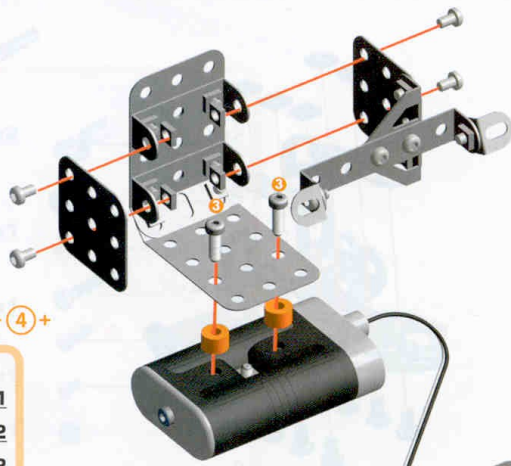

6 ⑤ +

	x2
	x2

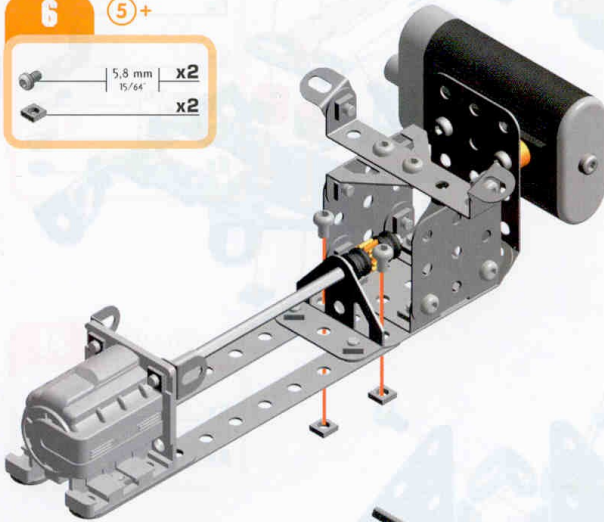

7

	x1
	x1
	x2
	x1

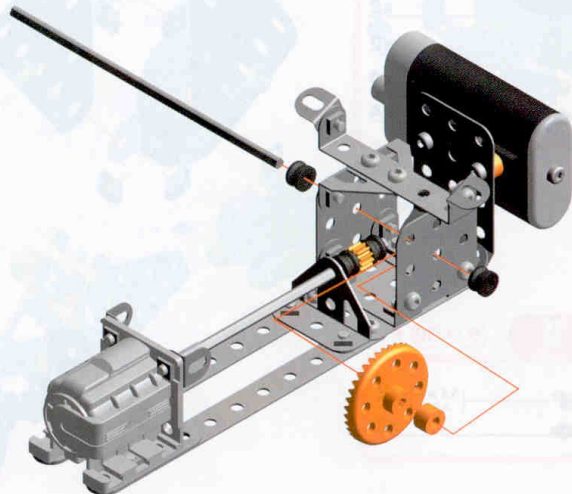

8

	x1
	x2
	x2
	x2
	x2
	x2
	x8
	x8

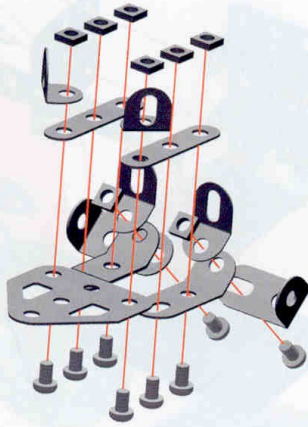
**9**

	x1
	x1
	x1
	x1
	x1
	x1
	x2
	x1
	x1
	x2
	x1
	x2

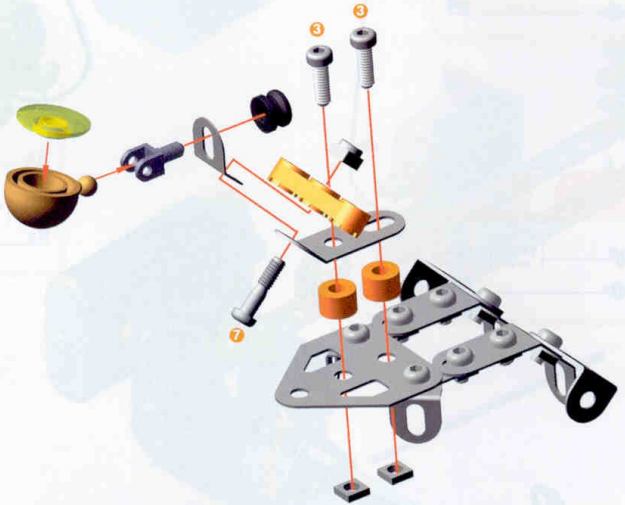
**10**

	x2
	x2
	x4
	x4

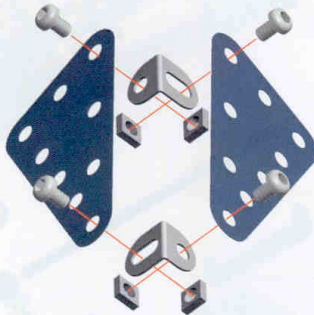
**11****9 + 10 +**

	x2
	x2

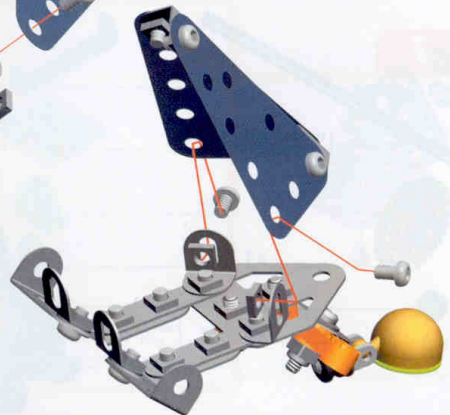

12



13

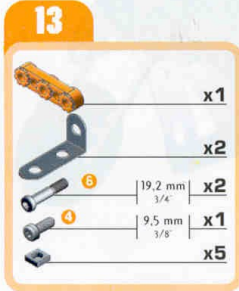

14

(12) + (13) +

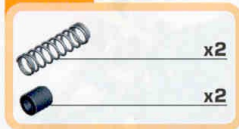



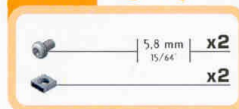

15

(7) + (14) +

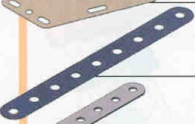



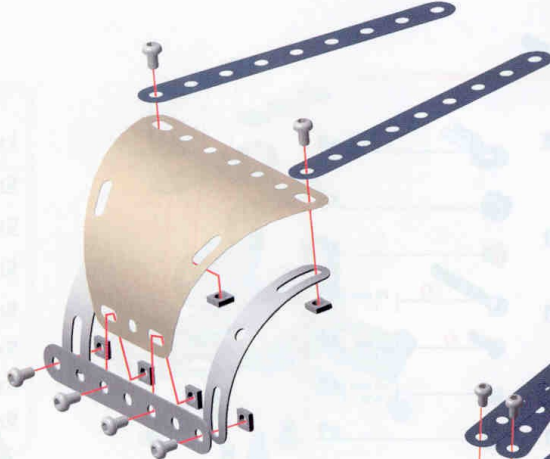

16

-  x1
-  x2
-  x1
-  x2
-  x6
-  x6







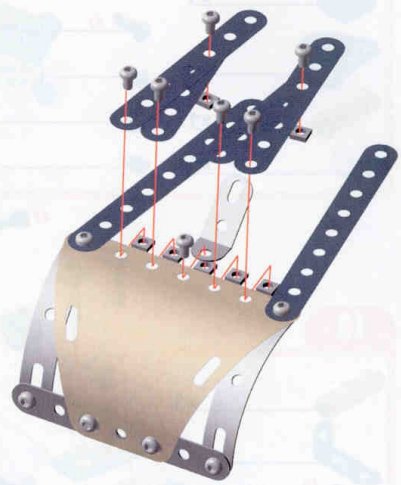

17

-  x2
-  x2
-  x1
-  x7
-  x7





18

-  x1
-  x2
-  x2
-  x1
-  x1
-  x2
-  x3



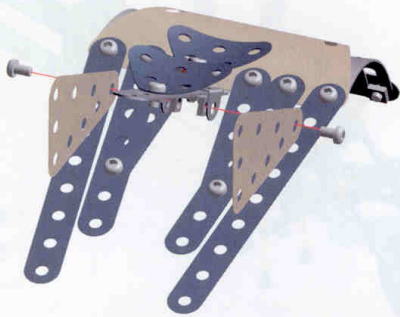

19

-  x2
-  x2
-  x2



20

15 + 19 +

	5,8 mm	x8
	15/64"	x8

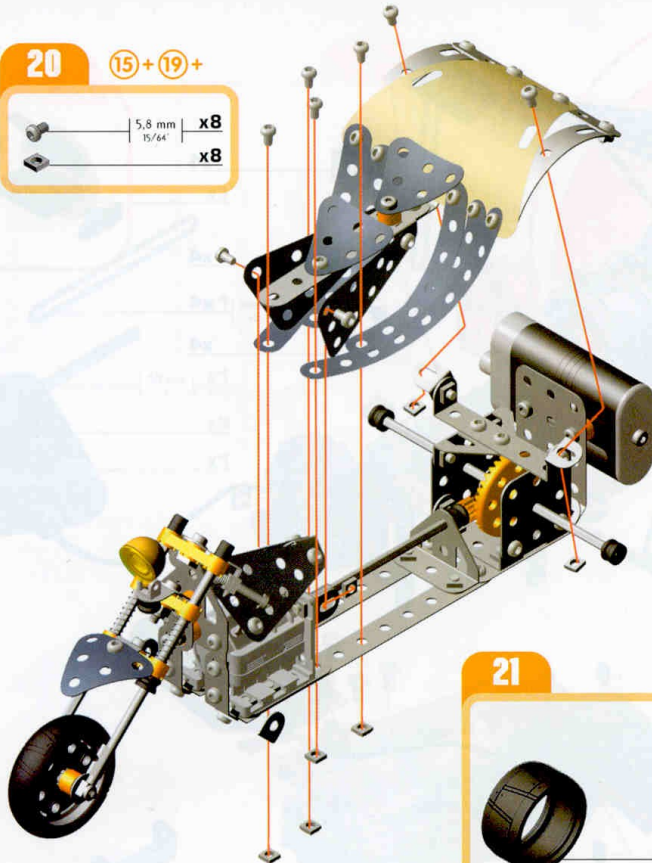

21

		x2
		x2
		x4
		x2

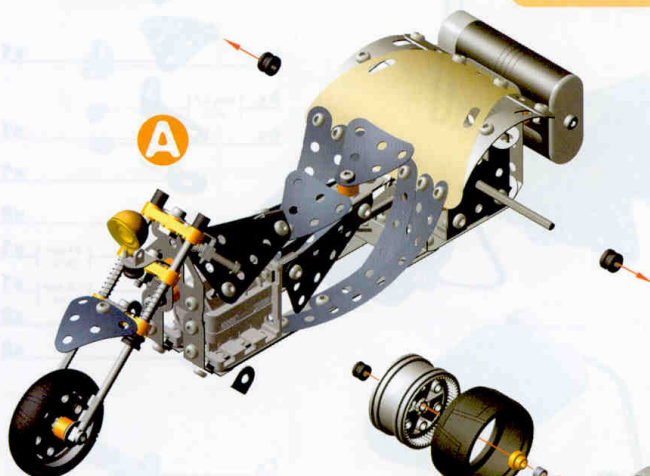



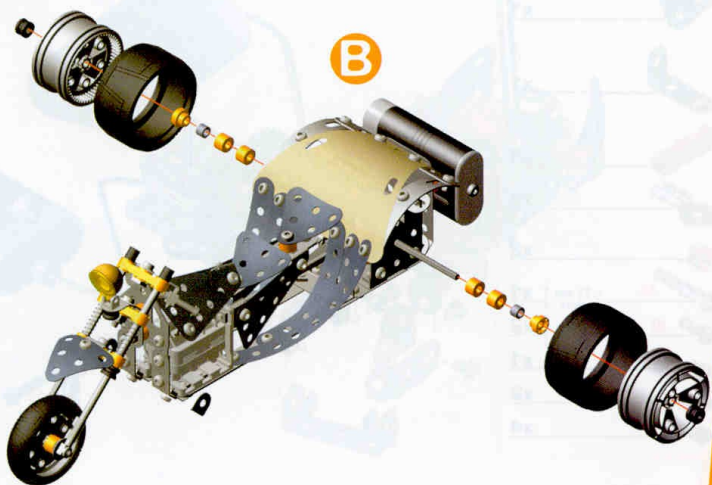

A

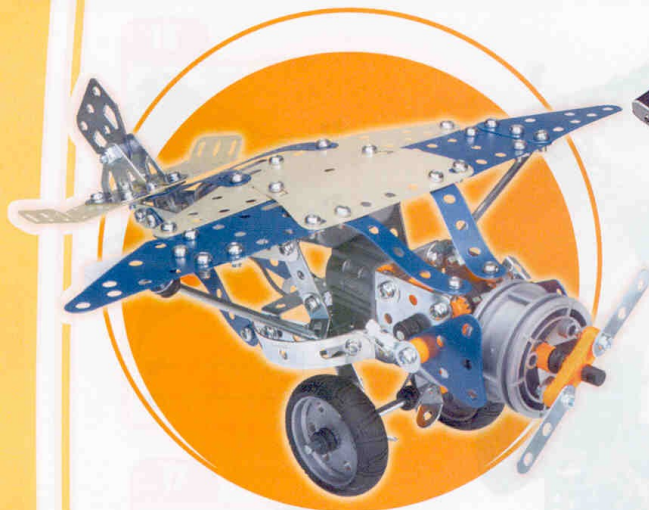







B





- 1**
-  x1
 -  x4
 -  x4
 -  x4

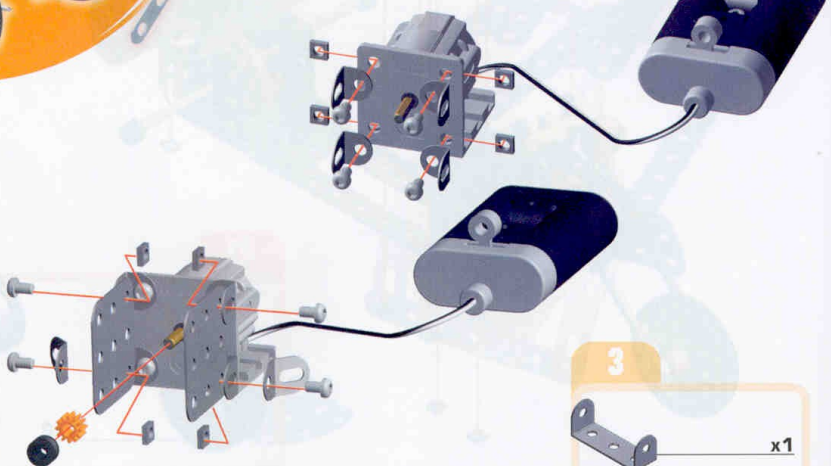

- 2**
-  x2
 -  x2
 -  x1
 -  x1
 -  x4
 -  x4



- 3**
-  x1
 -  x1
 -  x1
 -  x1
 -  x2
 -  x1
 -  x1
 -  x2
 -  x2

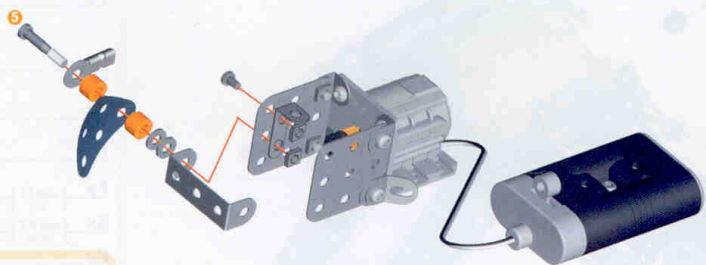

- 4**
-  x1
 -  x1
 -  x1
 -  x1
 -  x2
 -  x1
 -  x2
 -  x1
 -  x2
 -  x4

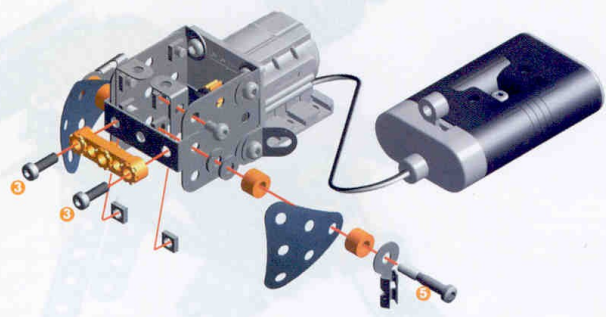

5



x1



x1



x1



x3



x1

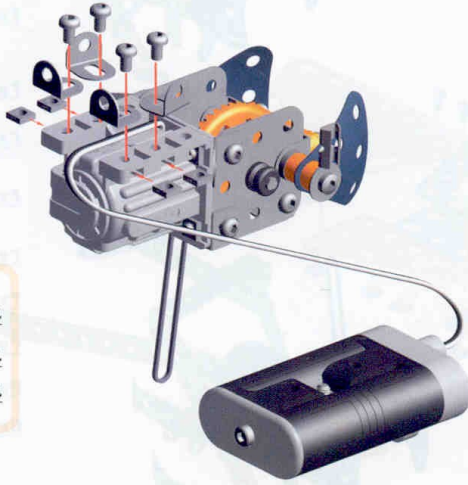
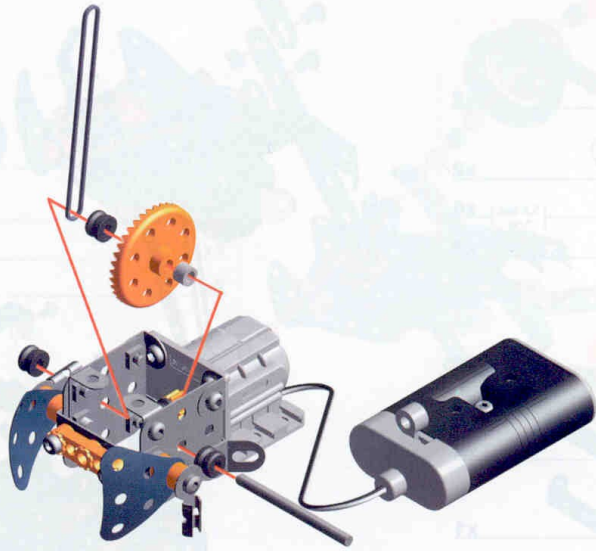

6



x4



x4



x4

7



x1



x2



x2







x4



x4





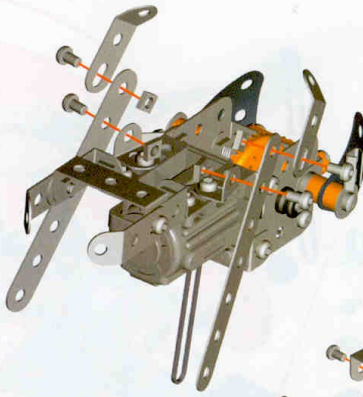

8

-  x2
-  x2
-  | 5,8 mm | 15/64" x4
-  x4





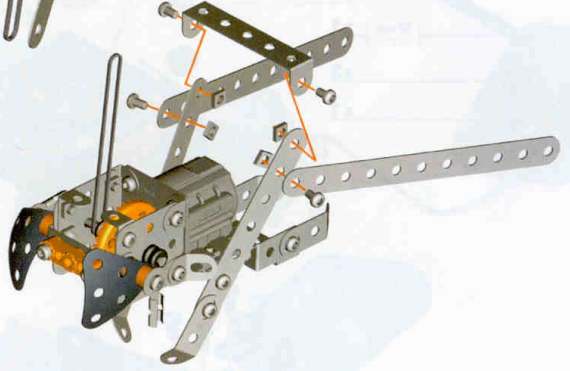

9

-  x2
-  x1
-  | 5,8 mm | 15/64" x4
-  x4



10

-  x2
-  x2
-  | 5,8 mm | 15/64" x4
-  x4

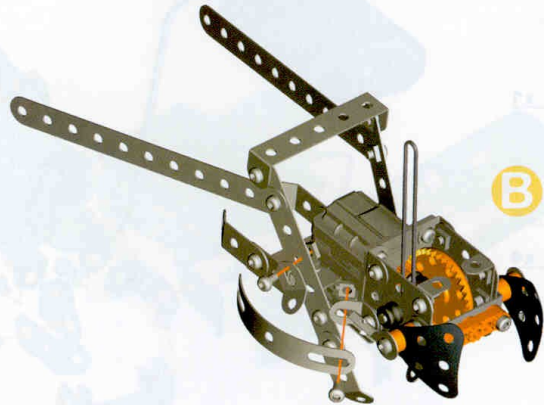
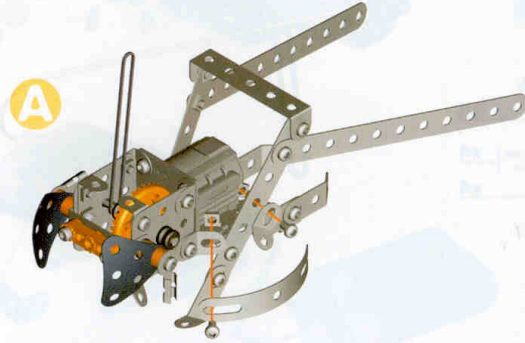

11

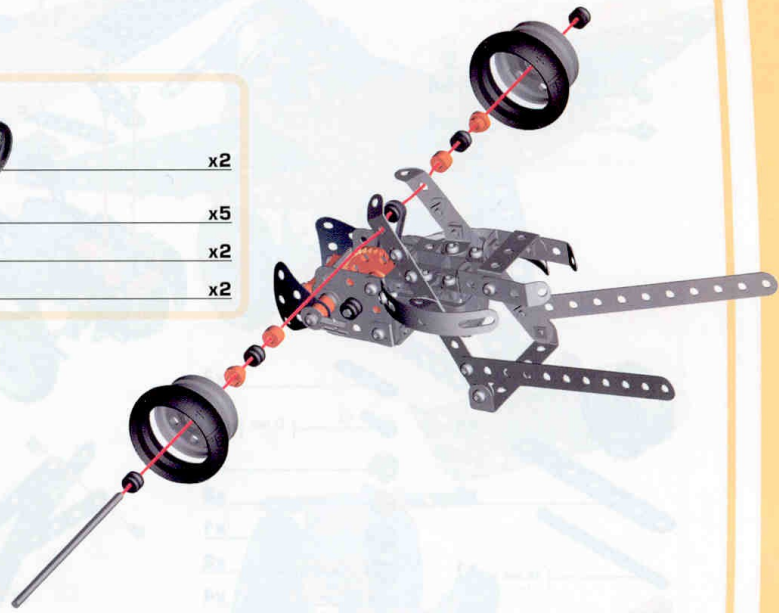
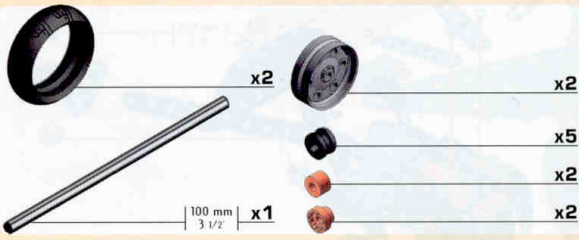

12

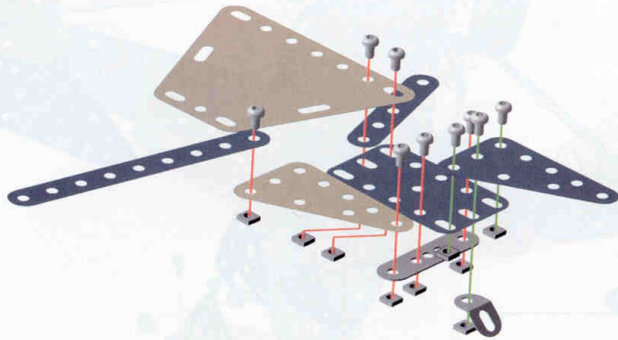
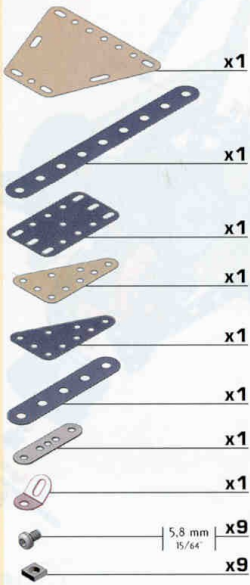

13

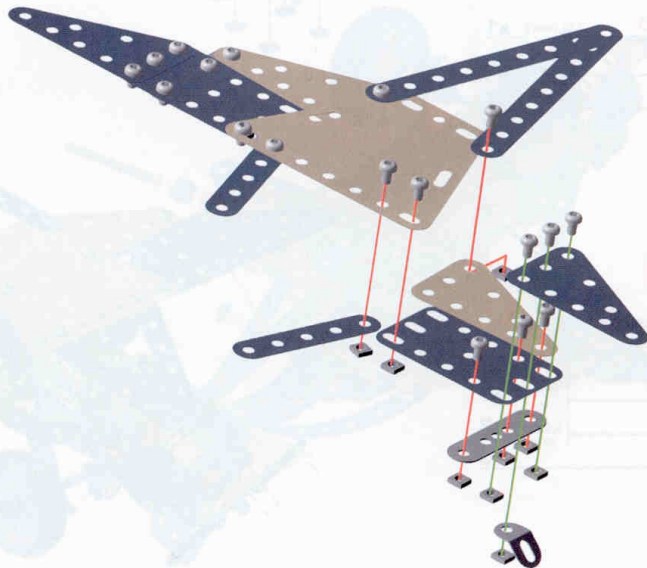
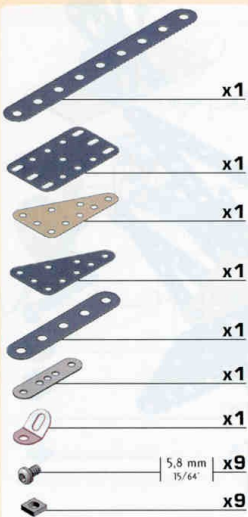



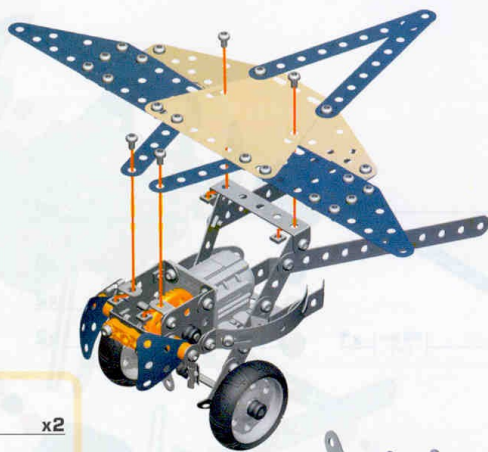

14

(11) + (14) +

	5,8 mm	x4
	15/64	x4



15

	x1
	x2
	60 mm x1
	2 1/8 x1

	x2
	12 mm x2
	1/2 x1
	x2
	x1
	x2
	5,8 mm x4
	15/64 x6

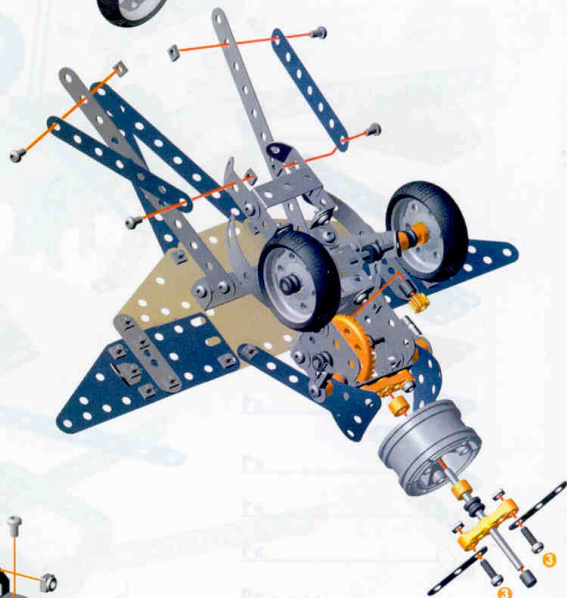

16

	x2
	x1
	x2
	x2
	x1
	x1
	19,2mm x1
	3/4 x1
	5,8 mm x4
	15/64 x4

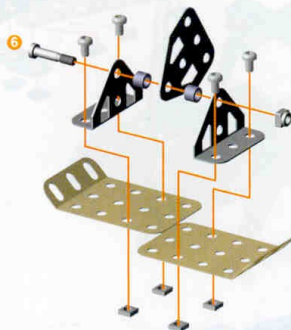

2

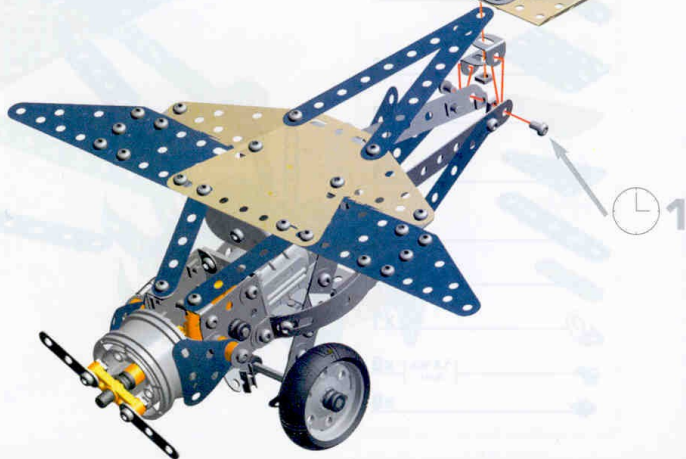

17

	x2
	12 mm x1
	1/2 x1
	5,8 mm x2
	15/64 x3



1

18

-  | 14,7 mm | x1
9/16
-  | x1
-  | x1

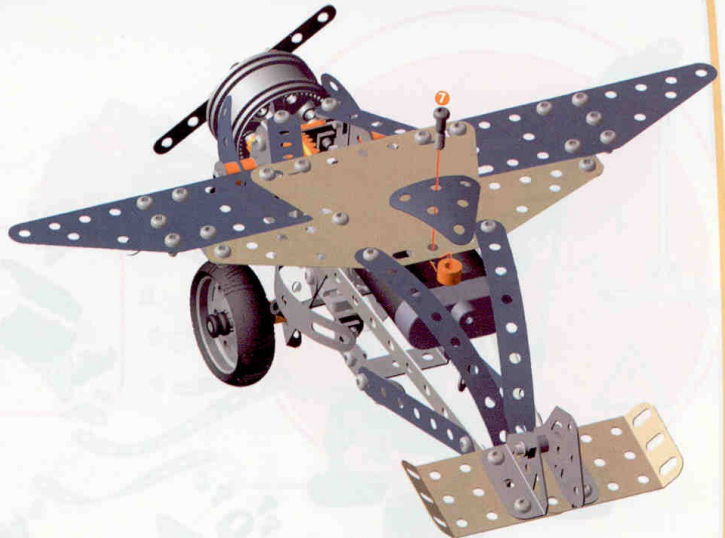

19

-  | 100 mm | x2
3 1/2
-  | x2
-  | x2







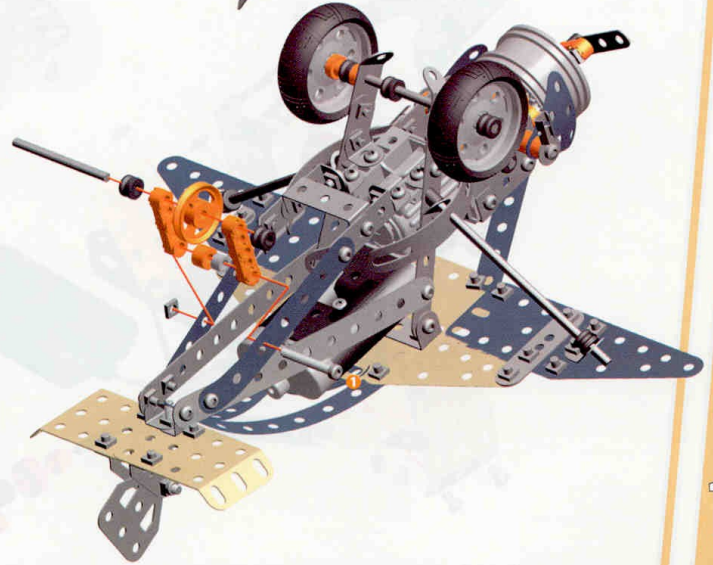







20

-  | 50 mm | x1
2"
-  | x2
-  | x1
-  | 28 mm | x1
1 1/8"
-  | x1
-  | x2
-  | x1
-  | x1









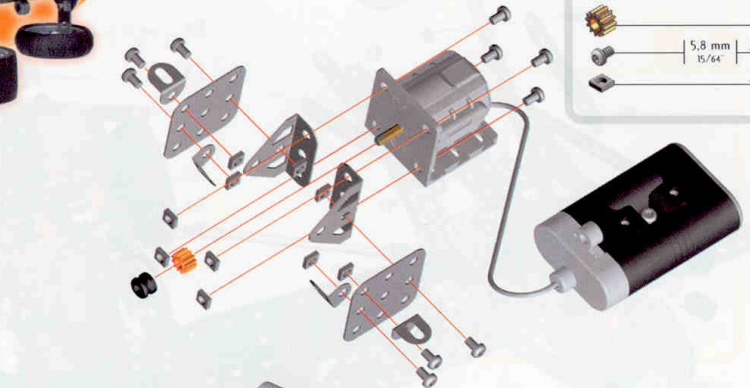

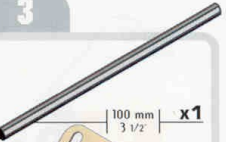



- 1**
-  x1
 -  x2
 -  x2
 -  x4
 -  x1
 -  x1
 -  x10
 -  x10







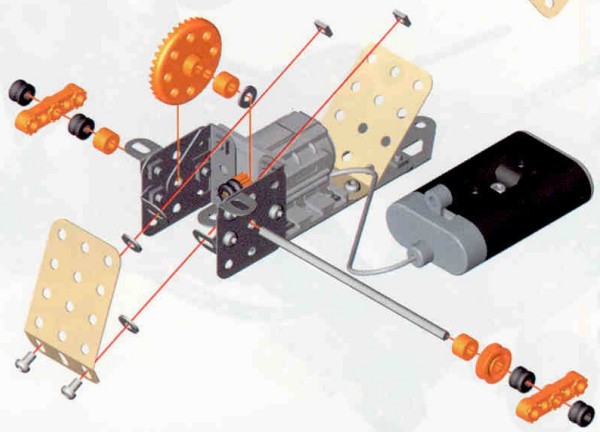

- 2**
-  x2
 -  x1
 -  x1
 -  5,8 mm x8
 -  15/64" x8



- 3**
-  100 mm x1
 -  3 1/2" x1
 -  x1
 -  x2
 -  x1
 -  x3
 -  x4
 -  x3
 -  5,8 mm x2
 -  15/64" x2







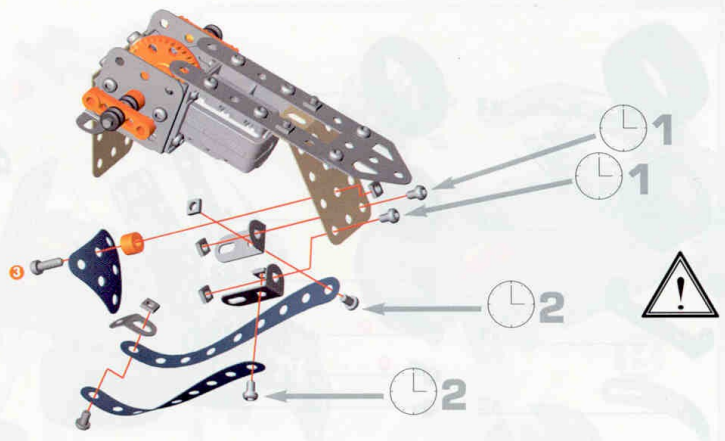

4

-  x2
-  x1
-  x2
-  x1
-  x1
-  12 mm | 1/2 | x1
-  5,8 mm | 15/64 | x5
-  x6



5

-  x2
-  x1
-  x2
-  x2
-  x2
-  5,8 mm | 15/64 | x5
-  x5

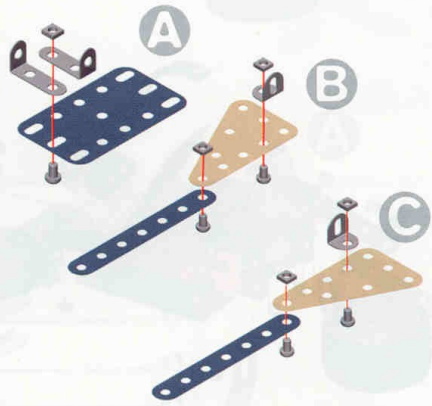

6

(4) + (5) +

-  50 mm | 2" | x1
-  x1
-  x2
-  12 mm | 1/2" | x1
-  5,8 mm | 15/64 | x2
-  x2

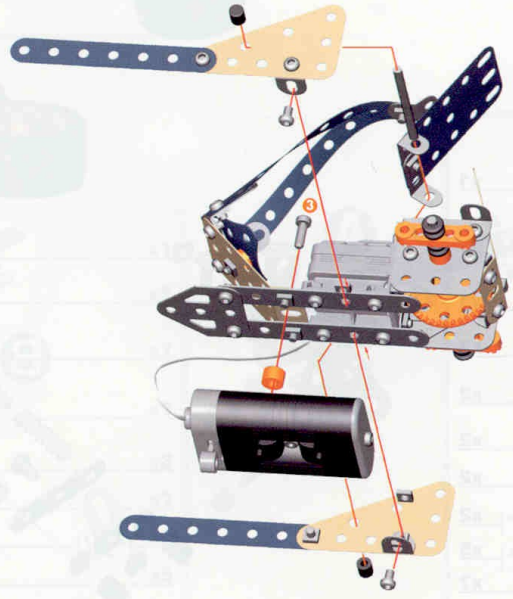

7

	x2		x1
	x2		x1
	x1		x2
	x2		x2
			x1
			x3

A X2

B

8

6 + 7 +

	x1
	x1
	x3
	x4

A

B

9







	x1
	x1
	x1
	x2
	x2
	x2
	x2
	x5
	x7

A

B







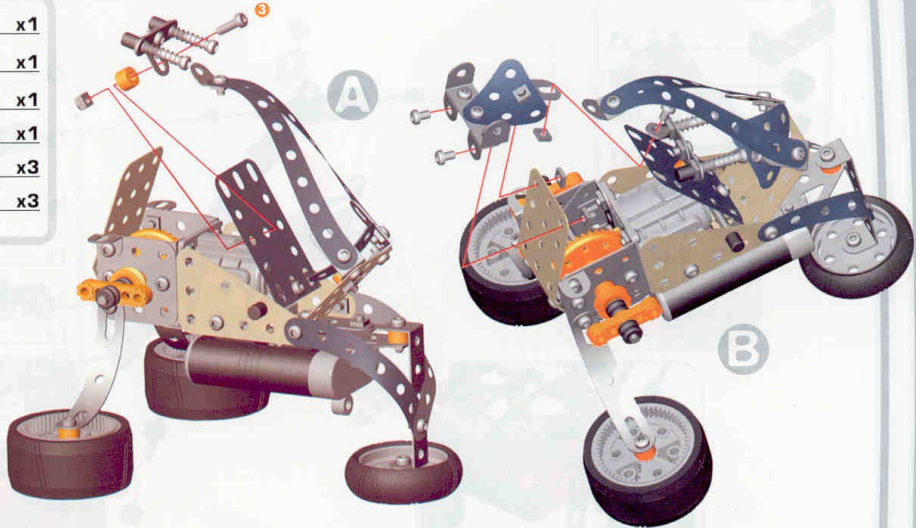

10

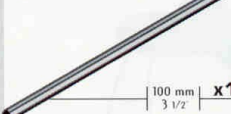
(8) + (9) +

-  x1
-  x1
-  x1
-  12 mm | x1
-  5,8 mm | x3
-  15/64" | x3











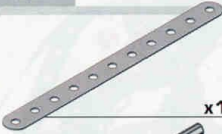
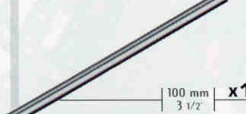

11

-  x1
-  100 mm | 3 1/2" | x1
-  x1
-  x1
-  x1
-  x1
-  x1
-  5,8 mm | x5
-  15/64" | x5



12

-  x1
-  100 mm | 3 1/2" | x1
-  x1
-  x1
-  x1
-  x1
-  x1
-  x1
-  x2
-  x1
-  5,8 mm | x5
-  15/64" | x5

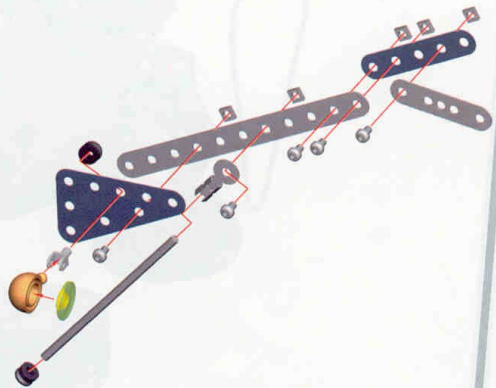

13

(10) + (11) + (12) +

	x1	
	x2	
	x2	
	x1	
	14,7 mm 9/16	x1
	5,8 mm 15/64	x4
	5,8 mm 15/64	x5

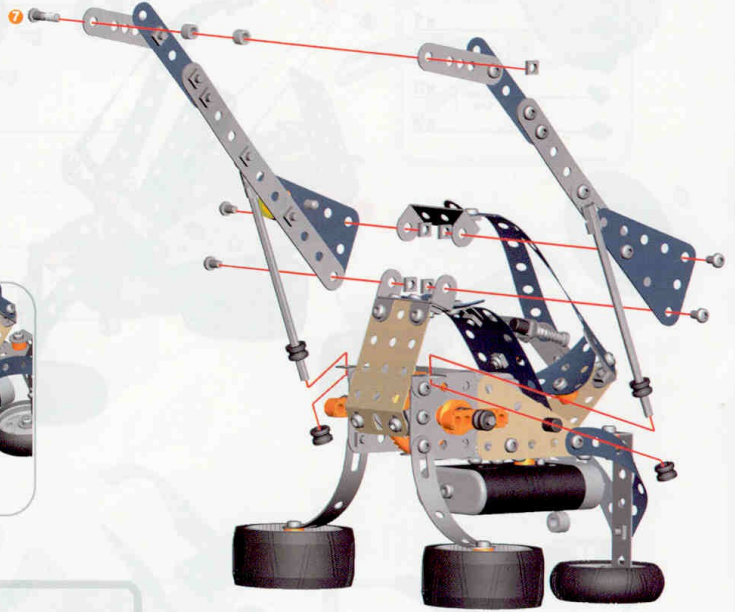
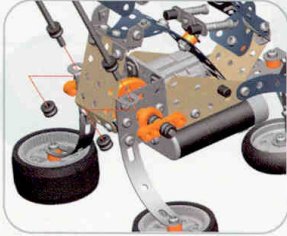





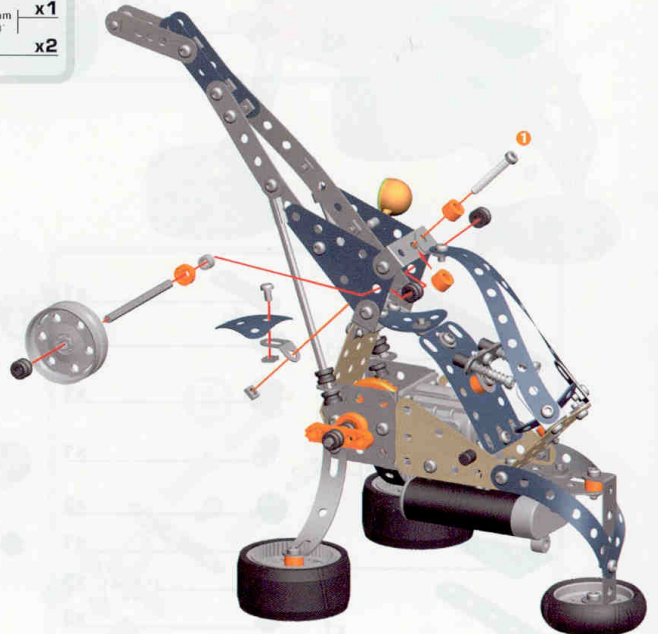



14

	x1		x3	
	x1		x1	
	60 mm 2 3/8		x2	
	x1		x1	
	x1		x1	
	x1		28 mm 1 1/8	x1
	x1		5,8 mm 15/64	x1
	x1		5,8 mm 15/64	x2



15

14+

-  x1
-  x1
-  x4
-  x1
-  x2
-  x1
-  12 mm x1
-  5,8 mm x2
-  15/64 x2

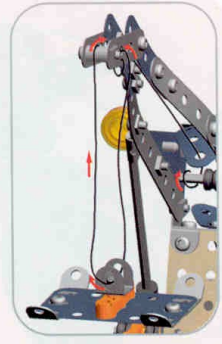
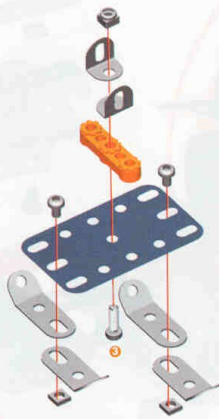

16

14+ 15+

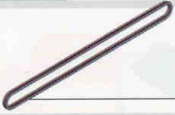
-  x1

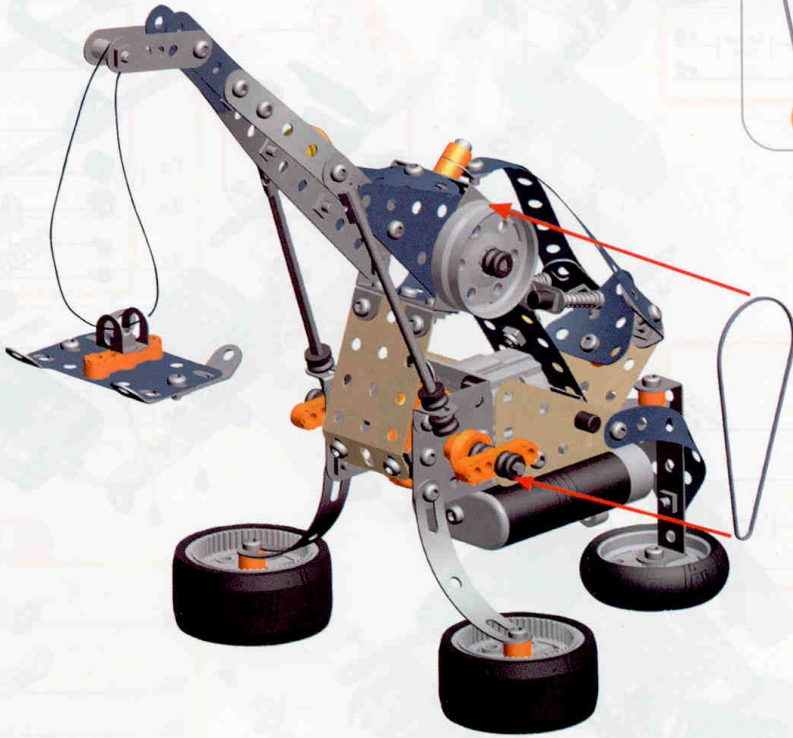
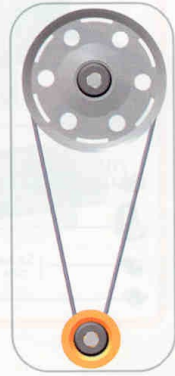

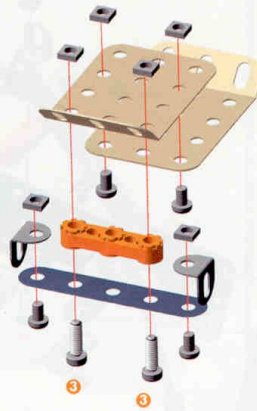
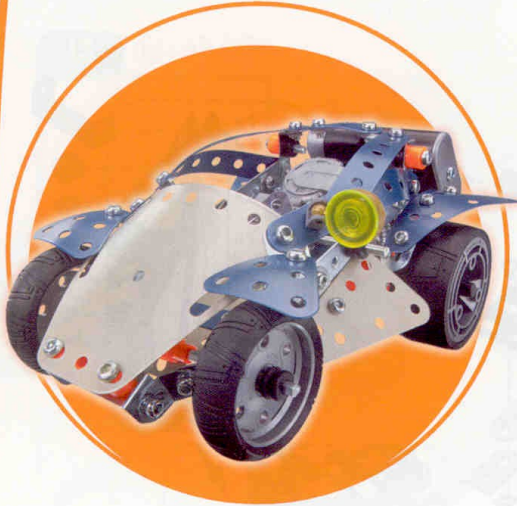

- 1**
- x2
 - x1
 - x1
 - x2
 - x2
 - x4
 - x6

- 2**
- x1
 - x1
 - x1
 - x2
 - x6
 - x6

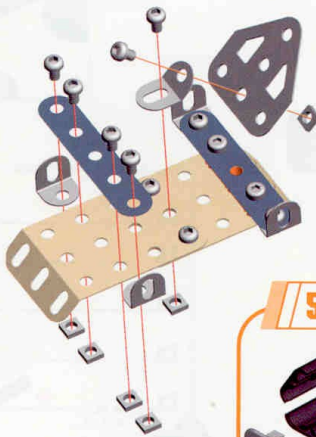



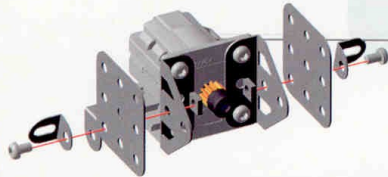
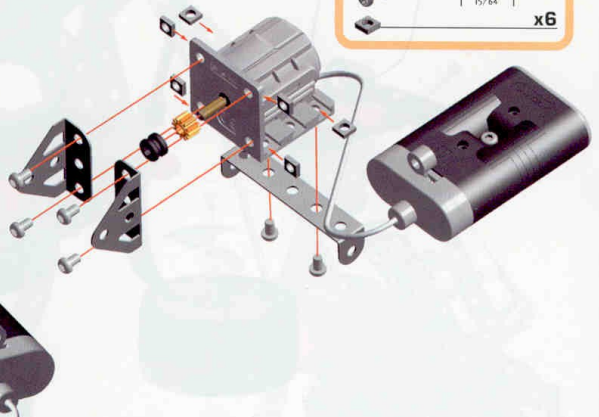

- 3**
- x1
 - x1
 - x2
 - x1
 - x1
 - x6
 - x6

- 4**
- x2
 - x2
 - x2
 - x2



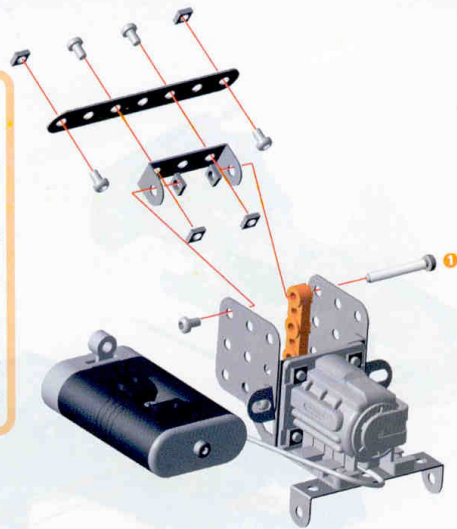

5

-  x1
-  x1
-  x1
-  28 mm | 1 1/8" | x1
-  5,8 mm | 15/64" | x5
-  x6







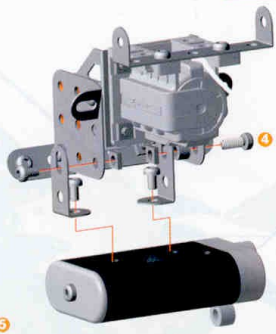



6

-  x2
-  x1
-  9,5 mm | 3/8" | x1
-  5,8 mm | 15/64" | x3
-  x2





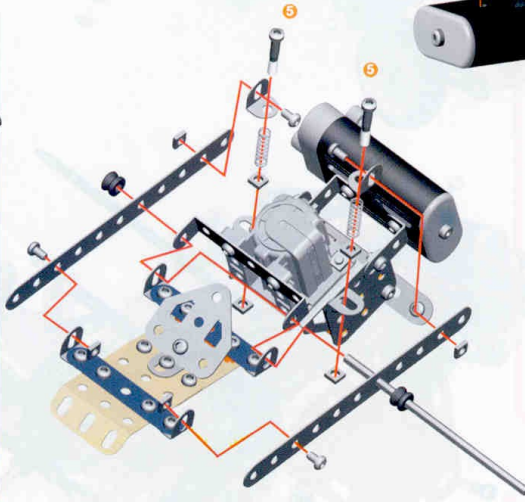

7

(2)+

-  x2
-  100 mm | 3 1/2" | x1
-  x2
-  x2
-  x2
-  23 mm | 29/32" | x2
-  5,8 mm | 15/64" | x4
-  x8



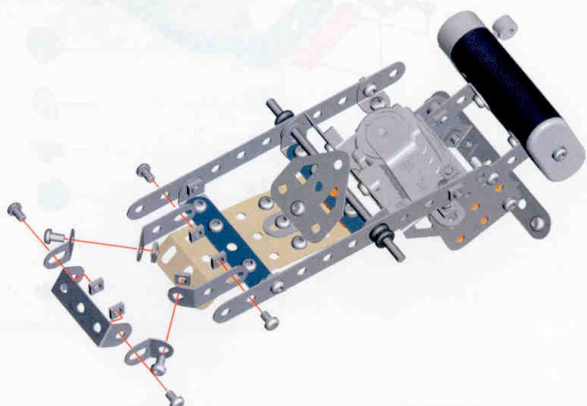

8

-  x1
-  x2
-  5,8 mm | 15/64" | x2
-  x6
-  x6







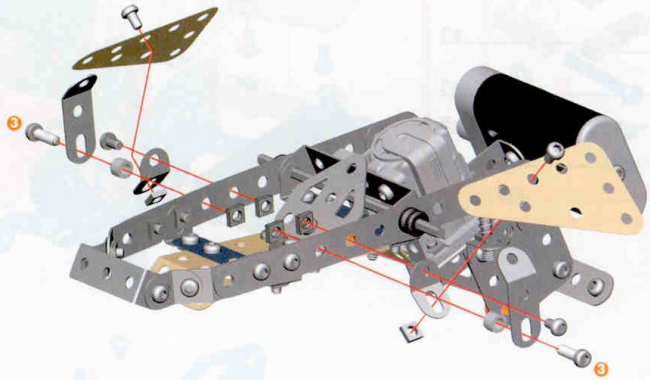



9

-  x2
-  x2
-  x2
-  x2
-  12 mm 1/2 x2
-  5,8 mm 15/64 x4
-  x6



10

-  x1
-  x2
-  x2
-  x1
-  x2
-  14,7 mm 9/16 x1
-  12 mm 1/2 x1
-  5,8 mm 15/64 x4
-  x6

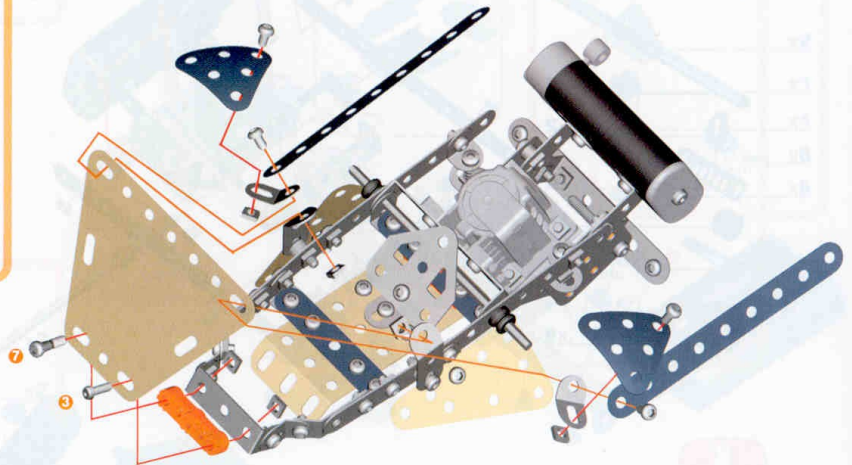





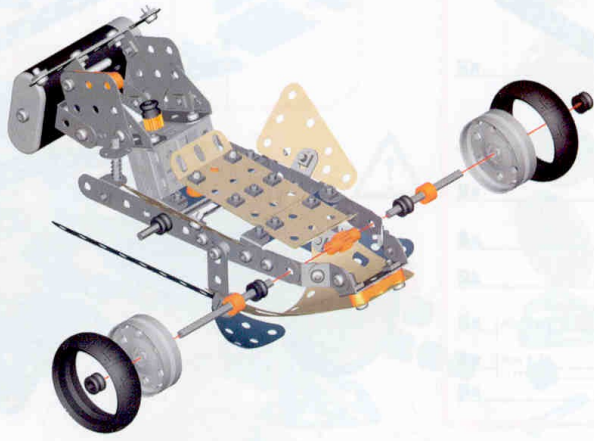

11

-  x2
-  x2
-  60 mm | 2 3/8" | x1
-  50 mm | 2" | x1
-  x1
-  x2
-  x4







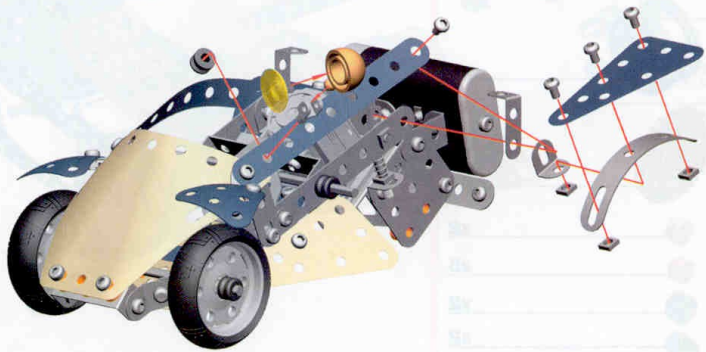
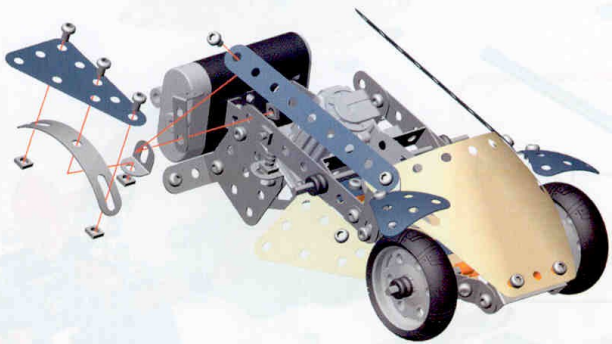





12







-  x1
-  x1
-  x1
-  x1
-  5,8 mm | 15/64" | x4
-  x4



13







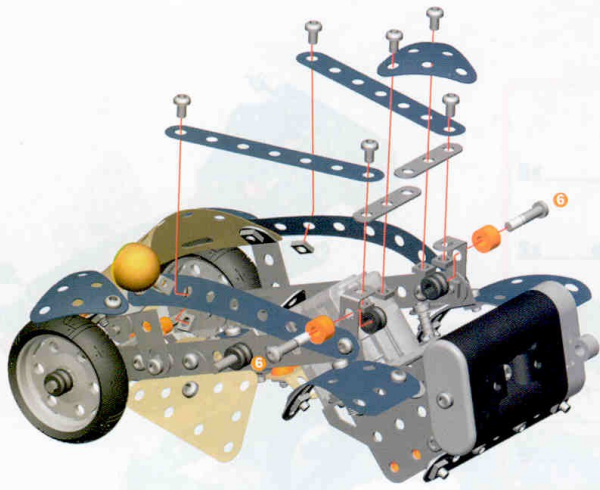

-  x1
-  x1
-  x1
-  x1
-  x1
-  x1
-  x1
-  x1
-  5,8 mm | 15/64" | x4
-  x4

14

-  x2
-  x1
-  x2
-  x2
-  x2
-  x2
-  x6
-  x6



15



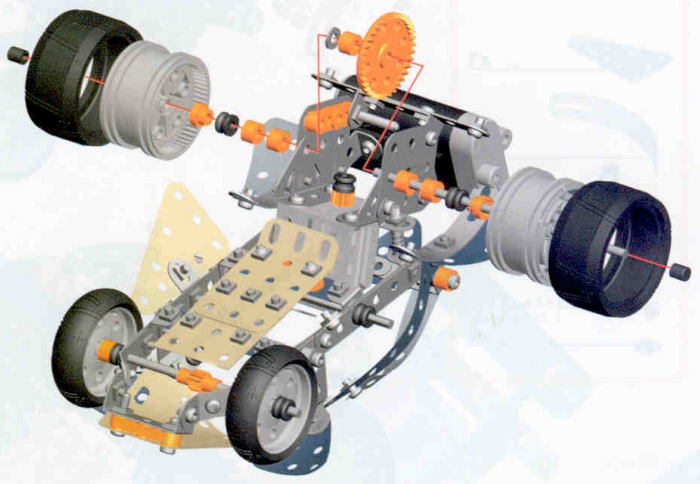

-  130 mm
3 1/2" x1
-  x2
-  x2
-  x1
-  x2
-  x5
-  x2
-  x2
-  x1



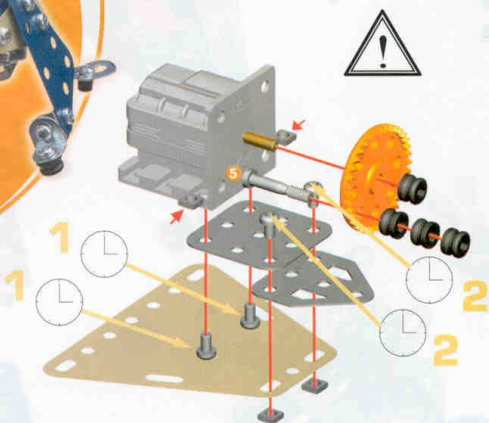







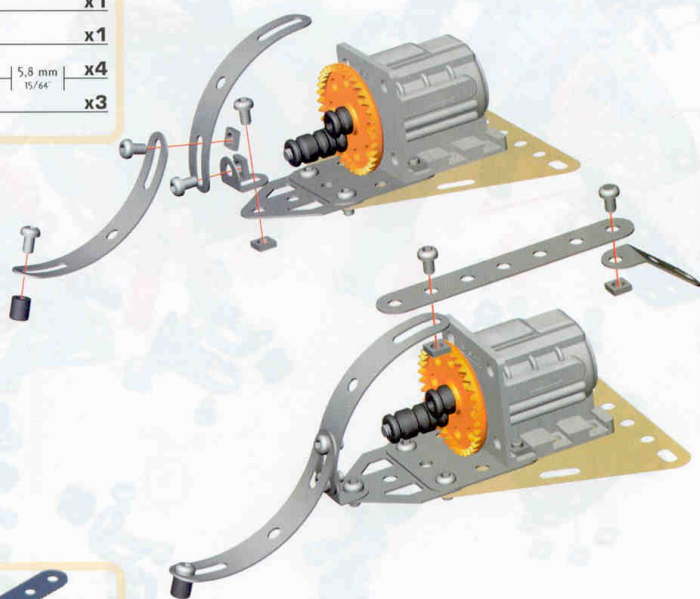

- 1**
-  x1
 -  x1
 -  x1
 -  x1
 -  x1
 -  x4
 -  23 mm 29/32 x1
 -  5,8 mm 15/64 x4
 -  5,8 mm 15/64 x4



- 2**
-  x2
 -  x1
 -  x1
 -  5,8 mm 15/64 x4
 -  x3



- 3**
-  x1
 -  x1
 -  5,8 mm 15/64 x2
 -  x2

- 4**
-  x2
 -  x1
 -  x2
 -  x2
 -  12 mm 1/2 x2
 -  5,8 mm 15/64 x3
 -  x3
 -  x2

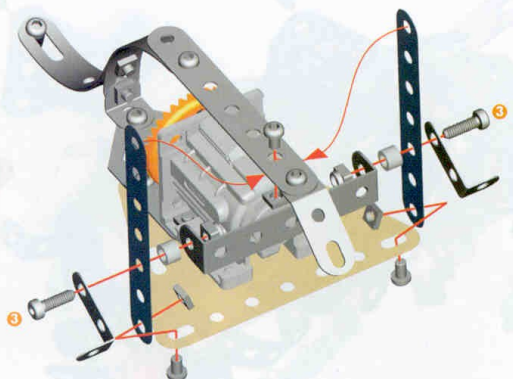

5

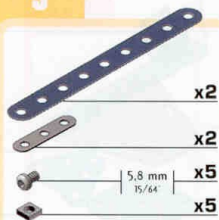

7

6+

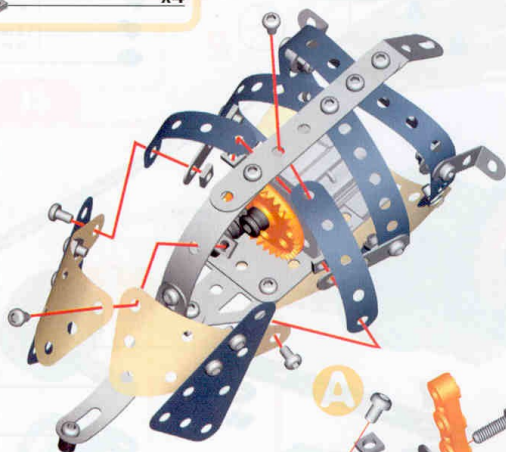
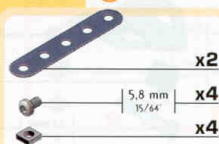

6

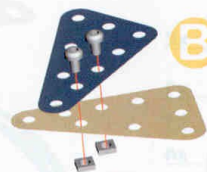
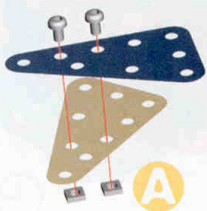
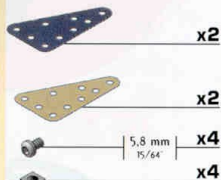

A

B



C

D



8

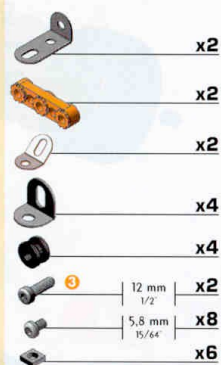



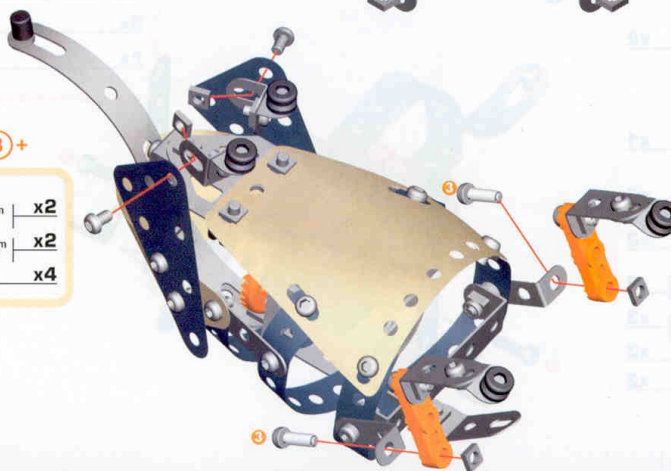
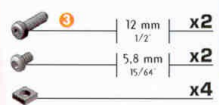

9

7+8+



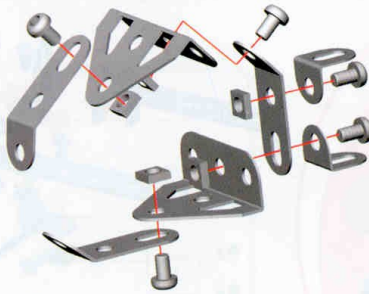

10

-  x2
-  x3
-  x2
-  5,8 mm 15/64 x5
-  x5





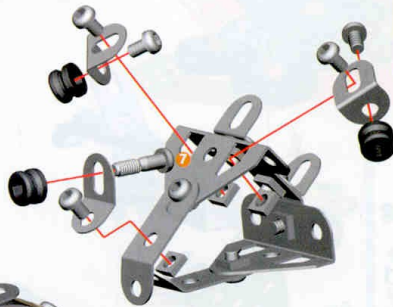

11

-  x1
-  x2
-  x3
-  14,7 mm 9/16 x1
-  5,8 mm 15/64 x5
-  x3





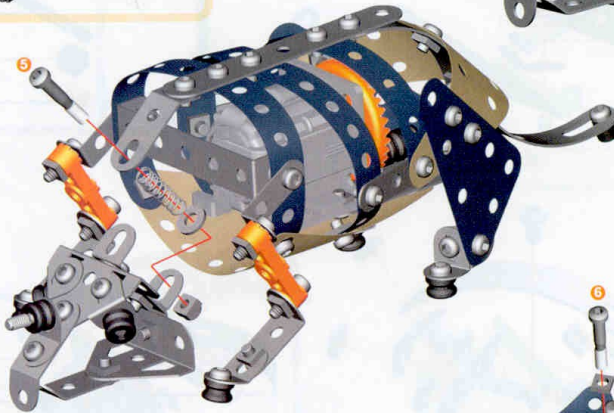

12

⑨ + ⑪ +

-  ⑥ 23 mm 29/32 x1
-  x1
-  x1
-  x1





13

-  x3
-  ⑥ 19,2 mm 3/4 x2
-  5,8 mm 15/64 x2
-  x6



14

⑬ +

-  5,8 mm 15/64 x1
-  x1

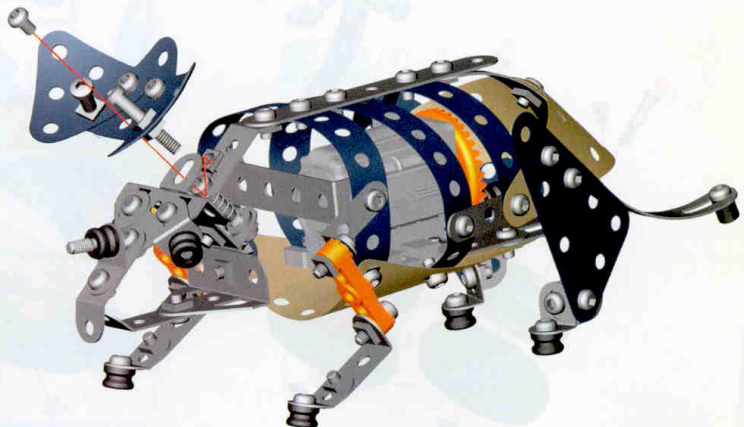

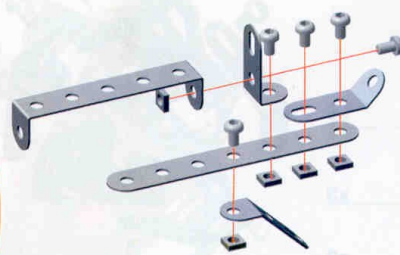

- 1**
- x1
 - x1
 - x2
 - x1
 - 5,8 mm 15/64 x5
 - 5,8 mm 15/64 x5

- 2**
- x2
 - x1
 - x1
 - x2
 - x1
 - x1
 - 5,8 mm 15/64 x3
 - 5,8 mm 15/64 x3



- 3**
- x1
 - 60 mm 2 3/8 x1
 - x3
 - x2

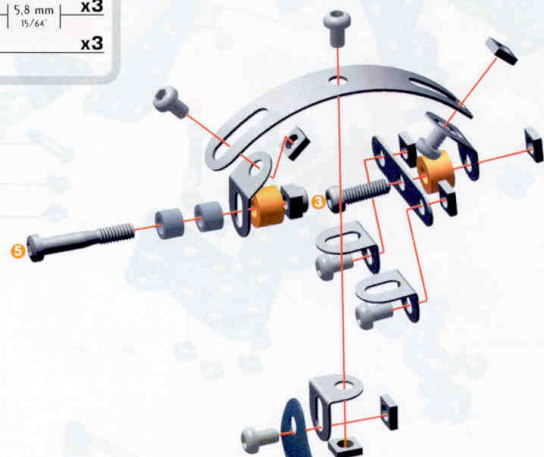

- 4**
- x1
 - x2
 - x2
 - x1
 - x1
 - 23 mm 29/32 x1
 - x1
 - 12 mm 1/2 x1
 - x2
 - 5,8 mm 16/64 x6
 - x3
 - x7



- 5**
- x2
 - x1
 - x2
 - x2
 - 19,2 mm 3/4 x2
 - 5,8 mm 15/64 x2
 - 5,8 mm 15/64 x4

6

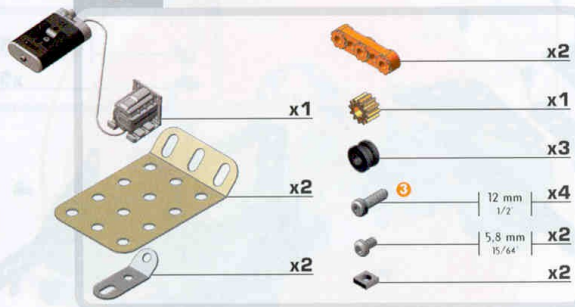

5

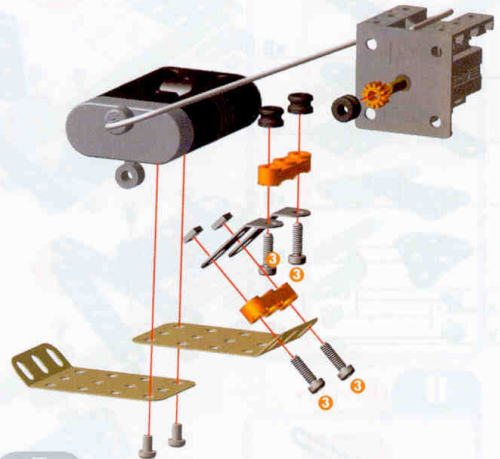

7

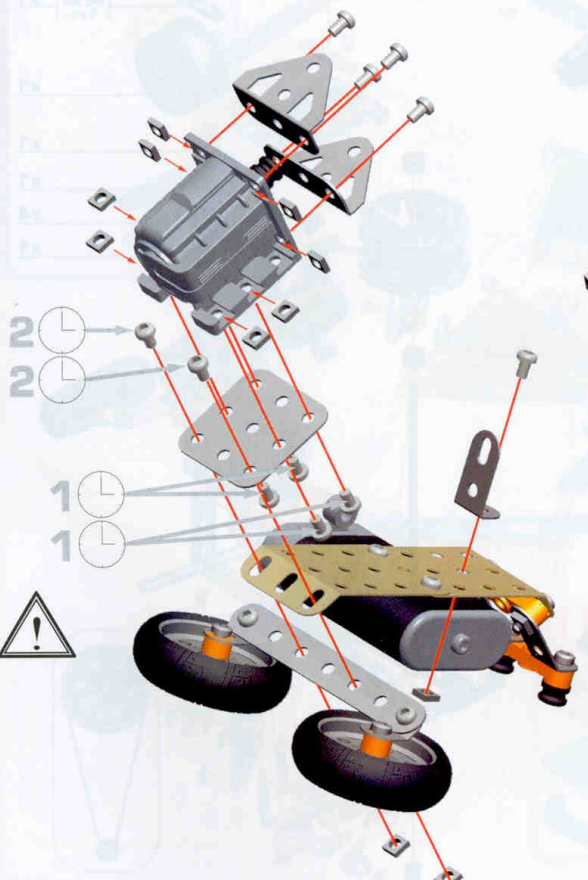
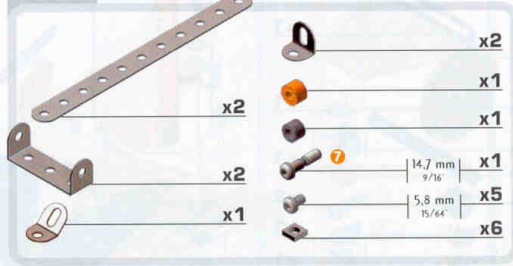

8

5 + 6 +

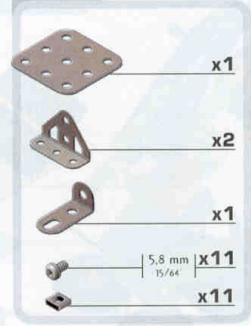

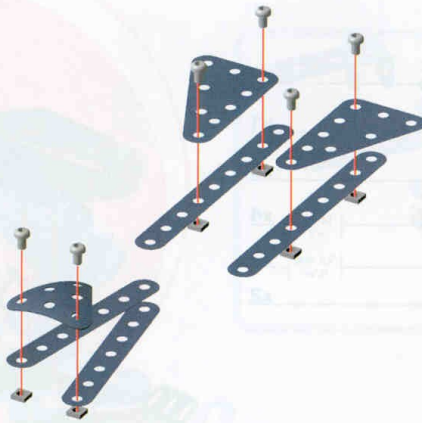
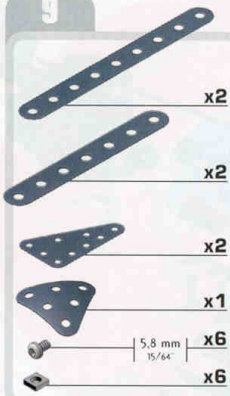
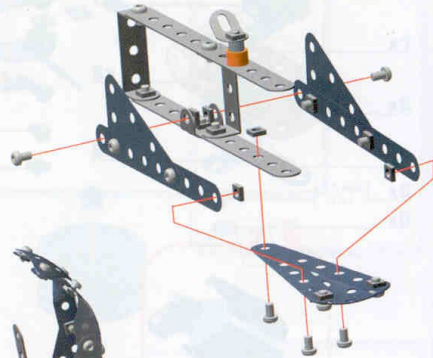
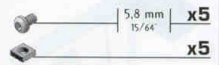
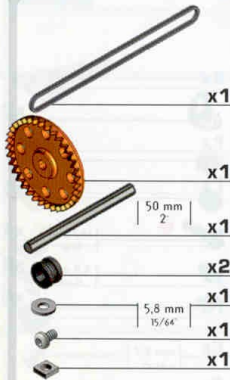
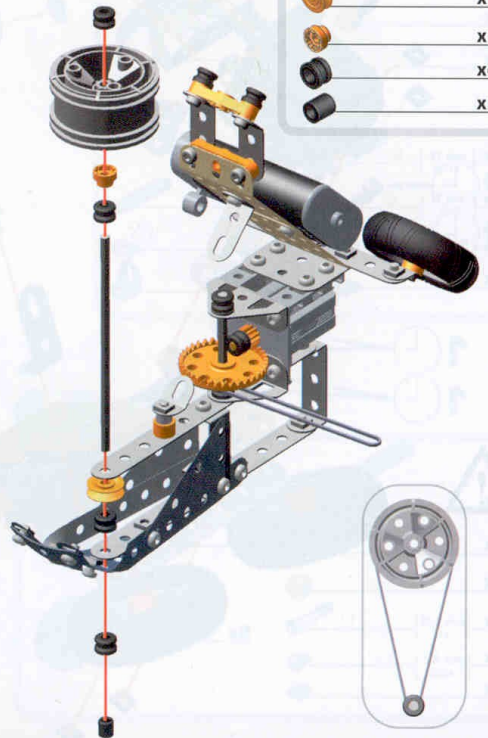
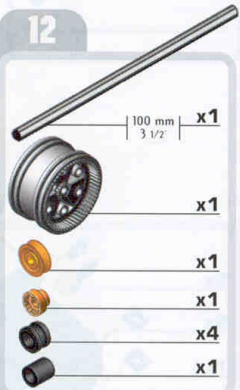
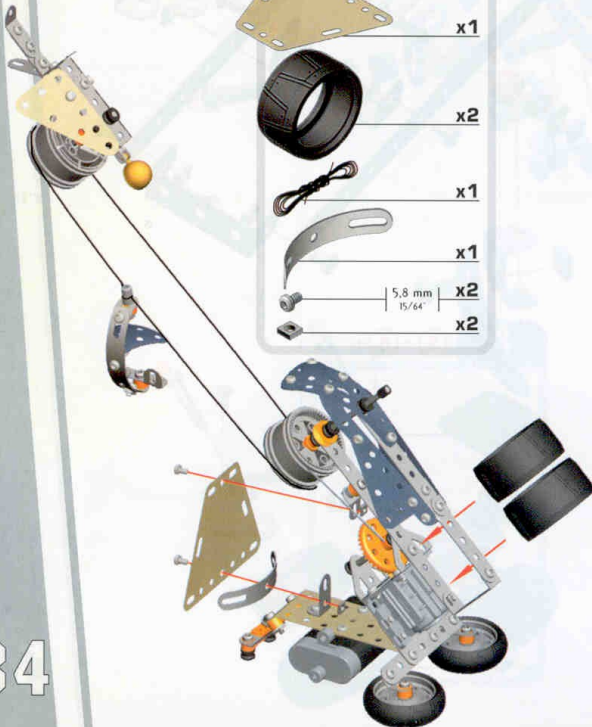
9**10****7 + 9 +****11****8 + 10 +****12****13****3 + 4 +**

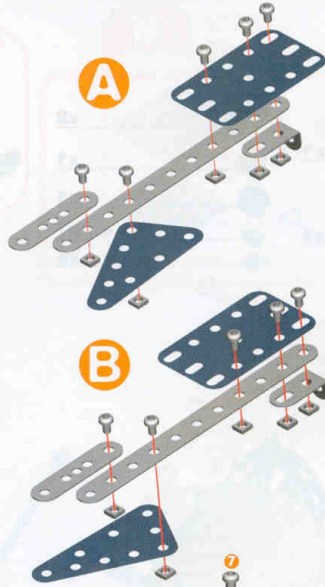
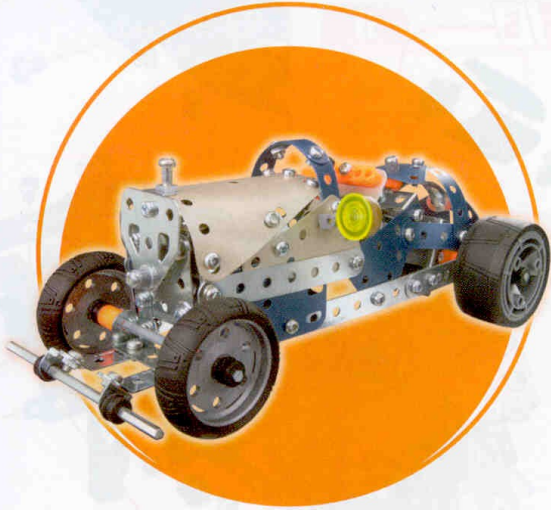

- 1**
- x2
 - x2
 - x2
 - x2
 - x2
 - 5,8 mm x10
 - 15/64 x10

- 2**
- x2
 - x2
 - x2
 - 5,8 mm x6
 - 15/64 x6

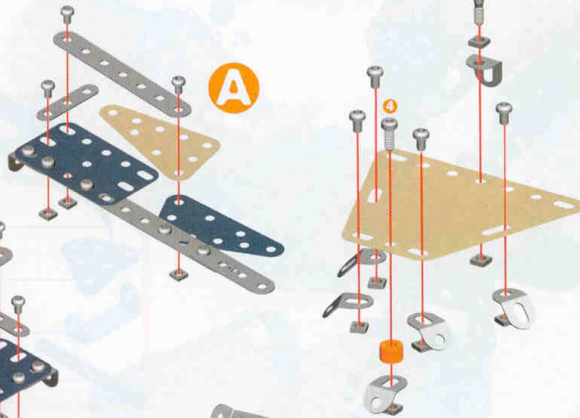

- 3**
- x1
 - x5
 - x1
 - x1
 - 14,7 mm x1
 - 9,7/6 x1
 - 9,5 mm x1
 - 3/8 x4
 - 5,8 mm x7
 - 15/64



- 4** ②+③+
- x1
 - x2
 - x1
 - x1
 - 12 mm x1
 - 1/2 x1
 - 5,8 mm x9
 - 15/64 x10

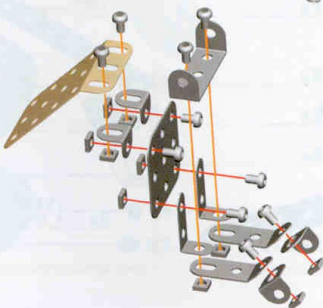

- 5**
- x1
 - x1
 - x1
 - x2
 - x2
 - x4
 - 5,8 mm x10
 - 15/64 x10

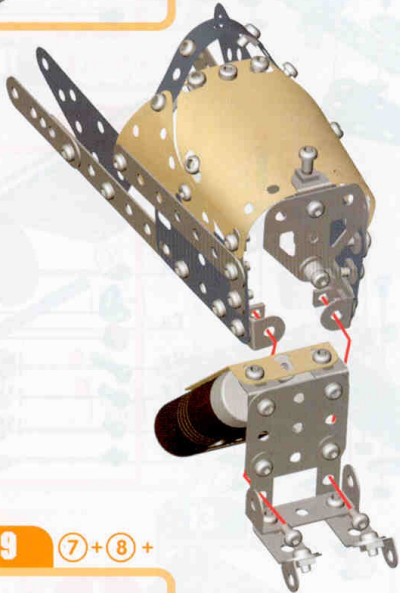
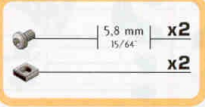
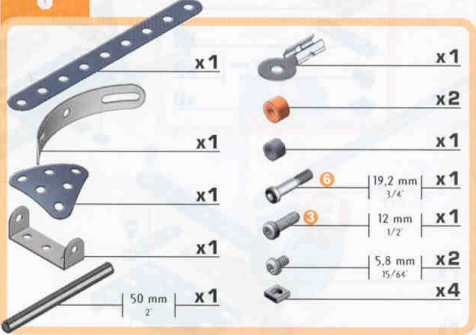
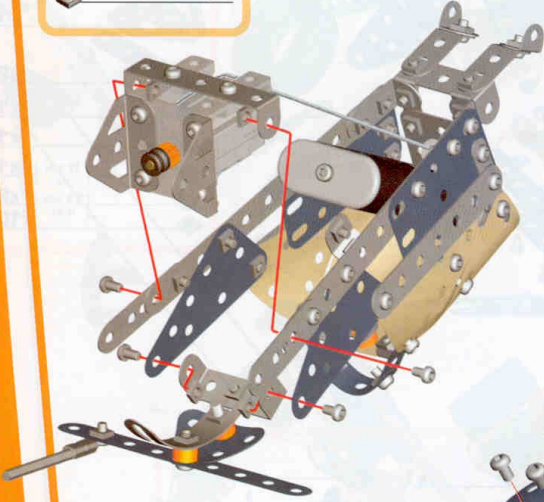
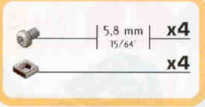
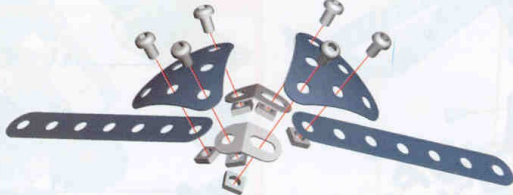
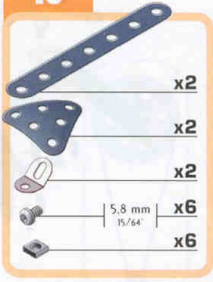
6**(5) +****5****7****(4) + (6) +****8****9****(7) + (8) +****10**

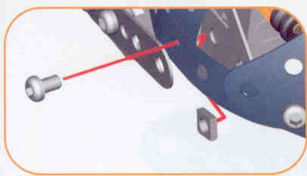

11

- | 5,8 mm | x4
- | x4

12

11 + 12 +

- | x1
- | x1
- | x1
- | x1
- | 12 mm | x1
- | 1/2" | x1
- | 5,8 mm | x3
- | 15/64" | x4

13

11 + 12 +

- | 60 mm | x1
- | 2 3/8" | x1
- | x1
- | x1
- | x1
- | x1
- | x3
- | x1
- | 5,8 mm | x1
- | 15/64" | x1

14

- | 100 mm | x2
- | 3 1/2" | x2
- | x2
- | x2
- | x4
- | x6

15

- | 130 mm | x1
- | 3 1/2" | x1
- | x1
- | x2
- | x2
- | x3
- | x4
- | x2
- | x2
- | x1



