

Instructions
Notice de montage
Bauanleitung
istruzioni di montaggio
Instrucciones de montaje
Instruções de montagem

Monteringsanvisning
Kokoamisohje
Monterings instruktioner
Montagehandleiding
Οδηγίες συναρμολόγησης.
組立説明書



#9902

7+

p.6



p.21



p.31



p.39





B954 x1



A045 (J0045) x2

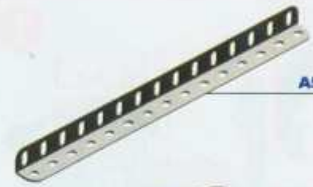

A509 (00088) x2



B729 x5



A142 (0142R) x2



A189 (0089) x12



B722 x5



A187 (0187C) x4



A202 (0002) x3



B732 x23



A128 (0028P3P) x1



B482 x6



B753 x1



A327 (0027P3P) x2



A304 (0004) x4



B756 x10



A631 (0025D3P) x1



A269 (0072) x1



B728 x79



A326 (0026P3P) x1



A455 (0161) x1



B727 x15



A313 (0213D3P) x1



A271 (0090A) x2



B953 x2



A444 (0144C) x2



A043 (0043) x2



B739 x1



B051 x1



B965 x2
135 mm
5 5/16"



B742 x1



B146 (0006) x2



A316 (0316) x2
90 mm
3 1/2"



B956 x1



A506 (0006A) x1



A516 (0316A) x1
60 mm
2 1/2"



B777 x2



A548 (0048E) x4



A512 (0012B) x1



B778 x4



A512 (0012B) x1



A317 (0317) x3
50 mm
2"



A712 (0012C) x9



A318 (0318A) x2
40 mm
1 9/16"



A012 (0012) x20



B775 x21
A | 31,7 mm
1 5/8"



B776 x17
A | 31,7 mm
1 5/8"



B726 x34
B | 25,4 mm
1"



B746 x35
B | 25,4 mm
1"



B725 x113
C | 19 mm
3/4"



B745 x106
C | 19 mm
3/4"



B724 x119
D | 12,7 mm
1/2"



B744 x114
D | 12,7 mm
1/2"



A238 (0038A) x9



A259 (0059C) x14



A138 (0038) x8



B752 x1



A136 (0036C) x1



B757 x1



1

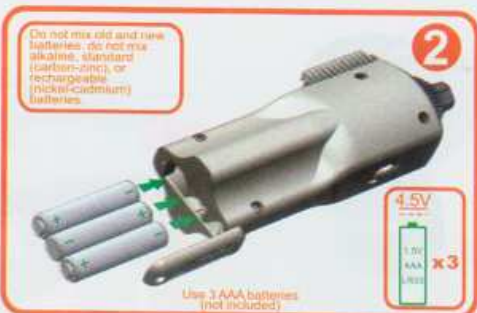

2

Do not mix old and new batteries, do not mix alkaline, standard (carbon-zinc), or rechargeable (nickel-cadmium) batteries.

Use 3 AAA batteries (not included)

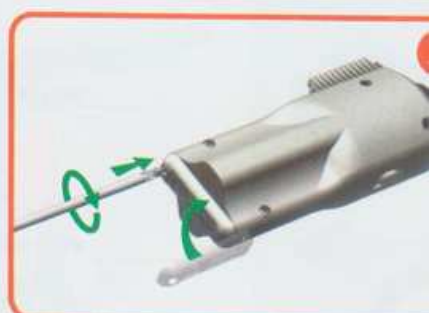

4

The power tool transforms into a motor!
La visseuse se transforme en moteur!
Der Schraubendreher wird zum Motor!
L'avvitatore si trasforma in motore!
!La atornilladora se transforma en motor!
De schroevendraaier wordt zo een motor!
ドライバーがモーターに変身します。



1

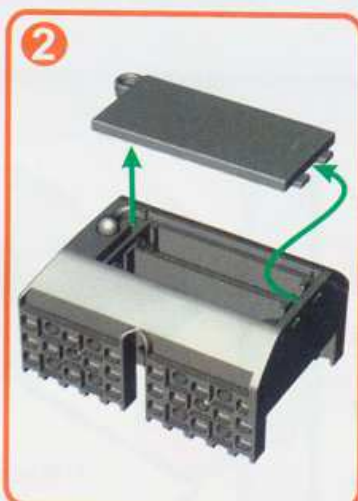

2



3

Do not mix old and new batteries, do not mix alkaline, standard (carbon-zinc), or rechargeable (nickel-cadmium) batteries.

Use 2 AAA batteries (not included)



4

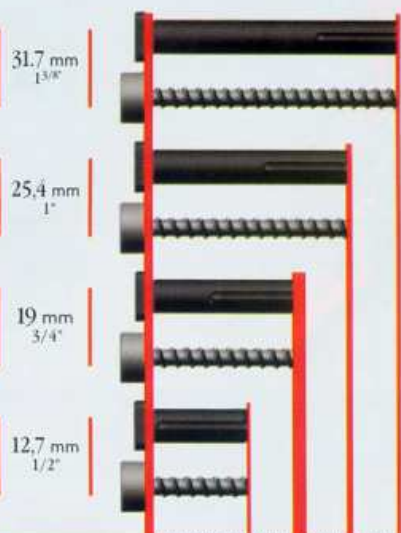

Scale
Echelle
Maßstab
Scala

Escala
Schaal
Escala
Skala

1:1

Mittakaava
Målestok
Κλίμακα
スケール

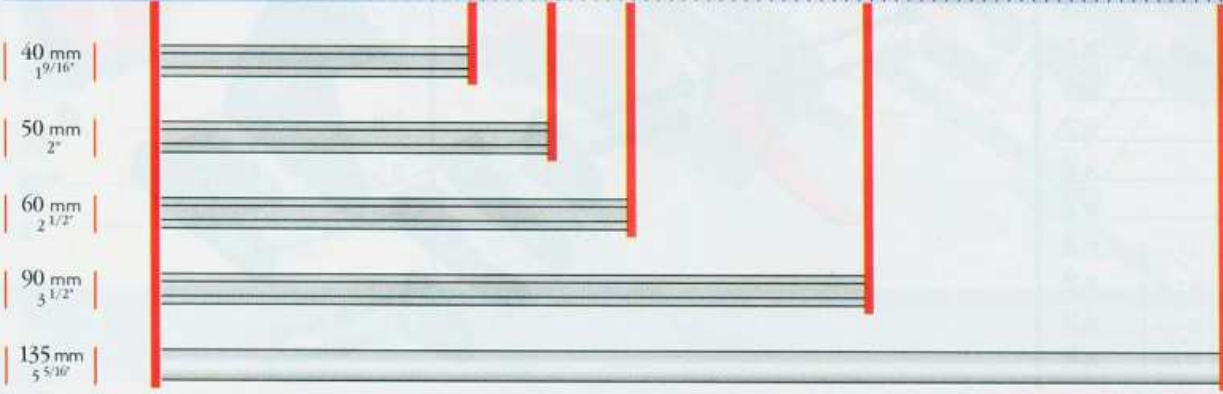

CONSTRUCTION TIPS
ASTUCES DE CONSTRUCTION
KONSTRUKTIONS-TIPPS

LE ASTUZIE DELLA COSTRUZIONE
LOS INGENIOS DE LA CONSTRUCCION
DE FIJNE KNEEPJES VAN NET BOUWEN

組み立ての秘訣

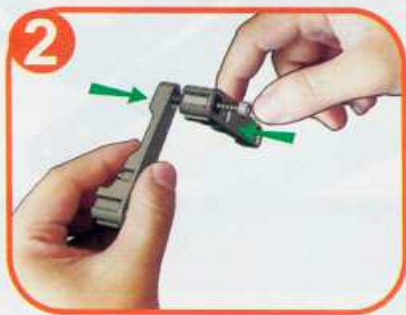

Oil Huile Öl Olio Oleo Olie Ölly Olie Óleo Olja Ἄδιον オイル

Add oil on the moving parts.
Ajoute de l'huile sur les pièces en mouvements.
Aplica el aceite en las piezas del mecanismo.

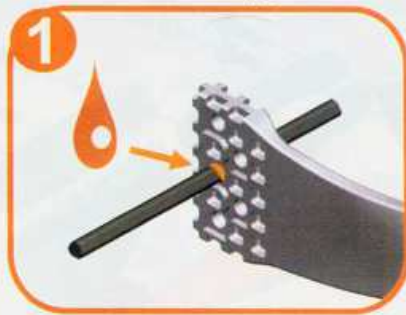

4

1 + 3 +

-  x2
-  19 mm 3/4" x2
-  19 mm 3/4" x2
-  12,7 mm 1/2" x2
-  12,7 mm 1/2" x2

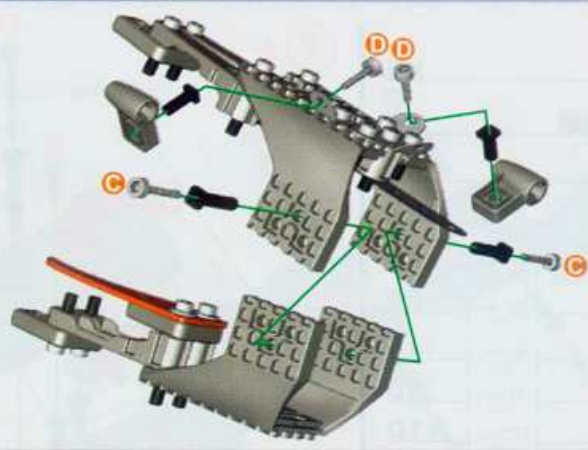





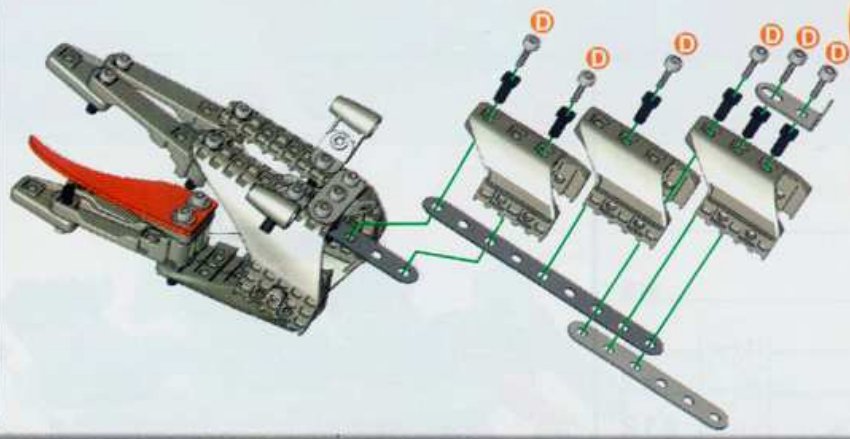

5

-  x1
-  x1
-  x3
-  x1
-  12,7 mm 1/2" x6
-  12,7 mm 1/2" x6





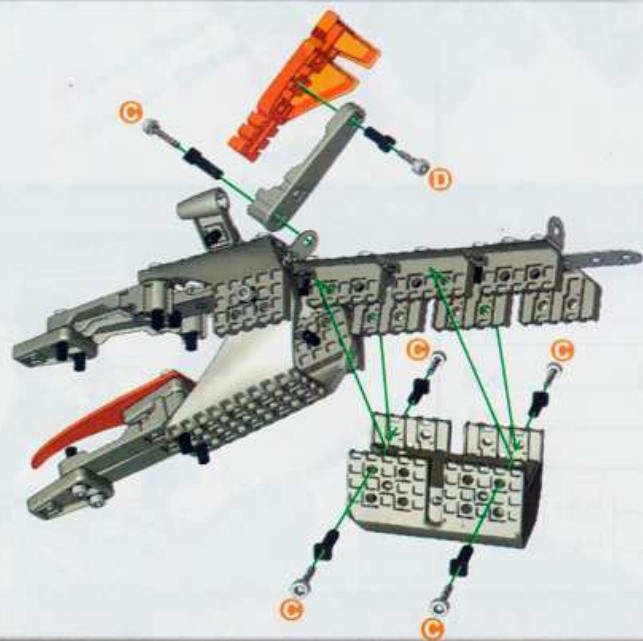

6

-  x1
-  x1
-  x1
-  19 mm 3/4" x5
-  19 mm 3/4" x5
-  12,7 mm 1/2" x1
-  12,7 mm 1/2" x1



7

-  x4
-  x4
-  12,7 mm 1/2" x4
-  12,7 mm 1/2" x4

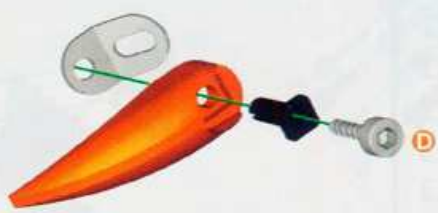

x4 

-  x6
-  x4
-  x2
-  x2
-  x2
-  x2
-  x6
-  x6
-  x10
-  x10

7 +

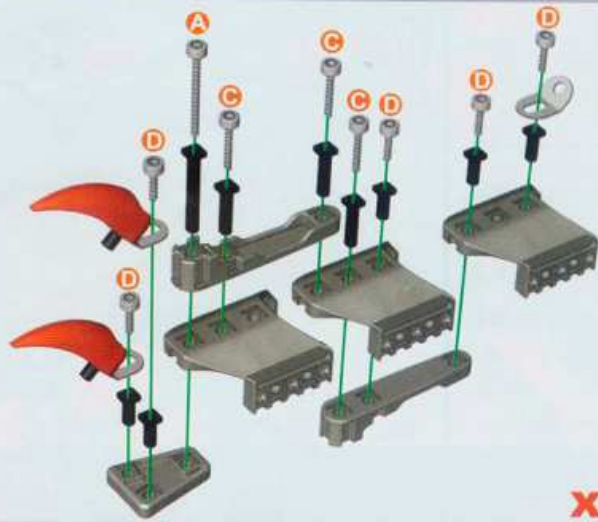

x2



-  x4
-  x6
-  x2
-  x2
-  x12
-  x12
-  x2
-  x2

8 +

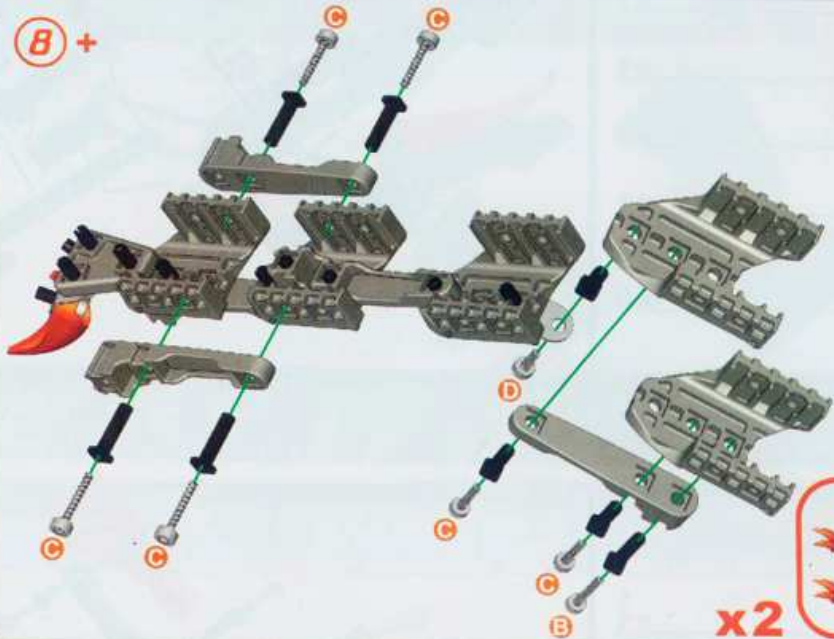





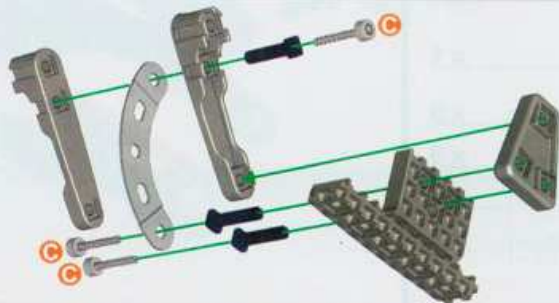

x2



-  x1
-  x2
-  x1
-  x1
-  x3
-  x3



-  x1
-  x2
-  x1
-  x1
-  x3
-  x3

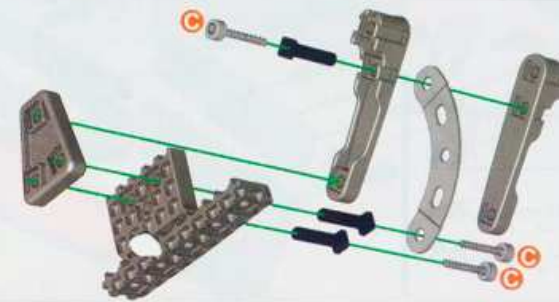

12

9 + 10 +

-  x1
-  (C) x4
-  (C) x4

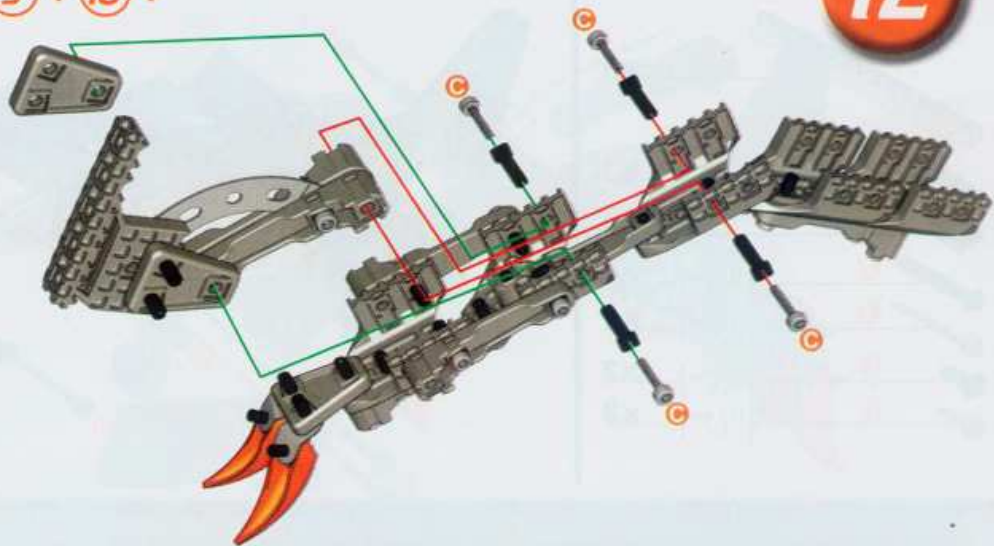



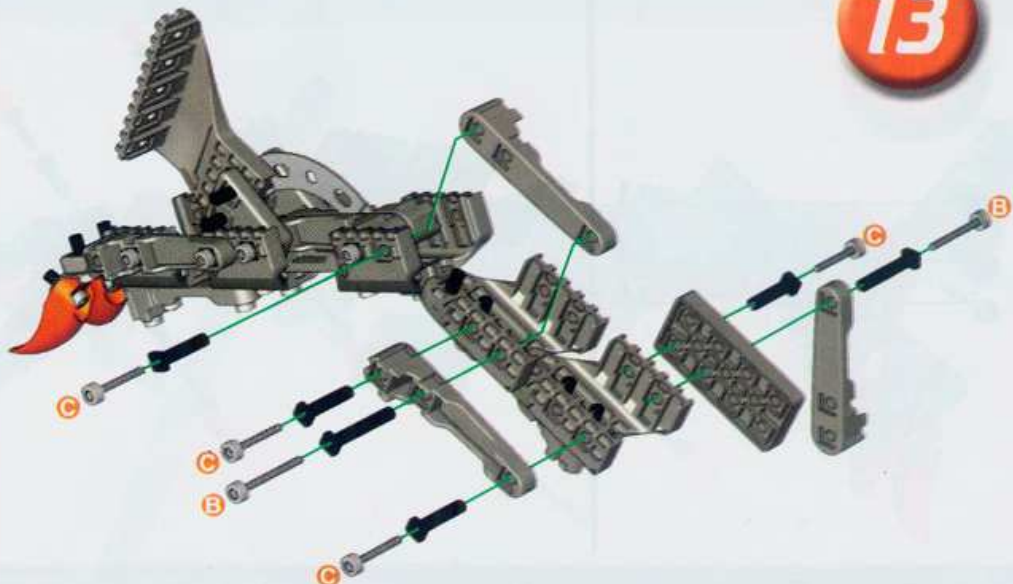

13

-  x1
-  x3
-  (B) x2
-  (B) x2
-  (C) x4
-  (C) x4



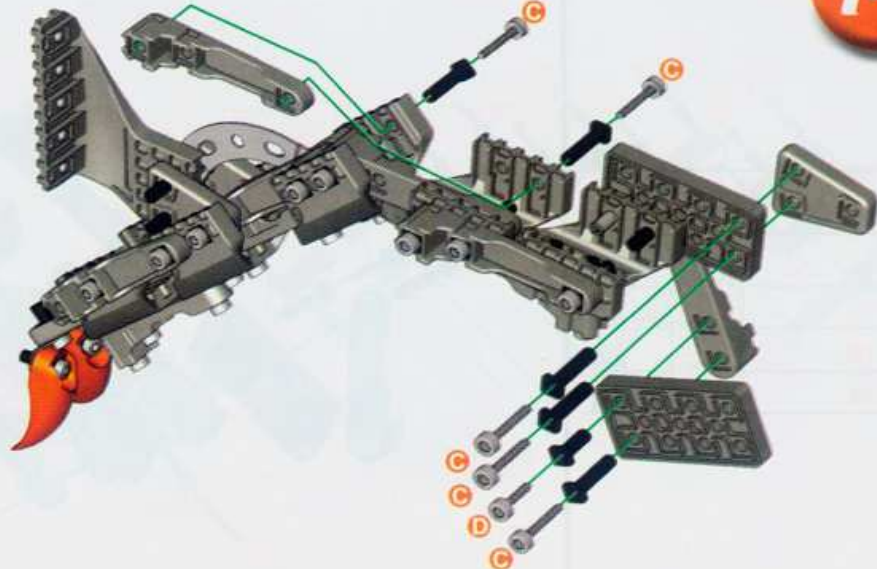

14

-  x1
-  x1
-  x1
-  (C) x5
-  (C) x5
-  (D) x1
-  (D) x1



15

-  x1
-  x1
-  x1
-  (A) | 31.7 mm | x1
-  (A) | 31.7 mm | x1
-  (B) | 12.7 mm | x2
-  (D) | 12.7 mm | x2

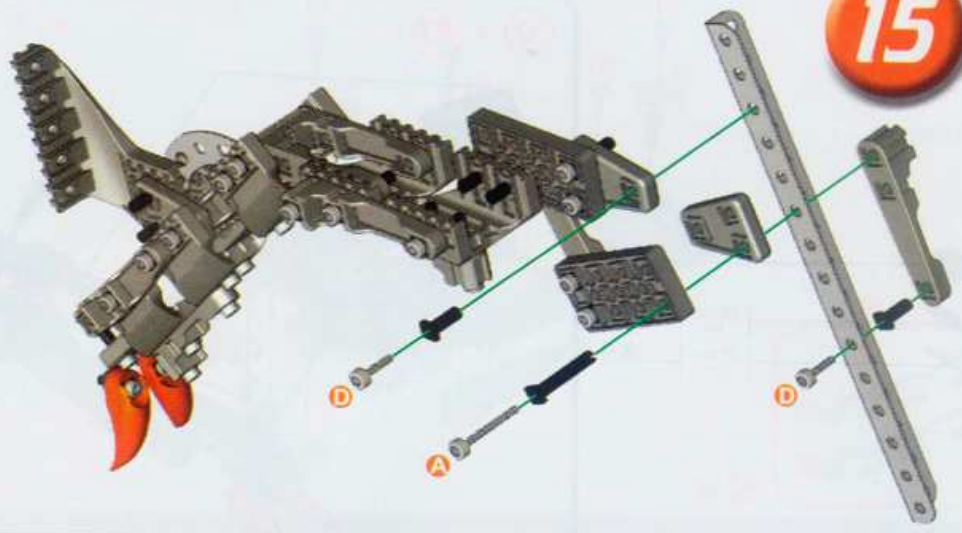





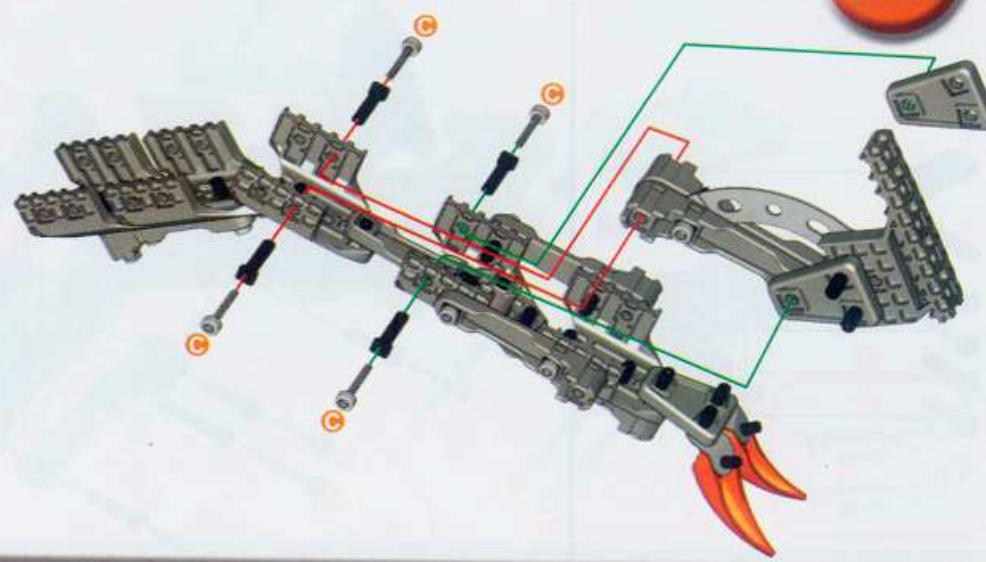

16

(9) + (11) +







-  x1
-  (C) | 19 mm | x4
-  (C) | 19 mm | x4

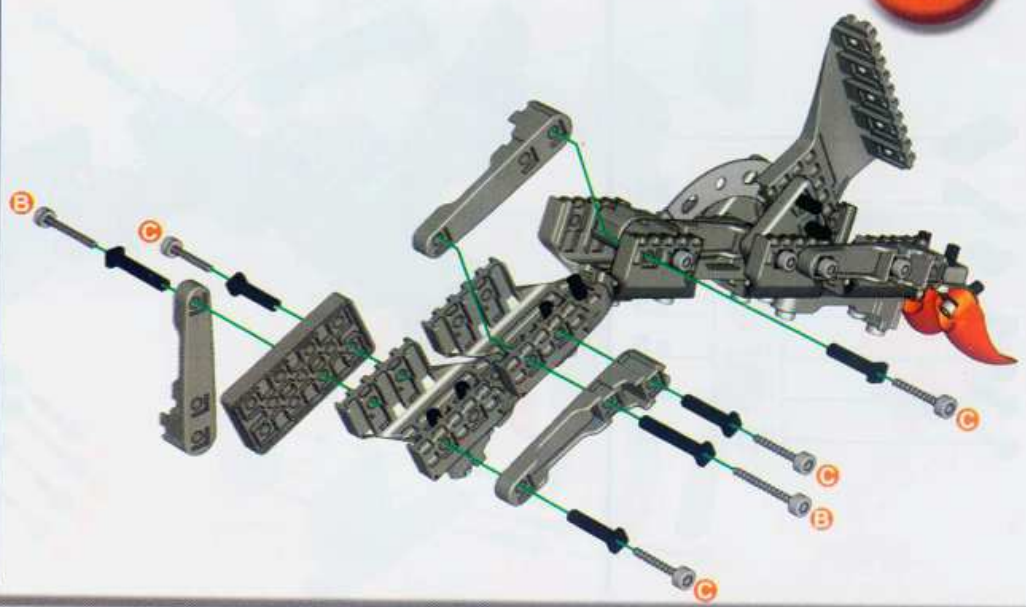







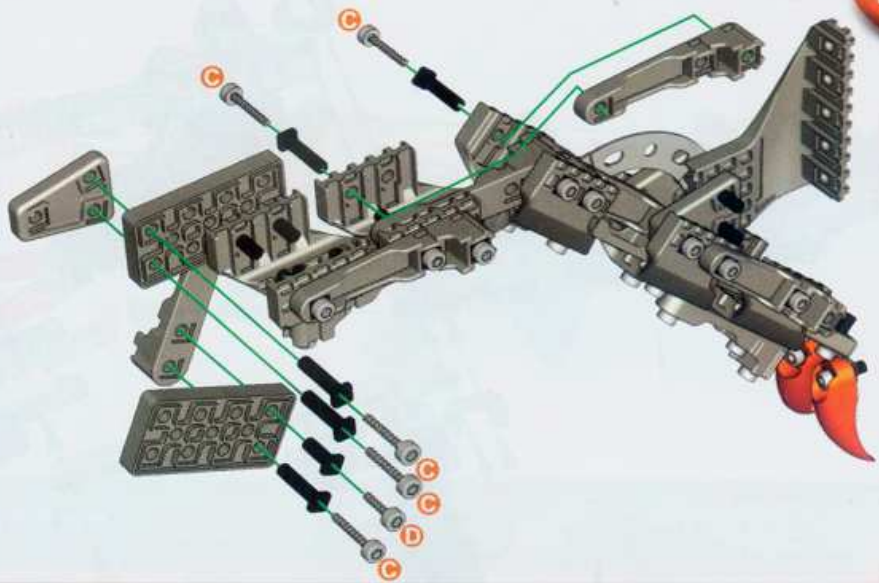

17

-  x1
-  x3
-  (B) | 25.4 mm | x2
-  (B) | 25.4 mm | x2
-  (C) | 19 mm | x4
-  (C) | 19 mm | x4



-  x1
-  x1
-  x1
-  (C) | 19 mm | x5
-  (C) | 19 mm | x5
-  (D) | 12,7 mm | x1
-  (D) | 12,7 mm | x1



-  x1
-  x1
-  x1
-  (A) | 31,7 mm | x1
-  (A) | 31,7 mm | x1
-  (D) | 12,7 mm | x2
-  (D) | 12,7 mm | x2

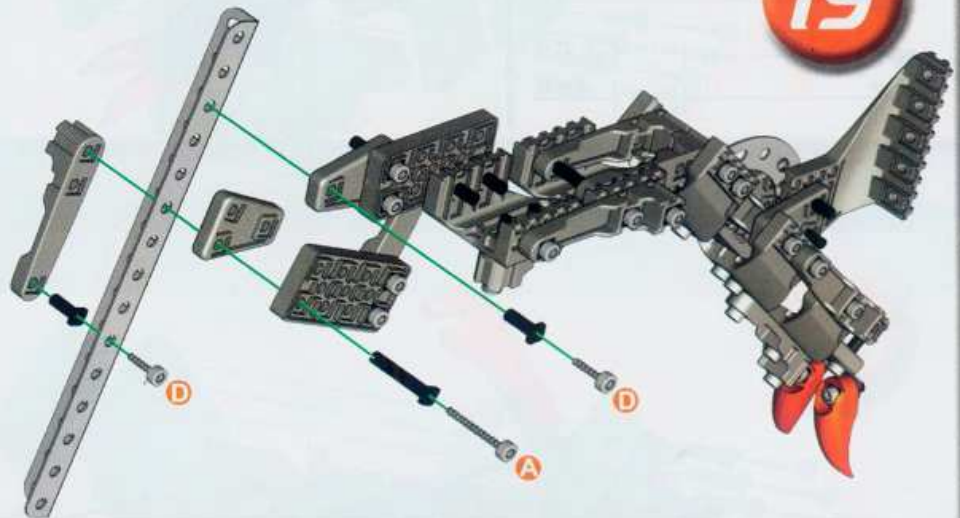



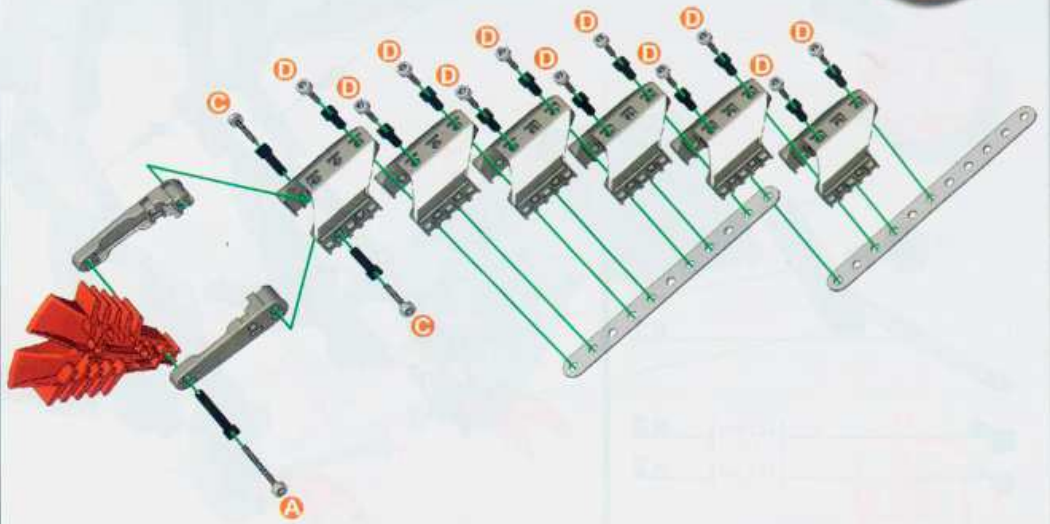

-  x2
-  x1
-  x6
-  x2
-  (A) | 31,7 mm | x1
-  (A) | 31,7 mm | x1
-  (C) | 19 mm | x2
-  (C) | 19 mm | x2
-  (D) | 12,7 mm | x11
-  (D) | 12,7 mm | x11

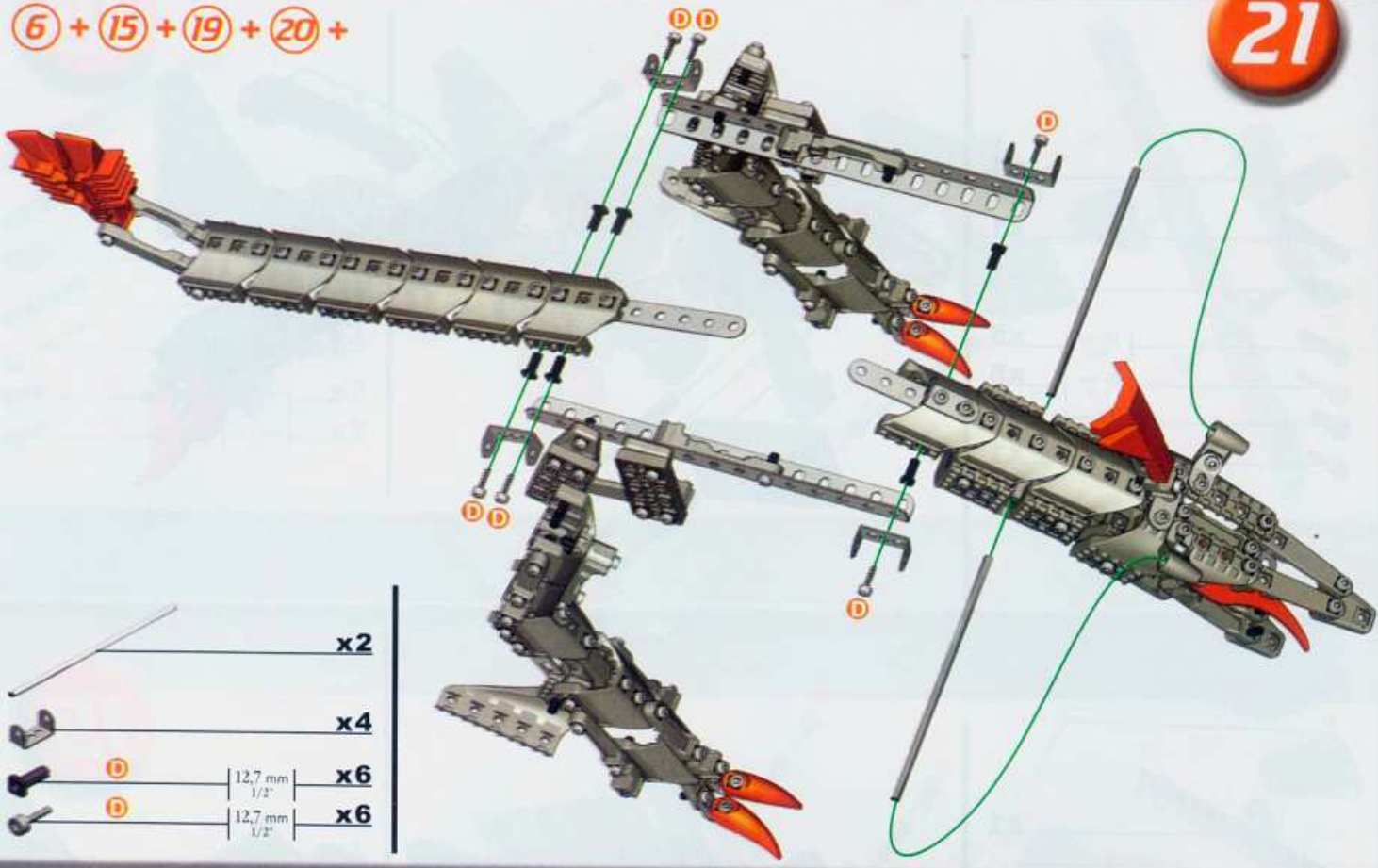



6 + 15 + 19 + 20 +

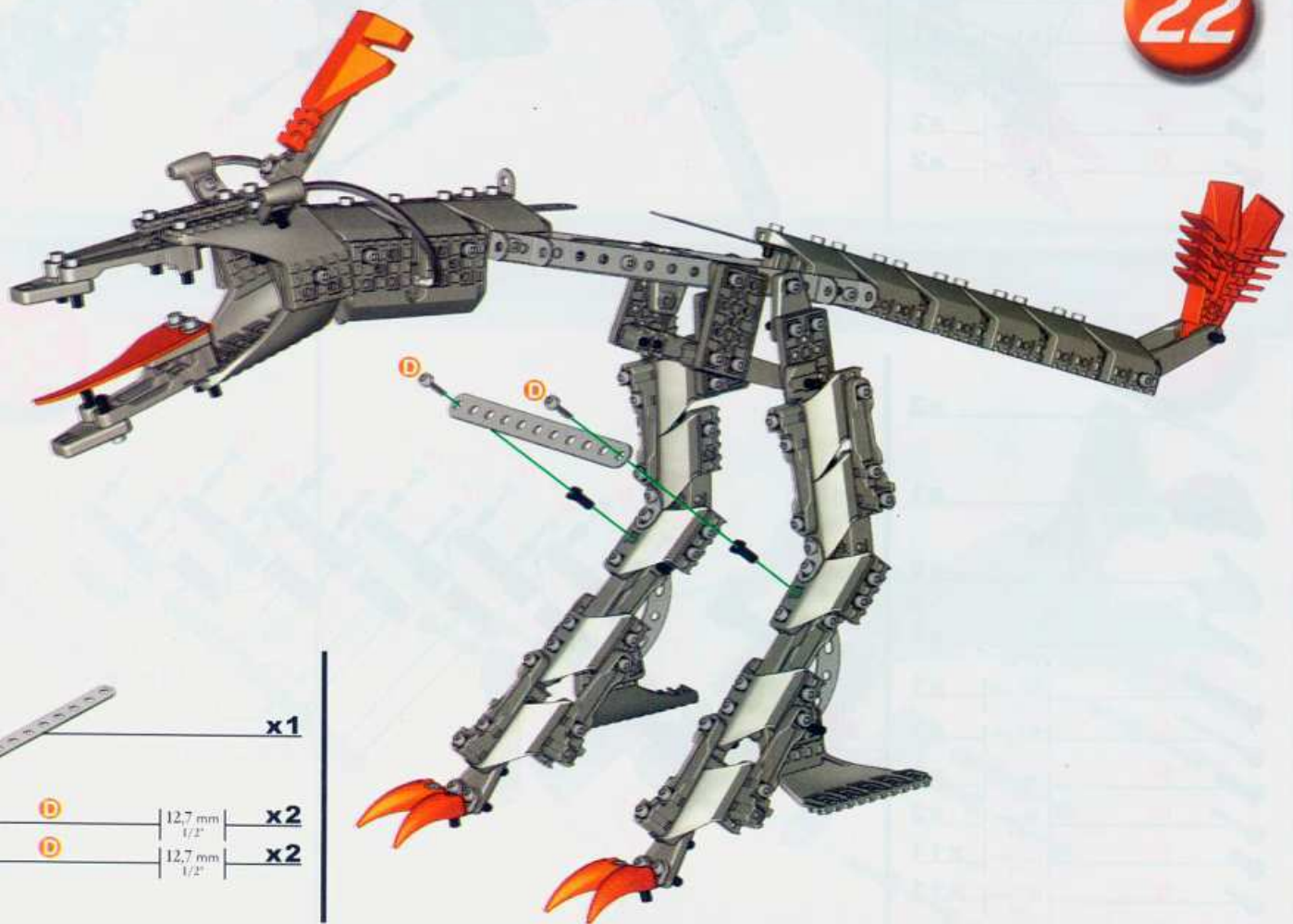

-  x2
-  x4
-  12,7 mm 1/2" x6
-  12,7 mm 1/2" x6





-  x1
-  12,7 mm 1/2" x2
-  12,7 mm 1/2" x2

23

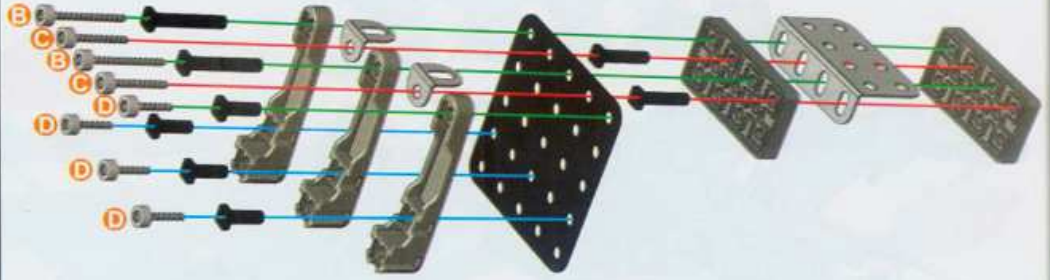
-  x1
-  x1
-  x2
-  x3
-  x2
-  x2
-  x2
-  x2
-  x4
-  x4





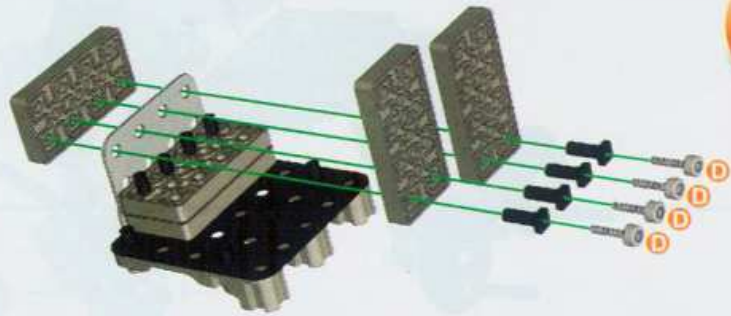

24

-  x3
-  x4
-  x4







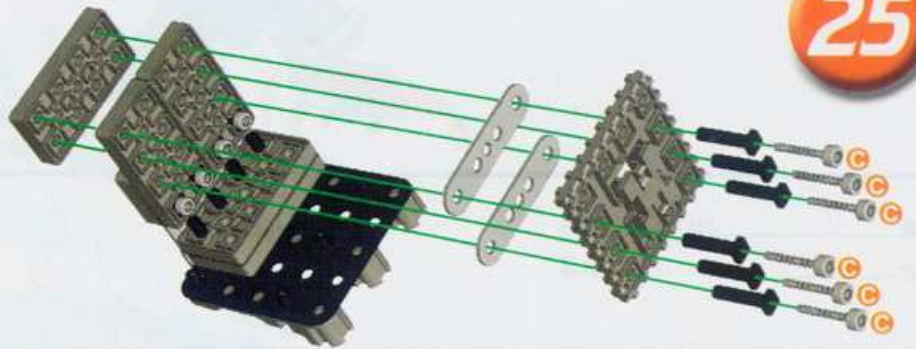



25

-  x1
-  x1
-  x2
-  x6
-  x6





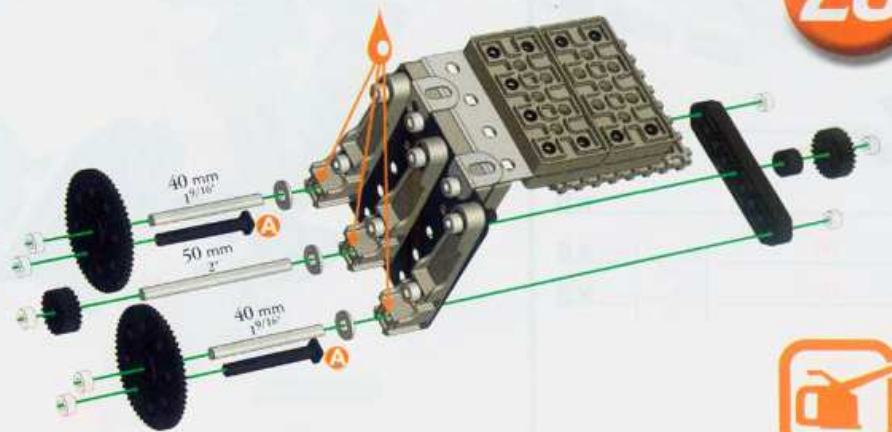

26

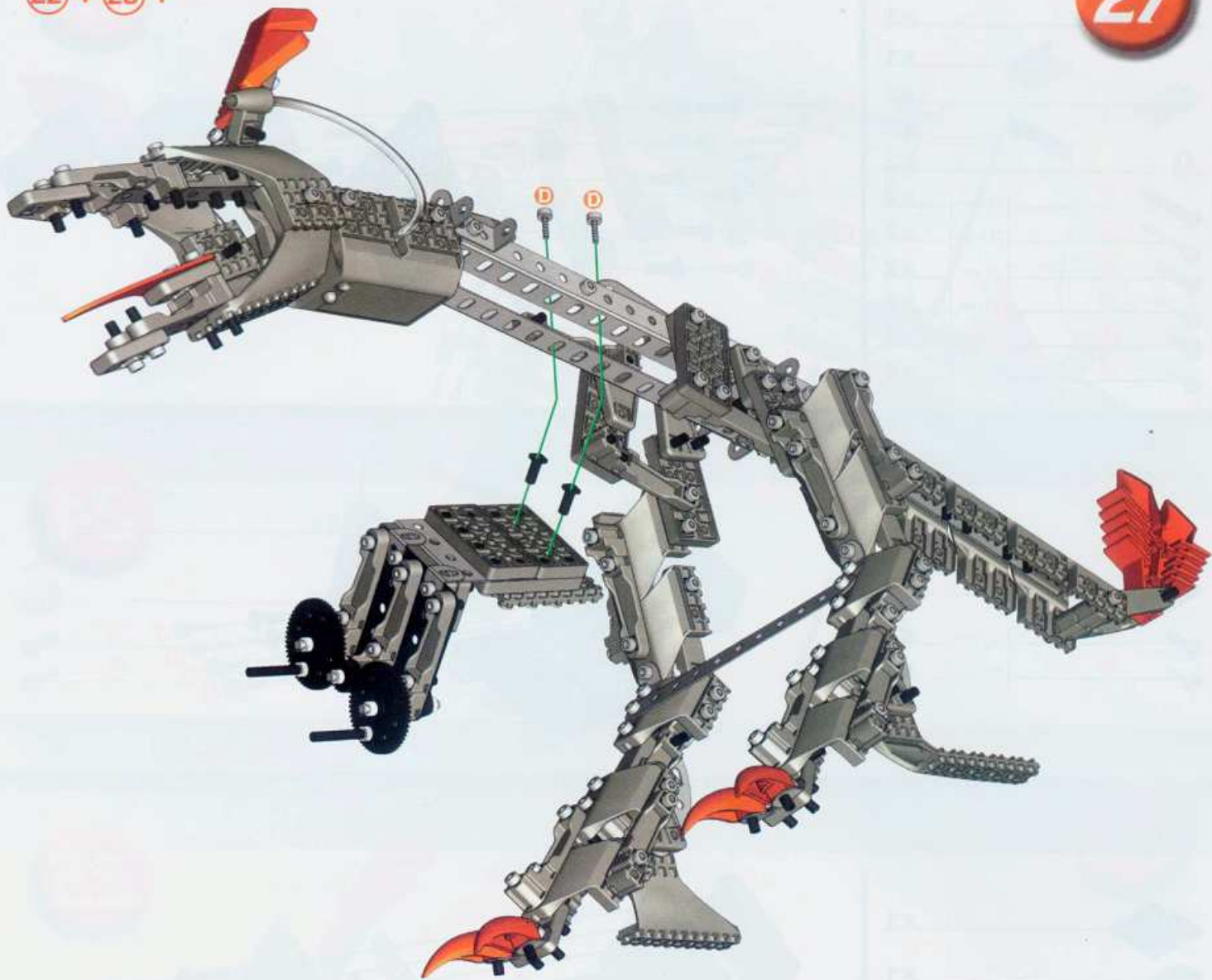
-  x1
-  x2
-  x1
-  x2
-  x1
-  x1
-  x1
-  x2
-  x3
- x8





-  **D** | 12,7 mm | **x2**
-  **D** | 12,7 mm | **x2**

-  **x4**
-  **x8**
-  **D** | 12,7 mm | **x8**
-  **D** | 12,7 mm | **x8**



x4

(27) + (28) +



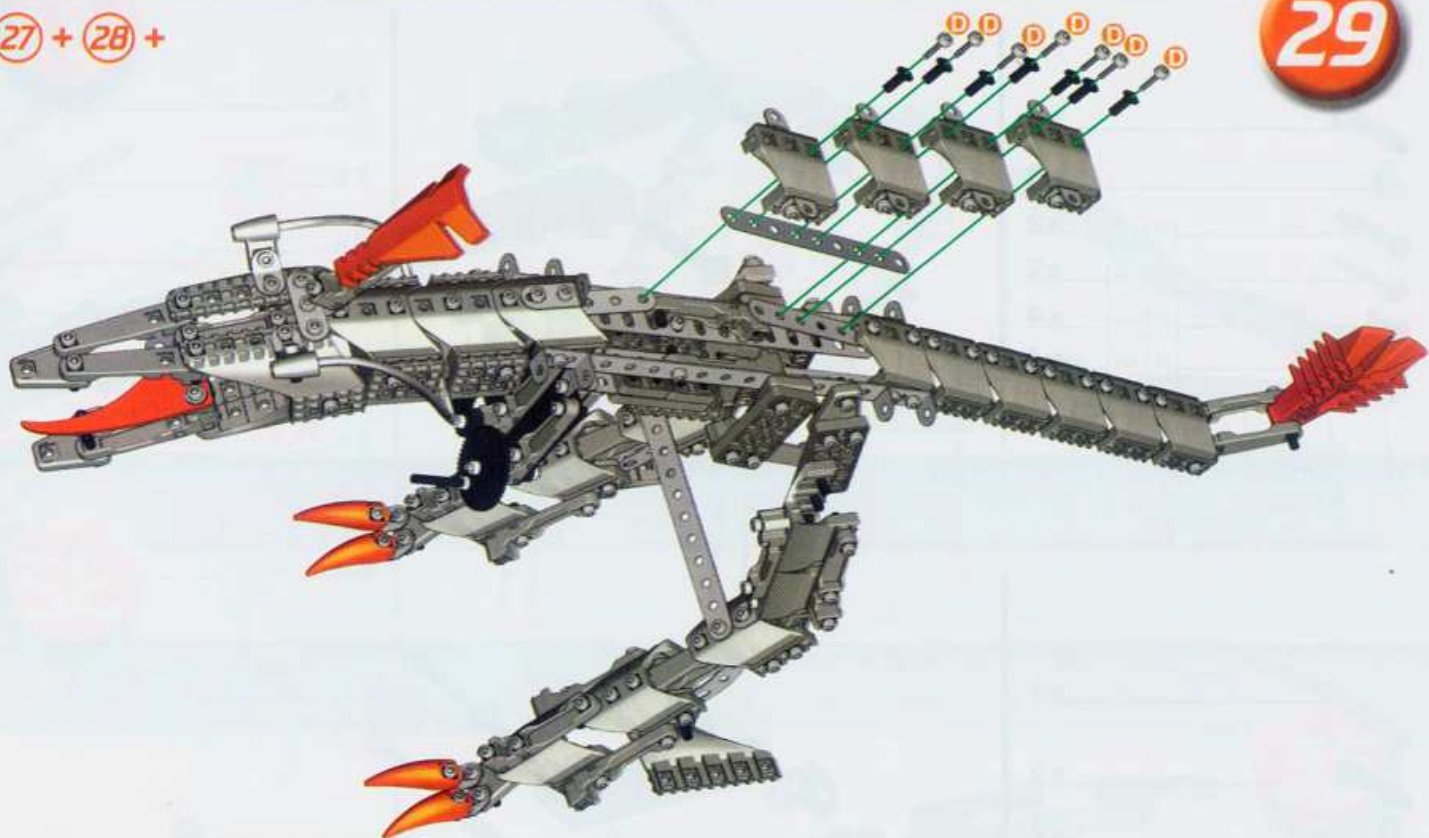



29

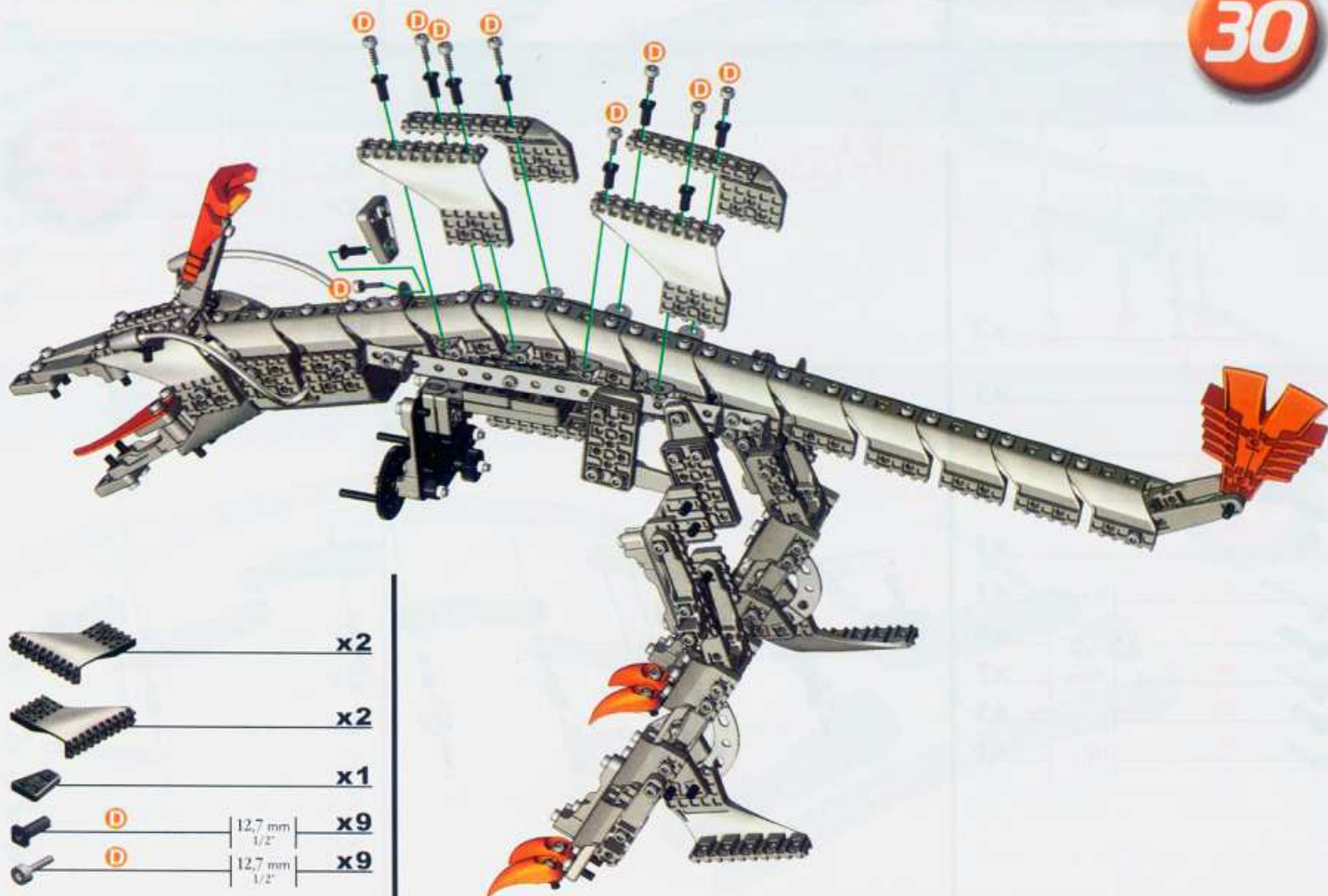







-   **x1**
-   **x7**
-   **x7**

30







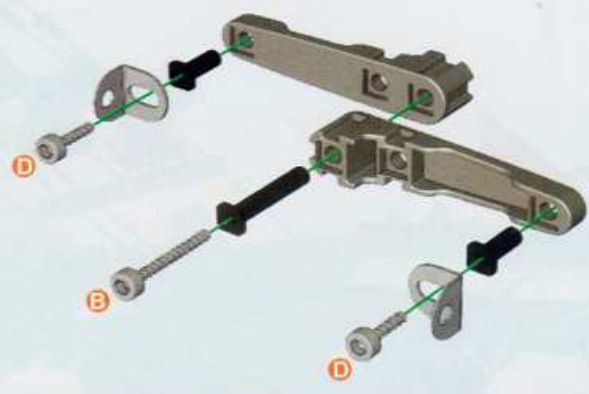

-  **x2**
-  **x2**
-  **x1**
-   **x9**
-   **x9**

-  **x4**
-  **x4**
-  **25,4 mm** **x2**
-  **25,4 mm** **x2**
-  **12,7 mm** **x4**
-  **12,7 mm** **x4**







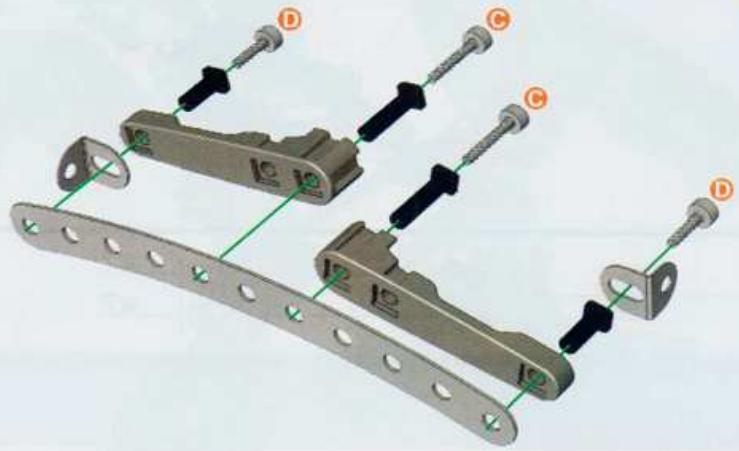





x2

-  **x1**
-  **x2**
-  **x2**
-  **19 mm** **x2**
-  **19 mm** **x2**
-  **12,7 mm** **x2**
-  **12,7 mm** **x2**



31 + 32 +

-  **x3**
-  **x1**
-  **x1**
-  **x7**
-  **x1**
-  **25,4 mm** **x1**
-  **19 mm** **x9**
-  **19 mm** **x7**
-  **12,7 mm** **x1**
-  **12,7 mm** **x1**

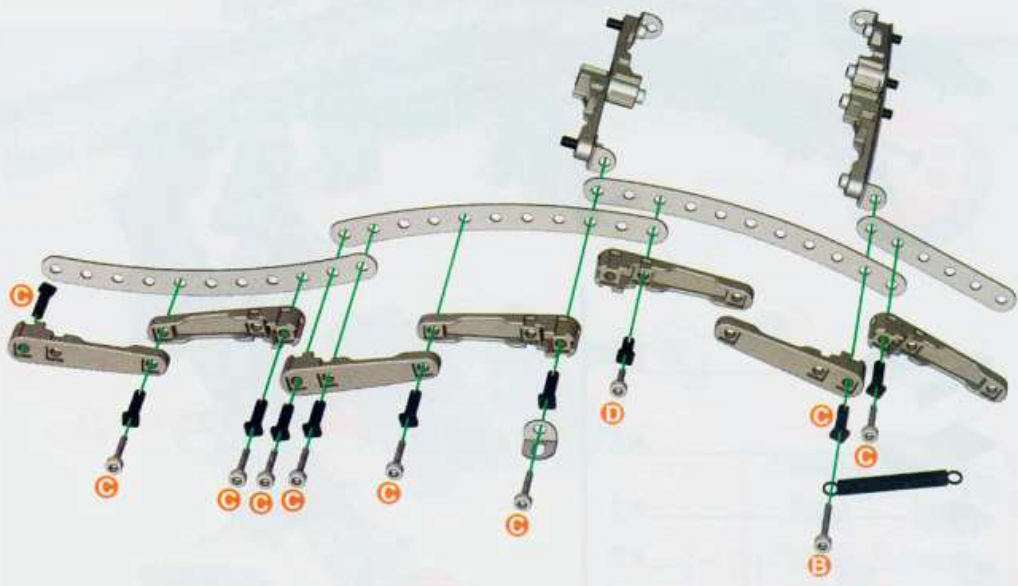

-  x1
-   x1
-  x8
-  x1
-  25,4 mm 1" x7
-  25,4 mm 1" x7
-  19 mm 3/4" x2
-  19 mm 3/4" x3
-  12,7 mm 1/2" x3
-  12,7 mm 1/2" x3

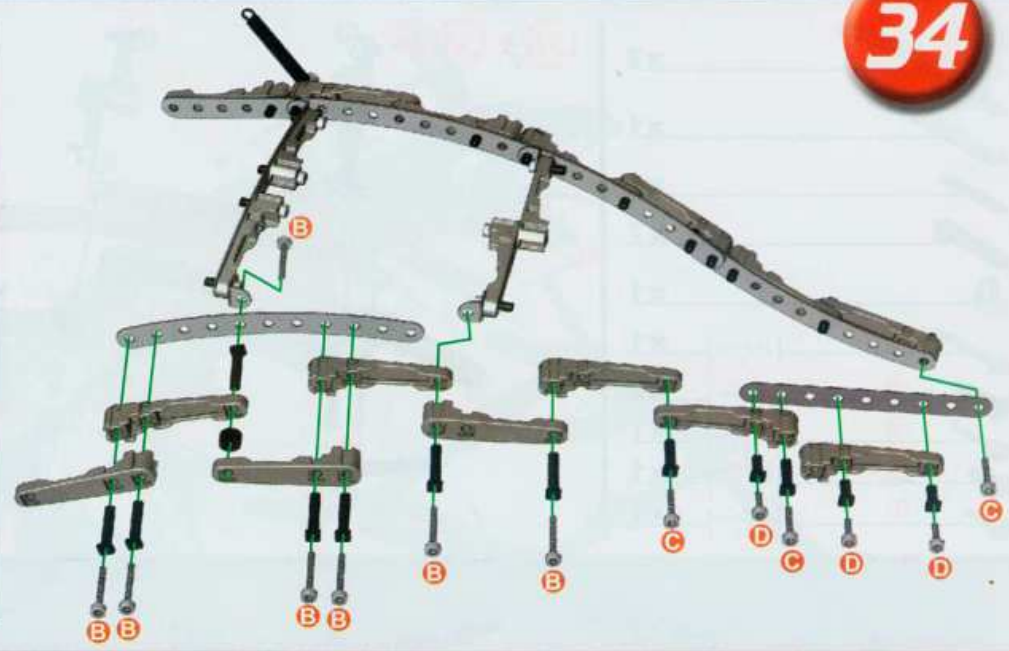

-  x1
-  x3
-  x1
-  x1
-  31,7 mm 1 1/8" x1
-  31,7 mm 1 1/8" x1
-  19 mm 3/4" x2
-  19 mm 3/4" x3
-  12,7 mm 1/2" x3
-  12,7 mm 1/2" x2





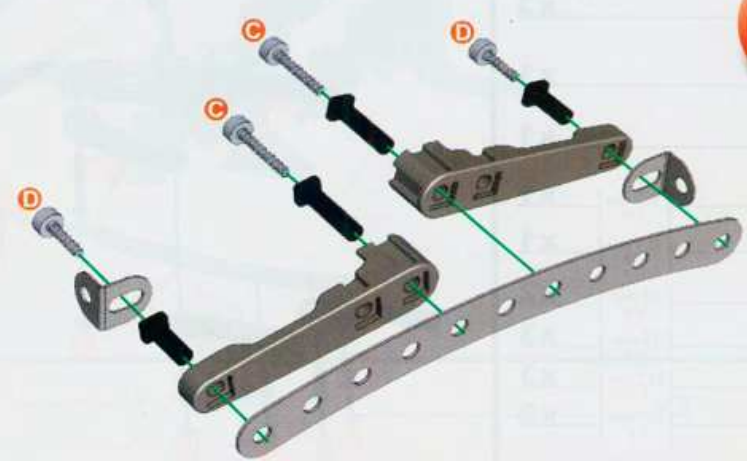





-  x1
-  x2
-  x2
-  19 mm 3/4" x2
-  19 mm 3/4" x2
-  12,7 mm 1/2" x2
-  12,7 mm 1/2" x2



37

31 + 36 +

-  x3
-  x1
-  x1
-  x7
-  x1
-  25,4 mm 1" x1
-  19 mm 3/4" x9
-  19 mm 5/4" x7
-  12,7 mm 1/2" x1
-  12,7 mm 1/2" x1

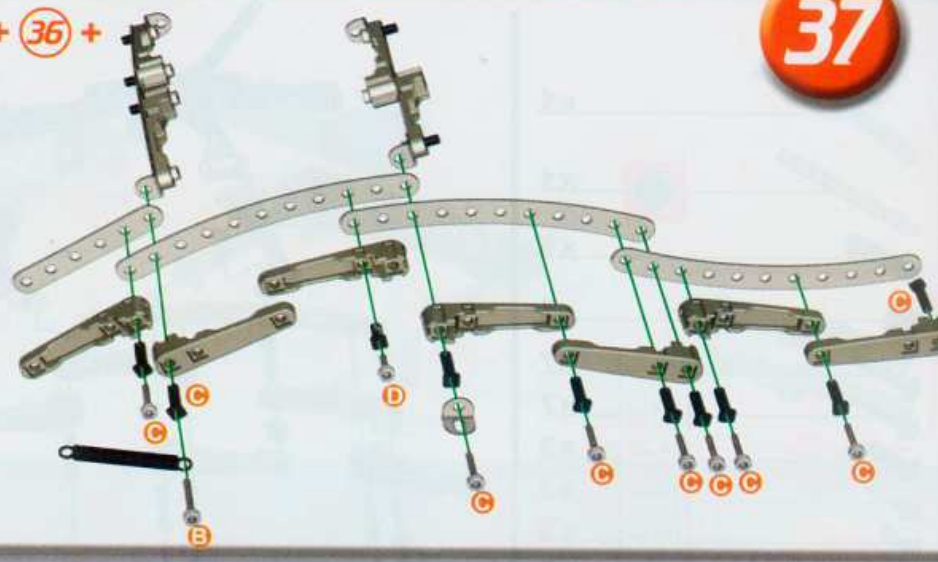





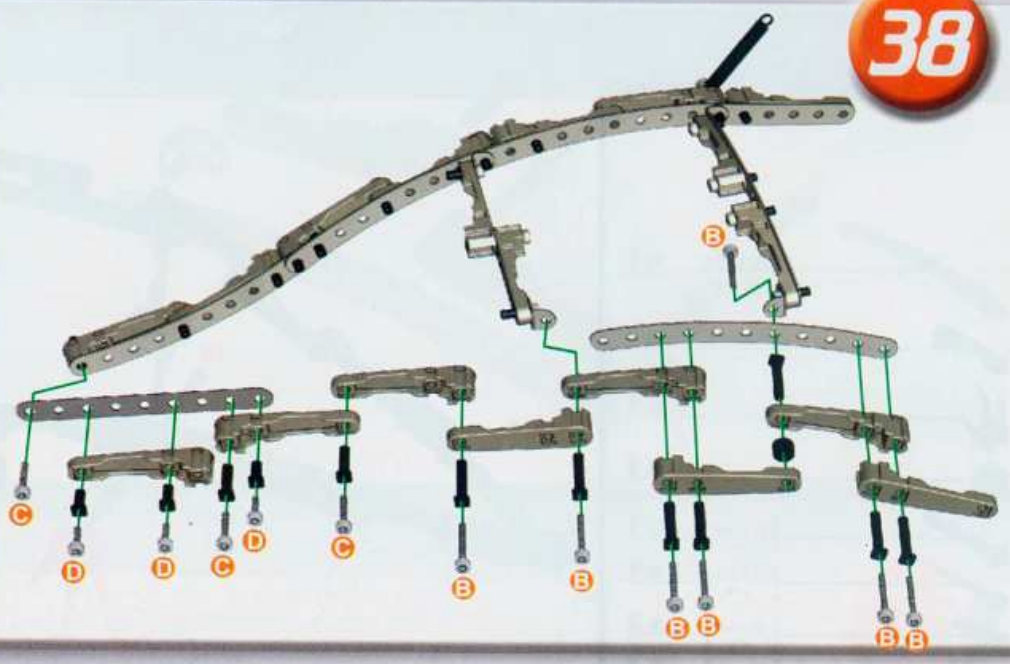





38

-  x1
-   x1
-  x8
-  x1
-  25,4 mm 1" x7
-  25,4 mm 1" x7
-  19 mm 3/4" x2
-  19 mm 5/4" x3
-  12,7 mm 1/2" x3
-  12,7 mm 1/2" x3



39





-  x1
-  x3
-  x1
-  x1
-  31,7 mm 1 1/8" x1
-  31,7 mm 1 1/8" x1
-  19 mm 3/4" x2
-  19 mm 3/4" x3
-  12,7 mm 1/2" x3
-  12,7 mm 1/2" x2



30 + 35 +

40



	31,7 mm 1 3/8"	x2		12,7 mm 1/2"	x1		x3
				12,7 mm 1/2"	x1		

39 + 40 +



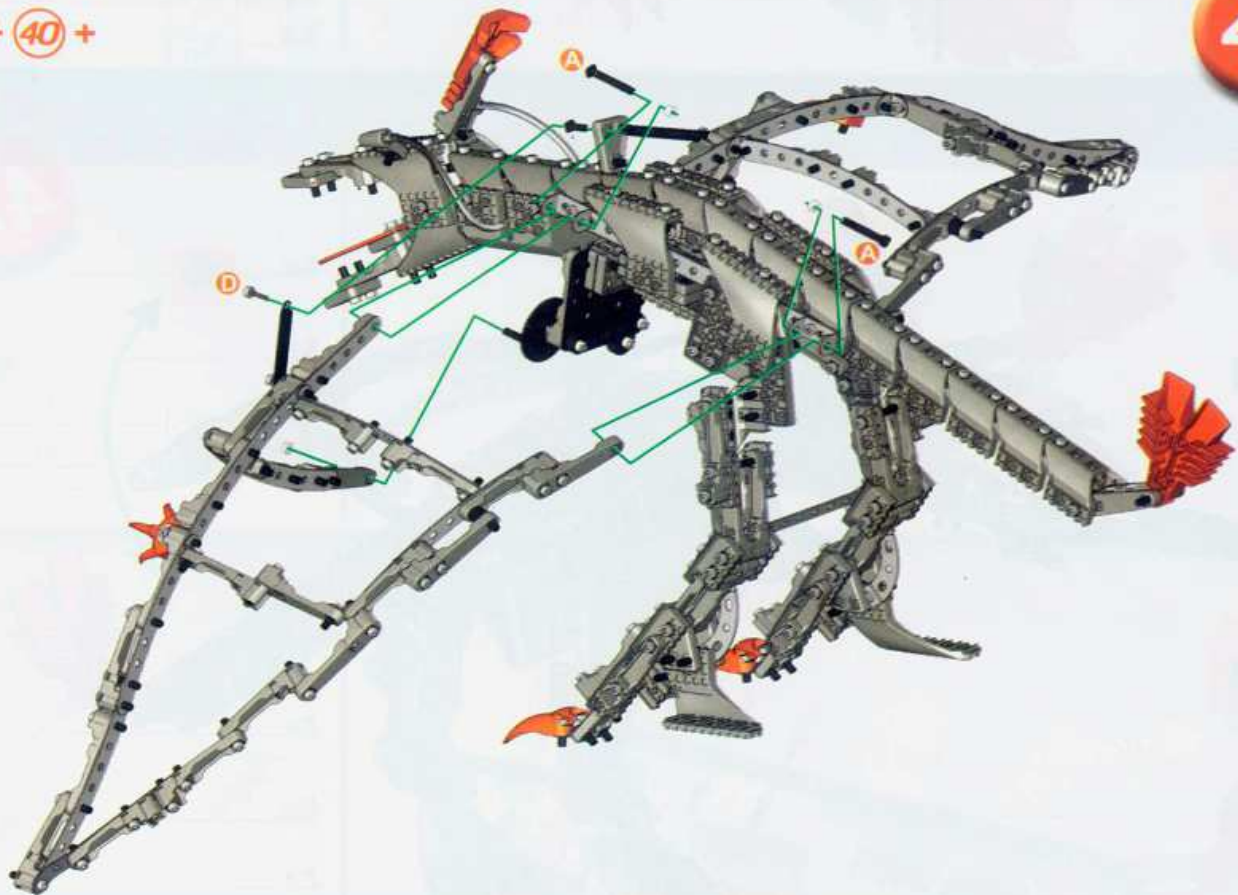

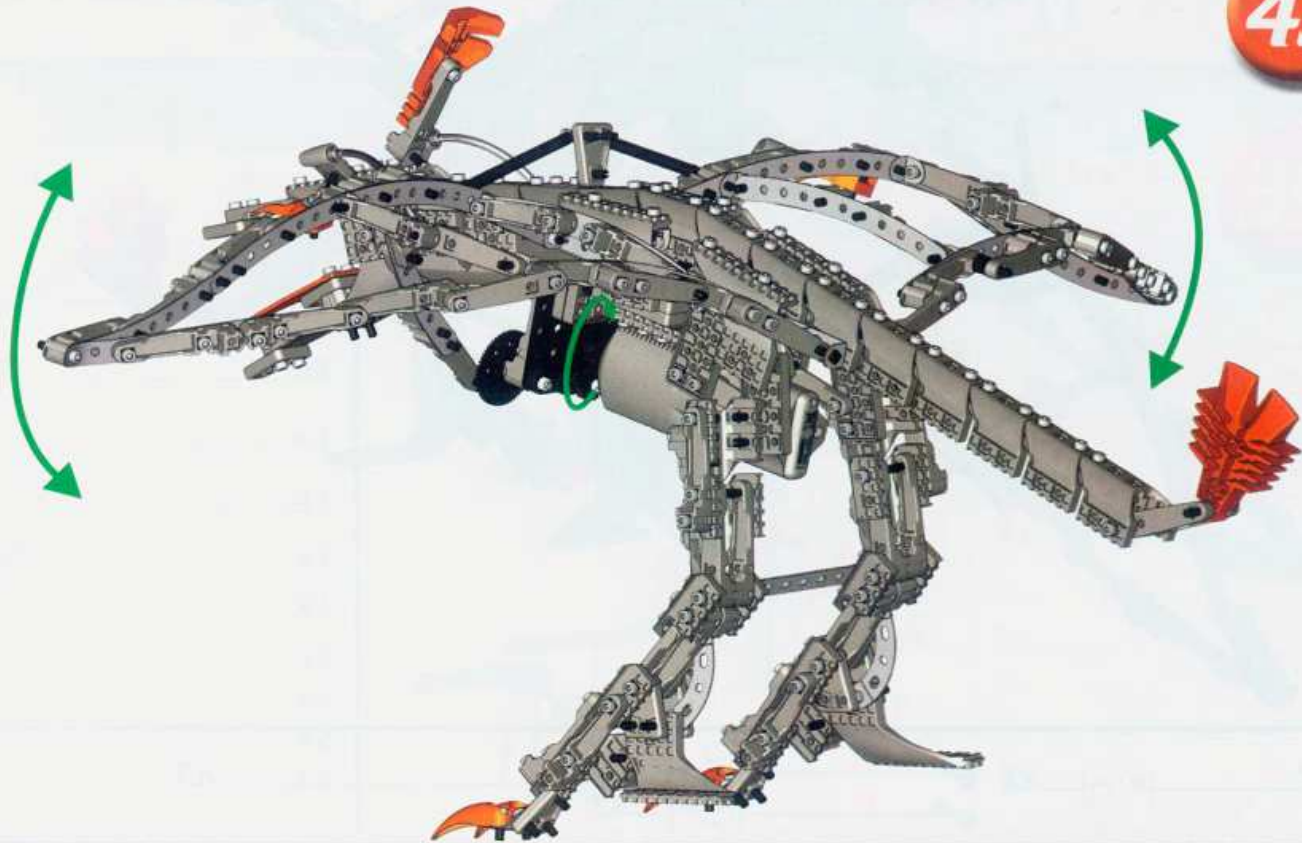
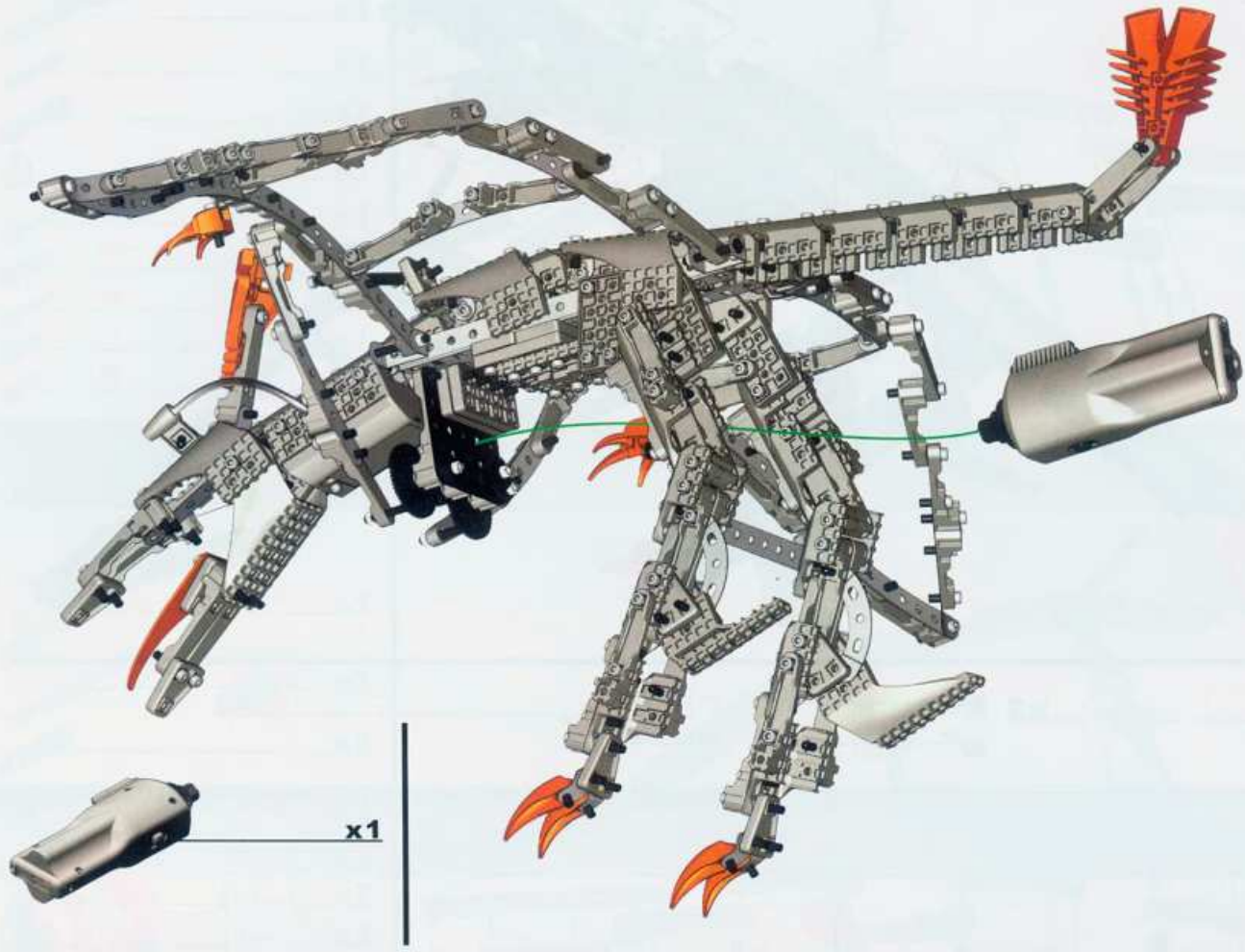

41

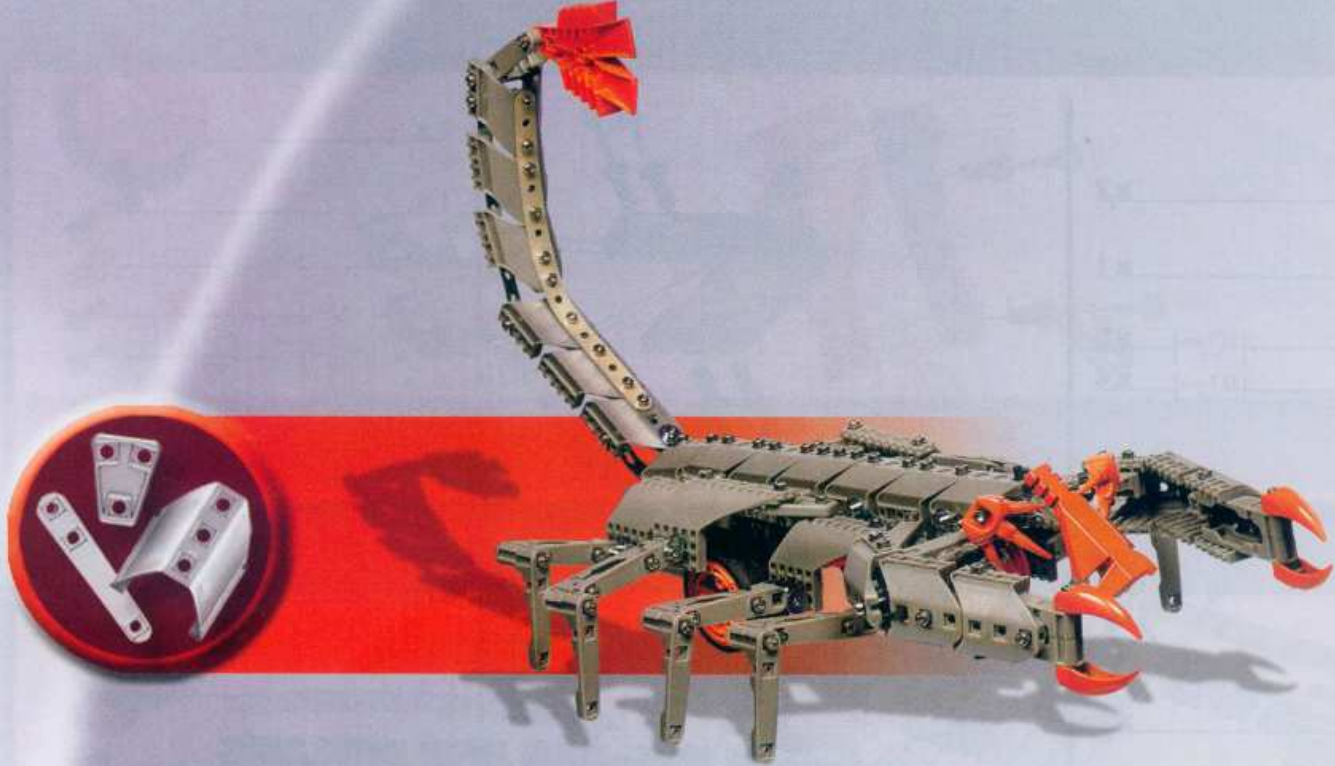

	31,7 mm 1 3/8"	x2		12,7 mm 1/2"	x1		x3
				12,7 mm 1/2"	x1		







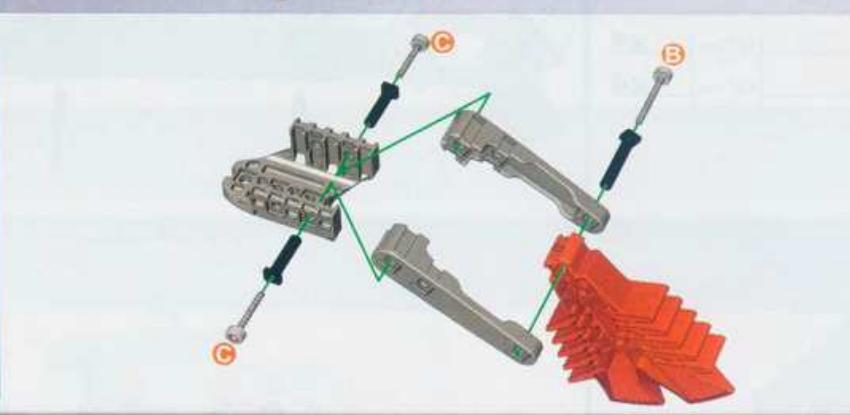

-  **x1**
-  **x1**
-  **x2**
-  **x1** | 25,4 mm | 1"
-  **x1** | 25,4 mm | 1"
-  **x2** | 19 mm | 3/4"
-  **x2** | 19 mm | 3/4"





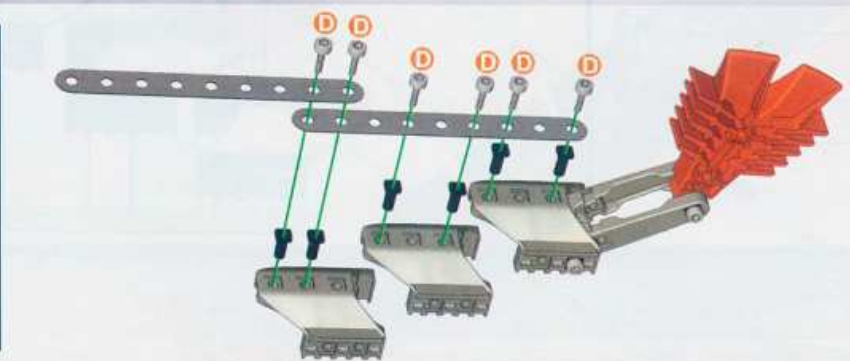

1

-   **x2**
-  **x2**
-  **x6** | 12,7 mm | 1/2"
-  **x6** | 12,7 mm | 1/2"



2

-  **x1**
-  **x3**
-  **x1**
-  **x5** | 12,7 mm | 1/2"
-  **x5** | 12,7 mm | 1/2"

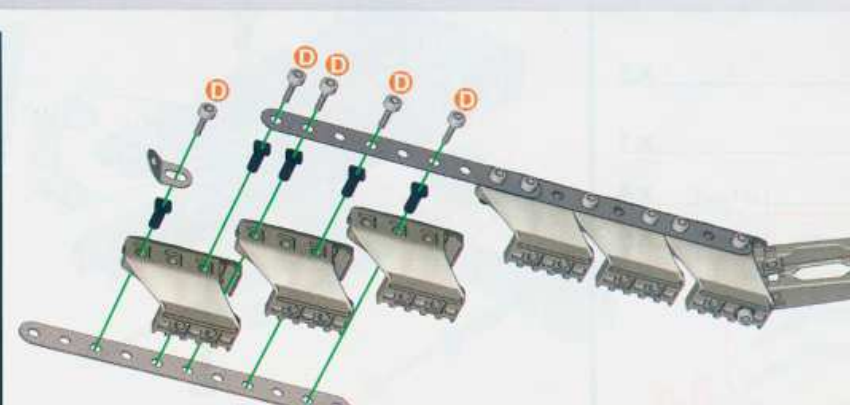



3

4

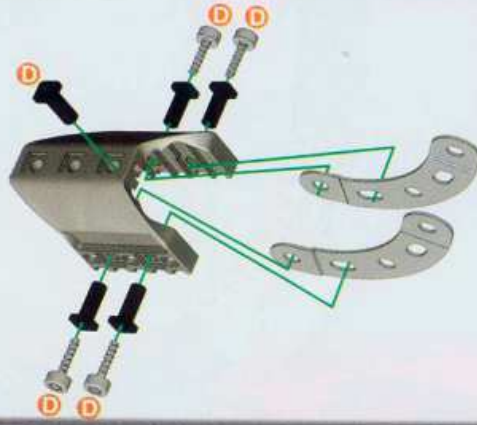
-  x2
-  x1
-  (D) | 12,7 mm | x5
-  (D) | 12,7 mm | x4





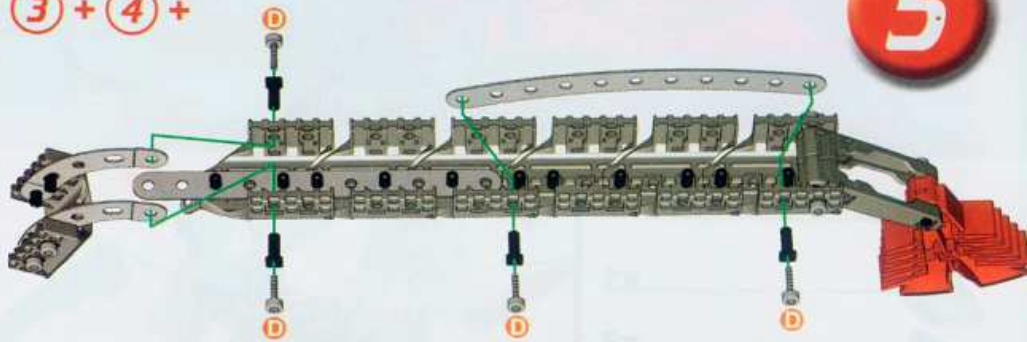

5

-  x1
-  (D) | 12,7 mm | x4
-  (D) | 12,7 mm | x4

(3) + (4) +



6

-  x1
-  x3
-  (D) | 12,7 mm | x5
-  (D) | 12,7 mm | x5

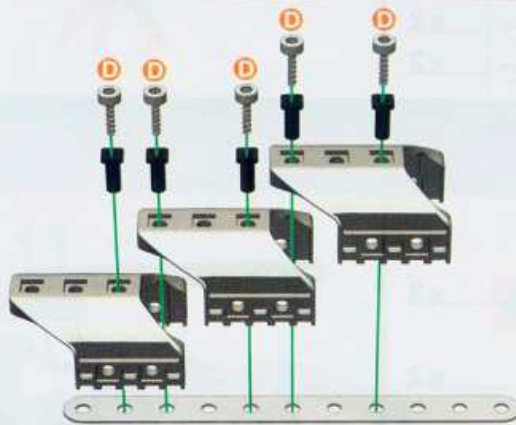

7

-  x1
-  x1
-  (D) | 12,7 mm | x4
-  (D) | 12,7 mm | x4

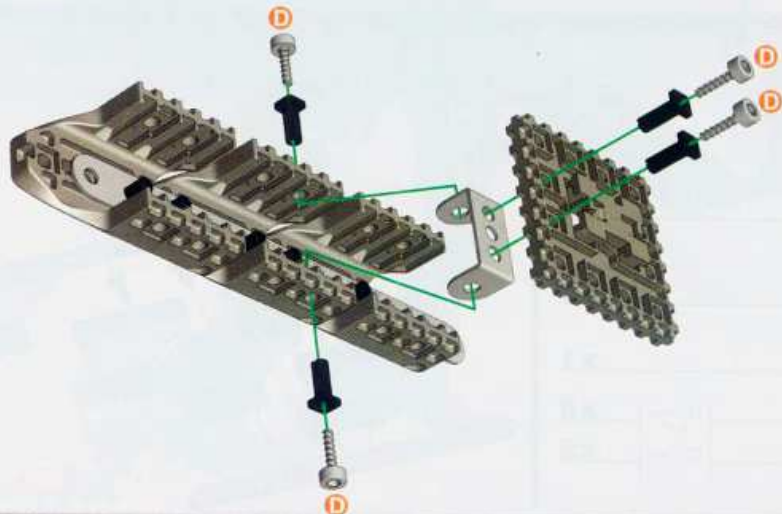



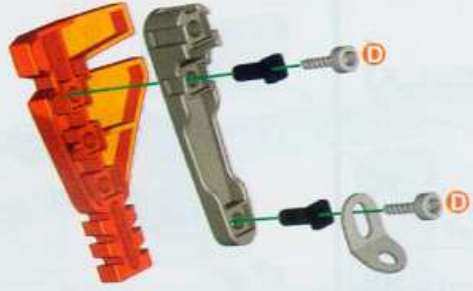

8

-  x1
-  x1
-  x1
-  (D) | 12,7 mm | x2
-  (D) | 12,7 mm | x2



9

(7) + (8) +

-  x1
-  x3
-  (D) | 12,7 mm | x7
-  (D) | 12,7 mm | x7

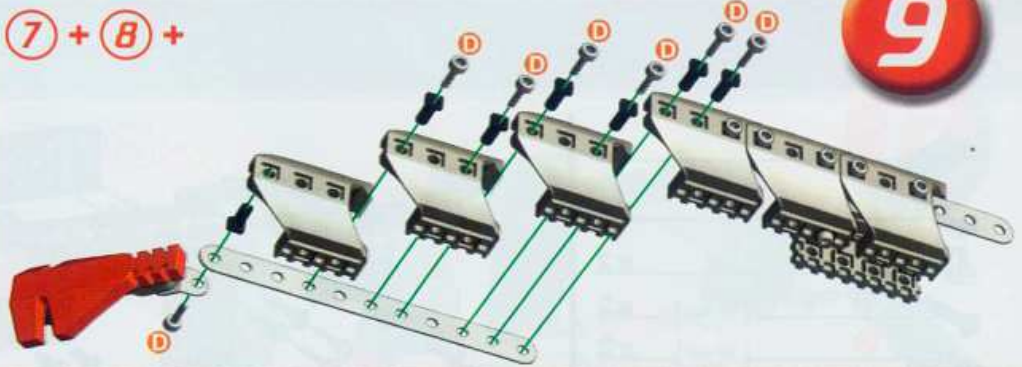

10

-  x2
-  x2
-  | 50 mm | x1
-  x1
-  x1
-  x1
-  x2
-  (D) | 12,7 mm | x4
-  (D) | 12,7 mm | x4

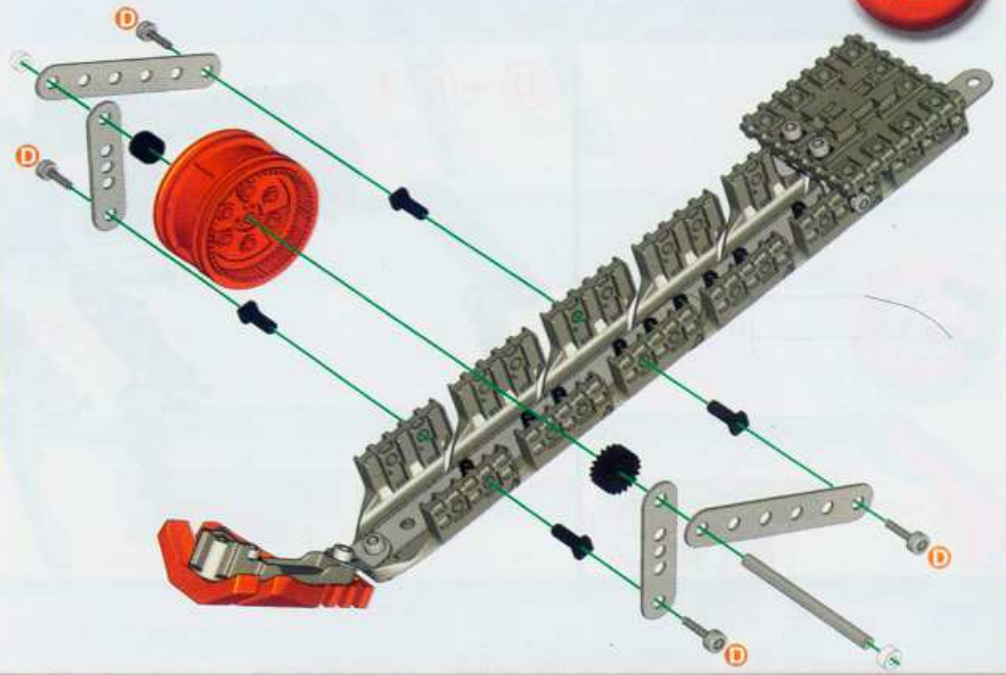



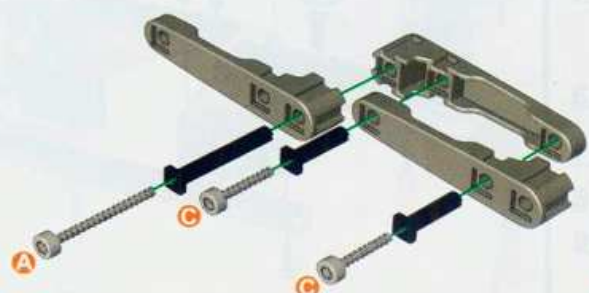

11

-  x24
-  (A) | 31,7 mm | x8
-  (A) | 31,7 mm | x8
-  (C) | 19 mm | x16
-  (C) | 19 mm | x16







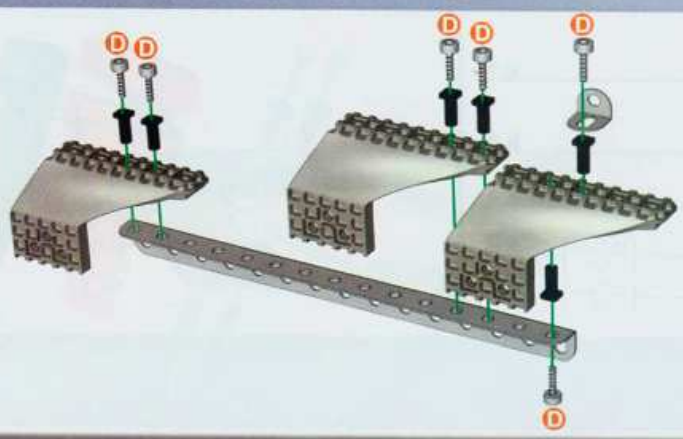

x8

12

-  x1
-  x3
-  x1
-  (D) | 12,7 mm | x6
-  (D) | 12,7 mm | x6



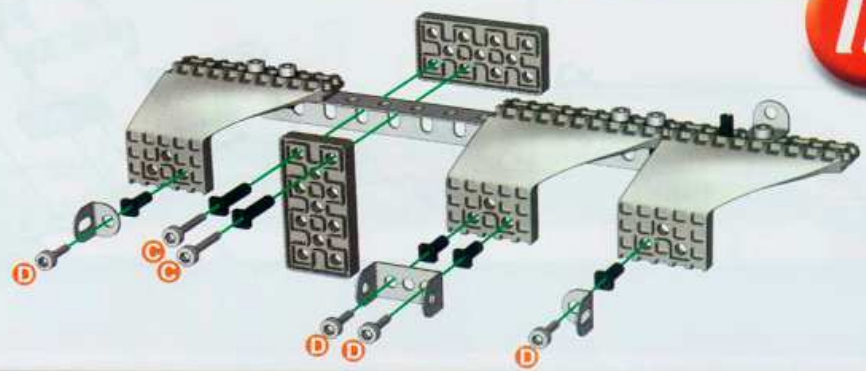

13

-  x2
-  x1
-  x2
-  (C) | 19 mm | x2
-  (C) | 19 mm | x2
-  (D) | 12,7 mm | x4
-  (D) | 12,7 mm | x4





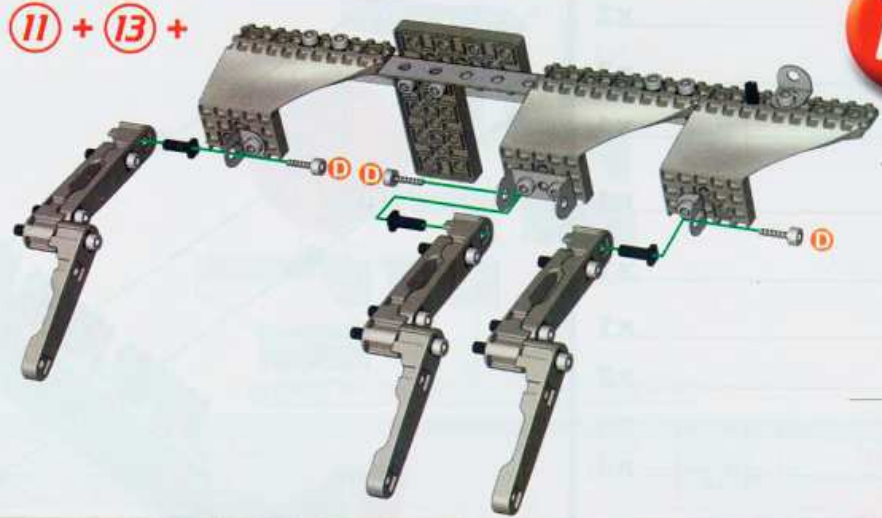

14

-  (D) | 12,7 mm | x3
-  (D) | 12,7 mm | x3

(11) + (13) +







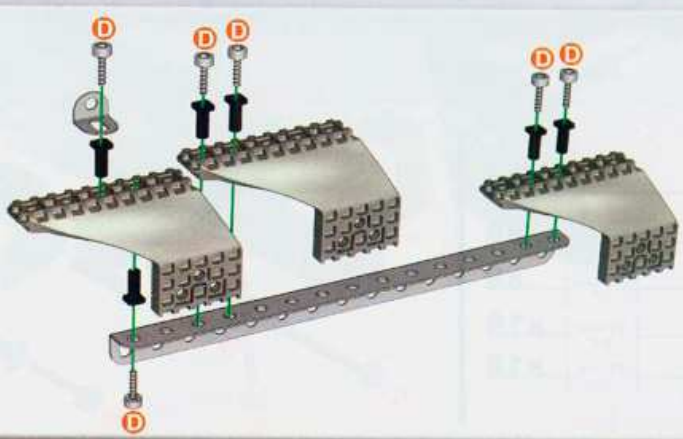

15

-  x1
-  x3
-  x1
-  (D) | 12,7 mm | x6
-  (D) | 12,7 mm | x6



16

-  x2
-  x1
-  x2
-  19 mm 3/4" x2
-  19 mm 3/4" x2
-  12,7 mm 1/2" x4
-  12,7 mm 1/2" x4

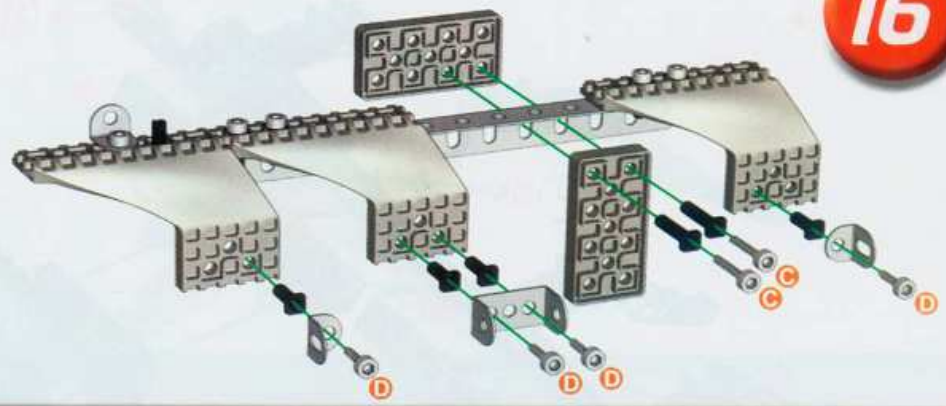

17

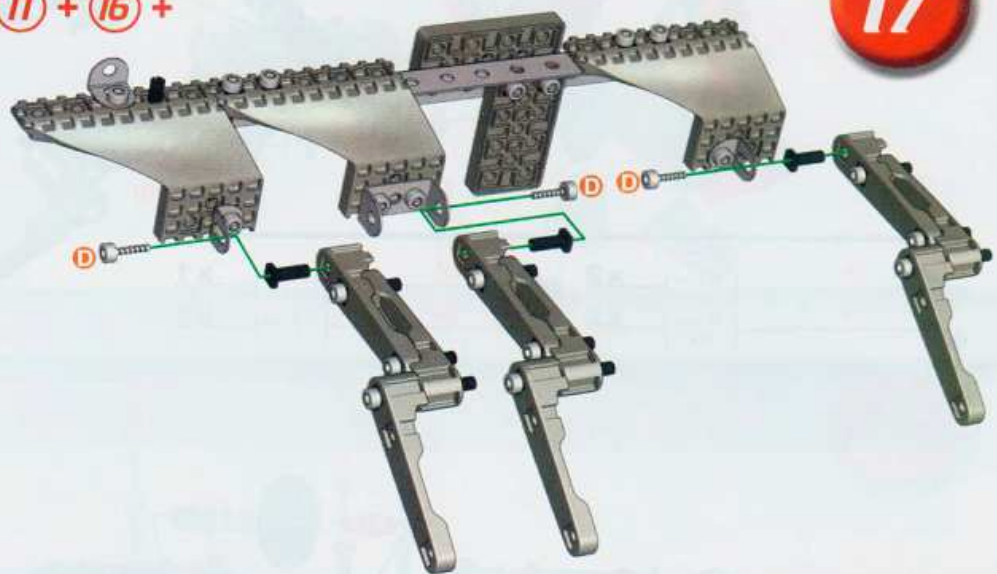

11 + 16 +

-  12,7 mm 1/2" x3
-  12,7 mm 1/2" x3



18

10 + 14 +

-  19 mm 3/4" x2
-  19 mm 3/4" x2
-  12,7 mm 1/2" x1
-  12,7 mm 1/2" x1

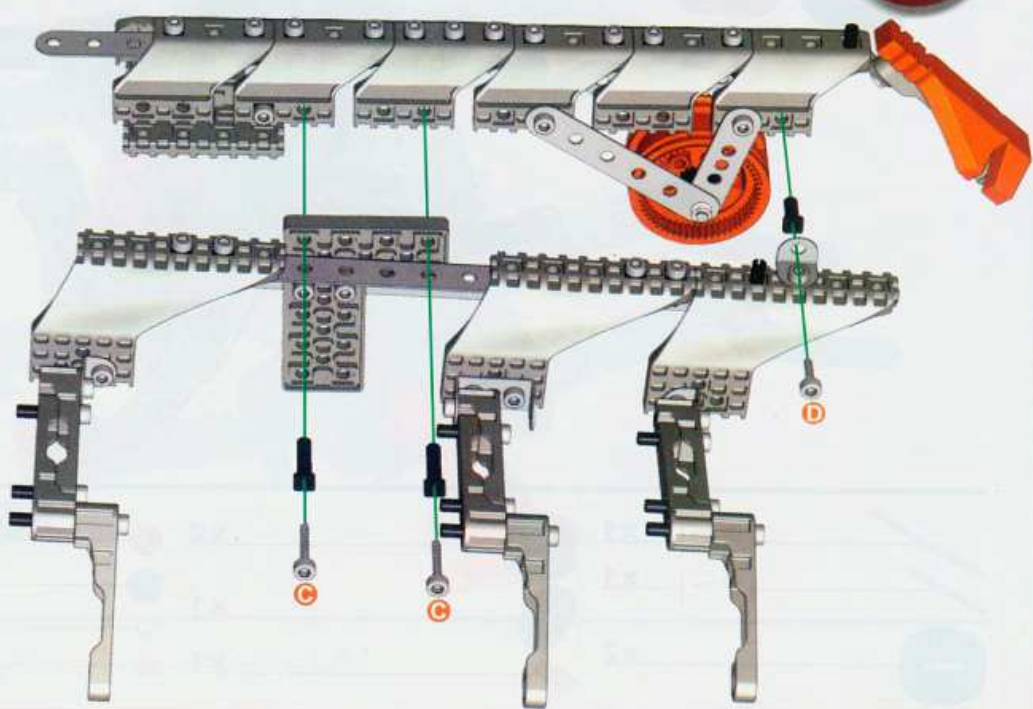

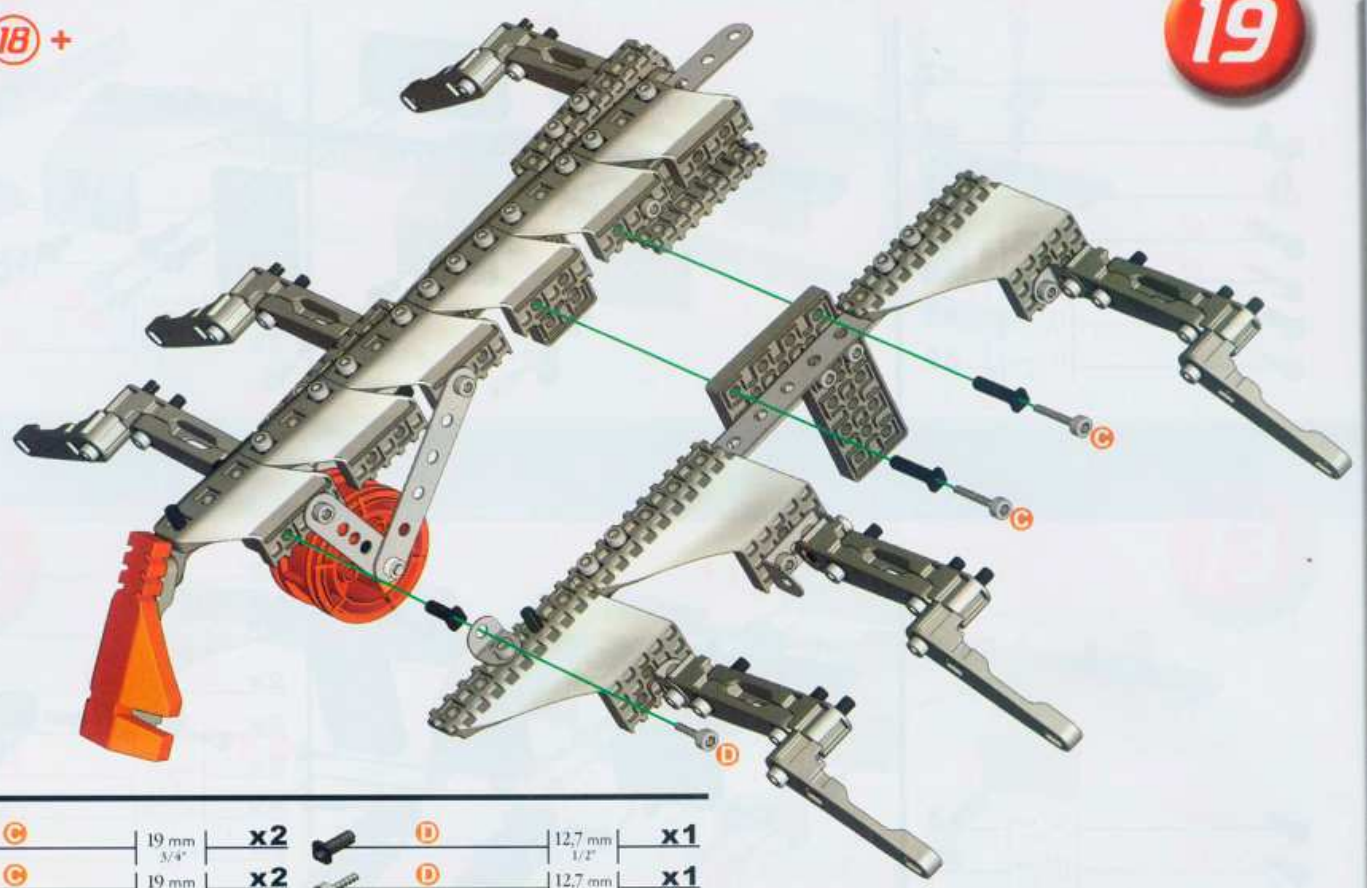



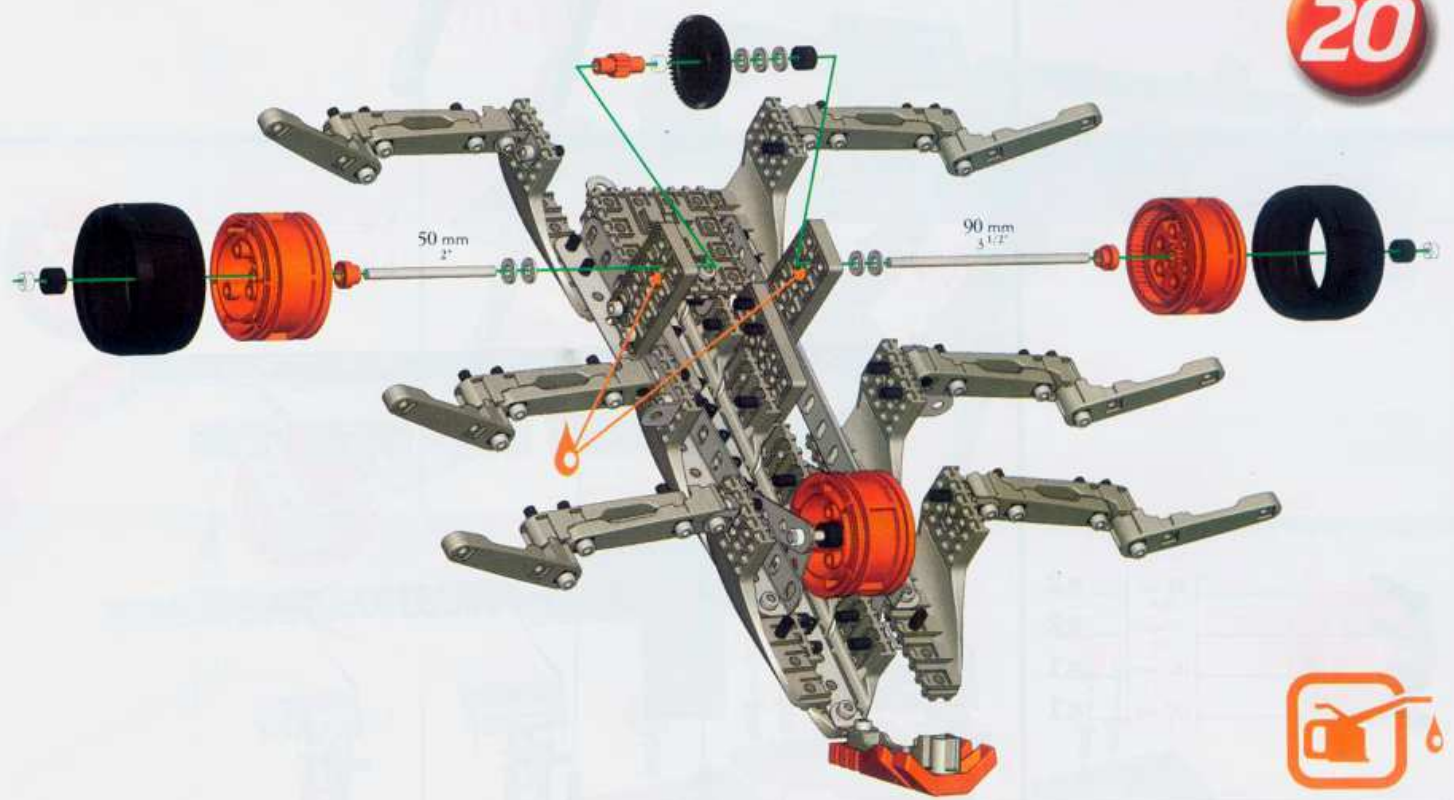



	19 mm	x2		12,7 mm	x1
	19 mm	x2		12,7 mm	x1



	90 mm	x1		x2		x2
	50 mm	x1		x1		x3
		x2		x1		x3
				x1		x1





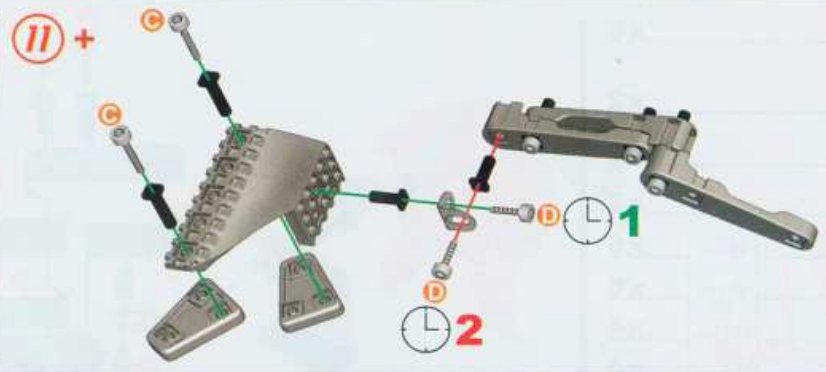

21

-  x1
-  x2
-  x1
-  (C) x2
-  (C) x2
-  (D) x2
-  (D) x2



22

-  x1
-  x2
-  x1
-  (C) x2
-  (C) x2
-  (D) x2
-  (D) x2

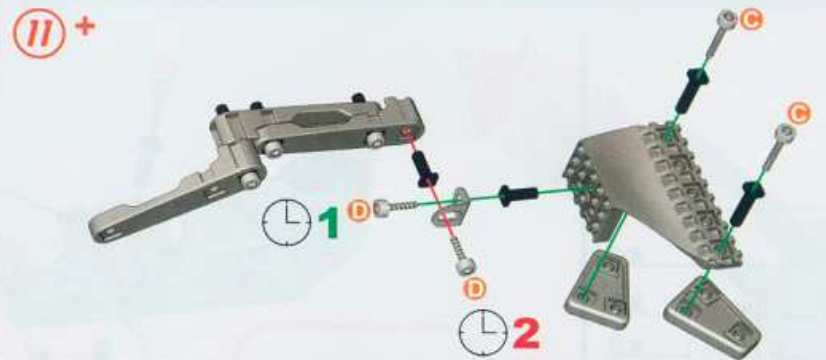

23



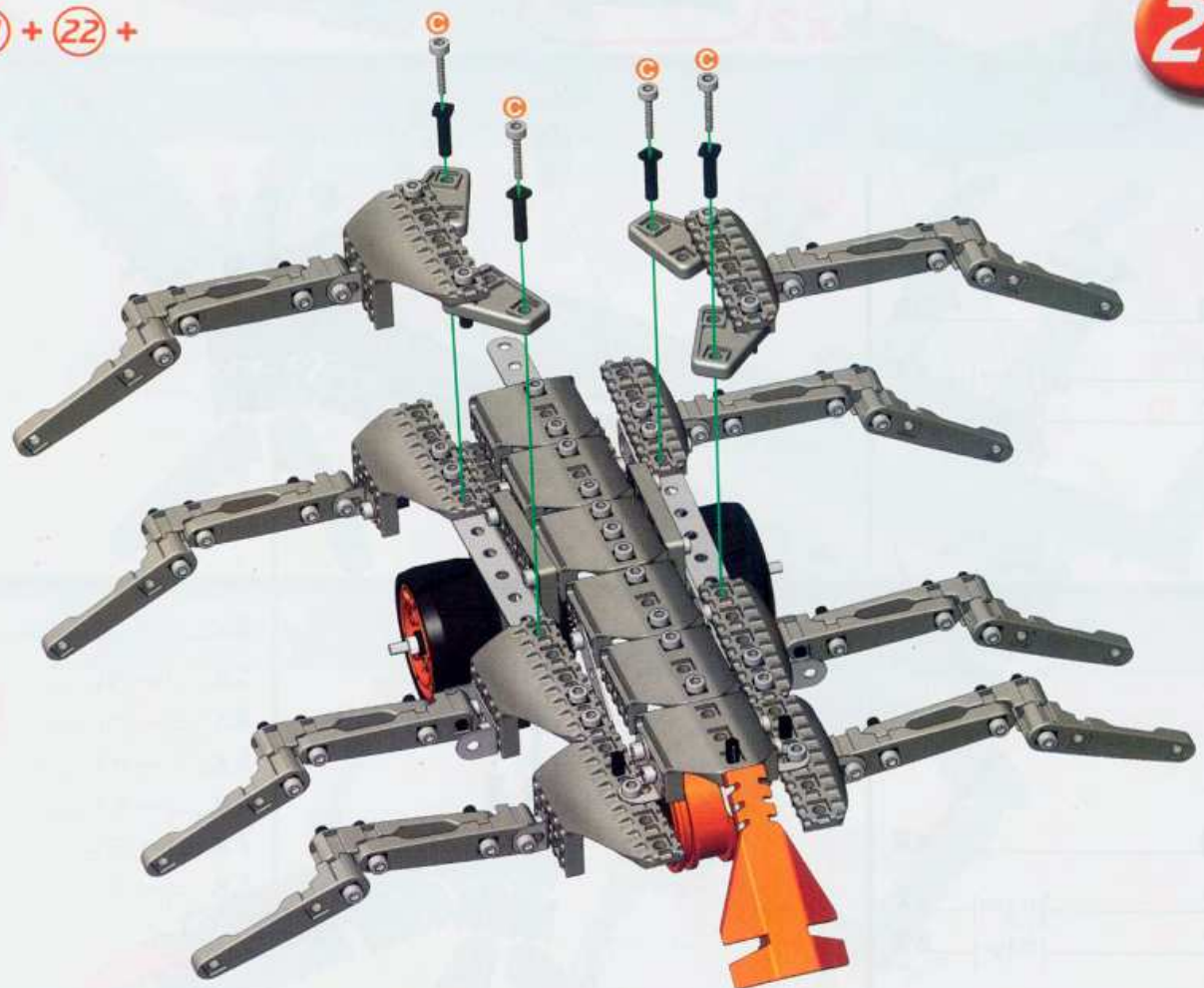

20 + 21 + 22 +

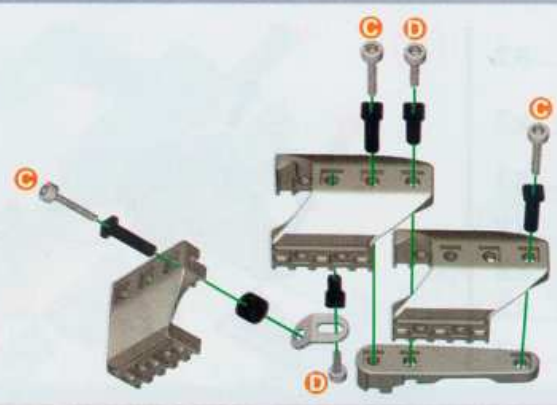

-  (C) x4
-  (D) x4



-  **x6**
-  **x2**
-  **x2**
-  **x2**
-  **x6**
-  **x6**
-  **x4**
-  **x4**

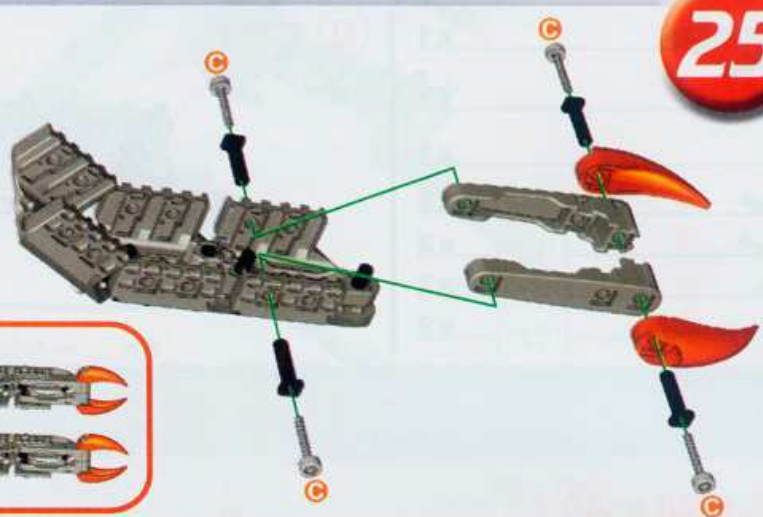

-  **x4**
-  **x4**
-  **x8**
-  **x8**



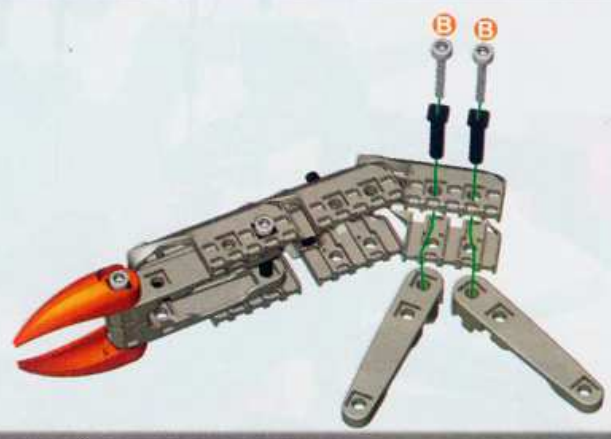

(25) +

-  **x2**
-  **x2**
-  **x2**



(25) +

-  **x2**
-  **x2**
-  **x2**

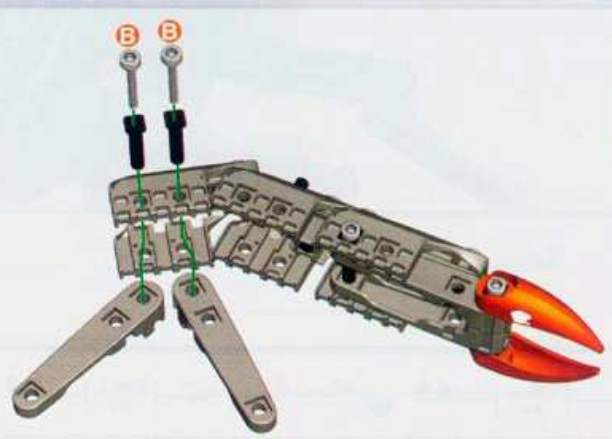

			x2
			x2
	B	12,7 mm 1/2"	x2
	D	12,7 mm 1/2"	x2

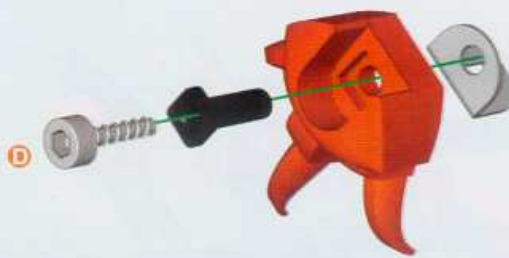

x2

5 + 23 + 26 + 27 + 28 +

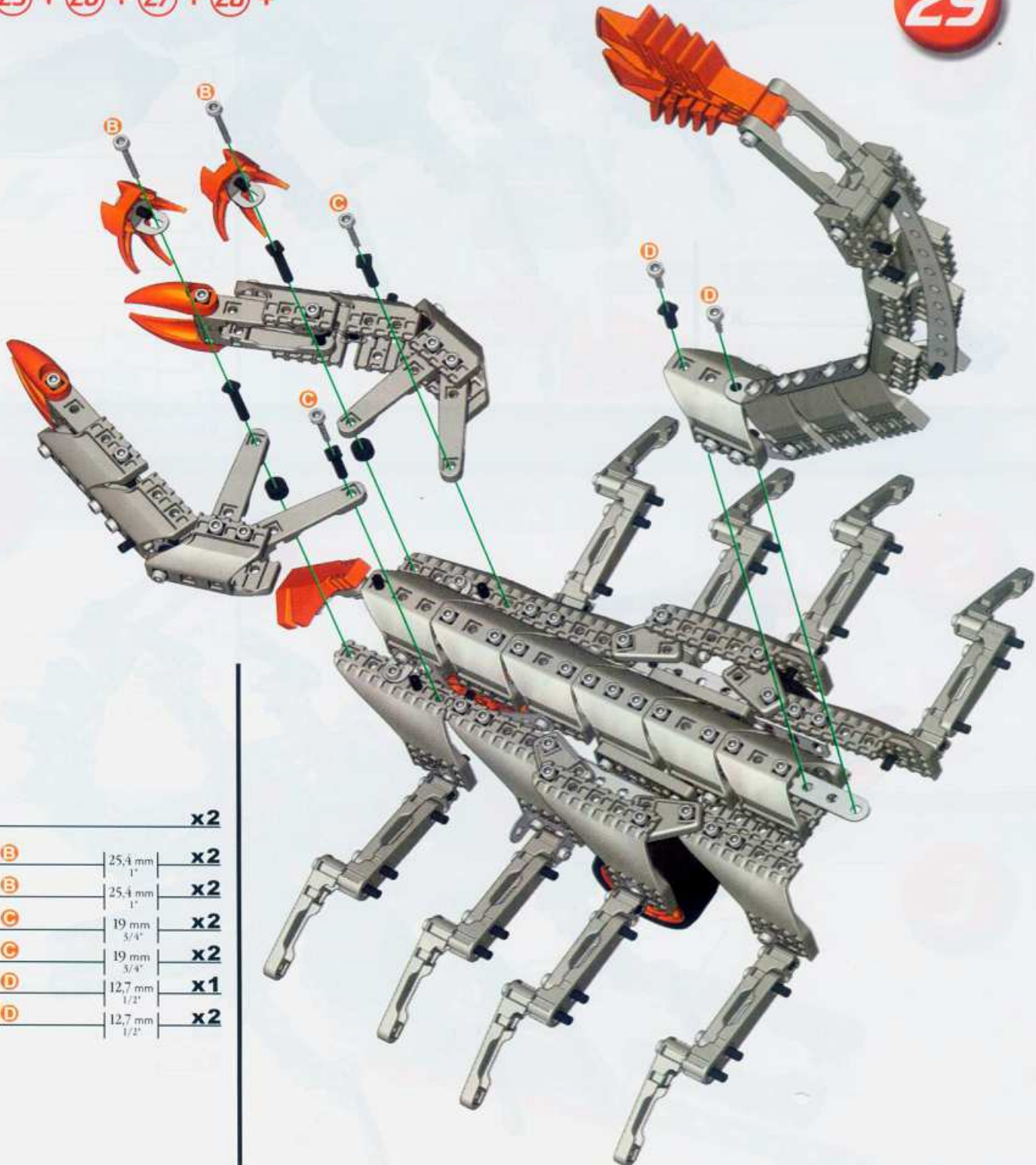

			x2
	B	25,4 mm 1"	x2
	B	25,4 mm 1"	x2
	C	19 mm 3/4"	x2
	C	19 mm 3/4"	x2
	D	12,7 mm 1/2"	x1
	D	12,7 mm 1/2"	x2

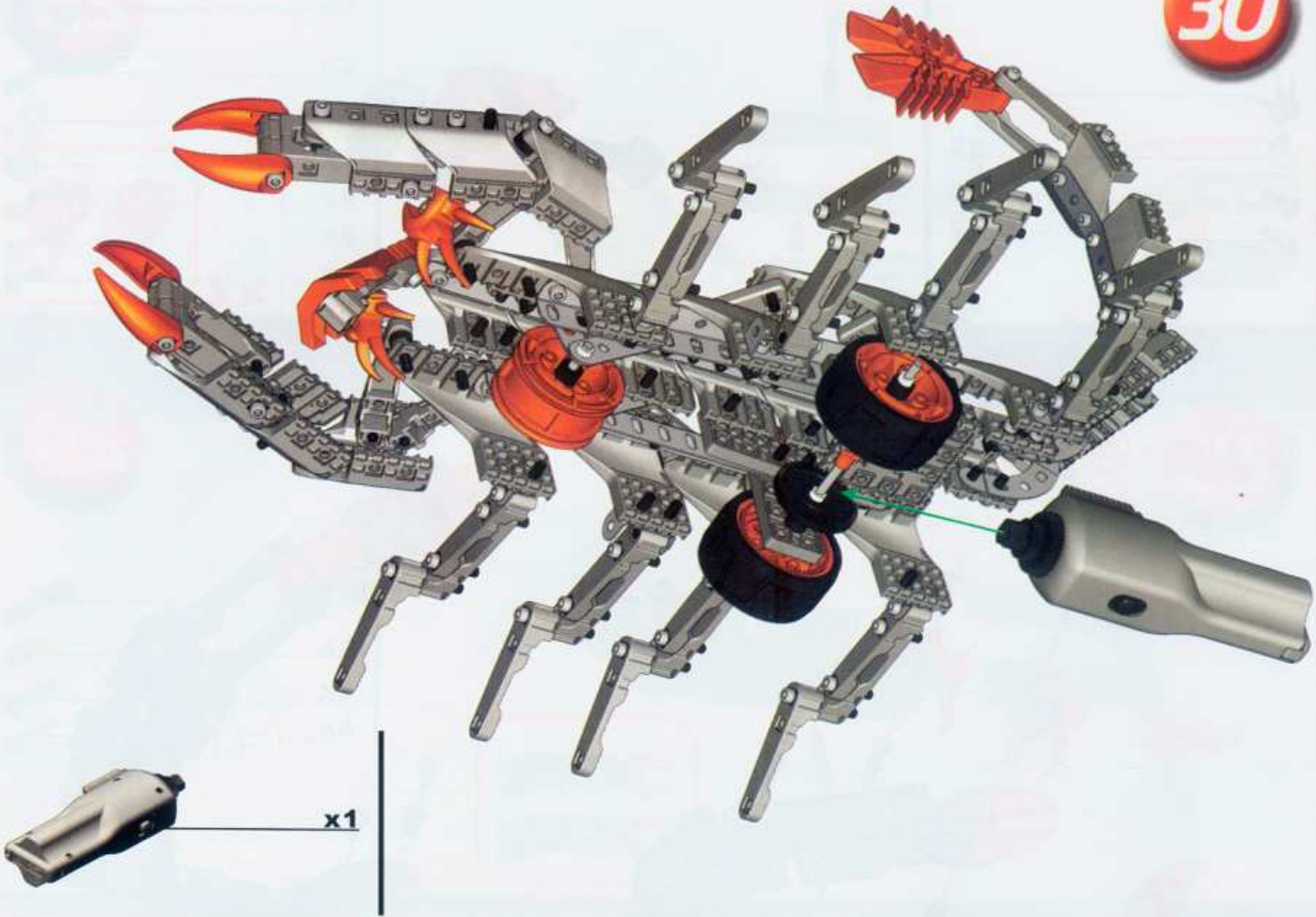



1

- x1
- x1
- x1
- x1
- x1
- x1
- 19 mm **x1**
5/4"
- 19 mm **x1**
5/4"
- 12,7 mm **x2**
1/2"
- 12,7 mm **x2**
1/2"

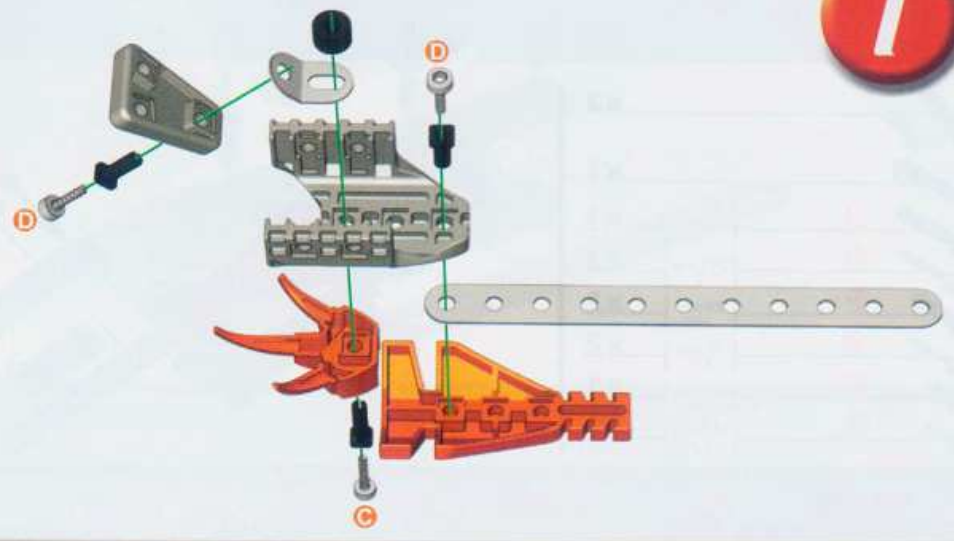

- x1
- 12,7 mm **x3**
1/2"
- 12,7 mm **x3**
1/2"

2

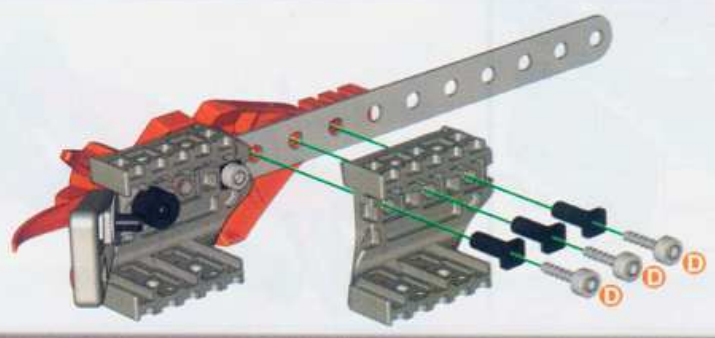



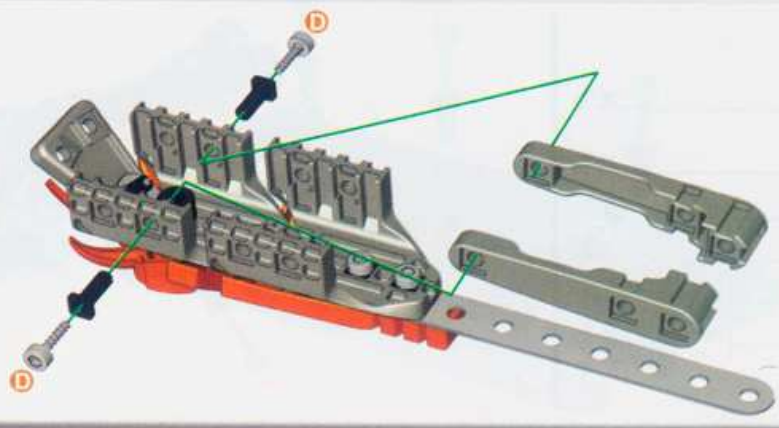

- x2
- 12,7 mm **x2**
1/2"
- 12,7 mm **x2**
1/2"

3



4

-  x2
-  x2
-  19 mm 3/4" x6
-  19 mm 3/4" x6

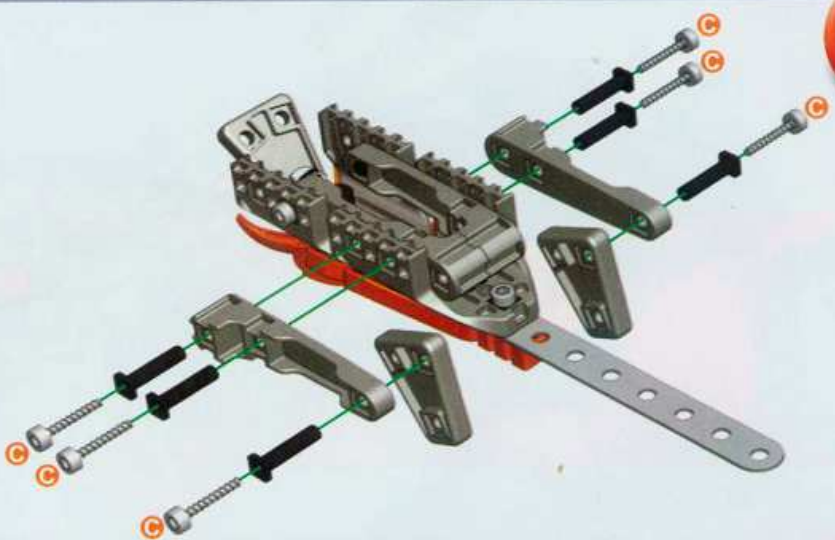

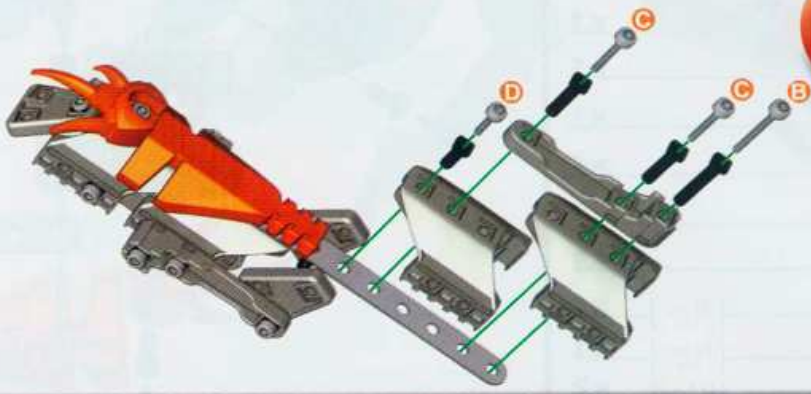

5

-  x2
-  x1
-  25,4 mm 1" x1
-  25,4 mm 1" x1
-  19 mm 3/4" x2
-  19 mm 3/4" x2
-  12,7 mm 1/2" x1
-  12,7 mm 1/2" x1







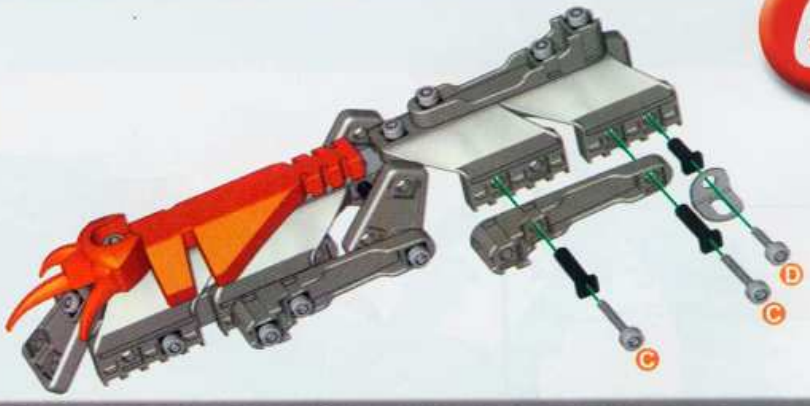

6

-  x1
-  x1
-  19 mm 3/4" x2
-  19 mm 3/4" x2
-  12,7 mm 1/2" x1
-  12,7 mm 1/2" x1





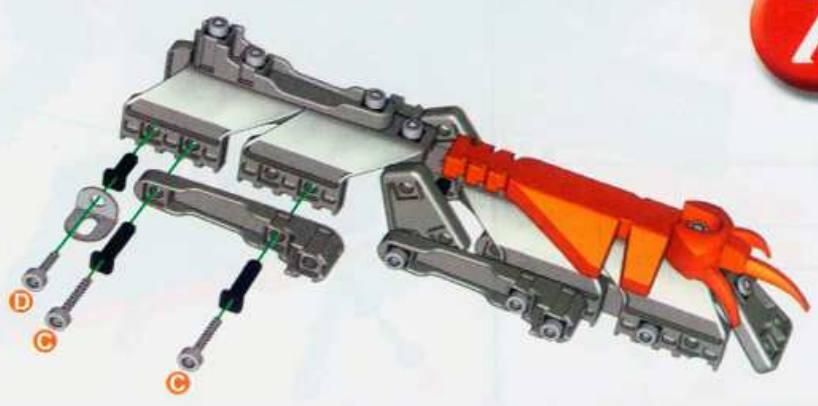

7

-  x1
-  x1
-  19 mm 3/4" x2
-  19 mm 3/4" x2
-  12,7 mm 1/2" x1
-  12,7 mm 1/2" x1



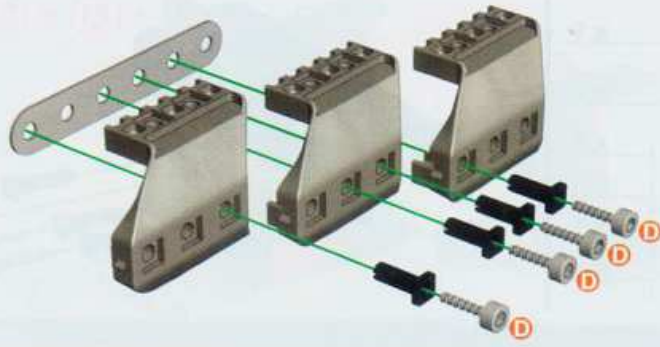

8

-  x2
-  x6
-  | 12,7 mm | x8
-  | 12,7 mm | x8



x2





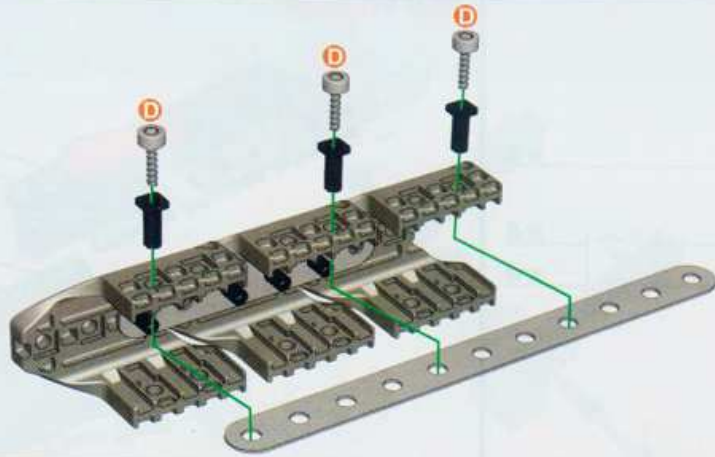

9

-  x1
-  | 12,7 mm | x3
-  | 12,7 mm | x3

8 +





10

-  x1
-  x1
-  | 19 mm | x3
-  | 19 mm | x3
-  | 12,7 mm | x1
-  | 12,7 mm | x1

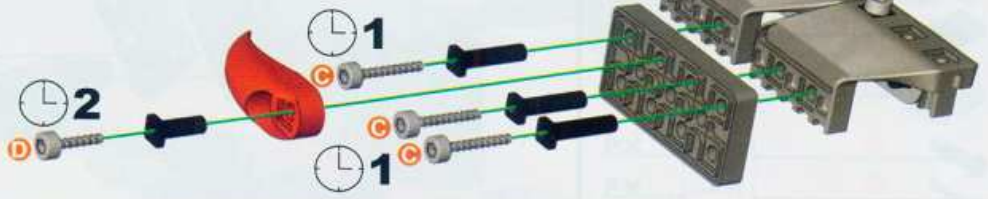
2







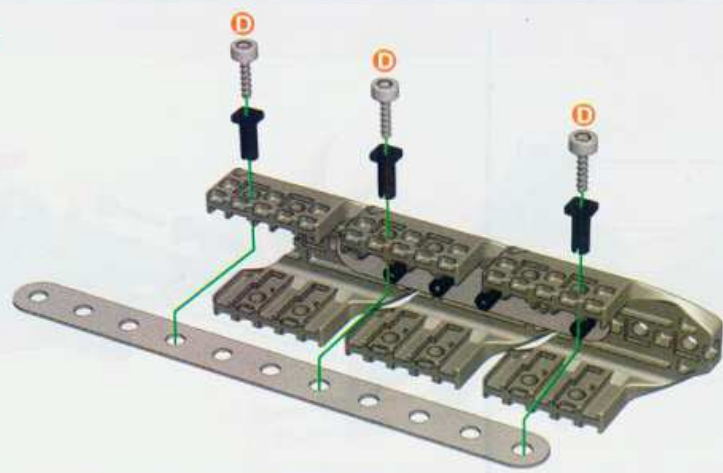

11

-  x1
-  | 12,7 mm | x3
-  | 12,7 mm | x3

8 +



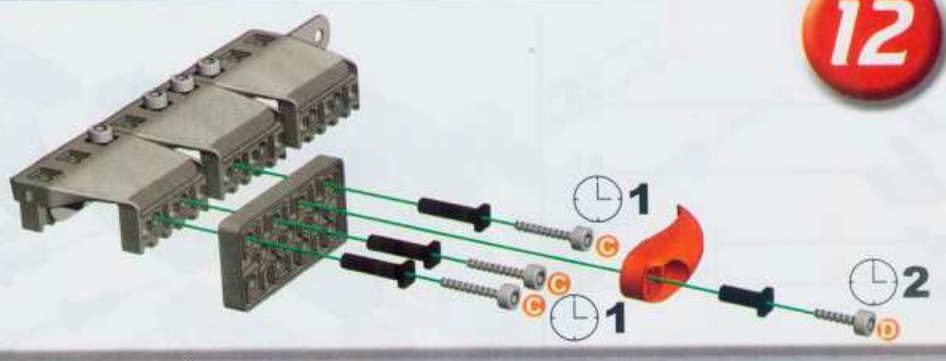

12

-  x1
-  x1
-  (C) | 19 mm | x3
-  (C) | 19 mm | x3
-  (D) | 12.7 mm | x1
-  (D) | 12.7 mm | x1



13

10 + 12 +

-  x1
-  (C) | 19 mm | x4
-  (C) | 19 mm | x4

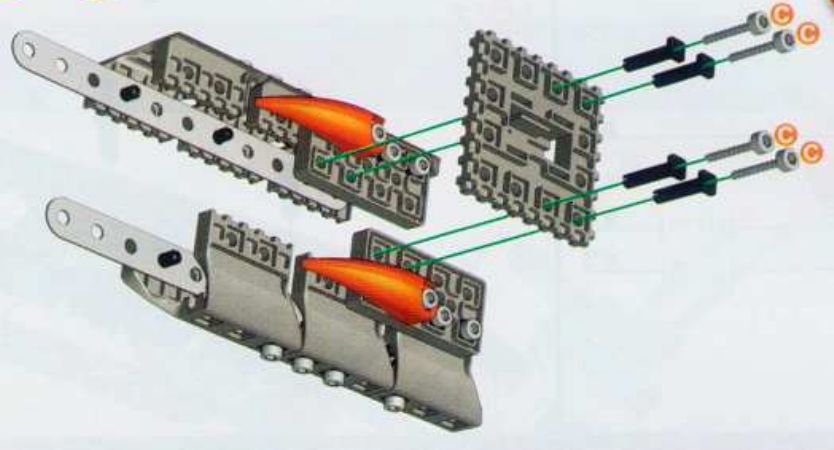



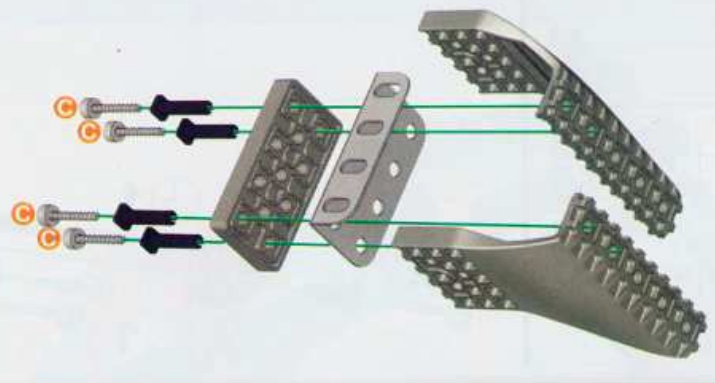

14

-  x1
-  x1
-  x1
-  x1
-  (C) | 19 mm | x4
-  (C) | 19 mm | x4



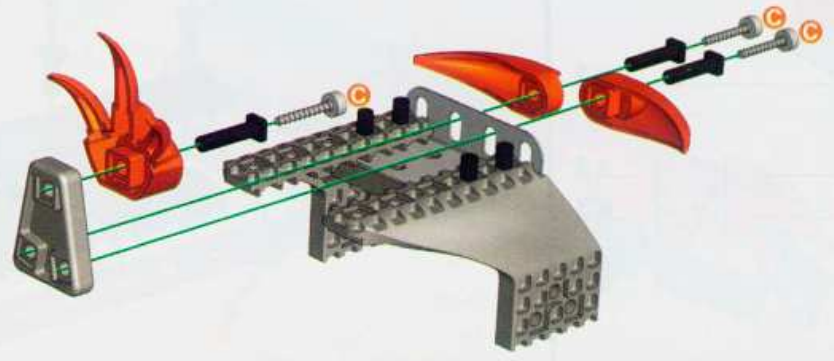

15

-  x1
-  x2
-  x1
-  (C) | 19 mm | x3
-  (C) | 19 mm | x3







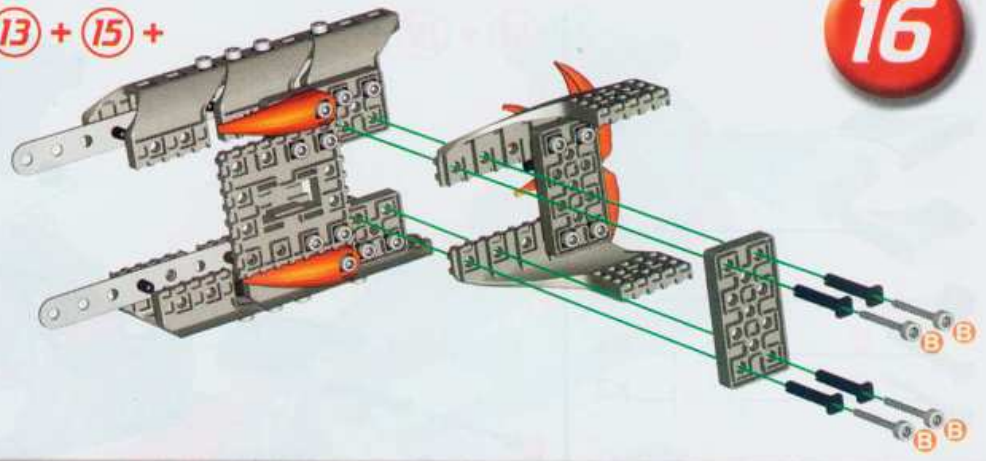

16

13 + 15 +

-  x1
-  B x4
-  B x4



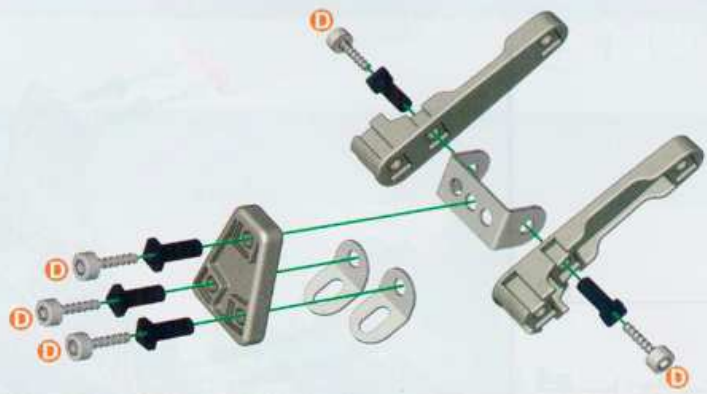

17

-  x2
-  x1
-  x1
-  x2
-  D x5
-  D x5









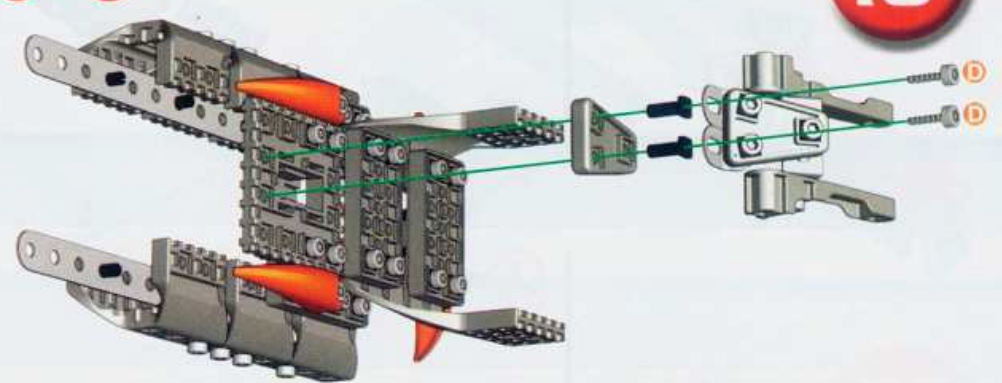

18

16 + 17 +





-  x1
-  D x2
-  D x2

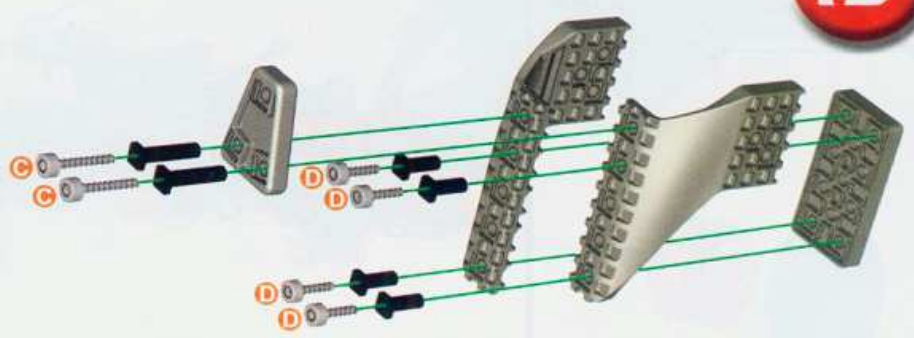

19

-  x1
-  x1
-  x1
-  x1
-  C x2
-  C x2
-  D x4
-  D x4



-  x1
-  x1
-  x2
-  x2
-  x2

18 + 19 +

20



-  x2
-  x4
-  x4

21

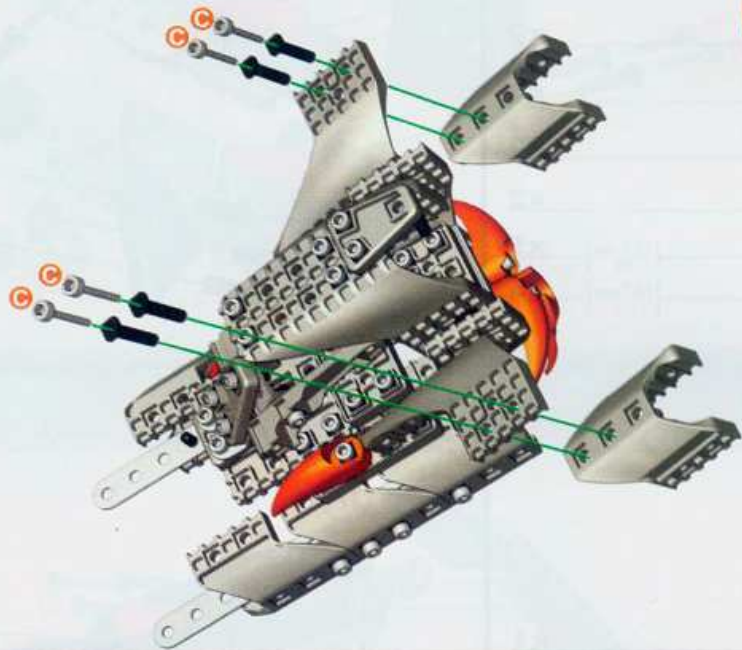







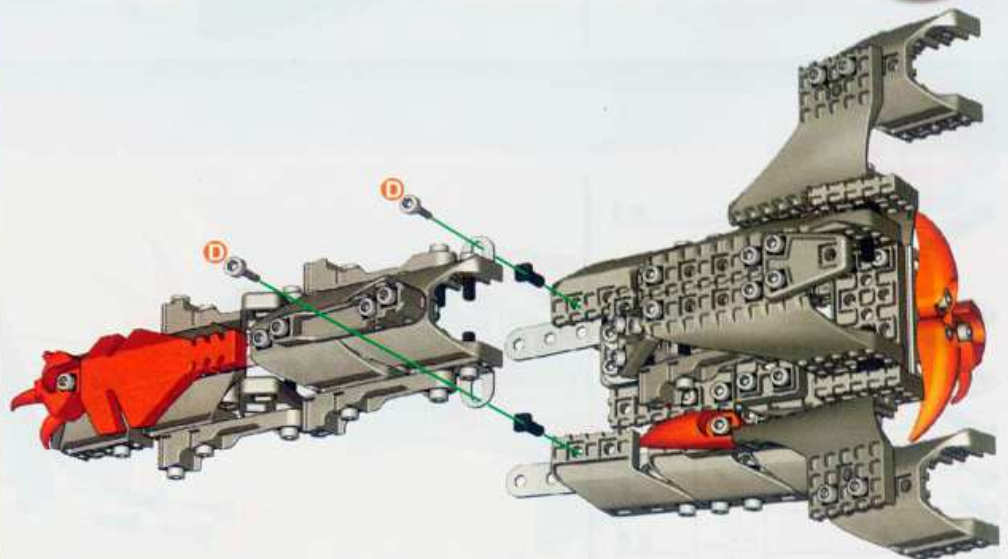

-  x2
-  x2

7 + 21 +

22



23

-  x1
-  x2
-  x1
-  (A) | 31.7 mm | x1
-  (A) | 31.7 mm | x1
-  (B) | 25.4 mm | x1
-  (B) | 25.4 mm | x1
-  (C) | 19 mm | x2
-  (C) | 19 mm | x2





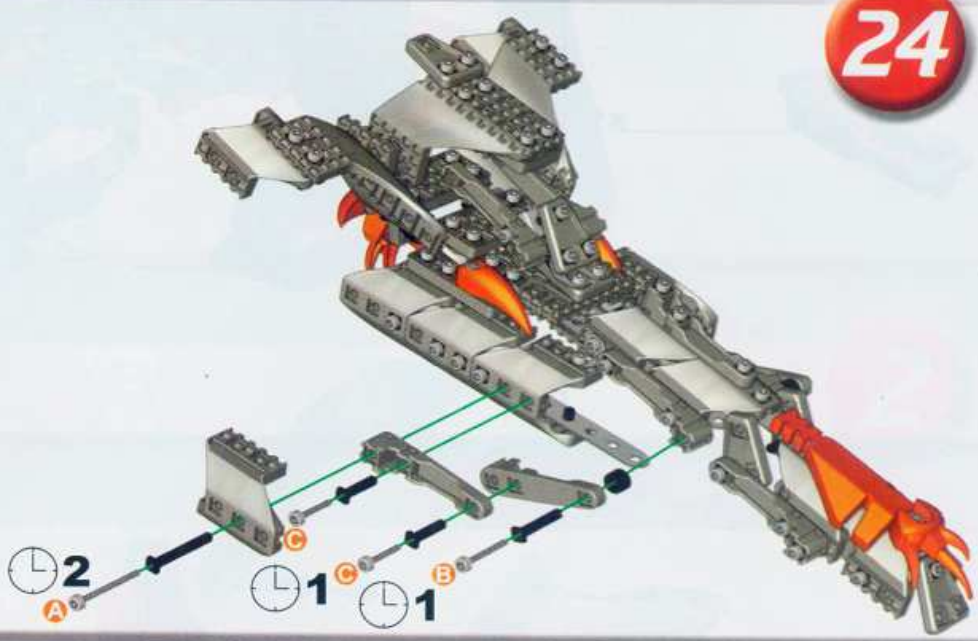

24

-  x1
-  x2
-  x1
-  (A) | 31.7 mm | x1
-  (A) | 31.7 mm | x1
-  (B) | 25.4 mm | x1
-  (B) | 25.4 mm | x1
-  (C) | 19 mm | x2
-  (C) | 19 mm | x2



25

-  | 90 mm | x1
-  x2
-  x2
-  x2
-  x2
-  x2



26

-  90 mm $3 \frac{1}{2}$ " x1
-  60 mm $2 \frac{1}{2}$ " x1
-  x2
-  x2
-  x1
-  x1
-  x2
-  x2
-  x4

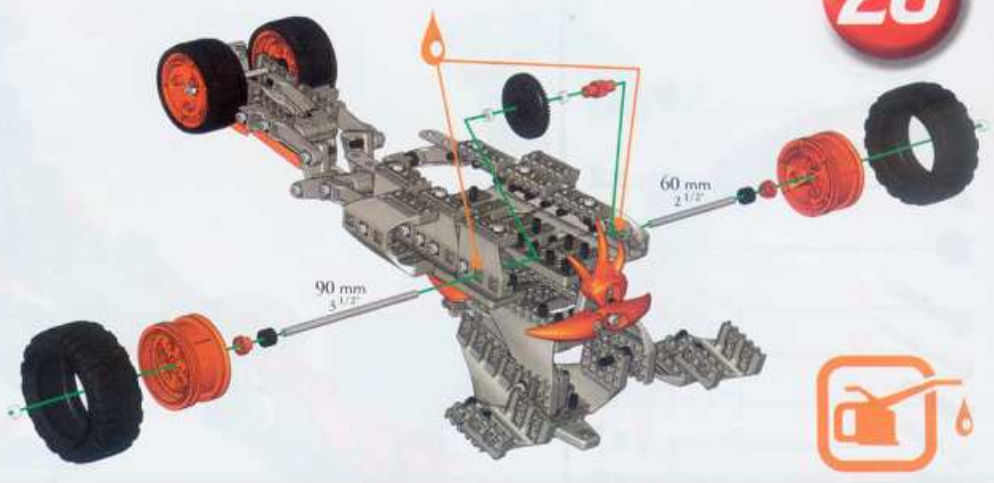

27

-  x1

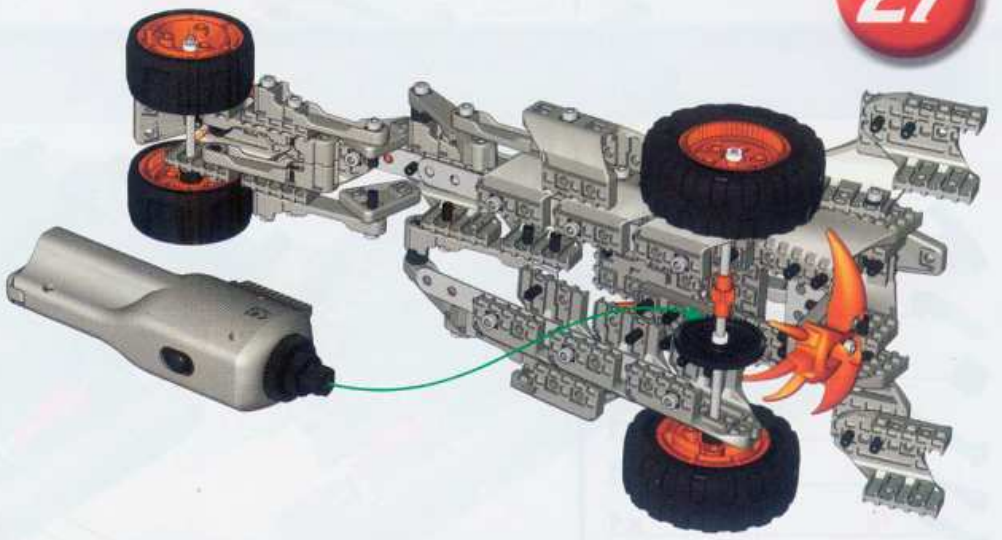





28







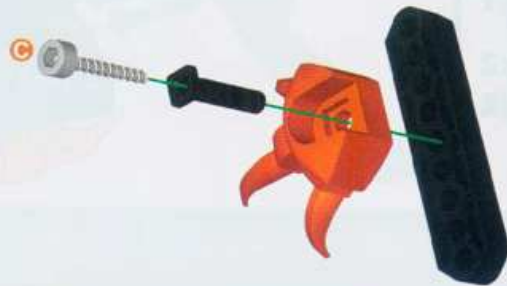

1

-  **x1**
-  **x1**
-  | 19 mm | **x1**
5/4"
-  | 19 mm | **x1**
5/4"



-  **x1**
-  **x1**
-  | 12,7 mm | **x2**
1/2"
-  | 12,7 mm | **x2**
1/2"

2

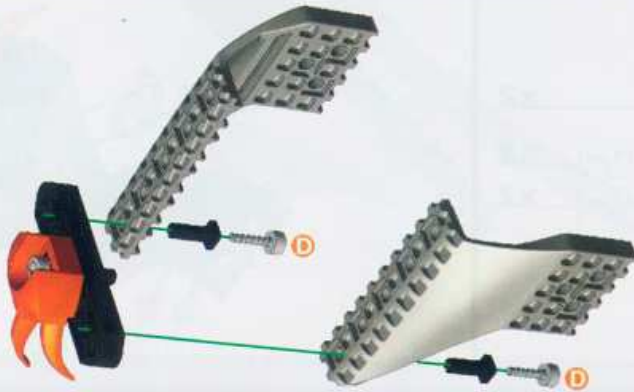

-  **x1**
-  | 19 mm | **x4**
5/4"
-  | 19 mm | **x4**
5/4"

3

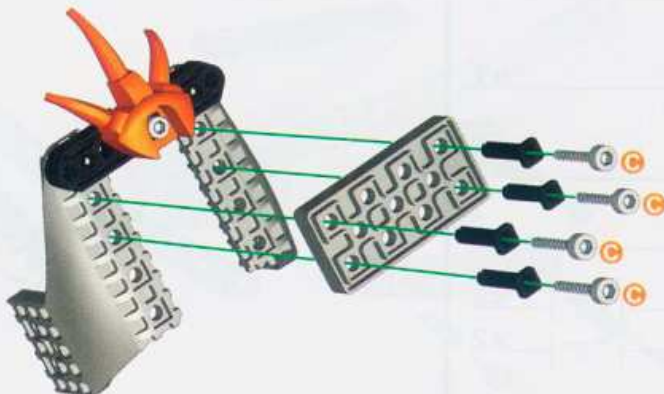

4

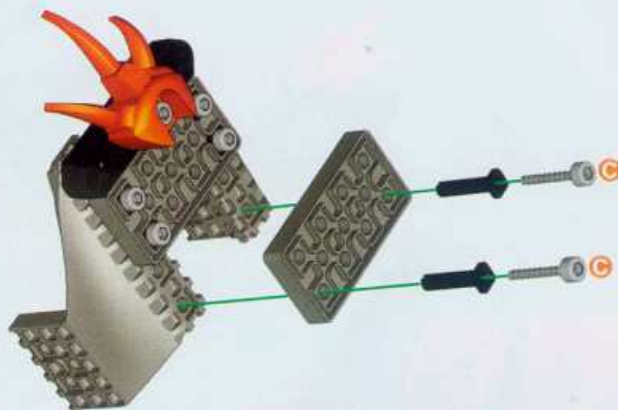

5

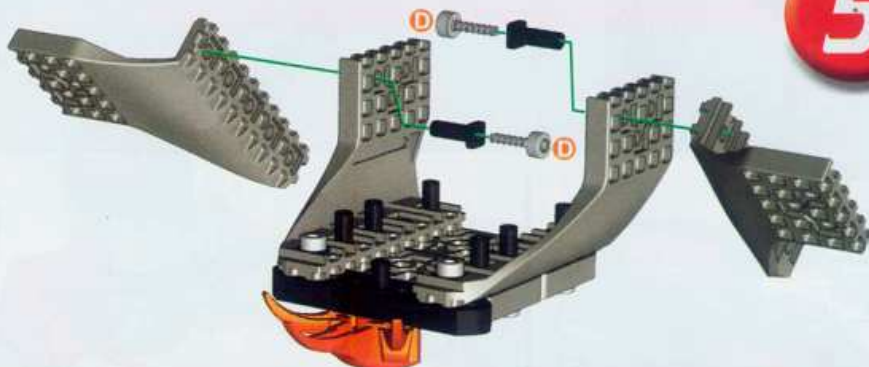
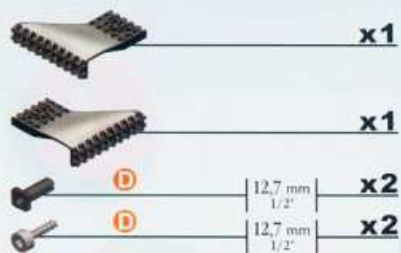

6

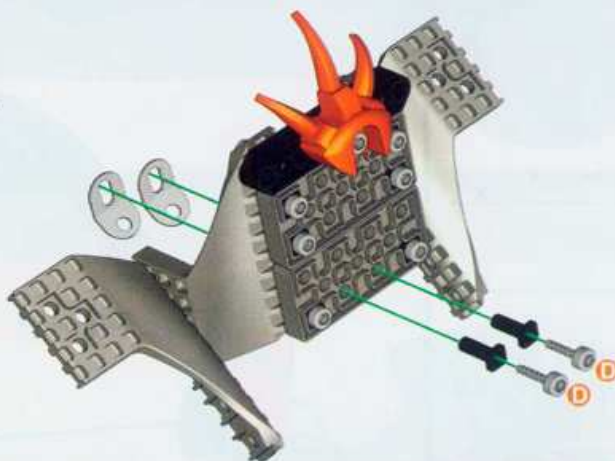

7

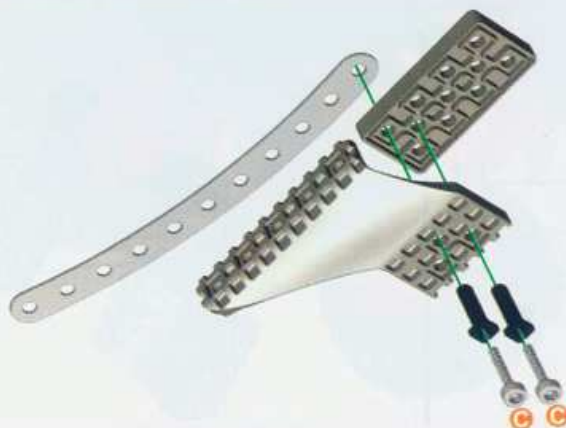
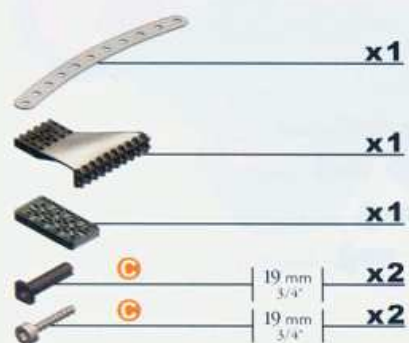



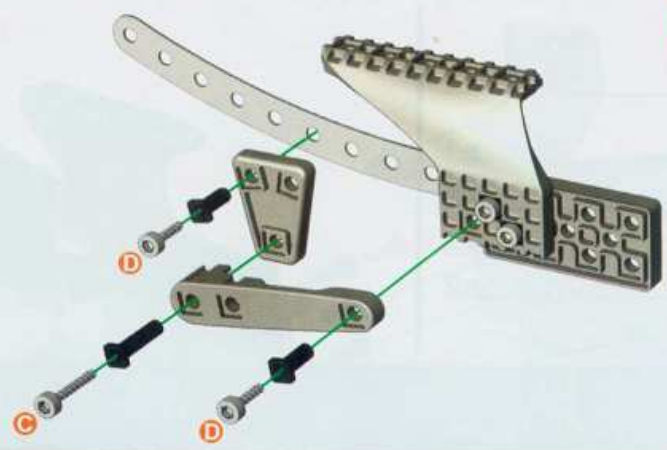

8

-  x1
-  x1
-  (C) | 19 mm 5/4" | x1
-  (C) | 19 mm 5/4" | x1
-  (D) | 12,7 mm 1/2" | x2
-  (D) | 12,7 mm 1/2" | x2





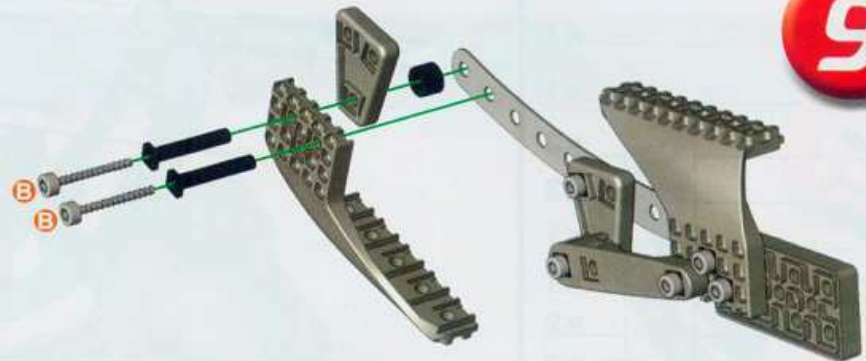

9

-  x1
-  x1
-  x1
-  (B) | 25,4 mm 1" | x2
-  (B) | 25,4 mm 1" | x2



10

-  x1
-  x1
-  x1
-  (C) | 19 mm 5/4" | x2
-  (C) | 19 mm 5/4" | x2

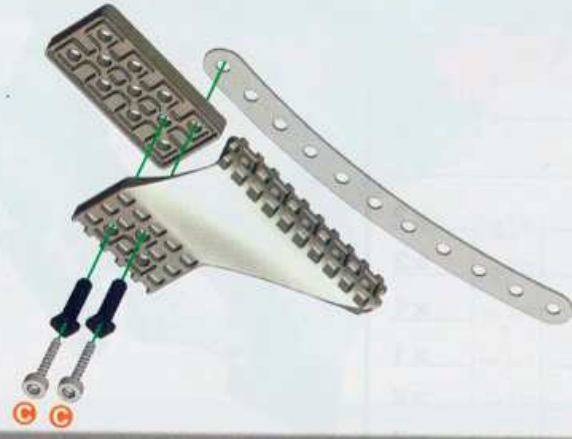



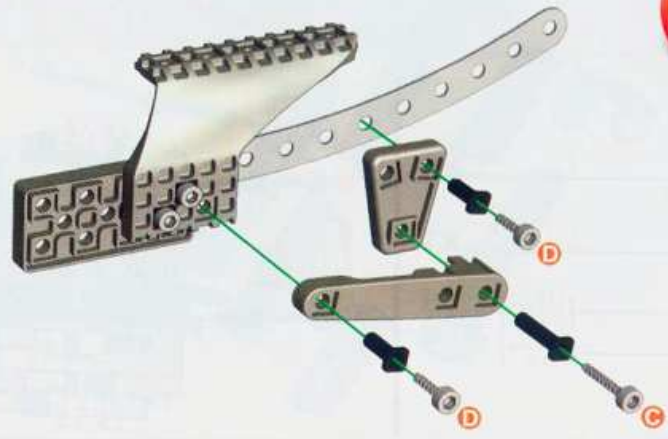

11

-  x1
-  x1
-  (C) | 19 mm 5/4" | x1
-  (C) | 19 mm 5/4" | x1
-  (D) | 12,7 mm 1/2" | x2
-  (D) | 12,7 mm 1/2" | x2



12

-  x1
-  x1
-  x1
-  (B) | 25,4 mm | x2
-  (B) | 25,4 mm | x2

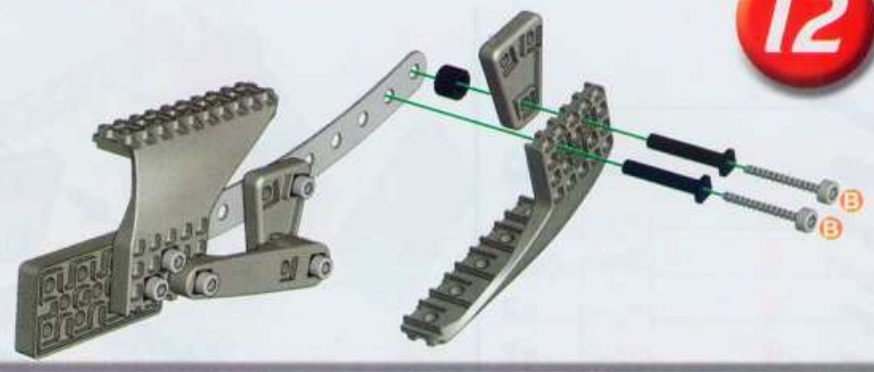

13

-  x2
-  x1
-  x1
-  (A) | 31,7 mm | x2
-  (A) | 31,7 mm | x2
-  (B) | 25,4 mm | x1
-  (B) | 25,4 mm | x1
-  (D) | 12,7 mm | x2
-  (D) | 12,7 mm | x2

(9) +

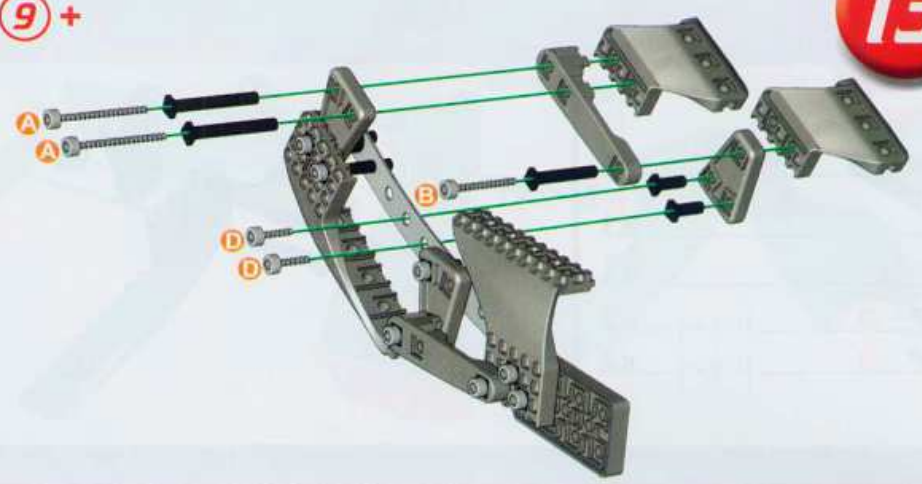



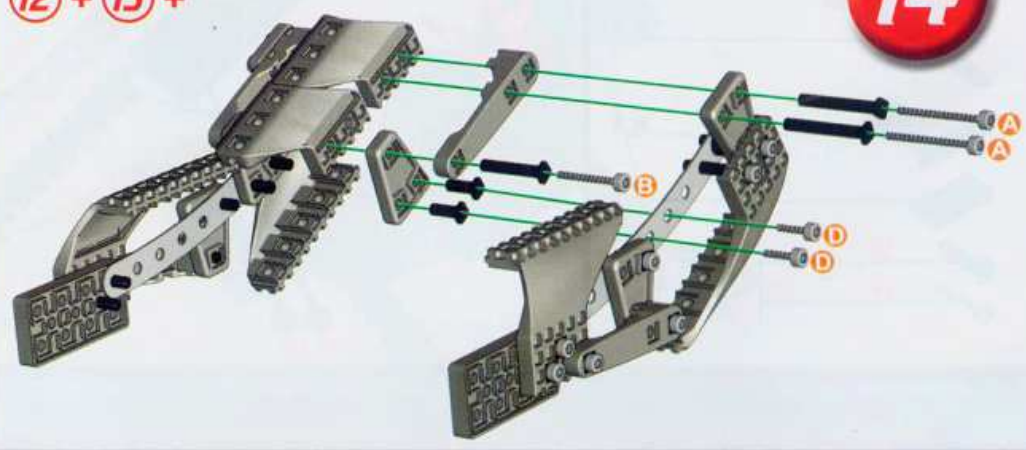

14

-  x1
-  x1
-  (A) | 31,7 mm | x2
-  (A) | 31,7 mm | x2
-  (B) | 25,4 mm | x1
-  (B) | 25,4 mm | x1
-  (D) | 12,7 mm | x2
-  (D) | 12,7 mm | x2

(12) + (13) +



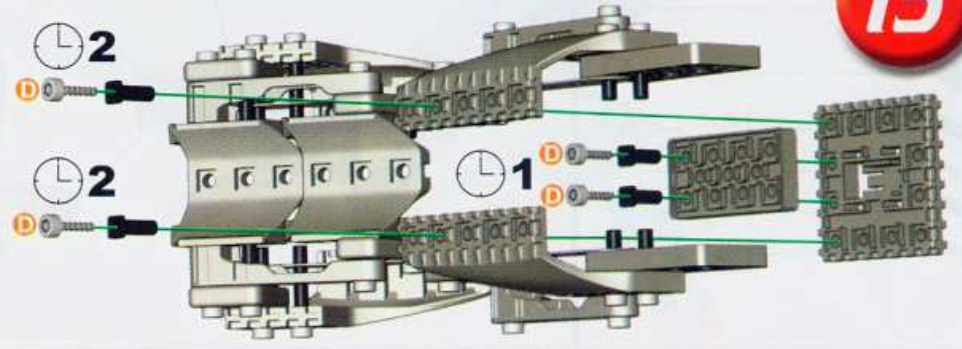

15

-  x1
-  x1
-  (D) | 12,7 mm | x4
-  (D) | 12,7 mm | x4



16

6 + 15 +

-  **D** | 12,7 mm | **x4**
1/2"
-  **D** | 12,7 mm | **x4**
1/2"

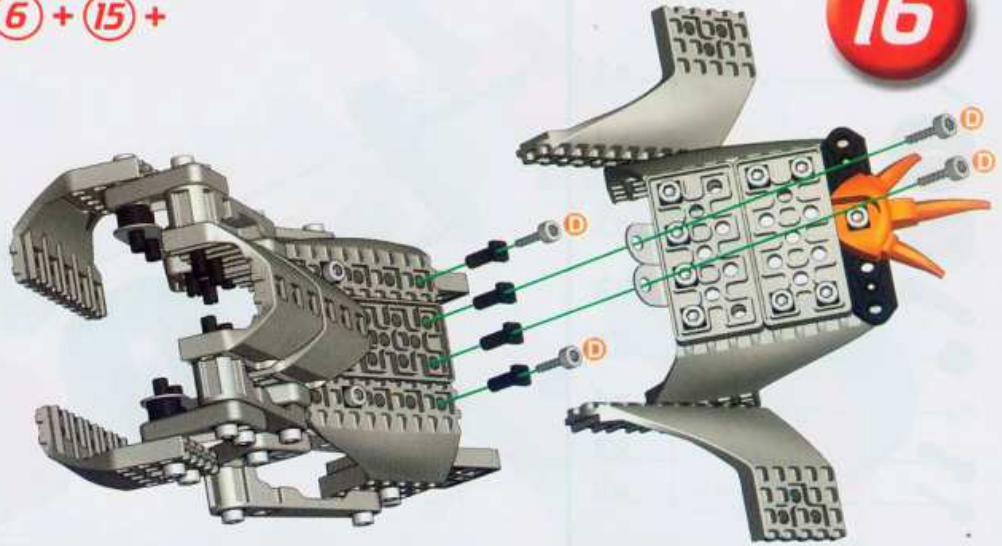



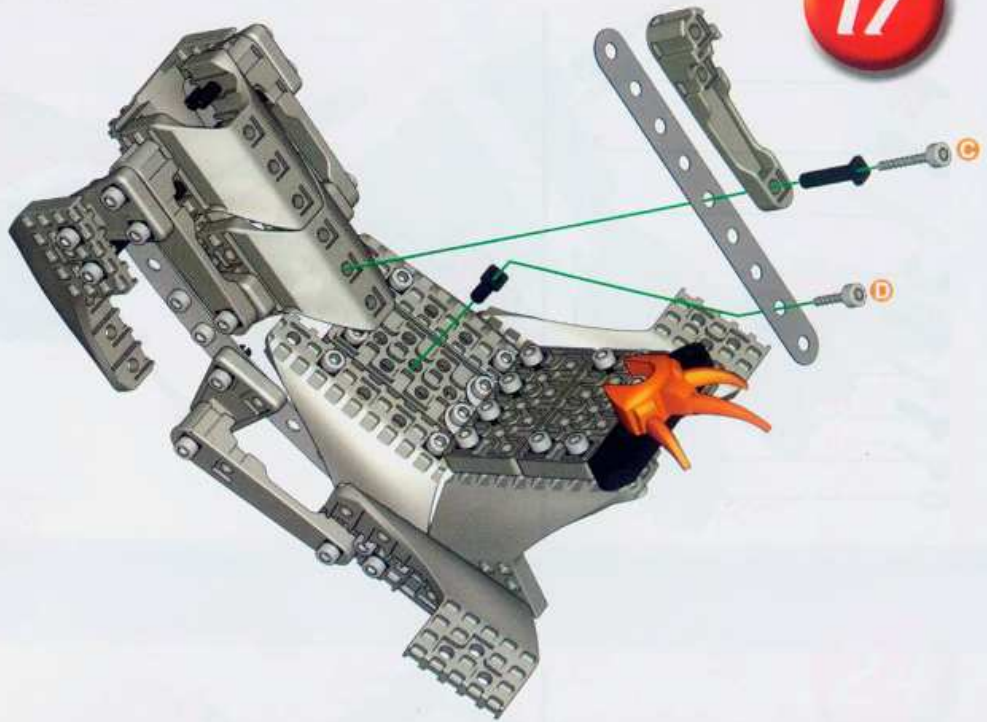

17

-   **x1**
-  **C** | **x1**
-  **C** | 19 mm | **x1**
3/4"
-  **C** | 19 mm | **x1**
3/4"
-  **D** | 12,7 mm | **x1**
1/2"
-  **D** | 12,7 mm | **x1**
1/2"



18

-  **B** | **x2**
-  **B** | **x2**
-  **B** | **x1**
-  **B** | 25,4 mm | **x3**
1"
-  **B** | 25,4 mm | **x3**
1"
-  **D** | 12,7 mm | **x1**
1/2"
-  **D** | 12,7 mm | **x1**
1/2"

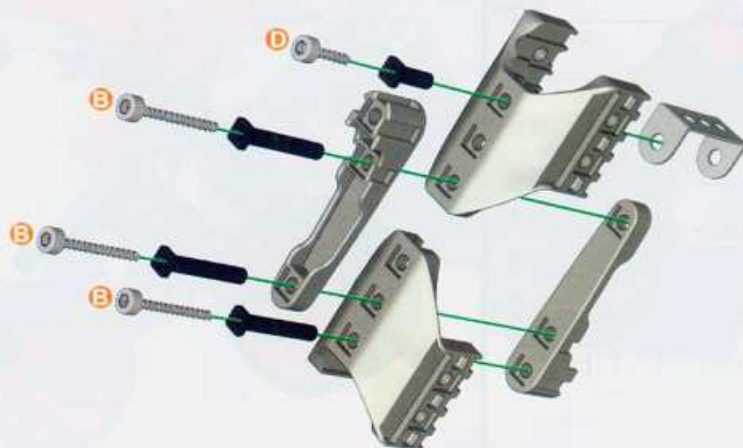

19

-  | 50 mm | **x1**
-  | **x1**
-  | **x1**
-  | **x2**
-  | **x2**
-  | **x4**
-  | 19 mm | **x2**
-  | 19 mm | **x2**

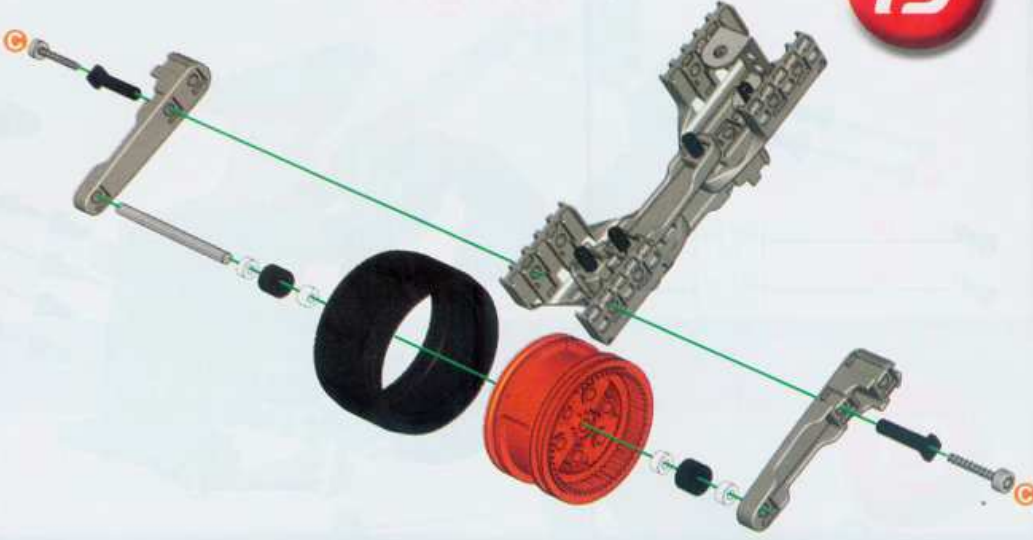

20

-  | **x1**
-  | **x1**
-  | **x1**
-  | **x1**
-  | 25,4 mm | **x1**
-  | 25,4 mm | **x1**
-  | 19 mm | **x1**
-  | 19 mm | **x1**
-  | **x1**

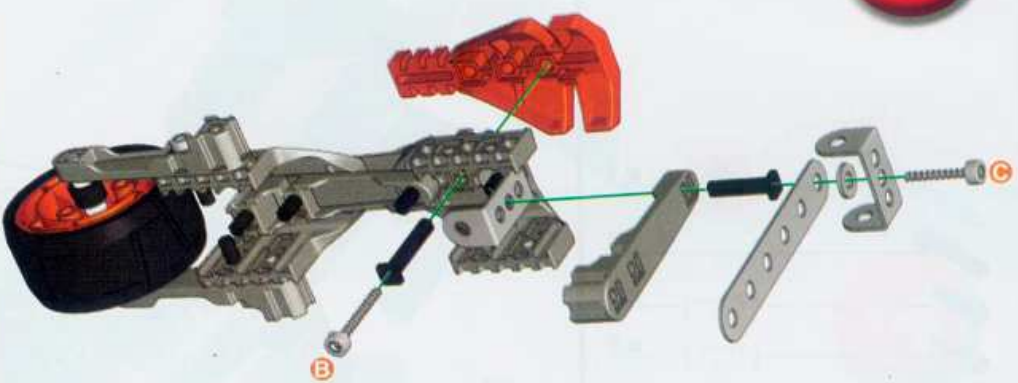

21

-  |  | **x1**
-  | **x1**
-  | **x1**
-  | 25,4 mm | **x2**
-  | 25,4 mm | **x2**
-  | 19 mm | **x1**
-  | 19 mm | **x1**
-  | 12,7 mm | **x1**
-  | 12,7 mm | **x1**





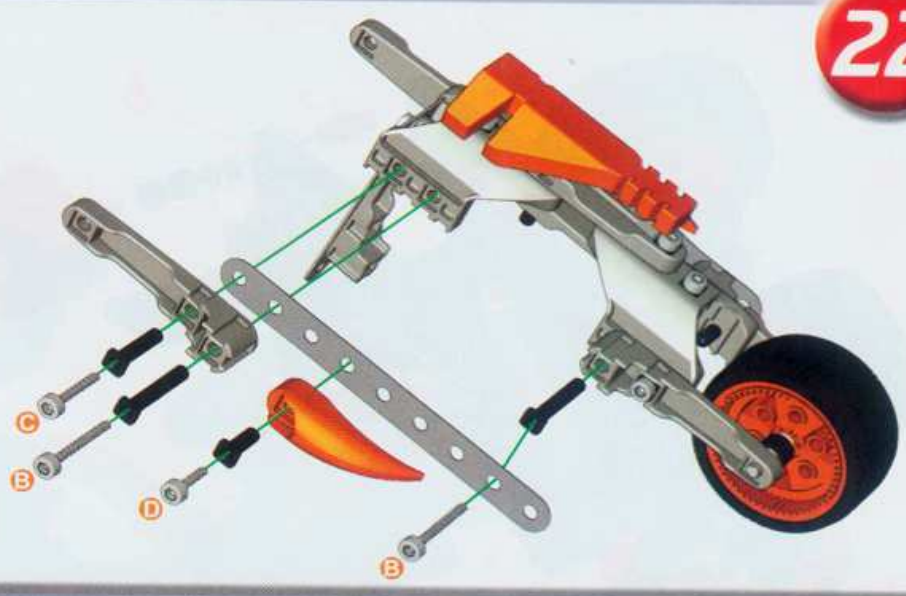



-   **x1**
-  **x1**
-  **x1**
-  **B** | 25,4 mm | **x2**
-  **B** | 25,4 mm | **x2**
-  **C** | 19 mm | **x1**
-  **C** | 19 mm | **x1**
-  **D** | 12,7 mm | **x1**
-  **D** | 12,7 mm | **x1**

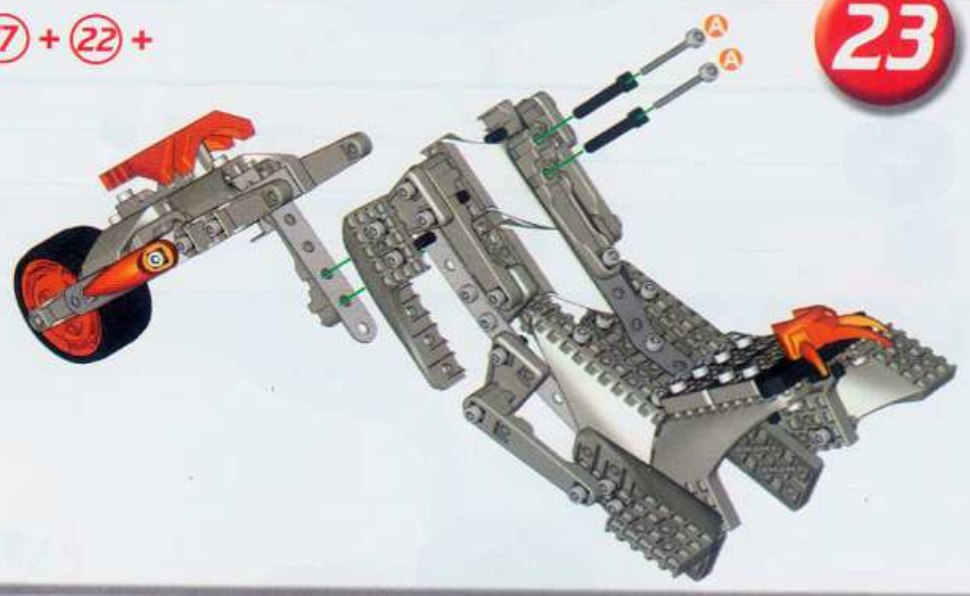

17 + 22 +









-  **A** | 31,7 mm | **x2**
-  **A** | 31,7 mm | **x2**



-  **x2**
-  **x2**
-  **A** | 31,7 mm | **x2**
-  **B** | 12,7 mm | **x2**
-  **B** | 12,7 mm | **x2**





- | | | | | | | |
|--|----|--|-----------------|----|--|----|
|  | x1 |  | 60 mm
2 1/2" | x1 |  | x2 |
|  | x1 |  | | x1 |  | x2 |
| | |  | | x1 |  | x2 |

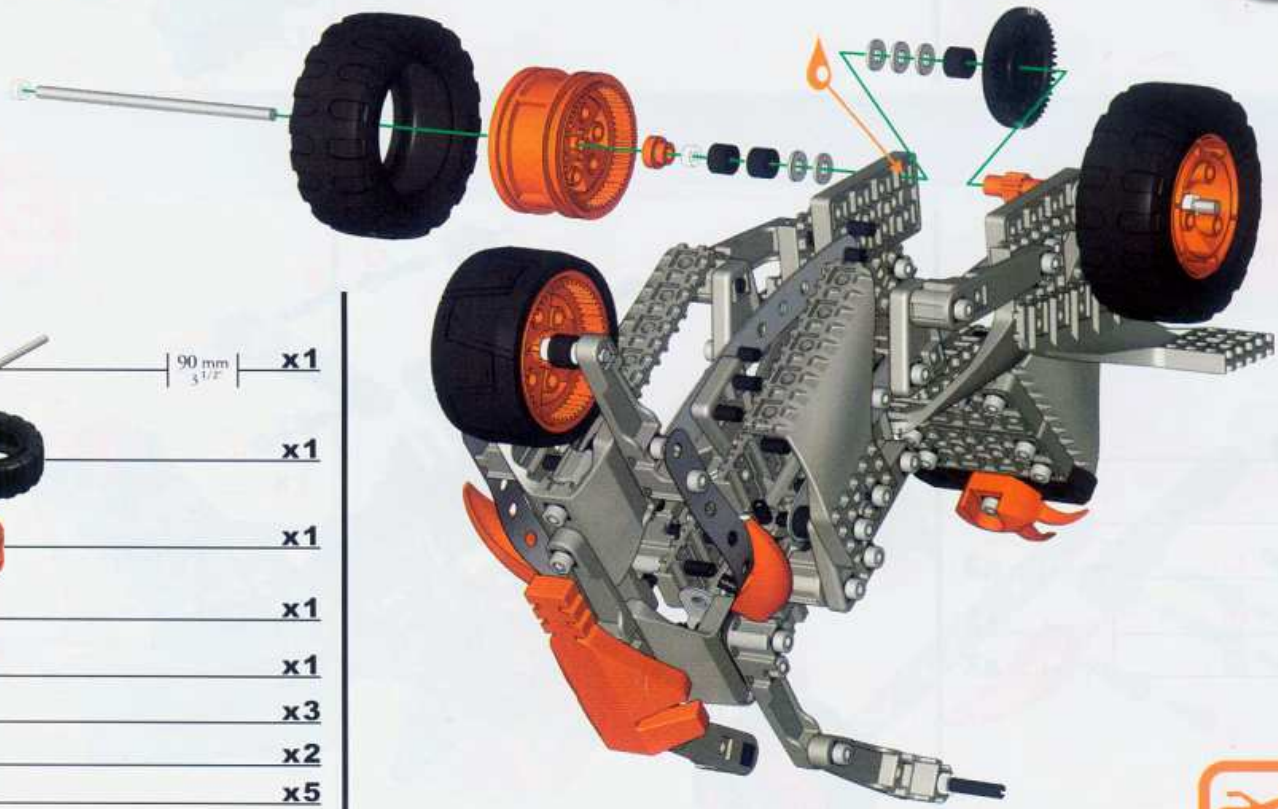

- | | | |
|---|-----------------|----|
|  | 90 mm
3 1/2" | x1 |
|  | | x1 |
|  | | x1 |
|  | | x1 |
|  | | x1 |
|  | | x3 |
|  | | x2 |
|  | | x5 |



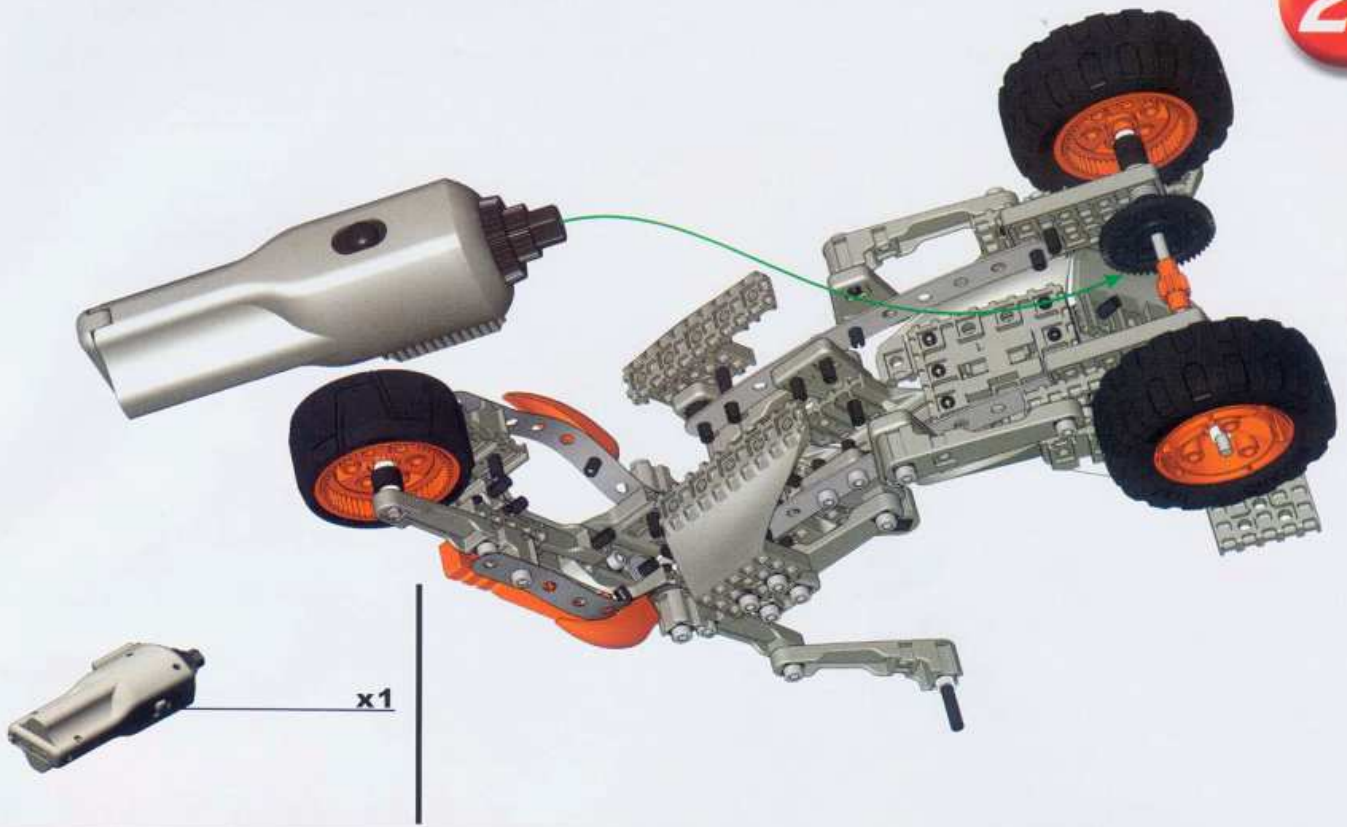

GB USA Many of the models and component parts are unique and original designs which are the property of MECCANO. They are protected by national legislation as industrial designs, trademarks and/or copyrights throughout many countries. For detailed information, please contact: MECCANO. Meccano shall have no responsibility for (I) failure to follow instructions, (II) use of parts for any purpose other than as specified in the instructions (III) any alteration of any parts or components. MECCANO respects children's safety: all models are tested by children.

F De nombreux modèles et pièces sont des créations originales, propriétés de MECCANO et sont protégés par les législations nationales sur les dessins et modèles, marques et/ou droits d'auteurs. Pour toute information, merci de contacter : MECCANO. La responsabilité de MECCANO ne saurait être engagée en cas d'accident survenu à la suite (I) du non respect des instructions de montage (II) d'une utilisation des pièces autre que celle proposée dans la notice (III) d'une altération ou de la modification des pièces. La société MECCANO respecte la sécurité des enfants : ses modèles sont testés par des enfants.

D Zahlreiche Modelle und Teile sind Erfindungen und Eigentum der Firma MECCANO. Sie sind durch Inland-Gesetze über Zeichnungen und Modelle sowie Warenzeichen und/oder Urheberrechte geschützt. Für zusätzliche Auskünfte wenden Sie sich bitte an : MECCANO. Die Firma Meccano haftet nicht für Unfälle, die aus der (I) Nichteinhaltung der Bauanleitung, der (II) Verwendung anderer als in der Bauanleitung angegebenen Teile oder der (III) Änderung oder Modifikation der Teile resultieren. Alle Modelle der Firma Meccano wurden von Kindern getestet und entsprechen den Sicherheitsnormen.

I Numerosi modelli e pezzi sono creazioni originali della MECCANO e sono protetti dalle legislazioni nazionali sui disegni e modelli, marchi e/o diritti d'autore. Per qualsiasi informazione, vogliate prendere contatto con : MECCANO. Meccano declina ogni responsabilità in caso d'incidenti sopravvenuti in seguito (I) a: non rispetto delle istruzioni di montaggio (II) utilizzo dei pezzi per funzioni diverse da quelle previste nel manuale (III) alterazione e/o modifica dei pezzi. La società MECCANO rispetta la sicurezza dei bambini : i suoi modelli vengono testati dai bambini stessi.

E Numerosos modelos y piezas son creaciones originales, propiedades de MECCANO y están protegidos por las legislaciones nacionales en lo que concierne a los dibujos y modelos, marcas y/o derechos de autor. Para cualquier información, sírvase ponerse en contacto con : MECCANO. MECCANO carece de responsabilidad en caso de accidente debido a: (I) el incumplimiento de las instrucciones de montaje (II) una utilización de las piezas diferente a la que se indica en las instrucciones (III) una alteración o modificación de las piezas. La sociedad MECCANO respeta la seguridad de los niños : sus modelos están probados por niños.

P Vários modelos e peças são criações originais, propriedades da MECCANO e são protegidos pelas legislações nacionais relativas aos desenhos e modelos, às marcas e/ou aos direitos de autor. Para qualquer informação, é favor contactar : MECCANO. A Sociedade MECCANO não poderá ser responsabilizada pelos acidentes provocados: (I) pela falta de cumprimento das instruções de montagem (II) pelo uso indevido das peças ou (III) pela modificação ou alteração das peças. A Sociedade MECCANO respeita a segurança das crianças : os seus modelos foram testados por crianças.

S Många modeller och delar bildar en unik och originell formgivning vilken är MECCANO egendom. Dessa modeller och delar är skyddade genom lagstiftning såsom industriell formgivning, varumärke och/eller upphovsmannarätt i ett flertal länder. För mer detaljerad information, var vänlig kontakta MECCANO. MECCANO fräntar sig allt ansvar i händelse av olycka till följd av (I) att monteringsinstruktionerna inte har respekterats (II) en annan användning av delarna än den som står i anvisningen (III) en förvänsning eller förändring av delarna. Företaget MECCANO respekterar barnsäkerheten : modellerna har testats av barn.

GB USA Standard batteries must not be recharged. Rechargeable batteries must be removed from the toy before being recharged (if it is possible to remove them). Rechargeable batteries must only be recharged under adult supervision (if it is possible to remove them). Do not mix different types of batteries together or new with old rechargeable / non rechargeable batteries. Only batteries of the recommended type or a similar type should be used. Batteries must be fitted in accordance with their instructions. Remove used batteries from the toy. Battery terminals must not be short-circuited. Please keep instructions.

F Les piles ne doivent pas être rechargées. Les accumulateurs doivent être enlevés du jouet avant d'être chargés (s'ils peuvent être enlevés). Différents types de piles ou accumulateurs ou des piles ou accumulateurs neufs et usagés ne doivent pas être mélangés. Seuls des piles ou accumulateurs du type recommandé ou d'un type similaire doivent être utilisés. Les piles et accumulateurs doivent être mis en place en respectant la polarité. Les piles et accumulateurs usagés doivent être enlevés du jouet. Les bornes d'une pile ou d'un accumulateur ne doivent pas être mises en court-circuit. Indications à conserver.

D Die Batterien dürfen nicht wieder aufgeladen werden. Die Akkus müssen vor dem Nachladen aus dem Spielzeug genommen werden (wenn sie ausgebaut werden können). Die Akkus dürfen nur unter Aufsicht eines Erwachsenen nachgeladen werden (wenn sie ausgebaut werden können). Unterschiedliche Arten von Batterien und Akkus oder neue und gebrauchte Batterien bzw. Akkus dürfen nicht zusammen verwendet werden. Es dürfen nur Batterien bzw. Akkus der empfohlenen Art oder einer ähnlichen Art verwendet werden. Beim Einsetzen der Batterien bzw. Akkus auf die richtige Polung achten. Verbrauchte Batterien bzw. Akkus bitte aus dem Spielzeug entfernen. Die Klemmen der Batterien bzw. Akkus dürfen nicht kurzgeschlossen werden. Diese Anweisungen bitte aufbewahren.

I Le pile non devono essere ricaricate. Gli accumulatori devono essere tolti dal giocattolo prima di essere caricati (se è possibile toglierli). Gli accumulatori devono essere caricati solo sotto la sorveglianza di un adulto (se è possibile toglierli). Non possono essere mescolati tipi diversi di pile o di accumulatori oppure pile o accumulatori nuovi e usati. Si devono usare solo pile o accumulatori del tipo raccomandato o di un tipo simile. Le pile e gli accumulatori devono venire sistemati rispettando la polarità. Le pile e gli accumulatori usati devono essere tolti dal giocattolo. I morsetti di una pila o di un accumulatore non devono essere messi in cortocircuito. Conservare queste istruzioni.

E Las pilas no deberán recargarse. Habrá que retirar los acumuladores del juguete antes de proceder a recargarlos (si es que pueden retirarse). Los acumuladores sólo se recargarán bajo la vigilancia de una persona adulta (si es que pueden retirarse). No deberán mezclarse diferentes tipos de pilas o acumuladores o de pilas o acumuladores nuevos y usados. Sólo se utilizarán pilas o acumuladores del tipo recomendado o de un tipo similar. Las pilas y acumuladores deberán colocarse respetando la polaridad. Deberán retirarse del juguete las pilas y acumuladores usados. Lors bornes de una pila o de un acumulador no deberán disponerse nunca en posición de cortocircuito. Conserve estas indicaciones.

P As pilhas não devem ser novamente carregadas. Os acumuladores devem ser removidos do brinquedo antes de serem carregados (caso possam ser removidos). Os acumuladores devem ser carregados apenas sob cuidados de um adulto (caso possam ser removidos). Diferentes tipos de pilhas ou acumuladores ou pilhas ou acumuladores novos já utilizados não devem ser misturados. Pilhas ou acumuladores do tipo recomendado ou de um tipo similar poderão ser utilizados. As pilhas e acumuladores devem ser inseridos, respeitando a polaridade. Devem ser removidos do brinquedo as pilhas e acumuladores já utilizados. Os polos de uma pilha ou de um acumulador não devem ser curto-circuitados. Indicações a conservar.

FIN Useat mallit ja osat ovat MECCANO: n omaisuutta olevaa alkuperäistä suunnittelua. Ne ovat kansallisia laillia suojattua teollista tuotantoa, tavaramerkkejä ja/tai kopiointioikeuksia. Pyydämme ottamaan yhteyden MECCANO: han kaikissa asioissa liittyvissä kysymyksissä. MECCANO ei vastaa eikä kots seuraavista syistä sattuneita onnettomuuksia: (I) ohjeiden vastainen kokoonpano, (II) muiden kuin ohjeissa ehdotettujen osien käyttö, (III) osien muuttelu tai ei tarkoitukseen käyttö. MECCANO-yhtiö huolehtii lasten turvallisuudesta: lapset ovat testanneet mallimme.

DK Vore mange modeller og dele er originale fremstillinger og ejes af MECCANO. Tagninger, modeller, fabriktionsmærker og ophavsret er lovbeskyttede i hvert land. Yderligere oplysninger kan fås hos: MECCANO. MECCANO frasiger sig ethvert ansvar, såfremt der er sket uheld forårsaget af (I) at monteringsinstruktionerne ikke er blevet overholdt (II) at delene er blevet brugt til andre formål, end dem der er beskrevet i betjeningsvejledningen, (III) eller at delene er blevet beskadiget eller ændret, MECCANO overholder sikkerhedsreglerne for børn: Alle modeller testes af børn.

NL Veel modellen en onderdelen zijn originele ontwerpen en eigendom van MECCANO en worden beschermd door de nationale wetgeving op tekeningen en modellen, merken en/of auteursrechten. Voor informatie gelieve contact op te nemen met MECCANO. De verantwoordelijkheid van MECCANO is uitgesloten in geval van ongevallen voortvloeiend uit het niet naleven van de montage-instructies (I), uit het gebruik van andere onderdelen dan die zoals vermeld in de handleiding (II) of uit het veranderen of modificeren van de onderdelen (III). De firma MECCANO neemt de veiligheid van de kinderen in acht : de modellen zijn door kinderen getest.

GR Πολλά μοντέλα και ανταλλακτικά είναι αυθεντικά, ιδιοκτησία της MECCANO και προστατεύονται από τις εθνικές νομοθεσίες για τα μοντέλα τις μάρκες, η τα διπλώματα ευρεσιτεχνίας. Για κάθε πληροφορία παρακαλώ απευθυνθείτε στη MECCANO. Η ευθύνη της MECCANO δεν δεσμεύεται σε περίπτωση ατυχήματος που έγινε συνέχεια (I) μη σεβασμού των οδηγιών συναρμολόγησης (II) χρήσης των τεμαχίων διαφορετική από αυτήν που προτείνεται στις οδηγίες (III) καταστροφή ή αλλαγή των τεμαχίων. Η εταιρεία MECCANO σεβεται την ασφάλεια των παιδιών: τα μοντέλα της δοκιμάζονται από παιδιά.

JPN モデルならびに部品は、その多くが MECCANO 社所有のオリジナル・デザインで、意匠・商標および/または著作権に関する国内法によって保護されています。詳細については、当社 (MECCANO) メカノ社は (I) 組立の注意事項を守らなかった場合、(II) 使用説明書に記されたもの以外の部品を使用した場合、(III) 部品を改変・改造した場合などに起きた事故については責任を負うことはできません。メカノ社の全モデルは事前に子供たちによりテストを行い、その安全性を確認されています。

S Batterierna skall inte laddas om. Akkumulatorbatterierna skall tas av från leksaken innan de laddas (om de kan tas av). Akkumulatorbatterierna skall endast laddas under uppsikt av en vuxen (om de kan tas av). Olika typer av batterier eller akkumulatorbatterier skall inte blandas. Nya och använda batterier eller akkumulatorbatterier skall inte blandas. Använd endast rekommenderade typer eller likartade typer av batterier eller akkumulatorbatterier. Batterierna, akkumulatorbatterierna skall sättas i med hänsyn till polerna. Använda batterier och akkumulatorbatterier skall tas av leksaken. Kontakterna på ett batteri eller ett akkumulatorbatteri skall inte kortslutas. Bevaka anvisningarna.

FIN Paristoja ei saa ladata uudelleen. Akut on otettava ulos leikkikalusta ennen lataamista (jos se on mahdollista). Akut saa ladata vain aikuisen valvonnassa (jos ne voidaan ottaa ulos). Erityyppisiä paristoja tai akkuja ei saa käyttää yhdessä, samoin ei saa sekoittaa akkuja ja uusia ja vanhoja paristoja. Vain suositeltuja akku- tai paristotyyppejä saa käyttää. Käytä vain suositeltuja paristoja tai akkuja. Paristoja ja akkuja on asetettava paikalleen niin, että navat tulevat oikeisiin suuntiin. Loppuunkäytetyt paristot tai akut on otettava leikkikalusta ulos. Akun tai pariston napoja ei saa oikosulkea. Ohjeet pidetäviä tallessa.

DK Batterierne må ikke oplades. Akkumulatorbatterier skal tages ud af legetøjet, inden de lades op (hvis de kan tages ud). Akkumulatorbatterierne må kun lades op under opsyn af en voksen (hvis de kan tages ud). Forskellige typer batterier og akkumulatorbatterier, eller nye og brugte batterier, må ikke blandes sammen. Der må kun anvendes batterier eller akkumulatorbatterier af den type der er anbefalet eller tilsvarende modeller. Batterier og akkumulatorbatterier vendes rigtigt (+/- poler). Brugte batterier og akkumulatorbatterier skal tages ud af legetøjet. Klemmerne på et batteri eller et akkumulatorbatteri må ikke kortsluttes. Disse instruktioner bør opbevares.

NL De batterijen mogen niet weer opgeladen worden. De accu's moeten voor het laden uit het speelgoed verwijderd worden (indien ze verwijderd kunnen worden). Gebruik geen verschillende typen batterijen of accu's of gebruikte nieuwe batterijen of accu's door elkaar. Gebruik alleen batterijen of accu's van het aanbevolen type of van een gelijkwaardig type. Let bij het plaatsen van de batterijen en accu's goed op de juiste polariteit. De verbruikte batterijen en accu's die uit het speelgoed verwijderd te worden. De aansluitingen van een batterij of van een accu mogen niet kortgesloten worden. Aanwijzingen om te bewaren.

GR Οι μπαταρίες δεν πρέπει να επαναφορτίζονται. Οι συσσωρευτές πρέπει να αφαιρούνται από το παιχνίδι πριν τη φόρτιση (εάν μπορούν να αφαιρεθούν). Οι συσσωρευτές πρέπει να φορτίζονται μόνον υπό την επίβλεψη ενήλικα (εάν μπορούν να αφαιρεθούν). Δεν πρέπει να ανακατεύονται διαφορεικοί τύποι μπαταριών ή συσσωρευτών ή μπαταριών ή συσσωρευτών καινούριων και παλιών. Πρέπει να χρησιμοποιούνται με μπαταρίες ή συσσωρευτές του συνιστώμενου τύπου ή παρόμοιου τύπου. Οι μπαταρίες και οι συσσωρευτές πρέπει να τοποθετούνται σύμφωνα με τη σωστή πόλωση. Οι παλιές μπαταρίες και οι παλιοί συσσωρευτές πρέπει να αφαιρούνται από το παιχνίδι. Οι πόλοι μιας μπαταρίας ή ενός συσσωρευτή δεν πρέπει να βραχυκυκλώνονται. Διατηρήστε τις οδηγίες.

JPN 電池は充電しないで下さい。蓄電池は充電する前に玩具から取り外して下さい (玩具から取り外せるようになっている場合)。蓄電池の充電は必ず大人のいるところで行って下さい (玩具から取り外せるようになっている場合)。異なる種類の電池は、使用済、使用済、あるいは異なる種類のものなどを混ぜ合わせておかないで下さい。電池や蓄電池は、指定の種類、またはそれに類似したもの以外は使用しないで下さい。電池や蓄電池を接続する際には、極性と接続の向きをよく確認します。使用済の電池や蓄電池は玩具から取り外して下さい。電池や蓄電池の極性はショートしないよう取り外しに注意して下さい。この説明書は保存しておいて下さい。

USA Do not mix old and new batteries. Do not mix alkaline, standard (carton-zinc), or rechargeable (nickel-cadmium) batteries.



363, avenue de Saint Exupéry
62100 Calais - France
<http://www.meccano.com>
© 04/2006 MECCANO

® MECCANO and ERECTOR are exclusive trademarks of MECCANO
All rights reserved