

Instructions
Notice de montage
Bauanleitung
Istruzioni di montaggio
Instrucciones de montaje
Instruções de montagem
Monteringsanvisning
Kokoamisohje
Monterings instruktioner
Montagehandleiding
Οδηγίες συναρμολόγησης.
組立説明書

TUNING RADIO CONTROL



#9950

8+



P.6



P.14



P.21



B969 x8



B664 x1

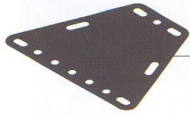

B480 x1

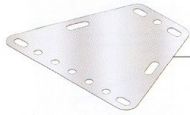

C037 x1

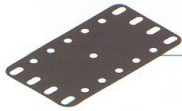

B583 x2



B709 x1



B709 x1



A201 (0201) x4



A300 (0103F) x1



A307 (0103H) x1



A302 (0002A) x1



B482 x1

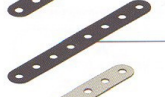

B666 x4



A203 (0003) x2



B488 x2



B973 x2



A105 (0005) x5



A506 (0006A) x4

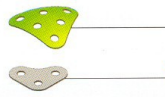

A367 (0133B) x2

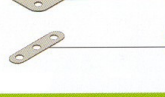

B484 x1



A133 (0133A) x2



A416 (0235E) x2

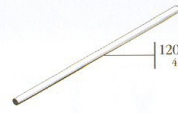

120 mm
4 3/4"

B908 x2



32 mm
1 1/4"

A518 (0018C) x2



A420 (0260C) x2



A109 (0009F) x1



A825 (0825) x2



A713 (0012D) x2



A437 (0812D) x4



A512 (0012B) x3



A399 (0154A) x1



A431 (0154B) x1



A712 (0012C) x11



A012 (0012) x2



A212 (0212) x4



C060 x1



B906 x1



C069 x1



B891 x1



B895 x1



B900 x1



C070 x1



S091 x1



19 mm
3/4"

A911 (0111) x2



14,7 mm
37/64"

A247 (0147D) x6



12 mm
1/2"

A411 (0111A) x4



9,5 mm
3/8"

A511 (0111C) x14



5,8 mm
15/64"

A637 (0037B) x88



5,8 mm
15/64"

A637 (0037B) x2



25,4 mm
1"

A912 (0111E) x1



A238 (0038A) x10



A338 (0038B) x4



A138 (0038) x6



A337 (0037A) x113



A134 (0034) x1



A136 (0036C) x1

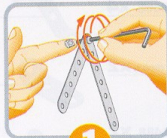
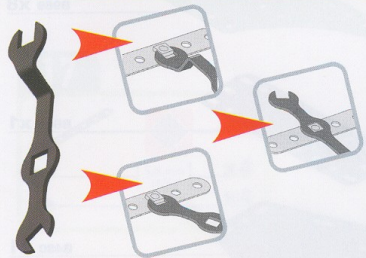
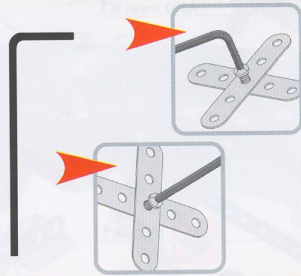
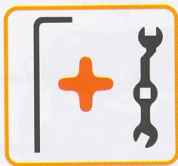

1

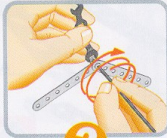

2

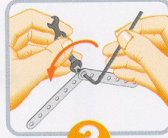

3

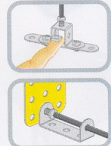

GB : Bend the spring steel parts, they will return to their original position.

F : Déformez les pièces en acier ressort, elles retrouvent leur position initiale.

D : Verbiege die Teile aus Federstahl, sie nehmen wieder ihre ursprüngliche Stellung ein.

I : Deformati i pezzi in acciaio elastico ritrovano la loro posizione iniziale.

E : Deforma las piezas de acero muelle, que recuperan su posición inicial.

JPN : 鋼鉄スプリングの部品を曲げてみてください。元の形に戻ります。

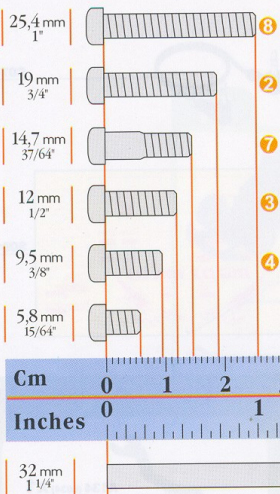

Scale
Echelle
Maßstab
Scala

Escala
Schaal
Escala
Skala

Mittakaava
Målestok
Κλίμακα
スケール

1:1



USER GUIDE
GUIDE DE L'UTILISATEUR
GEBRAUCHSANWEISUNG
GUIDA UTENTE
GUÍA DEL USUARIO
GEBRUIKERSGIDS



Warning: Changes or modifications to this unit not expressly approved by the party responsible for compliance could void the user's authority to operate the equipment.

NOTE: This equipment has been tested and found to comply with the limits for a Class B digital device, pursuant to Part 15 of the FCC Rules. These limits are designed to provide reasonable protection against harmful interference in a residential installation. This equipment generates, uses and can radiate radio frequency energy and, if not installed and used in accordance with the instructions, may cause harmful interference to radio communications.

However, there is no guarantee that interference will not occur in a particular installation. If the equipment does cause harmful interference to radio or television reception, which can be determined by turning the equipment off and on, the user is encouraged to try to correct the interference by one or more of the following measures:

- Reorient or relocate the receiving antenna.
- Increase the separation between the equipment and receiver.
- Connect the equipment into an outlet on a circuit different from that to which the receiver is connected.
- Consult the dealer or an experienced radio/TV technician for help.



- (GB USA) Refer to the USER GUIDE, included in the box, for information on operating the remote control.
- (F) Pour le fonctionnement du module radio-commandé, se référer au GUIDE DE L'UTILISATEUR inclus dans la boîte.
- (D) Die Funktion des funkgesteuerten Moduls ist in der beiliegenden GEBRAUCHSANWEISUNG erklärt.
- (I) Per il funzionamento del modulo radiocomandato, far riferimento al MANUALE UTENTE incluso nella confezione.
- (E) Para el funcionamiento del módulo radiocomandado, remitirse a la GUÍA DEL USUARIO incluida en la caja.
- (P) Para o funcionamento do módulo radiocomandado, reporte-se ao GUIA DO UTILIZADOR incluído na caixa.
- (S) För den radiostyrda modulens funktion, se ANVÄNDARGUDIEN som ingår i lådan.
- (FIN) Katso radio-ohjattu moduulin käyttöohjeet mukana toimitetusta KÄYTTÄJÄN KÄSIKIRJASTA
- (DK) Det radiostyrede moduls virkemåde er beskrevet i BRUGSVEJLEDNINGEN, der medfølger i æsken.
- (NL) Voor de werking van de radiogestuurde module verwijzen we naar de GEBRUIKERSGIDS die in de doos zit.
- (GR) Για τη λειτουργία της τηλεχειριζόμενης μονάδας, ανατρέξτε στις ΟΔΗΓΙΕΣ ΧΡΗΣΗΣ που περιλαμβάνονται στη συσκευασία.
- (JPN) リモコン操作に関する説明は、ボックスに入っている「ユーザーガイド」を参照してください。

CONSTRUCTION TIPS

ASTUCES DE CONSTRUCTION

KONSTRUKTIONS-TIPPEN

LE ASTUZIE DELLA COSTRUZIONE

LOS INGENIOS DE LA CONSTRUCCIÓN

DE FIJNE KNEEPPES VAN NET BOUWEN

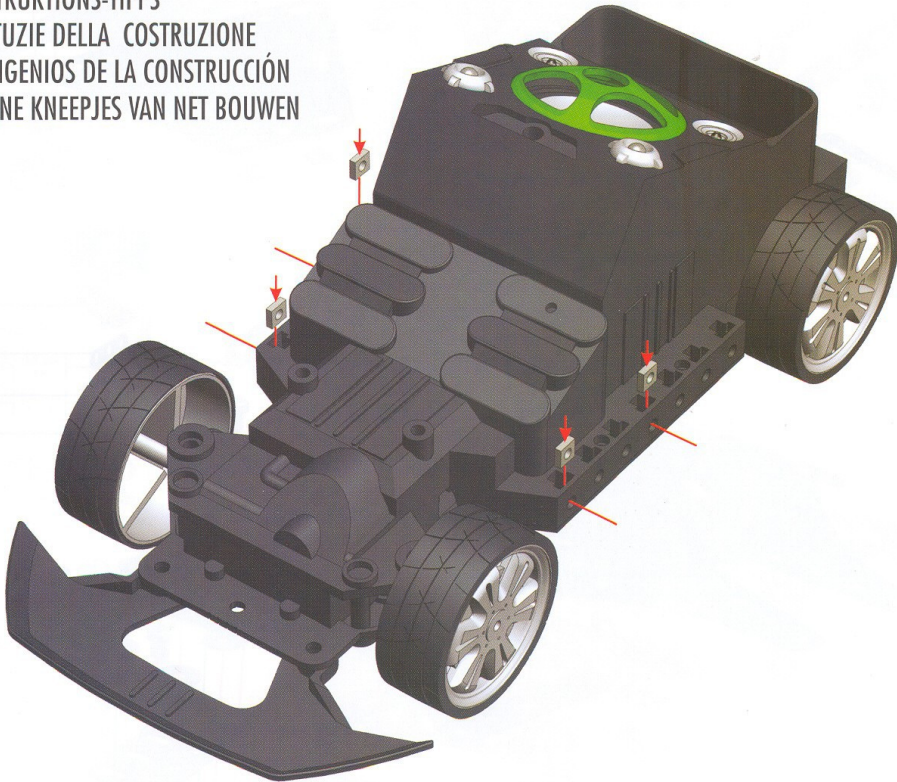



1

	x2
	x1
	x4
	x6
	x6

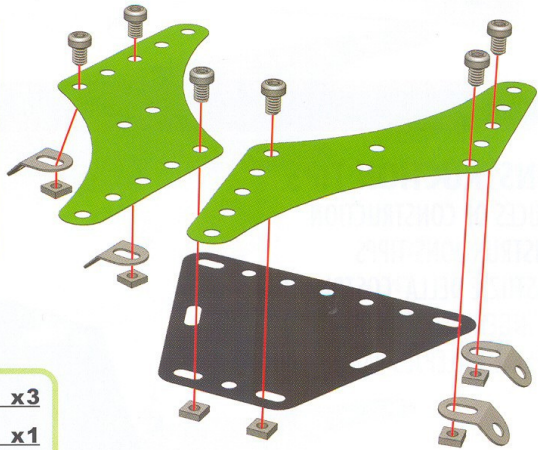

2

	x1		x3
	x1		x1
	x2		x2
			x3

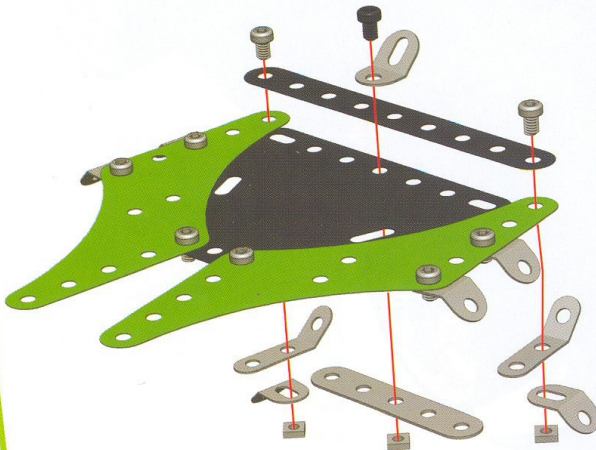

3

	x1
	x1
	x2
	x2
	x6
	x6

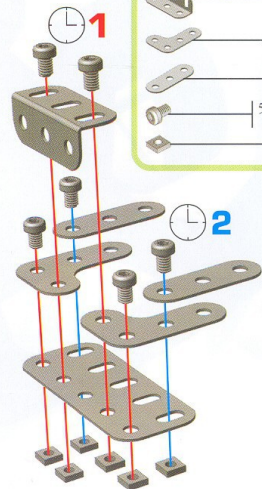

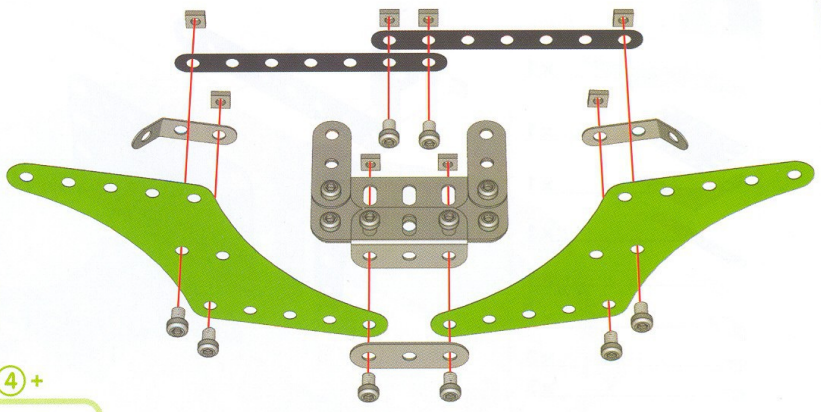

4

-  x2
-  x2
-  x1
-  x2
-  x8
-  x8









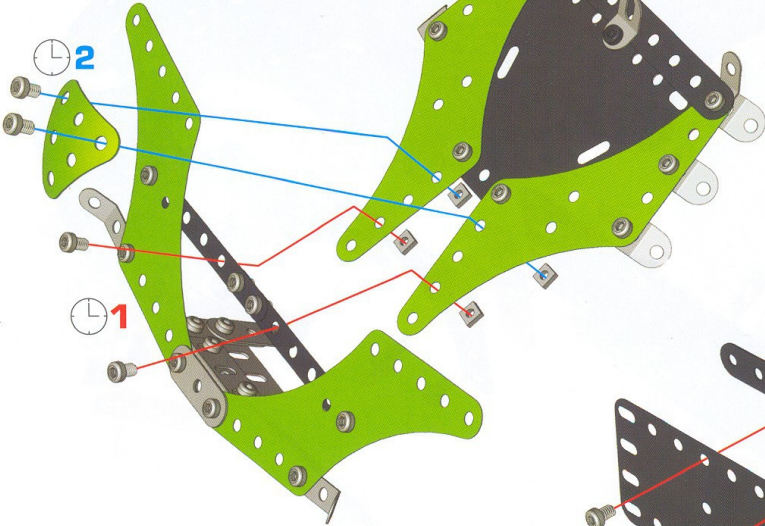

5

② + ④ +

-  x1
-  5,8 mm 15/64" x4
-  x4

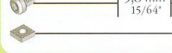

6

-  x1
-  x1
-  x1
-  x1
-  x1
-  x1
-  5,8 mm 15/64" x3
-  x3

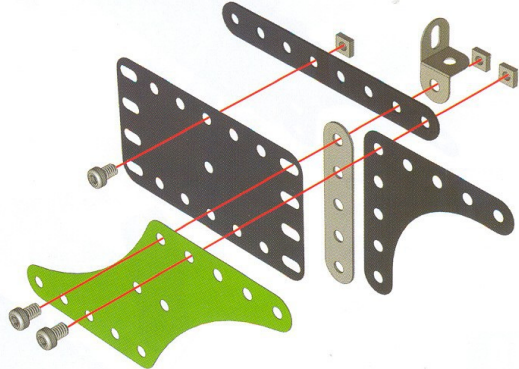







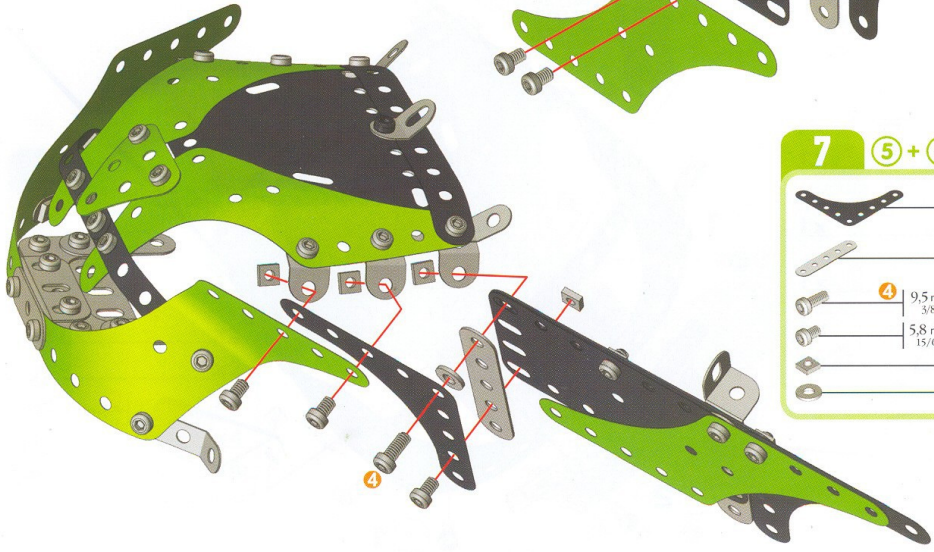

7

⑤ + ⑥ +

-  x1
-  x1
-  ④ 9,5 mm 3/8" x1
-  5,8 mm 15/64" x3
-  x4
-  x1







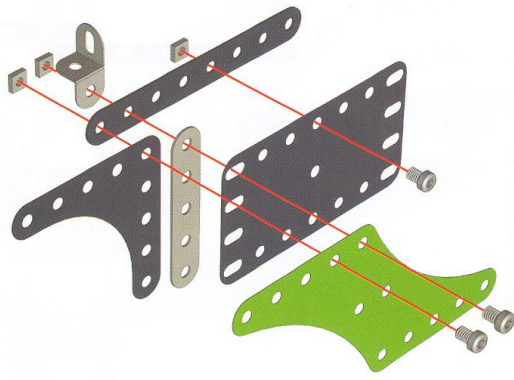

8

-  x1
-  x1
-  x1
-  x1
-  x1
-  x1
-  5,8 mm | 15/64" x3
-  x3





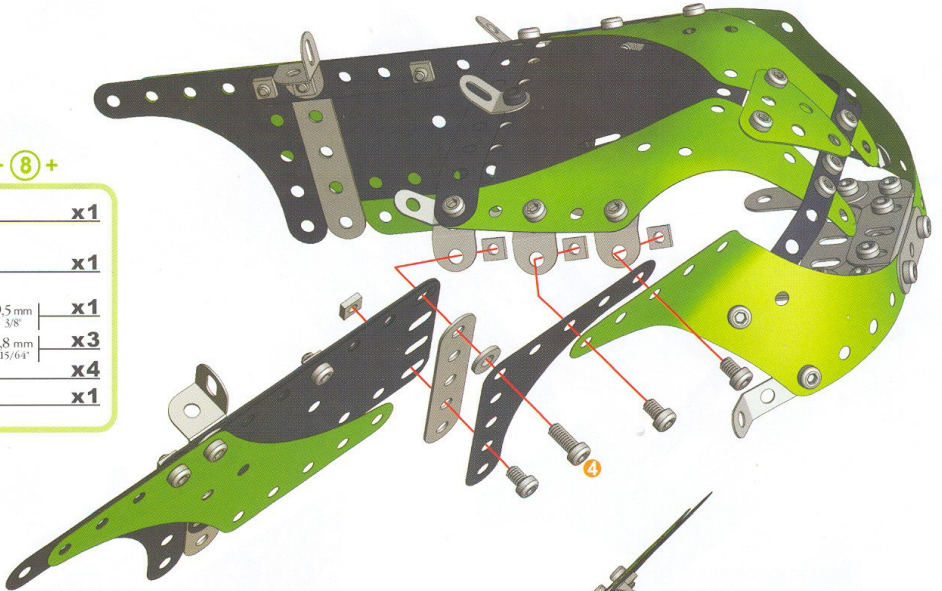

9

(7) + (8) +

-  x1
-  x1
-  9,5 mm | 3/8" x1
-  5,8 mm | 15/64" x3
-  x4
-  x1





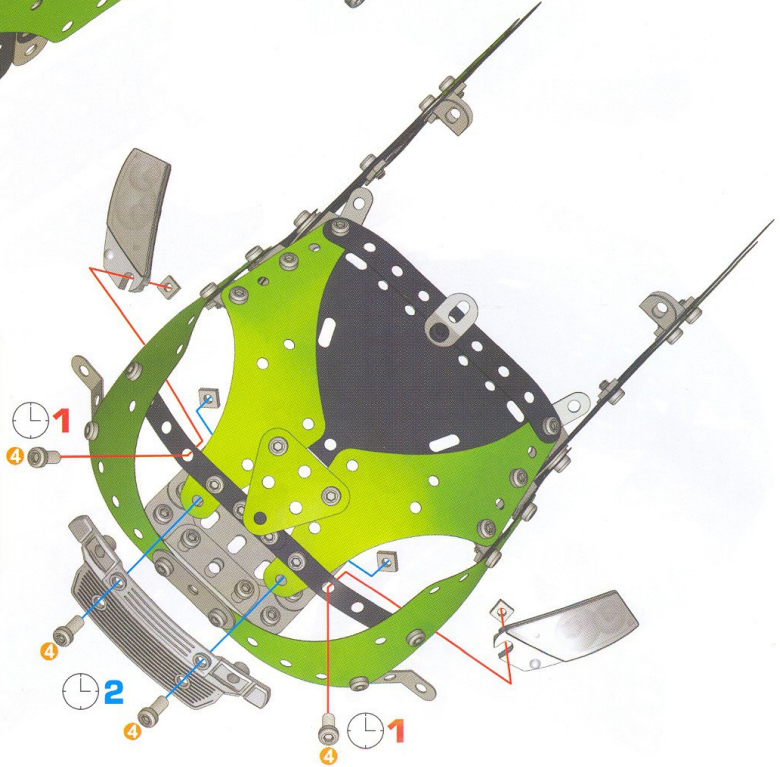

10

-  x1
-  x1
-  x1
-  9,5 mm | 3/8" x4
-  x4



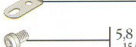

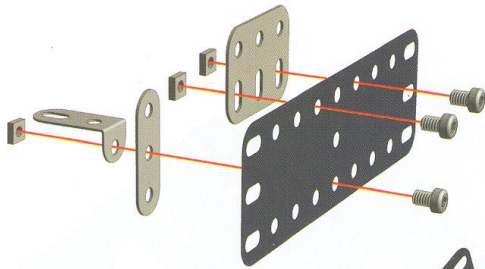

11

-  x1
-  x1
-  x1
-  x1
-  x3
-  x3





12

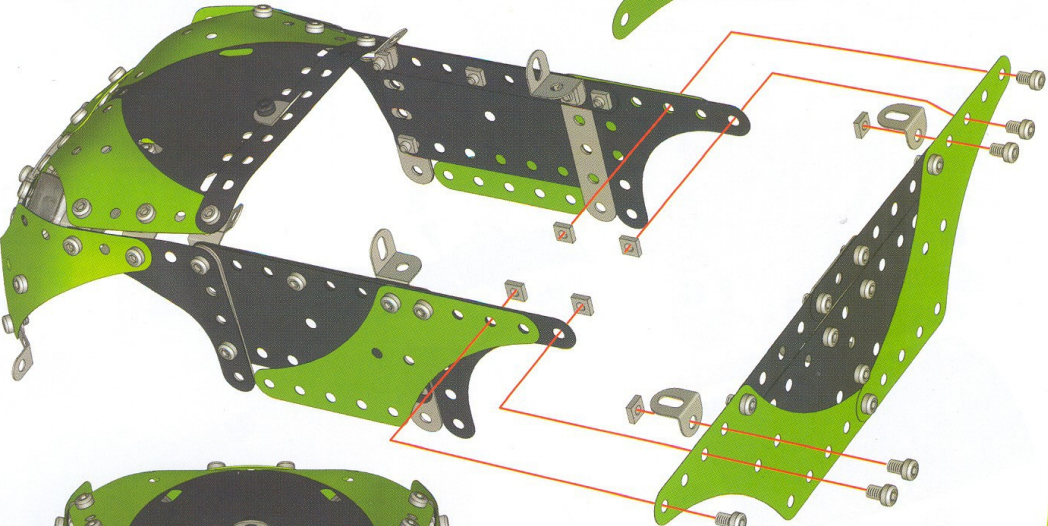
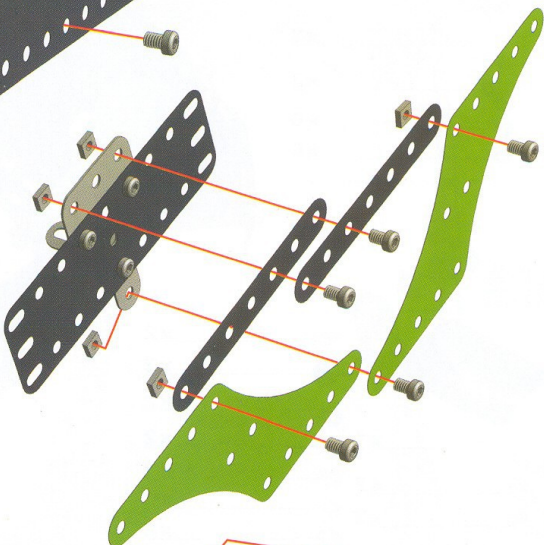

-  x2
-  x2
-  x5
-  x5



13 10 + 12 +





-  x2
-  x6
-  x6

14

-  x2
-  x4
-  x4



15

-  x1
-  x2
-  x2
-  5,8 mm 15/64" x6
-  x6

16

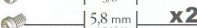
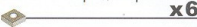

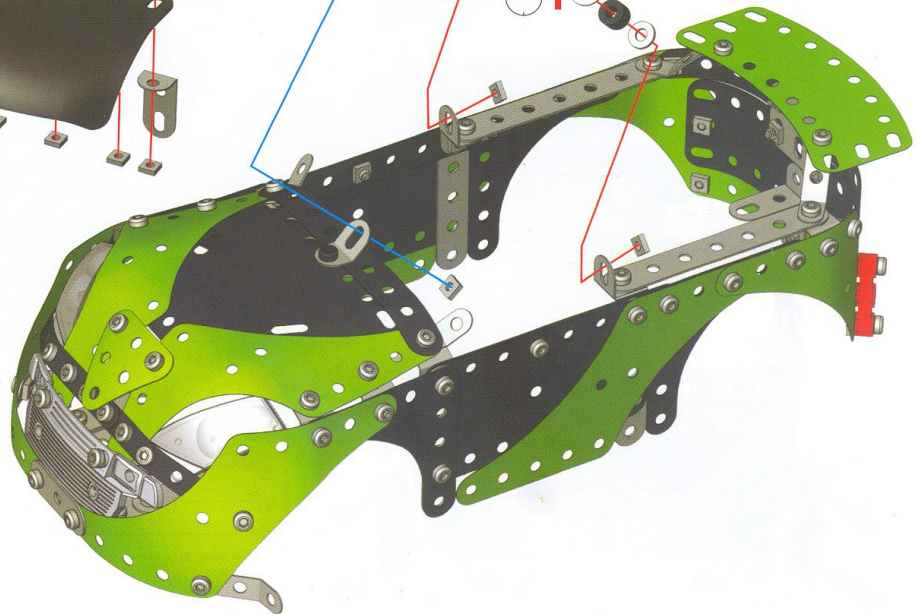
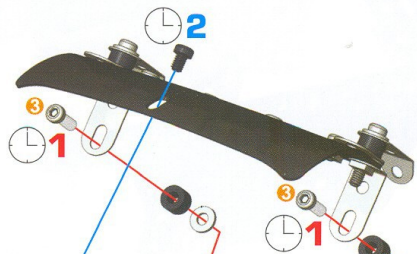
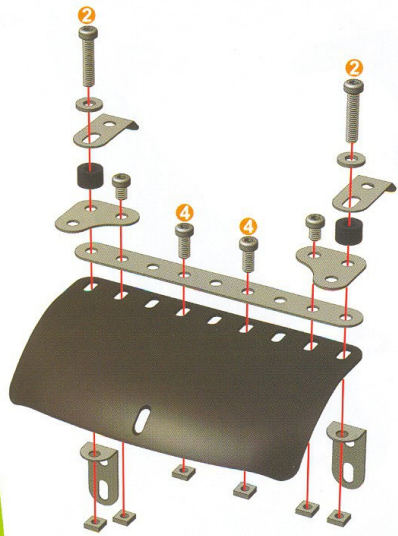
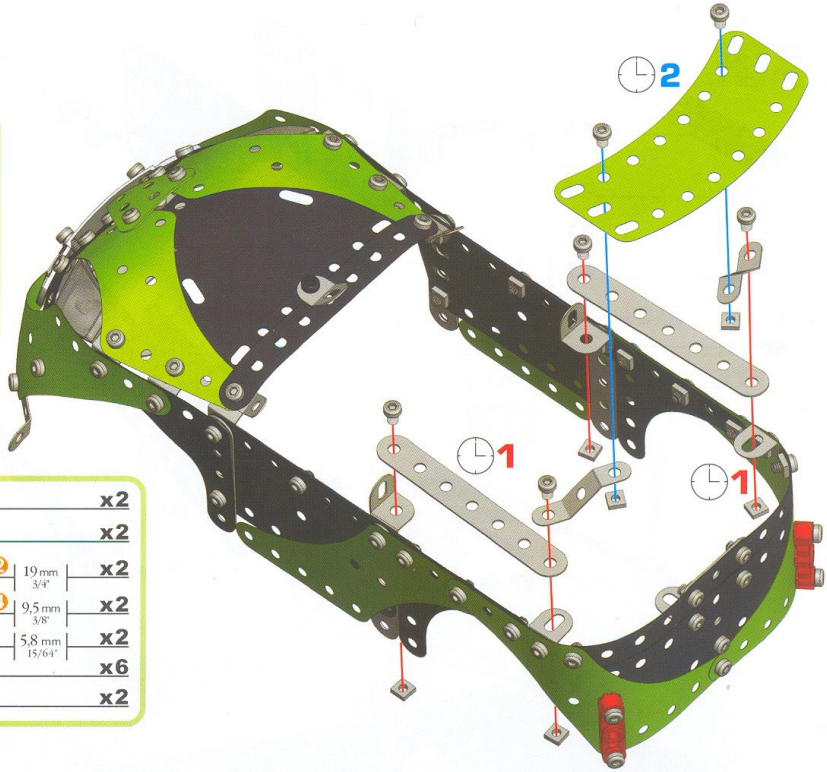

-  x1
-  x2
-  x2
-  19 mm 3/4" x2
-  4 9,5 mm 3/8" x2
-  5,8 mm 15/64" x2
-  x6
-  x2
-  x2

17 15 + 16 +

-  3 12 mm 1/2" x2
-  5,8 mm 15/64" x1
-  x2
-  x3
-  x2





18

-  32 mm | 1 1/4" | x2
-  x4
-  x2
-  5,8 mm | 15/64" | x2
-  x2





19 (17) + (18) +

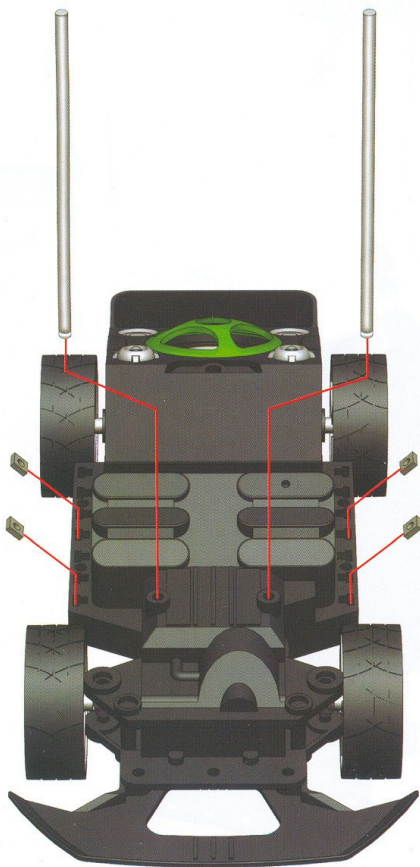



-  5,8 mm | 15/64" | x4
-  x4



20



-  x1
-  120 mm | 4 3/4" | x2
-  x4

21 19 + 20 +

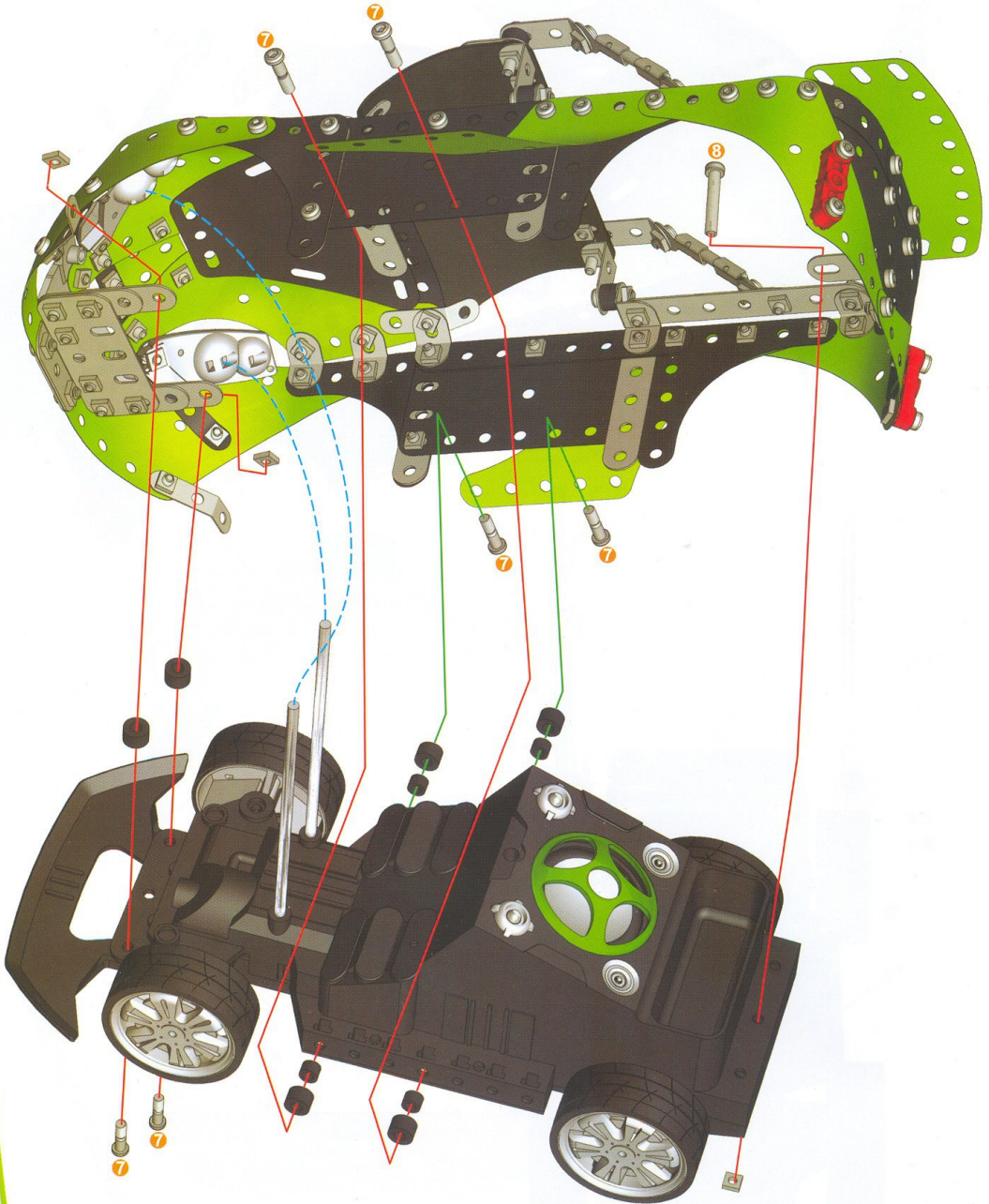
	8 25,4 mm 1"	x1		x6
	7 14,7 mm 3/4"	x6		x4
				x3



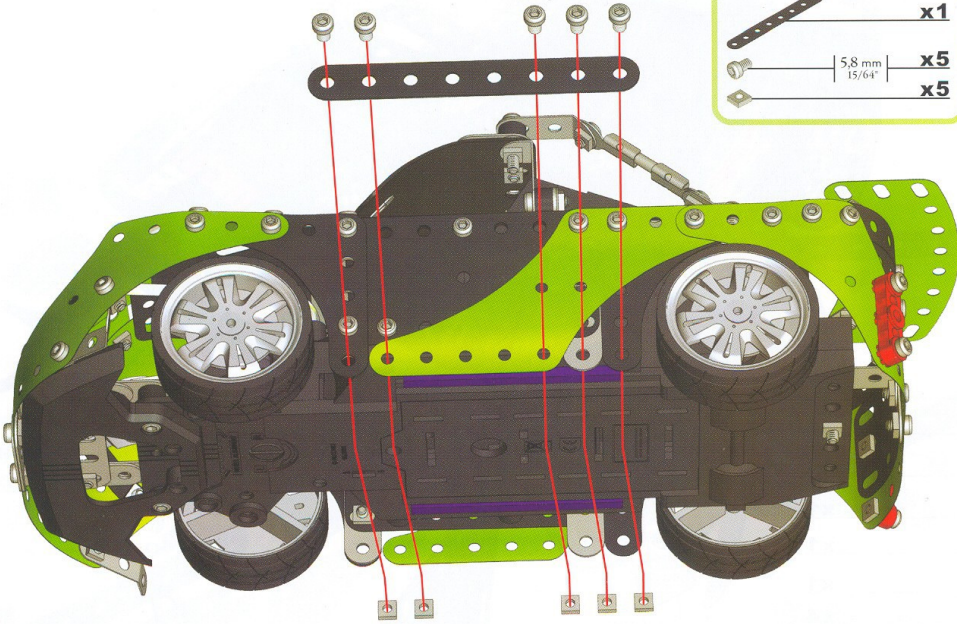

22

-  x1
-  5,8 mm | 15/64" x5
-  x5



23

-  x1
-  5,8 mm | 15/64" x5
-  x5

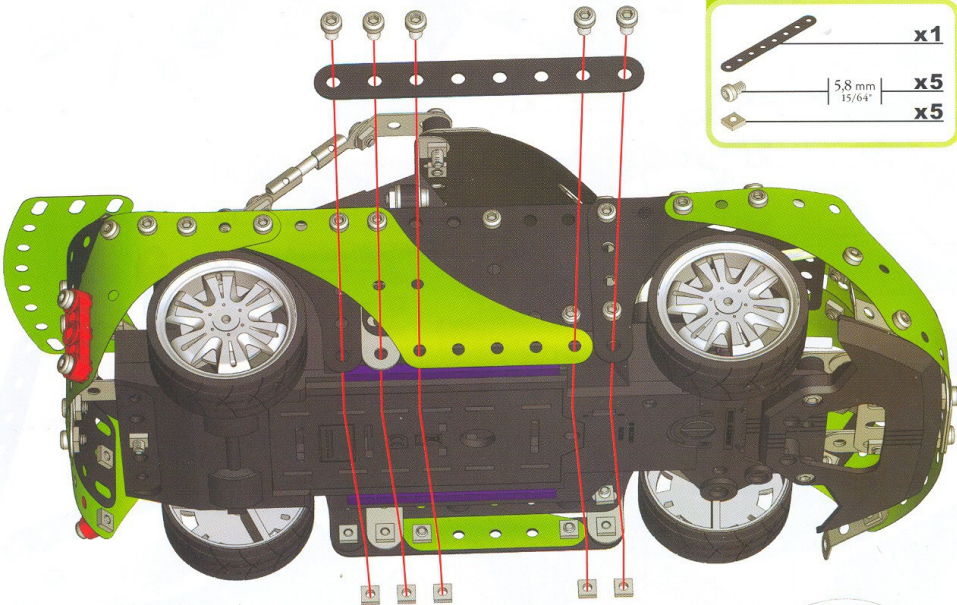



1

- x1
- x2
- x1
- x1
- x1
- x1
- | 5,8 mm | 15/64" | x4
- x4

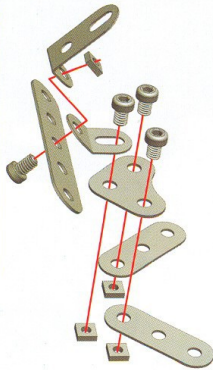

2

- x1
- x1
- | 5,8 mm | 15/64" | x1
- x1

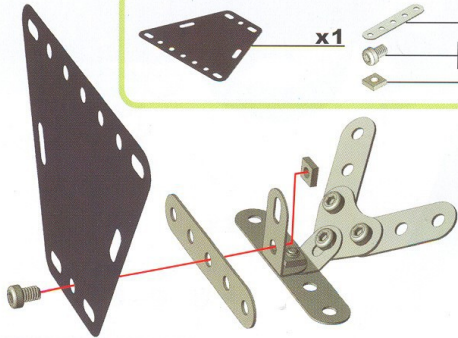

3

- x2
- x1
- | 19 mm | 3/4" | x2
- | 5,8 mm | 15/64" | x2
- x1
- x4

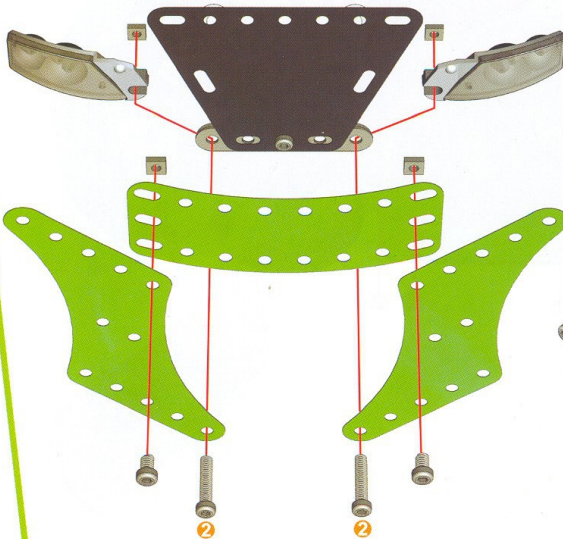



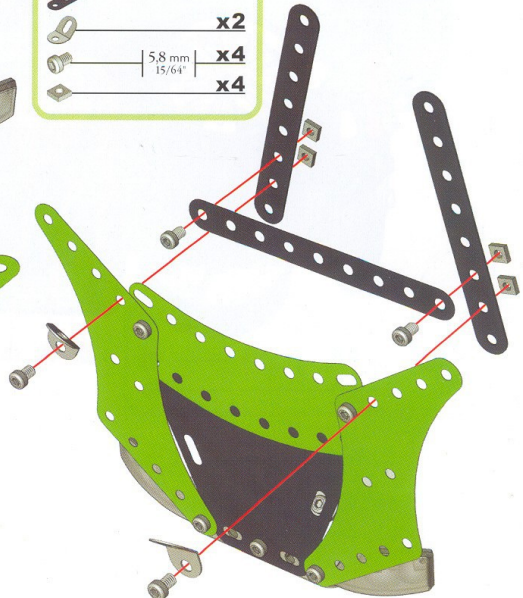

4





- x1
- x2
- x2
- | 5,8 mm | 15/64" | x4
- x4







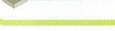

5

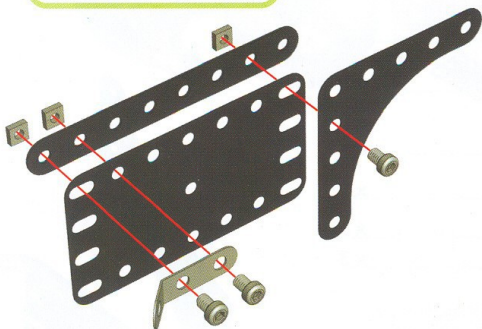
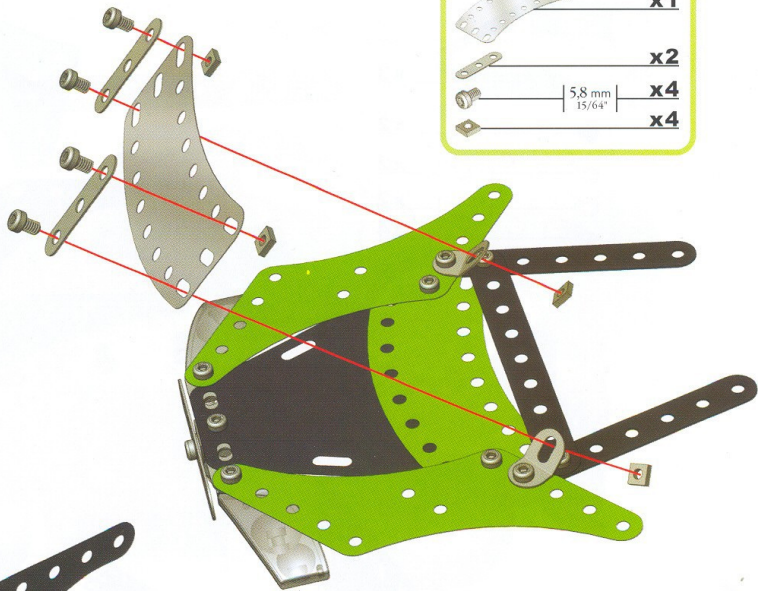
-  **x1**
-  **x2**
-  **x4**
-  **x4**





6

-  **x1**
-  **x1**
-  **x1**
-  **x1**
-  **x3**
-  **x3**

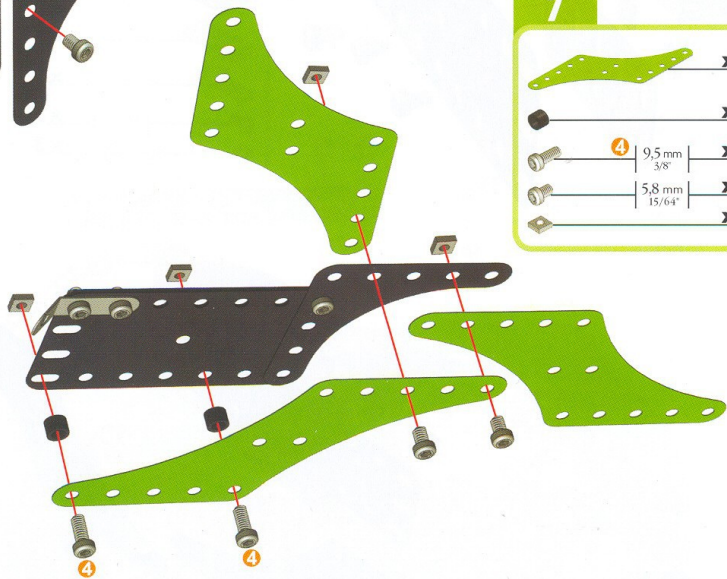
**7**



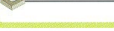

-  **x3**
-  **x2**
-  **x2**
-  **x2**
-  **x4**

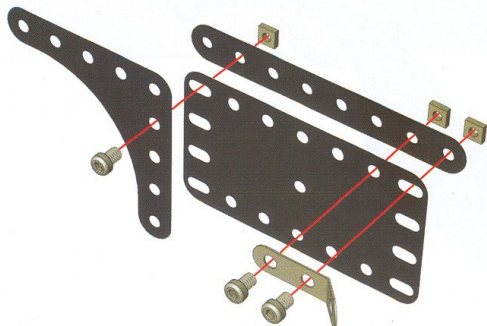
**8**

-  **x1**
-  **x1**
-  **x1**
-  **x1**
-  **x3**
-  **x3**





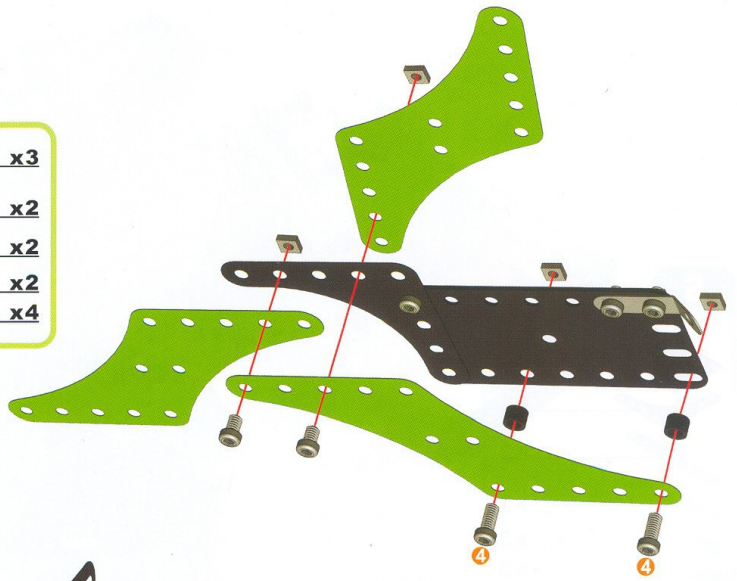

9

-  x3
-  x2
-  9,5 mm | 3/8" x2
-  5,8 mm | 15/64" x2
-  x4



10

-  x1
-  x1
-  x1
-  5,8 mm | 15/64" x3
-  x3

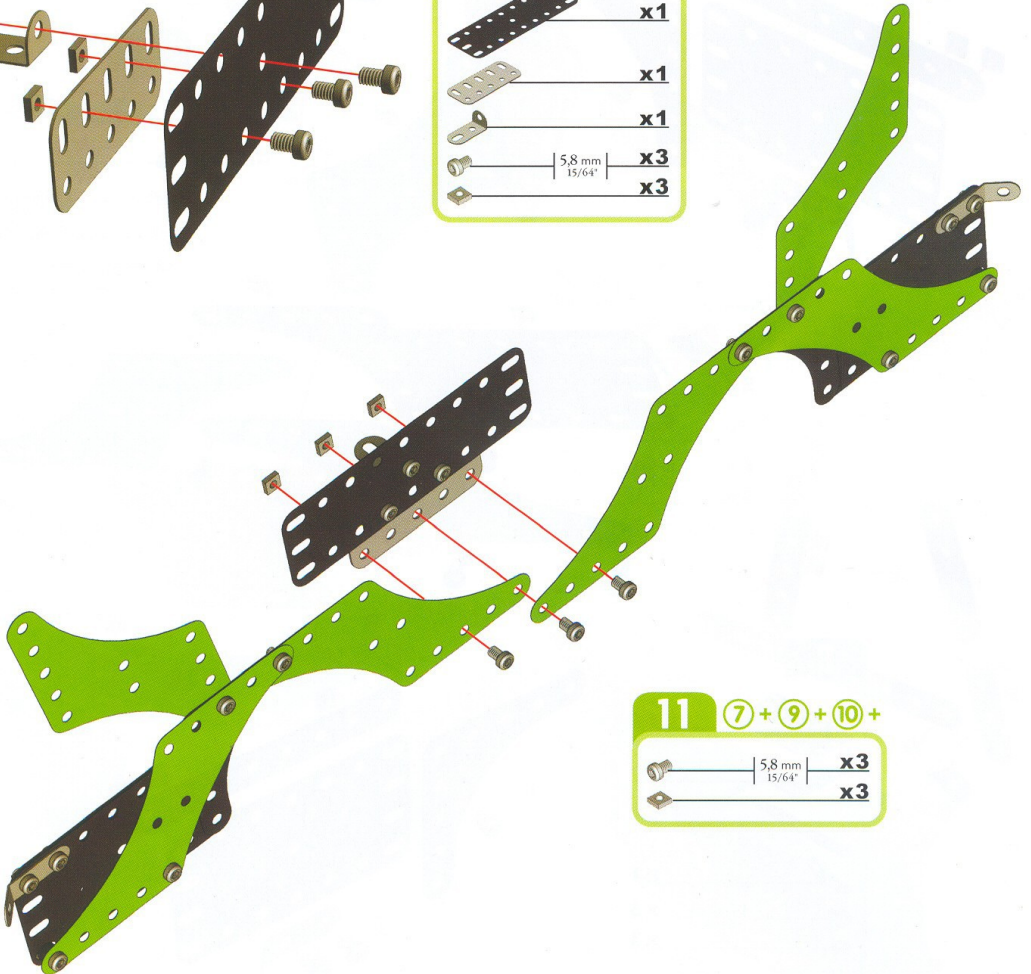
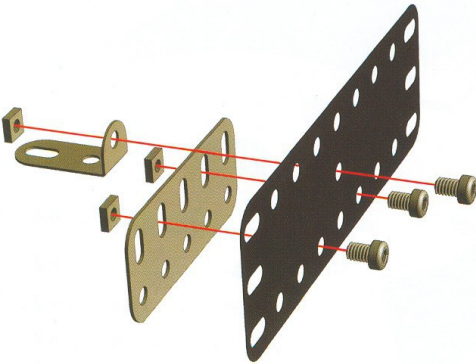

11 7 + 9 + 10 +

-  5,8 mm | 15/64" x3
-  x3

12

 5,8 mm | x2
15/64" | x2

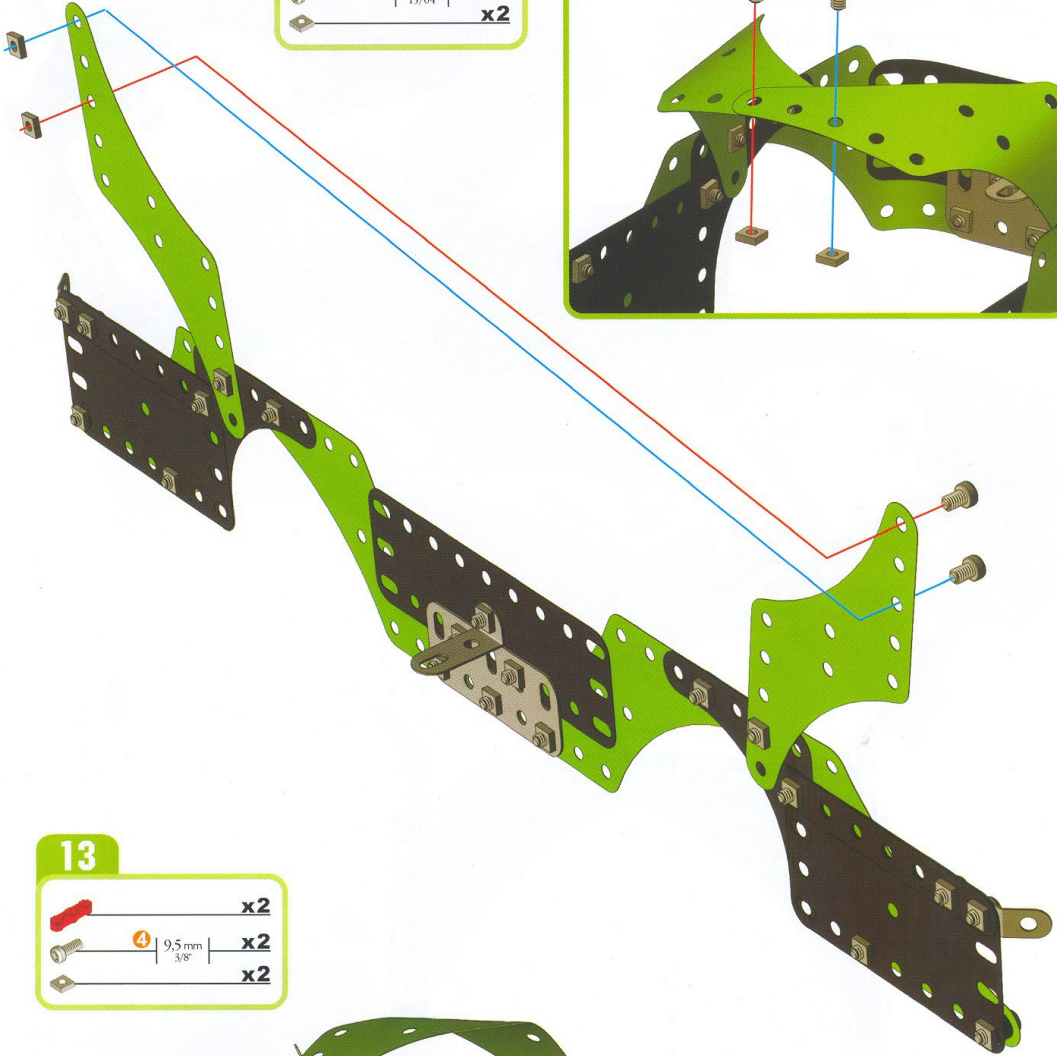
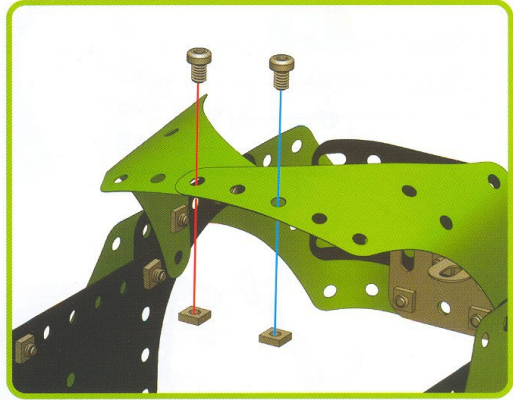

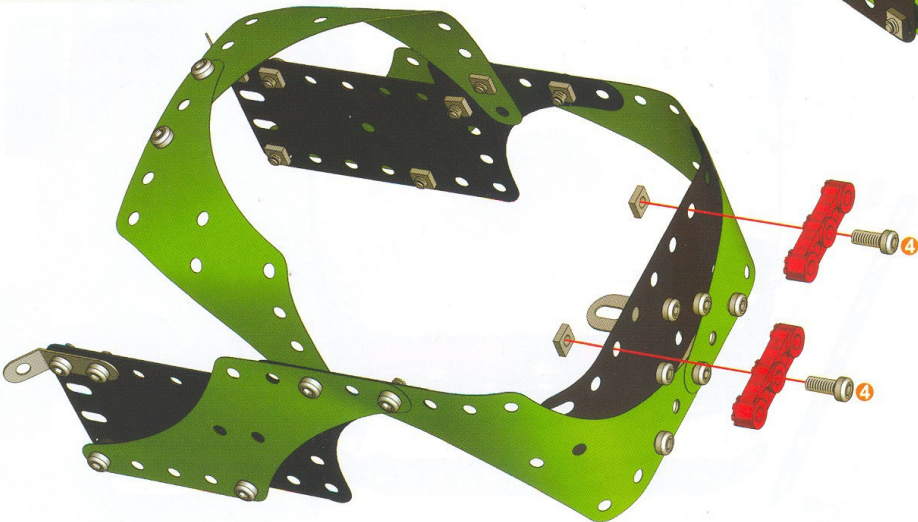

13

 x2
 4 | 9,5 mm | x2
3/8" | x2





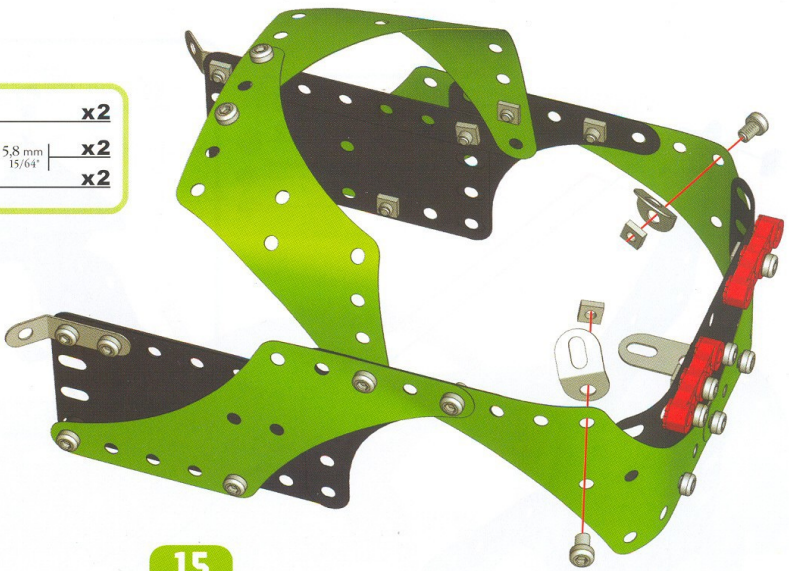

14

-  x2
-  x2
-  x2



15

-  x1
-  x2
-  x4
-  x4

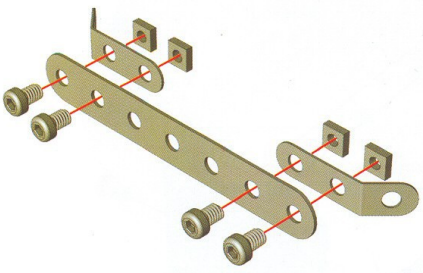

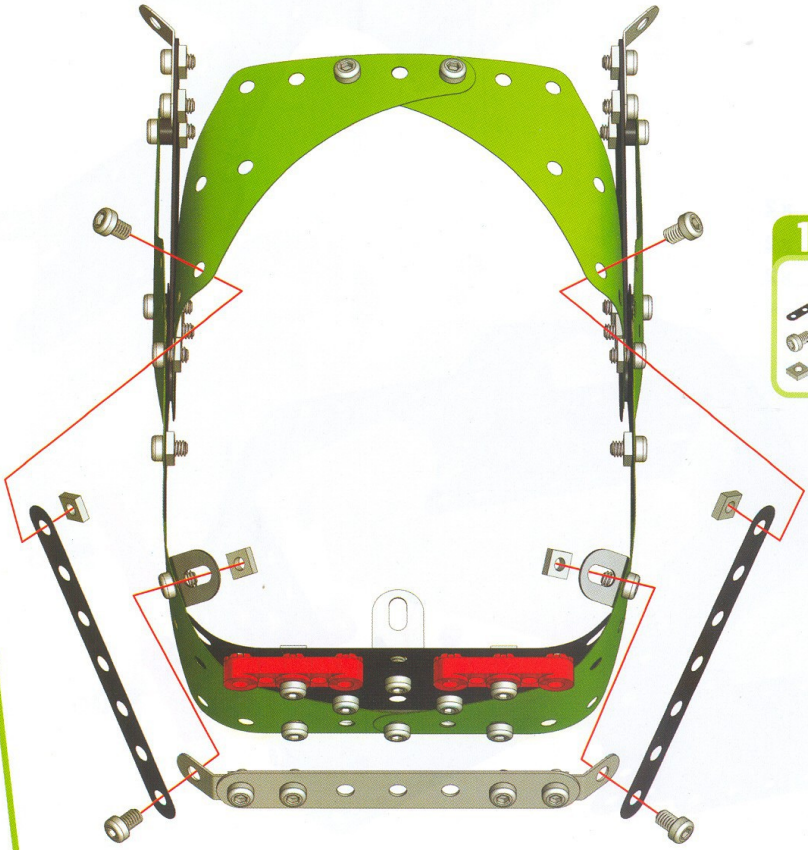

16 (14) + (15) +

-   x2
-  x4
-  x4



17 (5) + (16) +

	5,8 mm 15/64"	x4
		x4

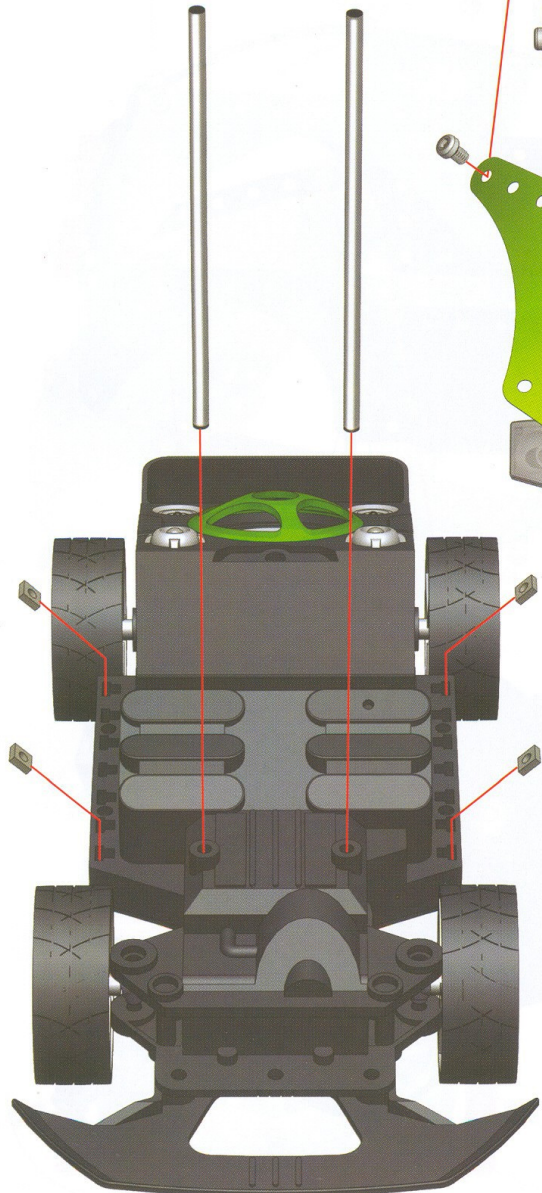
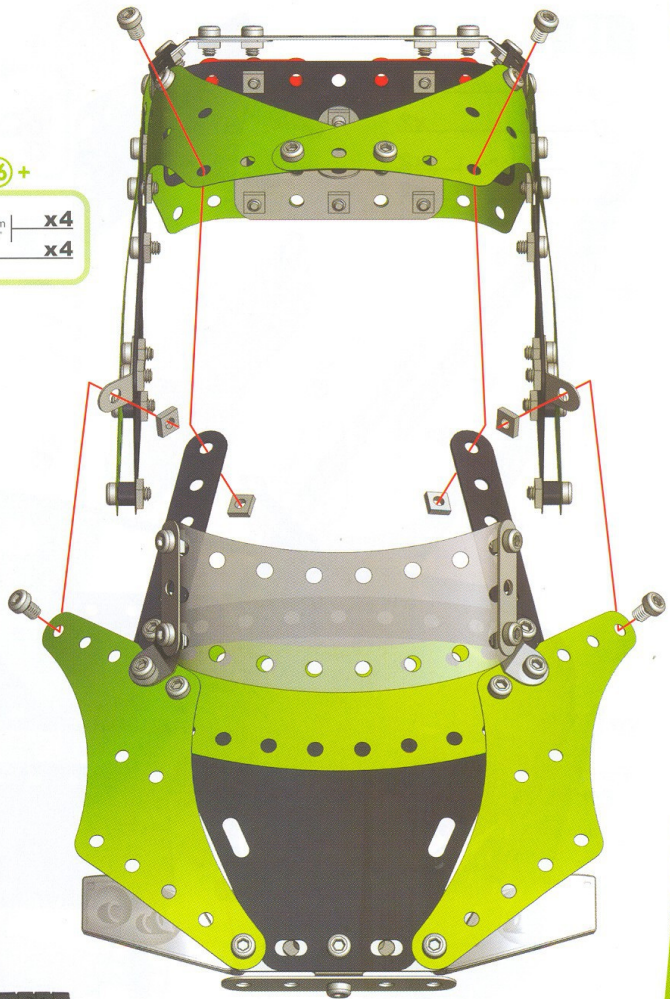

18

	x1	
	120 mm 4 5/8"	x2
		x4

19

	x2
	x2
	x2
	x2

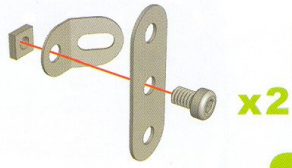







20 17 + 18 + 19 +

	8	25,4 mm 1"	x1		x6
	7	14,7 mm 37/64"	x2		x3
	3	12 mm 1/2"	x4		x1





1



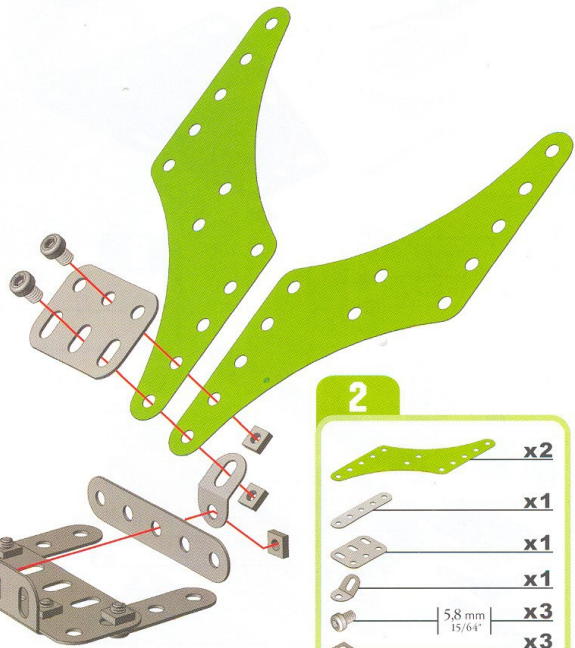
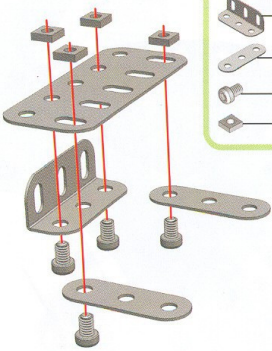



-  x1
-  x1
-  x2
-  x4
-  x4
-  x4



2

-  x2
-  x1
-  x1
-  x1
-  x3
-  x3

3

-  x1
-  x1
-  x2
-  x2
-  x2
-  x4
-  x6

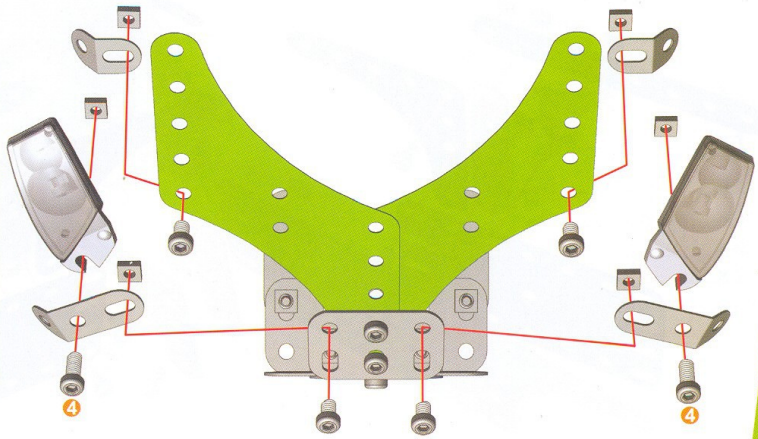



- 4**
- x2
 - x1
 - x1
 - x2
 - x2
 - x3
 - x3

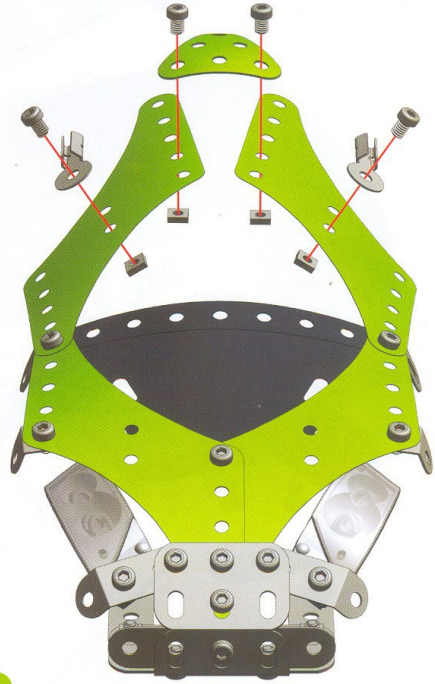

- 5**
- x1
 - x2
 - x4
 - x4

- 6**
- x1
 - x1
 - x1
 - x1
 - x4
 - x4

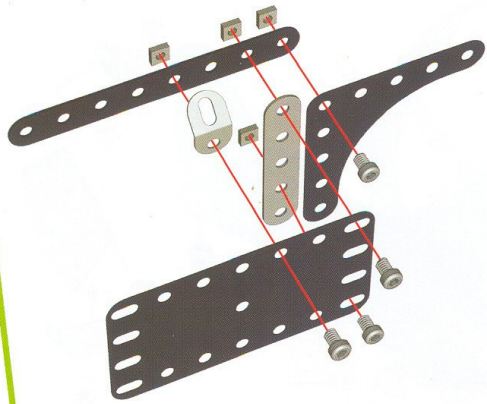

- 7**
- x1
 - x1
 - x1
 - x1
 - x4
 - x4

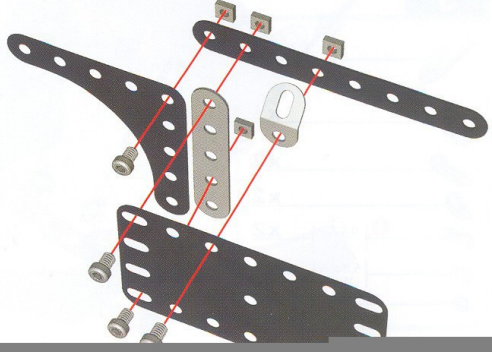

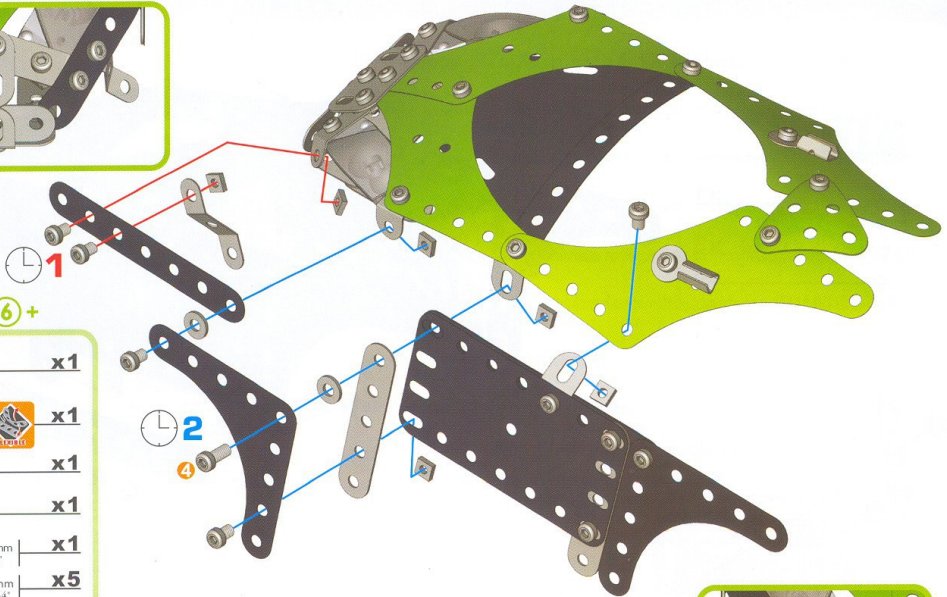
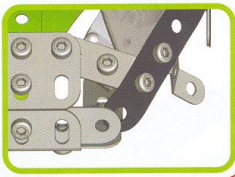

8 (5) + (6) +

- x1
- x1
- x1
- x1
- 4 | 9,5 mm | 3/8" | x1
- | 5,8 mm | 15/64" | x5
- x6
- x2

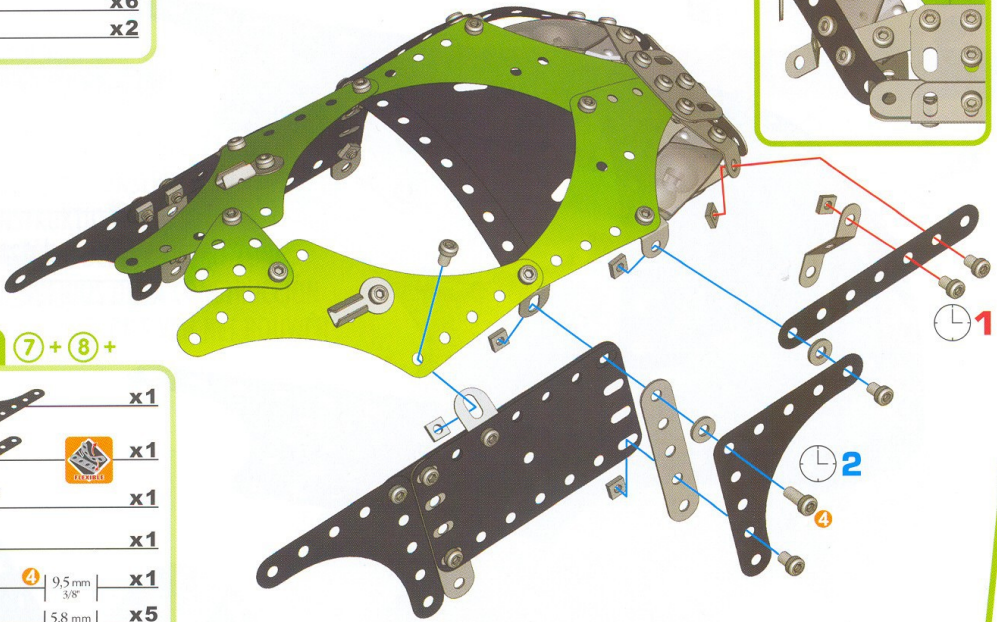

9 (7) + (8) +



- x1
- x1
- x1
- x1
- 4 | 9,5 mm | 3/8" | x1
- | 5,8 mm | 15/64" | x5
- x6
- x2

10

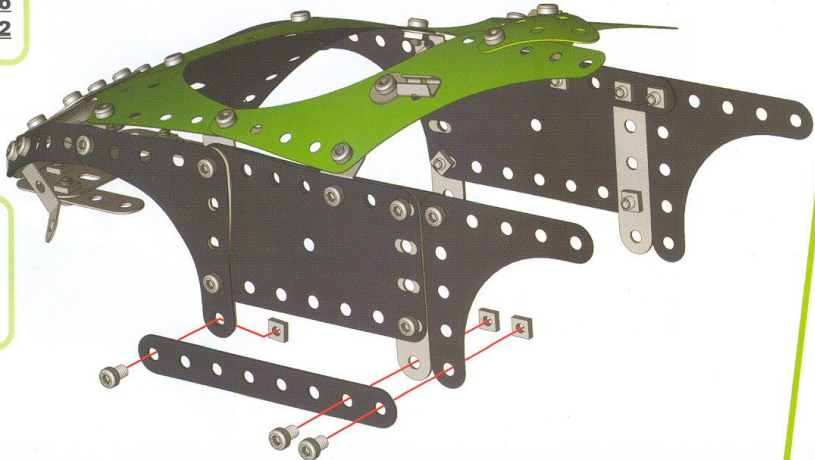
- x1
- | 5,8 mm | 15/64" | x3
- x3





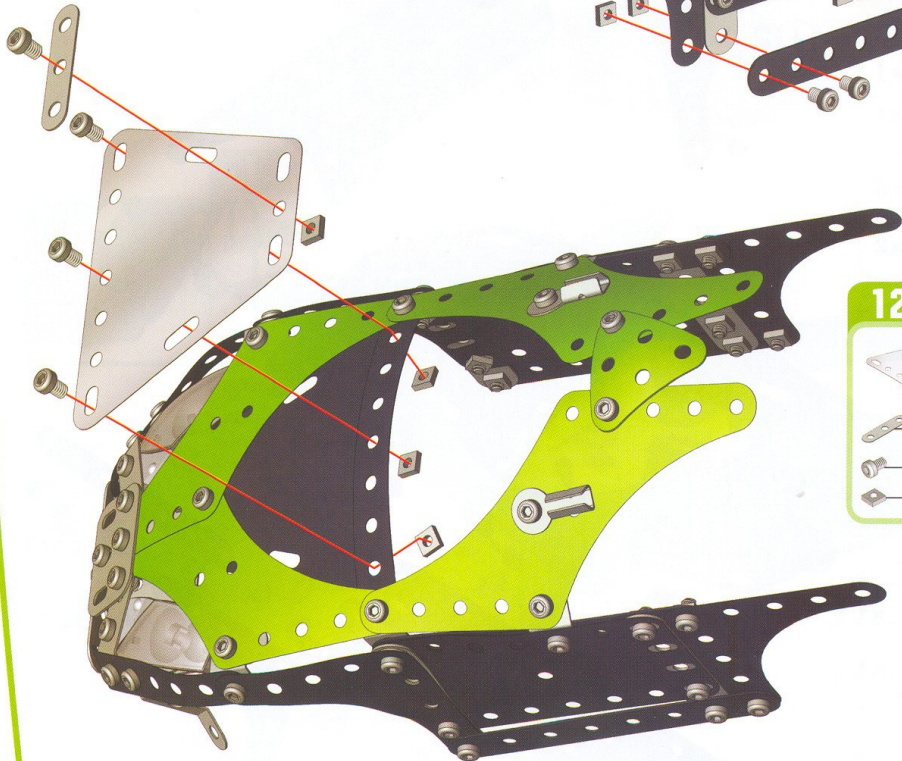
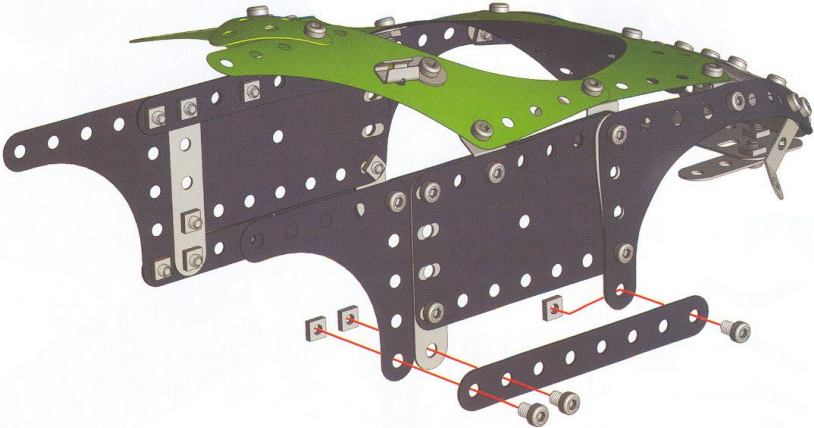

11

-  x1
-  | 5,8 mm | 15/64" x3
-  x3



12



-  x1
-  x1
-  | 5,8 mm | 15/64" x4
-  x4

13

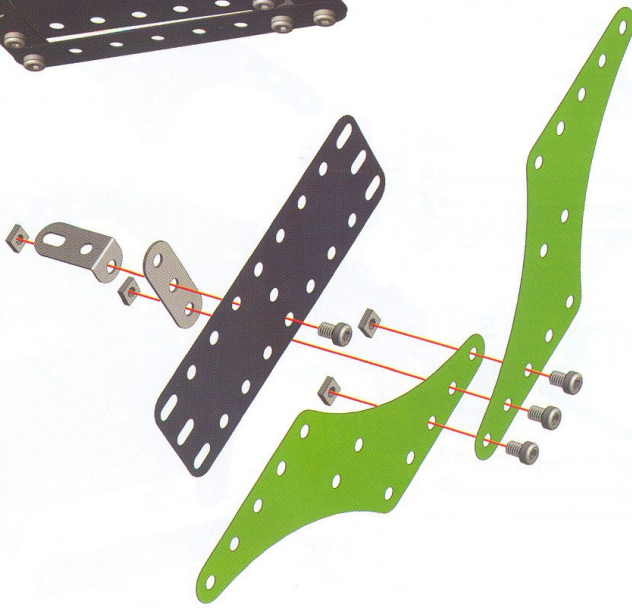
-  x2
-  x1
-  x1
-  x1
-  | 5,8 mm | 15/64" x4
-  x4



14

	x2
	x2
	x2

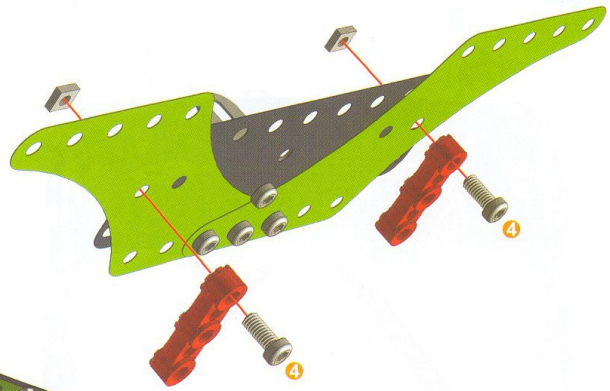

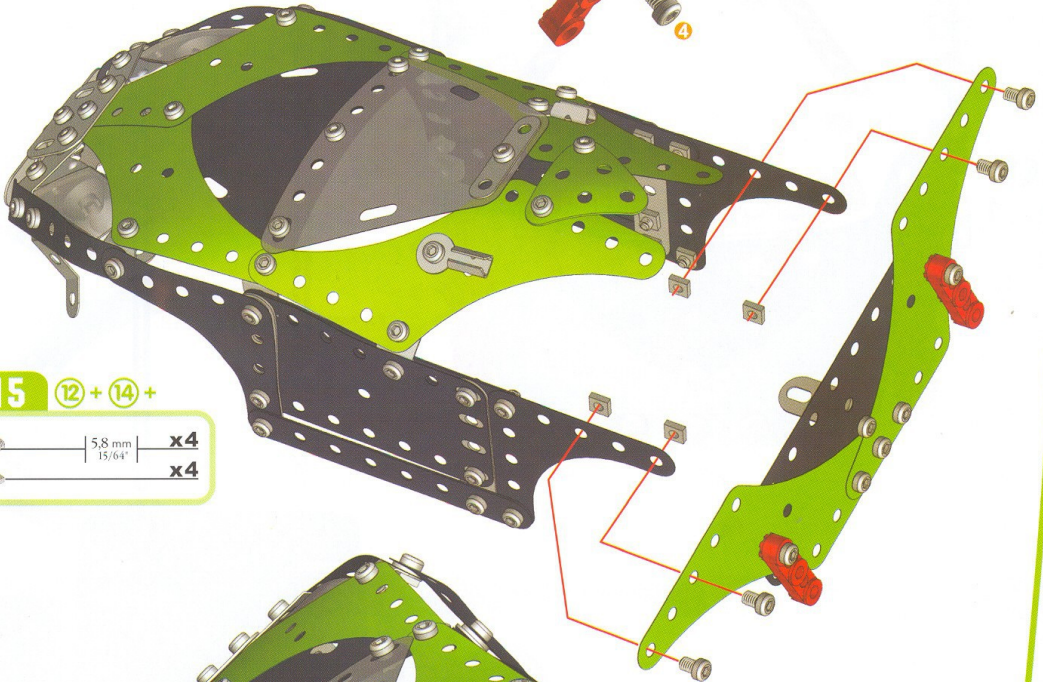

15 (12) + (14) +

	5,8 mm 15/64"	x4
		x4





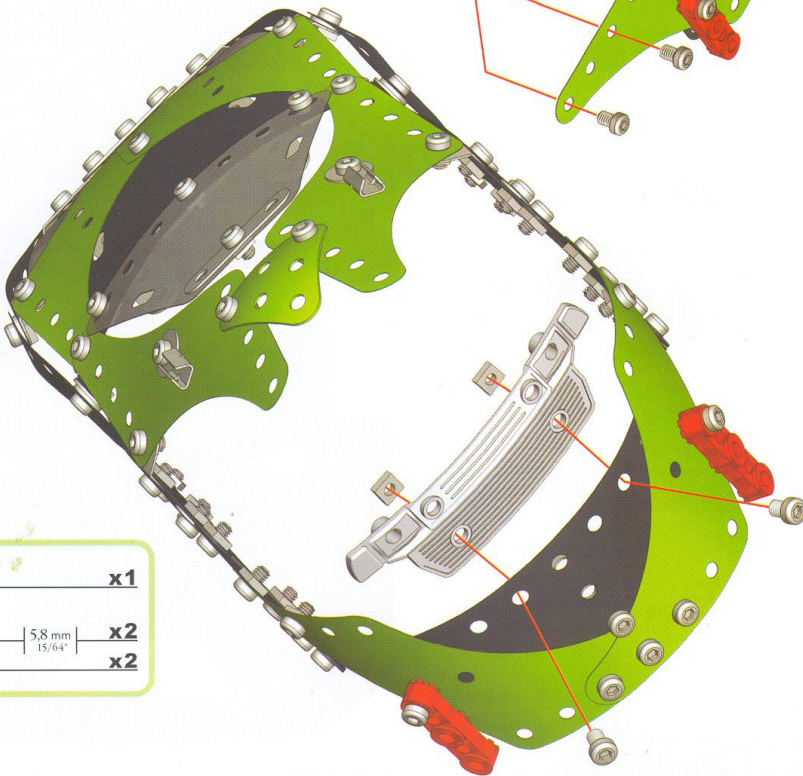

16

	x1	
	5,8 mm 15/64"	x2
		x2







17



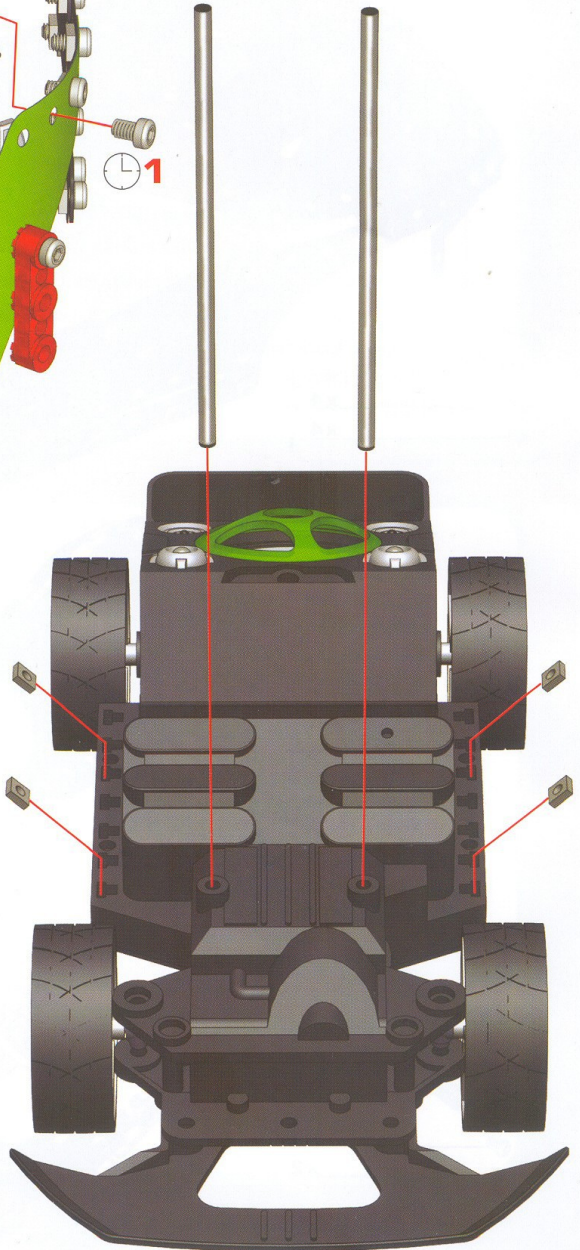

-   x2
-  | 5,8 mm | 15/64" | x4
-  x4

18

-  x1
-  | 120 mm | 4 3/4" | x2
-  x4



19 17 + 18 +

 8	25,4 mm 1"	x1		x6
 7	14,7 mm 37/64"	x6		x4
				x3

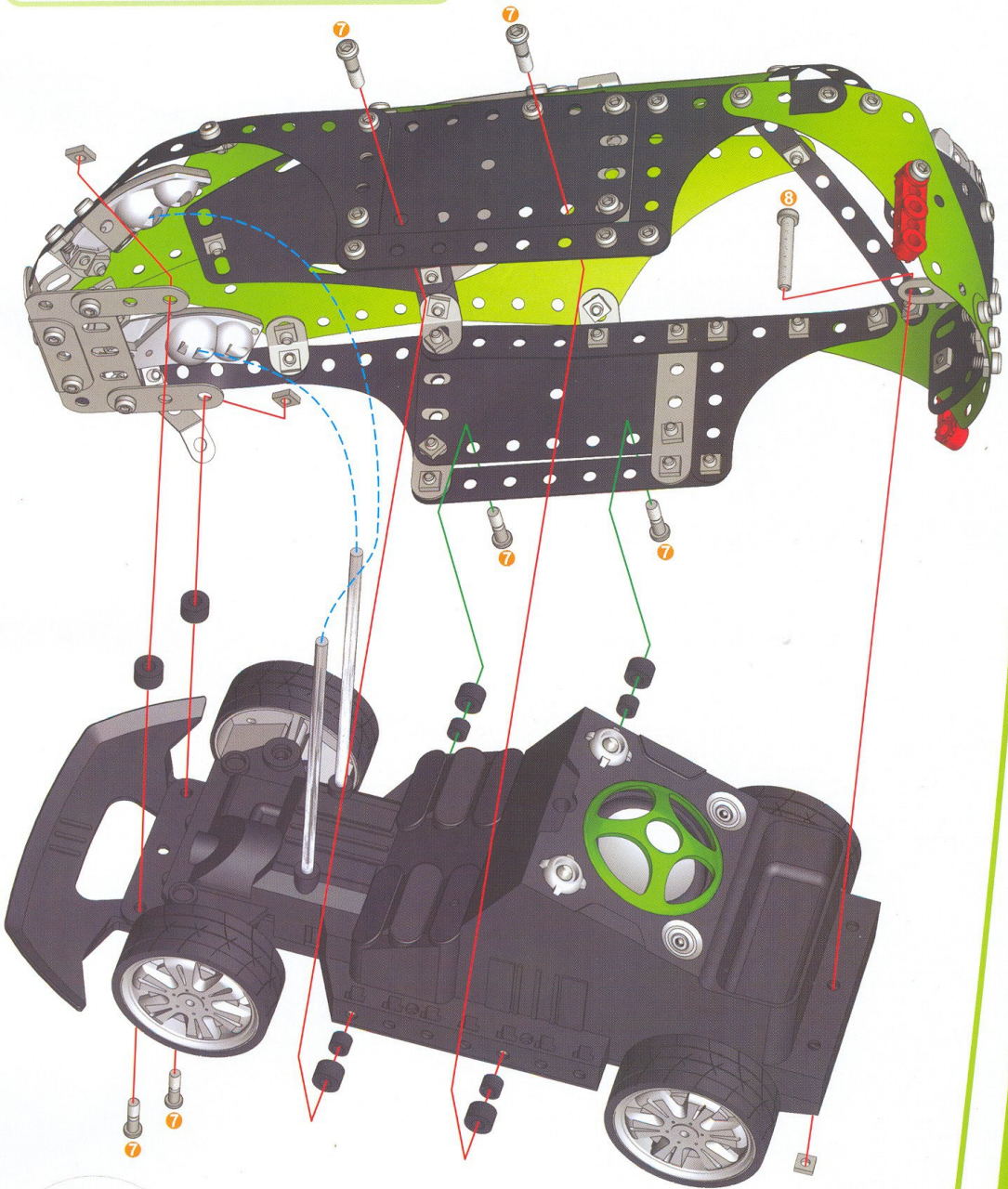

GB USA Many of the models and component parts are unique and original designs which are the property of MECCANO. They are protected by national legislation as industrial designs, trademarks and/or copyrights throughout many countries. For detailed information, please contact: MECCANO. Meccano shall have no responsibility for (I) failure to follow instructions, (II) use of parts for any purpose other than as specified in the instructions (III) any alteration of any parts or components. MECCANO respects children's safety, all models are tested by children.

F De nombreux modèles et pièces sont des créations originales, propriétés de MECCANO et sont protégés par les législations nationales sur les dessins et modèles, marques et/ou droits d'auteurs. Pour toute information, merci de contacter : MECCANO. La responsabilité de MECCANO ne saurait être engagée en cas d'accident survenu à la suite (I) du non respect des instructions de montage (II) d'une utilisation des pièces autre que celle proposée dans la notice (III) d'une altération ou de la modification des pièces. La société MECCANO respecte la sécurité des enfants : ses modèles sont testés par des enfants.

D Zahlreiche Modelle und Teile sind Erfindungen und Eigentum der Firma Meccano. Sie sind durch Inland-Gesetze über Zeichnungen und Modelle sowie Warenzeichen und/oder Urheberrechte geschützt. Für zusätzliche Auskünfte wenden Sie sich bitte an: MECCANO. Die Firma Meccano haftet nicht für Unfälle, die aus der (I) Nichtanwendung der Bauanleitung, der (II) Verwendung anderer als in der Bauanleitung angegebenen Teile oder der (III) Änderung oder Modifikation der Teile resultieren. Alle Modelle der Firma Meccano wurden von Kindern getestet und entsprechen den Sicherheitsnormen.

I Numerosi modelli e pezzi sono creazioni originali della MECCANO e sono protetti dalle legislazioni nazionali sui disegni e modelli, marchi e/o diritti d'autore. Per qualsiasi informazione, vogliate prendere contatto con: MECCANO. Meccano declina ogni responsabilità in caso d'incidenti sopravvenuti in seguito (I) al non rispetto delle istruzioni di montaggio (II) utilizzo dei pezzi per funzioni diverse da quelle previste nel manuale (III) alterazione e/o modifica dei pezzi. La società MECCANO rispetta la sicurezza dei bambini: i suoi modelli vengono testati dai bambini stessi.

E Numerosos modelos y piezas son creaciones originales, propiedades de MECCANO y están protegidos por las legislaciones nacionales en lo que concierne a los dibujos y modelos, marcas y/o derechos de autor. Para cualquier información, sírvase ponerse en contacto con: MECCANO. MECCANO carece de responsabilidad en caso de accidente debido a: (I) el incumplimiento de las instrucciones de montaje (II) una utilización de las piezas diferente a la que se indica en las instrucciones (III) una alteración o modificación de las piezas. La sociedad MECCANO respeta la seguridad de los niños: sus modelos están probados por niños.

P Vários modelos e peças são criações originais, propriedades da MECCANO e são protegidos pelas legislações nacionais relativas aos desenhos e modelos, às marcas e/ou aos direitos de autor. Para qualquer informação, é favor contactar: MECCANO. A Sociedade MECCANO não poderá ser responsabilizada pelos acidentes provocados: (I) pela falta de cumprimento das instruções de montagem (II) pelo uso indevido das peças ou (III) pela modificação ou alteração das peças. A Sociedade MECCANO respeita a segurança das crianças: os seus modelos foram testados por crianças.

GB USA Standard batteries must not be recharged. Rechargeable batteries must be removed from the toy before being recharged (if it is possible to remove them). Rechargeable batteries must only be recharged under adult supervision (if it is possible to remove them). Do not mix different types of batteries together or new with old rechargeable / non rechargeable batteries. Only batteries of the recommended type or a similar type should be used. Batteries must be fitted in accordance with their instructions. Remove used batteries from the toy. Battery terminals must not be short-circuited. Please keep instructions.

F Les piles ne doivent pas être rechargées. Les accumulateurs doivent être enlevés du jouet avant d'être chargés (s'ils peuvent être enlevés). Les accumulateurs ne doivent être chargés que sous la surveillance d'un adulte (s'ils peuvent être enlevés). Différents types de piles ou accumulateurs ou des piles ou accumulateurs neufs et usagés ne doivent pas être mélangés. Seuls des piles ou accumulateurs du type recommandé ou d'un type similaire doivent être utilisés. Les piles et accumulateurs doivent être mis en place en respectant la polarité. Les piles et accumulateurs usagés doivent être enlevés du jouet. Les bornes d'une pile ou d'un accumulateur ne doivent pas être mises en court-circuit. Indications à conserver.

D Die Batterien dürfen nicht wieder aufgeladen werden. Die Akkus müssen vor dem Nachladen aus dem Spielzeug genommen werden (wenn sie ausgebaut werden können). Die Akkus dürfen nur unter Aufsicht eines Erwachsenen nachgeladen werden (wenn sie ausgebaut werden können). Unterschiedliche Arten von Batterien und Akkus oder neue und gebrauchte Batterien bzw. Akkus dürfen nicht zusammen verwendet werden. Es dürfen nur Batterien bzw. Akkus der empfohlenen Art oder einer ähnlichen Art verwendet werden. Beim Einsetzen der Batterien bzw. Akkus auf die richtige Polung achten. Verbrauchte Batterien bzw. Akkus bitte aus dem Spielzeug entfernen. Die Klammern der Batterien bzw. Akkus dürfen nicht kurzgeschlossen werden. Diese Anweisungen bitte aufbewahren.

I Le pile non devono essere ricaricate. Gli accumulatori devono essere tolti dal giocattolo prima di essere caricati (se è possibile toglierli). Gli accumulatori devono essere caricati solo sotto la sorveglianza di un adulto (se è possibile toglierli). Non possono essere mescolati tipi diversi di pile o di accumulatori oppure pile o accumulatori nuovi e usati. Si devono usare solo pile o accumulatori del tipo raccomandato o di un tipo simile. Le pile e gli accumulatori devono venire sistemati rispettando la polarità. Le pile e gli accumulatori usati devono essere tolti dal giocattolo. I morsetti di una pile o di un accumulatore non devono essere messi in cortocircuito. Conservare queste istruzioni.

E Las pilas no deberán recargarse. Habrá que retirar los acumuladores del juguete antes de proceder a recargarlos (si es que pueden retirarse). Los acumuladores sólo se recargarán bajo la vigilancia de una persona adulta (si es que pueden retirarse). No deberán mezclarse diferentes tipos de pilas o acumuladores o de pilas o acumuladores nuevos y usados. Sólo se utilizarán pilas o acumuladores del tipo recomendado o de un tipo similar. Las pilas y acumuladores deberán colocarse respetando la polaridad. Deberán retirarse del juguete las pilas y acumuladores usados. Los bornes de una pila o de un acumulador no deberán disponerse nunca en posición de cortocircuito. Conservar estas indicaciones.

P As pilhas não devem ser novamente carregadas. Os acumuladores devem ser removidos do brinquedo antes de serem carregados (caso possam ser removidos). Os acumuladores devem ser carregados apenas sob cuidados de um adulto (caso possam ser removidos). Diferentes tipos de pilhas ou acumuladores ou pilhas ou acumuladores novos já utilizados não devem ser misturados. Pilhas ou acumuladores do tipo recomendado ou de um tipo similar poderão ser utilizados. As pilhas e acumuladores devem ser inseridos, respeitando a polaridade. Devem ser removidos do brinquedo as pilhas e acumuladores já utilizados. Os polos de uma pilha ou de um acumulador não devem ser curto-circuitados. Indicações a conservar.

S Många modeller och delar bildar en unik och originell formgivning vilken är MECCANO egen. Dessa modeller och delar är skyddade genom lagstiftning såsom industriell formgivning, varumärks och/eller upphovsmanrätt i ett flertal länder. För mer detaljerad information, var vänlig och kontakta MECCANO. MECCANO fräntar sig allt ansvar i händelse av olycka till följd av (I) att monteringsinstruktionerna inte har respekterats (II) en annan användning av delarna än den som står i anvisningen (III) en förvarskning eller förändring av delarna. Företaget MECCANO respekterar barnsäkerheten: modellerna har testats av barn.

FIN Useat mallit ja osat ovat MECCANO:n omaisuutta olevaa alkuperäistä suunnittelua. Ne ovat kansallisia lailla suojattua teollista tuotantoa, tavaramerkkejä ja/tai kopiointioikeuksia. Pyydämme ottamaan yhteyden MECCANO:han kaikissa asioissa liittyvissä kysymyksissä. MECCANO ei vastaa eikä kata seuraavista syistä sattuneita onnettomuuksia: (I) ohjeiden vastainen kokoaminen, (II) muiden kuin ohjeissa ehdotettujen osien käyttö, (III) osien muuttelu tai eri tarkoituukseen käyttö. MECCANO-välikie huolehtii lasten turvallisuudesta: lapset ovat testanneet mallimme.

DK Vore mange modeller og deler er originale fremtallinger og ejes af MECCANO. Tegninger, modeller, fabrikmærker og ophavsret er lovbeskyttede i versl land. Yderligere oplysninger kan fås hos: MECCANO. MECCANO frsiger sig ethvert ansvar, sfrmt der er sket uheld forrsaget af (I) at monteringsinstruktionerne ikke er blevet overholdt, (II) at delene er blevet brugt til andre form, end dem der er beskrevet i betjeningsvejledningen, (III) eller at delene er blevet beskadiget eller ændret. MECCANO overholder sikkerhedsreglerne for børn. Alle modeller testes af børn.

NL Vre modellen en onderdelen zijn originele ontwerpen en eigendom van MECCANO en worden beschermd door de nationale wetgevingen op tekeningen en modellen, merken en/of auteursrechten. Voor informatie gelieve contact te nemen met MECCANO. De verantwoordelijkheid van MECCANO is uitgesloten in geval van ongevallen voortvloeiend uit het niet naleven van de montage-instructies (I), uit het gebruik van andere onderdelen dan die zoals vermeld in de handleiding (II) of uit het veranderen of modificeren van de onderdelen (III). De firma MECCANO neemt de veiligheid van de kinderen in acht: de modellen zijn door kinderen getest.

GR Πολλά μοντέλα και ανταλλακτικά είναι αυθεντικά, ιδιοκτησία της MECCANO και προστατεύονται από τις εθνικές νομοθεσίες για τα μοντέλα της μάρκας ή/και διπλώματα ευρεσιτεχνίας για κάθε πληροφορία. Για κάθε πληροφορία παρακαλούμε απευθυνθείτε στη MECCANO. Η ευθύνη της MECCANO δεν δεσμεύεται σε περίπτωση ατυχήματος που έγινε συνέχεια (I) μη σεβασμού των οδηγίων συναρμολόγησης (II) χρήσης των τεμαχίων διαφορετικά από αυτά που προτείνονται στις οδηγίες (III) καταστροφής ή αλλαγής των τεμαχίων. Η εταιρεία MECCANO σεβεται την ασφαλία των παιδιών: τα μοντέλα της δοκιμάστηκαν από παιδιά.

JPN モデルからびて部品は、その多くがMECCANO社所有のオリジナル・デザインで、商標・商標および/または著作権に関する国内法によって保護されています。詳細については、当社(MECCANO)メカノ社は(III)注意の注意事項を守らなかった場合、(II)使用説明書に記載されたものの外装部品を使用した場合、(I)部品を改造・改造した場合などに起きた事故については責任を負うことはできません。メカノ社の全モデルは事前に子供たちによりテストを行い、その安全性を確認されております。

S Batterierna skall inte laddas om. Akkumulatörbatterierna skall tas av från lekens innan de laddas (om de kan tas av). Akkumulatörbatterierna skall endast laddas under uppsikt av en vuxen (om de kan tas av). Olika typer av batterier eller akkumulatörbatterier skall inte blandas. Nya och använda batterier eller akkumulatörbatterier skall inte blandas. Använd endast rekommenderade typer eller likartade typer av batterier eller akkumulatörbatterier. Batterierna och akkumulatörbatterierna skall sättas i med hänsyn till polerna. Använda batterier och akkumulatörbatterier skall tas av från lekens. Kontakterna på ett batteri eller ett akkumulatörbatteri skall inte kortslutas. Bevara anvisningarna.

FIN Paristoja ei saa ladata uudelleen. Akut on otettava ulos leikkikalusta ennen lataamista (jos se on mahdollista). Akut saa ladata vain aikuisen valvonnassa (jos ne voidaan ottaa ulos). Erityisesti paristoja tall akkuja ei saa käyttää yhdessä, samoin ei saa sekoittaa akkuja ja uusia ja vanhoja paristoja. Vain suositeltuja akku- tai paristoluokkia saa käyttää tyyppijä, jolla on samat ominaisuudet. Paristo ja akut on asetettava paikoilleen, eikä nevali tavottei oikeisiin suuntiin. Loppuikäiset paristot tai akut on otettava leikkikalusta ulos. Akut tai pariston nappoja ei saa koskettaa. Ohjeet on pidettävä tallessa.

DK Batterierne må ikke oplades. Akkumulatörbatterierne skal tages ud af legetøjet, inden de lades op (hvis de kan tages ud). Akkumulatörbatterierne må kun lades op under opsyn af voksne (hvis de kan tages ud). Forskellige typer batterier og akkumulatörbatterier, eller nye og brugte batterier, må ikke blandes sammen. Der må kun anvendes batterier eller akkumulatörbatterier af den type der er anbefalet eller tilsvarende modeller. Batterier og akkumulatörbatterier skal vendes rigtigt (+/- poler). Brugte batterier og akkumulatörbatterier skal tages ud af legetøjet. Klammene på et batteri eller et akkumulatörbatteri må ikke kortslutes. Disse instruktioner bør opbevares.

NL De batterijen mogen niet weer opgeladen worden. De accu's moeten voor het laden uit het speelgoed verwijderd worden (indien ze verwijderd kunnen worden). Gebruik geen verschillende typen batterijen of accu's of gebruikte en nieuwe batterijen of accu's door elkaar. Gebruik alleen batterijen of accu's van het aanbevolen type of van een gelijkwaardig type. Niet meng verschillende typen van de batterijen en accu's goed op de juiste polariteit. De verbuikte batterijen en accu's dienen uit het speelgoed verwijderd te worden. De aansluitingen van een batterij of van een accu mogen niet kortgesloten worden. Aanwijzingen om te bewaren.

GR Οι μπαταρίες δεν πρέπει να επαναφορτίζονται. Οι συσσωρευτές πρέπει να αφαιρούνται από το παιχνίδι πριν τη φόρτιση (εάν μπορούν να αφαιρεθούν). Οι συσσωρευτές πρέπει να φορτίζονται μόνον υπό την επίβλεψη ενήλικα (εάν μπορούν να αφαιρεθούν). Δεν πρέπει να ανακατεύονται διάφοροι τύποι μπαταριών ή συσσωρευτών ή μπαταριών ή συσσωρευτών καινούριων και παλιών. Πρέπει να χρησιμοποιούνται μόνον μπαταρίες ή συσσωρευτές του συστήματος παιχνιδιού ή παιχνιδιού τύπου. Οι μπαταρίες και οι συσσωρευτές πρέπει να τοποθετούνται ομοίωμα με τη σωστή πόλωση. Οι παλιές μπαταρίες και οι παλιές συσσωρευτές πρέπει να αφαιρούνται από το παιχνίδι. Οι παλιές μπαταρίες ή ένας συσσωρευτής δεν πρέπει να βραχυκυκλώνονται. Διατηρήστε τις οδηγίες.

JPN 電池は充電しないで下さい。蓄電池は充電する前に玩具から取り外して下さい(玩具から取り外せるようになっている場合)。蓄電池の充電は必ず大人のいるところで行って下さい(玩具から取り外せるようになっている場合)。電池や蓄電池は、使用前、使用済、あるいは異なる種類のものなどを混ぜておかないで下さい。電池や蓄電池は、指定の種類またはそれに類似したものの以外は使わないで下さい。電池や蓄電池をセツトする時には、陽極と陰極の向きをよく確認します。使用済の電池や蓄電池は玩具から取り出して下さい。電池や蓄電池の極はショートしないよう取り扱ひに注意して下さい。この説明書は保存しておいて下さい。

USA Do not mix old and new batteries. Do not mix alkaline, standard (carbon-zinc), or rechargeable (nickel-cadmium) batteries.



363, avenue de Saint Exupéry
62100 Calais - France
<http://www.meccano.com>
©11/2006 MECCANO

®MECCANO and ERECTOR are exclusive trademarks of MECCANO
All rights reserved

