

Simplified . . .

. . . Mechanics.

**A Constructional Mechanical
Toy.**

THIS INVENTION HAS FOR ITS OBJECT
THE TRAINING OF THE YOUNG IN
MECHANICAL CONSTRUCTION.

PATENTED.

— COPYRIGHT. —

SIMPLIFIED MECHANICS.

A CONSTRUCTIONAL MECHANICAL TOY.

This toy comprises a variety of mechanical parts, which, by the aid of the drawings and directions furnished, are adapted to be built up into a number of interesting working models and structures, such as :—WAGGONS, RAILWAYS, TRUCKS, CRANES, BRIDGES, ELEVATORS, TOWERS, and the like objects of interest. No tools are necessary beyond the appliances supplied, and no turning or machining is necessary, so that the toy is well adapted for parlour use.

The natural bent of most children's minds is constructional—to make something, especially **something which will work**, is one of their chief pleasures; most of the toys they have are already made, and too frequently the only way in which children can exercise their ingenuity is in the negative manner of trying to take the toy to pieces—usually with disastrous results.

Building blocks to some extent meet the child's need, but the structures made with bricks are not portable, and, above all, they do not **work**, and at the best, the exercise given is in one direction only, viz., building with bricks. The present toy, however, comprises all the main mechanical parts used in machines, such as levers, beams, wheels, axles, pulleys, wormwheels, screws, bolts, keys, &c., and the graduated series of examples given are designed to gradually train the child's mind in the mechanical principles involved in various machines and structures.

It is believed that not only is the knowledge gained in this way useful, but that educationally the training thus afforded is most valuable in developing the reasoning faculties, and tending in quite a pleasurable way to cultivate ingenuity, resourcefulness and method.

All parts are made to gauge, and the necessity for accuracy of work is clearly taught.

An almost endless variety of models may be built; the parts are of metal and almost unbreakable; and when one structure is finished the same parts can be used repeatedly for different structures.

Parents will find co-operation with the children an interesting and stimulating exercise, and in many instances a pleasant mode of exercising their own inventive faculties.

SIMPLIFIED MECHANICS.

INSTRUCTIONS.

This Toy is made up in the following boxes :—X, A, B, C, D and E.

Each box is complete in itself and contains all the parts necessary to construct the models as indicated below.

7101 Oulful 2 3 4 5 6	X A B C D E	Box ,, ,, ,, ,, ,,	makes models ,, ,, ,, ,, ,,	1 to 13 to 30 to 40 to 50 to 60 to	8-10 20 35 37 43 44 52 55 61
--------------------------------------	----------------------------	-----------------------------------	--	--	--	---	--

A series of supplementary Boxes X₁, A₁, B₁, and C₁ is arranged to form a connection between each of the above boxes, for example :—Those who have purchased the Box X in the first instance, may, by purchasing the supplementary Box X₁, obtain all the parts contained in the Box A; the Box X and the Box X₁ containing together all the parts found in the Box A. Again, those who have purchased Box A in the first instance, may, by purchasing the supplementary Box A₁, obtain all the parts contained in the Box B; the Box A, and the Box A₁, containing together all the parts found in Box B. In the same way the Boxes X, X₁, and A₁ contain all the parts found in the Box B. The Boxes B₁ and C₁ follow in the same order.

The supplementary boxes also admit of elaborations in the designs of the previous models.

The contents of each box are shown in tabular form at the end of the book, and by the arrangement of the supplementary boxes as above indicated, all the boxes may be purchased either at once or successively, and in the latter case without any unnecessary expense in overlapping parts.

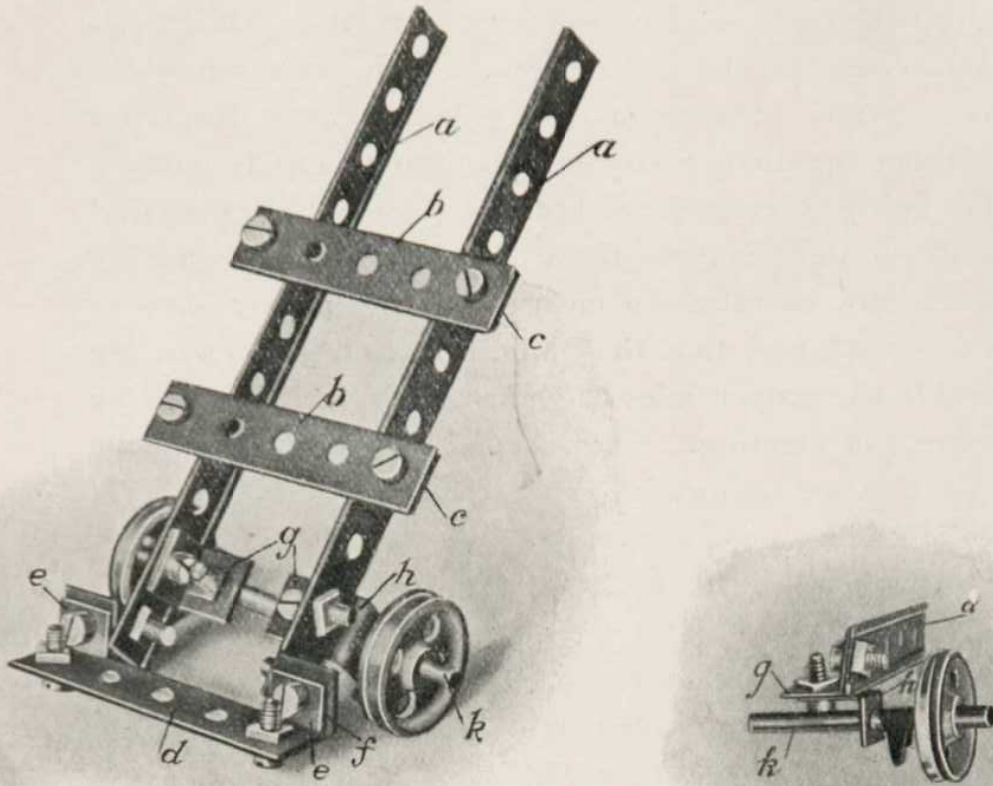
The designs given have been very accurately prepared from the actual structures themselves, and if in assembling the parts care be taken to ensure that the proper sizes of strips are used, and that the bolts, brackets, and axles are attached to the proper holes as shown, little difficulty will be experienced in erecting. Care should be taken to count the holes, as they are uniformly spaced throughout, and so form a most excellent guide in erecting.

The simple designs should in all cases be proceeded with first, and skill gradually acquired in following the designs and correctly connecting the parts together. Strips, when they require to be attached at right angles to each other, are attached by means of the angle brackets and screws and nuts, the nuts being preferably on the inside. The axles are adapted to fit any of the holes, and their positions in the various designs can always be ascertained by counting the holes.

Successive lengths of strips may be united together by means of one or, where a very rigid connection is required, two bolts.

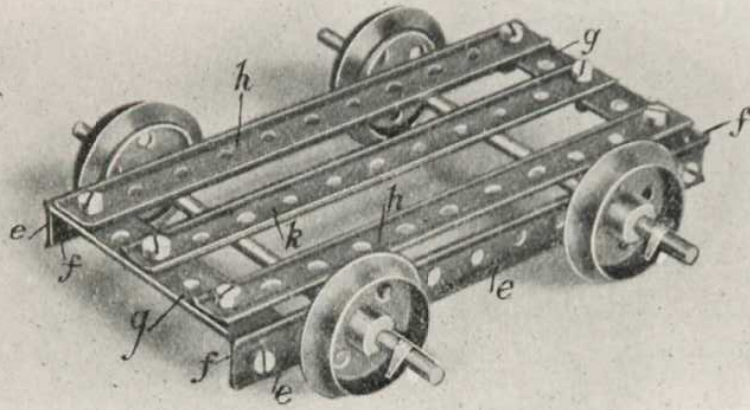
Several of these models require the strips to be bent. This can be conveniently done by the hands. They may afterwards be straightened out without injury. In bending the strips, it is always desirable to work systematically and not hap-hazard, for example:—In constructing the rim of a wheel, ascertain the diameter, and then describe a circle on some flat surface, bending the strips to correspond.

A board 6 feet long, 9 inches wide, and $\frac{3}{4}$ inch thick will be found very useful in the construction of those models which require to be securely fastened.



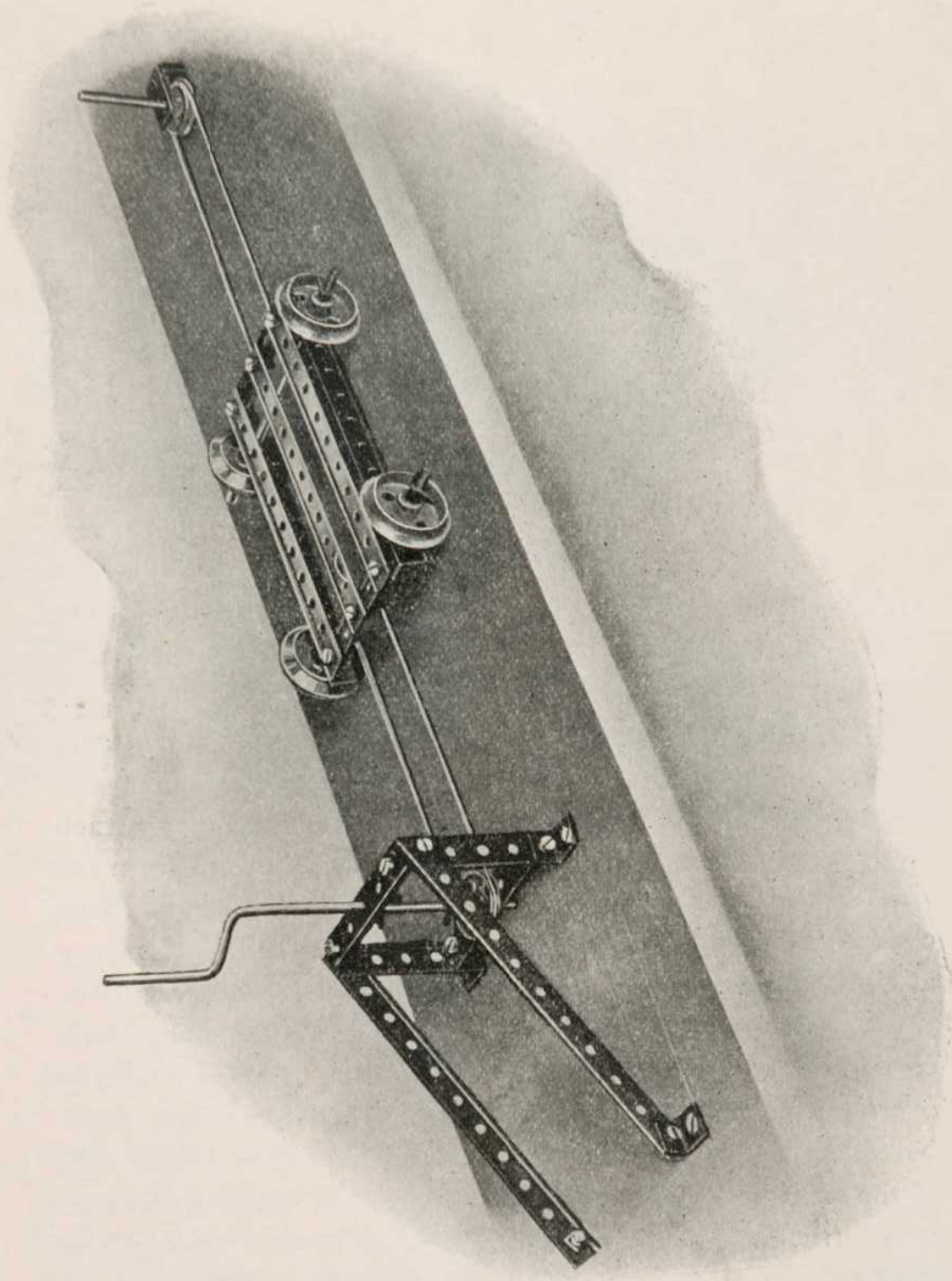
No. 1. LUGGAGE TRUCK.

In constructing this example, the two side frames *a* should, in the first place, be connected to the cross pieces *b* by means of four angle pieces *c*, advantage being taken of the slots in the latter to give a slight play to the frames as indicated in the drawing. The lowest cross piece *d* may then be carried from the end holes of the frames *a* by a combination of the two angle pieces *e f* at each end, and the bearings for the wheel axle are each somewhat similarly constructed of two angle pieces *g h*, as will be readily understood by referring to the small detail view. When these are in place the axle *k* is inserted, keys *l* put over the ends, and the wheels secured thereon.



No. 2. TRUCK

To construct this design, take a $5\frac{1}{2}$ in. strip *e* and attach, by means of screws and nuts, an angle piece *f* at each end. Then take a second $5\frac{1}{2}$ in. strip, and in the same way attach angle pieces at each end of it. These strips are to form the sides of the truck in which the axles of the wheels run. Now connect each end pair of angle pieces with two $2\frac{1}{2}$ in. strips *g* at right angles to the $5\frac{1}{2}$ in. strips forming the sides, and over these short strips *g* lay two $5\frac{1}{2}$ in. strips *h*, fastening each corner of the truck, where the ends of the strips *h* and *g* overlap the angle pieces *f*, by means of screws and nuts. Now attach the $5\frac{1}{2}$ in. piece *k* at each end to the centre hole of the strips *g*. This, with the two pieces *h*, forms the bottom of the truck. Next insert two axles, as shown, through the third holes from the ends of the side pieces *e*. Then push on the four wheels, and secure them in position by the keys by pushing the feather of the key along the groove in the axle and through the key-way in the wheels. These feathers serve to keep the wheels in position.



No. 3. ENDLESS ROPE RAILWAY.

In this example, the truck made according to the previous design is used, and it is connected to an endless cord which passes from a pulley attached to the board to another

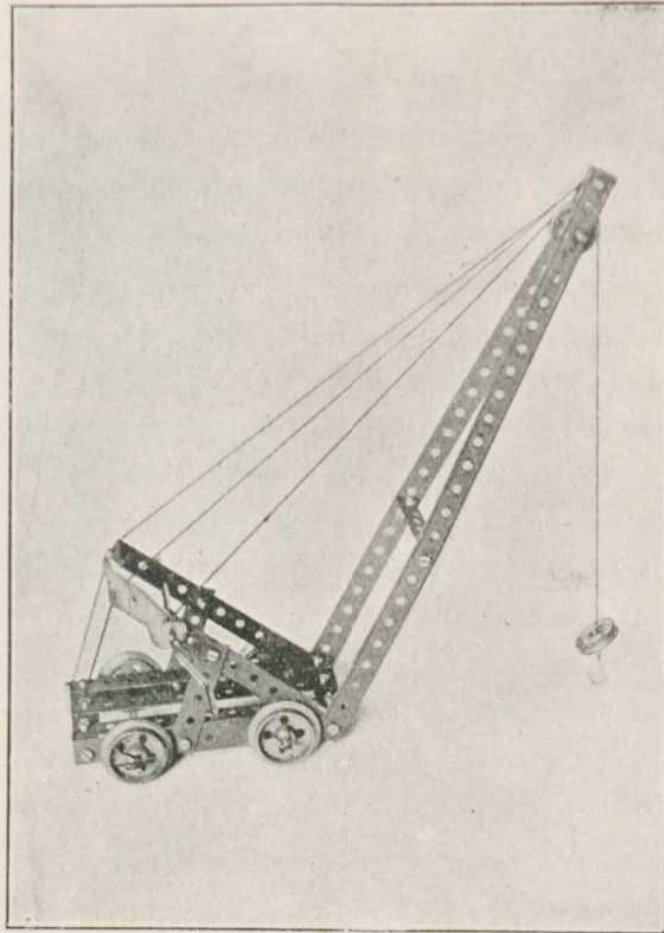
No. 3—*continued.*

pulley and shaft carried on the bracket shown. In the illustration, the two pulleys are shown close together to save space, but they may, of course, be placed at any distance desired.

The bracket is constructed as follows:—Two vertical $2\frac{1}{2}$ in. side pieces are connected together at the top and bottom by two more $2\frac{1}{2}$ in. pieces attached by angle pieces as shown. From the angle pieces at the top, two $5\frac{1}{2}$ in. pieces are carried down to two angle pieces screwed to the board as shown, and angle pieces are placed at the feet of the uprights, which are also screwed to the board. The pulley is keyed to the vertical spindle, which is threaded through the central holes of the two $2\frac{1}{2}$ in. cross pieces, and a second pulley, attached to a U shaped piece as shown, is screwed opposite to the bracket.

A piece of string is then formed into an endless rope running over the two pulleys, and the truck is attached to one side of the string, so that by rotating the handle in one direction or another, the truck is moved as desired.

No. 4. TRAVELLING JIB CRANE.

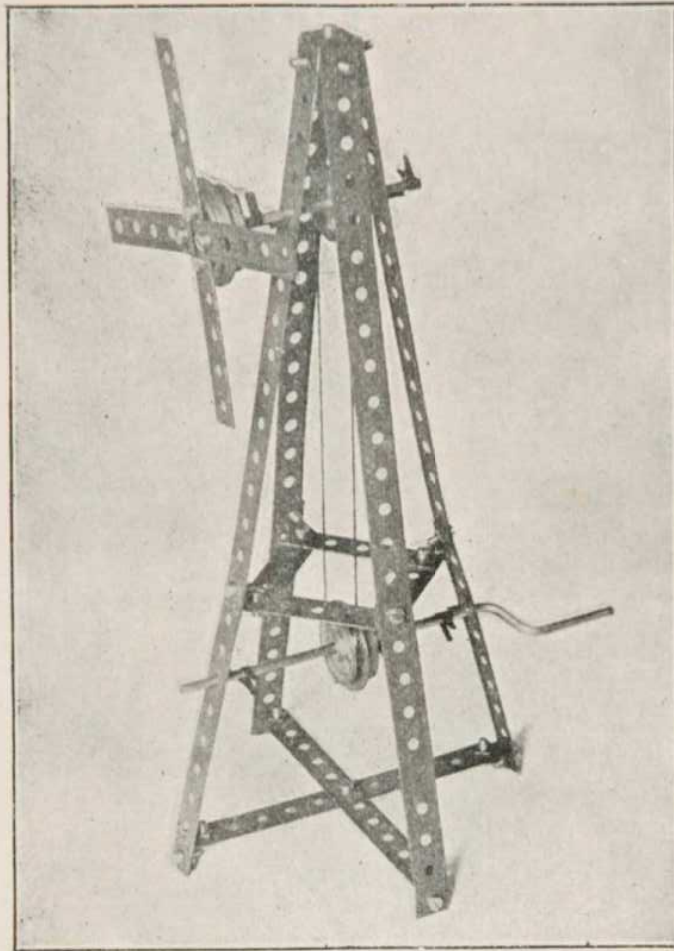


The truck of Example 2 is used in the construction of the crane, with the following additions :—

Two $5\frac{1}{2}$ in. strips sloping back to carry the spindle, and two $12\frac{1}{2}$ in. strips to form the jib, are attached by the same screws to the end holes of the truck ; the two $5\frac{1}{2}$ in. strips being braced to the truck by the two $2\frac{1}{2}$ in. strips as shown, and being connected together at their ends by a $2\frac{1}{2}$ in. strip and angle pieces.

The spindle, to which the pinion is keyed, is carried in the third pair of holes in the $5\frac{1}{2}$ in. strips as shown, and the pawl is pivoted on the screw which holds the angle piece in position.

The jib is braced by a $2\frac{1}{2}$ in. strip and angles at the ninth hole from the end, and the two sides are bolted together at the top hole, and the short spindle carrying the pulley is carried in the third hole from the top, over which pulley the string is passed and tied to the pinion spindle ; the whole structure is braced by tie rods formed of strings attached to the ends of the truck, the $5\frac{1}{2}$ in. strips, and the jib.

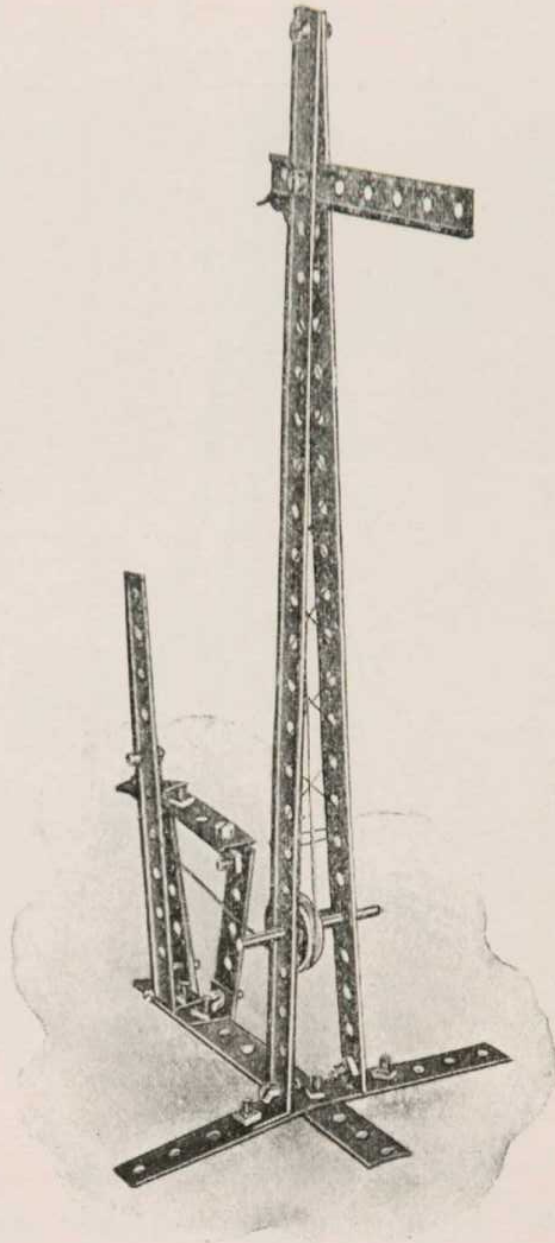


No. 5. WINDMILL.

This model will not be described quite so fully as the preceding ones, in order that its construction may be a test for the young model-maker, and be of use in developing his faculties for constructional work.

It will suffice to say that the four $12\frac{1}{2}$ in. strips are formed at the top by four angle pieces, and are stiffened lower down by the four $2\frac{1}{2}$ in. strips formed into a square, the corners of which are connected by angle pieces to the $12\frac{1}{2}$ in. strips.

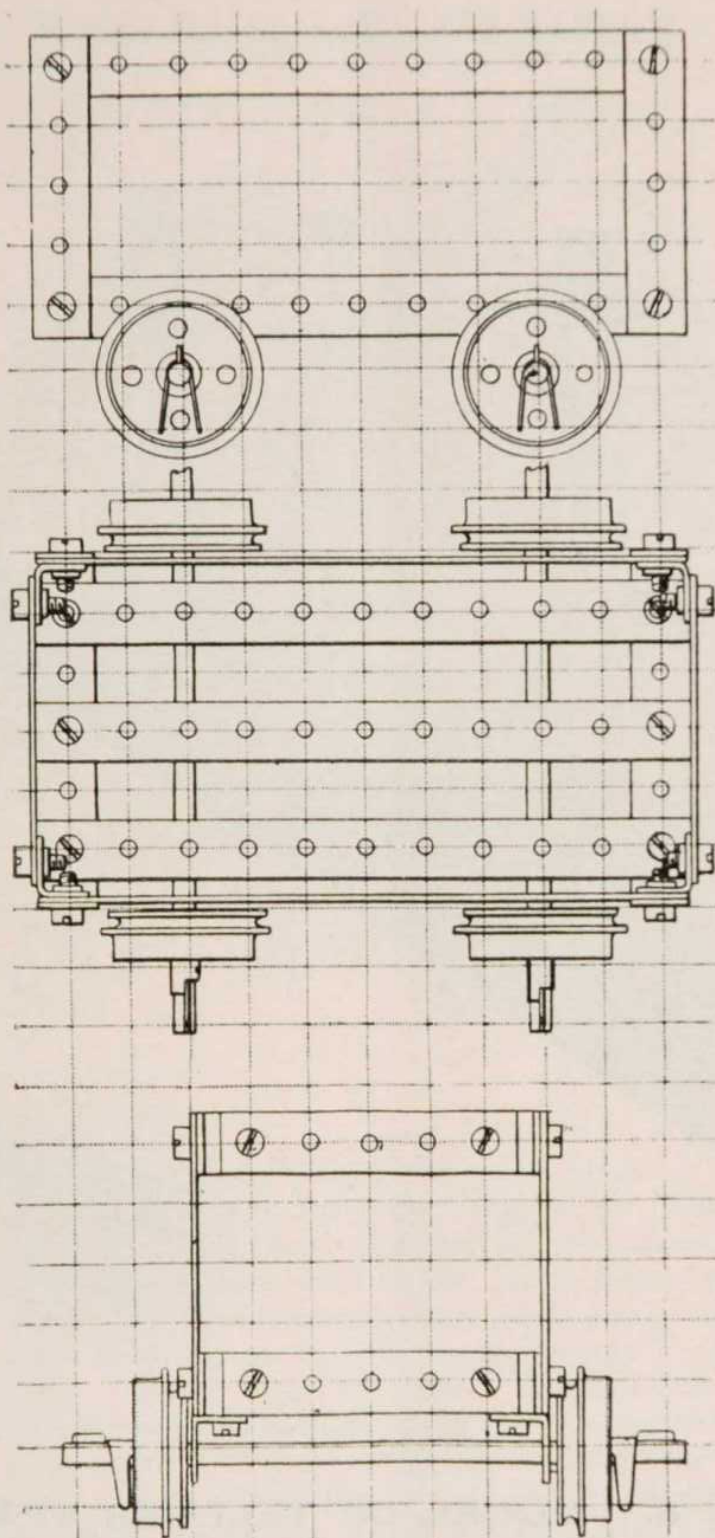
The wind sails are made by attaching four $2\frac{1}{2}$ in. strips to the flanged wheel, and keying the latter to the spindle. Note.—This spindle has a second pulley on the frame connected by the string band to the pulley on the spindle below.



No. 6. RAILWAY SIGNAL.

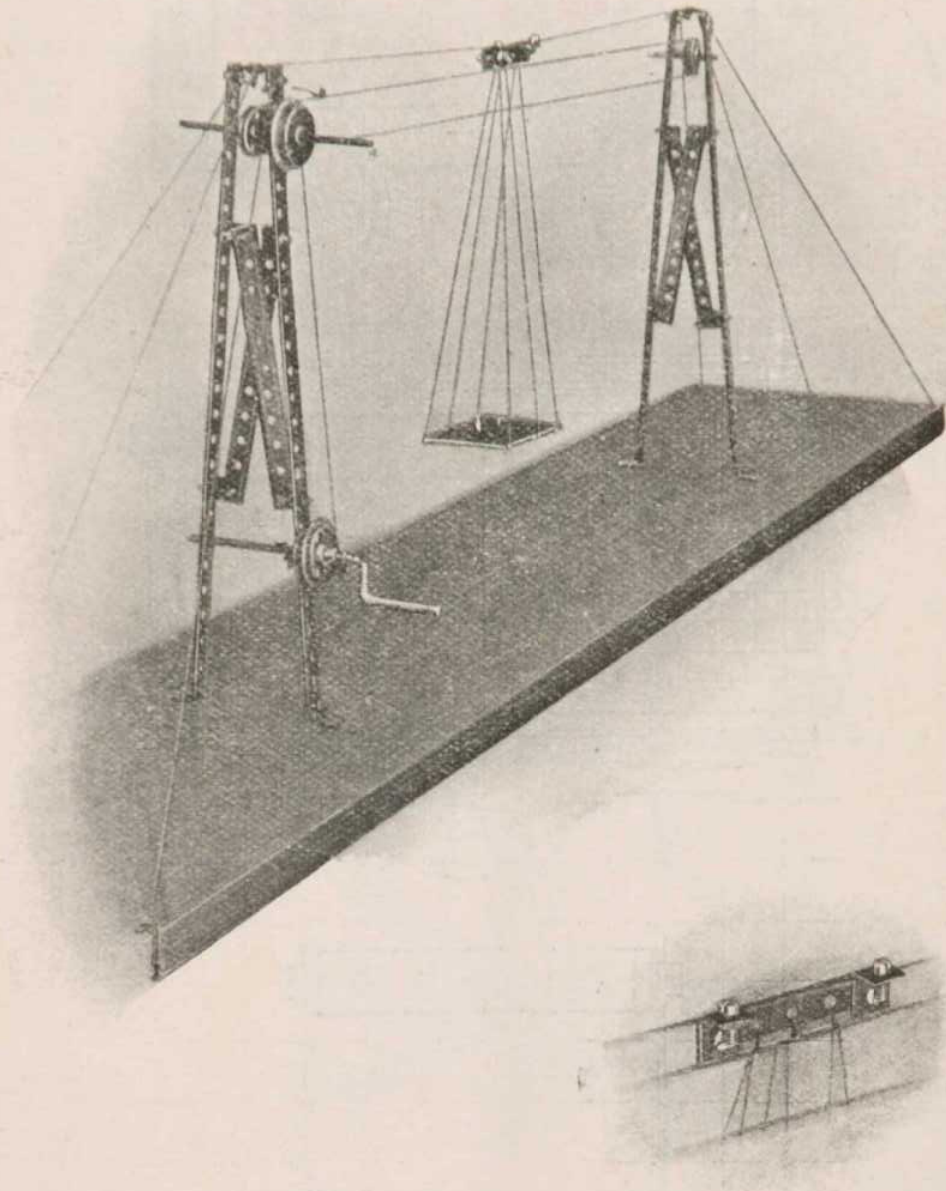
Very little difficulty will be found in constructing this model after Model 5 has been accomplished. It will therefore form another test for the young model-maker.

In fixing the lever, lock the nuts to prevent the screws working out.



No. 7. TRUCK.

This illustration is of a truck constructed in a similar manner to the foregoing models. It is intended in this to give an example of the actual kind of drawing that an engineer would make to represent such a model. Fig. 1 would be called an elevation, Fig. 2 a plan, and Fig. 3 an end view of the truck. It will be noticed that the views are on squared paper, and the elevation and plan are projected from each other, as should be the case with all views on an engineering drawing.

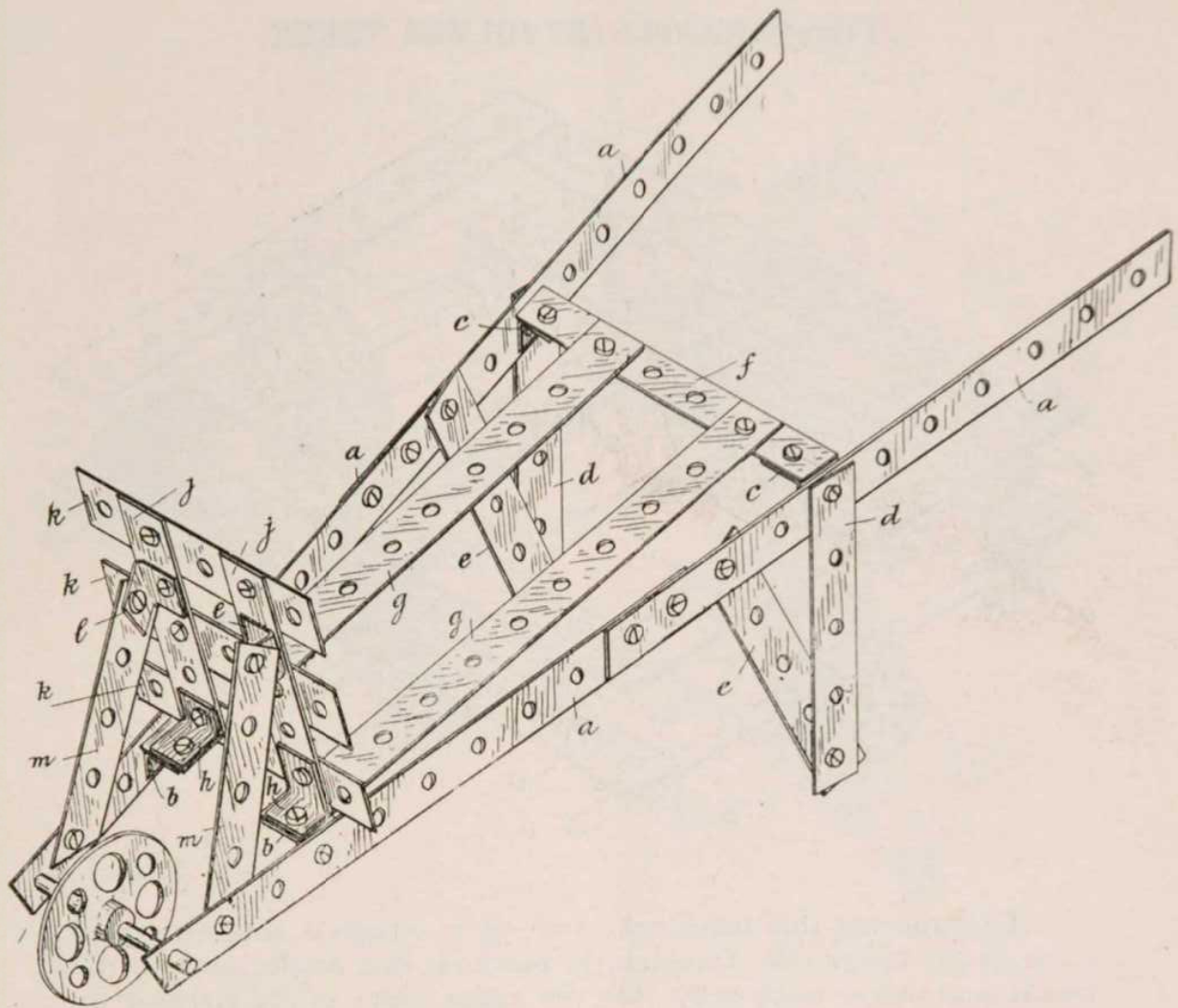


No. 8. MODEL OF TELPHER SPAN.

The construction of this model will be facilitated if the standards are screwed down before connecting the cords.

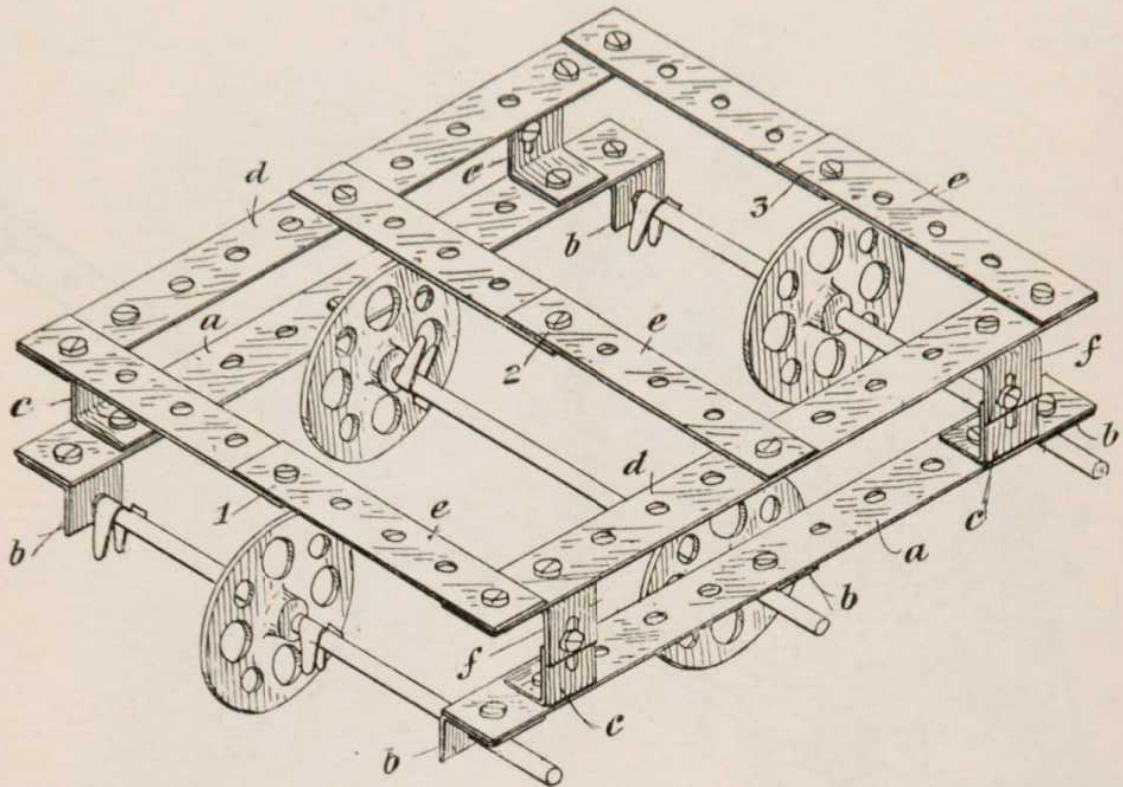
The crank pulley cord should be wound twice around the pulleys so as to ensure a better grip.

Figure No. 13. LUGGAGE BARROW.



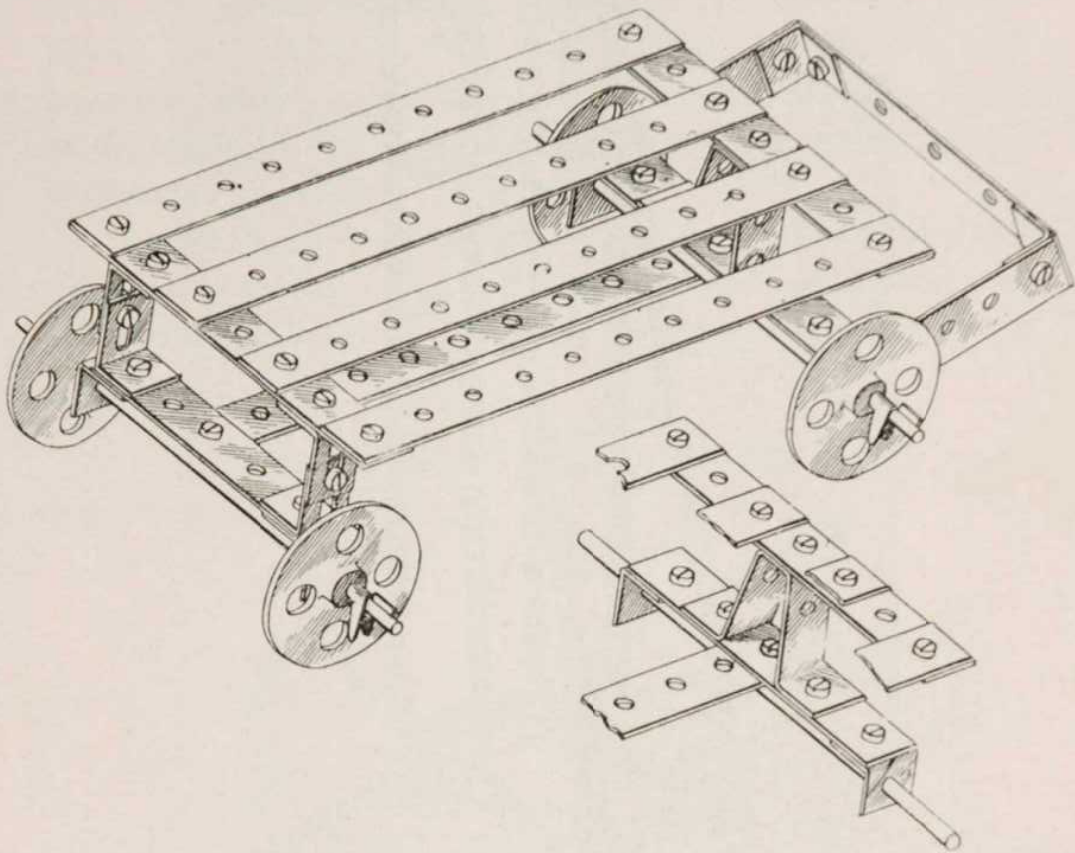
To construct this design, take two $5\frac{1}{2}$ in. strips *a*, and connect them together by screws to form one long strip. Then take two other strips and fasten them together in the same way. Next secure an angle piece *b* in each at the fourth hole from one end. Then, at the seventh hole from the other end, secure by the screw and nut shown, an angle piece *c* on the inside and a $2\frac{1}{2}$ in. strip *d* on the outside. These form the legs. Next put in the stays *e* connecting them from the bottom of the legs to the ninth hole from the end. Next connect the two angle pieces *c* by two overlapping $2\frac{1}{2}$ in. strips *f*. Then attach the two $5\frac{1}{2}$ in. strips *g* as shown to the angle pieces *b*, fitting the angle pieces *h* above the strips *g*. Next attach the two upright pieces *j* to the angle pieces, placing in position at the same time the three cross strips *k* as shown. Then attach the angle pieces *l* to the second holes from the top of the upright pieces *j*, and connect these by the stays *m* to the sides of the barrow. Then insert a 2 in. piece of the axle with the wheel on the centre, the wheel being held in place by two keys which have their feathers turned away from the wheel, and thus form collars between which the wheels can rotate.

Figure No. 14. REVOLVER TRUCK.



To construct this truck take two $5\frac{1}{2}$ in. strips *a*, and attach to each on the lower side three angle pieces *b*, one angle piece in the centre and one at each end. On the upper sides of the strips *a* fix two other angle pieces *c* in the holes next to those just utilized. Now take two $5\frac{1}{2}$ in. strips *d*, and to each of these attach three $2\frac{1}{2}$ in. strips *e* by screws and nuts, one strip at each end of the strips *d*, and one in the middle. Now bring these two pieces together, so that the holes 1, 2, 3 coincide, then bolt the strips together by inserting screws and nuts through these holes. To the framework so formed attach four angle pieces *f* to the last hole but one in the $5\frac{1}{2}$ in. strips *d*. Now bring the upper and lower frames together until the slots in the eight angle pieces coincide, and then bolt them together with screws and nuts. Now insert a 5 in. axle piece through each end pair of angle pieces *b*, fixing wheels in the centre of these axles, and also putting on keys near each angle piece, so as to prevent the axle moving endwise. Insert another 5 in. axle through the middle angle pieces, fixing two wheels in this case by means of keys at each end near the angle pieces. Either flanged or bushed wheels may be used in the construction of this model.

Figure No. 15. RAILWAY WAGGON.

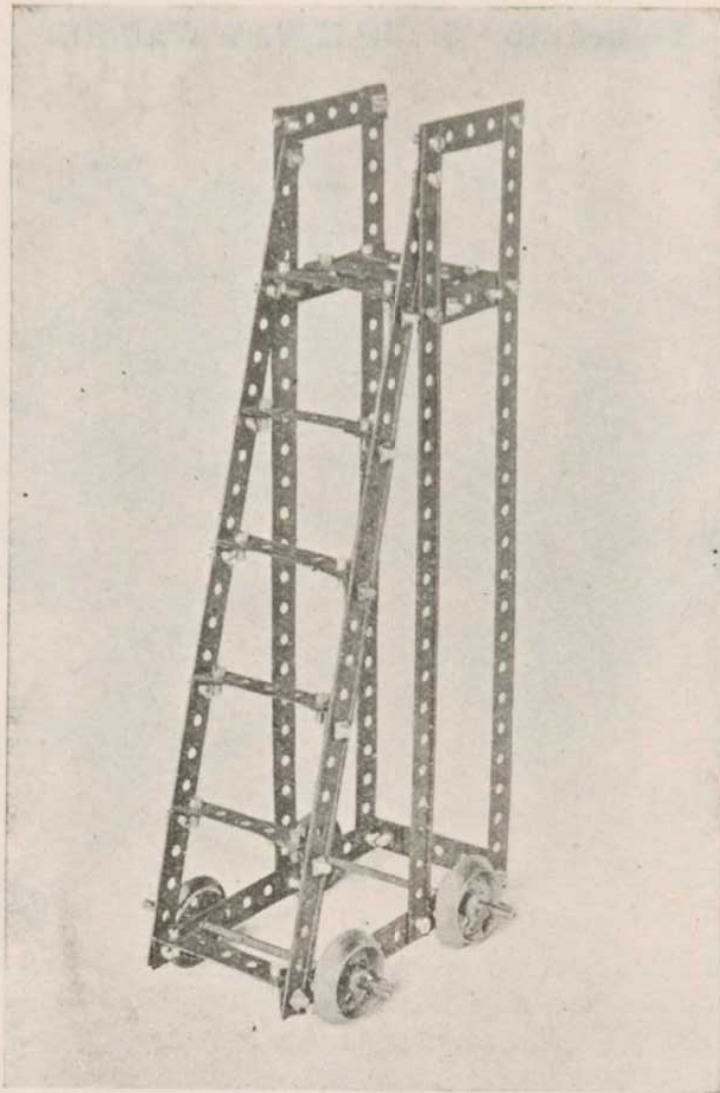


The top platform of this model will present no difficulty. It is formed by screwing four $5\frac{1}{2}$ in. strips to two end pieces of $3\frac{1}{2}$ in. long.

The front swivelling support, of which a separate detail view is given, is formed from a $2\frac{1}{2}$ in. strip bent to the shape indicated in the drawing.

The rear axle frame is formed from a $2\frac{1}{2}$ in. strip, and is held to the platform by two pairs of angle pieces. Both axles are carried in inverted angle pieces.

Figure No. 16. LADDER ON WHEELS.

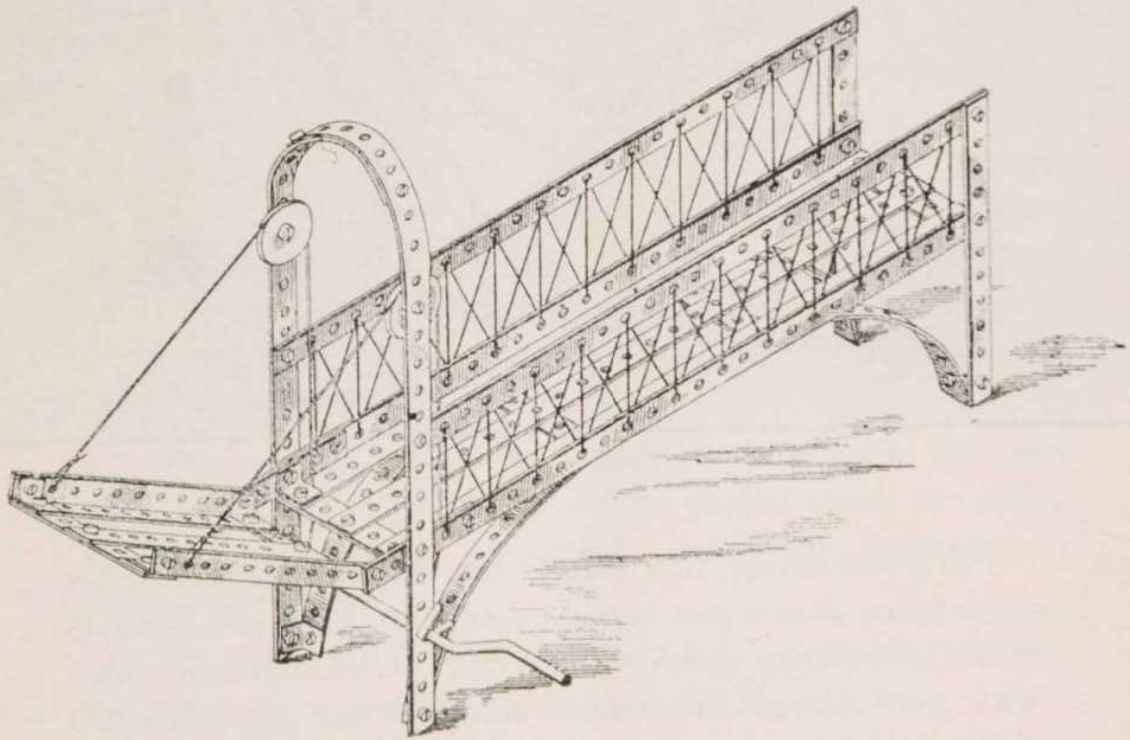


This model is formed by taking two $12\frac{1}{2}$ in. strips and connecting them at the upper ends with a $2\frac{1}{2}$ in. strip; then in the sixth hole down attaching another $2\frac{1}{2}$ in. strip, and at the lower ends a $5\frac{1}{2}$ in. strip, connecting one of the ends with the end hole of the $5\frac{1}{2}$ in. strip, at the same time attaching an angle piece, and the end of the other one with the fifth hole. Another $12\frac{1}{2}$ in. strip is then taken, one end being attached to the second hole from the top of one of the previous $12\frac{1}{2}$ in. strips, and the lower end to the end of the $5\frac{1}{2}$ in. strip, attaching an angle piece. Two angle pieces are then connected with the second $2\frac{1}{2}$ in. strip as shown in the illustration, forming the top step. This will now form one side of the ladder. The other side is formed in the same manner, with the exception that the order is reversed. These two sides are then brought together and connected by a $2\frac{1}{2}$ in. strip at the lower part of the back of the ladder, and one at the lower

part of the front of the ladder, forming the first step. The upper part is connected by two $2\frac{1}{2}$ in. strips to the angle pieces already placed in position forming the top step. To form the remaining steps, commence by attaching angle pieces, with the elongated holes outward, in the fifth hole from the bottom, and each fourth hole afterwards on each side of the sloping strips. $2\frac{1}{2}$ in. strips are then fastened to these, completing the steps.

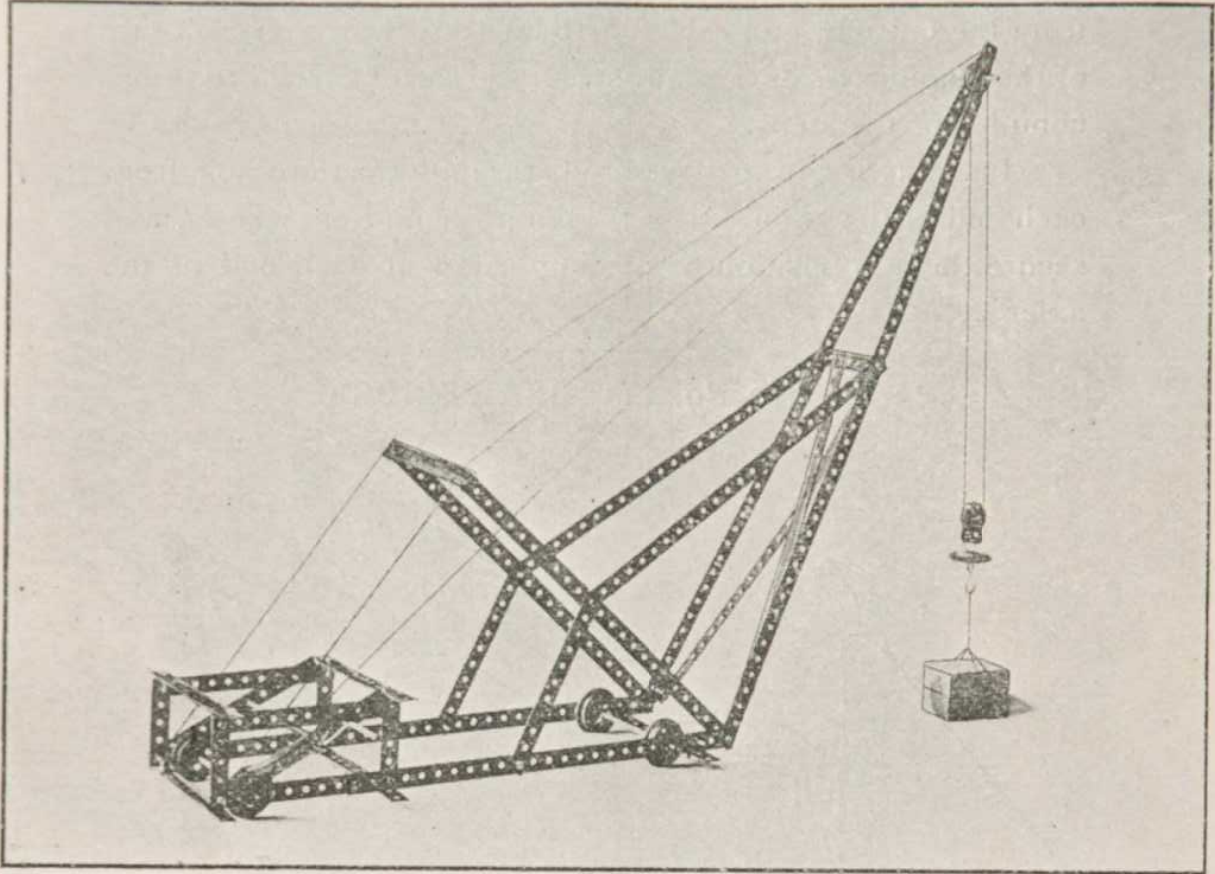
Insert two 5 in. grooved rods through the third hole from each end of the $5\frac{1}{2}$ in. strips; then push on four wheels, and secure them in position by placing a key at each end of the axles.

Figure No, 17. DRAWBRIDGE.



First make the floor of the bridge out of three $12\frac{1}{2}$ in. strips and four $2\frac{1}{2}$ in. strips, also attach, by the inner screws and nuts, four $5\frac{1}{2}$ in. strips bent so as to curve downwardly to meet the supports. Two $12\frac{1}{2}$ in. strips bent over form the front arch and supports, and two $2\frac{1}{2}$ in. strips must be added and attached to the lower side strips, to form projections to which the drawbridge is to be hinged. Two guide pulleys are required for the cords to actuate the drawbridge, these cords passing down and being wound on the centre portion of the cranked axle.

Fig. No. 18. TRAVELLING JIB CRANE.



In constructing this model, the lower horizontal sides of the crane should first be put together. Each side consists of a $12\frac{1}{2}$ in. strip and a $5\frac{1}{2}$ in. strip joined together, three holes overlapping. The winch frame at the end is formed of four $2\frac{1}{2}$ in. strips secured to the side frames and connected together at their tops by two $5\frac{1}{2}$ in. strips, the sides so constructed being united together by four $5\frac{1}{2}$ in. strips connected to the angle pieces as shown at the third hole from each end; a fifth transverse $5\frac{1}{2}$ in. strip is used to connect the other ends of the horizontal sides together as shown, and the wheel axles are inserted through appropriate holes in the ends of the horizontal frame.

The bearings for the winch handle are formed by two $5\frac{1}{2}$ in. strips secured diagonally to the winch frame; the winch handle has a pinion, and a ratchet is pivoted to the right hand diagonal and a brake wheel and lever may be added if desired.

Each side of the jib is constructed of two $12\frac{1}{2}$ in. strips, jointed together by overlapping; at the top where the sides meet a pulley is fixed on a short length of spindle, and at the bottom the two sides are respectively screwed to the two ends of the horizontal base.

The jib is braced by two diagonally arranged $12\frac{1}{2}$ in. strips, secured to a $2\frac{1}{2}$ in. transverse strip which is in turn attached to the sides of the jib by angle pieces

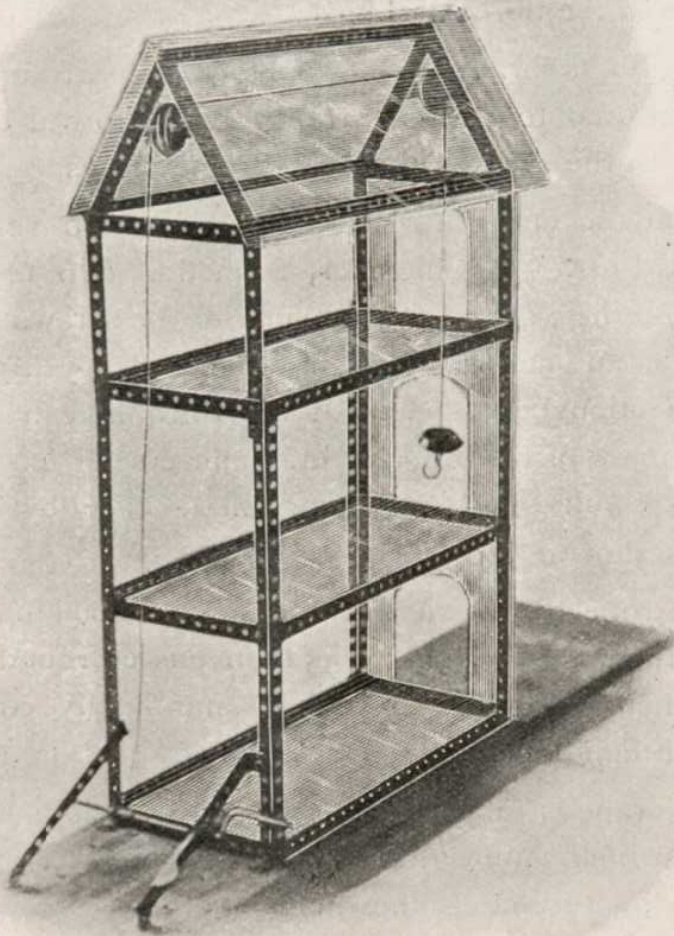
From the ends of the $2\frac{1}{2}$ in. strip, two $12\frac{1}{2}$ in. strips are carried to a truss member, formed of two $12\frac{1}{2}$ in. strips united together, secured at one end to the screws at the base of the jib, and united at their other ends by a $5\frac{1}{2}$ in strip; the connection being made at the third hole from the end as in the case of the other $5\frac{1}{2}$ in. transverse strip. The truss frame is connected to the horizontal base by two $5\frac{1}{2}$ in. strips as shown.

The rope by which the weight is raised has one end fixed to the end of the jib; it is then passed round the pulley block, then over the jib pulley, and finally connected to the winch handle.

The crane is further strengthened by strings to represent tie rods, which connect the ends of the jib, the truss frame, and the winch frame as shown.

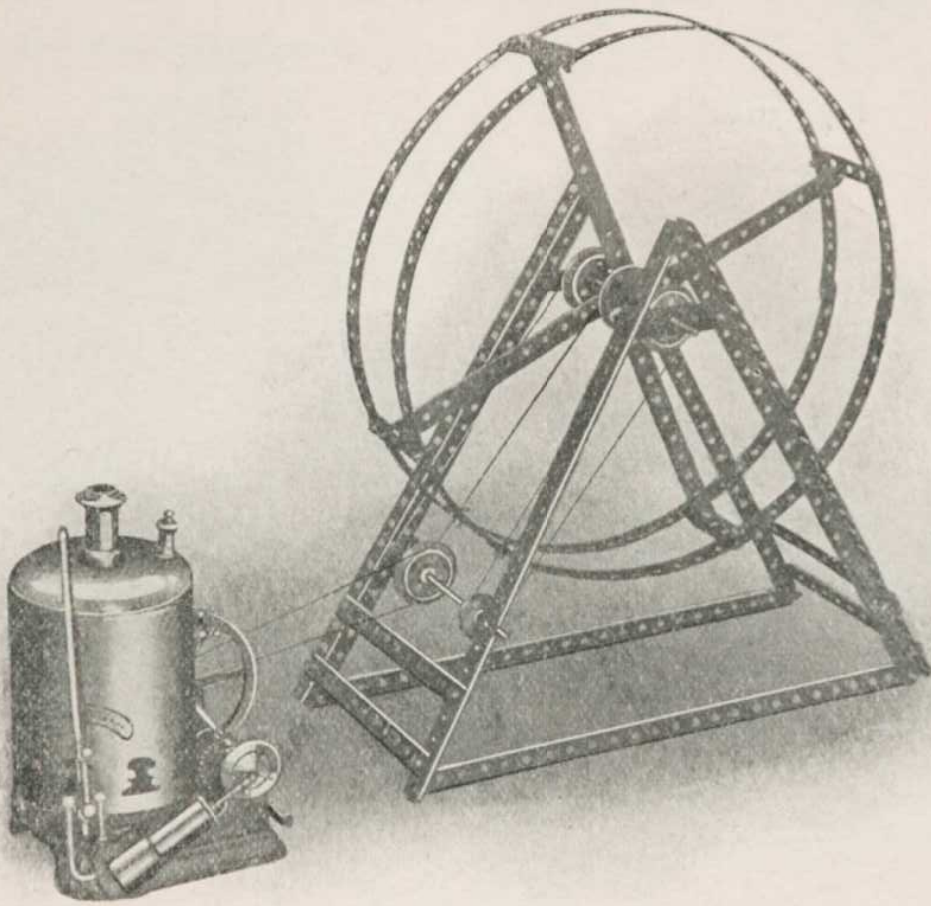
If possible, the joint between the truss frame, the side frames and the jib, should be made with a single pair of screws, which should also carry the angle pieces for the cross bracing of the crane.

Figure No. 19. WAREHOUSE WITH HOIST.



The framework of this model is shown to assist in its construction. The roof and floors may be formed with cardboard as suggested in the design.

Figure No. 20. WHEEL.



By extending the shaft of this Model additional pulleys may be used for driving small models.

Figure No 30. CABLE RAILWAY.

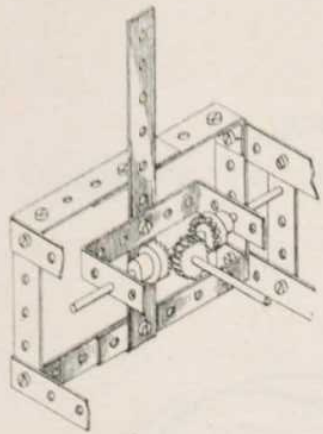


Fig. 30A.

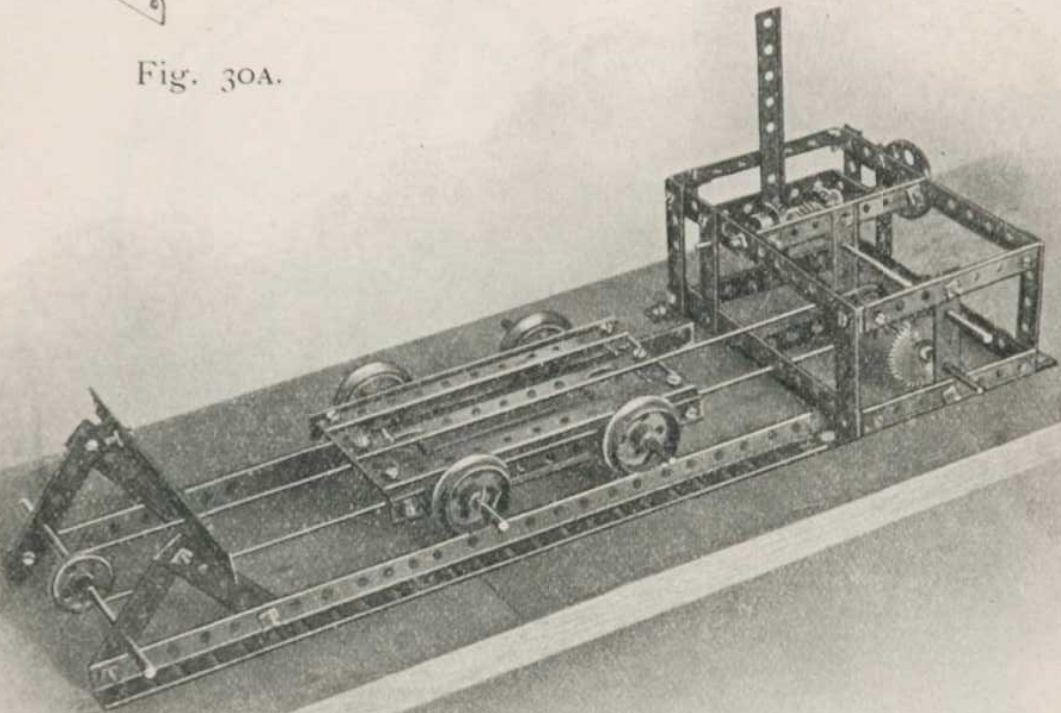


Fig. 30B.

In this model the driving power is received at the outer pulley, and is transmitted through the clutch mechanism (of which a separate detail is given) and the pair of gear wheels to the lower spindle on which the driving pulley is fixed, the driving rope passing round this pulley and second pulley at the end of the rails. all as shown in the drawings.

In fixing the lever for operating the clutch mechanism the nuts should be locked to prevent the screw working out. Only one section of rails is shown in the design, but they may be extended as desired.

Figure 30c is an example of a lever for operating signals at a distance. The bracket D is gripped between the top facing nut C and the lower locking nut E, which are threaded on the bolt A so as to leave sufficient play for the guide pulley B to rotate easily.

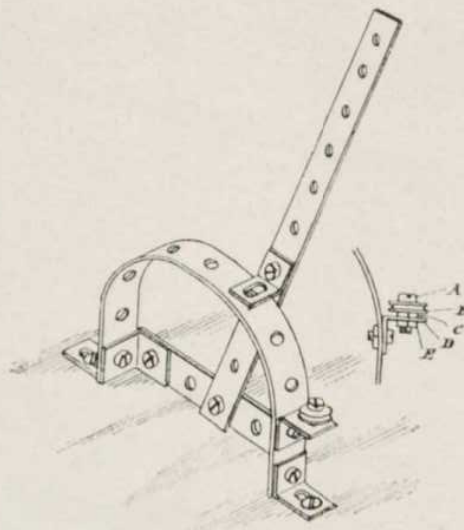


Fig. ~~30~~ 30c

Figure No. 31. WAREHOUSE WITH ELEVATOR

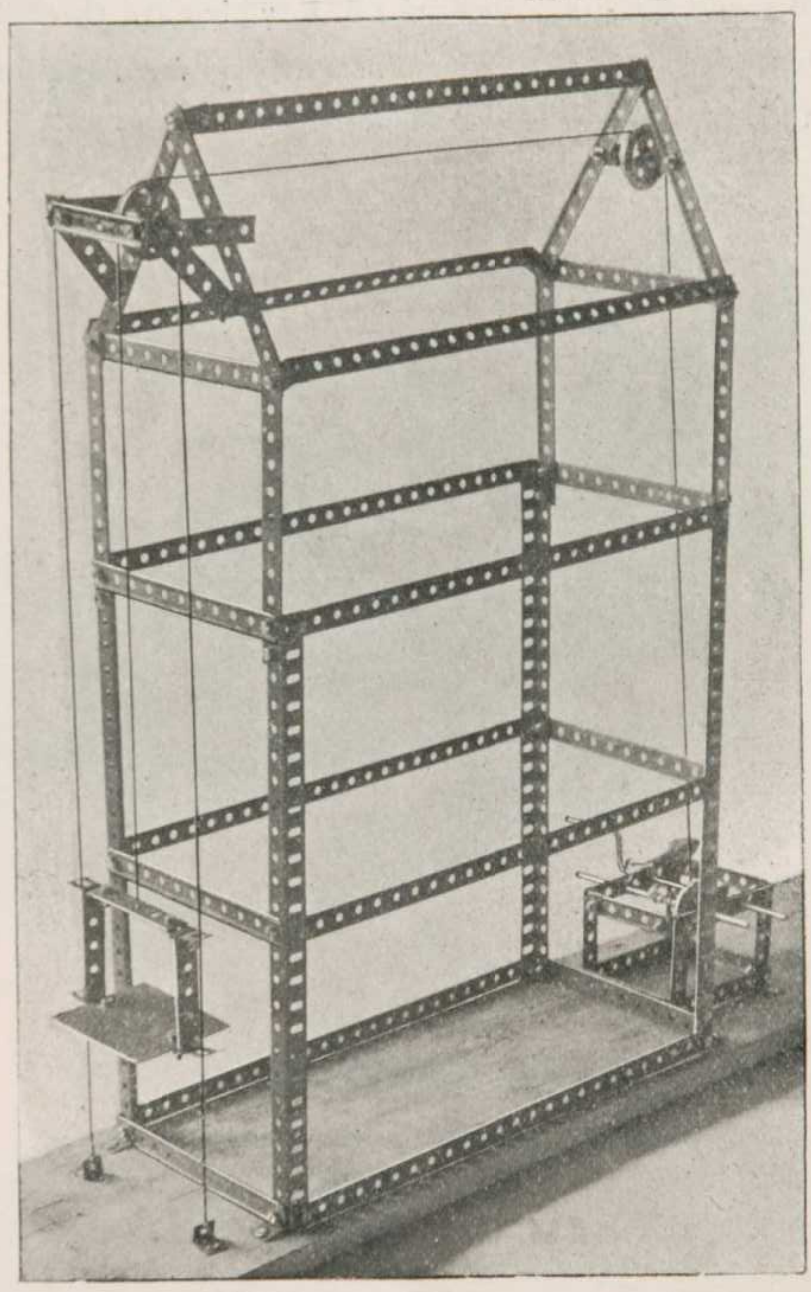
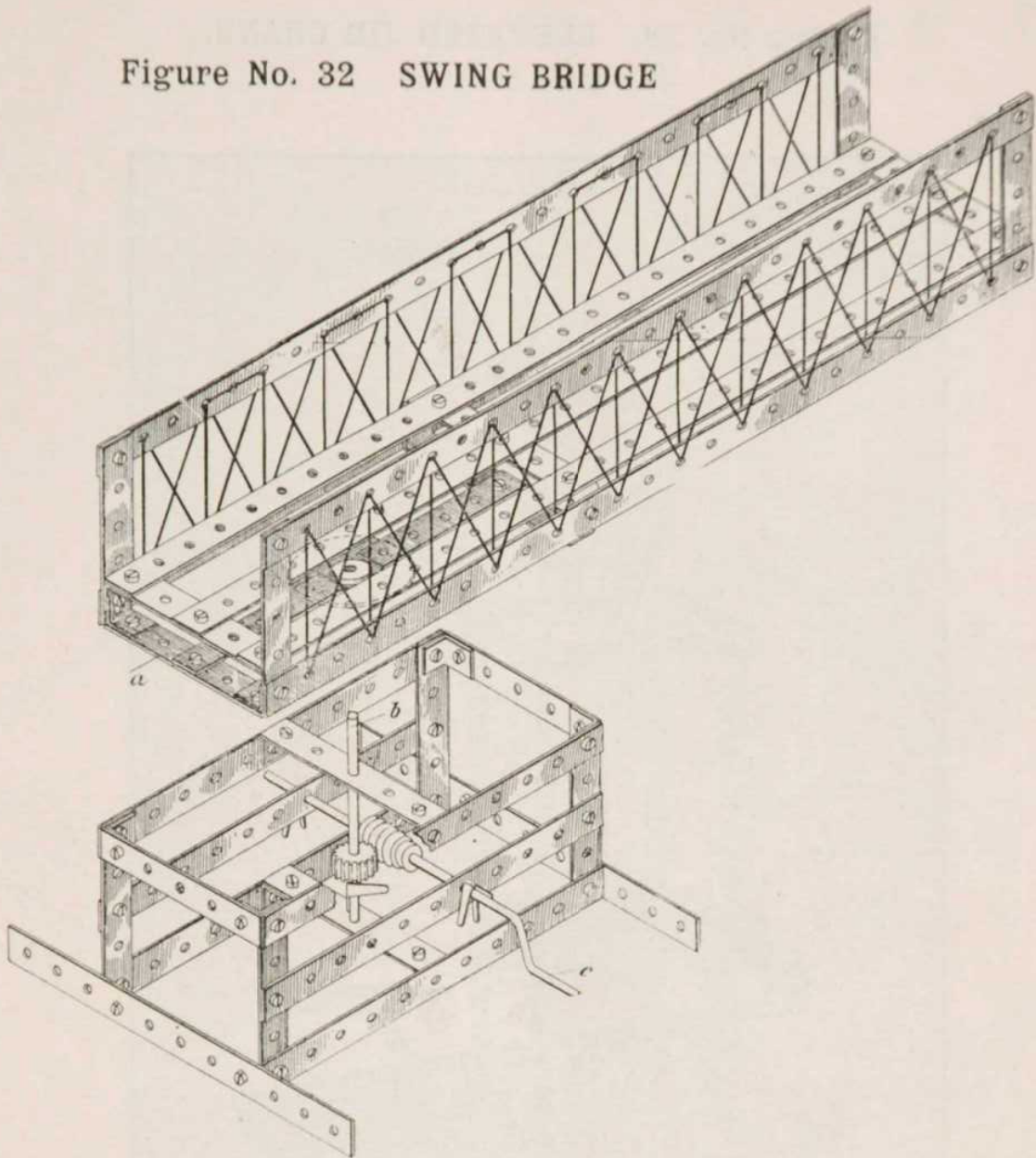


Figure No. 32 SWING BRIDGE



This design consists of the base portion, containing the perpendicular axle actuated by the worm and pinion, and the upper platform. In the sketch the upper platform and base are shown separate for the sake of clearness. The eye of the wheel built into the lower framework *a* of the platform, is threaded over the upstanding axle *b* in the base, and keyed into position, so that by turning the cranked axle *c* the platform will be rotated by means of the worm gearing.

The upper platform, it will be noticed, has, besides the framework forming the continuous floor, a secondary and shorter lower framework *a*. Into the centre strip of this lower framework is built the wheel upon which the platform rotates.

Figure No. 33. ELEVATED JIB CRANE.

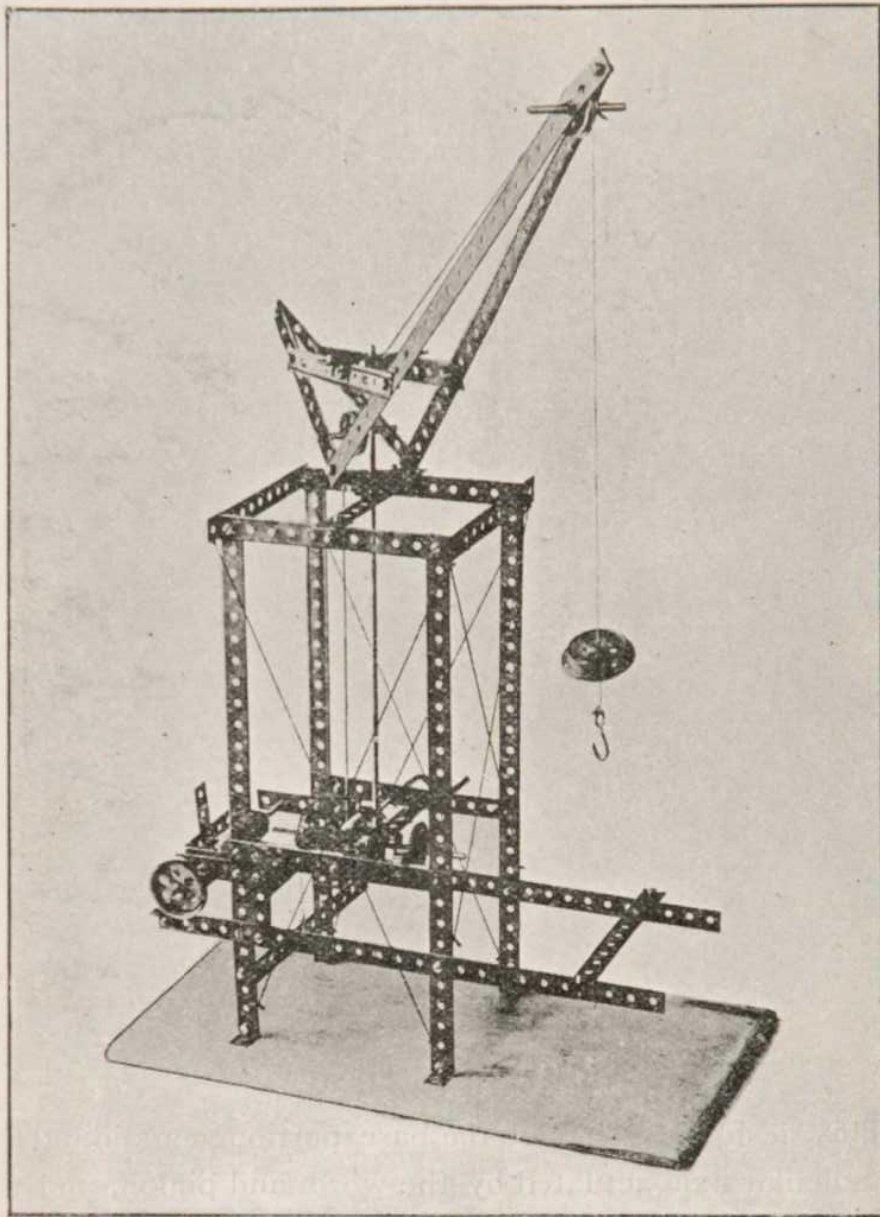


Fig. 33A.

The general construction of this crane (which is well adapted to be operated by a small steam or hot air engine) will be understood from the photograph, Fig. 33A, which shows the different parts of the structure assembled ready for use. The details of the hoisting, reversing, and swivelling gear are shown in the separate view, Fig. 33B.

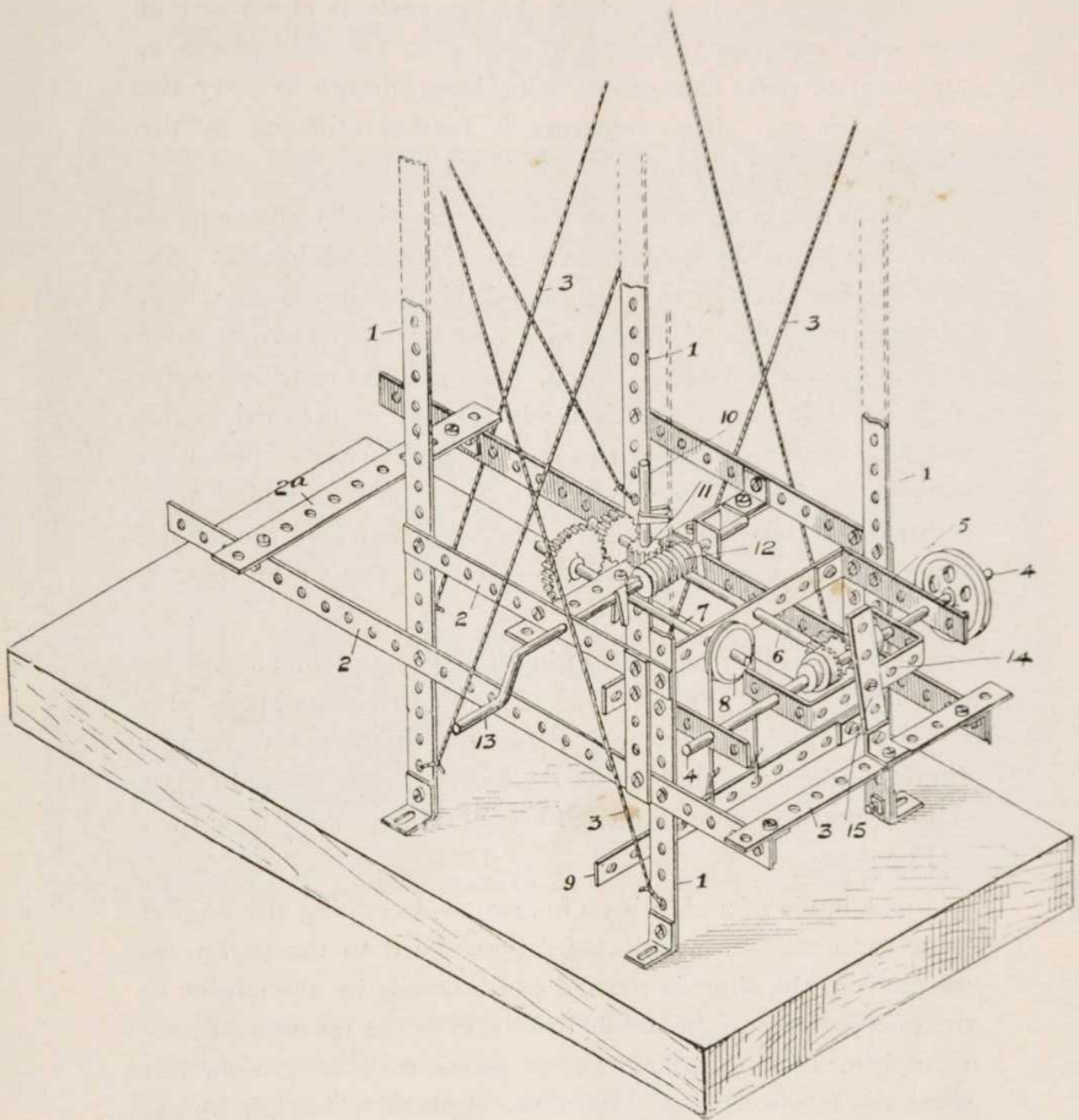


Fig. 33B.

If the model is to be worked from an engine, it is desirable that it should be fixed in position, and for this purpose the four angles at the bottom of the uprights 1 are provided, and these may be attached by screwing to a wood base, as shown in Fig. 33A, or, where no damage is likely to result, these brackets may be screwed directly to a bench or the like.

The main frame on which the jib rests is composed of four main uprights 1, braced together by the side pieces 2, the lower of these side pieces being long enough to carry the cross piece 2A. The structure is further stiffened by the diagonal cords 3 as shown.

The arrangement for reversing is practically the same as that shown for Fig. 30, and illustrated in detail in Fig. 30A. The driving shaft 4, to which the driving pulley is attached, is supported in the $2\frac{1}{2}$ in. pieces 5, and carries the two contrite wheels of the reversing clutch, one or other of which gears with the pinion on the shaft 6, which shaft in turn drives the winding shaft 7 through the pair of gear wheels shown on the extreme left. The winding shaft 7 is also provided with a brake, consisting of the pulley 8 shown on the shaft, round which passes a cord operated by the brake lever 9 as shown.

The spindle 10 for swinging the jib, which, as will be seen from Fig. 33A, extends up to and carries the jib, is provided with a pinion 11, which gears with the worm 12 and crank handle 13. One end of the winding rope is fixed to the shaft 7, and the rope is carried up over the pulleys as shown in Fig. 33A.

The mode of action is as follows:—Assuming the engine to be connected by a suitable driving cord to the pulley on the shaft 4, the shaft is rotated continuously by the engine in the one direction. In the mid position of the reversing frame 14, neither of the contrite wheels gears with the pinion, but when the frame 14 is pushed to the right or to the left by the reversing lever 15, one or other of the contrite wheels is caused to engage, and thus effects the lifting or the lowering.

The swivelling is effected by rotating the shaft 13, and when the reversing frame 14 is in mid position, the load on the crane is controlled by the movement of the brake lever 9.

Figure No. 34. SWIVELLING AND LUFFING JIB
CRANE.

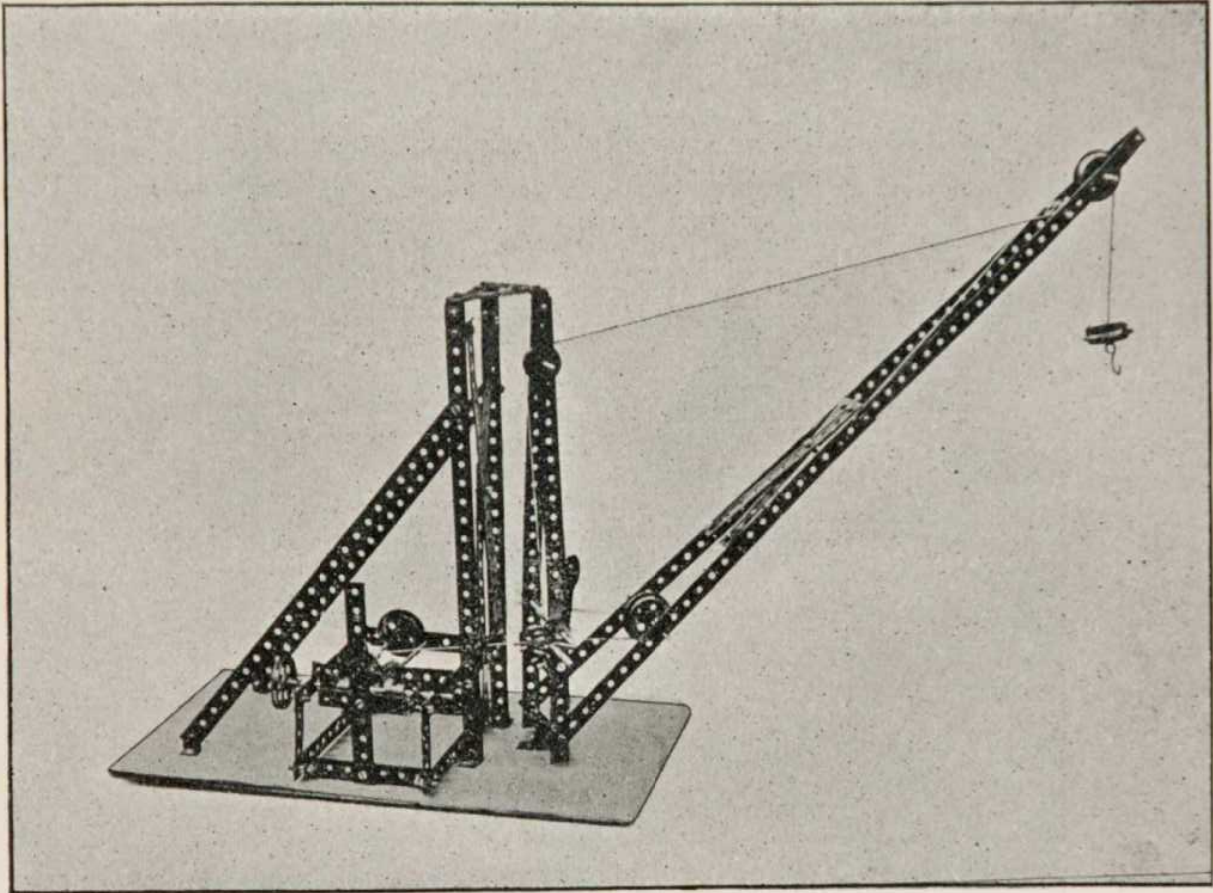


Fig. 34A.

This model is interesting as affording an example of a crane used to transport the load from, say, a ship's deck on to a quay, by "luffing" or altering the angle of the jib. As will be seen from the photographs, Fig. 34A, which is a side view of the crane, and Fig. 34B, which is a rear view of the crane from above, the apparatus consists of two parts, a fixed frame and a swivelling and luffing jib.

The construction of the fixed frame with the reversing frame and lever should present no difficulties, especially in view of the work done in connection with Fig. No. 33.

The two $12\frac{1}{2}$ in. uprights are braced together as shown, and are held in vertical position by the two $12\frac{1}{2}$ in. rearwardly

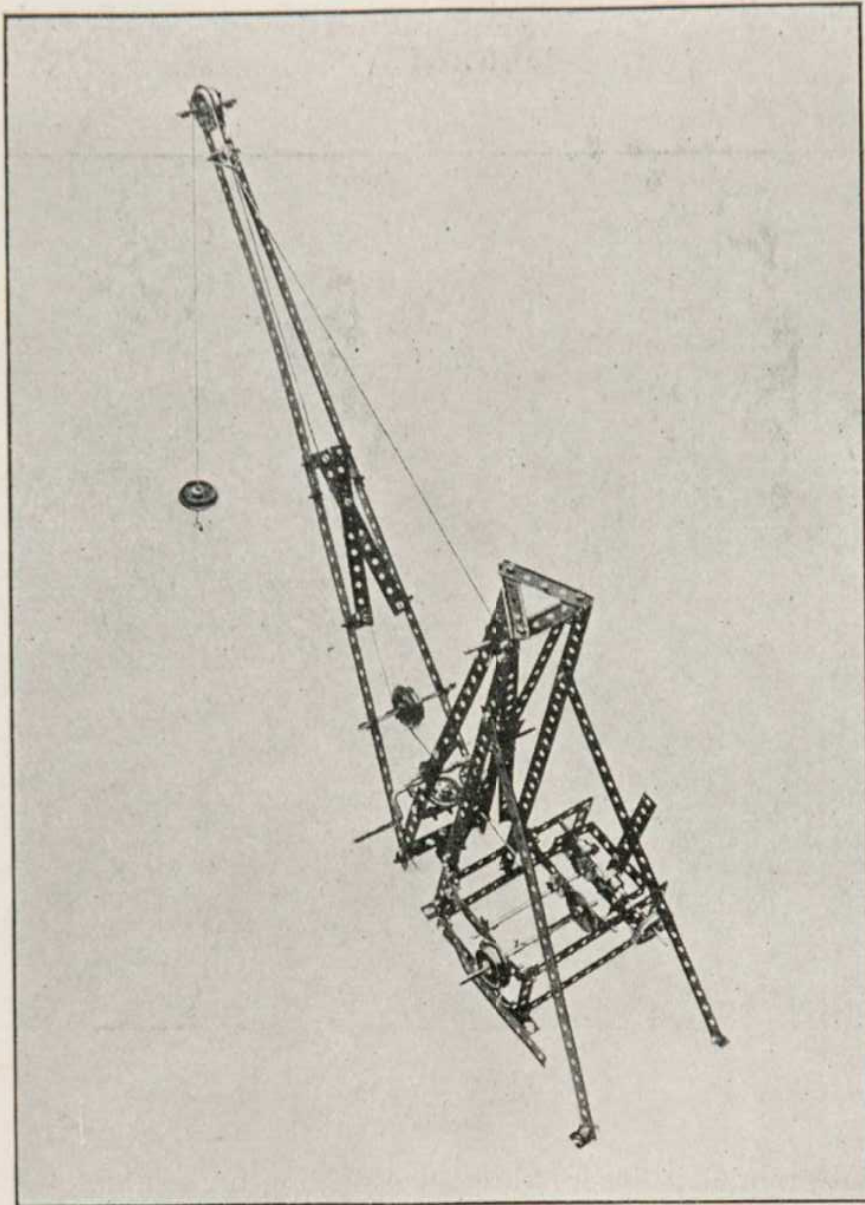


Fig. 34B.

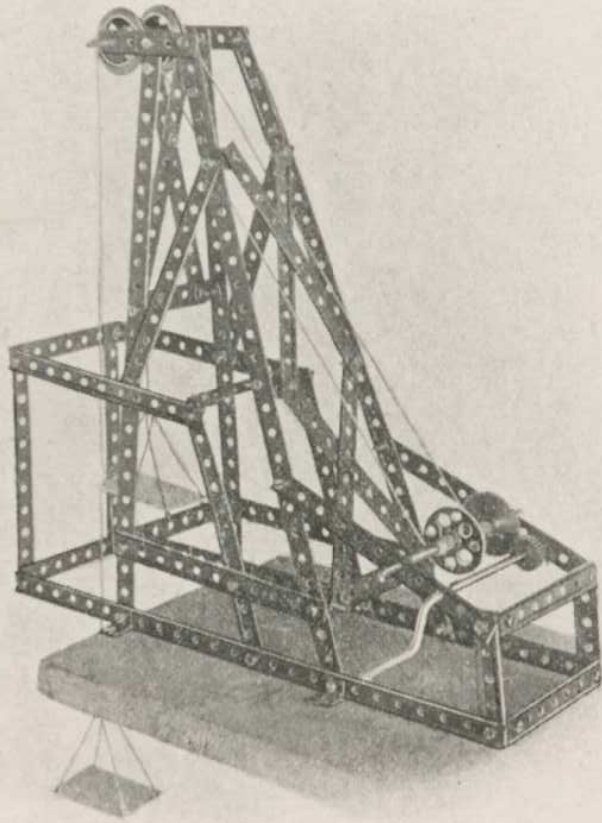
sloping pieces, and from the structure so formed the reversing frame is carried.

The swivelling piece of the jib consists of two $12\frac{1}{2}$ in. pieces bent as shown, connected at the bottom by a $2\frac{1}{2}$ in. piece. This $2\frac{1}{2}$ in. piece is provided with a screw in the centre hole, which fits in a double angle bracket screwed to the bench, and this forms the lower pivot; the upper pivot is formed with an angle bracket, having a screw, carried in the triangle formed of $2\frac{1}{2}$ in. pieces attached to the fixed frame.

The jib itself consists of two pairs of $12\frac{1}{2}$ in. pieces connected and braced together as shown. The jib luffs about its connection to the swivelling frame, and is thus capable of two motions, a swivelling motion and a luffing motion.

The luffing motion is effected by the luffing rope, which is coiled round the handle shown, and then passes round the pulley at the top of the swivelling frame, the other end being attached to the head of the jib. In order to keep the hoisting rope in position when the crane is swivelled, the two guide rollers carried on the swivelling frame are provided. These are attached by screws to two angle brackets connected with a $2\frac{1}{2}$ in. piece as shown.

By operating the luffing handle the jib may be put at any angle from nearly horizontal to nearly vertical, the crane thus acting as a transporter of the load.

No. 35. PIT HEAD HOIST.

MAXIM FLYING MACHINE.

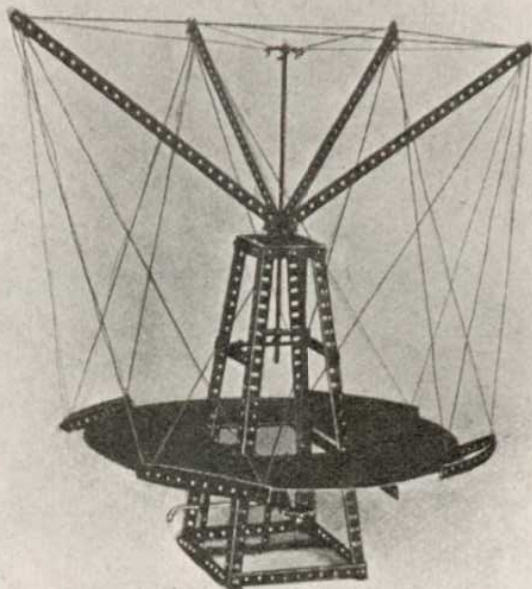


Fig. 40A.

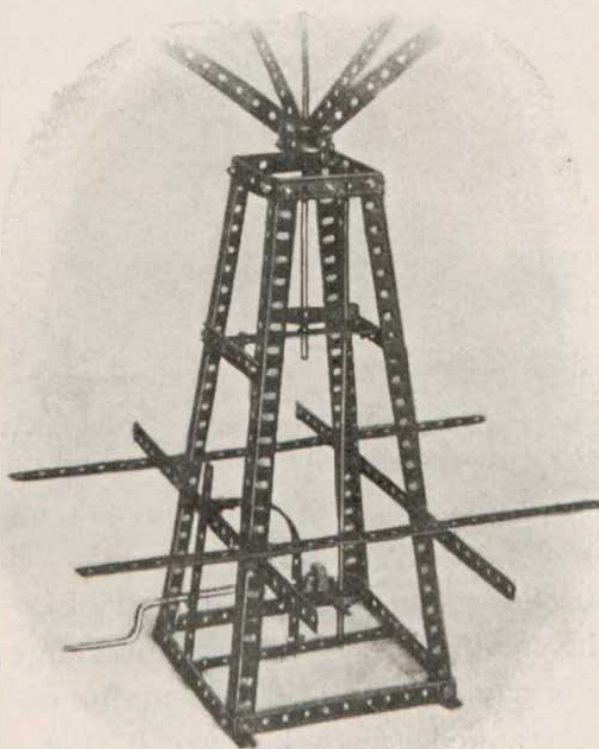


Fig. 40B.

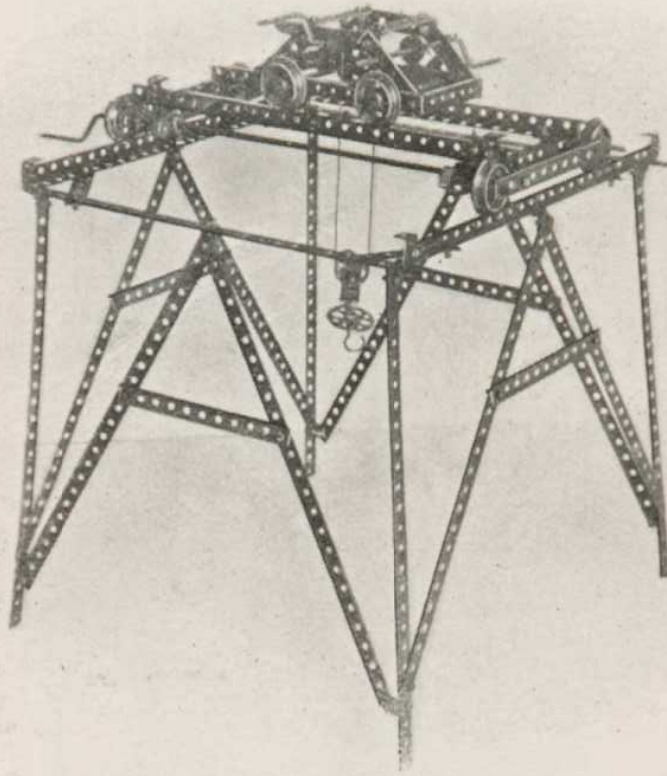
Fig. No. 41. TRAVELLING CRANE.

Fig. 41.

Separate views are given of three distinct parts composing the travelling crane. The first view, Fig. 41A, shows the braced gantry structure carrying a rail at each side. The two pairs of running wheels in the travelling gantry, Fig. 41B, must be keyed on the small axles, so as to fit the gauge of these rails. The gantry is caused to travel to and fro on these rails by rotating the cranked axle. The winch, Fig. 41C, again, is arranged to run on the gantry rails of Fig. 41B, and is

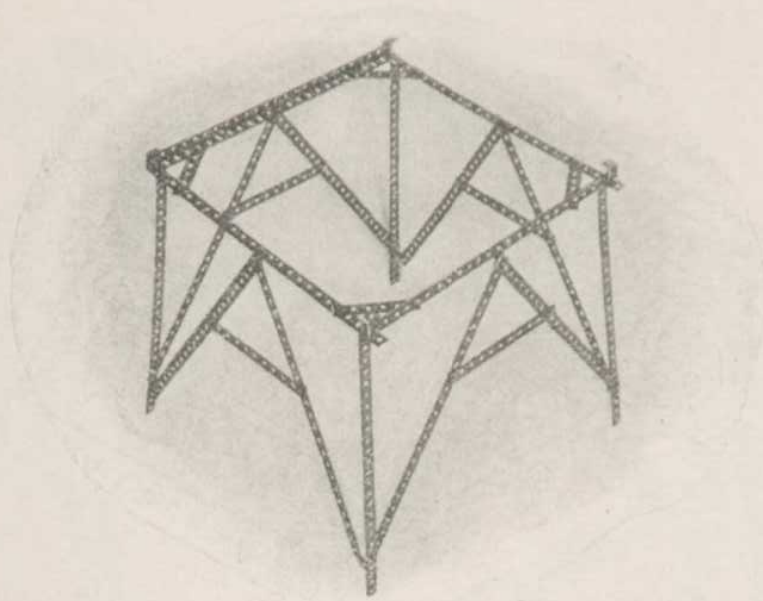


Fig. 41A.

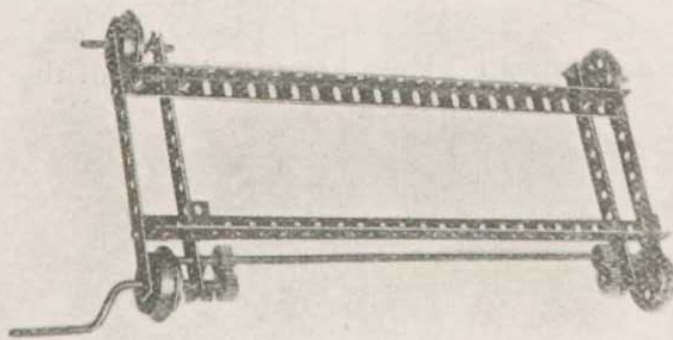


Fig. 41B.

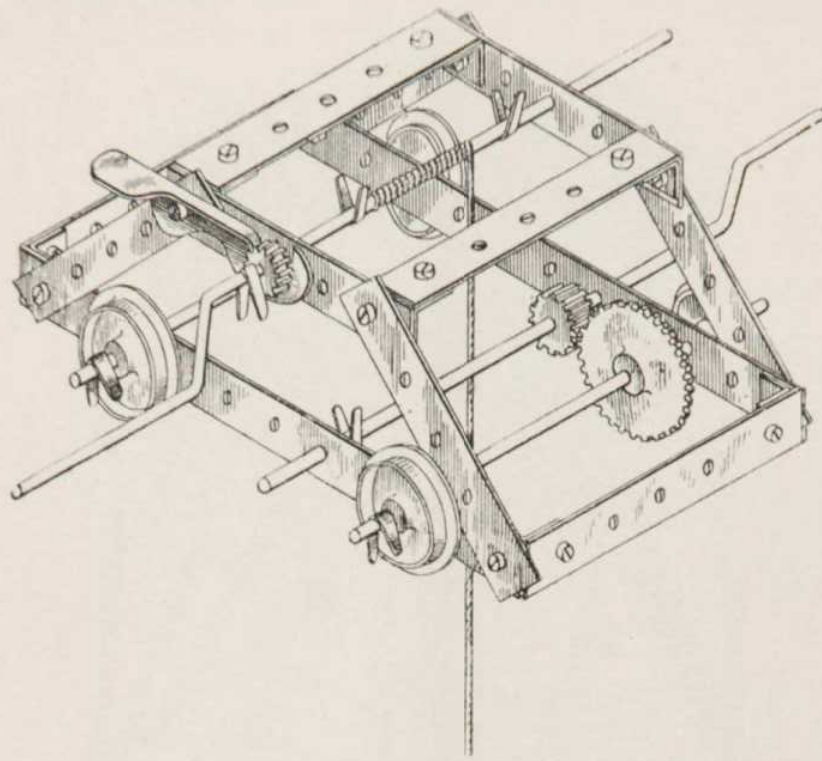


Fig. 41C.

provided with a hoisting axle, and one for traversing the winch.

Figure 41 shows a general arrangement of the complete model.

Fig. No. 42. CRANE.

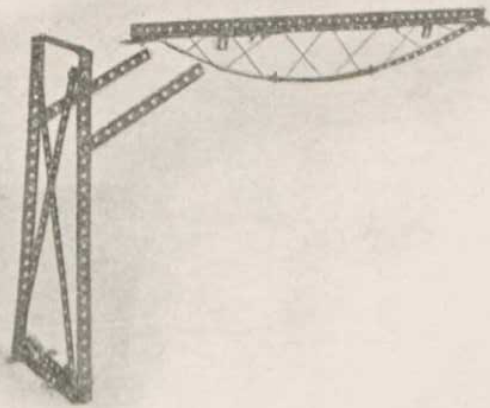
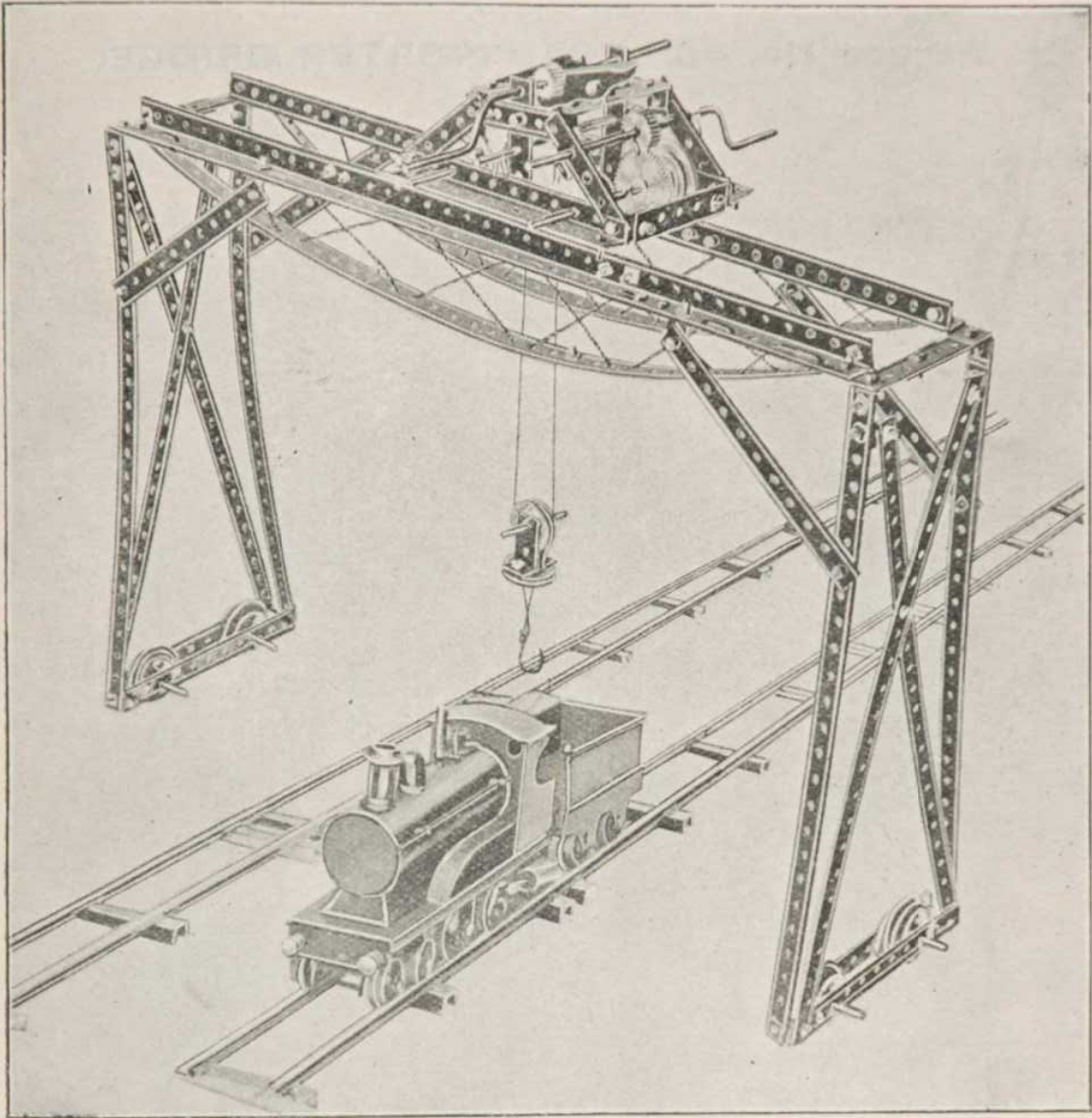


Figure No. 43. TRANSPORTER BRIDGE.

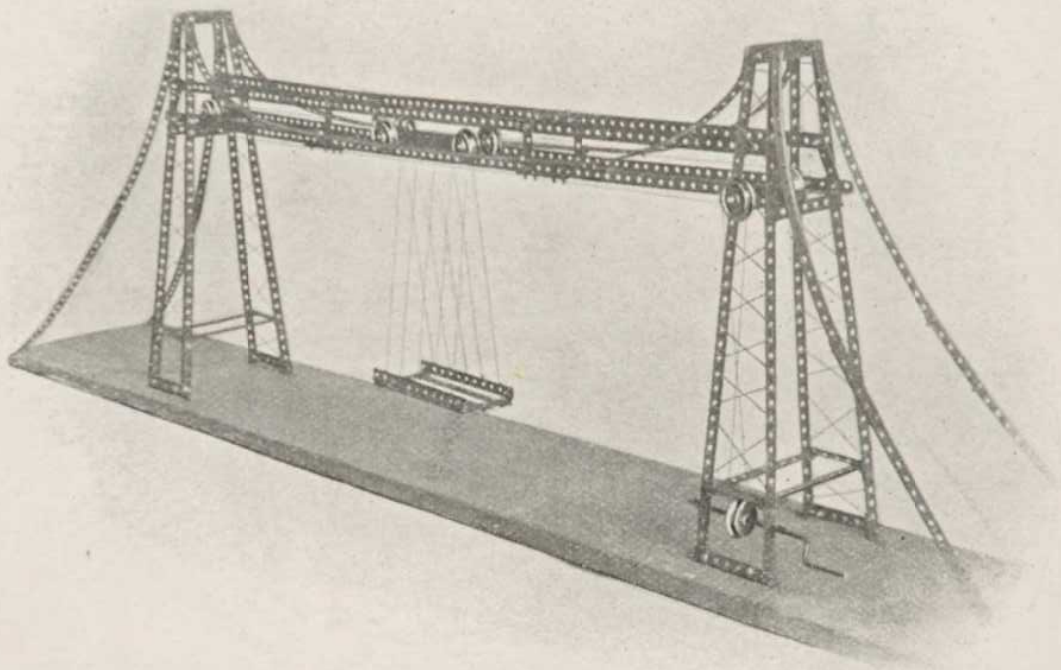


Figure No. 50. MODEL OF TOWER.

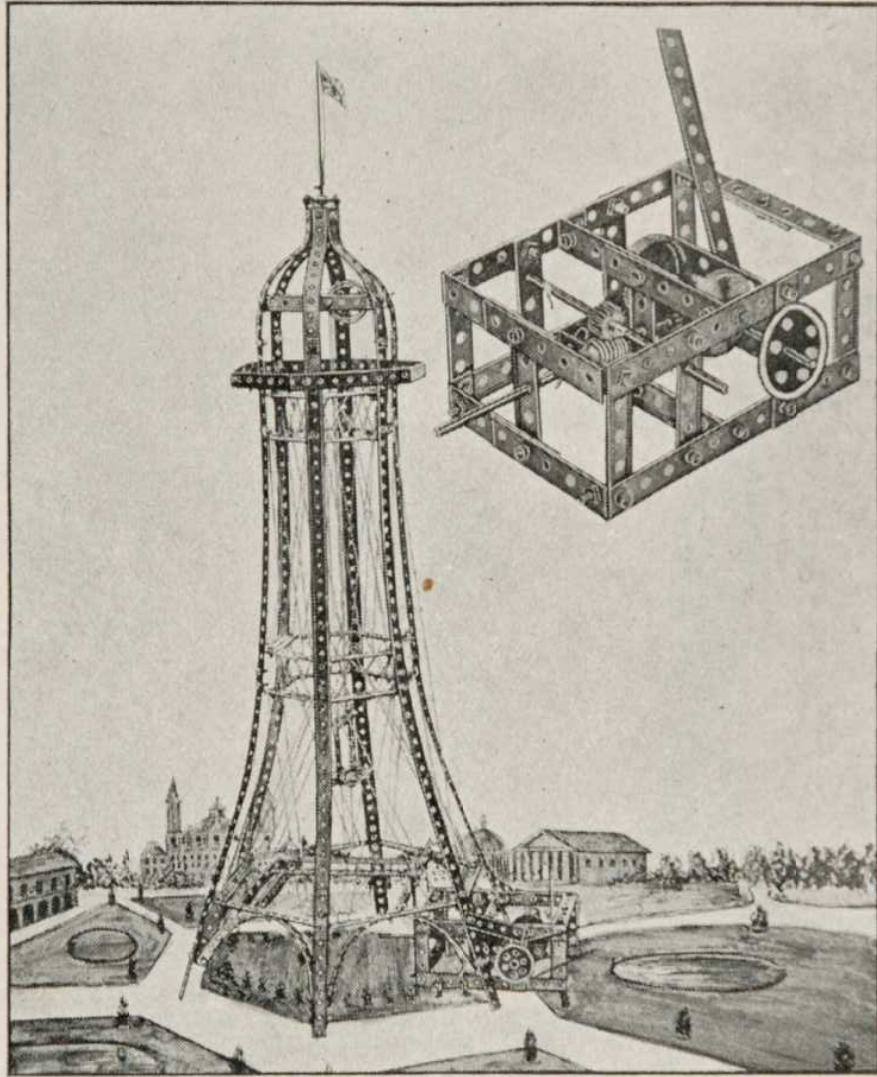


Figure No. 51. MODEL OF TOWER BRIDGE.

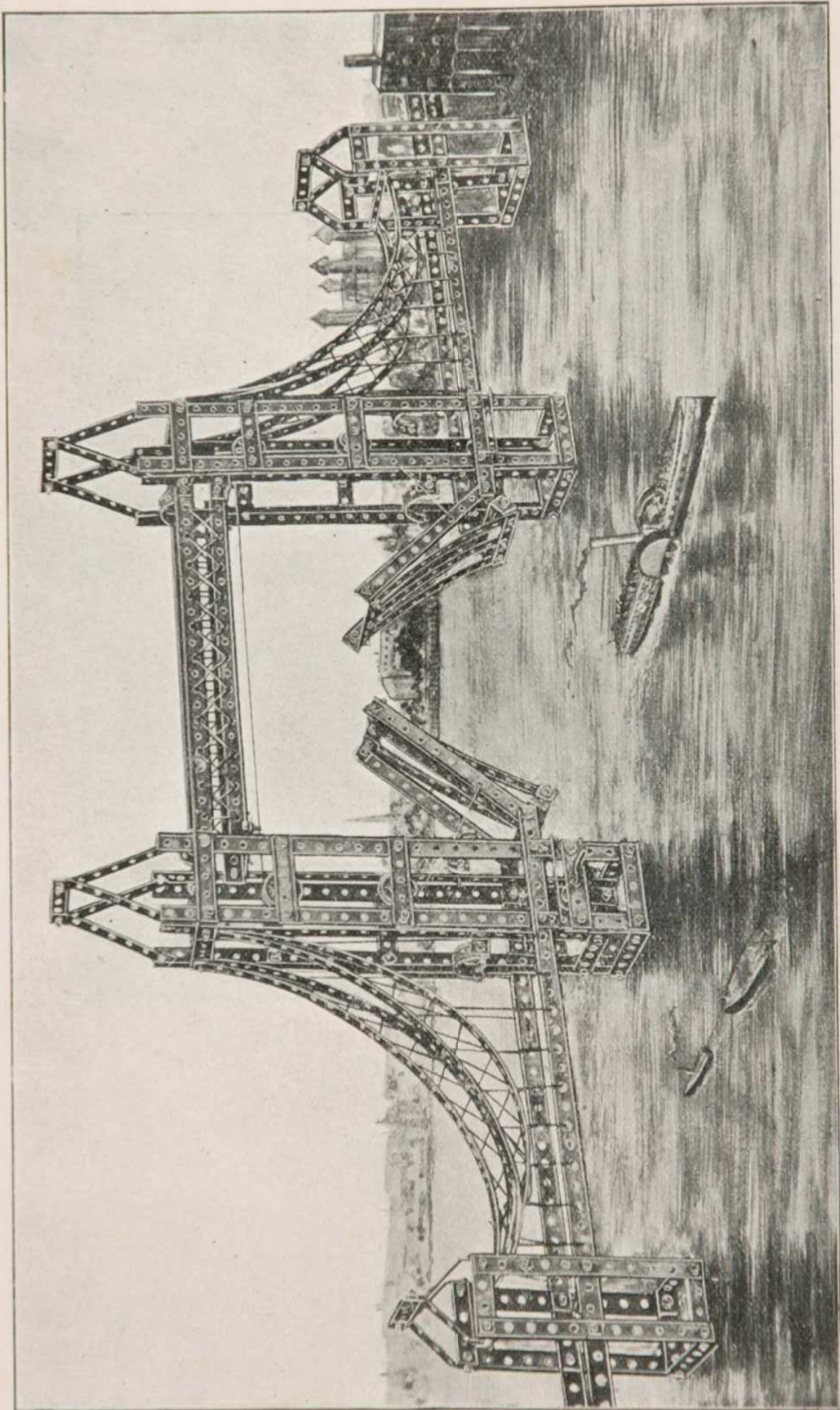


Fig. 51.

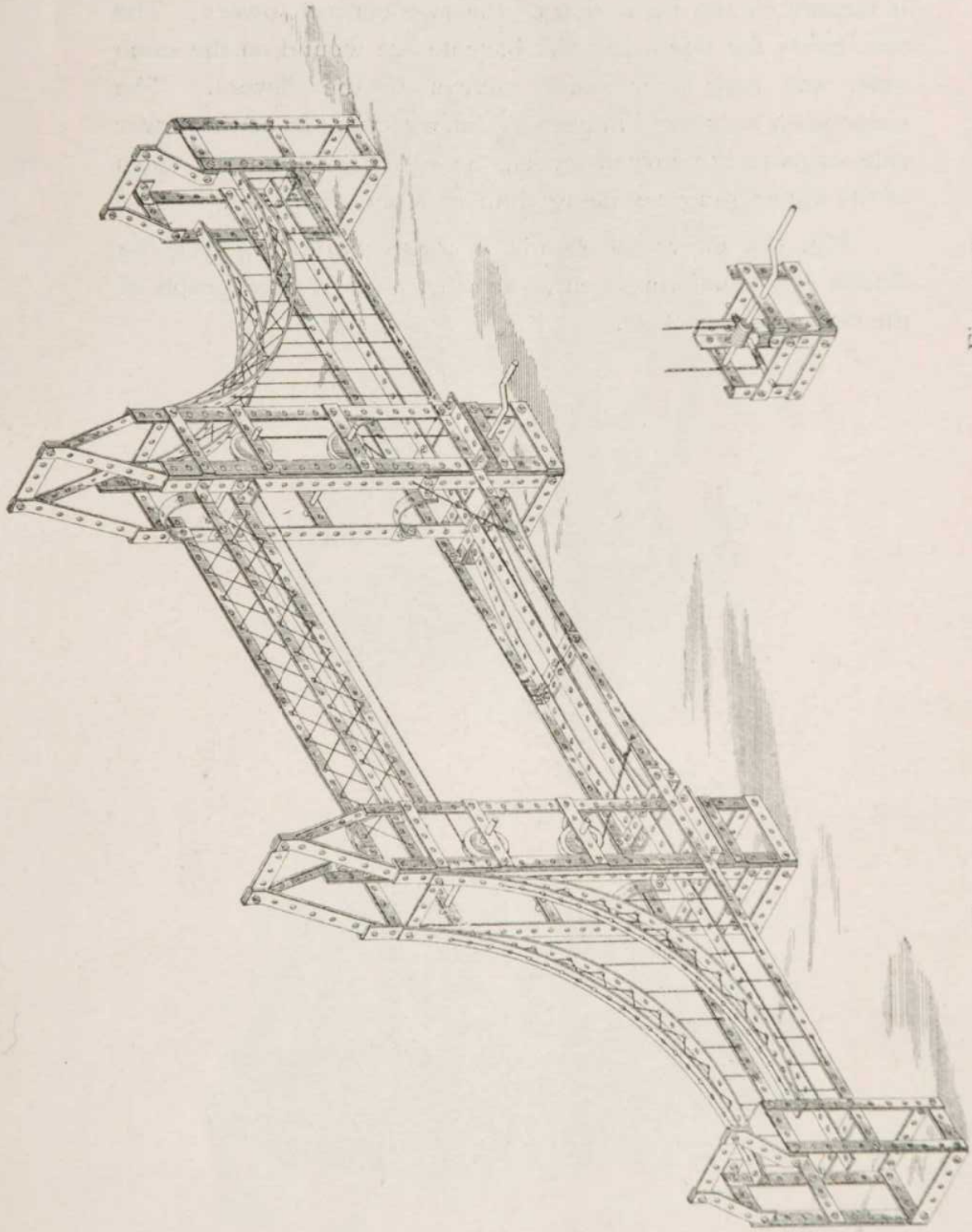


Fig. 51B.

Fig. 51A.

The two sides of this model are alike in every respect, except the gear for raising the bascules, which consists of a worm and pinion, operated by a cranked axle as shown, and is located in the right one of the two central towers. The two cords for operating the bascule are wound on the same axle, and pass over guide pulleys in the towers. The suspension rods are imitated by lacing cords from the lower side strips to the curved strips, the lattice work on the sides of the upper gangway being similarly done with cord.

Fig. 51A shows the details of construction, Fig. 51B the details of the hoisting gear, and Fig. 51 is a photograph of the complete structure.

Figure No. 52. BIG WHEEL.

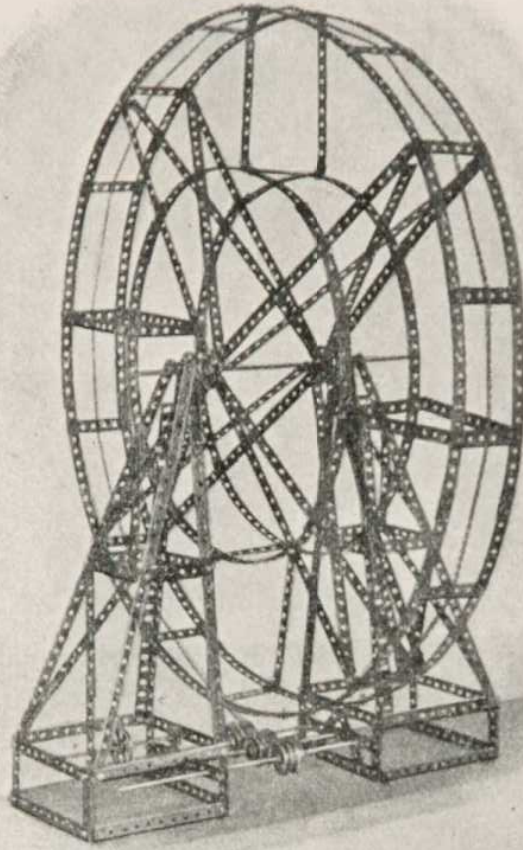


Fig. 52.

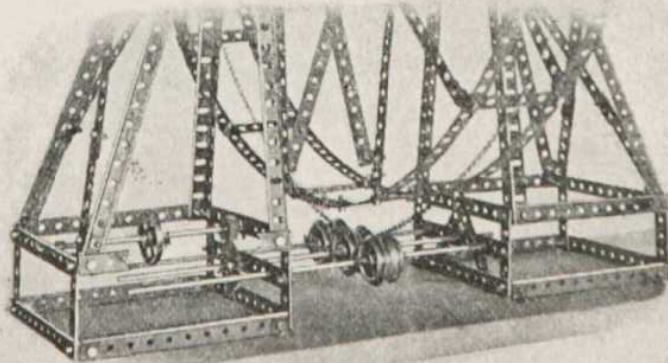
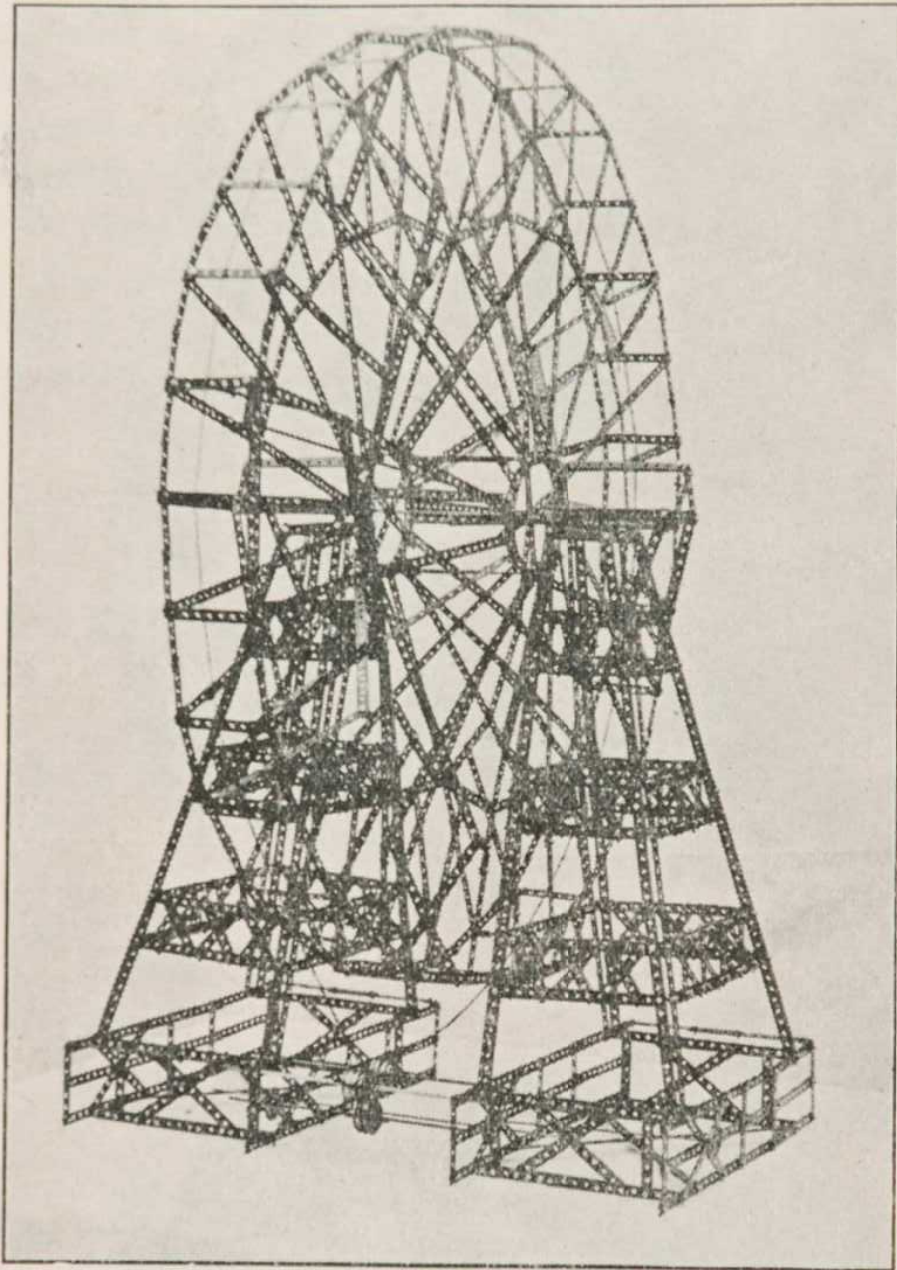


Fig. 52A

Fig. No. 60. BIG WHEEL.

Mechanism for operating Wheel practically as shown in
Figure 52A.

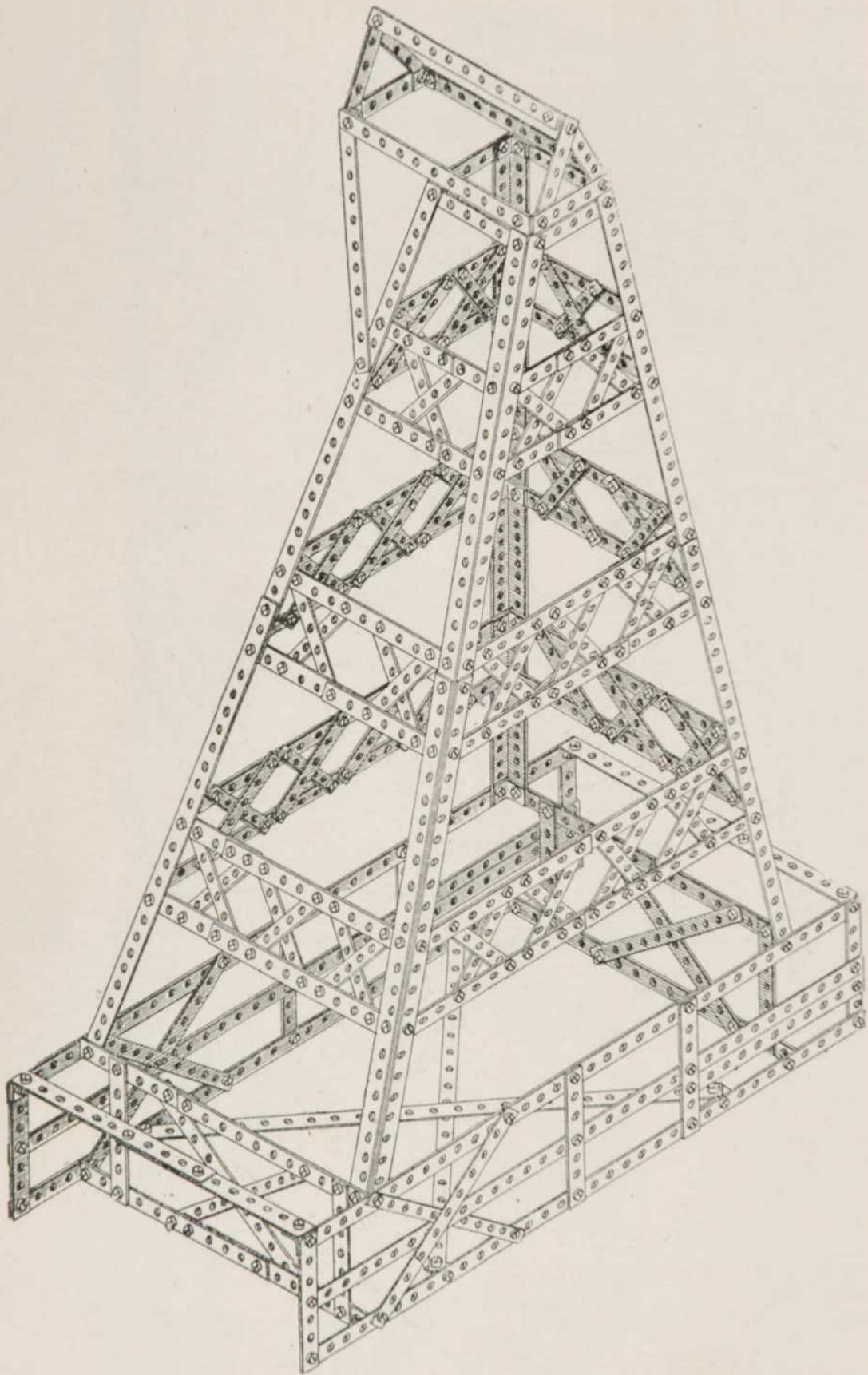


Fig. 60A.

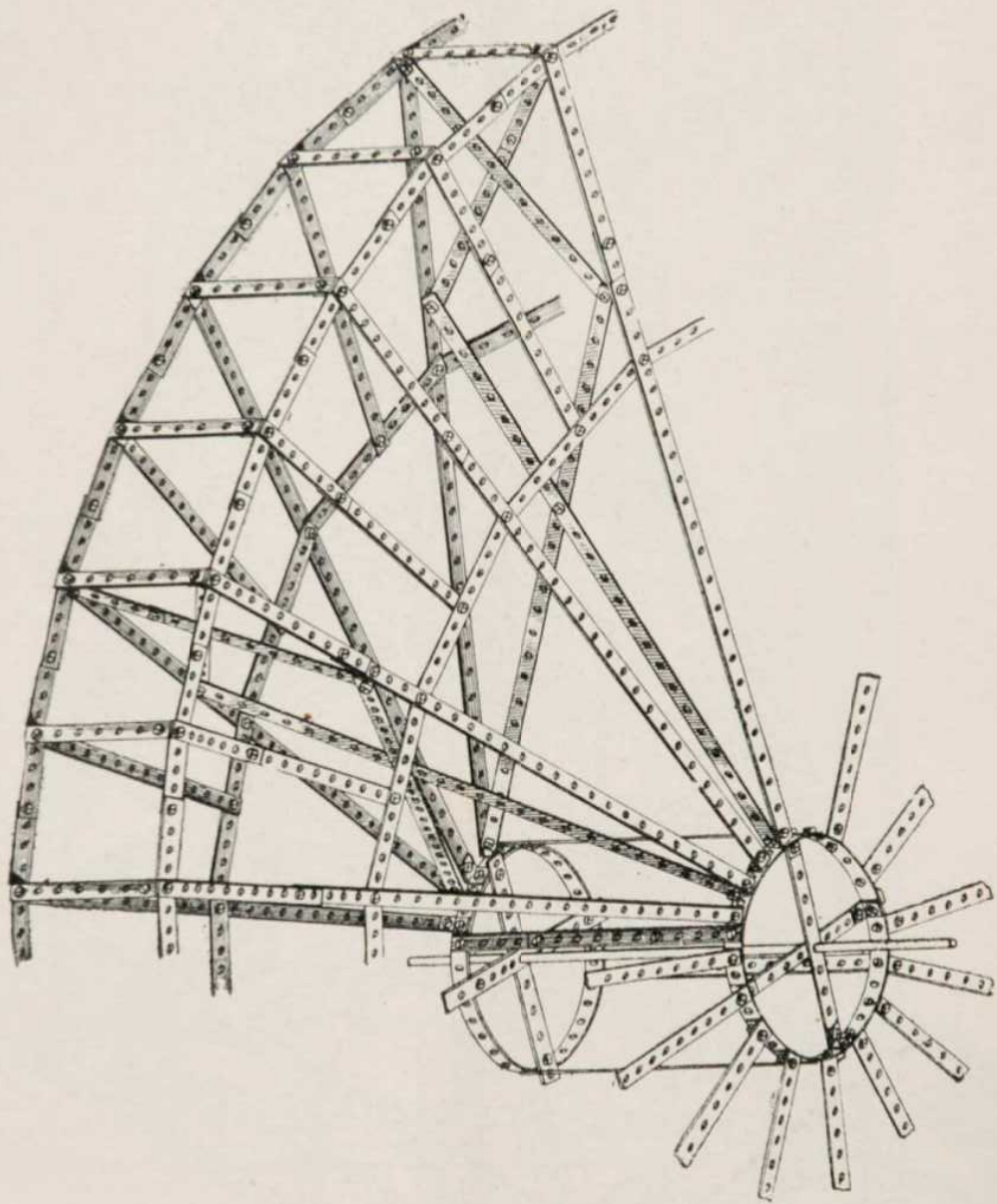
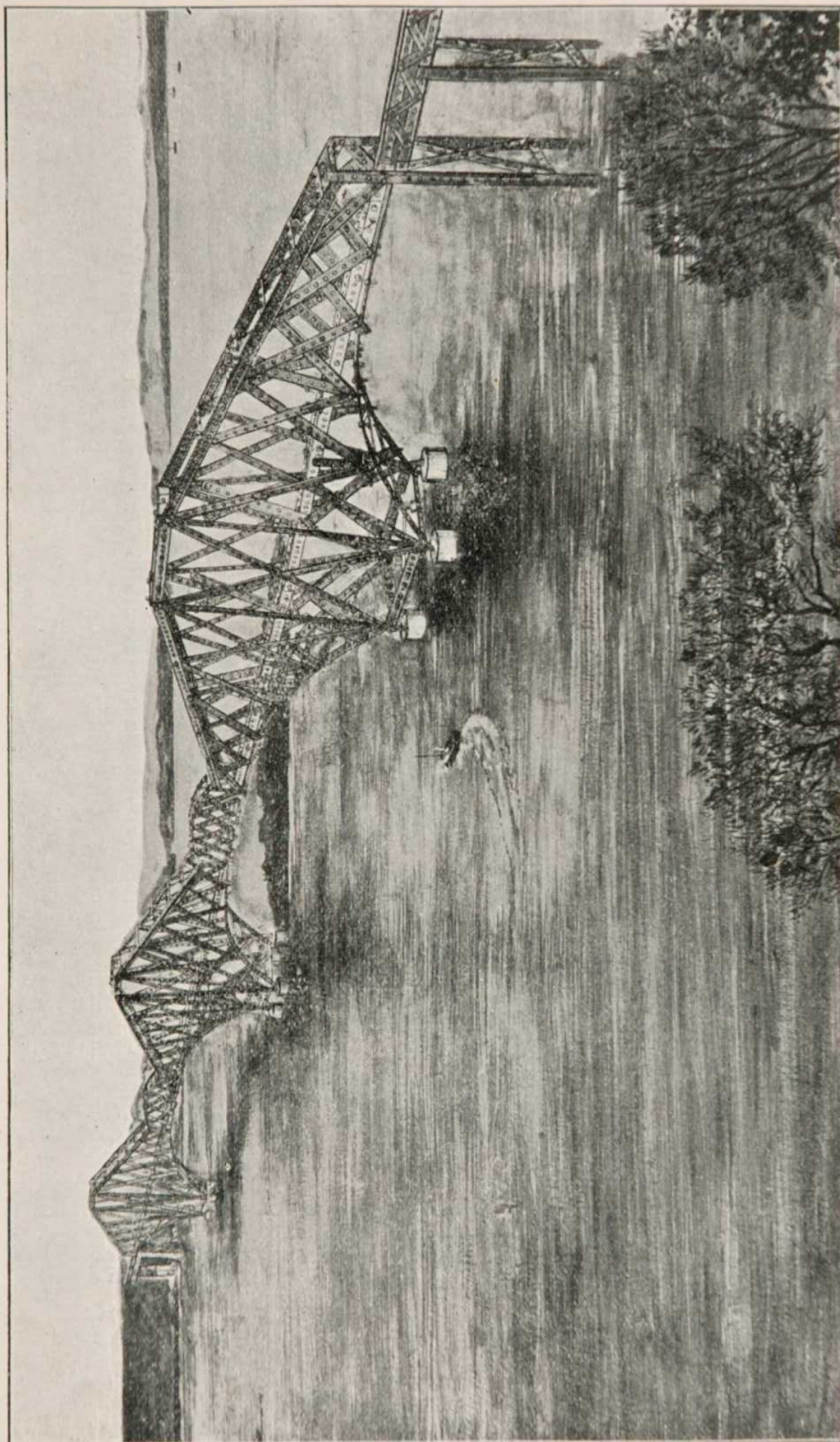


Fig. 60B.

Figure No. 61. MODEL OF FORTH BRIDGE.



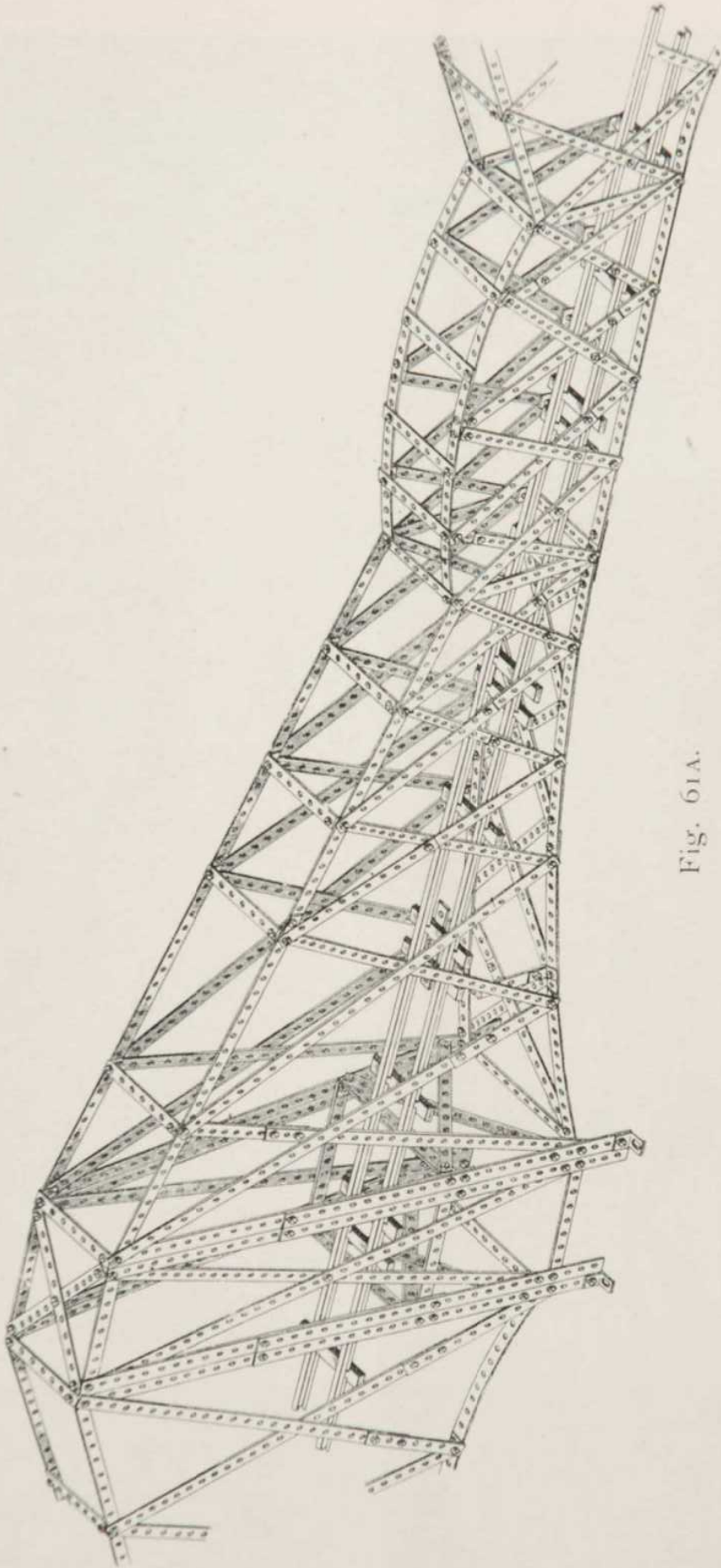


Fig. 61A.

This is one of the most interesting models which can be made with this apparatus. When completed, its length is 16 feet, and it forms a most realistic representation of the great Forth Bridge, and illustrates very clearly the cantilever principle used in its construction.

REQUIRED TO MAKE THEM.

17	18	19	20	30	31	32	33	34	35	40	41	42	43	50	51	52	60	61
9	12	9	8		9	7	8	12	6	8	14	18	28	13	35	46	98	164
11	14	18	8	6	16	8	16	8	18	15	10	14	18	28	28	34	193	264
				6	4			4	6	3		2	4	6		16	60	122
8	5		6	12	16	19	6	8	7	4	8	14	18	40	66	12	194	112
															8			
12	16	4	4	4	4			3	1	4	4		6	82	92	8	198	248
		14	8	18	42	22	26	35	26	18	34	40	48			80	6	
	2		2	4	1			1	1	2	1	3	1	4		4		
					1	1		1	1			2	3	1	5			
1	1	2			1	1	1	1	1	1	3	5	2	1	1			
	4	1	3		1			4	2		3	8	8			6	6	
				1	1		1	1	1				8	2		1	1	
2	2		2	2			3	3			1	2			4		2	
	1		1			1			1	2	1	2		1		4		
				2	1	1	1	1	1	2	1	1	2	1	1	1	2	
	1			1	1	1	1	1	1	1	5	1	2	1	1	1	3	
				2			2	2		1				2				
						1	1					1		1	1			
42	38	49	48	44	68	54	69	71	65	72	82	88	132	188	214	244	890	850
		6	4	12	10		4	6	4	4			12		16	8	8	
2	1	1						1			1	1						
	10	6	6	13	9	5	17	19	7	8	18	20	15	12	15	23	20	
																1	1	

Separate Parts.



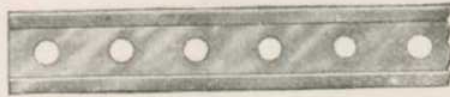
No 21



No. 28,



No. 27



No. 1.



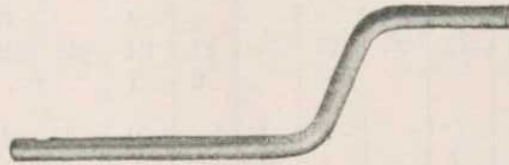
No, 9



No 23



No. 33



No. 19



No. 35.



No. 25.



No. 32.



No 12.



No 34.



No. 13.



No. 20.



No 24.