

MECCANO



(PATENTED)

INSTRUCTIONS

For the whole series of Models,
comprising thirteen progressive outfits

9^d

Copyright by **MECCANO LIMITED. LIVERPOOL,** throughout the world

INTRODUCTION.

THE first piece of advice we would give to the beginner in "Meccano" is that he commences with Model No. 1, and that he erects every model in turn up to the capacity of his outfit. By that time he will have grown so familiar with the various parts of "Meccano," and will see its possibilities so clearly, that he will with little difficulty be able to build many other models of his own invention.

The charm of "Meccano" lies greatly in its endless variety, and until the user has commenced to apply his own inventive faculties to the hobby, he is not getting the enjoyment out of it which he should.

Every part of the outfit should first be taken from its box, examined, and its name committed to memory, so that the instructions in the Manual may be followed easily and rapidly.

The parts are all standardised, and are interchangeable, and they will be found to fit together easily and without forcing. The holes in the strips are of equal distance apart. The axles fit any of the holes, and their position in the various designs may be ascertained by counting the holes.

All the models shown are built upon sound and standard engineering principles, and the parts employed represent the main mechanical parts used in machinery, such as levers, beams, wheels, axles, pulleys, worm wheels, screws, bolts, keys, &c., so that as an introduction to the serious study of Mechanics the value of "Meccano" is very great indeed.

Each model may be taken in pieces, and the same parts may be used to make up other models. Additional parts can always be purchased from your dealer or from us.

We are at all times glad to correspond with users of "Meccano," and to assist them by suggestions or criticisms when difficulties occur with new models.

For the convenience of users of Meccano we have compiled a series of standard details frequently occurring in the construction of our models; and we would particularly draw attention to the illustrations of these on pages 2 and 3.

Fig. 1. Luggage Truck



(MADE WITH MECCANO)
OUTFIT NO. 1.)

PARTS REQUIRED.

- 3 2½" Perforated Strips.
- 6 Angle Brackets.
- 1 4½" Rod.
- 2 1" Pulley Wheels.
- 10 Nuts and Bolts.
- 2 Keys.
- 1 Large Rectangular Plate.

Fig 2. See Saw

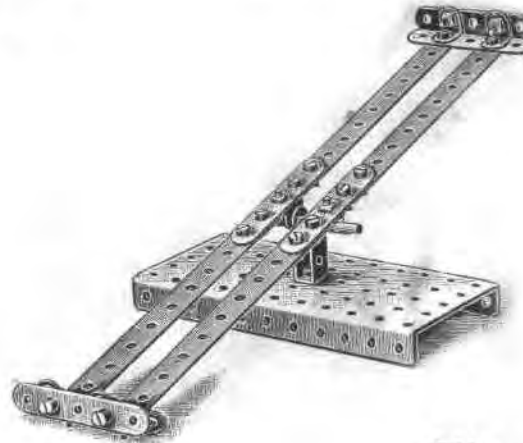

(MADE WITH MECCANO)
OUTFIT NO. 1.)

PARTS REQUIRED.

- 4 5½" Perforated Strips.
- 6 2½" " "
- 6 Angle Brackets.
- 1 2" Rod.
- 19 Nuts and Bolts.
- 2 Keys.
- 1 Single Bent Strip.
- 1 Large Rectangular Plate.

Fig. 3. Revolver Truck

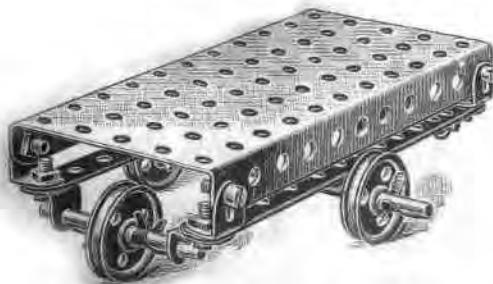

(MADE WITH MECCANO)
OUTFIT NO. 1.)

PARTS REQUIRED.

- 12 Angle Brackets.
- 1 4½" Rod.
- 2 2" " "
- 4 1" Pulley Wheels.
- 12 Nuts and Bolts.
- 6 Keys.
- 1 Large Rectangular Plate.

In a Revolver Truck the two end wheels are always raised just a little higher than the two centre wheels, so that the Truck may be quickly revolved upon the centre wheels.

Fig. 4. Truck

(MADE WITH MECCANO OUTFIT NO. 1.)

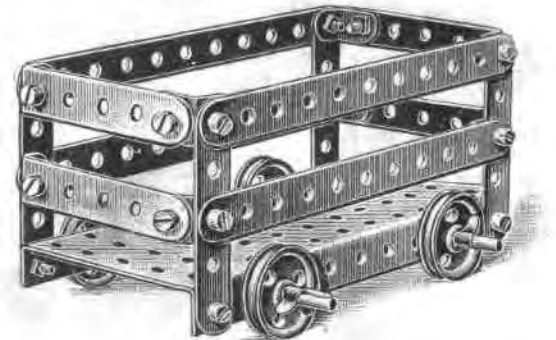

PARTS REQUIRED.

- | | |
|--------------------------|----------------------------|
| 4 5½" Perforated Strips. | 4 1" Pulley Wheels. |
| 8 2½" " " | 20 Nuts and Bolts. |
| 8 Angle Brackets. " | 4 Keys. |
| 2 4½" Rods. | 1 Large Rectangular Plate. |

Fig. 5. Luggage Truck

(MADE WITH MECCANO OUTFIT No. 1.)

PARTS REQUIRED.

2	5½" Perforated Strips	2	1" Pulley Wheels
6	2½" " "	1	Bush Wheel
4	Angle Brackets	13	Nuts and Bolts
1	4½" Rod	6	Keys
2	2" "	1	Single Bent Strip
		1	Large Rectangular Plate

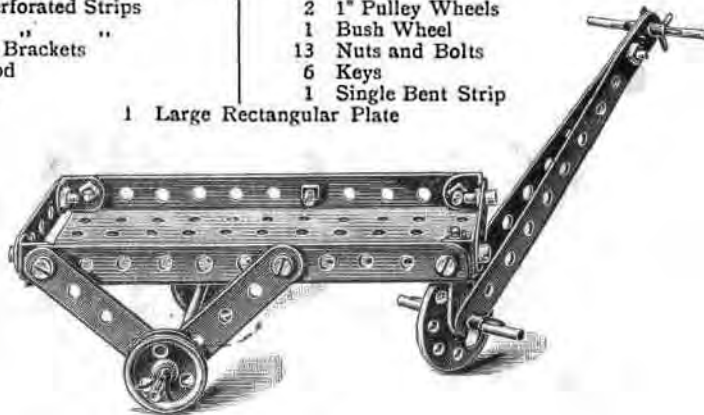

Fig. 6. Bath Chair

(MADE WITH MECCANO OUTFIT No. 1.)

PARTS REQUIRED.

2	5½" Perforated Strips	3	1" Pulley Wheels
9	2½" " "	20	Nuts and Bolts
6	Angle Brackets	6	Keys
1	4½" Rod	1	Single Bent Strip
2	2" "	1	Large Rectangular Plate

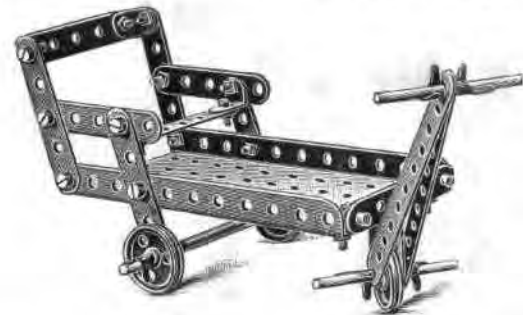

Fig. 7. Go Chair

(MADE WITH
MECCANO OUTFIT
No. 1.)

PARTS REQUIRED.

2	5½" Perforated Strips.
9	2½" " "
4	Angle Brackets. "
2	4½" Rods.
4	1" Pulley Wheels.
17	Nuts and Bolts.
4	Keys.

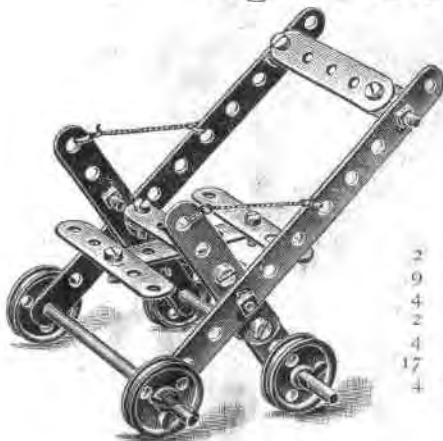

Fig. 8. Luggage Truck

(MADE WITH MECCANO
OUTFIT No. 1.)

PARTS REQUIRED.

2	5½" Perforated Strips.
9	2½" " "
2	Angle Brackets.
1	4½" Rod.
2	1" Pulley Wheels.
12	Nuts and Bolts.
2	Keys.
1	Large Rectangular Plate.

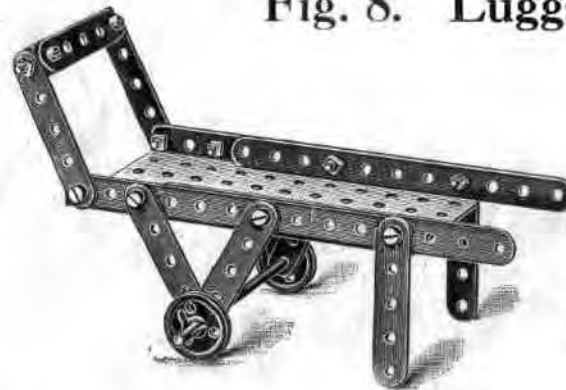
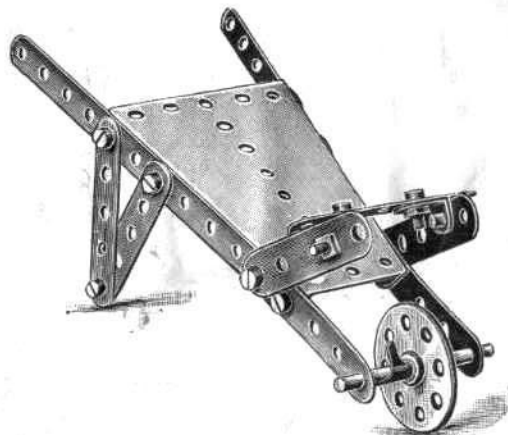

Fig. 9. Luggage Barrow

(MADE WITH MECCANO OUTFIT NO. 1.)



PARTS REQUIRED.

- | | | |
|----|------------------------|----|
| 2 | 5½" Perforated Strips. | m. |
| 9 | 2½" | m. |
| 2 | Angle Brackets. | |
| 1 | 2" Rod. | |
| 1 | Bush Wheel. | |
| 14 | Nuts and Bolts. | |
| 2 | Keys. | |
| 1 | Sector Plate. | |

Fig. 10. Truck

(MADE WITH MECCANO OUTFIT NO. 1.)

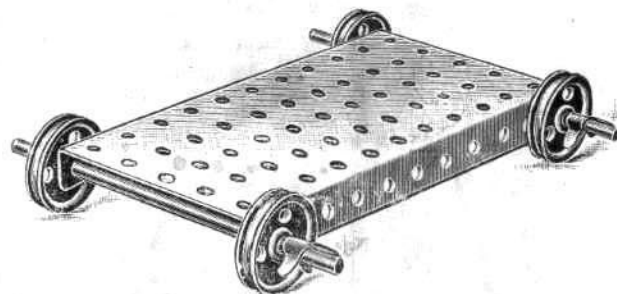

PARTS REQUIRED.

- | | | | |
|---|-------------------|---|--------------------------|
| 2 | 4½" Rods. | 4 | Keys. |
| 4 | 1" Pulley Wheels. | 1 | Large Rectangular Plate. |

Fig. 11. Endless Rope Railway

(MADE WITH MECCANO OUTFIT NO. 1.)

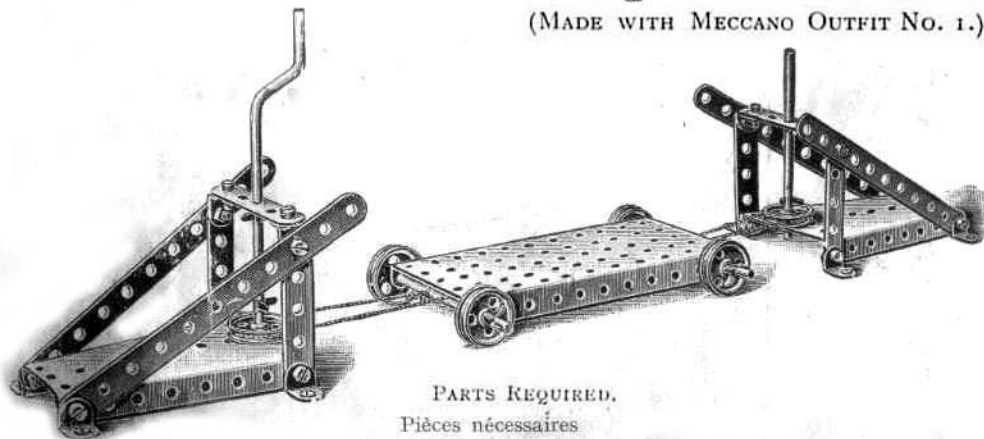

PARTS REQUIRED.

Pièces nécessaires

- | | | | | | |
|----|------------------------|----|-------------------|---|--------------------------|
| 4 | 5½" Perforated Strips. | 3 | 4½" Rods. | 8 | Wood Screws. |
| 6 | 2½" | 1 | Crank Handle. | 8 | Keys. |
| 12 | Angle Brackets. | 6 | 1" Pulley Wheels. | 1 | Large Rectangular Plate. |
| | | 16 | Nuts and Bolts. | 2 | Sector Plates. |

This is an attractive little combination working model, which will well repay a little trouble in making.

The truck is connected to an endless cord which passes from a pulley attached to a bracket at one end to another pulley carried on the crank handle shown. In the illustration the two pulleys are shown close together to save space, but they may, of course, be placed at any distance desired.

A piece of string is formed into an endless rope running over the two pulleys, and the truck is attached to one side of the string, so that by rotating the handle in one direction or another the truck is moved as desired.

Fig. 12. Windmill

(MADE WITH MECCANO
OUTFIT NO. 1.)

PARTS REQUIRED.

- 4 12½" Perforated Strips
- 4 5½" " "
- 9 2½" " "
- 6 Angle Brackets.
- 1 4½" Rod.
- 1 Crank Handle.
- 2 1" Pulley Wheels.
- 1 Bush Wheel.
- 20 Nuts and Bolts.
- 9 Keys.
- 1 Large Rectangular Plate.

This model may be driven by a small engine or other suitable motive power.

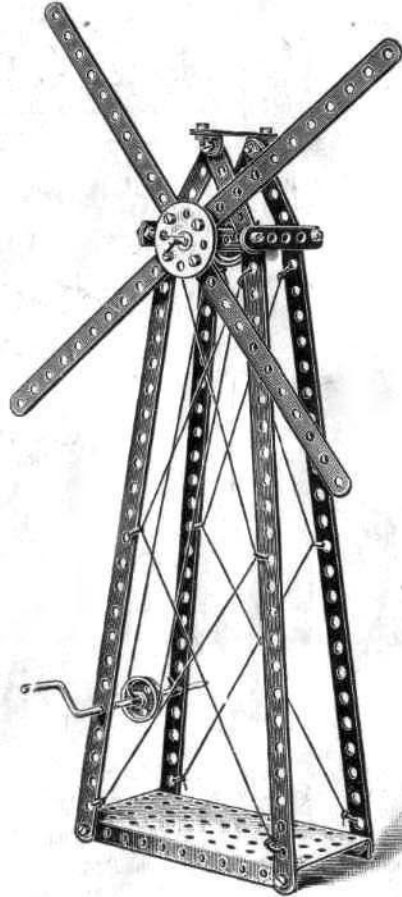

Fig. 13. Swing

(MADE WITH MECCANO OUTFIT NO. 1.)

PARTS REQUIRED.

- 4 12½" Perforated Strips.
- 1 5½" " "
- 9 2½" " "
- 10 Angle Brackets.
- 18 Nuts and Bolts.
- 4 Wood Screws. angulaire
- 1 Large Rectangular Plate.



Fig. 14. Railway Signal

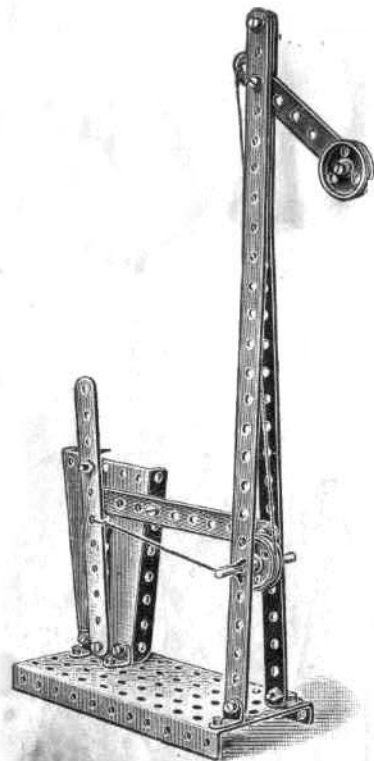

(MADE WITH MECCANO
OUTFIT NO. 1.)

PARTS REQUIRED.

- 2 12½" Perforated Strips.
- 2 5½" " "
- 1 3½" " "
- 6 Angle Brackets.
- 1 2" Rod.
- 2 1" Pulley Wheels.
- 18 Nuts and Bolts.
- 2 Keys.
- 1 Large Rectangular Plate.
- 1 Sector Plate.

In fixing the lever to the sector plate at the bottom, lock the nuts so as to prevent the screw from working out.

Fig. 15. Model of Telpher Span.

(MADE WITH MECCANO OUTFIT NO. 1.)

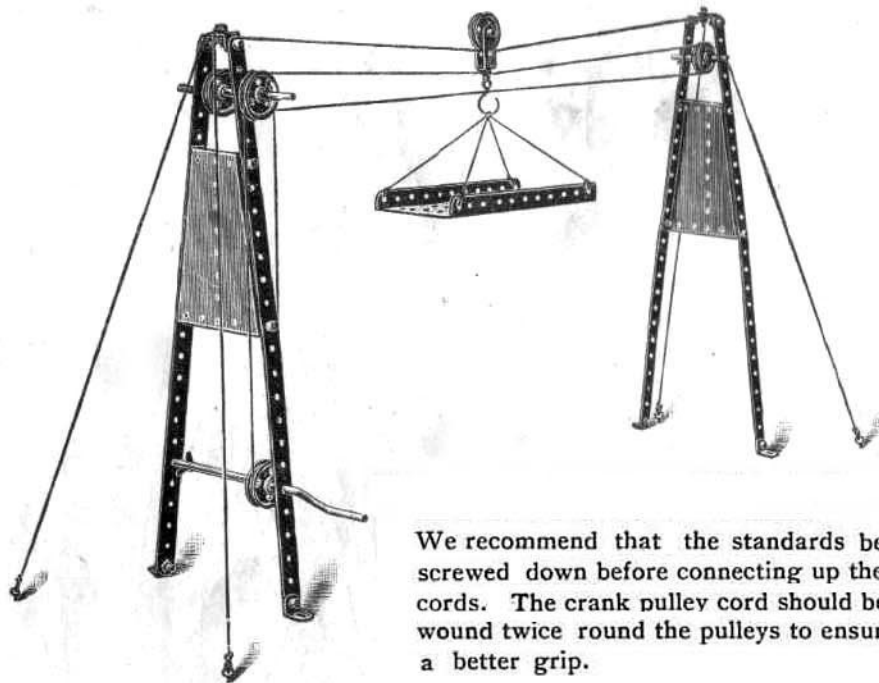

We recommend that the standards be screwed down before connecting up the cords. The crank pulley cord should be wound twice round the pulleys to ensure a better grip.

PARTS REQUIRED.

- | | | |
|---------------------------|---------------------|----------------------------|
| 4 12½" Perforated Strips. | 1 Crank Handle. | 1 Hook. |
| 8 Angle Brackets. | 5 1" Pulley Wheels. | 9 Keys. |
| 1 4½" Rod. | 19 Nuts and Bolts. | 1 Single Bent Strip. |
| 1 2" " | 4 Wood Screws. | 1 Large Rectangular Plate. |
| | | 2 Sector Plates. |

Fig. 16. Travelling Jib Crane

(MADE WITH MECCANO OUTFIT NO. 1.)

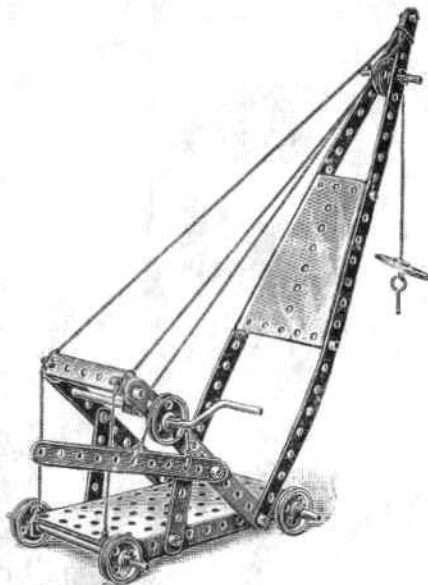

PARTS REQUIRED.

2 12½" Perforated Strips.	6 1" Pulley Wheels.
3 5½" " "	1 Bush Wheel.
3 2½" " "	17 Nuts and Bolts.
2 Angle Brackets.	1 Hook.
2 4½" Rods.	8 Keys.
1 2" Rod.	1 Large Rectangular Plate
1 Crank Handle,	1 Sector Plate.

Fig. 17. Scales

(MADE WITH MECCANO OUTFIT NO. 1.)



PARTS REQUIRED.

2 12½" Perforated Strips.	19 Nuts and Bolts.
3 5½" " "	4 Wood Screws.
3 2½" " "	1 Large Rectangular Plate.
8 Angle Brackets.	2 Sector Plates.

Fig. 25. Ladder on Wheels

(MADE WITH MECCANO OUTFIT NO. 2, OR NO. 1 AND NO. 1A.)

PARTS REQUIRED.

- 6 12½" Perforated Strips.
- 10 2½" " "
- 12 Angle Brackets.
- 2 5" Rods.
- 4 Flanged Wheels.
- 36 Nuts and Bolts.
- 4 Keys.
- 1 Large Rectangular Plate.

*Parts required in addition to
Outfit No. 1.*

- 2 12½" Perforated Strips.
- 2 5" Rods.
- 4 Flanged Wheels.
- 11 Nuts and Bolts.

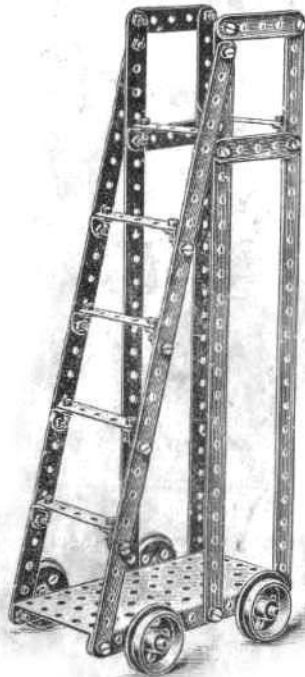
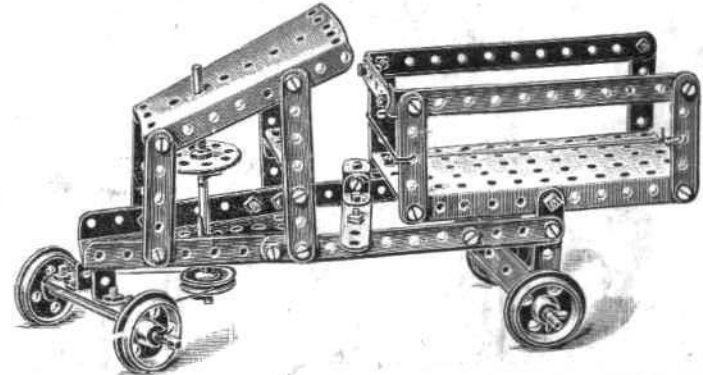

Fig. 26. Tipping Motor Wagon

(MADE WITH MECCANO OUTFIT NO. 2, OR NO. 1 AND NO. 1A.)



PARTS REQUIRED.

- 4 5½" Perforated Strips.
- 2 3½" " "
- 14 2½" " "
- 11 Angle Brackets. "
- 3 5" Rods.
- 4 Flanged Wheels.
- 1 1" Pulley.
- 1 Bush Wheel.
- 45 Nuts and Bolts.
- 11 Keys.
- 1 Double Bent Strip.
- 1 Large Rectangular Plate.
- 2 Sector Plates.

*Parts required in addition to
Outfit No. 1.*

- 1 3½" Perforated Strip.
- 4 2½" " "
- 3 5" Rods.
- 4 Flanged Wheels.
- 20 Nuts and Bolts.
- 2 Keys.
- 1 Double Bent Strip.

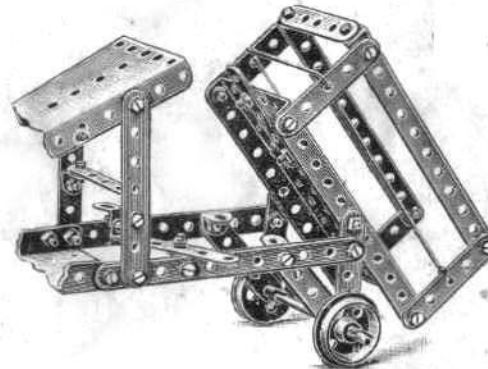

Fig. 27. Travelling Jib Crane

(MADE WITH MECCANO OUTFIT NO. 2 OR NO. 1 AND NO. 1A.)

This is so important a model that we have thought it best to give a detailed description of it, making use of engineering terms. It can be erected from a study of the illustration alone, but we strongly recommend our enthusiastic young friend to carefully read our instructions, and to make himself familiar with the correct technical description and terms. This model will well repay the time expended on a close and careful study.

The lower horizontal sides of the crane should first be put together. Each side consists of an angle girder joined to a rectangular plate, two holes overlapping. The winch frame at the end is formed of two sector plates bolted to the rectangular plate and connected together at their tops by two $2\frac{1}{2}$ " strips. The wheel axles are inserted through appropriate holes in the ends of the horizontal frame.

The bearings for the winch handle are formed by two holes in the sector plates; the winch handle has a pinion, and a ratchet is pivoted to the right-hand sector plate. A brake wheel and lever may be added if desired.

Each side of the jib is constructed of two $12\frac{1}{2}$ " strips, jointed together by overlapping; at the top where the sides meet a pulley is fixed on a short length of spindle, and at the bottom the two sides are respectively screwed to the two ends of the horizontal base.

The jib is braced by two diagonally arranged $12\frac{1}{2}$ " strips attached to the sides of the jib by angle pieces.

From each side of the jib two $12\frac{1}{2}$ " strips are carried to a truss member, formed of two $12\frac{1}{2}$ " strips united together, secured at one end to the screws at the base of the jib, and united at their other ends by a $2\frac{1}{2}$ " strip. The truss frame is connected to the horizontal base by two $5\frac{1}{2}$ " strips as shown.

The rope by which the weight is raised has one end fixed to the end of the jib; it is then passed round the pulley block, then over the jib pulley, and finally connected to the winch handle.

The crane is further strengthened by strings to represent tie rods, which connect the ends of the jib, the truss frame, and the winch frame as shown. If possible, the joint between the truss frame, the side frame, and the jib, should be made with a single pair of screws which should also carry the angle pieces for the cross bracing of the crane.

PARTS REQUIRED.	
10	$12\frac{1}{2}$ " Perforated Strips
2	$5\frac{1}{2}$ " " "
4	$2\frac{1}{2}$ " " "
2	Angle Girders
6	Angle Brackets
2	5" Rods
2	2" " "
1	Crank Handle
4	Flanged Wheels
2	1" Pulley Wheels
1	Bush Wheel
1	$\frac{1}{2}$ " Pinion
1	Pawl
35	Nuts and Bolts
1	Hook
10	Keys
1	Single Bent Strip
1	Large Rectangular Plate
2	Sector Plates

Parts required in addition to Outfit No. 1

6	$12\frac{1}{2}$ " Perforated Strips
2	Angle Girders
2	5" Rods
4	Flanged Wheels
1	$\frac{1}{2}$ " Pinion
1	Pawl
10	Nuts and Bolts
1	Key

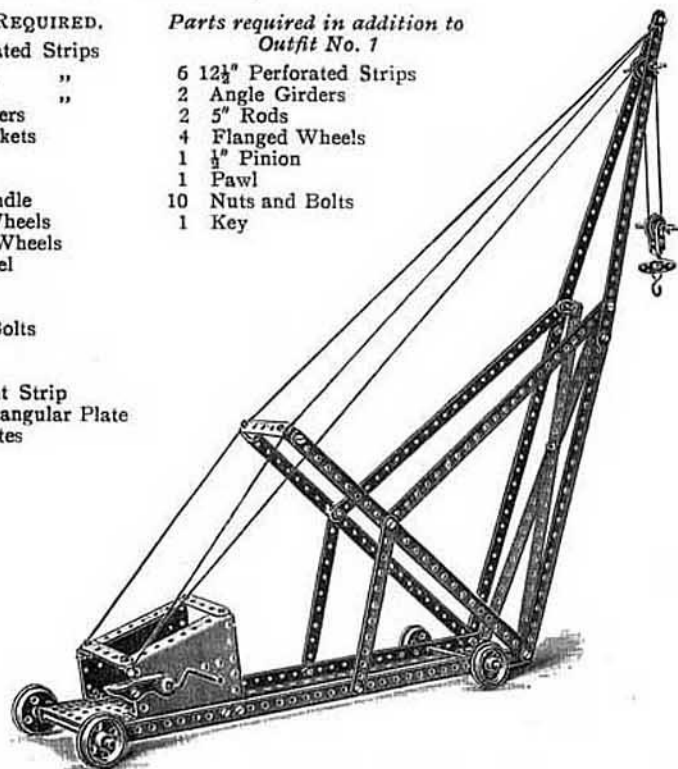

Fig. 28. Windmill

(MADE WITH MECCANO OUTFIT NO. 2 OR NO. 1 AND NO. 1A.) 1A)

PARTS REQUIRED.

10	12½" Perforated Strips	1	Crank Handle.
13	5½" " "	2	1" Pulley Wheels.
2	3½" " "	1	Bush Wheel.
2	2½" " "	45	Nuts and Bolts.
4	Angle Girders.	10	Keys.
8	Angle Brackets.	2	Sector Plates.
1	5" Rod.		

Parts required in addition to Outfit No. 1.

6	12½" Perforated Strips.	4	Angle Girders.	20	Nuts and Bolts.
7	5½" " "	1	5" Rod.		

This model requires no special instructions. We would, however, say that with the assistance of the parts contained in the succeeding outfits a more elaborate mechanism may be arranged to enable it to be driven by an engine or other suitable motive power.

This model also lends itself to further decorations by means of coloured ribbons used in the place of the cord lacings; or as streamers.



Fig. 29. Wheel

PARTS REQUIRED.

5	12½" Perforated Strips.
14	5½" " "
2	2½" " "
4	Angle Girders.
16	Angle Brackets.
2	5" Rods.
4	Flanged Wheels.
1	1" Pulley Wheel.
48	Nuts and Bolts.
6	Keys.

Parts required in addition to Outfit No. 1.

1	12½" Perforated Strip.
8	5½" " "
4	Angle Brackets.
2	5" Rods.
4	Angle Girders.
4	Flanged Wheels.
23	Nuts and Bolts.

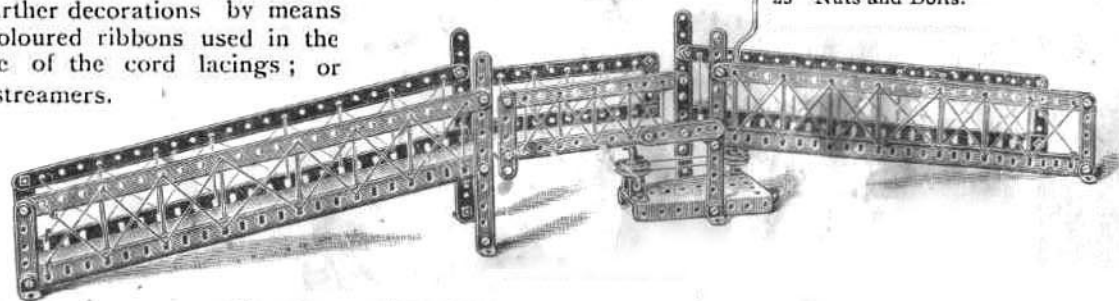
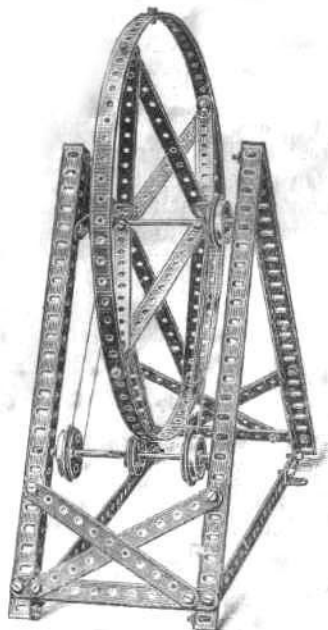

Fig. 30. Swing Bridge

PARTS REQUIRED.

4	12" Perforated Strips.	1	2" Rod.	4	Keys.
6	5½" " "	1	Crank Handle.	1	Double Bent Strip.
13	2½" " "	2	1" Pulley Wheels.	1	Large Rectangular Plate.
4	Angle Girders.	1	Bush Wheel.	1	Sector Plate.
8	Angle Brackets.	41	Nuts and Bolts.		

Parts required in addition to Outfit No. 1.

3	2½" Perforated Strips.
4	Angle Girders.
16	Nuts and Bolts.
1	Double Bent Strip.

Fig. 31. Bridge with Signals

Fig. 32. Roundabout See Saw

(MADE WITH MECCANO OUTFIT NO. 2 OR NO. 1 AND NO. 1A.)

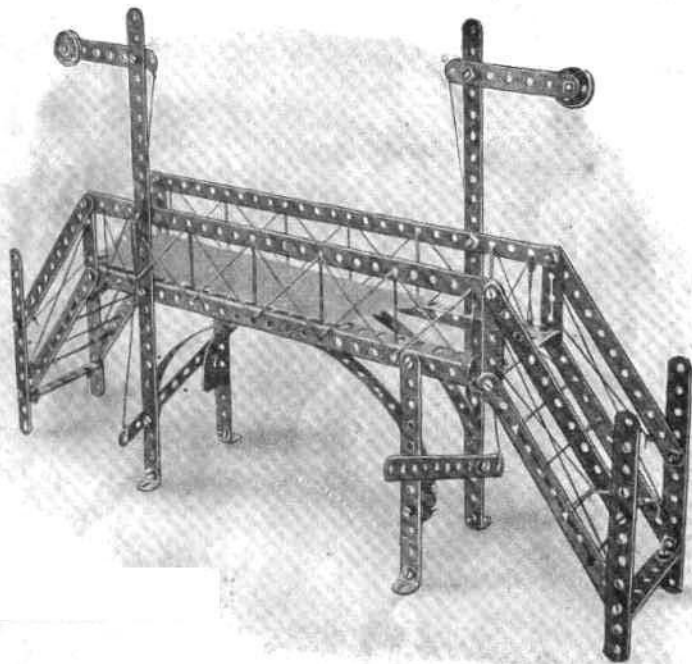

PARTS REQUIRED.

- 6 12½" Perforated Strips.
- 16 5½" " "
- 2 3½" " "
- 8 2½" " "
- 2 Angle Girders.
- 8 Angle Brackets.
- 2 1" Pulley Wheels.
- 50 Nuts and Bolts.

*Parts required in addition to
Outfit No. 1.*

- 2 12½" Perforated Strips
- 10 5½" " "
- 1 3½" " "
- 2 Angle Girders.
- 25 Nuts and Bolts.

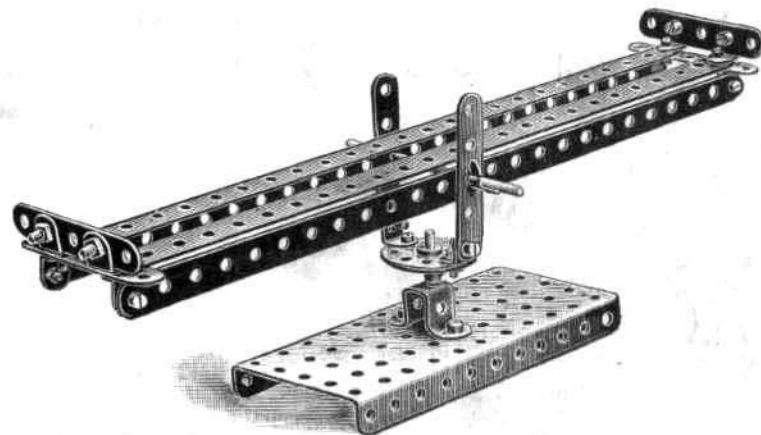

PARTS REQUIRED.

- 4 12½" Perforated Strips.
- 6 2½" " "
- 10 Angle Brackets.
- 1 4½" Rod.
- 1 Bush Wheel.
- 18 Nuts and Bolts.
- 2 Keys.
- 1 Double Bent Strip.
- 1 Large Rectangular Plate.

*Parts required in addition
to Outfit No. 1.*

- 1 Double Bent Strip.

Fig. 41. Cable Railway

(MADE WITH MECCANO OUTFIT NO. 3 OR WITH NO. 2 AND NO. 2A.)

Parts required in addition to Outfits.

PARTS REQUIRED.	No. 1	No. 2
3 5½" Perforated Strips	—	—
2 3" " "	2	2
1 2½" " "	—	—
2 Angle Girders	2	—
6 Angle Brackets	—	—
3 5" Rods	3	—
3 4½" " "	—	—
4 Flanged Wheels	4	—
1 1½" Pulley Wheel	1	1
2 1" " "	—	—
2 ½" Pinions	2	2
1 Gear Wheel	1	1
2 ¾" Contrate Wheels	2	2
28 Nuts and Bolts	3	—
18 Keys	9	7
1 Large Bent Strip	1	1
2 Large Rectangular Plates	1	1
3 Small " "	3	3
2 Sector Plates	—	—

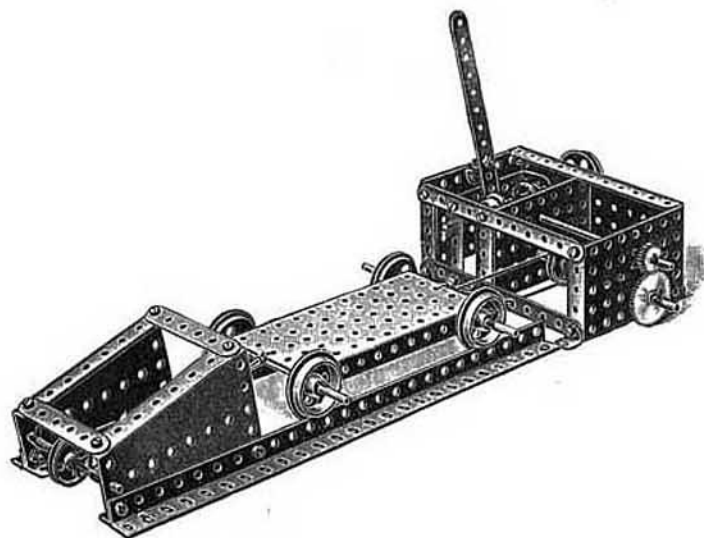

Our illustration hardly does this excellent model justice, owing to the parts having to be so crowded together. This is a very fine model, both instructive and highly interesting.

The driving power is received at the outer 1½" pulley, and is transmitted through the clutch mechanism and the pinion and gear wheels to the lower spindle on which the driving pulley is fixed, the driving rope passing round this pulley and the second pulley at the end of the rails, all as shown in the drawing.

In fixing the lever for operating the clutch mechanism, the nuts should be locked to prevent the screw working out. Only one section of rails is shown in the design, but they may be extended as desired.

Fig. 42. Swing Bridge

(MADE WITH MECCANO OUTFIT NO. 3 OR NO. 2 AND NO. 2A.)

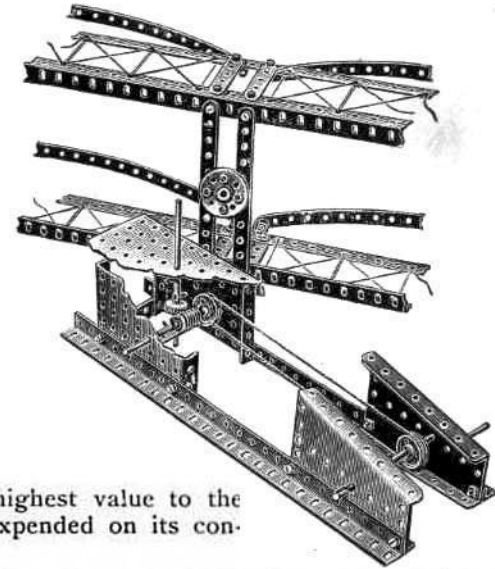
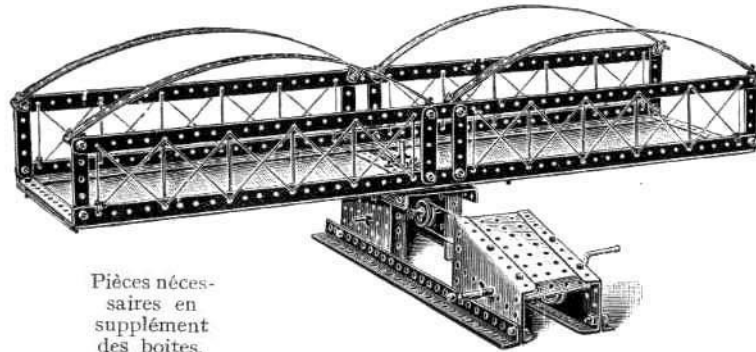

Pièces nécessaires en supplément des boîtes.

Pièces nécessaires.

	No. 1	No. 2
8 12½" Perforated Strips	4	—
4 5½" " "	—	—
9 2½" " "	—	—
6 Angle Girders	6	2
10 Angle Brackets	—	—
2 4½" Rods	—	—
1 Crank Handle	—	—
2 1" Pulleys	—	—
1 Bush Wheel	—	—
1 ½" Pinion	1	—
1 Worm Wheel	1	1
60 Nuts and Bolts	40	10
11 Keys	2	—
1 Large Rectangular Plate	—	—
3 Small " "	3	3
2 Sector Plates	—	—

This is a fine engineering model of the highest value to the young student, and any thought and care expended on its construction will be well repaid.

The base portion containing the perpendicular axle actuated by the worm and pinion should be constructed first. This, as will be seen by the illustration, is formed by connecting a small rectangular plate to an angle girder three holes from one end and a sector plate at the other end to form one side of the base. The other side is constructed in a similar manner. These two sides are then connected together at one end by a large rectangular plate containing the spindle, upon which the bridge swings, and at the other by a small rectangular plate. A 2½" strip is connected by two angle brackets to the angle girders to carry the lower portion of the perpendicular axle upon which the bridge swings. A ½" pinion is keyed to this axle, which is operated by the horizontal spindle upon which is keyed a worm wheel. A pulley wheel is also keyed to this spindle around which a driving rope passes from the pulley at the other end of the base keyed to a crank handle as shown in the illustration.

The platform is constructed by connecting two angle girders in the third holes. Two 2½" strips are attached to these in the centre and one at each end, with two 12½" strips along the top. Two 12½" strips are curved and connected by four angle brackets to form one side of the bridge. The other side is formed in a similar manner, and both are connected together by 5½" strips at the end and in the centre. Attached to the two 5½" strips in the centre is a bush wheel upon which the platform rotates.

Fig. 43. Tower Wagon

(MADE WITH MECCANO OUTFIT
No. 3 OR No. 2 AND No. 2A.)

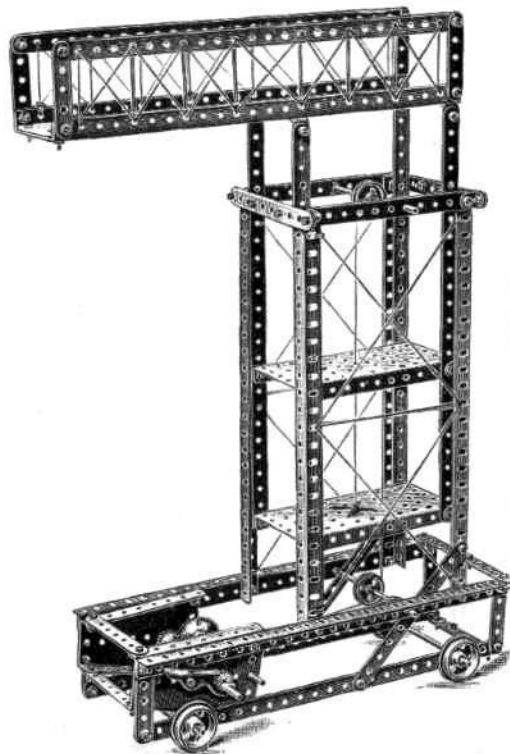

PARTS REQUIRED.

8	12½"	Perforated Strips.		
4	5½"	" "		
6	3½"	" "		
2	3"	" "		
13	2½"	" "		
8		Angle Girders		
18		Angle Brackets		
2	5"	Rods		
3	4½"	" "		
1		Crank Handle		
4		Flanged Wheels		
2	1"	Pulleys		
1	¾"	Pinion		
1	1½"	" "		
1		Gear Wheel		
1		Pawl		
69		Nuts and Bolts		
18		Keys		
2		Large Rectangular Plates		
2		Sector Plates		

This is a representation of a wagon used for repairing overhead electrical wires carrying the current for street cars. Each part is shown clearly in our illustration, and little difficulty will be experienced in its construction.

Fig. 44. Pile Driver x

(MADE WITH MECCANO OUTFIT
No. 3 OR No. 2 AND No. 2A.)



PARTS REQUIRED.

2	12½"	Perforated Strips		
1	3½"	" "		
2	3"	" "		
10	2½"	" "		
2		Angle Girders		
8		Angle Brackets		
2	5"	Rods		
2	4½"	" "		
1		Crank Handle		
4		Flanged Wheels		
1	1½"	Pulley Wheel		
1	1"	" "		
1	¾"	Pinion		
1		Gear Wheel		
42		Nuts and Bolts		
16		Keys		
1		Double Bent Strip		
1		Large Rectangular Plate		
1		Small Rectangular Plate		

This illustration shows a model pile driver in which the pile head is guided on the two vertical angle girders. The raising of the pile head is controlled from the main driving shaft through the pinion and gear wheel. This latter being mounted on the end of the pivotted lever, and in order to drop the pile head the lever is raised to free the gear wheel. A grooved pulley is fitted on the pinion shaft to enable the model to be driven from an engine.

Fig. 45. Swivelling & Luffing Jib Crane

(MADE WITH MECCANO OUTFIT NO. 3 OR NO. 2 AND NO. 2A.)

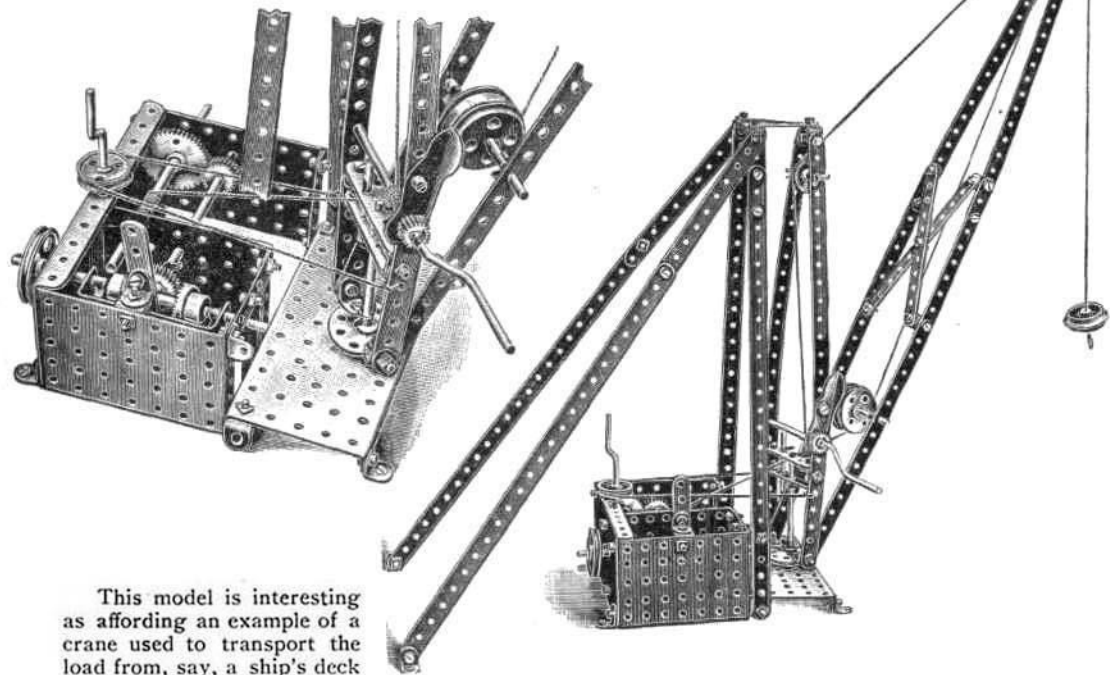

This model is interesting as affording an example of a crane used to transport the load from, say, a ship's deck on to a quay, by "luffing" or altering the angle of the jib. The apparatus consists of two parts, a fixed frame and a swivelling and luffing jib. The construction of the fixed frame with the reversing frame and lever should present no difficulties.

The two 12 1/2" upright strips are braced together as shown, and are held in vertical position by the two 12 1/2" connected to two 5 1/2" strips rear-wardly sloping pieces, and from the structure so formed the reversing frame is carried.

The swivelling piece of the jib consists of two 12 1/2" strips bent as shown, connected at the bottom by a bush wheel and at the sixth hole up by two 2 1/2" strips. A 4 1/2" rod is passed through the centre hole of these 2 1/2" strips, and the bush wheel into the bottom plate to form the lower pivot; the upper pivot is formed with an angle bracket, having a screw, carried in the triangle formed of 2 1/2" strips attached to the fixed frame.

The jib itself consists of two pairs of 12 1/2" strips connected and braced together as shown. The jib luffs about its connection to the swivelling frame, and is thus capable of two motions—a swivelling motion and a luffing motion.

The luffing motion is effected by the luffing rope, which is coiled round the handle shown, and then passes round the pulley at the top of the swivelling frame, the other end being attached to the head of the jib. In order to keep the hoisting rope in position when the crane is swivelled, the two guide rods carried on the swivelling frame are provided.

By operating the luffing handle the jib may be put at any angle from nearly horizontal to nearly vertical, the crane thus acting as a transporter of the load.

Parts required in addition to Outfits

PARTS REQUIRED.		No. 1	No. 2
10	12 1/2" Perforated Strips	6	—
4	5 1/2" " "	—	—
9	2 1/2" " "	—	—
24	Angle Brackets	14	8
3	5" Rods	3	—
2	4 1/2" " "	—	—
3	2" " "	1	1
2	Crank Handles	1	1
3	Flanged Wheels	3	—
1	1 1/2" Pulley	1	1
3	1" " "	—	1
1	Bush Wheel	—	—
2	2 1/2" Pinions	2	2
1	1 1/2" " "	1	—
1	Gear Wheel	1	1
2	3/4" Contrate Wheels	m. 2	2
1	Pawl	1	—
69	Nuts and Bolts	49	19
1	Hook	—	—
22	Keys	13	11
1	Large Bent Strip	1	1
2	Large Rectangular Plates	1	1
3	Small " "	3	3

Fig. 45. Pit Headgear

(MADE WITH MECCANO OUTFIT NO. 3 OR NO. 2 AND 2A.)

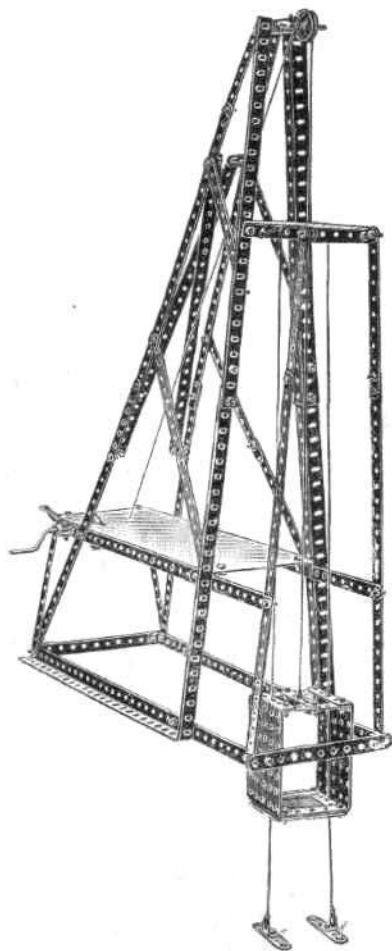

PARTS REQUIRED.	Parts required in addition to Outfits	
	No. 1	No. 2
8 12½" Perforated Strips	4	—
18 5½" " "	14	2
2 3½" " "	1	—
9 2½" " "	—	—
8 Angle Girders	8	4
14 Angle Brackets	4	—
1 4½" Rod	—	—
1 2" Rod	—	—
1 Crank Handle	—	—

PARTS REQUIRED.	Parts required in addition to Outfits	
	No. 2	No. 2A
1 1" Pulley	—	—
1 ¼" Pinion	1	1
1 ½" " "	1	—
1 Gear Wheel	1	1
1 Pawl	1	—
70 Nuts and Bolts	50	20
6 Keys	—	—
3 Small Rectangular Plates	3	3

This is a most interesting model, showing the principle upon which minerals are raised from below the ground.

The front main uprights are formed by two angle girders overlapped in the third hole. Each of these two uprights are fastened together at the top by two angle brackets. Two 2½" strips are bolted horizontally at the top to carry the wheel over which the winding rope runs, and to connect the diagonal stays. To stiffen the structure one 5½" strip is fixed on each side connected in the eighteenth hole down on the upright, and the eleventh hole down on the stays. Two more 5½" strips are bolted together, and fastened on each side lower down.

The framework in which the cage moves is formed by connecting a 5½" strip with a 12½" strip in the second hole to form the uprights. These are connected by 5½" strips to the main uprights. The framework takes the same angle as the main uprights, and is connected at the top by a small rectangular plate and two angle brackets, and at the bottom by a 5½" strip.

The cage is formed by connecting two small rectangular plates by two 2½" strips at the top and bottom. Another 2½" strip is bolted in the centre at the top, to which is attached the hoisting rope.

The guide ropes are connected to the small rectangular plate at the top of the framework, passed through the holes at each side of the cage, and connected with two 2½" strips screwed to the floor.

The hoisting mechanism is operated by the crank handle, upon which is keyed a ¼" pinion engaging a gear wheel connected with the spindle over which the hoisting rope is wound.

Fig. 47. Level Crossing Gates

(MADE WITH MECCANO OUTFIT NO. 3 OR NO. 2 AND NO. 2A.)

Parts required
in addition
to Outfits

PARTS REQUIRED.	No. 1		No. 2	
	No. 1	No. 2	No. 1	No. 2
9 5½" Perforated Strips	5	—	—	—
4 3½" " "	3	2	—	—
2 3" " "	2	2	—	—
10 2½" " "	1	—	—	—
6 Angle Girders	6	2	—	—
24 Angle Brackets	14	8	—	—
4 5" Rods	4	1	—	—
4 1" Pulley Wheels	—	2	—	—
54 Nuts and Bolts	34	4	—	—
4 Keys	—	—	—	—
2 Large Rectangular Plates	1	1	—	—

This model, if constructed with care, is a most admirable one, as the gates are opened simultaneously by the operation of one lever.

To construct it, commence by taking two angle girders and connecting them together at each end with a 5½" strip placed perpendicularly between them to form the supports of one pair of gates as shown in Figure 47. The supports for the

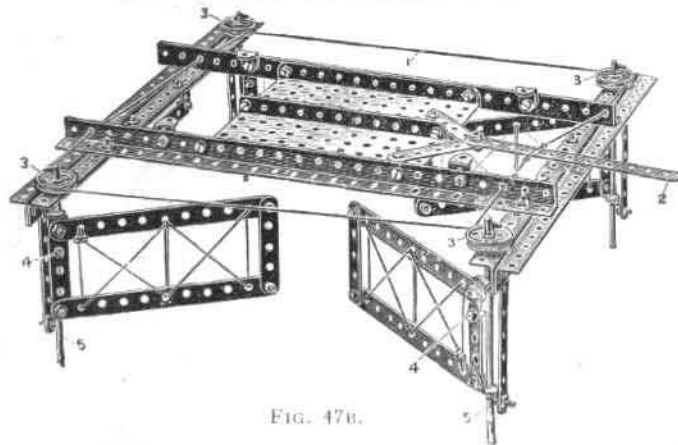

FIG. 47b.

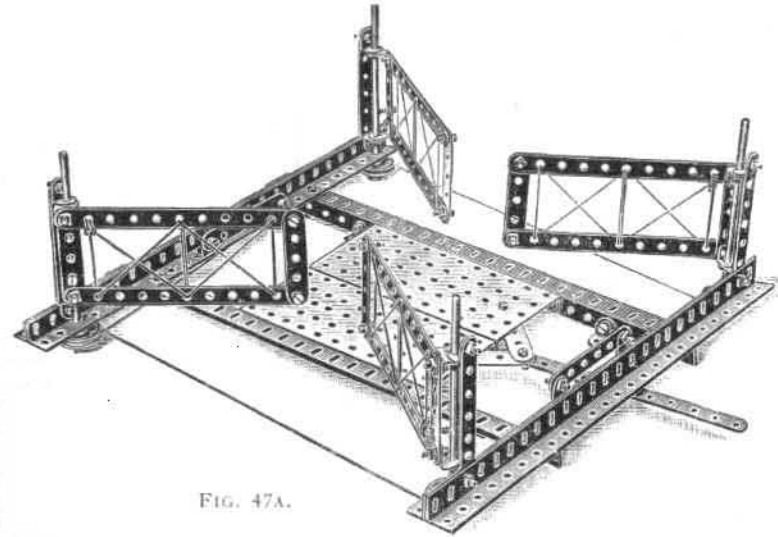

FIG. 47a.

other pair of gates are arranged in a similar manner. These two structures are connected by two other angle girders and two rectangular plates, as shown in the illustration.

The gates are formed by connecting two 5½" strips with two 2½" strips at one side of the gates; two angle brackets are attached to permit the axle rods to pass through upon which the gates swing.

Figure 47a is an inverted view showing the arrangement of operating cord 1 which is passed from the operating lever 2, around the corner pulleys 3, and back to the lever 2. In order to obtain a better grip on the pulleys, it is desirable to wind the operating cord twice around them. It is to be noted that the cord 1 is wound in opposite directions around the diagonal pairs of pulleys 3.

Pinching screws 4 are fitted in the inner sides of the gates to grip them to the spindles 5 so that all rotate together.

Fig. 48. Inclined Delivery Shoot

(MADE WITH MECCANO OUTFIT NO. 3 OR WITH NO. 2 AND NO. 2A.)

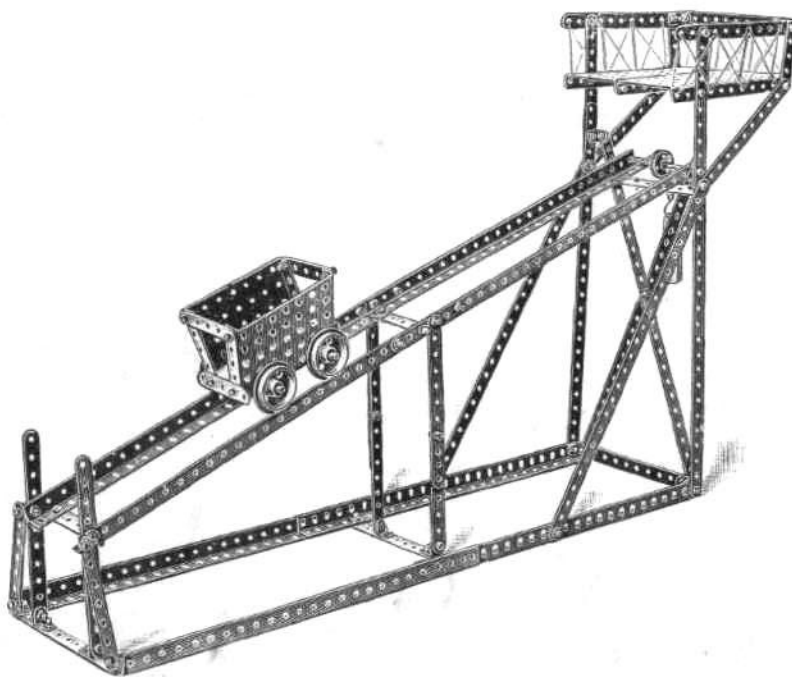

PARTS REQUIRED.

6	12½"	Perforated Strips	2	—
16	5½"	" "	12	—
4	3½"	" "	3	2
2	3"	" "	2	2
8	2½"	" "	—	—
8		Angle Girders	8	4
16		Angle Brackets	6	—
3	4½"	Rods	—	—
4		Flanged Wheels	4	—
1		1" Pulley Wheel	—	—
70		Nuts and Bolts	50	20
1		Hook	—	—
8		Keys	—	—
2		Large Rectangular Plates	1	1
2		Small " "	2	2

*Parts
required in
addition
to Outfits*

No. 1	No. 2
2	—
12	—
3	2
2	2
—	—
8	4
6	—
—	—
4	—
—	—
50	20
—	—
—	—
1	1
2	2

The model furnishes an illustration of the inclined plane. The loading platform at the extreme right delivers a load into the truck, which being now heavier than the balance weight, runs down the incline, and when at the bottom discharges its load by tipping. The weight immediately overcoming the empty truck returns it quickly to the loading platform.

Fig. 49. Fire Escape

(MADE WITH MECCANO OUTFIT NO. 3 OR NO. 2 AND NO. 2A.)

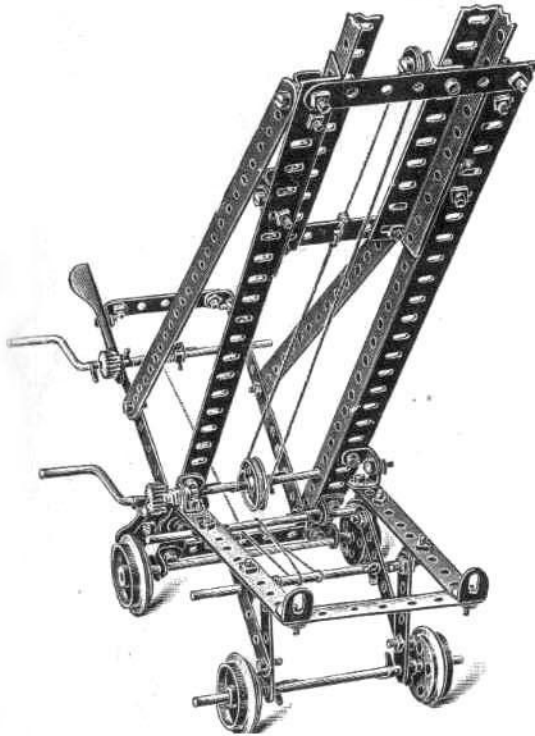

PARTS REQUIRED.

2	12½"	Perforated Strips		
4	5½"	" "		
3	3½"	" "	2	1
2	3"	" "	2	2
5	2½"	" "		
4		Angle Girders	4	
25		Angle Brackets	15	9
2		5" Rods	2	
3		4½" "		
2		Crank Handles	4	
4		Flanged Wheels	1	1
3		1" Pulley Wheels		1
1		½" " "	1	1
2		½" Pinions	2	1
2		Pawls	2	1
50		Nuts and Screws	30	
19		Keys	10	8

*Parts
required in
addition
to Outfit:*

No. 1	No. 2
—	—
—	—
2	1
2	2
—	—
4	—
15	9
2	—
—	—
4	—
1	1
—	1
1	1
2	1
2	1
30	—
10	8

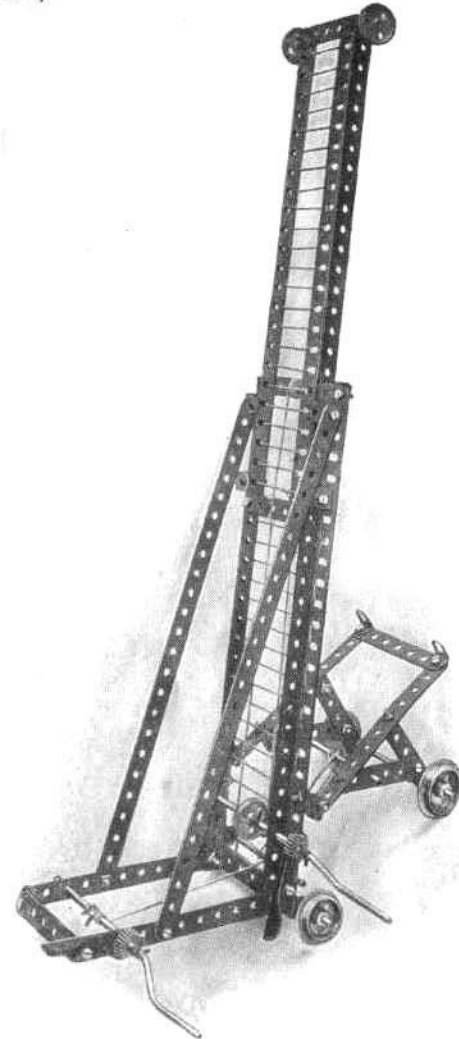

In constructing this model, take two angle girders and tie these together with 3½" strips at top and bottom. A 5½" strip is then attached at right angles to one end of the frame, diagonal stays tying these short strips to the angle brackets attached to the frame. The sliding frame is constructed from two angle girders reversed to those of the main frame, the angle girders of the sliding frame being tied together by two 2½" strips, and being retained and guided in the main carriage by the short angle brackets which act as clips. The framework of the running truck is very simply constructed, and is pivotally attached by angle brackets to the main frame.

Fig. 60. Flying Machine

(MADE WITH MECCANO OUTFIT NO. 4 OR NO. 3 AND NO. 3A.)

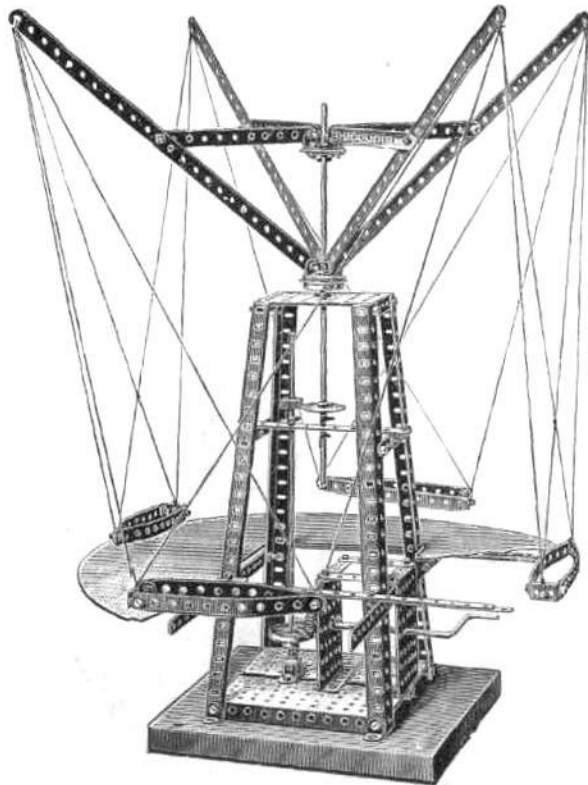

Parts required in addition to Outfits

PARTS REQUIRED.		No. 1	No. 2	No. 3
10	12½" Perforated Strips	6	—	—
13	5½" " "	9	—	—
2	3½" " "	1	—	—
2	2½" " "	—	—	—
4	Angle Girders	4	—	—
26	Angle Brackets	16	10	—
2	11½" Rods	2	2	2
1	Crank Handle	—	—	—
1	Flanged Wheel	1	—	—
1	Bush Wheel	—	—	—
2	¾" Pinions	2	2	—
1	Gear Wheel	1	1	—
1	1½" Contribute	1	1	1
74	Nuts and Bolts	54	24	4
11	Keys	2	—	—
1	Double Bent Strip	1	—	—
2	Large Rectangular Plates	1	1	—
3	Small " "	3	3	—

Most boys will have seen the Maxim Flying Machine at work, and will hardly fail to be interested in constructing a working model of it.

The main frame is composed of four angle girders connected at the bottom by two large rectangular plates separated one hole apart and connected together by two small rectangular plates carrying the crank handle, and at the top by a small rectangular plate. Across the centre on opposite sides in the ninth hole down is attached a 3½" strip connected together by a 5½" strip. These transverse 3½" and 5½" strips and the small rectangular plate at the top carry the perpendicular spindle upon which the upper structure revolves. A flanged wheel is keyed to this spindle to support the four arms, which are attached by four angle brackets. The arms are supported by means of 5½" strips connected to a bush wheel keyed on to the spindle, and the boats are connected to these by string arranged as shown in the illustration. The platform is supported by four 12½" strips attached to the sides of the main framework. The manner of constructing the mechanism for operating the model is clearly shown in the illustration.

Fig. 61. Travelling Crane

(MADE WITH MECCANO OUTFIT NO. 4 OR NO. 3 AND NO. 3A.)

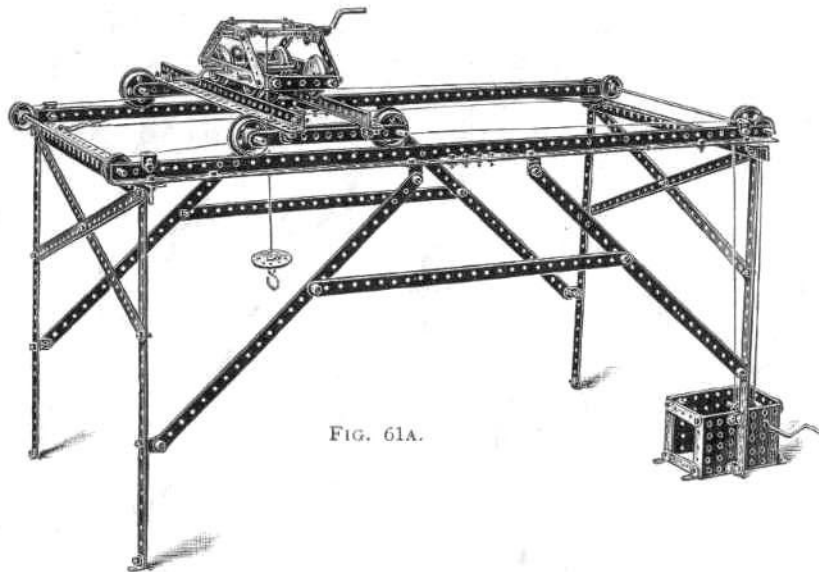

FIG. 61A.

Separate views are given of two distinct parts composing the travelling crane. Fig. 61 is a complete view of the structure showing the braced gantry carrying a rail at each side. The rails are formed by angle girders butt-jointed. FIG. 61A shows the construction of the travelling gantry with two pairs of wheels so arranged as to fit the gauge of the rails. The gantry is caused to travel to and fro on the rails by a cord which is connected to the gantry by a nut and bolt (1), and passes over a pulley at each end of the rail, keyed to the rod. On one of these rods is keyed a $1\frac{1}{2}$ " pulley carrying the driving cord, which passes over a pulley wheel keyed to the crank handle. The winch Fig. 61B again is arranged to run on the gantry rails of 61A, and is provided with a hoisting axle and one for traversing the winch.

Parts required in addition to Outfits

PARTS REQUIRED.	No.		
	1	2	3
14 $12\frac{1}{2}$ " Perforated Strips	10	4	4
6 $5\frac{1}{2}$ " " "	2	—	—
4 $3\frac{1}{2}$ " " "	4	4	2
16 $2\frac{1}{2}$ " " "	7	2	—
8 Angle Girders	8	4	—
39 Angle Brackets	29	23	13
2 $11\frac{1}{2}$ " Rods	2	2	2
2 $4\frac{1}{2}$ " " "	—	—	—
4 $2\frac{1}{2}$ " " "	2	2	1
3 Crank Handles	2	2	1
8 Flanged Wheels	8	4	4
1 $1\frac{1}{2}$ " Pulley Wheel	1	1	—
5 $1\frac{1}{2}$ " Pulleys	—	3	1
1 Bush Wheel	—	—	—
1 $\frac{3}{4}$ " Pinion	1	1	—
1 $\frac{1}{2}$ " " "	1	—	—
1 Gear Wheel	1	1	—
1 Pawl	1	—	—
1 Nuts and Bolts	85	55	35
1 Hook	—	—	—
22 Keys	13	11	—
2 Small Rectangular Plates	2	2	—

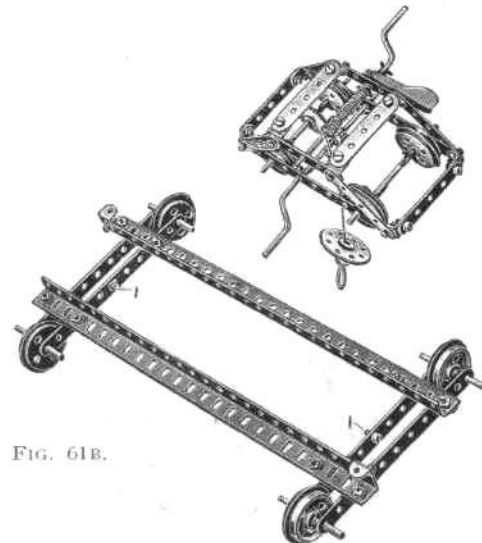
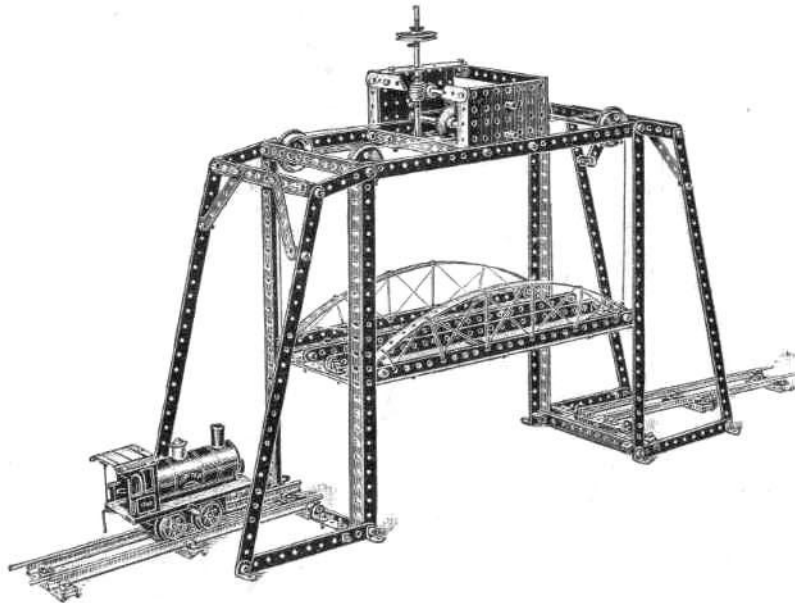

FIG. 61B.

FIG. 61C.

Fig. 62. Viaduct Bridge

(MADE WITH MECCANO OUTFIT NO. 4 OR NO. 3 AND NO. 3A.)



Parts required in addition to Outfits

PARTS REQUIRED.

8	12 $\frac{1}{2}$ "	Perforated Strips	4	—	—
19	5 $\frac{1}{2}$ "	" "	15	3	1
2	3 $\frac{1}{2}$ "	" "	1	—	—
4	3"	" "	4	4	2
4	2 $\frac{1}{2}$ "	" "	—	—	—
8		Angle Girders	8	4	—
44		Angle Brackets	34	28	18
2	6"	Rods	2	2	2
3	5"	" "	3	—	—
4		Flanged Wheels	4	—	—
1	$\frac{3}{4}$ "	Pinion	1	1	—
1	$\frac{1}{2}$ "	" "	1	—	—
1		Gear Wheel	1	1	—
1		Worm Wheel	1	1	—
102		Nuts and Bolts	82	52	32
15		Keys	6	4	—
2		Collars and Set Screws	—	—	—
2		Small Rectangular Plates	2	2	—

This model shows the construction of a suspended viaduct bridge, the central girder platform when lowered permitting the locomotive to pass along the continuous track, and is raised to enable ships to pass along the waterway beneath the gantry. The central movable girder platform is suspended from the corner cords, passing over the four pulley wheels, and is raised or lowered by the operation of the gear mechanism in the gear box on the top of the gantry. The grooved pulley wheel on the vertical driving shaft may be operated from an engine. The shaft carrying a worm gearing with a $\frac{1}{2}$ " pinion on a transverse shaft and a $\frac{3}{4}$ " pinion which in turn gears with a gear wheel on the winding spindle, operates the lifting cords. The operating cords are led on to the winding spindle in opposite directions so that when the spindle is being continuously driven in one direction all four cords wind on or off simultaneously.

The side rails and locomotive shown in the illustration are not included in the Outfit.

Fig. 63. Elevated Jib Crane

(MADE WITH MECCANO OUTFIT NO. 4 OR NO. 3 AND NO. 3A.)



PARTS REQUIRED.

2	12 $\frac{1}{2}$ "	Perforated Strips
11	5 $\frac{1}{2}$ "	" "
2	3 $\frac{1}{2}$ "	" "
4	2 $\frac{1}{2}$ "	" "
4	Angle Girders	" "
18	Angle Brackets	
2	11 $\frac{1}{2}$ "	Rods
2	5"	"
1	4 $\frac{1}{2}$ "	"
1	2"	"
8	Flanged Wheels	
2	1" Pulleys	
1	$\frac{3}{4}$ " Pinion	
1	$\frac{1}{2}$ " "	
1	Gear Wheel	
1	1 $\frac{1}{2}$ " Contrate	
67	Nuts and Bolts	
1	Hook	
21	Keys	
1	Single Bent Strip	
1	Double Bent Strip	
1	Large Bent Strip	
2	Large Rectangular Plates	
3	Small Rectangular Plates	
1	Sector Plate	
2	Eye Pieces	
1	Rubber Band	

Parts required in addition to Outfits

No. 1	No. 2	No. 3
—	—	—
7	—	—
1	—	—
—	—	—
4	—	—
8	2	—
2	2	2
2	—	—
—	—	—
—	—	—
8	4	4
—	—	—
1	1	—
1	—	—
1	1	—
1	1	1
47	17	—
—	—	—
12	10	—
—	—	—
1	—	—
1	1	—
1	1	—
3	3	—
—	—	—
2	2	2
1	1	1

The main framework is similar to Model 60, and the vertical winding spindle for hoisting is supported and driven from the lower pinion and contrate wheel in the same manner as in Model 60.

The main shaft is fitted with fast and loose pulleys, flanged wheels being used for this purpose.

The driving power is received at the outer 1 $\frac{1}{2}$ " pulley on the main driving shaft, as shown in the illustration. The means for striking the belt from the fast to the loose pulley is clearly brought out in the illustration.

Fig. 64. Suspension Bridge

(MADE WITH MECCANO NO. 4 OR NO. 3 AND NO. 3A.)

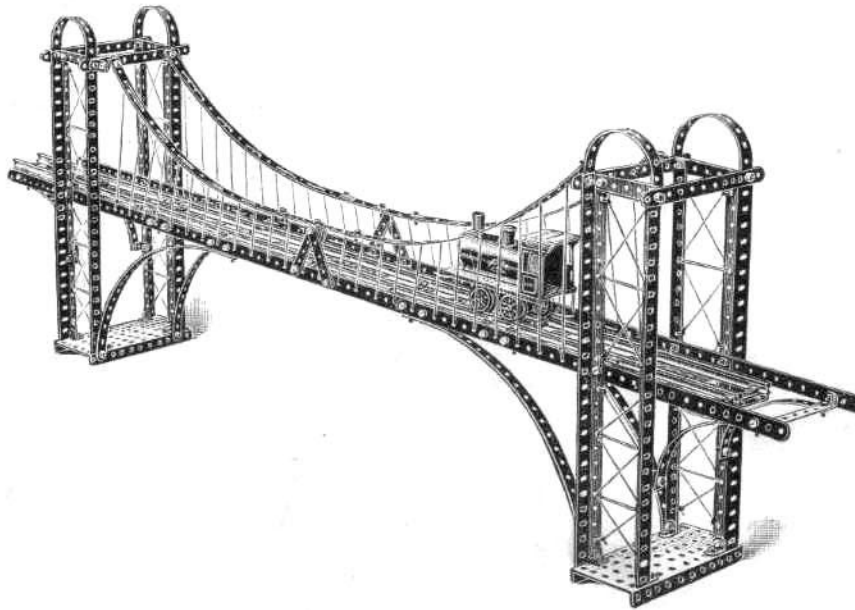

PARTS REQUIRED.		<i>Parts required in addition to Outfits.</i>		
		No. 1	No. 2	No. 3
14	12½" Perforated Strips	10	4	—
18	5½" " "	14	2	—
4	3½" " "	3	2	—
8	2½" " "	—	—	—
8	Angle Girders	8	4	—
30	Angle Brackets	20	14	4
103	Nuts and Bolts	83	53	33
2	Large Rectangular Plates	1	1	—
3	Small Rectangular Plates	3	3	—

The end towers of this model are built up from four angle girders carried from large rectangular plates at the base.

The rail track platform is coupled to the towers by small rectangular plates. A third small rectangular plate being disposed at the centre of the track platform. Two 3½" strips are connected to the side strips of the girder platform between the end and middle rectangular plates and one at each end. Any suitable track rails may be laid across the girder platform.

The engine and rails shown in the illustration are not included in the outfit, and are merely shown for purposes of illustration.

Fig. 65. Warehouse with Elevator

(MADE WITH MECCANO OUTFIT No. 4 OR
WITH No. 3 AND No. 3A.)

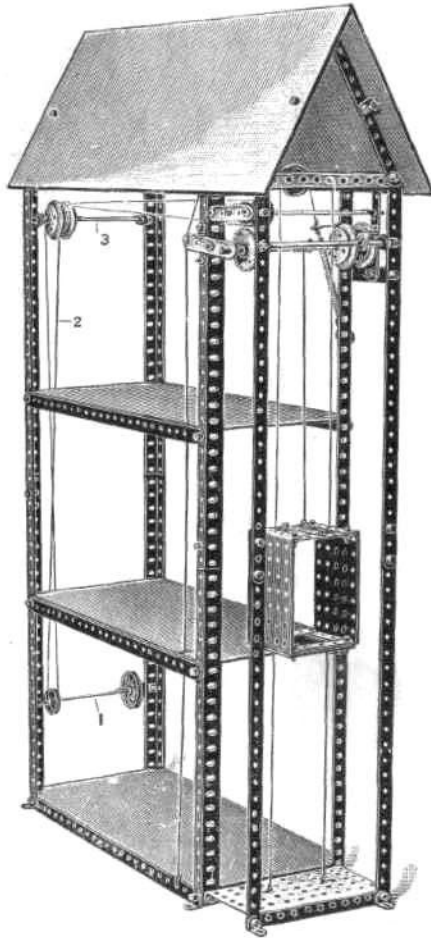

Parts required in addition to Outfits

PARTS REQUIRED.		No. 1	No. 2	No. 3
13	12½" Perforated Strips	9	—	—
8	5½" " "	4	—	—
2	3½" " "	1	—	—
1	3" " "	1	1	—
7	2½" " "	—	—	—
8	Angle Girders	8	4	—
29	Angle Brackets	19	13	—
2	6" Rods	2	2	1
2	5" "	2	—	—
1	4½" "	—	—	—
2	2" "	—	—	—
4	Flanged Wheels	4	—	—
1	1½" Pulley Wheel	1	1	—
4	1" " "	—	2	—
1	¾" Pinion	1	1	—
1	Gear Wheel	1	1	—
86	Nuts and Bolts	66	36	16
1	Hook	—	—	—
19	Keys	10	8	—
1	Spring	1	1	1
2	Large Rectangular Plates	1	1	—
3	Small " "	3	3	—

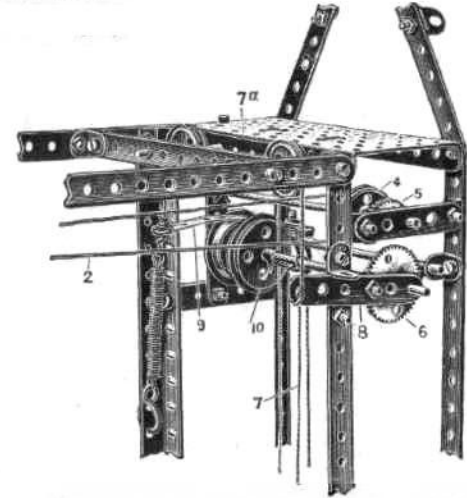

The structure of the warehouse is built up of corner members made from pairs of angle girders overlapped three holes and bolted together in the middle hole. These are connected at the sides by 12½" strips, and at the ends, top and bottom, by 5½" strips, and a large rectangular plate to form the floor for the elevator arrangement.

The driving shaft 1 is connected to the grooved pulley 4 by belt 2 passing over loose pulleys and shaft 3. The shaft carrying the pulley 4 is fitted with a ¾" pinion 5, and is adapted to be geared with the gear wheel 6 by operating the cord 7 controlling the lever 8 which carries the wheel spindle. The cord 7 is extended over pulleys at 7a and connected to a brake band 9 engaging the brake driven pulley 10 mounted on the winding spindle. The one operation of throwing the gear wheel 6 into engagement with the driving pinion 5, simultaneously releases the brake 9 and enables the cage to be hoisted. By only partially releasing the operating cord 7 the gears 5 and 6 are disconnected without the brake 9 being engaged, the cage is then allowed to descend freely.

Fig. 71. Travelling Crane

(MADE WITH MECCANO OUTFIT NO. 5 OR WITH NO. 4 AND NO. 4A.)

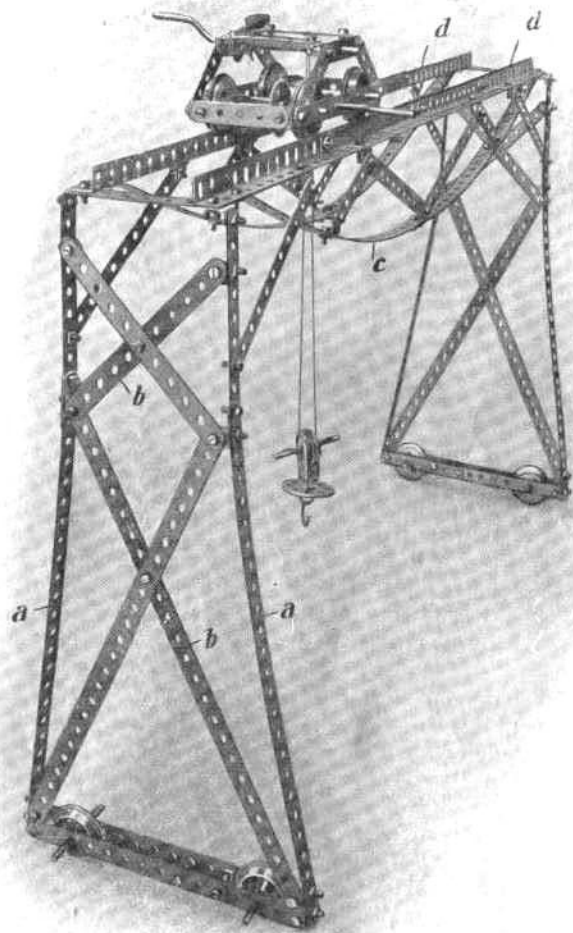

FIG. 71A.

Parts required in addition to Outfits,

PARTS REQUIRED.	No.			
	1	2	3	4
12 12½" Perforated Strips	8	2	—	—
22 5½" " "	18	6	4	2
6 3½" " "	5	4	—	—
14 2½" " "	5	—	—	—
6 Angle Girders	6	2	—	—
46 Angle Brackets	36	30	20	2
2 3½" Rods	1	—	—	—
5 2" " "	3	3	2	1
2 Crank Handles	1	1	—	—
8 Flanged Wheels	8	4	4	—
1 1" Pulley Wheel	—	—	—	—
1 Bush Wheel	—	—	—	—
1 ½" Pinion	1	1	—	—
1 ½" " "	1	—	—	—
1 Gear Wheel	1	1	—	—
1 Pawl	1	—	—	—
122 Nuts and Bolts	102	72	52	12
1 Hook	—	—	—	—
20 Keys	11	9	—	—
1 Single Bent Strip	—	—	—	—

The side frames of this model are each similarly constructed. Two edge strips (a) of 12½" and 5½" overlapped in three holes and diagonal bracing (b) being attached to these edge strips (a) by angle brackets.

The side frames are connected together by two bowstring rail girders (c) also diagonally braced, as shown in Fig. No. 71A. The rail members (d) are composed of two angle girders butted together, and overlapped by a strengthening girder, in the central portion of which diagonal bracing are secured.

The construction of the carriage is shown in Fig. No. 71B.



FIG 71B.

Fig. 72. Tower

(MADE WITH MECCANO OUTFIT NO. 5 OR NO. 4 AND NO. 4A.)

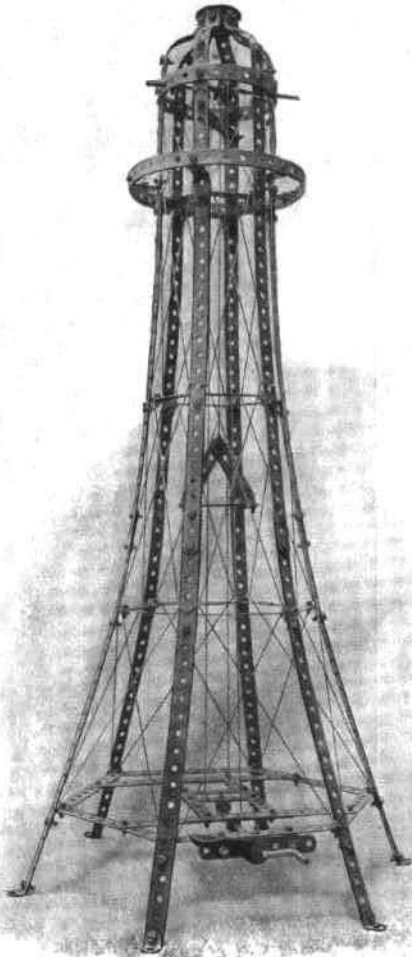

PARTS REQUIRED.		<i>Parts required in addition to Outfits.</i>			
		No. 1	No. 2	No. 3	No. 4
14	12 $\frac{1}{2}$ " Perforated Strips	10	4	4	—
18	5 $\frac{1}{2}$ " " "	14	2	—	—
17	3 $\frac{1}{2}$ " " "	16	15	11	11
12	2 $\frac{1}{2}$ " " "	3	—	—	—
6	2" " "	6	6	6	6
53	Angle Brackets	43	37	27	9
1	5 $\frac{1}{2}$ " Axle Rod	1	—	—	—
1	Crank Handle	—	—	—	—
1	1" Pulley Wheel	—	—	—	—
1	Bush Wheel	—	—	—	—
1	$\frac{1}{2}$ " Pinion Wheel	1	—	—	—
1	Pawl	1	—	—	—
132	Nuts and Bolts	112	82	62	22
8	Keys	—	—	—	—

We can only give information in principal for the construction of this model without any construction details.

Commence by making the lower platform with 6 5 $\frac{1}{2}$ " strips bolted together forming a hexagon with angle brackets at the corners. The other 3 smaller platforms are made similarly with 3 $\frac{1}{2}$ ", 2 $\frac{1}{2}$ " and 2" strips

These sub assemblies are then bolted with the angle brackets to the vertical members to make the basic design of the tower.

Fig. 73. Coal Tip

(MADE WITH MECCANO OUTFIT NO. 5 OR NO. 4 AND NO. 4A.)

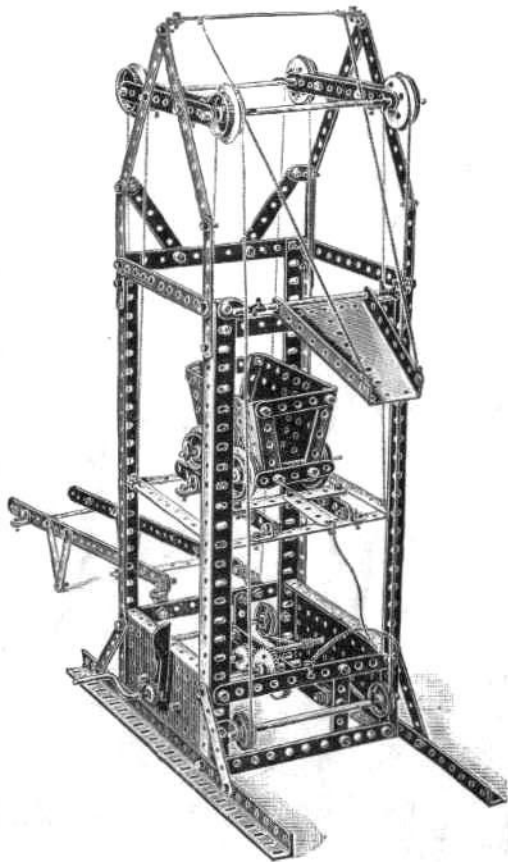

Parts required in addition to Outfits.

PARTS REQUIRED.

2	12 $\frac{1}{2}$ "	Perforated Strips	—	—	—	—
24	5 $\frac{1}{2}$ "	" "	20	8	6	4
8	3 $\frac{1}{2}$ "	" "	7	6	2	2
6	3"	" "	6	6	4	2
11	2 $\frac{1}{2}$ "	" "	2	—	—	—
6		Angle Girders	6	2	—	—
37		Angle Brackets	27	21	11	—
4	6"	Rods	4	4	4	2
3	5"	" "	3	—	—	—
2	3 $\frac{1}{2}$ "	" "	2	2	2	2
1		Crank Handle	—	—	—	—
8		Flanged Wheels	8	4	4	—
4	1"	Pulley Wheels	—	2	—	—
2	$\frac{3}{4}$ "	Pinion Wheels	2	2	—	—
1	$\frac{5}{8}$ "	" Wheel "	1	—	—	—
1		Gear Wheel "	1	1	—	—
1		Pawl	1	—	—	—
124		Nuts and Bolts	104	74	54	14
28		Keys	19	17	6	—
2		Small Rectangular Plates	2	2	—	—
1		Sector Plate	—	—	—	—

No. 1	No. 2	No. 3	No. 4
—	—	—	—
20	8	6	4
7	6	2	2
6	6	4	2
2	—	—	—
6	2	—	—
27	21	11	—
4	4	4	2
3	—	—	—
2	2	2	2
—	—	—	—
8	4	4	—
—	2	—	—
2	2	—	—
1	—	—	—
1	1	—	—
1	—	—	—
104	74	54	14
19	17	6	—
2	2	—	—
—	—	—	—

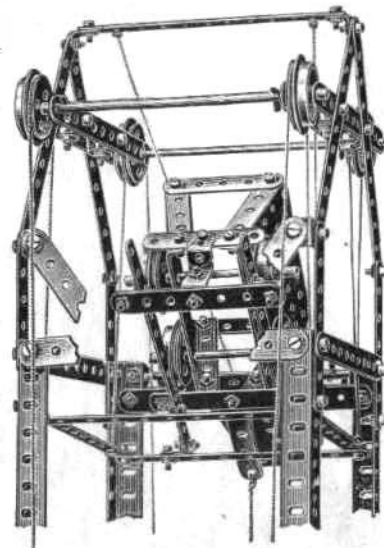
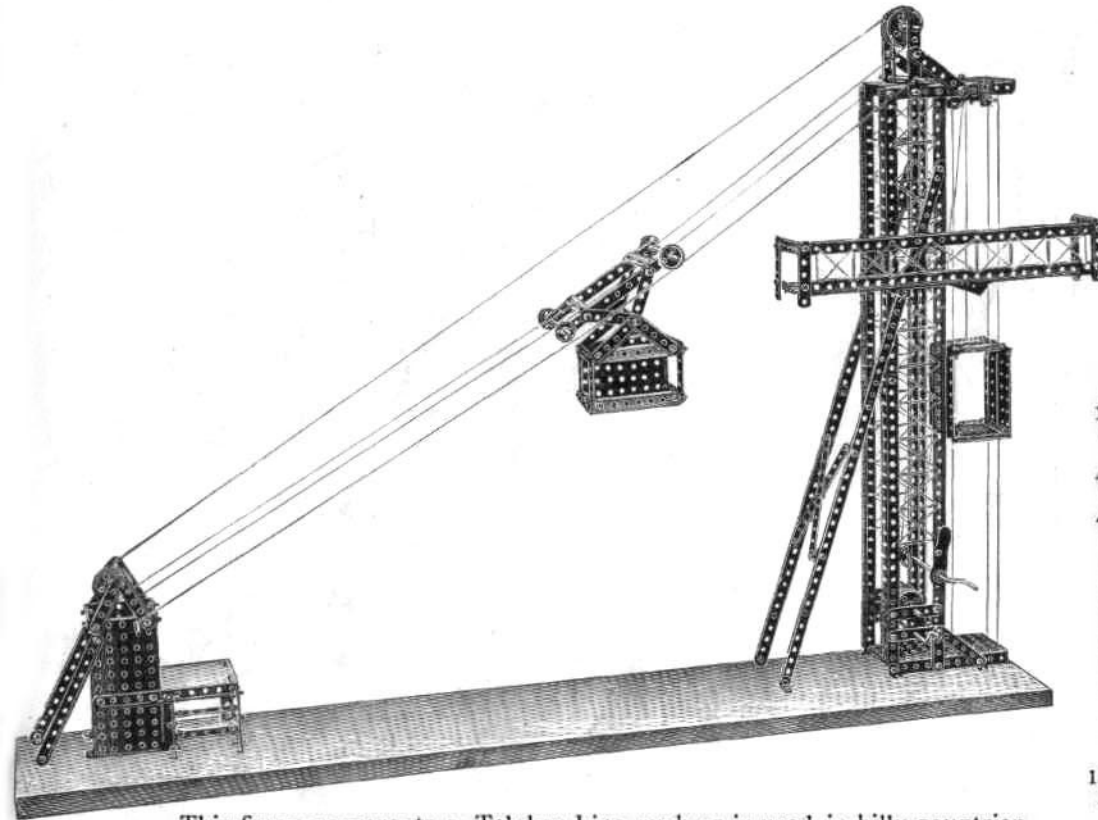

Fig. 74. Telfer Line

(MADE WITH MECCANO OUTFIT No. 5 OR No. 4 AND No. 4A.)



This figure represents a Telfer Line such as is used in hilly countries for transporting loads across intervening valleys.

Parts required in addition to Outfits

PARTS REQUIRED.		No. 1	No. 2	No. 3	No. 4
6	12½" Perforated Strips	2	—	—	—
10	5½" " "	6	—	—	—
2	3½" " "	1	—	—	—
8	3" " "	8	8	6	4
44	2½" " "	35	30	30	26
9	Angle Girders	9	5	1	1
45	Angle Brackets	35	29	19	1
4	5" Rods	4	1	—	—
3	4½" " "	—	—	—	—
2	3½" " "	2	2	2	2
2	Crank Handles	1	1	—	—
4	Flanged & Grooved Wheels	4	—	—	—
2	1½" Pulley Wheels	2	2	1	1
6	1" " "	—	4	2	1
1	¾" Pinion Wheel	1	1	—	—
1	½" " "	1	—	—	—
1	Gear Wheel "	1	1	—	—
1	Pawl	1	—	—	—
150	Nuts and Bolts	130	100	80	40
31	Keys	22	20	9	9
1	Large Bent Strip	1	1	—	—
4	Large Rectangular Plates	3	3	2	2
3	Small Rectangular Plates	3	3	—	—

Fig. 75. Travelling Gantry

(MADE WITH MECCANO OUTFIT NO. 5 OR NO. 4 AND NO. 4A.)

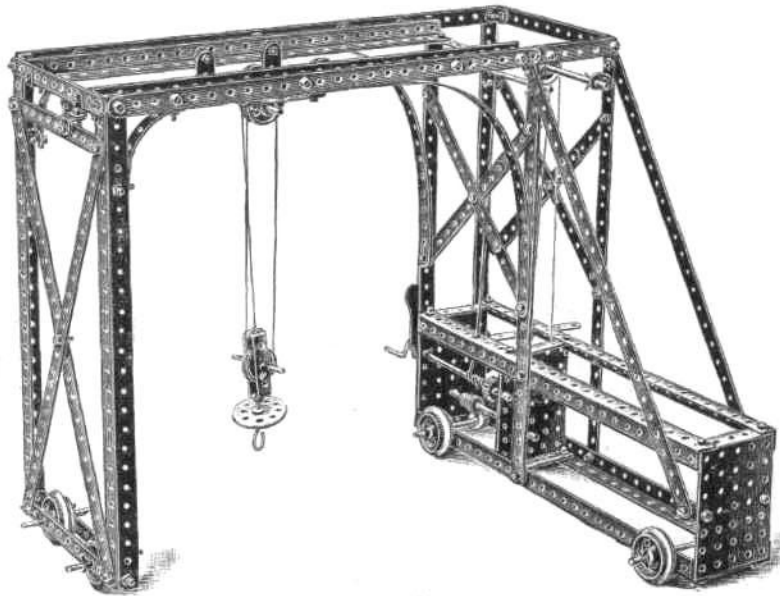

Parts required in addition to Outfits

PARTS REQUIRED.		No. 1	No. 2	No. 3	No. 4
12	1 1/2" Perforated Strips	8	2	—	—
16	5 1/2" " "	12	—	—	—
1	3 1/2" " "	—	—	—	—
2	3" " "	2	2	—	—
3	2 1/2" " "	—	—	—	—
8	Angle Girders	8	4	—	—
26	Angle Brackets	16	10	—	—
2	6" Rods	2	2	2	—
1	5" "	1	—	—	—
2	4 1/2" "	—	—	—	—
4	2" "	2	2	1	—
3	Crank Handles	2	2	1	—
6	Flanged and Grooved Wheels	6	2	2	—
6	1" Pulleys	—	4	2	1
6	1/2" " "	6	6	5	5
1	Bush Wheel	—	—	—	—
2	3/4" Pinion Wheels	2	2	—	—
2	1/2" " "	2	1	—	—
1	Gear Wheel	1	1	—	—
1	Worm Wheel	1	1	—	—
109	Nuts and Bolts	89	59	39	—
1	Pawl	1	—	—	—
1	Hook	—	—	—	—
33	Keys	24	22	11	11
2	Single Bent Strips	1	1	1	1
2	Large Bent Strips	2	2	1	1
3	Small Rectangular Plates	3	3	—	—

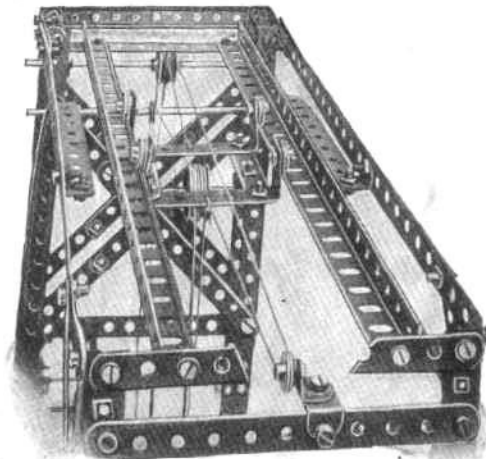

A most interesting model to the student of mechanics. If carefully constructed, the mechanism will be found to work with the utmost precision and smoothness, and much instruction can be gained by a study of its parts.

The construction is quite straightforward, and hardly needs any description. Care should be taken as to the construction of the clutch mechanism, which is clearly shown in the illustration.

As regards the Cord for operating the travelling carriage, care must be taken to wind this cord twice around the pulley on the spindle of the traversing handle.

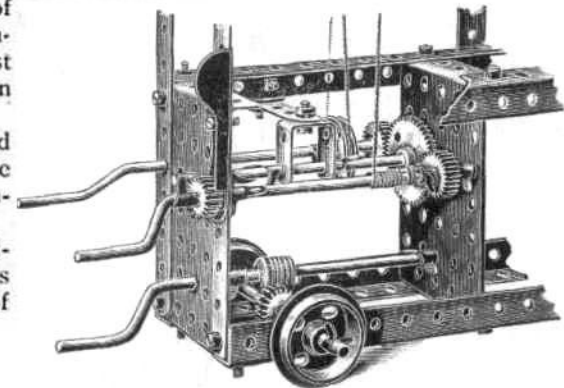

Fig. 76. Revolving Aeroplane

(MADE WITH MECCANO OUTFIT No. 5 OR No. 4 AND No. 4A.)

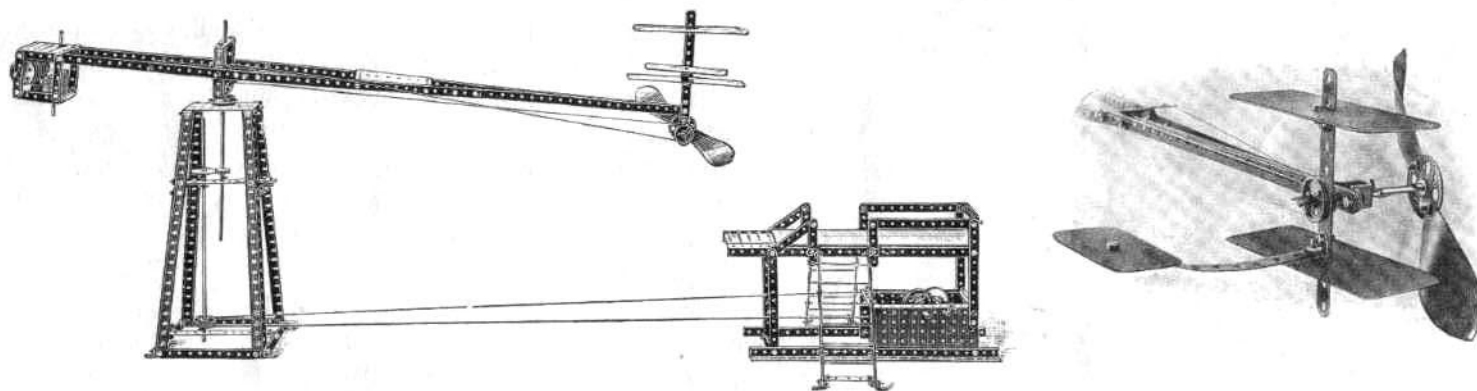

FIG. 76A

*Parts required in addition
to Outfits.*

PARTS REQUIRED.	No. 1	No. 2	No. 3	No. 4
6 12½" Perforated Strips	2	—	—	—
23 5½" " "	19	7	5	3
10 3½" " "	9	8	4	4
2 3" " "	2	2	—	—
11 2½" " "	2	—	—	—
8 Angle Girders	8	4	—	—
28 Angle Brackets	18	12	2	—
2 11½" Rods	2	2	2	—
4 5" "	4	1	—	—
1 4½" "	—	—	—	—
1 3½" "	1	1	—	—
1 2" "	—	—	—	—
1 Crank Handle	—	—	—	—
1 Flanged Wheel	1	—	—	—
2 1½" Pulley Wheels	2	2	1	1

*Parts required in addition
to Outfits.*

PARTS REQUIRED.	No. 1	No. 2	No. 3	No. 4
2 1" Pulley Wheels	—	—	—	—
6 ½" " "	6	6	5	5
1 Bush Wheel	—	—	—	—
3 ¾" Pinions	3	3	1	1
2 Gear Wheels	1	1	—	—
1 ¾" Contrate Wheel	2	2	1	1
128 Nuts and Bolts	108	78	58	18
27 Keys	18	16	5	5
2 Propeller Blades	2	2	2	2
1 Double Bent Strip	1	—	—	—
2 Large Bent Strips	2	2	1	1
2 Large Rectangular Plates	1	1	—	—
4 Small Rectangular Plates	4	4	1	1
1 Sector Plate	—	—	—	—

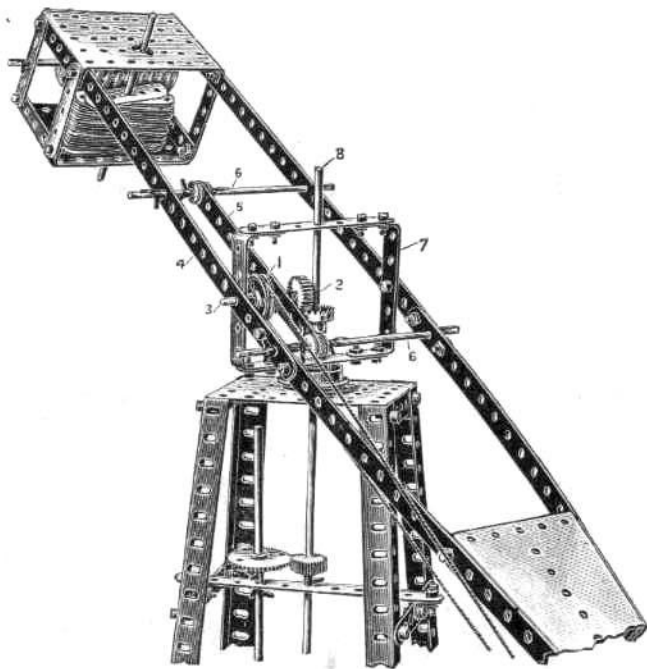

FIG. 76B.

As regards the construction of the detailed portion shown in Fig. 76B, the pulley wheel (1) and the pinion (2) are both keyed on the short spindle (3) in the following manner : The pulley wheel (1) is first inserted on the spindle (3), after the latter has been passed through the outer strip (4). It is then keyed on the spindle, and the $5\frac{1}{2}$ " strip (5), which is loose on both the spindles (6), is then slid on the spindles (6) and the spindle (3) close against the pulley wheel (1). The pinion (2) is then inserted on the spindle (3), and keyed in place. During this operation it is necessary to have the swinging arm and the square frame (7) drawn off the main vertical spindle (8), so as to give room for the keying up of the pulley (1) and pinion (2), after which the frame (7) may be dropped into place over the spindle (8).

The balance weight is made up of a series of short strips or wheels threaded over the spindles in the shorter arm, and by this means the weight can be adjusted to any nicety.

The driving gear is operated from the crank handle (shown on the right in the sketch), and drives the vertical spindle (8) in the pedestal on the left, upon which a $\frac{3}{4}$ " contrate wheel is keyed, engaging the $\frac{3}{4}$ " pinion (2). At the upper end of this spindle is mounted the balanced swinging arm carrying the propeller and aeroplane on its longer limb, and a balance weight on the short one. The operation of the crank will cause the propeller to revolve, and the aeroplane to travel.

Fig. 77. Signal Gantry

(MADE WITH MECCANO OUTFIT No. 5 OR No. 4 AND No. 4A.)

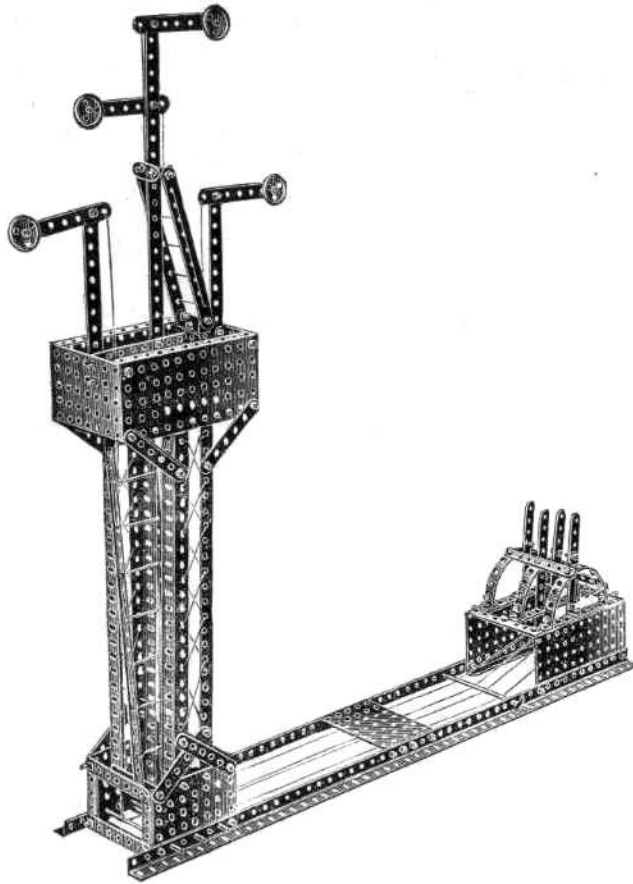

*Parts required in addition
to Outfits*

PARTS REQUIRED.

3	12 $\frac{3}{4}$ "	Perforated Strips	—	—	—	—
13	5 $\frac{1}{2}$ "	" "	9	—	—	—
16	3 $\frac{1}{2}$ "	" "	15	14	10	10
8	3"	" "	8	8	6	4
8		Angle Girders	8	4	—	—
33		Angle Brackets	23	17	7	—
1	5"	Rod	1	—	—	—
3	4 $\frac{1}{4}$ "	Rods	—	—	—	—
4	1"	Pulley Wheels	—	2	—	—
138		Nuts and Bolts	118	88	68	28
8		Keys	—	—	—	—
4		Large Rectangular Plates	3	3	2	2
5		Small Rectangular Plates	5	5	2	2

No. 1	No. 2	No. 3	No. 4
—	—	—	—
—	—	—	—
15	14	10	10
8	8	6	4
8	4	—	—
23	17	7	—
—	—	—	—
—	2	—	—
118	88	68	28
—	—	—	—
3	3	2	2
5	5	2	2

Fig. 81. Tower Bridge

(MADE WITH MECCANO OUTFIT NO. 6 OR NO. 5 AND NO. 5A.)

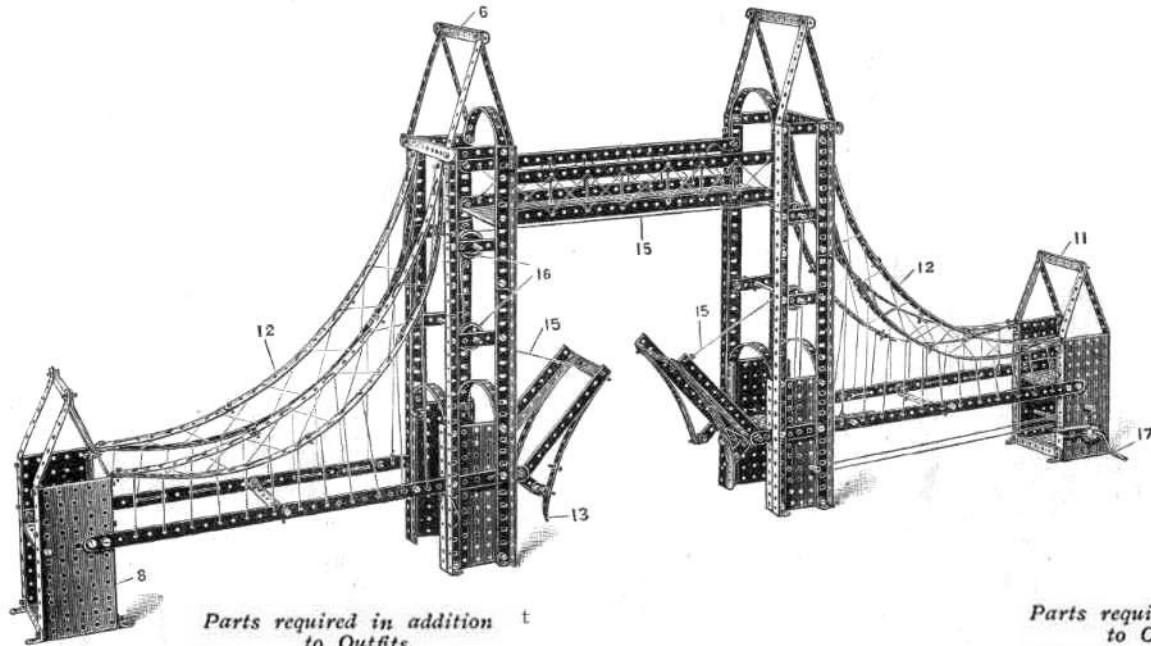

Parts required in addition to Outfits

PARTS REQUIRED.	No. 1	No. 2	No. 3	No. 4	No. 5
22 12½" Perforated Strips	18	12	12	8	8
34 5½" " "	30	18	16	14	10
12 3½" " "	11	10	6	6	—
12 2½" " "	3	—	—	—	—
10 12½" Angle Girders	10	6	2	2	1
12 5½" " "	12	12	12	12	12
28 Angle Brackets	18	12	2	—	—
4 5" Rods	4	1	—	—	—
2 4½" " "	—	—	—	—	—
1 Crank Handle	—	—	—	—	—
6 1" Pulley Wheels	—	4	2	1	—

Parts required in addition to Outfits

PARTS REQUIRED.	No. 1	No. 2	No. 3	No. 4	No. 5
1 3" Pinion Wheel	1	1	—	—	—
1 1½" " "	1	—	—	—	—
1 Gear Wheel	1	1	—	—	—
1 Pawl	1	—	—	—	—
183 Nuts and Bolts	163	133	113	73	23
18 Keys	9	7	—	—	—
2 Large Bent Strips	2	2	1	1	—
2 Springs	2	2	2	1	1
8 Large Rectangular Plates	7	7	6	6	4
4 Small " "	4	4	1	1	—

Tower Bridge

Begin by making the two main towers, the construction of one of which is shown in figure 81A. The four uprights (1) are made of angle girders, connected at their lower extremities by large rectangular plates (2) and transverse strips (3). The sides of the tower are connected together by a small rectangular plate (4) across the top of which, and at the top of the tower, are bolted bent $5\frac{1}{2}$ " strips.

The top gable (6) constructed as shown, is then bolted at its lower edges (7) to the top of the uprights.

The short end towers, one of which is shown to the right of the figure, are built up from two large rectangular plates (8) connected together by a small rectangular plate (9) and two $3\frac{1}{2}$ " strips (10), the gable (11) being then bolted on top.

The catenary member (12) is built up from four curved $12\frac{1}{2}$ " strips overlapped, the lower member by 12 holes and the upper member by 15 holes, so as to produce a longer sweep in the lower member, and are bolted to the vertical angle girders of the higher towers, and by angle brackets to the shorter towers.

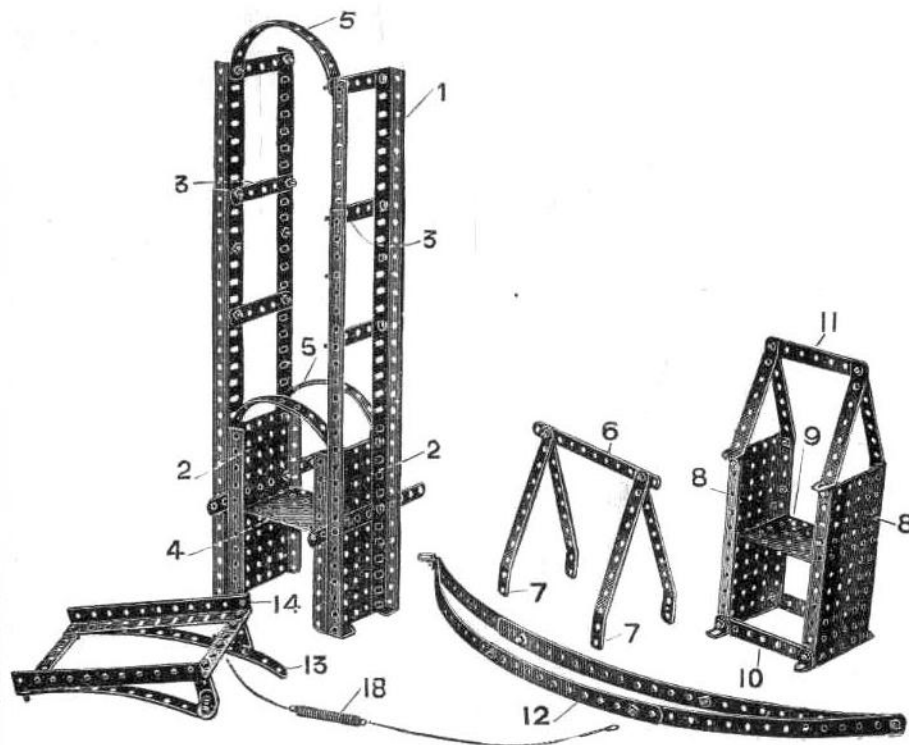

FIG. 81A

The bascules as illustrated in the left-hand corner of the picture are built up of two $5\frac{1}{2}$ " angle girders braced with transverse $3\frac{1}{2}$ " strips, and reinforced with bent $5\frac{1}{2}$ " strips, one of which is provided with a projecting $2\frac{1}{2}$ " strip (13), which bears against the main tower and acts as a stop when the bascules are horizontal. The bascules are hinged by fixing bolts in the end holes (14). The bascules are opened by the cords (15) passing over the guide pulleys (16), and are controlled by the extension spring (18), which normally acts to return them to their closed position. In the right smaller tower is the operating handle (17), on which is keyed a pinion meshed with a worm wheel on the spindle, on to which the operating cords (15) are wound.

Fig. 82. Rotating Crane

(MADE WITH MECCANO OUTFIT NO. 6 OR NO. 5 AND NO. 5A.)

*Parts required in addition
to Outfits*

PARTS REQUIRED.	No. 1	No. 2	No. 3	No. 4	No. 5
4 12 $\frac{1}{2}$ " Perforated Strips	—	—	—	—	—
37 5 $\frac{1}{2}$ " " "	33	20	19	17	13
18 3 $\frac{1}{2}$ " " "	17	16	12	12	1
11 3" " "	11	11	9	7	3
18 2 $\frac{1}{2}$ " " "	9	4	4	—	—
1 2" " "	1	1	1	1	—
16 12 $\frac{1}{2}$ " Angle Girders	16	12	8	8	7
2 5 $\frac{1}{2}$ " " "	2	2	2	2	2
47 Angle Brackets	37	31	21	3	—
1 6" Axle Rod	1	1	1	—	—
3 4 $\frac{1}{2}$ " " "	—	—	—	—	—
5 2" " "	3	3	2	—	—
3 Crank Handles	2	2	1	—	—
8 Flanged Wheels	8	4	4	—	—
2 1 $\frac{1}{2}$ " Pulley Wheels	2	2	1	1	—
6 1" " "	—	4	2	1	—
1 Bush Wheel	—	—	—	—	—
1 $\frac{3}{4}$ " Pinion Wheel	1	1	—	—	—
2 $\frac{1}{2}$ " " "	2	1	—	—	—
1 Gear Wheel	1	1	—	—	—
1 Worm Wheel	1	1	—	—	—
1 Pawl	1	—	—	—	—
174 Nuts and Bolts	154	124	104	64	14
1 Hook	—	—	—	—	—
32 Keys	23	21	10	10	—
2 Single Bent Strips	1	1	—	—	—
1 Large " "	1	1	—	—	—
1 Length of Chain	1	1	1	1	1
5 Small Rectangular Plates	5	5	2	2	—

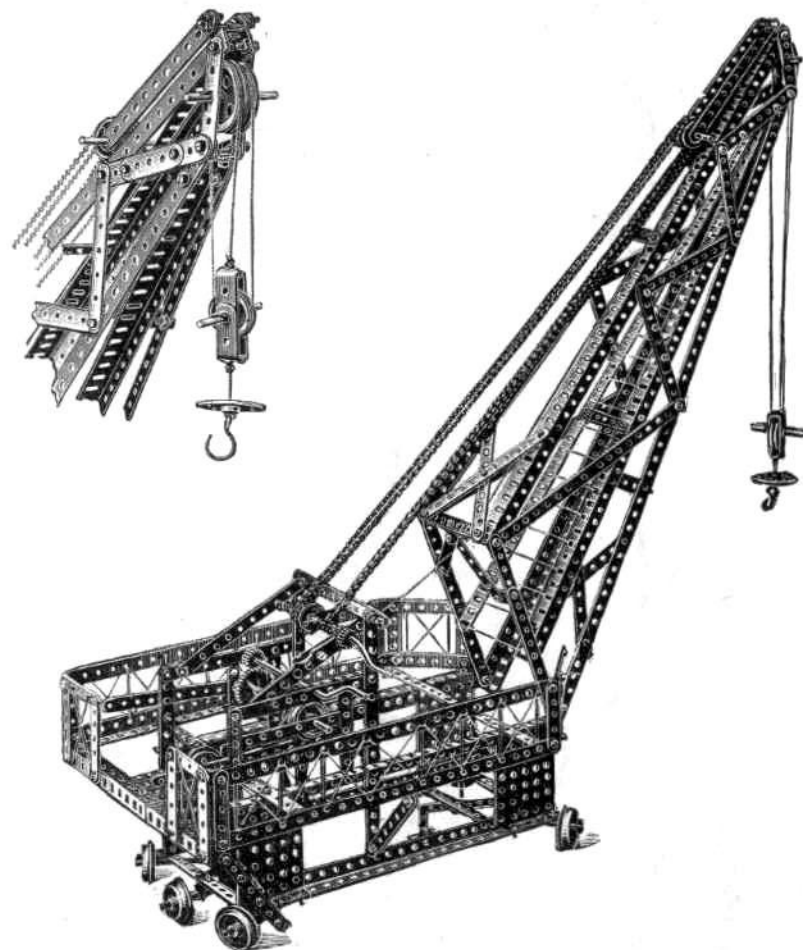

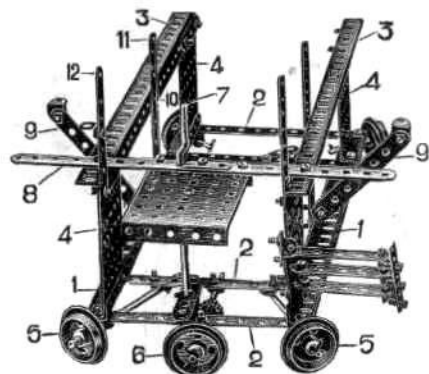

FIG. 82A

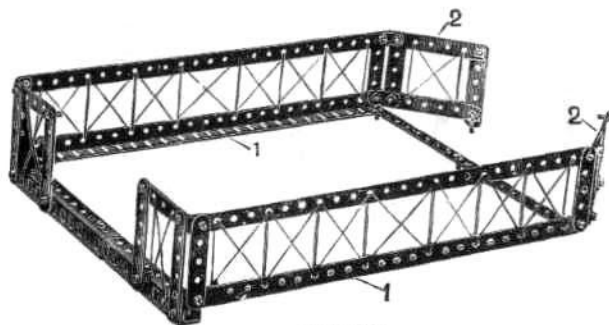
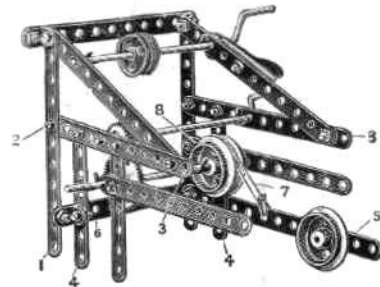

FIG. 82B



In constructing this model, begin by building up the lower wheel carriage (Figure 82A). As will be seen, this consists of two main angle girders (1) connected by four $5\frac{1}{2}$ " cross strips (2), the superstructure made from the upper angle girders (3) and vertical small rectangular plates (4) being then bolted to the lower girders (1). The extreme bolts in these lower girders carry two reverse angle brackets, which form the bearing for the spindles of the flanged wheels (5), the flanged pulley (6) running in bearings formed by angle brackets on the end cross strips being driven from the operating handle (7), carrying a worm engaging the pinion on the spindle of the driven wheel (6). Two $5\frac{1}{2}$ " strips (8) overlapped three holes form with the inclined $3\frac{1}{2}$ " strips (9) supports for the outer gallery frame (Figure 82B). The outer ends of the inclined strips (9) and the cross strips (8) are bolted to the gallery frame.

The gallery frame (Figure 82B) is built up of two $12\frac{1}{2}$ " angle girders (1) braced at one end with two $5\frac{1}{2}$ " angle girders overlapped three holes, and at the other end with two $5\frac{1}{2}$ " strips similarly overlapped. The end wings (2) are bolted in the extreme holes to the angle girders (3) in Figure 82A.

The gear frame mechanism (Figure 82C) may now be proceeded with, the framework of which is clearly shown in the illustration. The holes (1 and 2) are bolted to the corresponding holes (10 and 11) in the upright strips (Figure 82A), the holes (3) being bolted to the top holes of the strips (12) in Figure 82A. The lower holes (4) are bolted to the angle girders (3) in Figure 82A.

The brake mechanism is effected by means of the weighted lever (5) pivoted in an angle bracket carried from the cross piece (6), the lever being provided with the brake cord (7) which passes over a pair of flanged pulleys (8) keyed together on the winding spindle.

Fig. 83. Flip Flap

(MADE WITH MECCANO OUTFIT NO. 6 OR NO. 5 AND NO. 5A.)

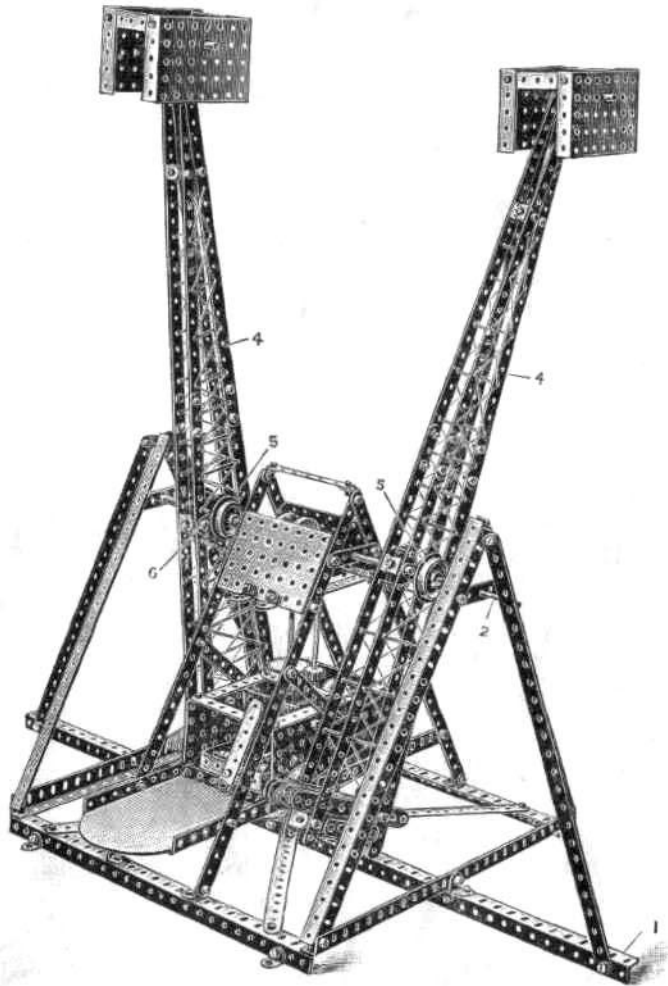

*Parts required in addition to
Outfits.*

PARTS REQUIRED.

24	12½"	Perforated Strips	20	14	14	10	10
4	5½"	" "	—	—	—	—	—
10	3½"	" "	9	8	4	4	—
12	2½"	" "	3	—	—	—	—
10	12½"	Angle Girders	10	6	2	2	—
1	5½"	" "	1	1	1	1	—
44		Angle Brackets	34	28	18	—	—
1	8"	Rod	1	1	1	1	1
2	6"	Rods	2	2	2	—	—
4	5"	" "	4	1	—	—	—
2	3½"	" "	2	2	2	2	—
4		Flanged Wheels	4	—	—	—	—
1	1½"	Pulley Wheel	1	1	—	—	—
3	½"	Pinion Wheels	3	3	1	1	—
2	½"	" "	2	1	—	—	—
2		Gear Wheels	2	2	1	1	—
2	1½"	Contrate Wheels	2	2	2	1	1
2	½"	" "	2	2	—	—	—
1		Worm Wheel	1	1	—	—	—
161		Nuts and Bolts	141	111	91	51	—
30		Keys	21	19	8	8	—
1		Large Bent Strip	1	1	—	—	—
2		Large Rectangular Plates	1	1	—	—	—
8		Small Rectangular Plates	8	8	5	5	3

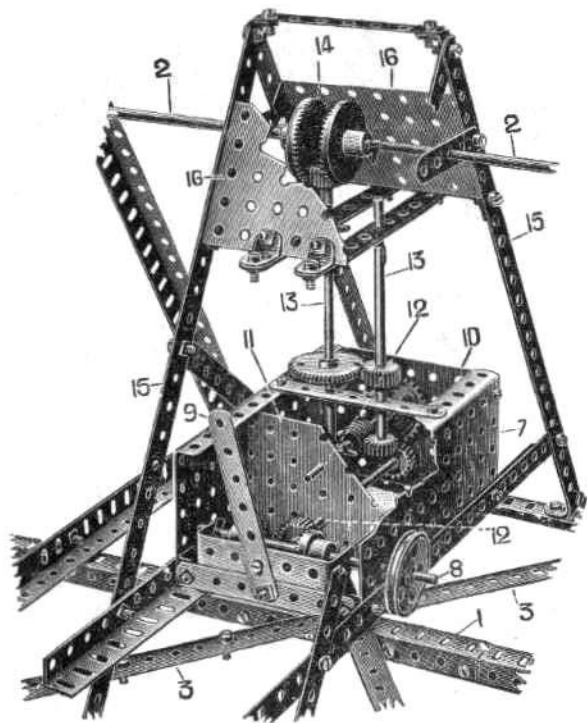

The construction of the arms and the main body of the supporting frame is clearly shown in the illustration. The main longitudinal rib (1) is made up from two angle girders butt jointed, not overlapped, the joint being strengthened with a 3" strip bolted through in every hole to the angle girders. By this means of butt-jointing the true alignment of the main axle (2) is secured.

The cross diagonal strips (3) of the base are formed by joining together 12½" and 5½" strips and overlapping them together for five holes.

The axle (2) is gripped to the arms (4) by means of the keyed wheels (5) on either side of the arms, which are in turn secured to the arms by means of a pair of nuts and bolts in the wheels, the nuts binding against the short 2½" cross strip (6) on the arms.

Having constructed the main body of the supporting frame as above described, the operating gear cage is now proceeded with. This is built up of large rectangular plates (7) forming a bearing for the driving spindle (8) operated by the clutch handle (9) and connected together by a small rectangular plate (10) and a similar mid plate (11). These two latter plates form bearings for the longitudinal spindle (12). The vertical spindles (13) drive the 1½" contra wheels (14) on the main axles (2), the inclined 12½" strips (15) being connected near the contra wheels by the small rectangular plates (16).

Fig. 84. Transporter Bridge

(MADE WITH MECCANO OUTFIT No. 6 OR
No. 5 AND No. 5A).

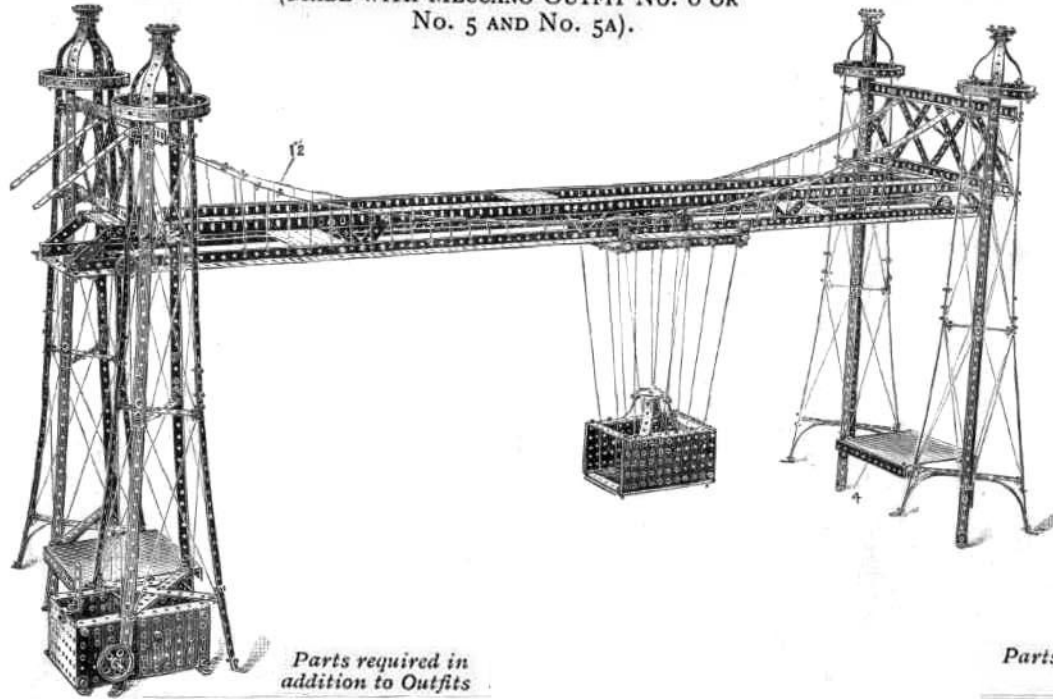

Parts required in addition to Outfits

PARTS REQUIRED.	No. 1	No. 2	No. 3	No. 4	No. 5
46 12 $\frac{1}{2}$ " Perforated Strips	42	32	36	32	32
44 5 $\frac{1}{2}$ " " "	40	24	26	24	20
29 3 $\frac{1}{2}$ " " "	28	27	23	23	12
8 3" " "	8	8	6	4	—
36 2 $\frac{1}{2}$ " " "	27	22	22	18	—
20 12 $\frac{1}{2}$ " Angle Girders	20	16	12	12	11
10 5 $\frac{1}{2}$ " " "	10	10	10	10	10
150 Angle Brackets	140	134	124	106	97
1 6" Rod	1	1	1	—	—
2 5" Rods	2	—	—	—	—
3 4 $\frac{1}{2}$ " " "	—	—	—	—	—
1 1 $\frac{1}{2}$ " Pulley Wheel	1	1	—	—	—
4 1" " "	—	2	—	—	—
4 $\frac{1}{2}$ " " "	4	4	3	3	—

Parts required in addition to Outfits

PARTS REQUIRED.	No. 1	No. 2	No. 3	No. 4	No. 5
5 Bush Wheels	4	4	4	4	5
2 $\frac{3}{4}$ " Pinion Wheels	2	2	—	—	—
1 $\frac{1}{2}$ " " "	1	—	—	—	—
1 Gear Wheel "	1	1	—	—	—
2 $\frac{3}{4}$ " Contrate Wheels	2	2	—	—	—
1 Worm Wheel	1	1	—	—	—
473 Nuts and Bolts	453	423	403	363	313
28 Keys	19	17	6	6	—
1 Large Bent Strip	1	1	—	—	—
4 Large Rectangular Plates	3	3	2	2	—
8 Small " "	8	8	5	5	3

In the construction of this model begin by taking two $5\frac{1}{2}$ " strips to form the base portion of each tower. Four curved $5\frac{1}{2}$ " strips are now bolted to the centre of the cross, and bent down to form an attachment for the vertical members (1). At the top of the first $12\frac{1}{2}$ " strips forming the vertical brace, cross strips $3\frac{1}{2}$ " long are now connected by angle brackets. Further $12\frac{1}{2}$ " strips are overlapped on the lower strips, which carries the construction to the crown (2) of the tower, which is made of $3\frac{1}{2}$ " curved strips. The gallery is formed of a $12\frac{1}{2}$ " strip, bent round and secured by angle brackets to the uprights.

The towers are connected at their base by $5\frac{1}{2}$ " angle girders (4) bolted to the angle brackets (3) and at their upper parts by the braced girders (5). The $12\frac{1}{2}$ " angle girders (6) are bolted to the cross strips (7) on the towers in the third hole from the end.

The construction of the main girder is as follows:—

The side frames are built up of four $12\frac{1}{2}$ " angle girders (8) butted together and reinforced at the joints by $5\frac{1}{2}$ " angle girders. The upper elements are constructed of four $12\frac{1}{2}$ " angle girders (9) each overlapped two holes. Small rectangular plates (10) and upper small rectangular plates (11) are bolted to the lower and upper elements respectively. The end upper plates (11) are bolted to the lower angle girders of the braced elements (5).

Figure 84D shows the construction of the cage, which is built up of side rectangular plates (1) connected across by four $3\frac{1}{2}$ " strips (2). The carrier frame (Figure 84E) is made of two $5\frac{1}{2}$ " strips overlapped eight holes and bent up to form the brackets on which the trolley wheels are bolted. The runners (3) carried in the bent-up ends of the end members (4) are made to run freely on the shank of the bolts by providing lock nuts on the inside and outside of the turned-up ends of the strips (4).

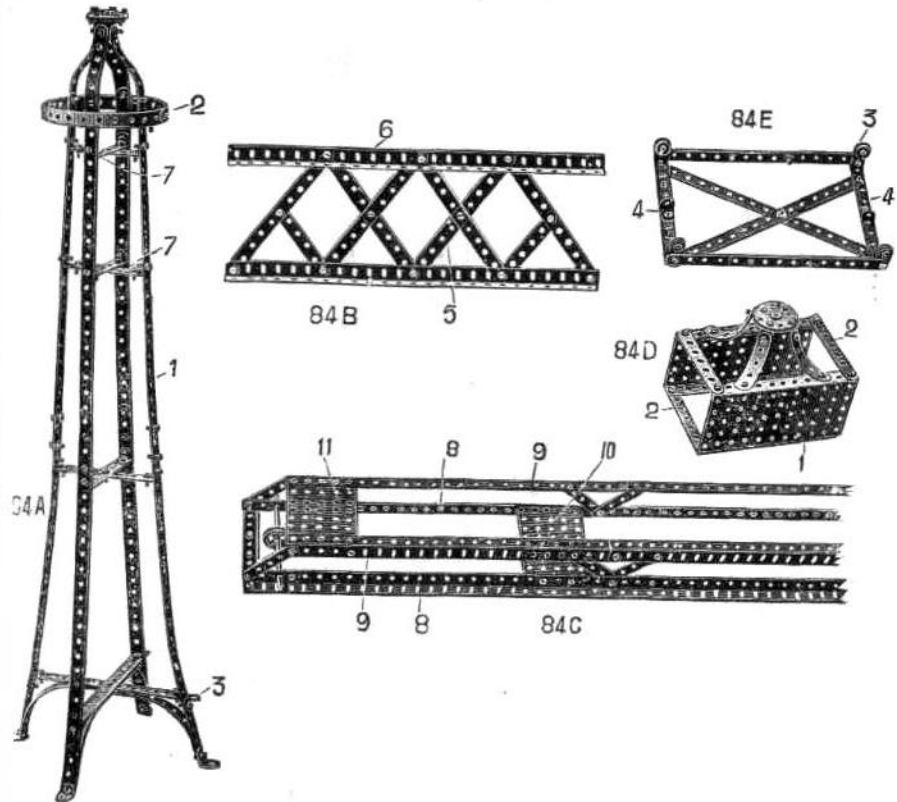
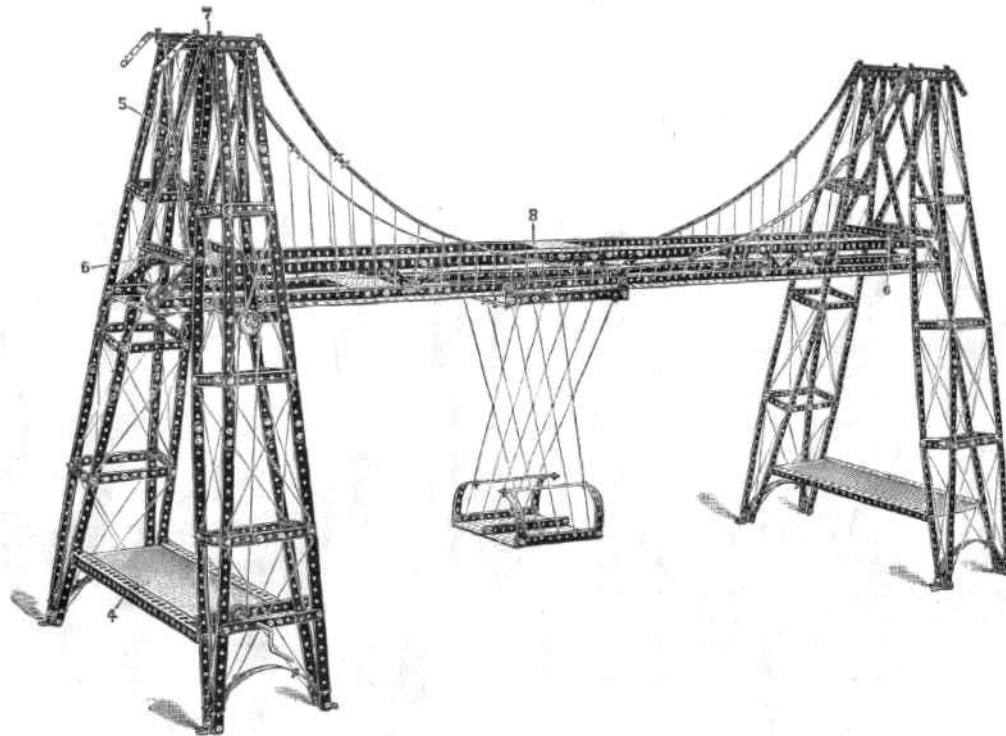

Fig. 85. Transporter Bridge

(MADE WITH MECCANO OUTFIT NO. 6 OR NO. 5 AND NO. 5A.)



Transporter Bridge

Parts required in addition to Outfits.

PARTS REQUIRED.	No. 1	No. 2	No. 3	No. 4	No. 5
42 12½" Perforated Strips	36	32	32	28	28
56 5½" " "	52	40	38	36	32
12 3½" " "	11	10	6	6	—
23 3" " "	23	23	21	19	15
32 2½" " "	23	18	18	14	—
24 2" " "	24	24	24	24	18
20 12½" Angle Girders	20	16	12	12	11
11 5½" " "	11	11	11	11	11
120 Angle Brackets	110	104	94	76	67
1 11½" Rod	1	1	1	—	—
2 4½" Rods	—	—	—	—	—
1 Crank Handle	—	—	—	—	—
4 1" Pulley Wheels	—	2	—	—	—
4 ½" " "	4	4	3	3	—
1 ½" Pinion Wheel	1	1	—	—	—
1 Gear Wheel	1	1	—	—	—
397 Nuts and Bolts	377	347	327	287	237
15 Keys	6	4	—	—	—
2 Large Rectangular Plates	1	1	—	—	—
5 Small " "	5	5	2	2	—

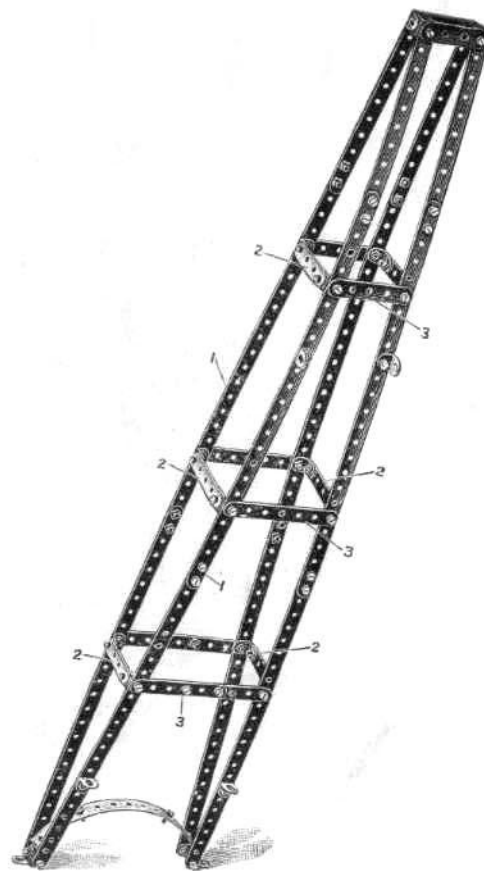

The main girder in this model calls for no particular description, being constructed similarly to that previously described.

The end towers are each made up of a pair of side girders composed of perforated strips (1) bowed at the centres and distanced by the short strips (2) and traverse strips (3). These side girders are connected at their lower ends by 12½" angle girders (4) and at their upper parts by the inclined 5½" strips (5), transverse 5½" angle girders (6) and upper 5½" strips (7). The end rectangular plates of the main girder (8) are bolted to the angle girders (6) of the towers.

Fig. 86. Big Wheel

(MADE WITH MECCANO OUTFIT NO. 6 OR NO. 5 AND NO. 5A.)

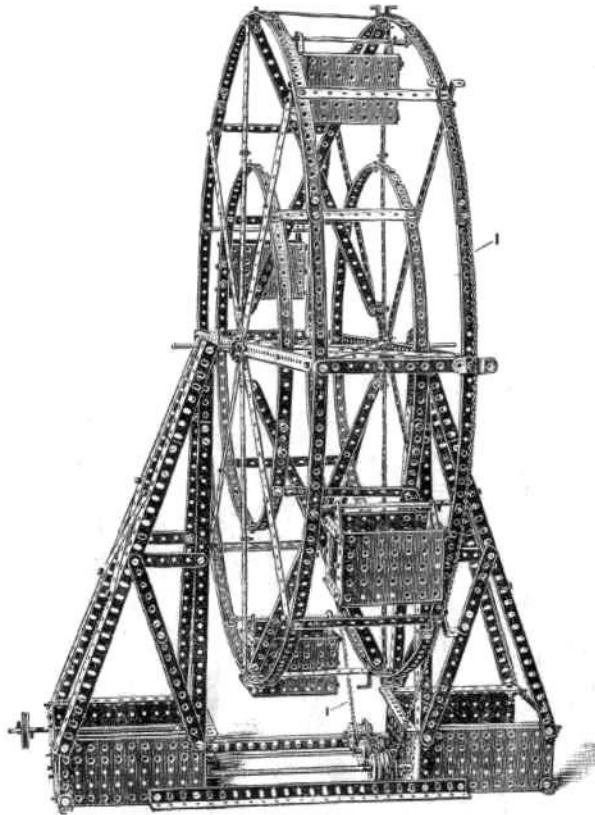

FIG. 86A

Parts required in addition to Outfits.

PARTS REQUIRED.	Parts required in addition to Outfits.				
	No. 1	No. 2	No. 3	No. 4	No. 5
46 12½" Perforated Strips	42	36	36	32	32
24 5½" " "	20	8	6	4	—
4 3½" " "	3	2	—	—	—
4 3" " "	4	4	2	—	—
34 2½" " "	25	20	20	16	—
10 12½" Angle Girders	10	6	2	2	1
4 5½" " "	4	4	4	4	4
60 Angle Brackets	50	44	34	16	7
4 11½" Rods	4	4	4	2	2
1 8" Rod	1	1	1	1	1
1 6" " "	1	1	1	—	—
4 5" Rods	4	1	—	—	—
6 Flanged Wheels	6	2	2	—	—
1 1½" Pulley Wheel	1	1	—	—	—
4 Bush Wheels	3	3	3	3	3
2 ¾" Pinion Wheels	2	2	—	—	—
2 Gear Wheels	2	2	1	1	—
292 Nuts and Bolts	272	242	222	182	132
27 Keys	18	16	5	5	—
1 Length of Chain	1	1	1	1	1
8 Double Bent Strips	8	7	7	7	7
6 Large Rectangular Plates	5	5	4	4	2
8 Small " "	8	8	5	5	3
2 Sector Plates	—	—	—	—	—

In constructing this model advantage is taken of the new rectangular perforated plates now issued with the Meccano Outfits to form the sides and inner part of the base of the side pedestals and also to form the suspended cages on the wheel.

The driving chain is conveniently kept in position around the periphery of one of the side elements of the wheel by a series of double bent strips bolted on the ends of the spokes.

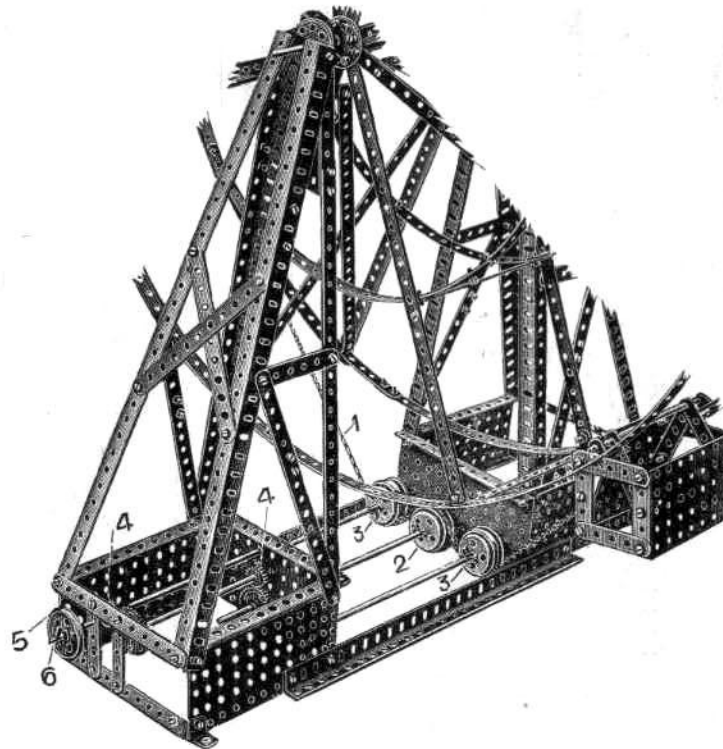

FIG. 86B

In Figure 86A is shown how the driving chain (1), passing around the driving wheel (2), is held around the circumference thereof by the guide wheels (3). The driving wheel (2) being driven through the gear wheel (4) from a $1\frac{1}{2}$ " pulley wheel (5) carried on the spindle (6).

Additional Parts



No. 21.



No. 28.



No. 27.



No. 1.



No. 9.



No. 23.



No. 33.



No. 19.



No. 35.



No. 25.



No. 32.



No. 12.



No. 34.



No. 13.



No. 20.



No. 24.

Price List of Additional Parts

			s.	d.
1.	Perforated Strips, 12 $\frac{1}{2}$ " long	.. per bdl. ($\frac{1}{2}$ doz.)	1	3
2.	" " 5 $\frac{1}{2}$ " " " "	" " " "	0	8
3.	" " 3 $\frac{1}{2}$ " " " "	" " " "	0	6
4.	" " 3" " " "	" " " "	0	6
5.	" " 2 $\frac{1}{2}$ " " " "	" " " "	0	6
6.	" " 2" " " "	" " " "	0	6
8.	Angle Girders, 12 $\frac{1}{2}$ " long	" " " "	1	9
9.	" " 5 $\frac{1}{2}$ " " " "	" " " "	1	00
12.	Angle Brackets	.. (dozen)	0	10
13.	Axle Rod, 11 $\frac{1}{2}$ " long	.. each	0	5
14.	" " 6" " " "	" " " "	0	4
15.	" " 5" or 4 $\frac{1}{2}$ " long	" " " "	0	4
16.	" " 3 $\frac{1}{2}$ " long	" " " "	0	4
17.	" " 2" " " "	" " " "	0	2
19.	Crank Handle	" " " "	0	5
20.	Flanged and Grooved Wheel	" " " "	1	3
21.	Pulley Wheel, 1 $\frac{1}{2}$ " diameter	" " " "	0	10
22.	" " 1" " " "	" " " "	0	7
23.	" " $\frac{1}{2}$ " " " "	" " " "	0	4
24.	Bush Wheel	" " " "	0	10
25.	Pinion Wheel, $\frac{3}{4}$ " diameter	" " " "	1	3
26.	" " $\frac{1}{2}$ " " " "	" " " "	0	10
27.	Gear Wheel, 1 $\frac{1}{2}$ " " " "	" " " "	1	6
28.	Contrate Wheel, 1 $\frac{1}{4}$ " diameter	" " " "	2	0
29.	Contrate Wheel, $\frac{3}{4}$ " " " "	" " " "	1	8
32.	Worm Wheel	" " " "	1	3
33.	Pawl	" " " "	0	5
34.	Spanner	" " " "	0	5
35.	Keys	.. (dozen)	0	10
36.	Screw Driver	.. each	0	5
37.	Nuts and Bolts	.. per box (2 dozen)	0	10
39.	Card Cord (Special)	.. each	0	2
40.	Hank cord	" " " "	0	2
41.	Propellor Blades	.. per pair	0	10
42.	Chain	.. 12 ft. lengths, each	1	8
43.	Spring	.. each	0	4
44.	Single Bent Strip	" " " "	0	4
45.	Double	" " " "	0	4
46.	Large	" " " "	0	4
51.	Eye Piece	" " " "	0	4
52.	Perforated Rectangular Plate Large	" " " "	0	7
53.	" " " " Small	" " " "	0	6
54.	Perforated Sector Plate, Small	" " " "	0	5
55.	Rubber Bands	" " " "	0	2

Price List.

Royal	5/-
Meccano	Outfit	No. 1.	8/6
"	"	No. 2.	16/6
"	"	No. 3.	25/-
"	"	No. 4.	40/-
"	"	No. 5.	Presentation Outfit				90/-
			Packed in well made walnut stained box with lock and key							
"	"	No. 6.	"	"	"	"	"	"	"	160/-
			Packed in well made walnut stained box with lock and key							
"	"	No. 1A	Accessory Outfit		(containing sufficient parts to convert a No. 1 into a No. 1 Outfit)					9/6
"	"	No. 2A	"	"	(containing sufficient parts to convert a No. 2 into a No. 3 Outfit)					10/6
"	"	No. 3A	"	"	(containing sufficient parts to convert a No. 3 into a No. 4 Outfit)					18/6
"	"	No. 4A	"	"	(containing sufficient parts to convert a No. 4 into a No. 5 Outfit)					58/6
			Packed in well made walnut stained box with lock and key							
"	"	No. 5A	"	"	(containing sufficient parts to convert a No. 5 into a No. 6 Outfit)					82/6
			Packed in well made walnut stained box with lock and key							

