

MECCANO



(PATENTED)

INSTRUCTIONS

For the whole series of Models,
comprising thirteen progressive outfits

9^d

Copyright by **MECCANO LIMITED. LIVERPOOL,** throughout the world

HOW TO MAKE MODELS AND TOYS WITH MECCANO

THE first piece of advice we would give to the beginner in "Meccano" is that he commences with Model No. 1, and that he erects every model in turn up to the capacity of his outfit. By that time he will have grown so familiar with the various parts of "Meccano," and will see its possibilities so clearly, that he will with little difficulty be able to build many other models of his own invention.

The charm of "Meccano" lies greatly in its endless variety, and until the user has commenced to apply his own inventive faculties to the hobby, he is not getting the enjoyment out of it which he should.

Every part of the outfit should first be taken from its box, examined, and its name committed to memory, so that the instructions in the Manual may be followed easily and rapidly.

The parts are all standardised, and are interchangeable, and they will be found to fit together easily and without forcing. The holes in the strips are of equal distance apart. The axles fit any of the holes, and their position in the various designs may be ascertained by counting the holes.

All the models shown are built upon sound and standard engineering principles, and the parts employed represent the main mechanical parts used in machinery, such as levers, beams, wheels, axles, pulleys, worm wheels, screws, bolts, keys, &c., so that as an introduction to the serious study of Mechanics the value of "Meccano" is very great indeed.

Each model may be taken in pieces, and the same parts may be used to make up other models. Additional parts can always be purchased from your dealer or from us.

We are at all times glad to correspond with users of "Meccano," and to assist them by suggestions or criticisms when difficulties occur with new models.

For the convenience of users of Meccano we have compiled a series of standard details frequently occurring in the construction of our models ; and we would particularly draw attention to the illustrations of these on pages 2 and 3.

Meccano Parts



No. 1.
Perforated Strip,
12½", 5½", 3½", 3", 2½", 2".



No. 8.
Perforated
Angle Girder,
12½", 5½".



No. 12.
Angle
Bracket.



No. 32.
Worm
Wheel.



No. 44.
Single
Bent Strip.



No. 51.
Eye
Piece.



No. 37.
Nut
and Bolt.



No. 35.
Clip.



No. 13.
Rod.
11½", 8", 6", 5", 4½", 3½", 2".



No. 19.
Crank Handle



No. 20.
Flanged and
Grooved Wheel.



No. 24.
Bush
Wheel.



No. 25.
Pinion Wheel,
¾", ½".



No. 27.
Gear Wheel.



No. 59.
Collar and Set Screw.



No. 33.
Pawl.



No. 34.
Spanner.



No. 36.
Screw Driver.



No. 21.
Pulley Wheel,
1½", 1", ½".



No. 28.
Contrate Wheel.
1½", ¾".



No. 45.
Double Bent
Strip.



No. 43.
Spring.



No. 60.
Large Bent Strip.



No. 46.
Large Bent Strip.



No. 52.
Large Rectangular
Plate.

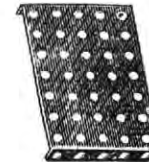

No. 53.
Small Rectangular
Plate.



No. 54.
Sector Plate.

Model No. 1. Luggage Truck

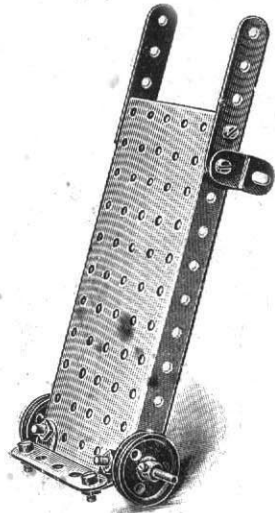

(MADE WITH MECCANO
OUTFIT NO. I.)

PARTS REQUIRED.

- 3 $2\frac{1}{2}$ " Perforated Strips.
- 6 Angle Brackets.
- 1 $4\frac{1}{2}$ " Rod.
- 2 1" Pulley Wheels.
- 10 Nuts and Bolts.
- 1 Large Rectangular Plate.



1A.

The body of the Truck is made of a rectangular plate, two $2\frac{1}{2}$ " strips being bolted through angle brackets 1A to the upper end to form shafts. The lip of the Truck consists of a $2\frac{1}{2}$ " strip bolted to the plate by angle brackets. On an axle passed through the end holes of the flanges are secured a pair of 1" pulley wheels, with set screws.

Model No. 2. Seesaw

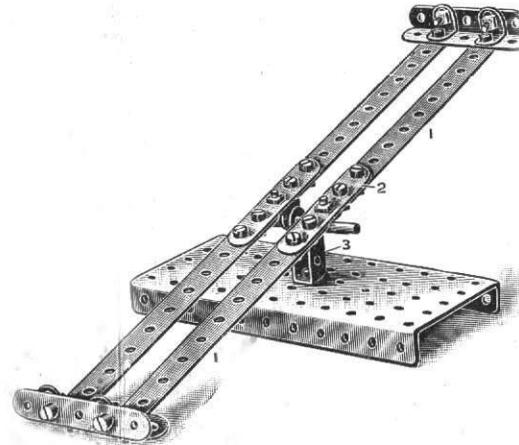

(MADE WITH MECCANO
OUTFIT NO. I.)

PARTS REQUIRED.

- 4 $5\frac{1}{2}$ " Perforated Strips.
- 6 $2\frac{1}{2}$ " " "
- 6 Angle Brackets.
- 1 2" Rod.
- 19 Nuts and Bolts.
- 2 Clips.
- 1 Single Bent Strip.
- 1 Large Rectangular Plate.

Make the Seesaw first. Commence with one side by connecting two $5\frac{1}{2}$ " strips 1 together with a $2\frac{1}{2}$ " strip 2, as shown in the illustration. An angle bracket is then bolted to the central hole of the short strip on its under side to form a bearing for the spindle. It is to be noted that the angle bracket is bolted with the head of the bolt downward, to clear the spindle. The other side of the Seesaw is formed in a similar manner.

Now connect these two together at each end by two $2\frac{1}{2}$ " strips and two angle brackets. Next bolt the single bent strip 3 to the centre of the rectangular plate; bring the two centre brackets on the under side of the Seesaw in line with the top holes in the bent strip, and pass through the short rod fixing a clip on each side to keep it in position.

Model No. 3. Revolver Truck

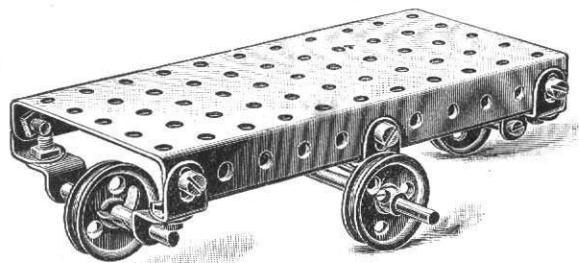

(MADE WITH MECCANO
OUTFIT NO. I.)

PARTS REQUIRED.

- 12 Angle Brackets.
- 1 $4\frac{1}{2}$ " Rod.
- 2 2" Rods.
- 4 1" Pulley Wheels.
- 12 Nuts and Bolts.
- 4 Clips.
- 1 Large Rectangular Plate.

FIG. 3A



FIG. 3B



In a Revolver Truck the two end wheels are always raised just a little higher than the two centre wheels with a moderate amount of play on the axles, so that the Truck may be quickly revolved upon the centre wheels.

The bearings for the end axles are formed by connecting two angle brackets together, as shown in Fig. 3A, and bolting them in each end hole at the sides of the plate.

The two centre bearings are formed as shown in Fig. 3B, and bolted in the centre holes of each flanged side of the plate.

It will be noted that the elongated holes of the bearings are bolted on the outside of the plate flanges. This enables the end wheels to be raised and the centre wheels to be lowered for the purpose already mentioned.

The axle carrying the two centre wheels is then placed in position, and the wheels having set screws are secured to this axle, while the two end wheels run freely on the rods, the latter being held in position by clips.

Model No. 4. Truck

(MADE WITH MECCANO OUTFIT NO. I.)

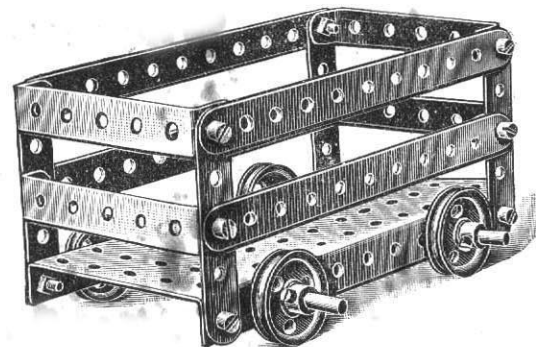

PARTS REQUIRED.

- | | |
|---------------------------------------|----------------------------|
| 4 $5\frac{1}{2}$ " Perforated Strips. | 4 1" Pulley Wheels. |
| 4 $2\frac{1}{2}$ " " " | 12 Nuts and Bolts. |
| 4 $2\frac{3}{8}$ " Bent Strips. " | 1 Large Rectangular Plate. |
| 2 $4\frac{1}{2}$ " Rods. | |

Fix the four upright $2\frac{1}{2}$ " strips at each corner of the plate first; then attach the $2\frac{1}{2}$ " bent strips and $5\frac{1}{2}$ " side strips to the uprights by means of nuts and bolts. Insert two axles through the third holes from each end of the plate; push on the wheels, and secure them in position by the clips.

This is a very neat little model, and very simple make.

Model No. 5. Luggage Truck

(MADE WITH MECCANO OUTFIT NO. 1.)

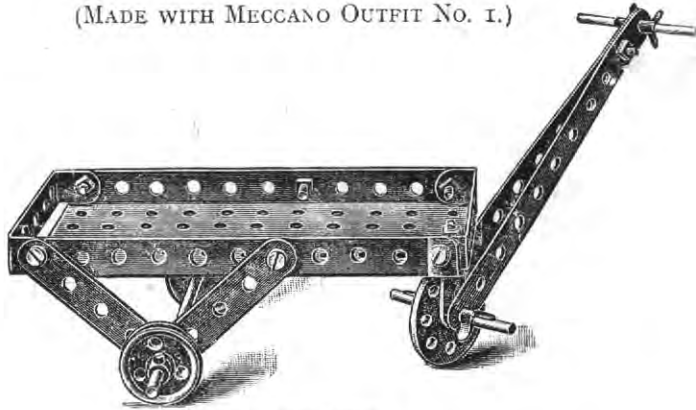

PARTS REQUIRED.

2	5½"	Perforated Strips.	2	1"	Pulley Wheels.
4	2½"	"	1		Bush Wheel.
2	2½"	Bent Strips.	9		Nuts and Bolts.
1	4½"	Rod.	4		Clips.
2	2"	"	1		Single Bent Strip.
			1		Large Rectangular Plate.

In connection with the construction of this Model, it will only be necessary to state that the front swivelling support is formed by connecting loosely a single bent strip in the centre end hole of the plate, by a bolt with two nuts on the upper side, locked (see standard detail D, page 94) to prevent it from working out, and that the axle carrying the hind wheels is passed through the end holes of the 2½" diagonal side strips which form the bearings.

Model No. 6. Bath Chair

(MADE WITH MECCANO OUTFIT NO. 1.)

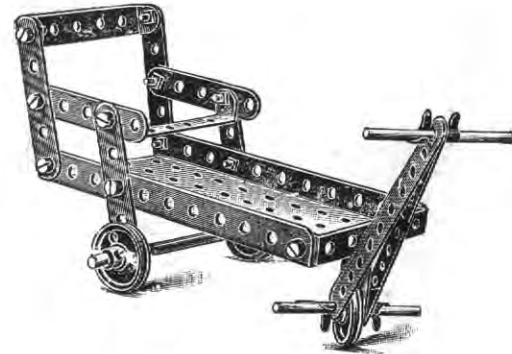

PARTS REQUIRED.

2	5½"	Perforated Strips.	3	1"	Pulley Wheels.
6	2½"	"	14		Nuts and Bolts.
3	2½"	Bent Strips.	4		Clips.
6		Angle Brackets.	1		Single Bent Strip.
1	4½"	Rod.	1		Large Rectangular Plate.
2	2"	Rods.			

After Model No. 5 has been accomplished, no difficulty will be experienced in the construction of this model.

Model No. 7. Go Chair

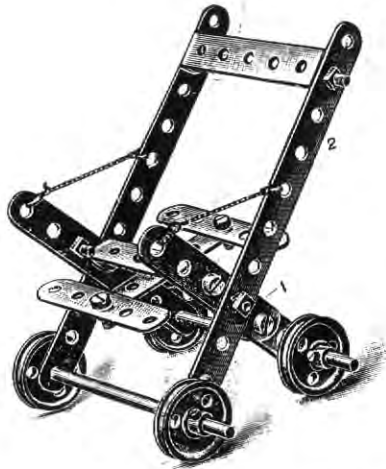

(MADE WITH
MECCANO OUTFIT
NO. I.)

PARTS REQUIRED.

- 2 5½" Perforated Strips.
- 7 2½" " "
- 2 2½" Bent Strips.
- 2 4½" Rods.
- 4 1" Pulley Wheels.
- 13 Nuts and Bolts.

Proceed to construct one side of this Model first by taking two 2½" strips 1 and bolting them together overlapped in three holes; after which attach diagonally a 5½" strip 2 in the fourth hole from the bottom, and with the same bolt a 2½" bent strip on the inside. The other side is constructed in a similar manner. The sides are then brought together and connected by the 2½" bent strip.

The seat is then formed by bolting a 2½" strip at right angles with the central 2½" bent strip, and a further 2½" strip at each end.

The back is formed by connecting a 2½" bent strip in the second hole from the top of the two 5½" side strips. Two axle rods are then passed through the bottom holes, and the wheels placed in position, and secured by the clips.

Model No. 8. Luggage Truck

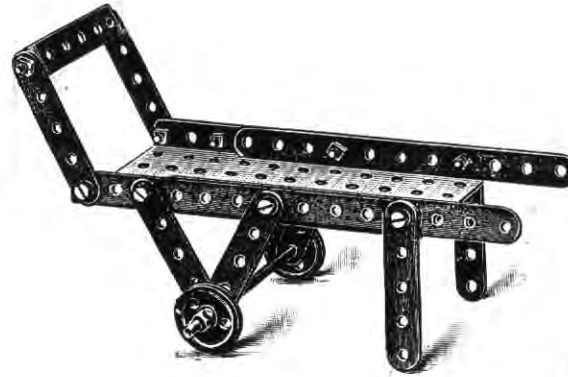

(MADE WITH
MECCANO OUTFIT
NO. I.)

PARTS REQUIRED.

- 2 5½" Perforated Strips.
- 8 2½" " "
- 1 2½" Bent Strip.
- 1 4½" Rod.
- 2 1" Pulley Wheels.
- 10 Nuts and Bolts.
- 1 Large Rectangular Plate.

This is very similar to Model No. 5, and requires no explanation.

Model No. 9. Luggage Barrow

(MADE WITH MECCANO OUTFIT NO. 1.)

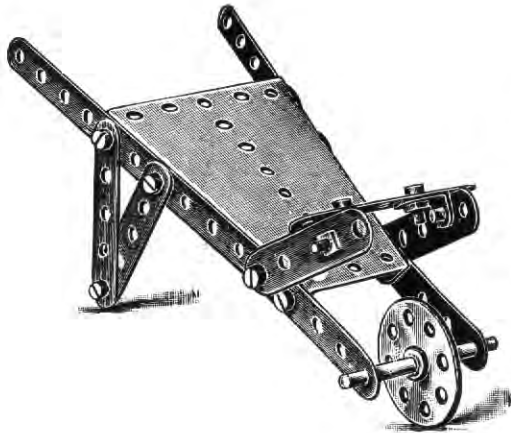

PARTS REQUIRED.

- 2 5½" Perforated Strips.
- 9 2½" " "
- 2 Angle Brackets.
- 1 2" Rod.
- 1 Bush Wheel.
- 14 Nuts and Bolts
- 2 Clips.
- 1 Sector Plate.

The only point to be noted in this Model is that the floor plate of the Barrow is made from a sector plate, to the sides of which the arm strips are secured, made up from two 5½" strips bolted on the inside of the sector plate; the 2½" strips carrying the wheel axle being bolted on the outside of the sector plate.

Model No. 10. Truck

(MADE WITH MECCANO OUTFIT NO. 1.)

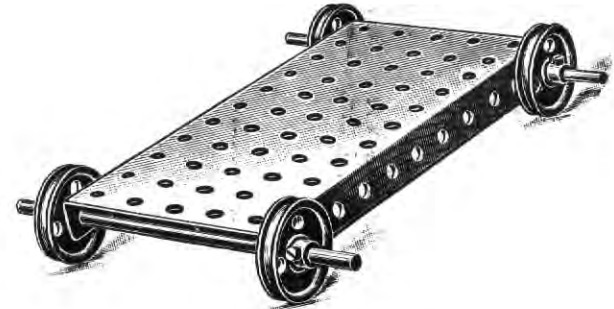

PARTS REQUIRED.

- 2 4½" Rods,
- 4 1" Pulley Wheels
- 1 Large Rectangular Plate.

Model No. 11. Endless Rope Railway

(MADE WITH MECCANO OUTFIT NO. 1.)

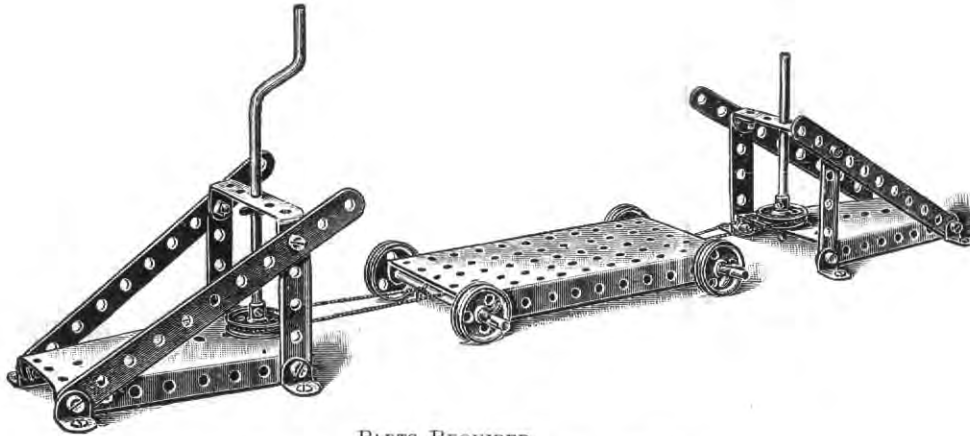

PARTS REQUIRED.

4	5½" Perforated Strips.	6	1" Pulley Wheels.
6	2½" Bent " Strips. "	12	Nuts and Bolts.
2	2½" Bent " Strips. "	4	Clips.
8	Angle Brackets.	1	Large Rectangular Plate.
3	4½" Rods.	2	Sector Plates.
1	Crank Handle.		

This is an attractive little combination working model, which will well repay a little trouble in making.

The truck is connected to an endless cord which passes from a pulley attached to a bracket at one end to another pulley carried on the crank handle shown. In the illustration the two pulleys are shown close together to save space, but they may, of course, be placed at any distance desired.

A length of cord is formed into an endless rope running over the two pulleys, and the truck is attached to one side of the string, so that by rotating the handle in one direction or another the truck is moved as desired.

Model No. 12. Swing

(MADE WITH MECCANO OUTFIT NO. 1.)



PARTS REQUIRED.

4	12½" Perforated Strips.	3	2½" Bent Strips.
1	5½" " "	4	Angle Brackets.
6	2½" " "	12	Nuts and Bolts
		1	Large Rectangular Plate.

Model No. 13. Ladder

(MADE WITH MECCANO OUTFIT NO. 1.)

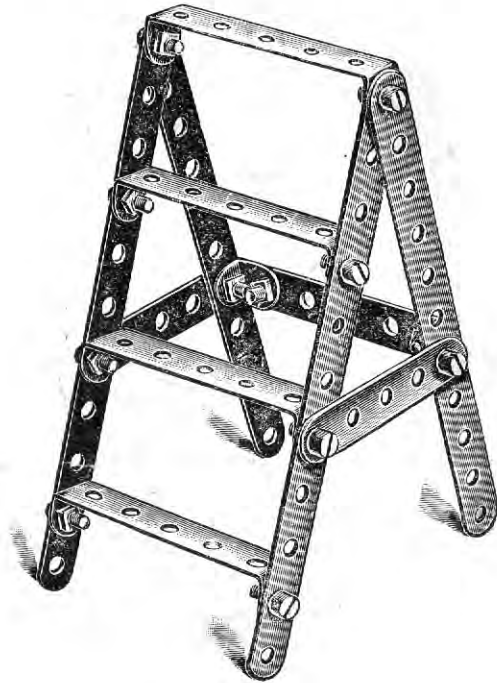

PARTS REQUIRED.

- 4 5½" Perforated Strips.
- 3 2½" " "
- 4 2½" Bent Strips.
- 2 Angle Brackets.
- 12 Nuts and Bolts.

Model No. 14. Cot on Wheels

(MADE WITH MECCANO OUTFIT NO. 1.)

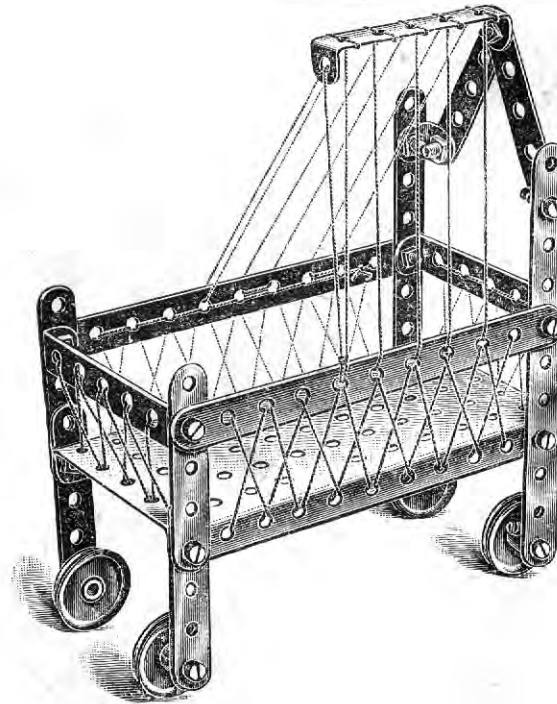

PARTS REQUIRED.

- 4 5½" Perforated Strips
- 6 2½" " "
- 3 2½" Bent Strips.
- 2 Angle Brackets.
- 4 1" Pulley Wheels.
- 17 Nuts and Bolts

In the construction of this Model it will only be necessary to say that the two front uprights are formed by 2½" strips overlapped two holes. The wheels are secured, as shown in standard detail R, in the bottom holes.

Model No. 15. Telpher Span

(MADE WITH MECCANO OUTFIT NO. 1.)

PARTS REQUIRED.

2	12 $\frac{1}{2}$ "	Perforated Strips,	1	Crank Handle.
2	5 $\frac{1}{2}$ "	" "	5	1" Pulley Wheels.
6	2 $\frac{1}{2}$ "	" "	20	Nuts and Bolts.
3	2 $\frac{1}{2}$ "	Bent Strips.	6	Clips.
4		Angle Brackets.	1	Single Bent Strip.
2	4 $\frac{1}{2}$ "	Rods.	1	Large Rectangular Plate.
1	2"	"	2	Sector Plates.

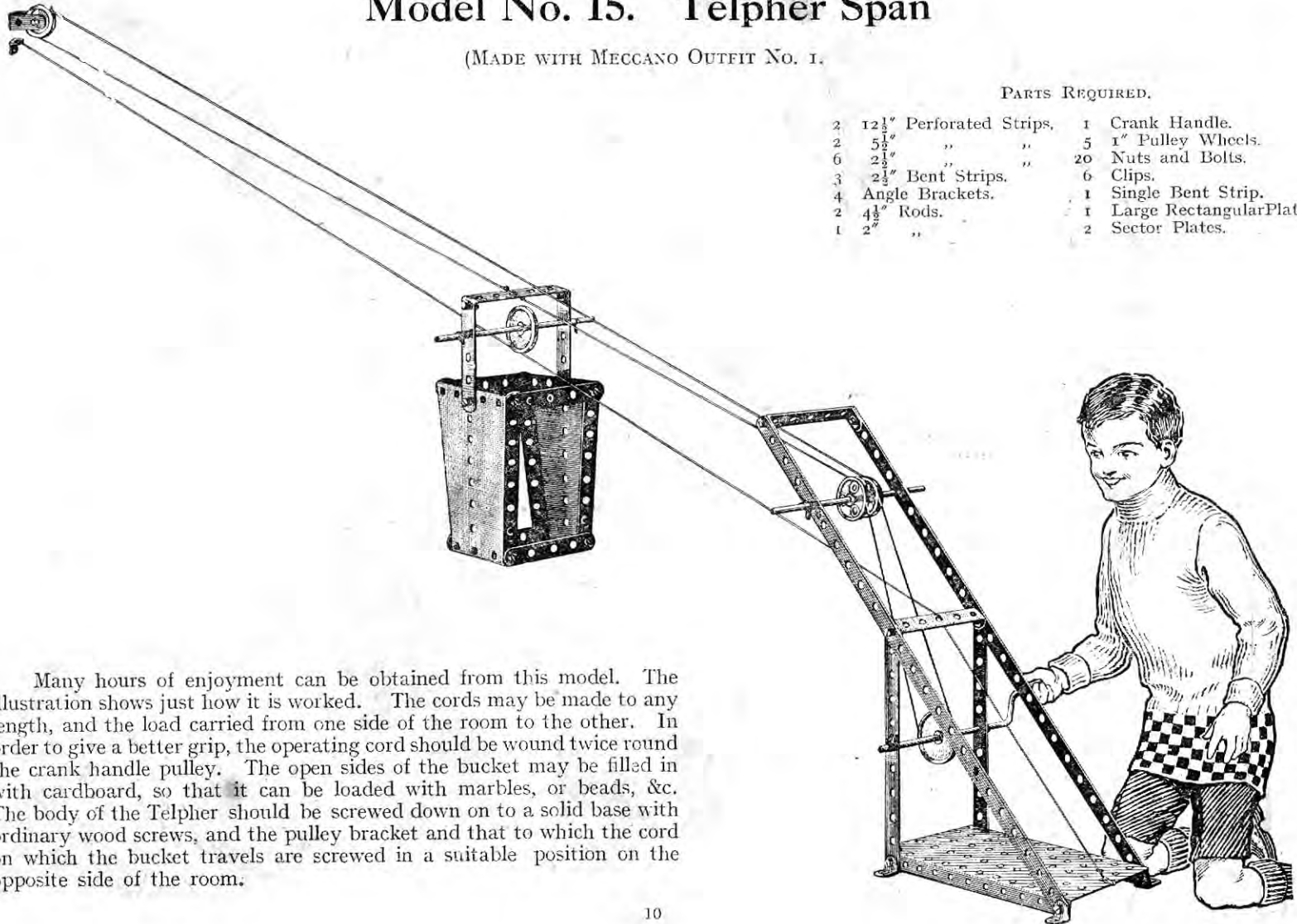

Many hours of enjoyment can be obtained from this model. The illustration shows just how it is worked. The cords may be made to any length, and the load carried from one side of the room to the other. In order to give a better grip, the operating cord should be wound twice round the crank handle pulley. The open sides of the bucket may be filled with cardboard, so that it can be loaded with marbles, or beads, &c. The body of the Telpher should be screwed down on to a solid base with ordinary wood screws, and the pulley bracket and that to which the cord on which the bucket travels are screwed in a suitable position on the opposite side of the room.

Model No. 16. Travelling Jib Crane

(MADE WITH MECCANO OUTFIT NO. 1.)

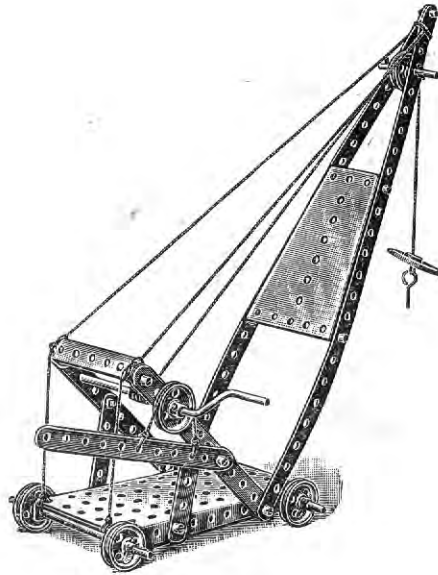

PARTS REQUIRED.

2	12½"	Perforated Strips.	6	1"	Pulley Wheels.
3	5½"	"	1		Bush Wheel.
2	2½"	"	15		Nuts and Bolts.
1	2½"	Bent Strip.	1		Hook.
2	4½"	Rods.	5		Clips.
1	2"	Rod.	1		Large Rectangular Plate.
1		Crank Handle.	1		Sector Plate.

Model No. 17. Scales

(MADE WITH MECCANO OUTFIT NO. 1.)

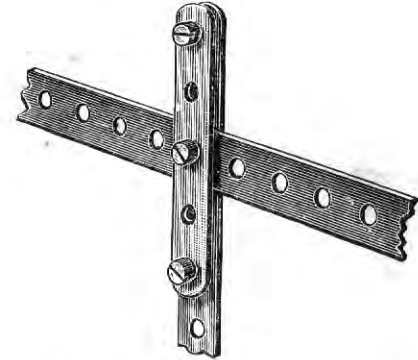
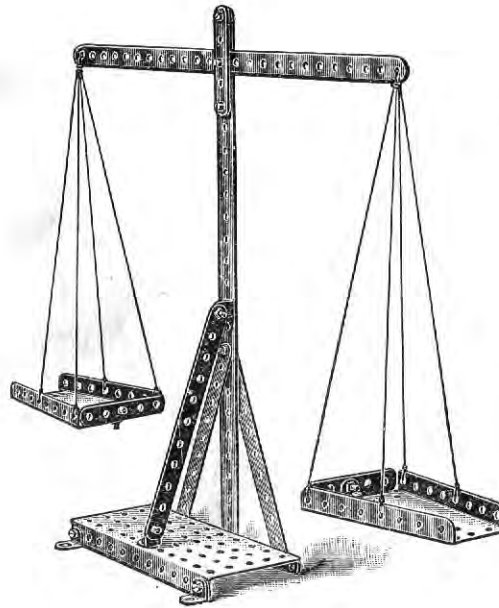

PARTS REQUIRED.

2	12½"	Perforated Strips.	4		Angle Brackets.
3	5½"	"	19		Nuts and Bolts.
1	2½"	"	1		Large Rectangular Plate.
2	2½"	Bent Strips.	2		Sector Plates.

The scale beam of this model is pivoted in a slot at the top of the upright standard. This slot is formed by bolting a 2½" strip to the standard, nuts being placed between the strip and the standard before screwing up. These nuts hold the strip and the standard at the required distance apart to give the beam free play.

Model No. 18. Travelling Ladder

(MADE WITH MECCANO OUTFIT NO. 1.)

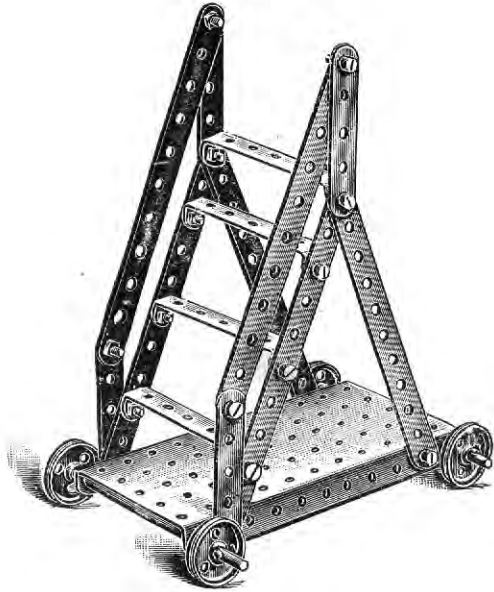

PARTS REQUIRED.

- | | | | |
|---|------------------------|----|--------------------------|
| 6 | 5½" Perforated Strips. | 4 | 1" Pulley Wheels. |
| 4 | 2½" " " | 16 | Nuts and Bolts. |
| 4 | 2½" Bent Strips. | 4 | Clips. |
| 2 | 4½" Rods. | 1 | Large Rectangular Plate. |

Model No. 19. High Level Bridge

(MADE WITH MECCANO OUTFIT NO. 1.)

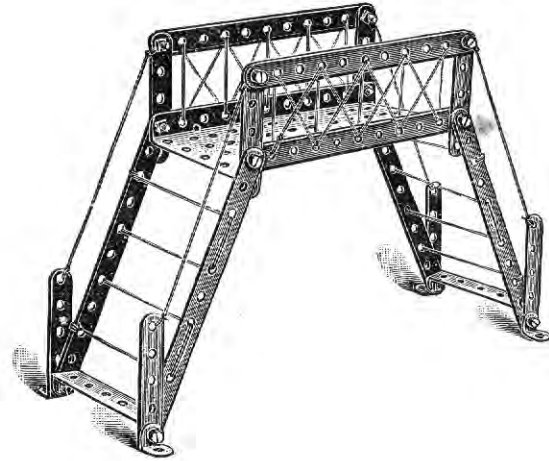

PARTS REQUIRED.

- | | | | |
|---|------------------------|----|--------------------------|
| 6 | 5½" Perforated Strips. | 4 | Angle Brackets. |
| 8 | 2½" " " | 12 | Nuts and Bolts. |
| 2 | 2½" Bent Strips. | 1 | Large Rectangular Plate. |

Model No. 20. Tip Wagon

(MADE WITH MECCANO OUTFIT NO. 1.)

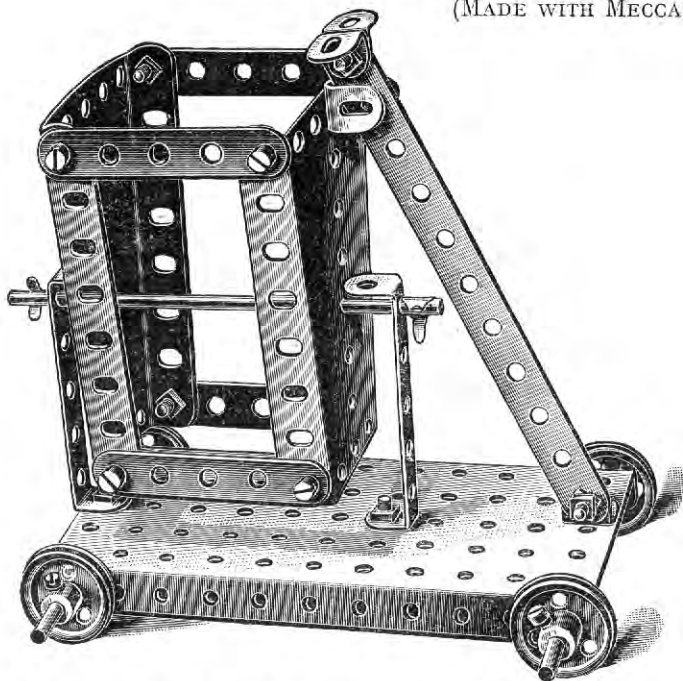

PARTS REQUIRED.

- 1 5½" Perforated Strip.
- 4 2½" " "
- 2 2½" Bent Strips.
- 5 Angle Brackets.
- 3 4½" Rods.
- 4 1" Pulley Wheels.
- 14 Nuts and Bolts.
- 2 Clips.
- 1 Large Rectangular Plate.



20.A.

FIG. 20A

This interesting Model represents a Tip Wagon, such as is used on constructional or embankment work for carrying loads of earth, &c., along a track in such manner that the load may be readily tipped to one side or the other at any required position.

The sides of the Tip consist of sector plates connected at the top and bottom by 2½" strips. The pivoted lever strip at the end engages between a pair of inclined angle brackets, see Fig. 20A, to lock the Tip. By releasing the lever, the Tip may be swung to either side. To enable the Model to hold material, a bent piece of cardboard may be inserted resting on the axle.

Model No. 21. Windmill

(MADE WITH MECCANO OUTFIT NO. 1.)

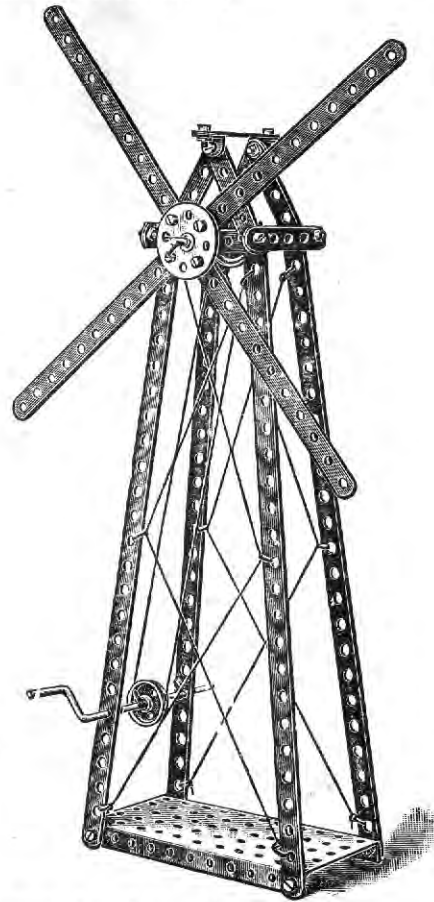

PARTS REQUIRED.

- 4 12 $\frac{1}{2}$ " Perforated Strips.
- 4 5 $\frac{1}{2}$ " " "
- 7 2 $\frac{1}{2}$ " " "
- 2 2 $\frac{1}{3}$ " Bent Strips.
- 6 Angle Brackets.
- 1 4 $\frac{1}{2}$ " Rod.
- 1 Crank Handle.
- 2 1" Pulley Wheels.
- 1 Bush Wheel.
- 20 Nuts and Bolts.
- 4 Clips.
- 1 Large Rectangular Plate.

This model may be driven by the No. 1 Meccano Spring Motor (see page 97).

Model No. 22. Railway Signal

(MADE WITH MECCANO OUTFIT NO. 1.)

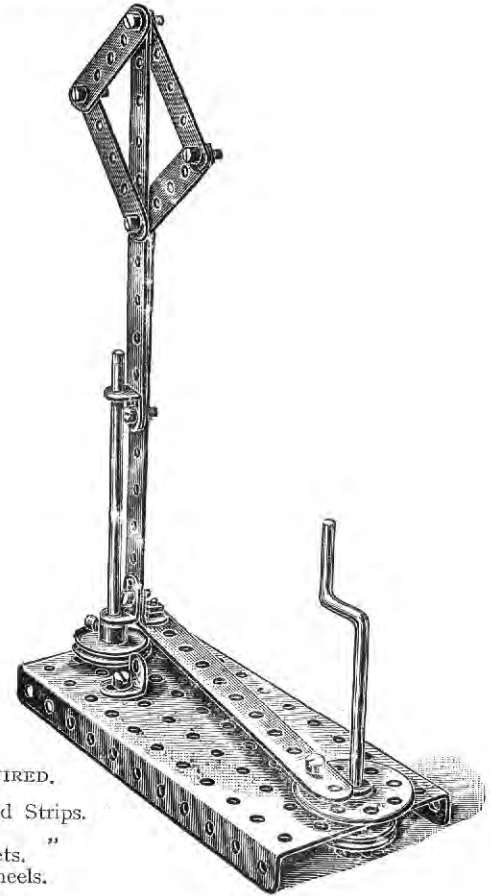

PARTS REQUIRED.

- 3 5 $\frac{1}{2}$ " Perforated Strips.
- 4 2 $\frac{1}{2}$ " " "
- 5 Angle Brackets. "
- 3 1" Pulley Wheels.
- 1 Bush Wheel.
- 1 4 $\frac{1}{2}$ " Rod.
- 1 Crank Handle.
- 14 Nuts and Bolts.
- 1 Large Rectangular Plate.

Railway Signals

Model No. 23

(MADE WITH MECCANO OUTFIT NO. 1.)

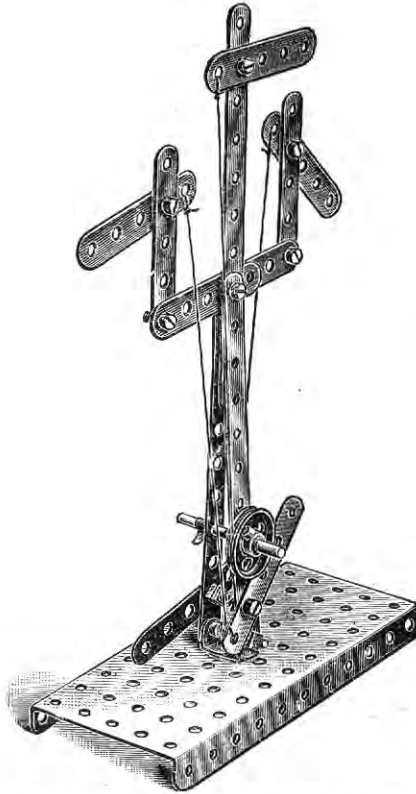

PARTS REQUIRED.

- 1 12 $\frac{1}{2}$ " Perforated Strip,
- 1 5 $\frac{1}{2}$ " " "
- 1 3 $\frac{1}{2}$ " " "
- 7 2 $\frac{1}{2}$ " " "
- 2 Angle Brackets.
- 1 2" Rod.
- 1 1" Pulley Wheel.
- 1 Clip.
- 16 Nuts and Bolts.
- 1 Large Rectangular Plate.

The two outside signals of this Model are operated by the levers pivoted to the upright, and the centre signal by the pulley wheel. The cord operating this latter signal is securely tied round the pulley wheel so that when the wheel is turned the signal is raised or lowered.

Model No. 24

PARTS REQUIRED.

- 2 12 $\frac{1}{2}$ " Perforated Strips.
- 2 5 $\frac{1}{2}$ " " "
- 1 3 $\frac{1}{2}$ " " "
- 4 Angle Brackets. "
- 1 2" Rod.
- 2 1" Pulley Wheels.
- 19 Nuts and Bolts.
- 2 Clips.
- 1 Large Rectangular Plate.
- 1 Sector Plate.

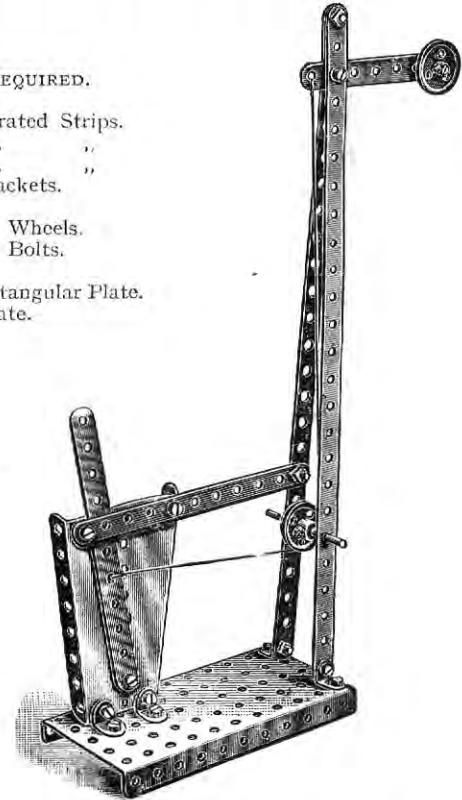

In fixing the lever to the sector plate at the bottom, lock the nuts, as shown in standard detail D, so as to prevent the screw from working out.

Model No. 25. Monoplane

(MADE WITH MECCANO OUTFIT NO. I.)

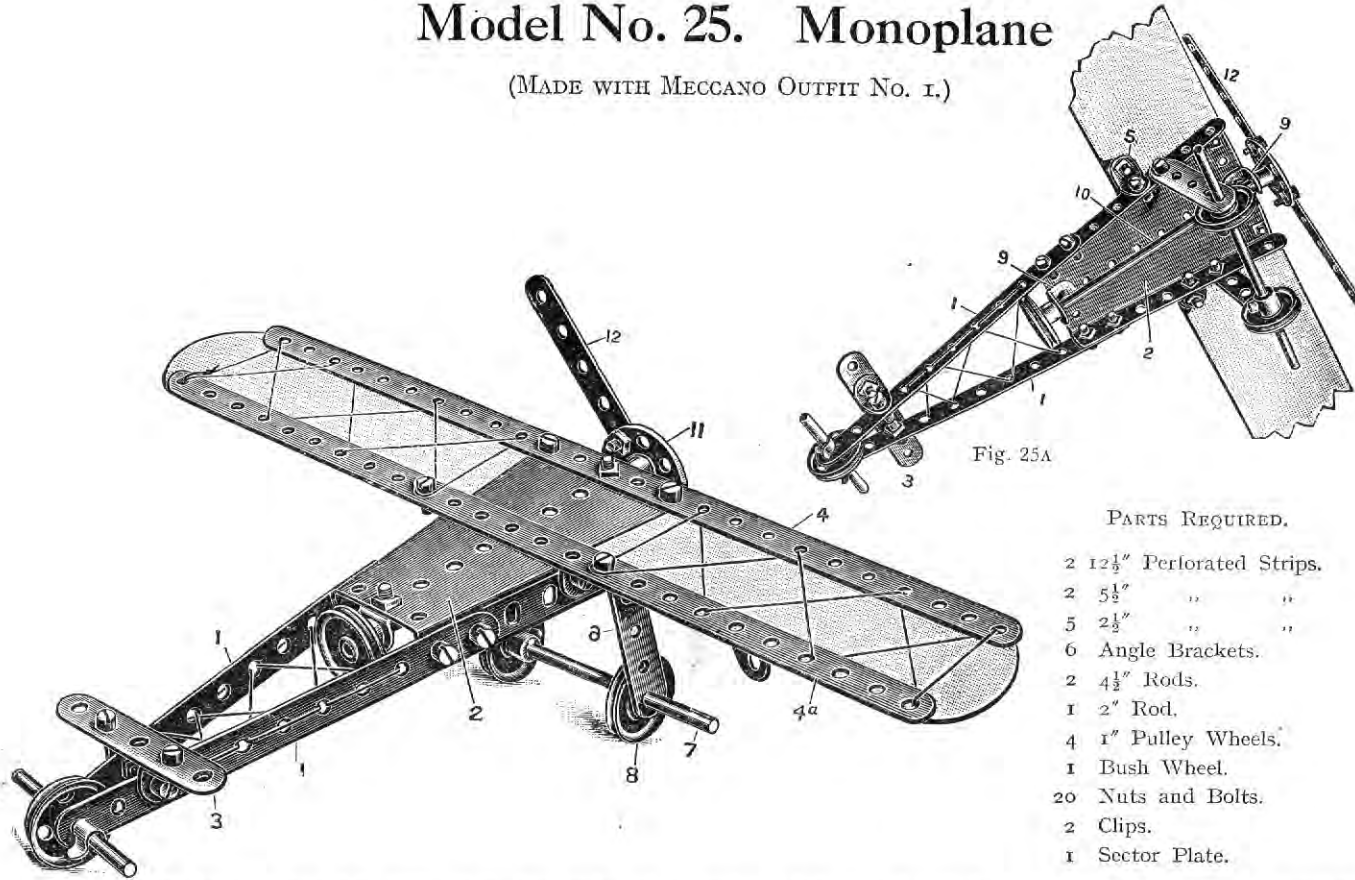

Fig. 25A

PARTS REQUIRED.

- 2 $12\frac{1}{2}$ " Perforated Strips.
- 2 $5\frac{1}{2}$ " " "
- 5 $2\frac{1}{2}$ " " "
- 6 Angle Brackets.
- 2 $4\frac{1}{2}$ " Rods.
- 1 2" Rod.
- 4 1" Pulley Wheels.
- 1 Bush Wheel.
- 20 Nuts and Bolts.
- 2 Clips.
- 1 Sector Plate.

Begin by bolting two $5\frac{1}{2}$ " strips 1 to the ends of a sector plate 2; the tail plane of the monoplane consisting of a $2\frac{1}{2}$ " strip 3 is then connected to the body strips 1 by angle brackets. The two $12\frac{1}{2}$ " strips 4 are then bolted to the sector plate, the outer strip 4 being bolted direct and the inner strip 4A by means of angle brackets 5. These strips 4 and 4A may be fitted with cardboard strips or laced to imitate the wings. Two $2\frac{1}{2}$ " strips 6 are then bolted vertically to the sector plate 2, and a rod 7 passed through the lowest holes to carry the wheels 8. Angle brackets 9 are then bolted to the ends of the sector plate 2, and a rod 10 to form the engine shaft is threaded in these angle brackets and fitted at the forward end with a bush wheel 11, to which is bolted perforated strips 12 to form the propeller blades.

Model No. 26. Turntable Gangway

(MADE WITH MECCANO OUTFIT NO. 1.)

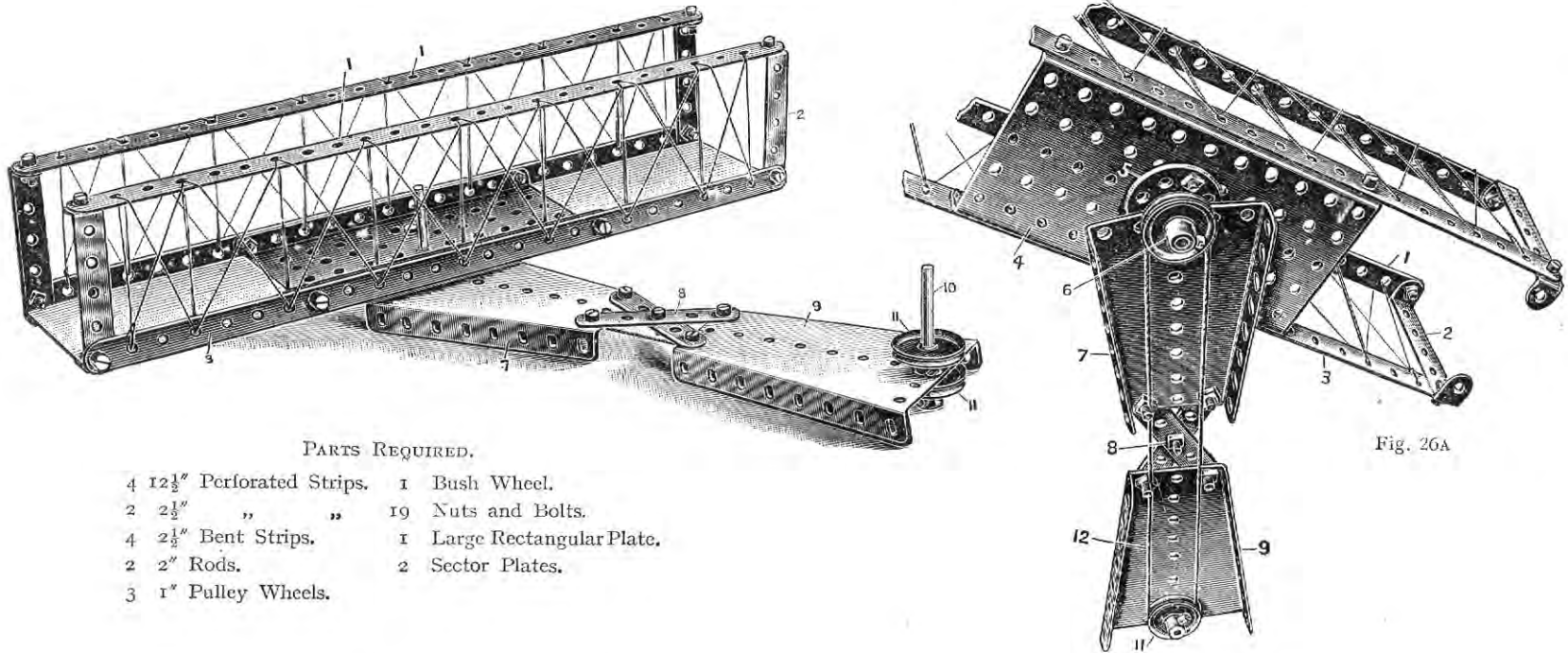

PARTS REQUIRED.

- | | |
|--|----------------------------|
| 4 $12\frac{1}{2}$ " Perforated Strips. | 1 Bush Wheel. |
| 2 $2\frac{1}{2}$ " " " | 19 Nuts and Bolts. |
| 4 $2\frac{1}{2}$ " Bent Strips. | 1 Large Rectangular Plate. |
| 2 2" Rods. | 2 Sector Plates. |
| 3 1" Pulley Wheels. | |

The side frames of the gangway are made of $12\frac{1}{2}$ " strips 1 bolted by means of $2\frac{1}{2}$ " bent strips 2 to lower strips 3, the strips 3 and 1 being set at right angles to each other, and the side frames being connected by a perforated rectangular plate 4. A bush wheel 5 is bolted to the underneath of the rectangular plate and fitted with a rod on which is mounted a grooved pulley 6, the rod passing through one of the end holes of a sector plate 7. This sector plate 7 is connected by diagonal strips 8 to another sector plate 9, through the end hole of which a rod 10 is threaded carrying grooved pulleys 11. An operating cord 12 passes from the grooved pulley 11 to the pulley 6. In this way the gangway may be rotated by operating the spindle 10.

Model No. 27. Swivelling Jib Crane

(MADE WITH MECCANO OUTFIT NO. 1.)

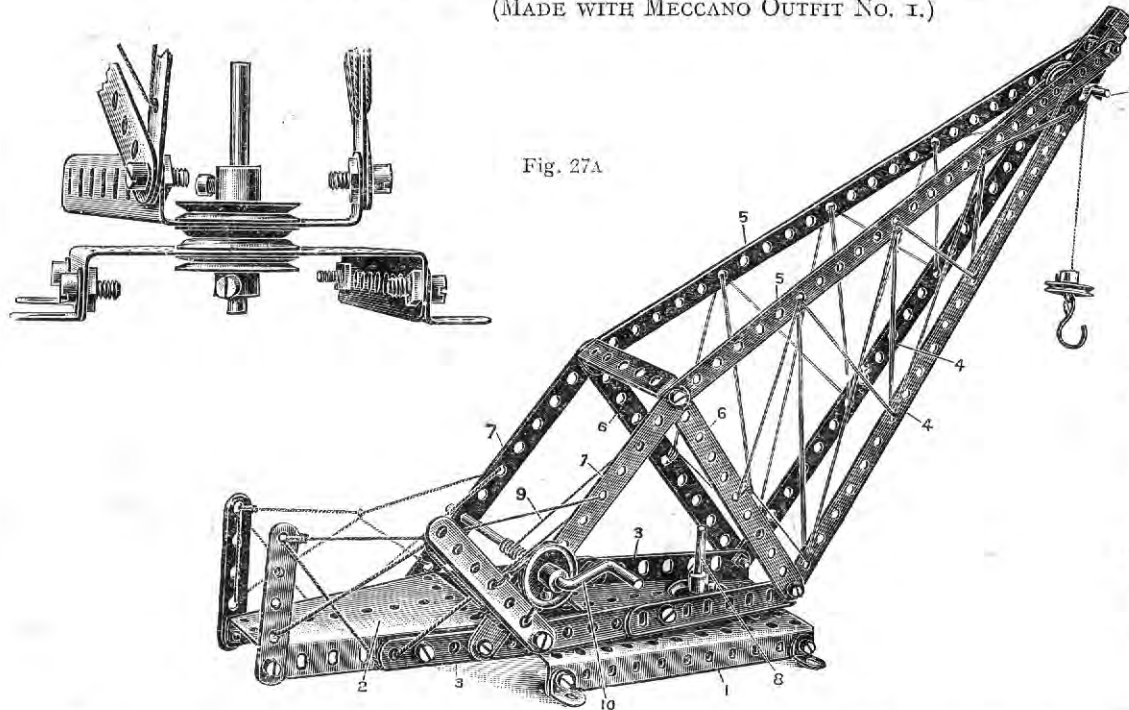

Fig. 27A

PARTS REQUIRED.

- 4 $12\frac{1}{2}$ " Perforated Strips.
- 6 $5\frac{1}{2}$ " " " "
- 1 $3\frac{1}{2}$ " " " "
- 2 $2\frac{1}{2}$ " " " "
- 1 $2\frac{1}{2}$ " Bent Strips.
- 4 Angle Brackets.
- 2 2" Rods.
- 1 Crank Handle.
- 6 1" Pulley Wheels.
- 3 Clips.
- 19 Nuts and Bolts.
- 1 Single Bent Strip.
- 1 Large Rectangular Plate.
- 2 Sector Plates.

The fixed base of this Crane is a perforated rectangular plate 1, and the swivelling base of the Crane is formed by two sector plates 2 and 3. The jib is formed from two $12\frac{1}{2}$ " strips 4 bolted to the ends of the sector plate 3, two other $12\frac{1}{2}$ " strips 5 being bolted to the top of the strips 4 and to cross strips 6, the outer ends of these latter strips being stayed by strips 7 bolted to the other sector plate. The upper structure of the Crane swivels about a rod 8, and is secured as shown in Fig. 27A. The winding rope 9 is operated by the crank handle 10 and passes over a pulley in the head of the Crane on a short rod 11.

HOW TO CONTINUE

This completes the Models which may be made with Meccano Outfit No. 1. The next Models are a little more advanced, requiring a number of extra parts to construct them. The necessary parts are all contained in a No. 1A Accessory Outfit, the cost of which will be found in the Price List at the end of the Manual.

Model No. 35 Ladder on Wheels

(MADE WITH MECCANO OUTFIT NO. 2, OR NO. 1 AND NO. 1A.)

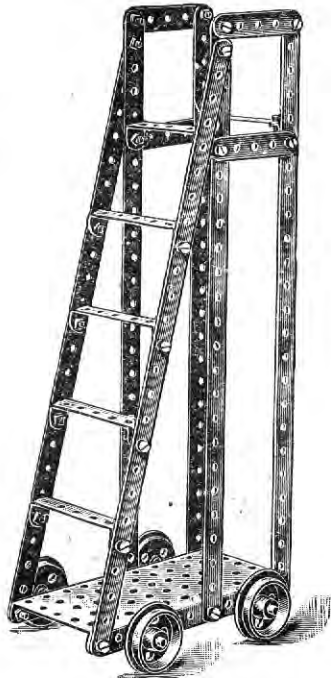

PARTS REQUIRED.

- 6 12½" Perforated Strips
- 4 2½" " "
- 6 2½" Bent Strips.
- 2 5" Rods.
- 4 Flanged Wheels.
- 24 Nuts and Bolts.
- 1 Large Rectangular Plate.

Parts required in addition to

Outfit No. 1.

- 2 12½" Perforated Strips.
- 2 5" Rods.
- 4 Flanged Wheels.
- 4 Nuts and Bolts.

Model No. 36 Tipping Motor Wagon

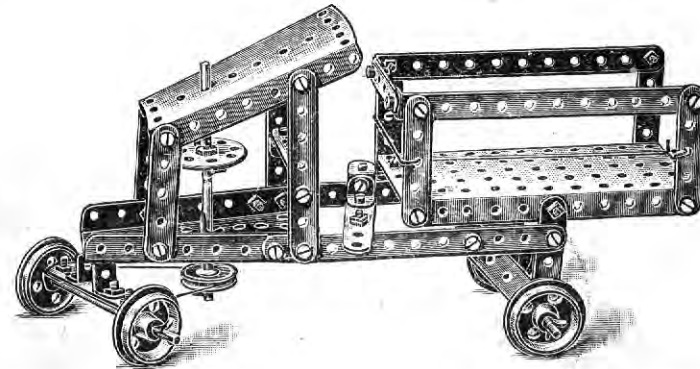

PARTS REQUIRED.

- 4 5½" Perforated Strips.
- 2 3½" " "
- 12 2½" " "
- 3 2½" Bent Strips.
- 5 Angle Brackets.
- 3 5" Rods.
- 4 Flanged Wheels.
- 2 1" Pulleys.
- 1 Bush Wheel.
- 38 Nuts and Bolts.
- 1 Double Bent Strip.
- 1 Large Rectangular Plate
- 2 Sector Plates.

Parts required in addition to
Outfit No. 1.

- 1 3½" Perforated Strip.
- 3 2½" " "
- 3 5" Rods.
- 4 Flanged Wheels.
- 18 Nuts and Bolts.
- 1 Double Bent Strip.

Model No. 37. Travelling Jib Crane

(MADE WITH MECCANO OUTFIT NO. 2 OR NO. 1 AND NO. 1A.)

This is so important a model that we have thought it best to give a detailed description of it, making use of engineering terms. It can be erected from a study of the illustration alone, but we strongly recommend our enthusiastic young friend to carefully read our instructions, and to make himself familiar with the correct technical description and terms. This model will well repay the time expended on a close and careful study.

The lower horizontal sides of the crane should first be put together. Each side consists of an angle girder joined at one end to a rectangular plate, two holes overlapping, and at the other end by a $2\frac{1}{2}$ " strip. The winch frame is formed of two sector plates bolted to the rectangular plate and connected together at their tops by two $2\frac{1}{2}$ " strips. The wheel axles are inserted through appropriate holes in the ends of the horizontal frame.

The bearings for the winch handle are formed by two holes in the sector plates; the winch handle has a pulley wheel and a strip is pivoted to the right-hand sector plate, to form a brake wheel and lever.

Each side of the jib is constructed of two $12\frac{1}{2}$ " strips, jointed together by overlapping; at the top where the sides meet a pulley is fixed on a short length of spindle, and at the bottom the two sides are respectively screwed to the two ends of the horizontal base.

The jib is braced by two diagonally arranged $12\frac{1}{2}$ " strips attached to the sides of the jib by angle pieces.

From each side of the jib two $12\frac{1}{2}$ " strips are carried to a truss member, formed of two $12\frac{1}{2}$ " strips united together, secured at one end to the screws at the base of the jib, and united at their other ends by a $2\frac{1}{2}$ " bent strip. The truss frame is connected to the horizontal base by two $5\frac{1}{2}$ " strips as shown.

The rope by which the weight is raised has one end fixed to the end of the jib; it is then passed round the pulley block, then over the jib pulley, and finally connected to the winch handle.

The crane is further strengthened by strings to represent tie rods, which connect the ends of the jib, the truss frame, and the winch frame as shown. The joint between the truss frame, the side frame, and the jib, should be made with a single pair of screws which should also carry the angle pieces for the cross bracing of the crane.

PARTS REQUIRED.	
10	$12\frac{1}{2}$ " Perforated Strips
3	$5\frac{1}{2}$ " " "
3	$2\frac{1}{2}$ " " "
1	$2\frac{1}{2}$ " Bent Strip
2	Angle Girders
4	Angle Brackets
2	$5\frac{1}{2}$ " Rods
2	" "
1	Crank Handle
4	Flanged Wheels
3	1" Pulley Wheels
1	Bush Wheel
35	Nuts and Bolts
1	Hook
5	Clips
1	Single Bent Strip
1	Large Rectangular Plate
2	Sector Plates

*Parts required in addition to
Outfit No. 1*

6	$12\frac{1}{2}$ " Perforated Strips
2	Angle Girders
2	$5\frac{1}{2}$ " Rods
4	Flanged Wheels
15	Nuts and Bolts

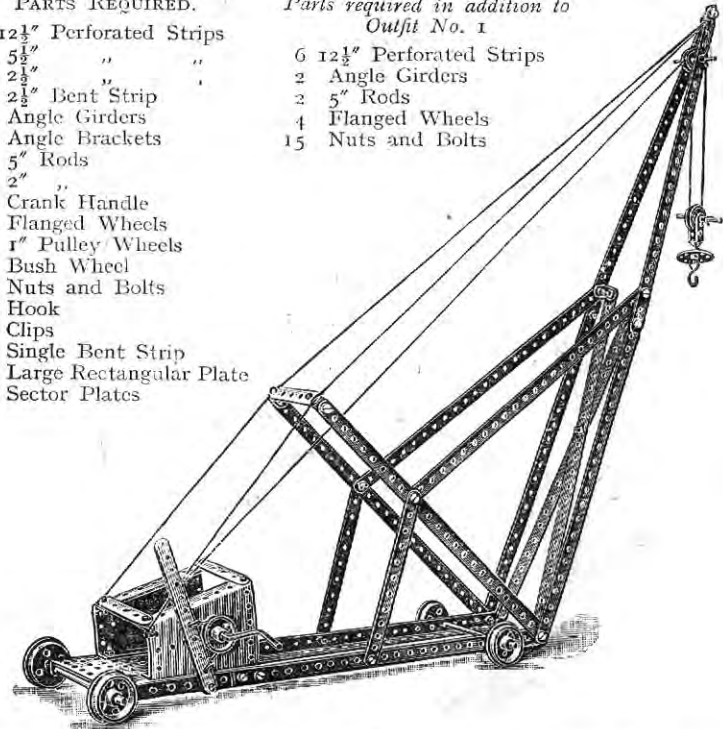

Model No. 38. Small Windmill

(MADE WITH MECCANO OUTFIT NO. 2.)

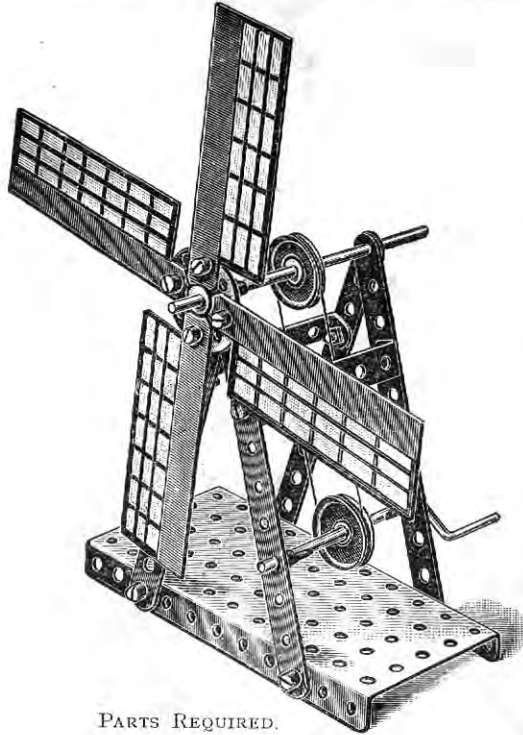

PARTS REQUIRED.

- | | | |
|----|---------------------------|--|
| 4 | 5 1/2" Perforated Strips. | <i>Parts required in addition to Outfit No. 1.</i> |
| 2 | 2 1/2" Bent Strips. | |
| 1 | 4 1/2" Rod. | 4 Sails. |
| 1 | Crank Handle. | |
| 2 | Pulley Wheels. | |
| 1 | Bush Wheel. | |
| 12 | Nuts and Bolts. | |
| 3 | Clips. | |
| 1 | Large Rectangular Plate. | |
| 4 | Sails. | |

Model No. 39. Windmill

(MADE WITH MECCANO OUTFIT NO. 2.)

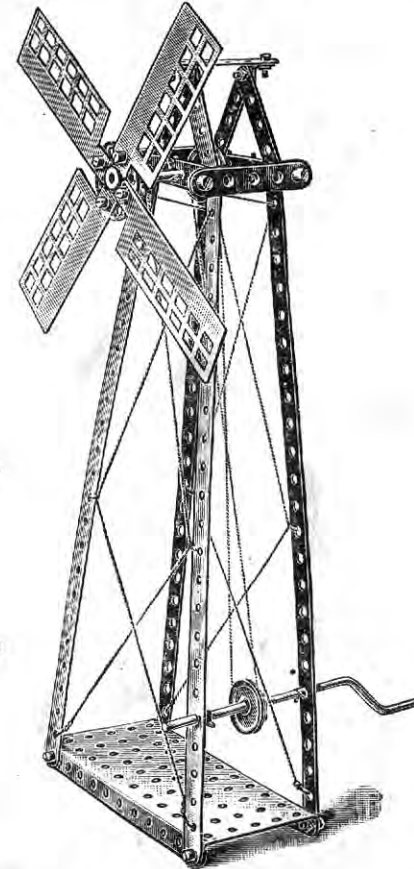

PARTS REQUIRED.

- | | |
|----|----------------------------|
| 4 | 12 1/2" Perforated Strips. |
| 7 | 2 1/2" " " |
| 2 | 2 1/2" Bent Strips. " |
| 2 | Angle Brackets. |
| 1 | 4 1/2" Rod. |
| 1 | Crank Handle. |
| 2 | 1" Pulley Wheels. |
| 1 | Bush Wheel. |
| 20 | Nuts and Bolts. |
| 4 | Clips. |
| 1 | Large Rectangular Plate. |
| 4 | Sails. |

Parts required in addition to Outfit No. 1.

4 Sails.

This Model may be driven by the No. 1 Meccano Spring Motor. (See page 97.)

Model No. 40. Windmill

(MADE WITH MECCANO OUTFIT NO. 2 OR NO. 1 AND NO. 1A.)

PARTS REQUIRED.

10	12½" Perforated Strips.	1	Crank Handle.
13	5½" " "	2	1" Pulley Wheels.
2	3½" " "	1	Bush Wheel.
2	2½" " "	45	Nuts and Bolts.
4	Angle Girders.	4	Clips.
4	Angle Brackets.	2	Sector Plates.
1	5" Rod.		



Parts required in addition to Outfit No. 1.

6	12½" Perforated Strips.
7.	5½" " "
1	3½" " "
4	Angle Girders.
1	5" Rod.
25	Nuts and Bolts.

This model requires no special instructions. We would, however, say that this model may be driven by the No. 1 Meccano Spring Motor.

This model also lends itself to further decorations by means of coloured ribbons used in the place of the cord lacings; or as streamers.

Model No. 41. Wheel

PARTS REQUIRED.

5	12½" Perforated Strips.
12	5½" " "
2	2½" " "
4	Angle Girders.
8	Angle Brackets.
2	4½" Rods.
3	Flanged Wheels.
2	1" Pulley Wheels.
44	Nuts and Bolts.

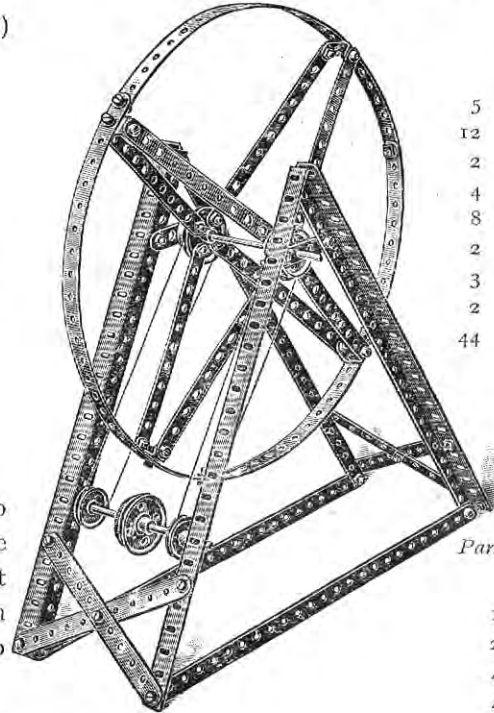

Parts required in addition to Outfit No. 1.

1	12½" Perforated Strip.
2	5½" " "
4	Angle Girders.
4	Flanged Wheels.
24	Nuts and Bolts.

The only point calling for description in this model, which is otherwise very clearly shown, is the wheel. This is made from three 12½" strips to form the outer hoop, the spokes being made from pairs of 5½" strips bolted to flanged wheels mounted on a spindle. These flanged wheels are secured in their splayed position on the spindle by set screws.

Model No. 42. Swing Bridge

(MADE WITH MECCANO NO. 2 OR NO. 1 AND NO. 1A.)

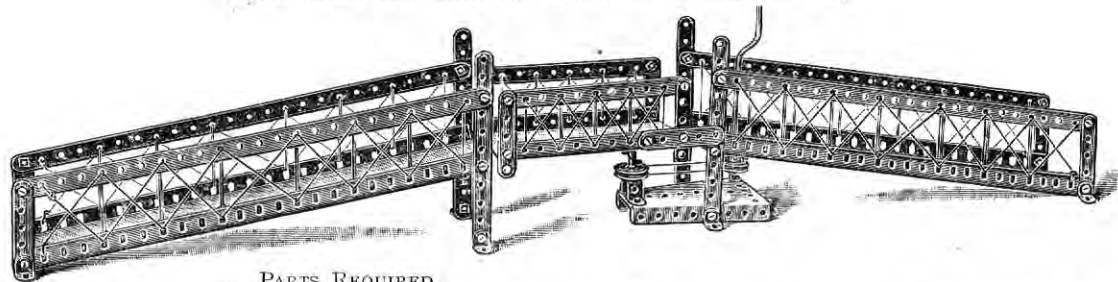

- 4 12" Perforated Strips.
- 6 5½" " "
- 9 2½" " "
- 4 2½" Bent Strips.
- 4 Angle Girders.
- 8 Angle Brackets.

PARTS REQUIRED.

- 1 2" Rod.
- 1 Crank Handle.
- 2 1" Pulley Wheels.
- 1 Bush Wheel.
- 31 Nuts and Bolts.

- 1 Clip.
- 1 Double Bent Strip.
- 1 Large Rectangular Plate
- 1 Sector Plate.

*Parts required in addition to
Outfit No. 1.*

- 4 Angle Girders.
- 11 Nuts and Bolts.
- 1 Double Bent Strip.

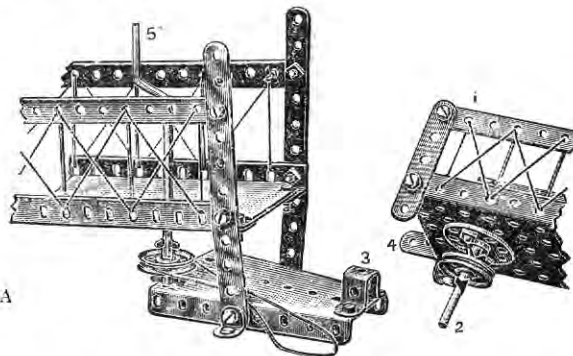

FIG. 42A

The action for swinging the middle section of the Bridge will be made clearer by the detail Fig. 42A, the middle section 1 being fitted with a spindle 2 journalled in the double bent strip 3; the upper end of the spindle being secured to a bush wheel.

A short strip 4 acts as a stop against the middle section of the Bridge swinging past the central position.

The operating cord passes round pulleys on the spindles 2 and crank handle 5.

Model No. 43. Railway Foot Bridge and Signals

(MADE WITH MECCANO OUTFIT NO. 2 OR NO. 1 AND NO. 1A.)

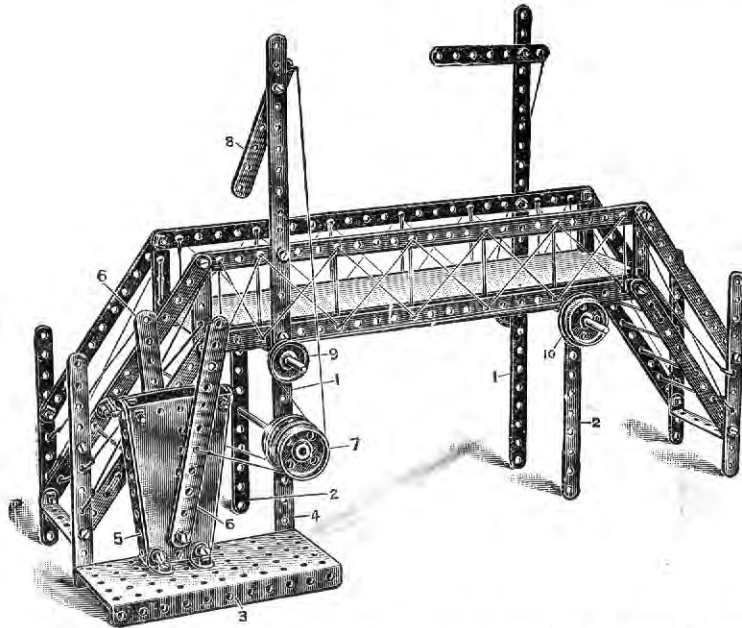

PARTS REQUIRED.

4	12 $\frac{1}{2}$ "	Perforated Strips.	4	Angle Brackets.
16	5 $\frac{1}{2}$ "	" "	4	Flanged Wheels.
2	3 $\frac{1}{2}$ "	" "	1	1" Pulley Wheel.
6	2 $\frac{1}{2}$ "	" "	46	Nuts and Bolts.
2	2 $\frac{1}{2}$ "	Beam Strips.	1	Large Rectangular Plate
3	5"	Rods.	2	Sector Plates.
2		Angle Girders.		

Parts required in addition to Outfit No. 1.

10	5 $\frac{1}{2}$ "	Perforated Strips.	4	Flanged Wheels.
1	3 $\frac{1}{2}$ "	" "	2	Angle Girders.
3	5"	Rods.	26	Nuts and Bolts.

The structure of the bridge may be readily followed from the illustration, being built up from a series of perforated strips. The vertical signal posts 1 are bolted to the side rails of the bridge and form feet for it. Opposite each signal post another foot consisting of a 5 $\frac{1}{2}$ " perforated strip 2 is disposed. A rectangular plate 3 is bolted by its flange to the vertical strips 4 of the bridge, and two sector plates 5, the flanges of which are overlapped and bolted together, form the casing for the point-operating levers 6. These point-operating levers are pivotally bolted to the lower parts of the sector plates 5, and operating cords from each point lever are led over a pair of grooved pulleys 7 carried on an axle rod passing through the feet of the bridge. One of the cords passes direct to the signal 8, the other being led over a grooved pulley 9 and secured to the rim of pulley 10, carried upon a rod passing through the feet of the bridge, this rod being furnished at its far end with another pulley to the rim of which is secured another cord operating the signal arm.

Model No. 44. Motor Van

(MADE WITH MECCANO OUTFIT NO. 2 OR NO. 1 AND NO. 1A.)

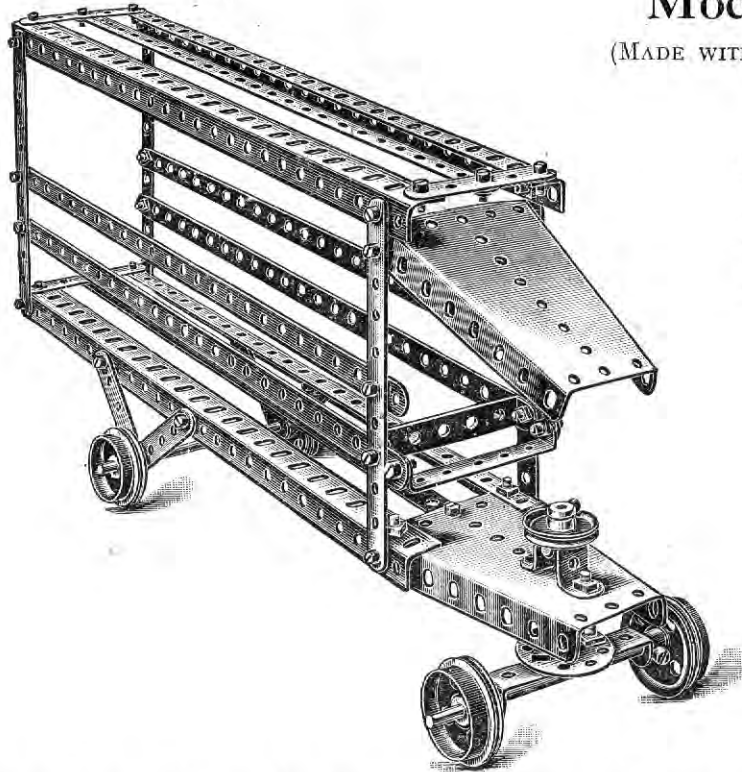

PARTS REQUIRED.

6	12½" Perforated Strips.	2	1" Pulley Wheels.
4	5½" " "	4	Angle Girders.
7	2½" " "	1	Bush Wheel.
3	2½" Bent Strips.	40	Nuts and Bolts.
2	4½" Rods.	1	Double Bent Strip.
1	2" " "	2	Sector Plates.
4	Flanged Wheels.		

Parts required in addition to Outfit No. 1.

2	12½" Perforated Strips.
4	Angle Girders.
4	Flanged Wheels.
20	Nuts and Bolts.
1	Double Bent Strip.

The only portion of this Model calling for a description is the steering gear. The steering shaft, to which is secured the steering handle, passes through a double bent strip bolted to the steering platform, consisting of a sector plate. The arrangement of the gear beneath the platform is shown in Fig. 44A. A 1" pulley wheel is secured on the spindle immediately below the platform, and a bush wheel affixed below this on the end of the spindle. A 2½" bent strip bolted to the bush wheel forms the bearings for the spindle of the running wheels. By fitting the 1" pulley below the platform, the running wheels are maintained at a requisite distance, to give clearance from the platform flanges.

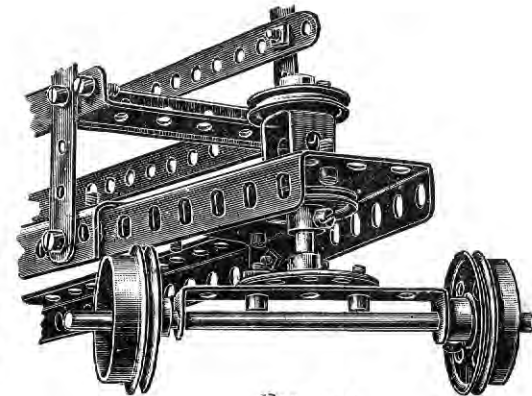
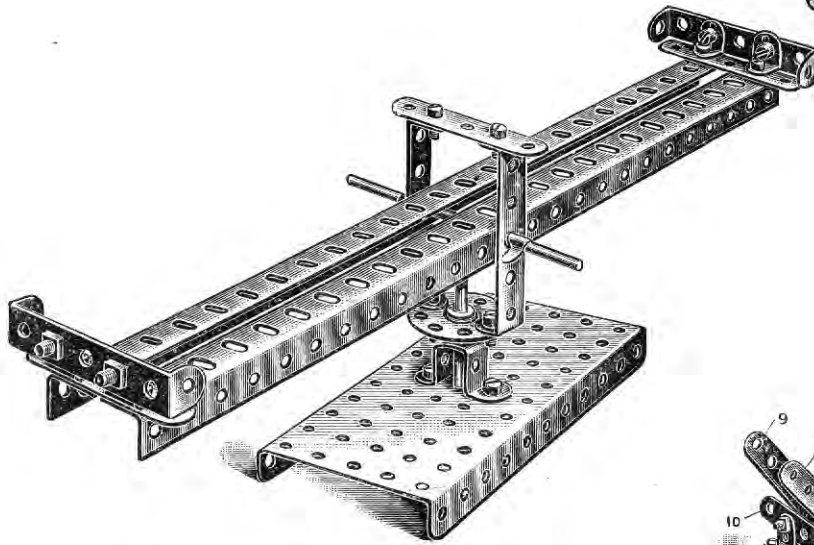

FIG. 44A

Model No. 45. Roundabout Seesaw

(MADE WITH MECCANO OUTFIT NO. 2 OR NO. 1 AND NO. 1A.)



PARTS REQUIRED.

- | | | | |
|---|------------------------|----|-------------------------|
| 2 | Angle Girders. | 1 | Bush Wheel. |
| 3 | 2½" Perforated Strips. | 14 | Nuts and Bolts. |
| 4 | 2½" Bent Strips. | 2 | Clips. |
| 4 | Angle Brackets. | 1 | Double Bent Strip. |
| 1 | 4½" Rod. | 1 | Large Rectangular Plate |

Parts required in addition to Outfit No. 1.

- 1 Double Bent Strip.

Model No. 46. Three-Arm Signal

(MADE WITH MECCANO OUTFIT NO. 2 OR NO. 1 AND NO. 1A.)

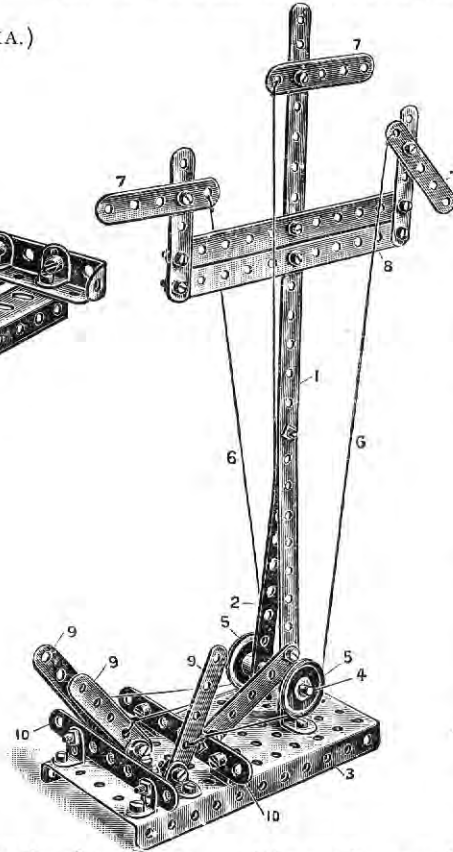

PARTS REQUIRED.

- | | |
|----|-------------------------|
| 1 | 12½" Perforated Strips. |
| 3 | 5½" " " |
| 2 | 3½" " " |
| 9 | 2½" " " |
| 10 | Angle Brackets. |
| 1 | 2" Rod. |
| 2 | 1" Pulley Wheels. |
| 34 | Nuts and Bolts. |
| 1 | Large Rectangular Plate |

Parts required in addition to Outfit No. 1.

- | | |
|----|-----------------------|
| 1 | 3½" Perforated Strip. |
| 14 | Nuts and Bolts. |

A rectangular perforated plate forms the base of this model, a 12½" strip 1 being bolted to a 5½" strip 2, the feet of both these strips being connected to the rectangular plate 3 by angle brackets. A rod 4 is passed through the lower holes of the strips 1 and 2 and is fitted with guide pulleys 5 leading the actuating cords 6

to the signal arms 7. The cord operating the central arm is run under the rod 4. The signal arms 7 are carried from transverse strips 8. The operating cords 6 are led to three strips 9, pivoted to angle brackets bolted to the rectangular plate, and transverse strips 10 are bolted to the perforated plate in the front and rear of the pivoted strips 9, to limit their movement.

Model No. 47. Extensible Ladder on Running Carriage

(MADE WITH MECCANO OUTFIT NO. 2 OR NO. 1 AND NO. 1A.)

The bed of the lower carriage framework 1 is formed by bolting two $12\frac{1}{2}$ " strips to the sides of a large rectangular plate 2, and two sector plates 3 bolted to the rectangular plate by their flanges to form the sides, and a bearing for the spindle 4 carrying the operating cord 5 to raise the ladder from a horizontal position. The strips 6 form a support for the ladder when in this horizontal position. Angle brackets 7, Fig. 47A, form pivots for the lower part 8 of the ladder, and are carried from the supports 9. The upper part of the ladder 10, Fig. 47B, is slidably guided and retained on the lower ladder 8 by angle brackets 11. The extension of the ladder is effected by the cranked spindle 12, round a pulley 13, on which and another 14, carried as shown in Fig. 47A, the cord 15 is passed, the ends of which are secured to the lower part of the movable ladder 10.

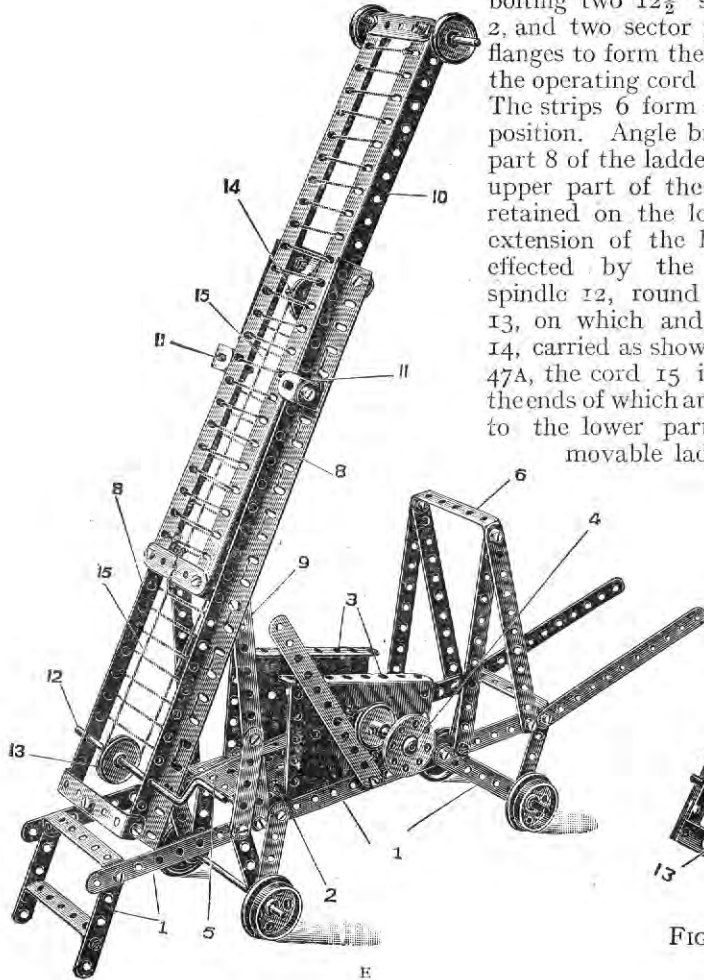

FIG. 47A

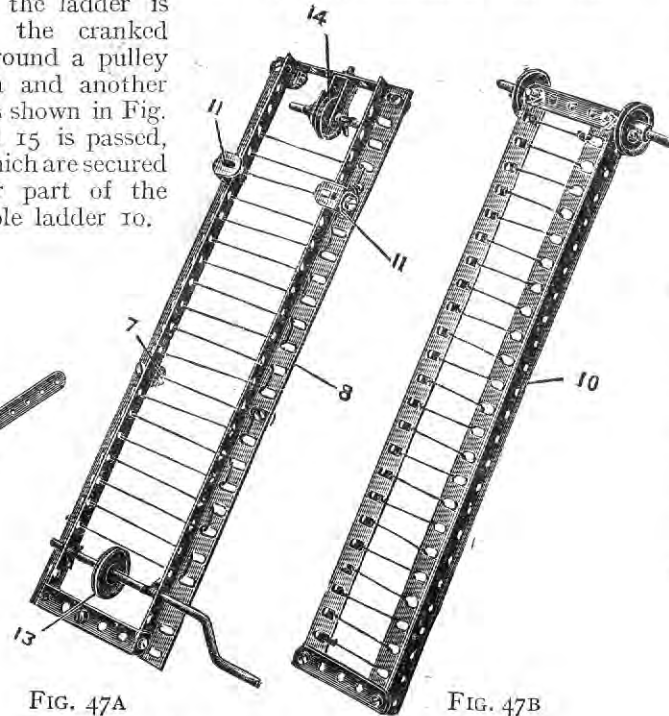

FIG. 47B

PARTS REQUIRED.

2	$12\frac{1}{2}$ "	Perforated Strips.
9	$5\frac{1}{2}$ "	" "
2	$3\frac{1}{2}$ "	" "
12	$2\frac{1}{2}$ "	" "
6	$2\frac{1}{2}$ "	Bent Strips.
8		Angle Brackets.
4	$12\frac{1}{2}$ "	Angle Girders.
1	5"	Rod.
3	$4\frac{1}{2}$ "	" "
1		Crank Handle.
4		Flanged Wheels.
5	1"	Pulley Wheels.
1		Bush Wheel.
6		Clips.
49		Nuts and Bolts.
1		Single Bent Strip.
1		Large Rectangular Plate.
2		Sector Plates.

Parts required in addition to Outfit No. 1.

3	$5\frac{1}{2}$ "	Perforated Strips.
1	$3\frac{1}{2}$ "	Strip.
3	$2\frac{1}{2}$ "	Strips.
2	$2\frac{1}{2}$ "	Bent Strips.
4	$12\frac{1}{2}$ "	Angle Girders.
1	5"	Rod.
4		Flanged Wheels.
29		Nuts and Bolts.

Model No. 48. Monoplane

(MADE WITH MECCANO OUTFIT NO. 2 OR NO. 1 AND NO. 1A.)

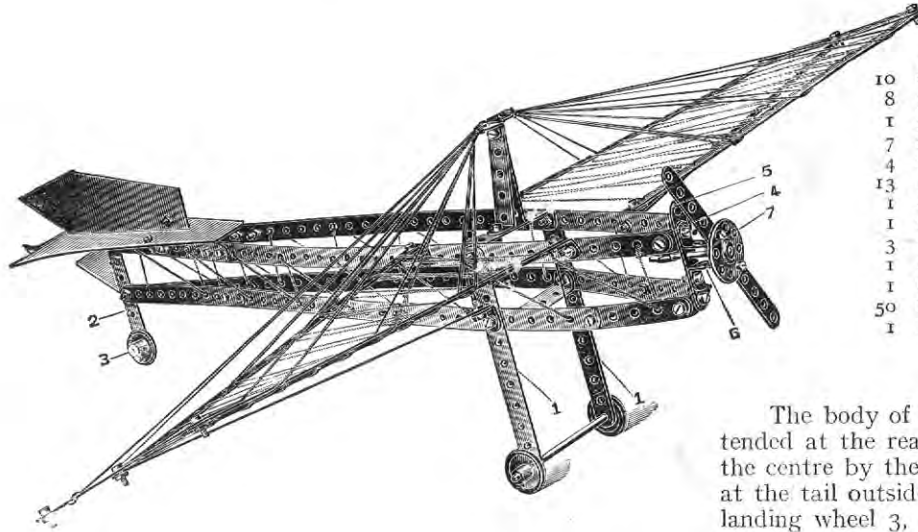

PARTS REQUIRED.

10	12 $\frac{1}{2}$ " Perforated Strips.	<i>Parts required in addition to</i>	
8	5 $\frac{1}{2}$ " " "	<i>Outfit No. 1.</i>	
1	3 $\frac{1}{2}$ " " "		
7	2 $\frac{1}{2}$ " " "	6	12 $\frac{1}{2}$ " Perforated Strips.
4	2 $\frac{1}{2}$ " Bent Strips.	2	5 $\frac{1}{2}$ " " "
13	Angle Brackets.	1	Angle Bracket.
1	4 $\frac{1}{2}$ " Rod.	30	Nuts and Bolts.
1	2" "	1	Double Bent Strip.
3	1" Pulley Wheels.		
1	Bush Wheel.		
1	Clip.		
50	Nuts and Bolts.		
1	Double Bent Strip.		

The body of the Monoplane is made from 12 $\frac{1}{2}$ " strips, extended at the rear by 5 $\frac{1}{2}$ " strips overlapped, and distended at the centre by the vertical framework 1, and bolted together at the tail outside the vertical 3 $\frac{1}{2}$ " strip 2, which carries the landing wheel 3, pivoted as shown in the standard detail No. R on page 96. The body strips are extended by 2 $\frac{1}{2}$ " strips bolted by angle brackets 4 to a vertical 2 $\frac{1}{2}$ " strip 5 carrying a double bent strip 6, which form a bearing for the propeller spindle 7. The other details will be clearly followed from the drawing.

HOW TO CONTINUE

This completes the models which may be made with MECCANO Outfit No. 2. The next models are a little more advanced, requiring a number of extra parts to construct them. The necessary parts are all contained in a No. 2A Accessory Outfit, the cost of which will be found in the Price List at the end of the Manual.

Model No. 55. Swing Bridge

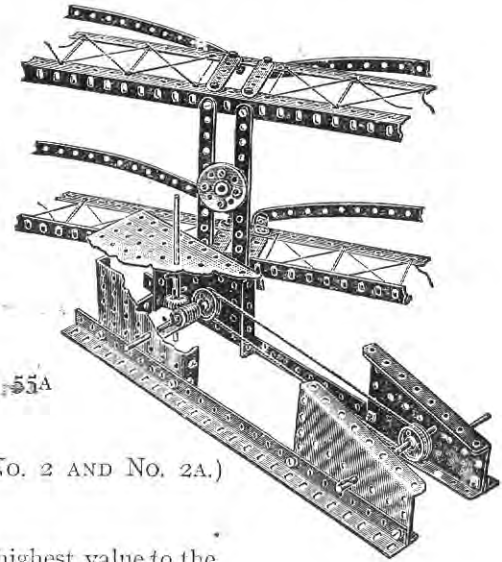
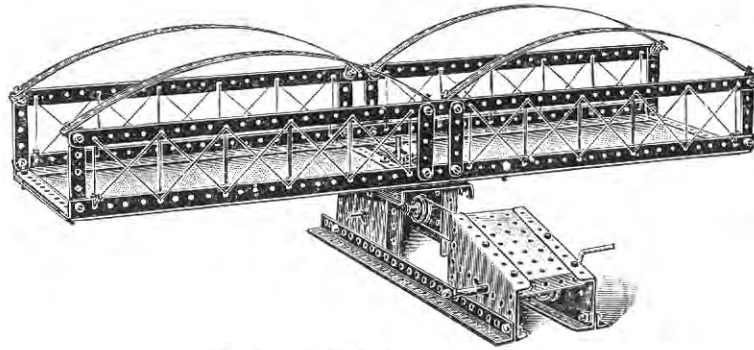

FIG. 55A

Parts required in addition to Outfits

(MADE WITH MECCANO OUTFIT NO. 3 OR NO. 2 AND NO. 2A.)

PARTS REQUIRED.		No. 1	No. 2
8	12½" Perforated Strips	4	—
4	5½" " "	—	—
8	2½" " "	—	—
1	2½" Bent Strip	—	—
6	Angle Girders	6	2
10	Angle Brackets	—	—
2	4½" Rods	—	—
1	Crank Handle	—	—
2	1" Pulleys	—	—
1	Bush Wheel	—	—
1	½" Pinion	1	1
1	Worm Wheel	1	1
60	Nuts and Bolts	40	10
3	Clips	—	—
2	Collars and Set Screws	2	2
1	Large Rectangular Plate	—	—
3	Small " "	3	3
2	Sector Plates	—	—

This is a fine engineering model of the highest value to the young student, and any thought and care expended on its construction will be well repaid.

The base portion containing the perpendicular axle actuated by the worm and pinion should be constructed first. This, as will be seen by the illustration, Fig. 55A, is formed by connecting a small rectangular plate to an angle girder three holes from one end and a sector plate at the other end to form one side of the base. The other side is constructed in a similar manner. These two sides are then connected together at one end by a large rectangular plate containing the spindle, upon which the bridge swings, and at the other by a small rectangular plate. A 2½" bent strip is connected to the angle girders to carry the lower portion of the perpendicular axle upon which the bridge swings. A ½" pinion is secured to this axle, which is operated by the horizontal spindle upon which is secured a worm wheel. A pulley wheel is also secured to this spindle around which a driving rope passes from the pulley at the other end of the base secured to a crank handle, as shown in the illustration.

The platform is constructed by connecting two angle girders in the third holes. Two 2½" strips are attached to these in the centre and one at each end, with two 12½" strips along the top. Two 12½" strips are curved and connected by four angle brackets to form one side of the bridge. The other side is formed in a similar manner, and both are connected together by 5½" strips at the end and in the centre. Attached to the two 5½" strips in the centre is a bush wheel upon which the platform rotates.

Model No. 56. Tower Wagon

(MADE WITH MECCANO OUTFIT NO. 3 OR NO. 2 AND NO. 2A.)

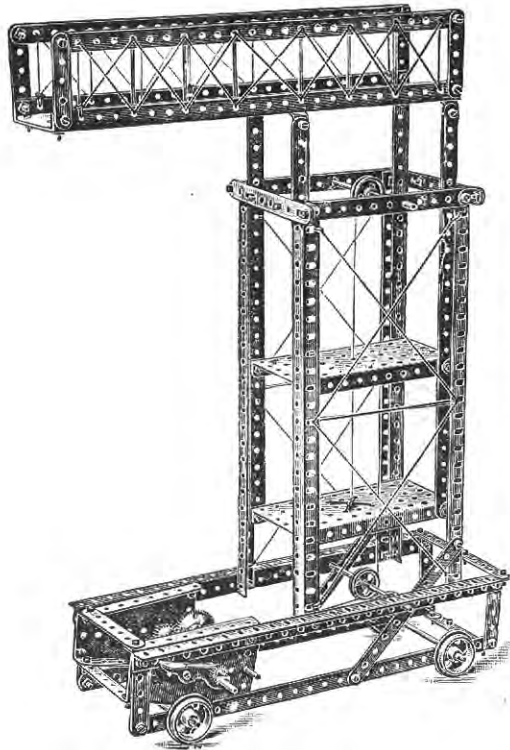

PARTS REQUIRED.		No. No.	
		1	2
8	12 1/2" Perforated Strips	4	—
4	5 1/2" " "	—	—
6	3 1/2" " "	5	4
2	3" " "	2	2
11	2 1/2" " "	2	—
2	2 1/2" Bent Strips	—	—
8	Angle Girders	8	4
14	Angle Brackets	2	—
2	5" Rods	2	—
3	4 1/2" " "	—	—
1	Crank Handle	—	—
4	Flanged Wheels	4	—
2	1" Pulleys	—	—
1	3/4" Pinion	1	1
1	1/2" " "	1	1
1	Gear Wheel	1	1
1	Pawl	1	—
69	Nuts and Bolts	49	19
6	Clips	—	—
2	Large Rectangular Plates	1	1
2	Sector Plates	—	—

This is a representation of a wagon used for repairing overhead electrical wires carrying the current for street cars. Each part is shown clearly in our illustration, and little difficulty will be experienced in its construction.

Model No. 57. Pile Driver

(MADE WITH MECCANO OUTFIT NO. 3 OR NO. 2 AND NO. 2A.)

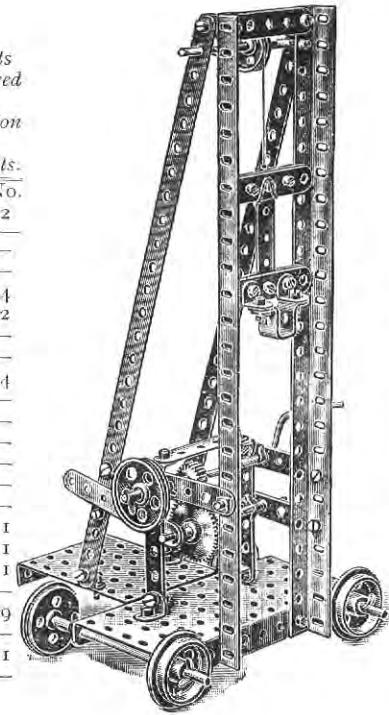

PARTS REQUIRED.		No. No.	
		1	2
2	12 1/2" Perforated Strips	—	—
1	3 1/2" " "	—	—
2	3" " "	2	2
8	2 1/2" " "	—	—
2	2 1/2" Bent Strips	—	—
2	Angle Girders	2	—
4	Angle Brackets	—	—
2	5" Rods	2	—
2	4 1/2" " "	—	—
1	Crank Handle	—	—
4	Flanged Wheels	4	—
1	1 1/2" Pulley Wheel	1	1
1	1" " "	—	—
1	3/4" Pinion	1	1
1	Gear Wheel	1	1
40	Nuts and Bolts	20	—
4	Clips	—	—
1	Double Bent Strip	1	1
1	Large Rectangular Plate	—	—
1	Small Rectangular Plate	1	1

This illustration shows a model pile driver in which the pile head is guided on the two vertical angle girders. The raising of the pile head is controlled from the main driving shaft through the pinion and gear wheel. This latter is mounted on the end of the pivoted lever, and in order to drop the pile head the lever is raised to free the gear wheel. A grooved pulley is fitted on the pinion shaft to enable the model to be driven from an engine.

Model No. 58. Cake Walk

(MADE WITH MECCANO OUTFIT NO. 3 OR NO. 2 AND NO. 2A.)

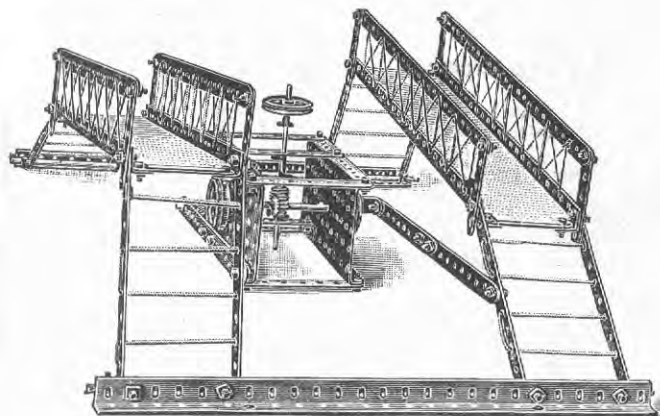

Parts required in addition to Outfits.

PARTS REQUIRED.	No. of	
	No. 1	No. 2
4 12 $\frac{1}{2}$ " Perforated Strips	—	—
12 5 $\frac{1}{2}$ " " "	6	—
12 2 $\frac{1}{2}$ " " "	3	—
4 2 $\frac{1}{2}$ " Bent Strips "	—	—
6 12 $\frac{1}{2}$ " Angle Girders	6	2
12 Angle Brackets	—	—
4 5" Rods	4	1
2 4 $\frac{1}{2}$ " " "	—	—
2 Flanged Wheels	2	—
1 1 $\frac{1}{2}$ " Pulley Wheel	1	1
1 $\frac{1}{2}$ " Pinion	1	1
1 Worm Wheel	1	1
60 Nuts and Bolts	40	10
8 Clips	2	2
3 Collars and Set Screws	2	2
2 Large Rectangular Plates	1	1

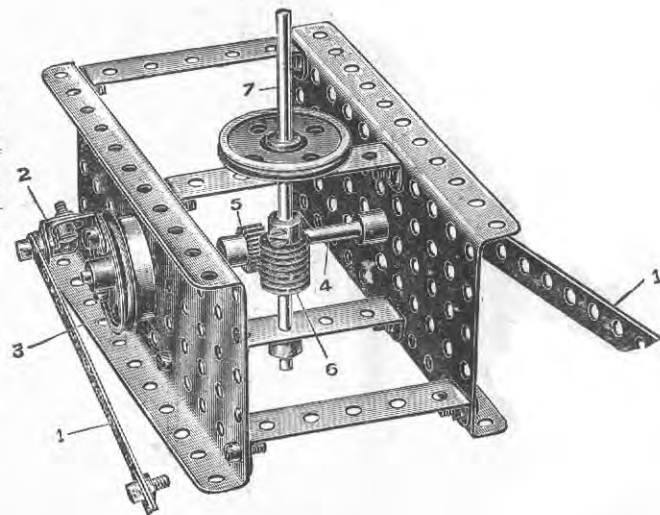

FIG. 58A

This model comprises two side platforms carried upon strips pivoted to the platforms, and to the angle girders forming the base. The strips, when connected to the platforms, are lock-nutted to allow for free movement, and at their lower ends are pivoted on a rod secured to the base girders.

The platforms are rocked by coupling strips 1, Fig. 58A, the outer ends of which are lock-nutted, and the inner ends also lock-nutted, connected by angle brackets 2 to flanged wheels 3, forming cranks. These cranked wheels 3 are mounted upon a common spindle 4, carrying a pinion 5 operated by a worm 6 on the vertical spindle 7, as shown in Fig. 58A.

Model No. 59. Pit Headgear

(MADE WITH MECCANO OUTFIT NO. 3 OR NO. 2 AND NO. 2A.)

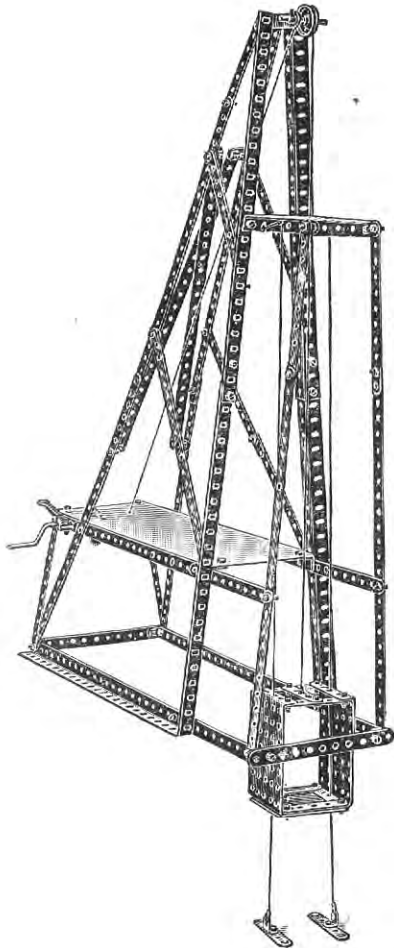

Parts required in addition to Outfits.

PARTS REQUIRED.	No. 1 No. 2	
	8 12½" Perforated Strips	4
18 5½" " " "	12	2
2 3½" " " "	1	—
9 2½" " " "	—	—
1 2½" Bent Strip	—	—
8 Angle Girders	8	4
12 Angle Brackets	—	—
1 4½" Rod	—	—
1 2" Rod	—	—
1 Crank Handle	—	—

Parts required in addition to Outfits.

PARTS REQUIRED.	No. 1 No. 2	
	1 1" Pulley	—
1 ¾" Pinion	1	1
1 ½" " "	1	1
1 Gear Wheel	1	1
1 Pawl	1	1
70 Nuts and Bolts	50	20
3 Clips	—	—
3 Small Rectangular Plates	3	3

This is a most interesting model, showing the principle upon which minerals are raised from below the ground.

The front main uprights are formed by two angle girders overlapped in the third hole. These two uprights are fastened together at the top by two angle brackets. Two 2½" strips are bolted horizontally at the top to carry the wheel over which the winding rope runs, and to connect the diagonal stays. To stiffen the structure one 5½" strip is fixed on each side connected in the eighteenth hole down on the upright, and the eleventh hole down on the stays. Two more 5½" strips are bolted together, and fastened on each side lower down.

The framework in which the cage moves is formed by connecting a 5½" strip with a 12½" strip in the second hole to form the uprights. These are connected by 5½" strips to the main uprights. The framework takes the same angle as the main uprights, and is connected at the top by a small rectangular plate and a 2½" bent strip, and at the bottom by a 5½" strip.

The cage is formed by connecting two small rectangular plates by two 2½" strips at the top and bottom. Another 2½" strip is bolted in the centre at the top, to which is attached the hoisting rope.

The guide ropes are connected to the small rectangular plate at the top of the framework, passed through the holes at each side of the cage, and connected with two 2½" strips screwed to the floor.

The hoisting mechanism is operated by the crank handle, upon which is secured a ¾" pinion engaging a gear wheel connected with the spindle over which the hoisting rope is wound.

Model No. 60. Level Crossing Gate

(MADE WITH MECCANO OUTFIT NO. 3 OR NO. 2 AND NO. 2A.)

Parts required in addition to Outfits.

PARTS REQUIRED.	No. of	
	No. 1	No. 2
9 $5\frac{1}{2}$ " Perforated Strips	3	—
4 $3\frac{1}{2}$ " " "	3	2
2 3 " " "	2	2
6 $2\frac{1}{2}$ " " "	—	—
4 $2\frac{1}{2}$ " Bent Strips	—	—
6 Angle Girders	6	2
16 Angle Brackets	4	2
4 5 " Rods	4	1
4 1 " Pulley Wheels	—	—
54 Nuts and Bolts	31	4
2 Large Rectangular Plates	1	1

This model, if constructed with care, is a most admirable one, as the gates are opened simultaneously by the operation of one lever.

To construct it, commence by taking two angle girders and connecting them together in the second hole from each end with a $3\frac{1}{2}$ " strip placed perpendicularly between them to form the supports of one pair of gates as shown in Figure 60.

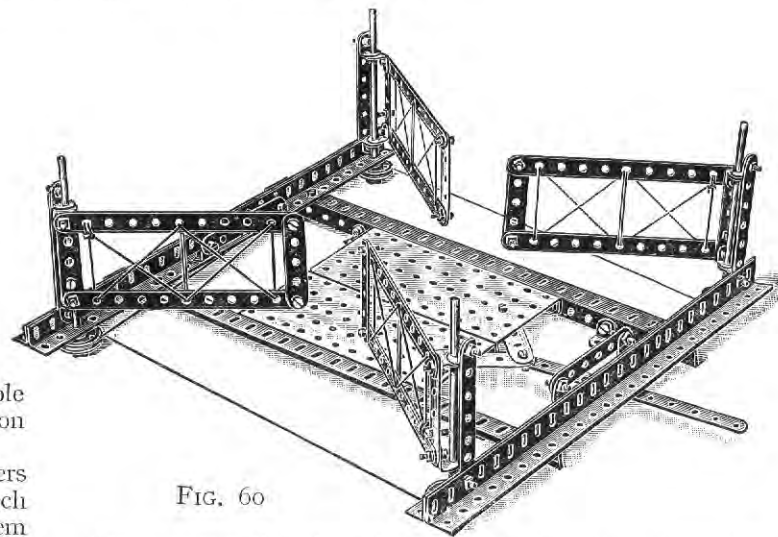

FIG. 60

The supports for the other pair of gates are arranged in a similar manner. These two structures are connected by two other angle girders and two rectangular plates, as shown in the illustration.

The gates are formed by connecting two $5\frac{1}{2}$ " strips with a $2\frac{1}{2}$ " strip at the outer end of the gate and a $2\frac{1}{2}$ " bent strip at the inner end, to permit the axle rods to pass through upon which the gates swing.

Figure 60A is an inverted view showing the arrangement of operating cord 1 which is passed from the operating lever 2, around the corner pulleys 3, and back to the lever 2. In order to obtain a better grip on the pulleys, it is desirable to wind the operating cord twice around them. It is to be noted that the cord 1 is wound in opposite directions around the diagonal pairs of pulleys 3.

Pinching screws 4 are fitted in the inner sides of the gates to grip them to the spindles 5 so that all rotate together.

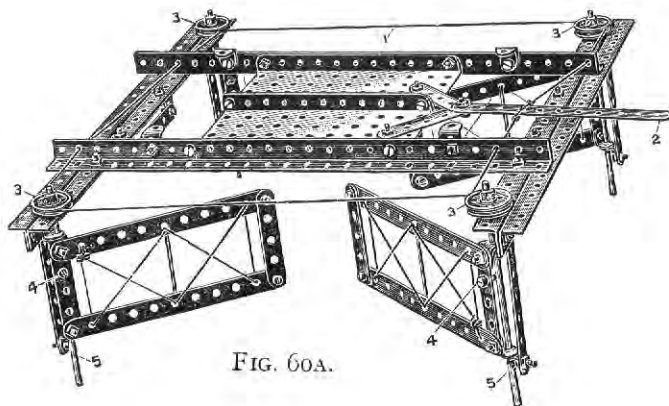
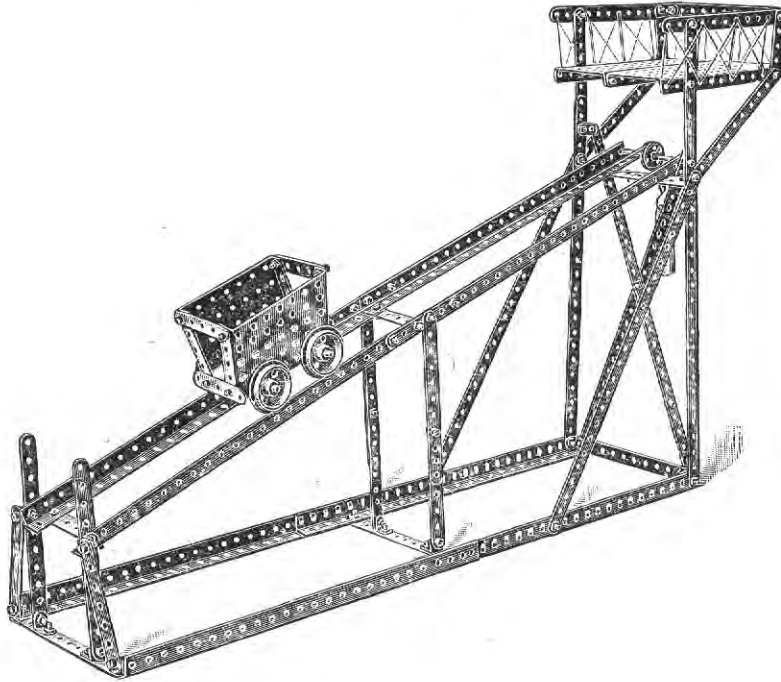

FIG. 60A.

Model No. 61. Inclined Delivery Shoot

(MADE WITH MECCANO OUTFIT NO. 3 OR WITH NO. 2 AND NO. 2A.)



Parts required in addition to Outfits.

PARTS REQUIRED.		No. 1	No. 2
6	12½" Perforated Strips	2	—
16	5½" " "	10	—
4	3½" " "	3	2
2	3" " "	2	2
8	2½" " "	—	—
8	Angle Girders	8	4
16	Angle Brackets	4	2
3	4½" Rods	—	—
4	Flanged Wheels	4	—
1	1" Pulley Wheel	—	—
70	Nuts and Bolts	50	20
1	Hook	—	—
2	Clips	—	—
2	Large Rectangular Plates	1	1
2	Small " "	2	2

This model furnishes an illustration of the inclined plane. The loading platform at the extreme right delivers a load into the truck, which being now heavier than the balance weight, runs down the incline, and when at the bottom discharges its load by tipping. The weight immediately overcoming the empty truck returns it quickly to the loading platform.

Model No. 62. Fire Escape

(MADE WITH MECCANO OUTFIT NO. 3 OR NO. 2 AND NO. 2A.)

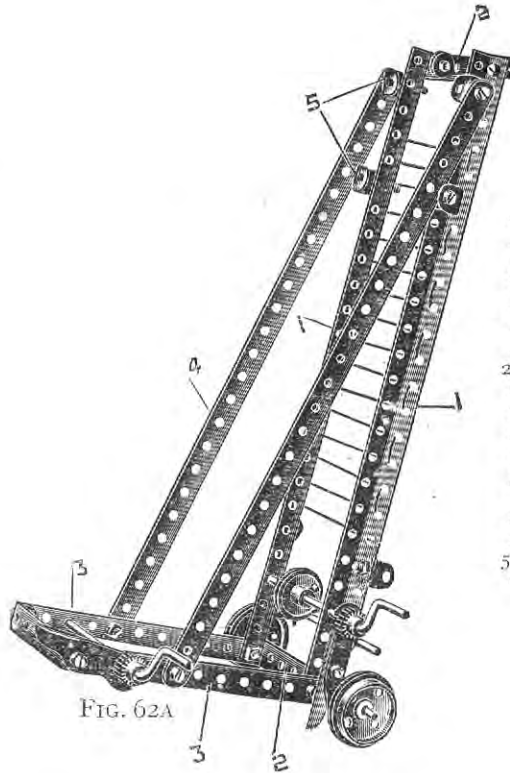

FIG. 62A

Parts required in addition to Outfits.

PARTS REQUIRED.	No. 1	No. 2
2 12½" Perforated Strips	—	—
4 5½" " "	—	—
3 3½" " "	2	1
2 3" " "	2	2
4 2½" " "	—	—
1 2½" Bent Strip	—	—
4 Angle Girders	4	—
22 Angle Brackets	10	8
2 5" Rods	2	—
3 4½" " "	—	—
2 Crank Handles	1	1
4 Flanged Wheels	4	—
3 1" Pulley Wheels	—	1
1 1½" " "	1	1
2 1½" Pinions	2	2
2 Pawls	2	2
50 Nuts and Screws	30	—
8 Clips	2	2

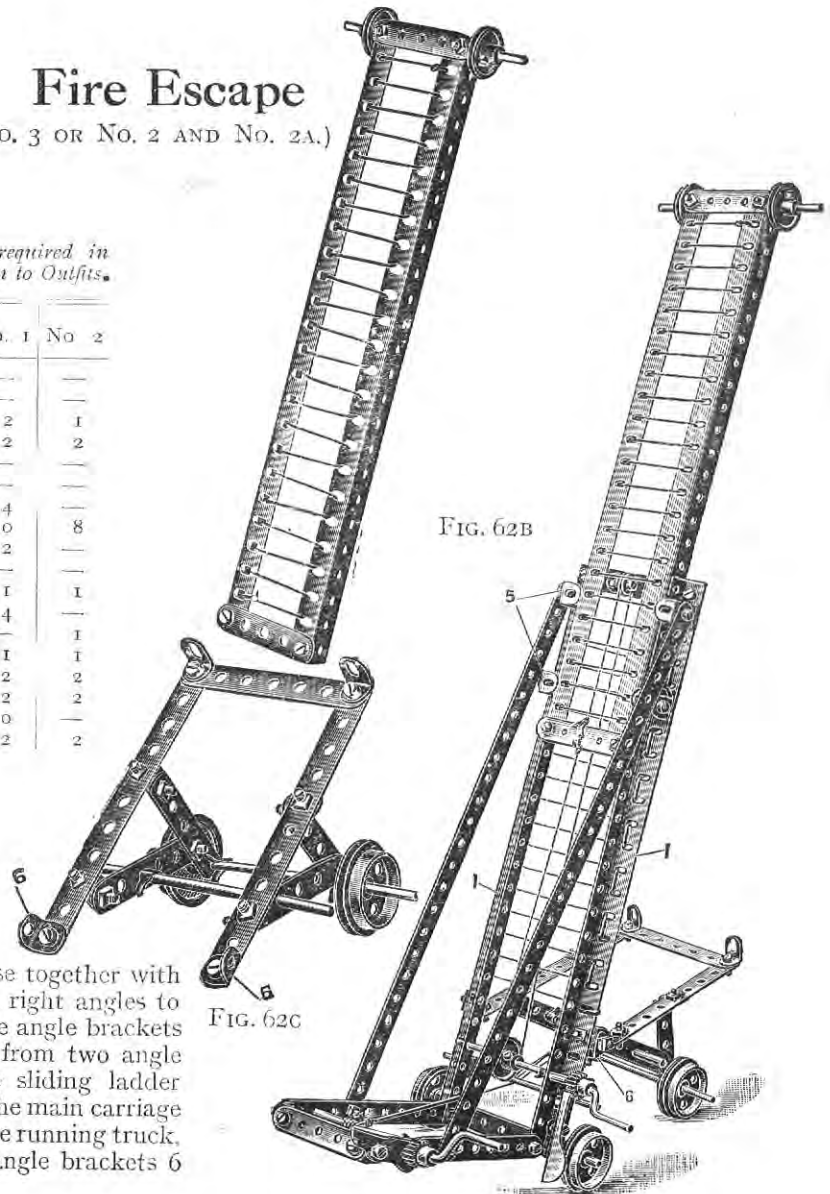

FIG. 62B

FIG. 62C

In constructing this model, take two angle girders 1 and tie these together with 3½" strips 2 at top and bottom. 5½" strips 3 are then attached at right angles to one end of the frame, diagonal stays 4 tying these short strips to the angle brackets attached to the frame. The sliding ladder, Fig. 62B, is constructed from two angle girders reversed to those of the main frame, the angle girders of the sliding ladder being tied together by two 2½" strips, and being retained and guided in the main carriage by the short angle brackets 5 which act as clips. The framework of the running truck, Fig. 62C, is very simply constructed, and is pivotally attached by angle brackets 6 to the main frame.

Model No. 63.

(MADE WITH MECCANO OUTFIT

Rotating Crane

No. 3 OR NO. 2 AND NO. 2A.)

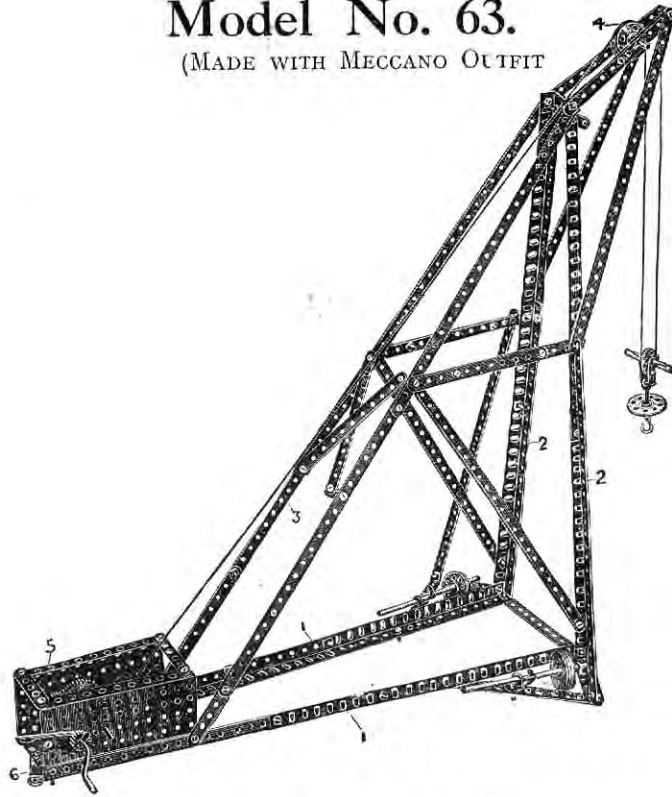

Parts required in addition to Outfits.

PARTS REQUIRED.		No. 1	No. 2
10	12 $\frac{1}{2}$ " Perforated Strips	6	—
13	5 $\frac{1}{2}$ " " "	7	—
3	3 $\frac{1}{2}$ " " "	2	1
1	3" " "	1	1
5	2 $\frac{1}{2}$ " " "	—	—
8	12 $\frac{1}{2}$ " Angle Girders	8	4
14	Angle Brackets	2	—
2	5" Rods	2	—
1	4 $\frac{1}{2}$ " Rod	—	—
2	2" Rods	—	—
1	Crank Handle	—	—
2	Flanged Wheels	2	—
1	1 $\frac{1}{8}$ " Pulley Wheel	1	1
1	1" " "	—	—
1	Bush "Wheel "	—	—
1	$\frac{3}{4}$ " Pinion Wheel	1	1
1	1" " "	1	1
1	Gear "Wheel "	1	1
1	Pawl	1	1
4	Clips	—	—
4	Collars and Set Screws	4	4
62	Nuts and Bolts	42	12
1	Hook	—	—
1	Single Bent Strip	—	—
1	Double " "	1	—
2	Large Rectangular Plates	1	1

The lower horizontal ribs 1 and main vertical members 2 are made of angle girders overlapping nine holes; and the diagonal ties 3 of two 12 $\frac{1}{2}$ " strips and one 5 $\frac{1}{2}$ " strip, the 12 $\frac{1}{2}$ " strips being overlapped three holes, and the lower 5 $\frac{1}{2}$ " strip seven holes.

The pulley 4 is carried in a nosing made of two 5 $\frac{1}{2}$ " strips and two 12 $\frac{1}{2}$ " strips connected at their apex by angle brackets. The rear swivel point of the crane is made by bolting the gear box 5 to a double bent strip 6 secured to the floor. The crane runs on the flanged wheels 7, the spindles of which are secured in their position by collars and set screws.

HOW TO CONTINUE

This completes the models which may be made with MECCANO Outfit No. 3. The next models are a little more advanced, requiring a number of extra parts to construct them. The necessary parts are all contained in a No. 3A Accessory Outfit, the cost of which will be found in the Price List at the end of the Manual.

Model No. 70. Flying Machine

(MADE WITH MECCANO OUTFIT NO. 4 OR NO. 3 AND NO. 3A.)

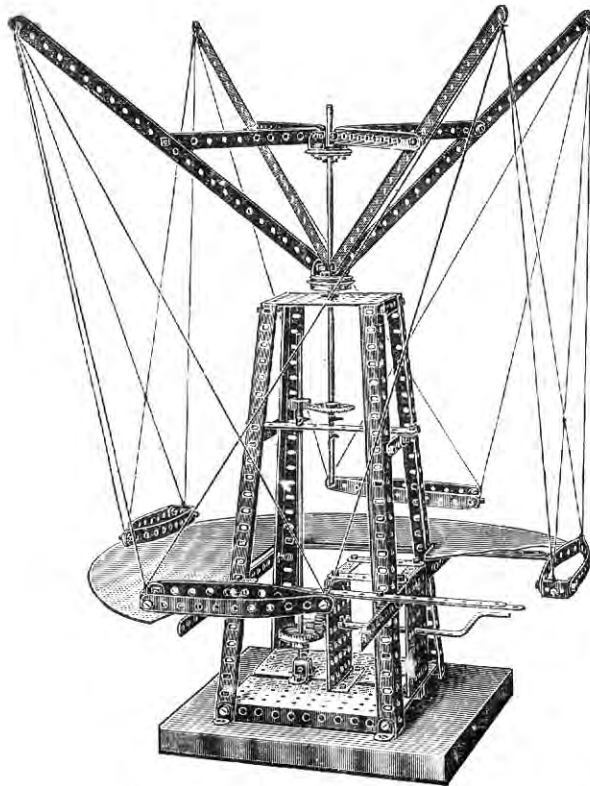

Parts required in addition to Outfits.

PARTS REQUIRED.		No. 1	No. 2	No. 3
8	12 $\frac{1}{2}$ " Perforated Strips	4	—	—
13	5 $\frac{1}{2}$ " " "	7	—	—
2	3 $\frac{1}{2}$ " " "	1	—	—
2	2 $\frac{1}{2}$ " " "	—	—	—
4	Angle Girders	4	—	—
26	Angle Brackets	14	12	2
2	11 $\frac{1}{2}$ " Rods	2	2	2
1	Crank Handle	—	—	—
2	Bush Wheels	1	1	1
2	$\frac{3}{4}$ " Pinions	2	2	1
1	Gear Wheel	1	1	—
1	1 $\frac{1}{2}$ " Contrate Wheel	1	1	1
78	Nuts and Bolts	58	28	8
4	Collar and Set Screws	4	4	—
1	Double Bent Strip	1	—	—
2	Large Rectangular Plates	1	1	—
3	Small " "	3	3	—

Most boys will have seen the Maxim Flying Machine at work, and will hardly fail to be interested in constructing a working model of it.

The main frame is composed of four angle girders connected at the bottom by two large rectangular plates separated one hole apart and connected together by two small rectangular plates carrying the crank handle, and at the top by a small rectangular plate. Across the centre on opposite sides in the ninth hole down is attached a 3 $\frac{1}{2}$ " strip connected together by a 5 $\frac{1}{2}$ " strip. These transverse 3 $\frac{1}{2}$ " and 5 $\frac{1}{2}$ " strips and the small rectangular plate at the top carry the perpendicular spindle upon which the upper structure revolves. A bush wheel is secured to this spindle to support the four arms, which are attached by four angle brackets. A pulley wheel is placed between this bush wheel and the perforated plate. The arms are supported by means of 5 $\frac{1}{2}$ " strips connected to a bush wheel secured on to the spindle, and the boats are connected to these by cord arranged as shown in the illustration. The platform is supported by four 12 $\frac{1}{2}$ " strips attached to the sides of the main framework. The manner of constructing the mechanism for operating the model is clearly shown in the illustration.

Model No. 71. Travelling Crane

(MADE WITH MECCANO OUTFIT NO. 4 OR NO. 3 AND NO. 3A.)

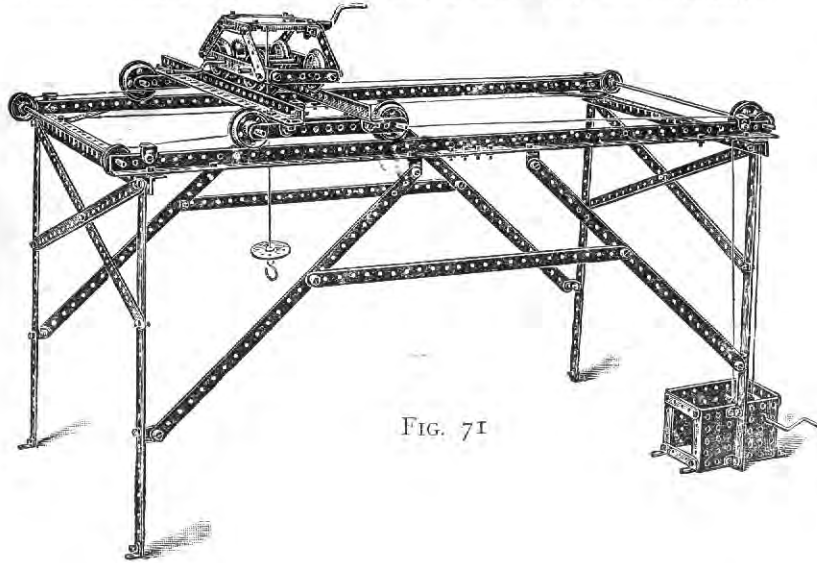

FIG. 71

Separate views are given of two distinct parts composing the travelling crane. Fig. 71 is a complete view of the structure showing the braced gantry carrying a rail at each side. The rails are formed by angle girders butt-jointed. Fig. 71A shows the construction of the travelling gantry with two pairs of wheels so arranged as to fit the gauge of the rails. The gantry is caused to travel to and fro on the rails by a cord which is connected to the gantry by a nut and bolt 1 and passes over a pulley at each end of the rail, secured to the rod. On one of these rods is secured a $1\frac{1}{2}$ " pulley carrying the driving cord, which passes over a pulley wheel secured to the crank handle. The winch Fig. 71B again is arranged to run on the gantry rails of 71A, and is provided with a cranked hoisting axle 2 and another axle 3 for traversing the winch.

PARTS REQUIRED.		No. 1	No. 2	No. 3
14	$12\frac{1}{2}$ " Perforated Strips	10	4	4
6	$5\frac{1}{2}$ " " "	—	—	—
4	$3\frac{1}{2}$ " " "	4	4	2
10	$2\frac{1}{2}$ " " "	—	—	—
4	$2\frac{1}{2}$ " Dent Strips	—	—	—
8	Angle Girders	8	4	—
26	Angle Brackets	4	12	2
2	$1\frac{1}{2}$ " Rods	2	—	2
2	$4\frac{1}{2}$ " " "	—	—	—
4	$2\frac{1}{2}$ " " "	2	2	2
3	Crank Handles	2	2	1
8	Flanged Wheels	8	4	4
1	$1\frac{1}{2}$ " Pulley Wheel	1	1	—
5	$1\frac{1}{2}$ " Pulleys	—	—	—
1	Bush Wheel	—	—	—
1	$\frac{3}{4}$ " Pinion	1	1	—
1	$\frac{1}{2}$ " " "	1	1	—
1	Gear Wheel	1	1	—
1	Pawl	1	1	—
98	Nuts and Bolts	78	48	28
1	Hook	—	—	—
4	Clips	—	—	—
4	Collars and Set Screws	4	4	—
2	Small Rectangular Plates	2	2	—

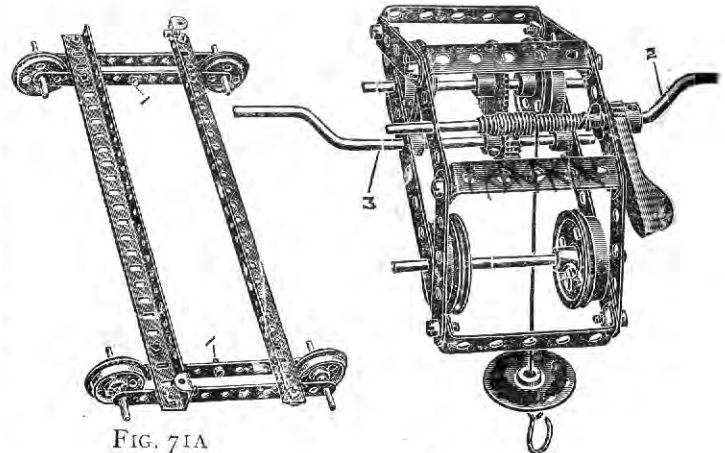
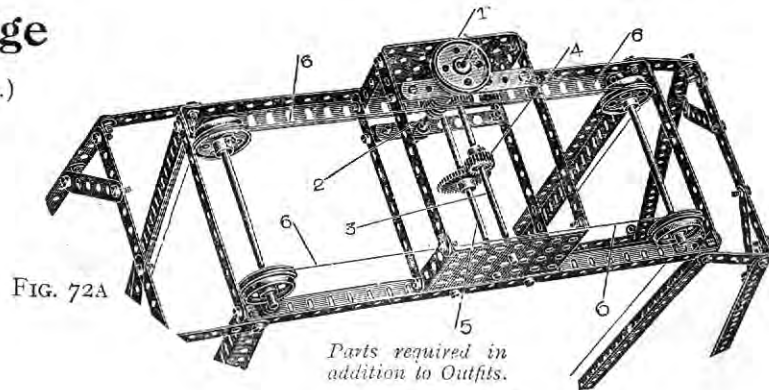
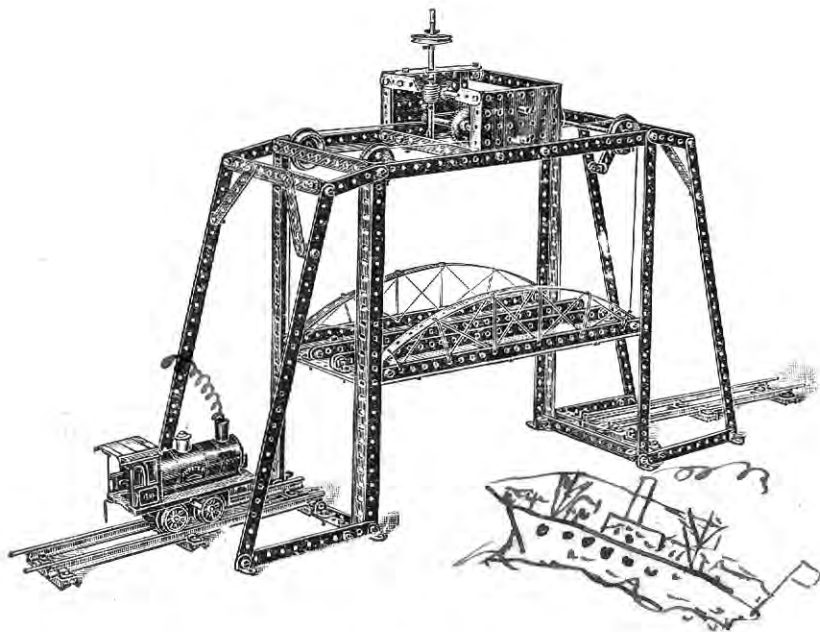

FIG. 71A

FIG. 71B

Model No. 72. Viaduct Bridge

(MADE WITH MECCANO OUTFIT NO. 4 OR NO. 3 AND NO. 3A.)



Parts required in addition to Outfits.

PARTS REQUIRED.	No. 1	No. 2	No. 3
8 $1\frac{1}{2}$ " Perforated Strips	4	—	—
17 $5\frac{1}{2}$ " " "	11	1	—
2 $3\frac{1}{2}$ " " "	1	—	—
4 $3\frac{3}{4}$ " " "	4	4	2
4 $2\frac{1}{2}$ " " "	—	—	—
8 Angle Girders	8	4	—
32 Angle Brackets	20	18	8
2 6" Rods	2	2	2
3 5" "	3	—	—
4 Flanged Wheels	4	—	—
1 $\frac{3}{4}$ " Pinion	1	1	—
1 $\frac{1}{2}$ " "	1	1	—
1 Gear Wheel	1	1	—
1 Worm Wheel	1	1	—
90 Nuts and Bolts	70	40	20
2 Clips	—	—	—
4 Collars and Set Screws	4	4	—
2 Small Rectangular Plates	2	2	—

This model shows the construction of a suspended viaduct bridge, the central girder platform when lowered permitting the locomotive to pass along the continuous track, which is raised to enable ships to pass along the waterway beneath the gantry. The central movable girder platform is suspended from the corner cords, passing over the four pulley wheels, and is raised or lowered by the operation of the gear mechanism in the gear box, Fig. 72A, on the top of the gantry. The grooved pulley wheel 1 on the vertical driving shaft may be operated from an engine. The shaft carries a worm 2 gearing with a $\frac{1}{2}$ " pinion on a transverse shaft 3 which has a $\frac{3}{4}$ " pinion 4, which in turn gears with a gear wheel on the winding spindle 5, to operate the lifting cords. As will be seen by reference to Fig. 72A, the operating cords are led on to the winding spindle 5 in opposite directions, so that when the spindle is being continuously driven in one direction all four cords 6 wind on or off simultaneously.

The side rails and locomotive shown in the illustration are not included in the Outfit.

Model No. 73. Elevated Jib Crane

(MADE WITH MECCANO OUTFIT NO. 4 OR NO. 3 AND NO. 3A.)

Parts required in addition to Outfits.

No. 1 No. 2 No. 3

PARTS REQUIRED.		No. 1	No. 2	No. 3
4	12½" Perforated Strips	—	—	—
7	5½" " "	1	—	—
2	3½" " "	1	—	—
11	2½" " "	2	—	—
4	2½" Bent Strips	—	—	—
4	Angle Girders	4	—	—
15	Angle Brackets	3	1	—
2	11½" Rods	2	2	2
2	4½" " "	—	—	—
3	2" " "	—	—	—
4	Flanged Wheels	4	—	—
1	1½" Pulley Wheel	1	1	—
5	1" " "	—	—	—
1	Bush Wheel	—	—	—
2	¾" Pinion Wheels	2	2	1
1	Gear Wheel	1	1	—
1	1½" Contrate Wheel	1	1	1
66	Nuts and Bolts	46	16	—
1	Hook	—	—	—
9	Clips	3	3	1
4	Collars and Set Screws	4	4	—
1	Double Bent Strip	1	—	—
1	Large Bent Strip	1	1	—
2	Large Rectangular Plates	1	1	—
3	Small " "	3	3	—
1	Sector Plate	—	—	—

FIG. 73A.

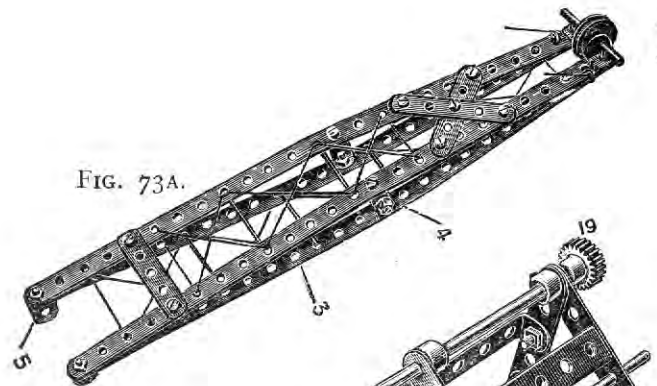

FIG. 73C

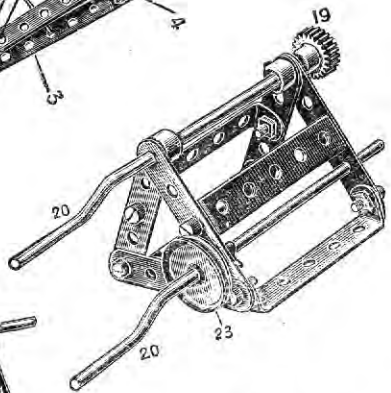
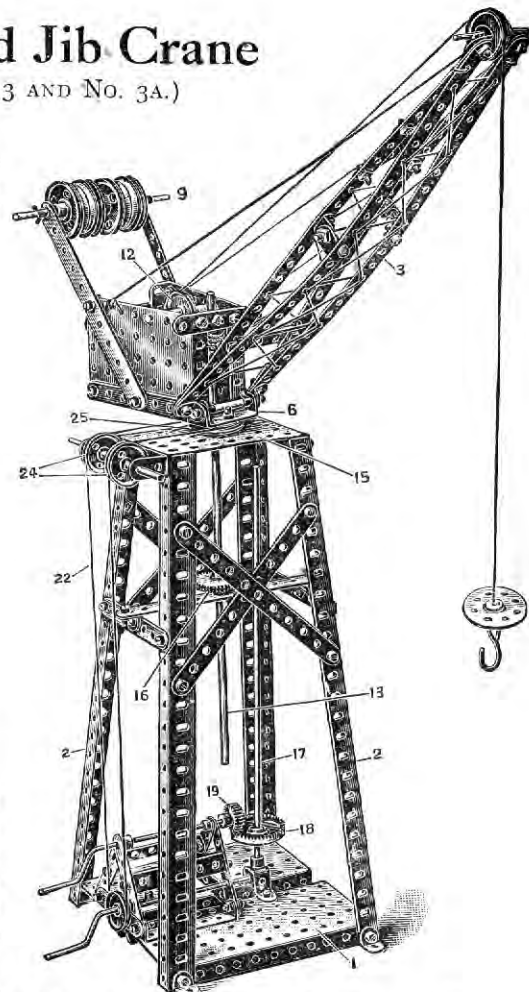
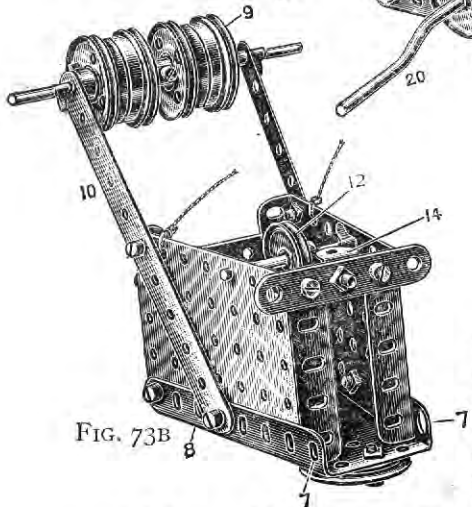

FIG. 73B



The base of the main frame is composed of two large rectangular plates 1, to the outer corners of which are bolted the vertical angle girders 2. The jib, Fig. 73A, is made from 12½" strips 3 distended centrally by angle brackets 4 and bolted together at the ends. Angle brackets 5 form the pivots for the jib about a spindle 6 mounted in the end holes 7 of the flanges of the sector plate 8 forming the base of the upper gear box, Fig. 73B. The balance weight 9 is composed of several flanged wheels

carried from 5½" strips 10. The hoisting cord 11 passes over the jib end pulley to the guide pulley 12, and winds on the upper end of the vertical spindle 13, carried in the angle bracket 14 and the top plate 15. This vertical spindle 13 is operated by a gear wheel 16 meshing with a ¾" pinion on the other vertical spindle 17, which is driven by a contrate wheel 18 from a ¾" pinion 19, Fig. 73C, on the cranked spindle 20. The swivelling of the jib is effected from the cranked spindle 21 by the continuous cord 22 which passes round the pulley wheel 23 over the pulley wheel 24, and round the 1½" pulley wheel 25, bolted to the under surface of the base sector plate 8 of the upper gear box.

Model No. 74. Suspension Bridge

(MADE WITH MECCANO NO. 4 OR NO. 3 AND NO. 3A.)

Parts required in addition to Outfits.

PARTS REQUIRED.

14	12½"	Perforated Strips	10	4	—
16	5½"	" "	10	—	—
2	3½"	" "	1	—	—
2	3"	" "	2	2	—
12	2½"	" "	9	—	—
8		Angle Girders	8	4	—
30		Angle Brackets	18	16	6
102		Nuts and Bolts	82	52	32
2		Large Rectangular Plates	1	1	—
3		Small Rectangular Plates	3	3	—

No. 1	No. 2	No. 3
10	4	—
10	—	—
1	—	—
2	2	—
9	—	—
8	4	—
18	16	6
82	52	32
1	1	—
3	3	—

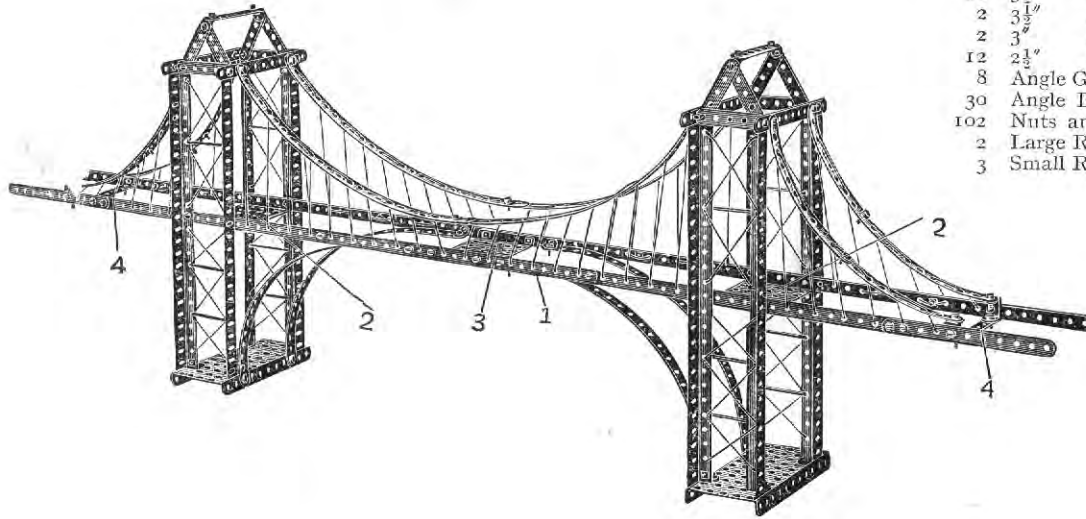

The end towers of this model are built up from four angle girders carried from large rectangular plates at the base.

The rail track platform 1 is coupled to the towers by small rectangular plates 2. A third small rectangular plate 3 being disposed at the centre of the track platform. 3½" strips 4 connect the side strips of the girder platform at each end. Any suitable track rails may be laid across the girder platform.

Model No. 75. Warehouse with Elevator

(MADE WITH MECCANO OUTFIT NO. 4 OR WITH NO. 3 AND NO. 3A.)

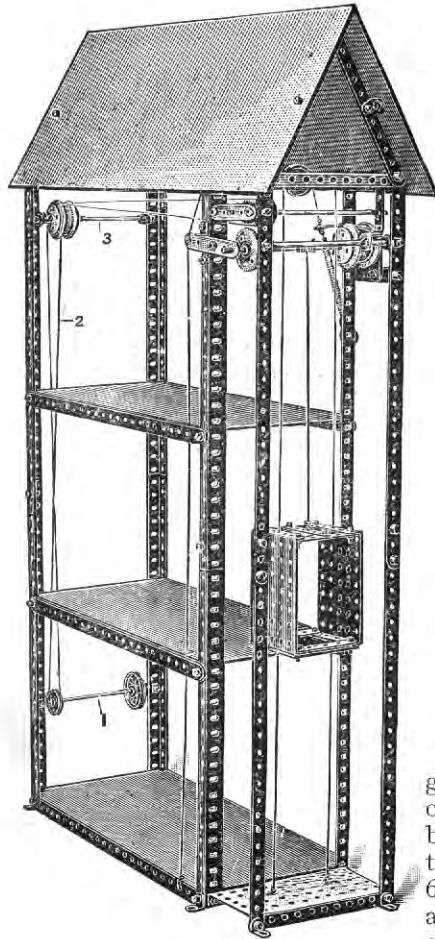

PARTS REQUIRED.

13	12 $\frac{1}{2}$ "	Perforated Strips	9	3	3
8	5 $\frac{1}{2}$ "	" "	2	—	—
2	3 $\frac{1}{2}$ "	" "	1	—	—
1	3"	" "	1	1	—
7	2 $\frac{1}{2}$ "	" "	—	—	—
8		Angle Girders	8	4	—
29		Angle Brackets	17	15	5
2	6"	Rods	2	2	2
2	5"	" "	2	—	—
1	4 $\frac{1}{2}$ "	" "	—	—	—
2	2"	" "	—	—	—
4		Flanged Wheels	4	—	—
1	1 $\frac{1}{2}$ "	Pulley Wheel	1	1	—
4	1"	" "	—	—	—
1	$\frac{3}{4}$ "	Pinion	1	1	—
1		Gear Wheel	1	1	—
86		Nuts and Bolts	66	36	16
1		Hook	—	—	—
6		Clips	—	—	—
1		Spring	1	1	1
2		Large Rectangular Plates	1	1	—
2		Small " "	2	2	—

Parts required in addition to Outfit

No. 1	No. 2	No. 3
9	3	3
2	—	—
1	—	—
1	1	—
—	—	—
8	4	—
17	15	5
2	2	2
2	—	—
—	—	—
—	—	—
4	—	—
1	1	—
—	—	—
—	—	—
1	1	—
1	1	—
66	36	16
—	—	—
—	—	—
1	1	1
1	1	—
2	2	—

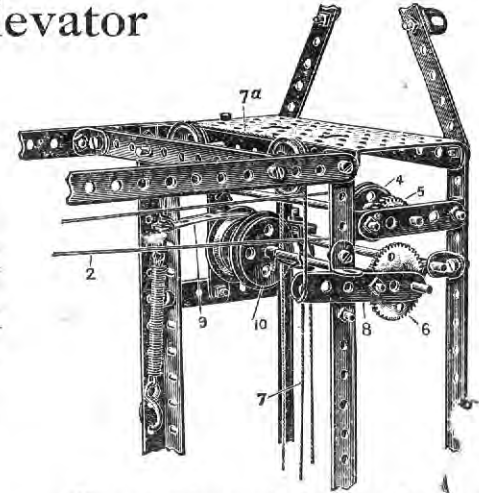

The structure of the warehouse is built up of corner members made from pairs of angle girders overlapped three holes and bolted together in the middle hole. These are connected at the sides by 12 $\frac{1}{2}$ " strips, and at the ends, top, and bottom by 5 $\frac{1}{2}$ " strips, and a large rectangular plate to form the floor for the elevator arrangement.

The driving shaft 1 is connected to the grooved pulley 4 by belt 2 passing over loose pulleys and shaft 3. The shaft carrying the pulley 4 is fitted with a $\frac{3}{4}$ " pinion 5, and is adapted to be geared with the gear wheel 6 by operating the cord 7 controlling the lever 8 which carries the wheel spindle. The cord 7 is extended over pulleys at 7a and connected to a brake band 9 engaging the brake driven pulley 10, formed of two flanged wheels butted together and secured to the winding spindle. The one operation of throwing the gear wheel 6 into engagement with the driving pinion 5, simultaneously releases the brake 9 and enables the cage to be hoisted. By only partially releasing the operating cord 7 the gears 5 and 6 are disconnected without the brake 9 being engaged, the cage is then allowed to descend freely.

Model No. 76. Cable Railway

(MADE WITH MECCANO OUTFIT NO. 4 OR NO. 3 AND NO. 3A.)

Parts required in addition to Outfits.

PARTS REQUIRED		No. 1	No. 2	No. 3
3	5½" Perforated Strips	—	—	—
2	3½" " "	2	2	—
1	2½" " "	—	—	—
2	Angle Girders	2	—	—
6	Angle Brackets	—	—	—
3	5" Rods	3	—	—
3	4½" " "	—	—	—
4	Flanged Wheels	4	—	—
1	1½" Pulley Wheel	1	1	—
2	1" " "	—	—	—
2	¾" Pinions	2	2	2
1	Gear Wheel	1	1	—
2	¾" Contrate Wheels	2	2	2
28	Nuts and Bolts	8	—	—
2	Clips	—	—	—
2	Collars and Set Screws	2	2	1
1	Large Bent Strip	1	1	—
2	Large Rectangular Plates	1	1	—
3	Small " "	3	3	—
2	Sector Plates	—	—	—

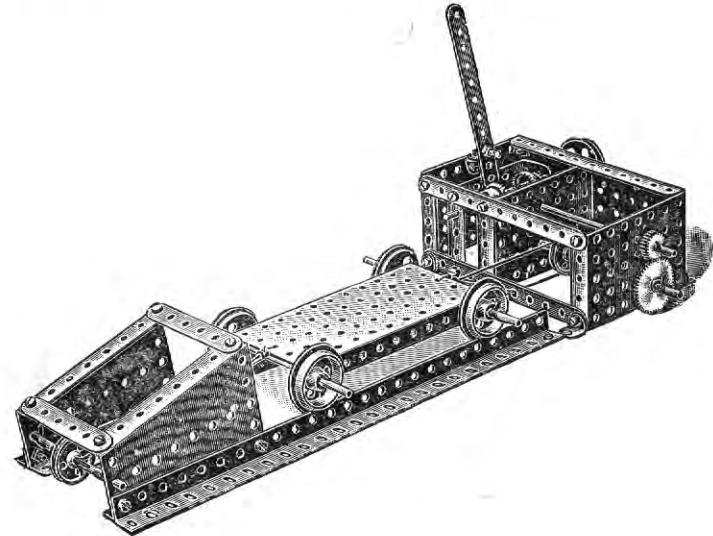

Our illustration hardly does this excellent model justice, owing to the parts having to be so crowded together. This is a very fine model, both instructive and highly interesting.

The driving power is received at the outer 1½" pulley, and is transmitted through the clutch mechanism and the pinion and gear wheels to the lower spindle on which the driving pulley is fixed, the driving rope passing round this pulley and the second pulley at the end of the rails, all as shown in the drawing.

In fixing the lever for operating the clutch mechanism, the nuts should be locked to prevent the screw working out. Only one section of rails is shown in the design, but they may be extended as desired.

Model No. 77. Swivelling and Luffing Jib Crane

(MADE WITH MECCANO NO. 4 OR NO. 3 AND NO. 3A.)

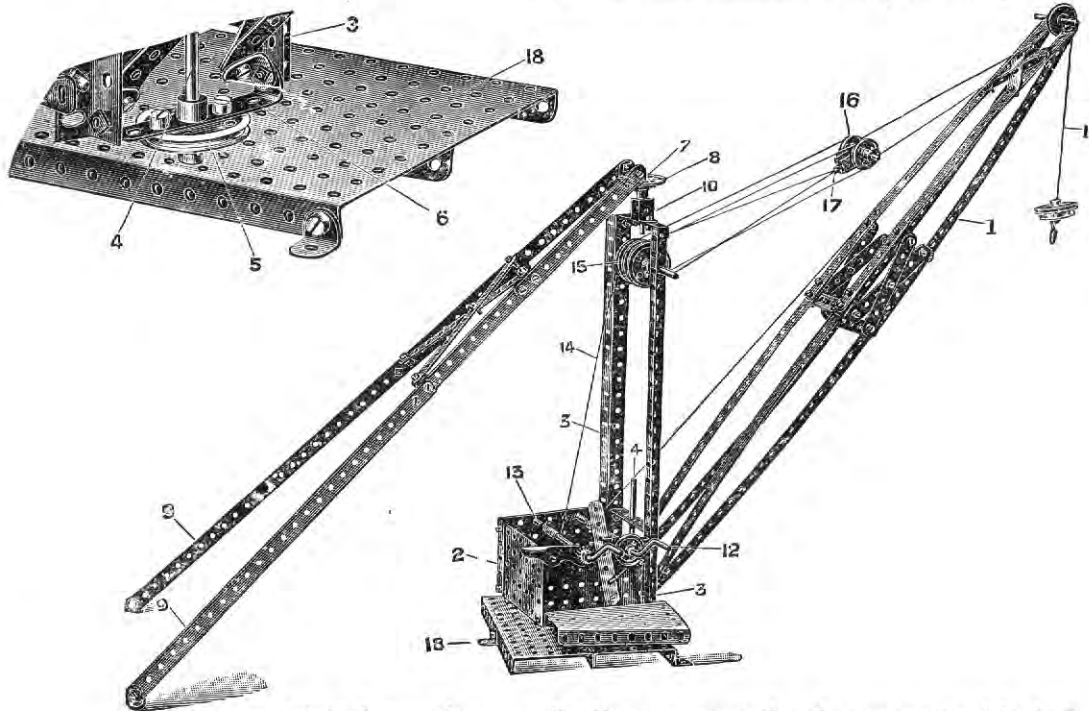

Parts required in addition to Outfits.

PARTS REQUIRED		No. 1	No. 2	No. 3
10	12 $\frac{1}{2}$ " Perforated Strips	6	—	—
6	5 $\frac{1}{2}$ " " "	—	—	—
5	3 $\frac{1}{2}$ " " "	4	3	—
2	2 $\frac{1}{2}$ " " "	—	—	—
4	2 $\frac{1}{2}$ " Bent Straps	—	—	—
23	Angle Brackets	11	9	—
2	4 $\frac{1}{2}$ " Rods	—	—	—
2	2"	—	—	—
2	Crank Handles	1	1	—
4	Flanged Wheels	4	—	—
1	1 $\frac{1}{2}$ " Pulley	1	1	—
3	1"	—	—	—
2	Bush Wheels	1	1	1
1	$\frac{1}{2}$ " Pinion	1	1	—
1	Pawl	1	1	—
78	Nuts and Bolts	58	28	8
1	Hook	—	—	—
7	Clips	1	1	—
2	Large Rectangular Plates	1	1	—
3	Small " "	3	3	—
1	Sector Plate	—	—	—

This model is interesting as affording an example of a crane used to transport the load from say a ship's deck on to a quay by "luffing" or altering the angle of the jib. The jib 1 and its gear box 2, as well as the vertical angle girders 3, all swivel about pivots, the lower one formed by a spindle 4 secured in a pulley wheel 5 bolted to a 2 $\frac{1}{2}$ " bent strip 6, which is also bolted to the girders 3. The upper pivot is a spindle 7 fixed to a bush wheel 8 bolted by angle brackets to the shear legs 9. A double bent strip 10 forms a strong bearing for the spindle 7. The hoisting cord 11 passes round the end jib pulley on to the cranked winding spindle 12. The "luffing" or raising of the jib is controlled by the cranked spindle 13, the cord 14 from which passes over one of the flanged wheels 15 round one of the pair of pulley wheels 16, back round another flanged wheel 15, then round the remaining pulley wheel 16, again round the last flanged wheel 15, and is made fast to the single bent strip 17 between the pulley wheels 16. Cords are connected to the ends of the spindle of the pulley wheels 16 and the end of the jib. The feet of the shear legs 9, and the angle brackets on the flanges of the base rectangular plates 18, carrying the spindle 4, should be screwed to some suitable wooden base.

Model No. 78. Drilling Machine

(MADE WITH MECCANO OUTFIT NO. 4 OR NO. 3 AND NO. 3A.)

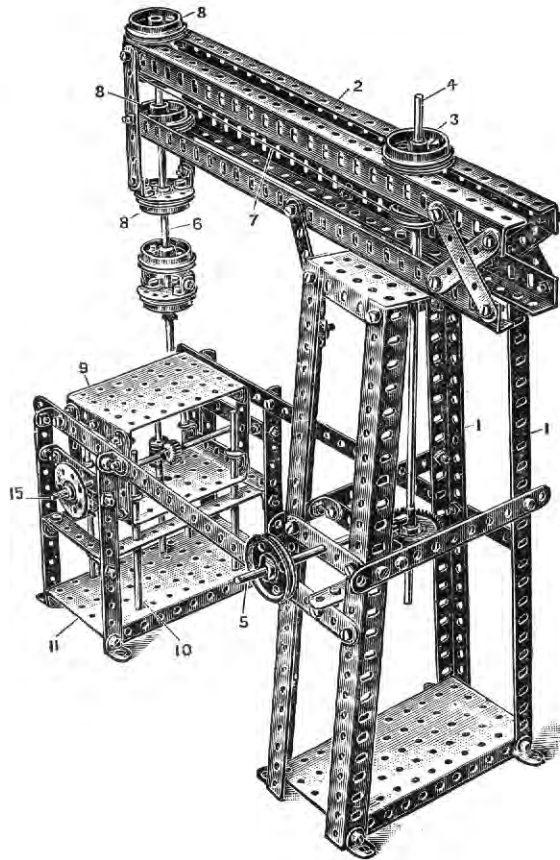

The main tower built up of top and bottom perforated plates with angle girder corner pieces, supports the driller arm made up of four angle girders 2. The lower angle girders of the arm 2 are bolted to the top perforated plate, and a flanged wheel 3 bolted to the top angle girders forms the upper bearing for the driving shaft 4, driven from the main shaft 5 through a pinion and contrate wheel.

The drive from the shaft 4 is conveyed to the drilling spindle 6 by cord 7 passing round grooved pulleys on the spindles 4 and 6. The spindle 6 is journalled in flanged wheels 8 carried from the arm 2.

The drilling table 9 is arranged to rise and fall on the vertical spindles 10, Fig. 78A. These spindles 10 being held in the perforated plate 11, and framing strips 12, and passing through the end holes in the perforated plate 9A of the table and guide angle brackets 13 bolted to the table walls. The vertical movement of the table is effected by the pinion 14 secured to the operating shaft 15 meshing with the worm wheel 16 carried on a spindle 17 rigidly secured with collars and set screws to the table, the worm 16 acting as a rack.

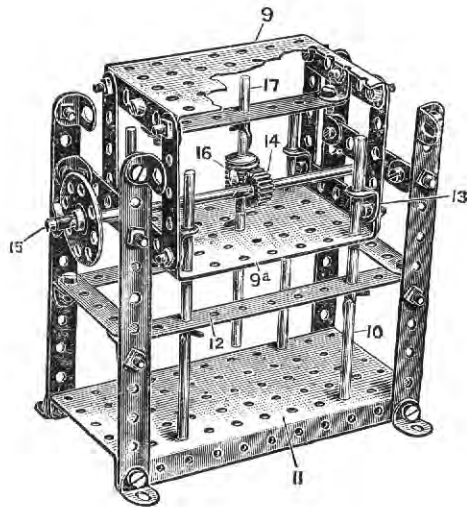

FIG. 78A

Parts required in addition to Outfits.

PARTS REQUIRED.		No. 1	No. 2	No. 3
2	12 $\frac{1}{2}$ " Perforated Strips	—	—	—
9	5 $\frac{1}{2}$ " " "	3	—	—
3	3 $\frac{1}{2}$ " " "	2	1	—
2	3" " "	2	2	—
9	2 $\frac{1}{2}$ " " "	—	—	—
5	2 $\frac{1}{2}$ " Bent Strips	—	—	—
8	12 $\frac{1}{2}$ " Angle Girders	8	4	—
26	Angle Brackets	14	12	2
1	11 $\frac{1}{2}$ " Rod	1	1	1
2	6" "	2	2	2
4	5" "	4	1	—
2	4 $\frac{1}{2}$ " "	—	—	—
1	2" "	—	—	—
6	Flanged Wheels	6	2	2
1	1 $\frac{1}{2}$ " Pulley Wheel	1	1	—
2	1" " "	—	—	—
1	Bush " "	—	—	—
2	$\frac{1}{2}$ " Pinion "	2	2	—
1	1 $\frac{1}{2}$ " Contrate "	1	1	1
1	Worm "	1	1	—
102	Nuts and Bolts	82	52	32
8	Clips	2	2	—
4	Collars and Set Screws	4	4	—
2	Large Rectangular Plates	1	1	—
3	Small " "	3	3	—

Model No. 79. Travelling Crane

(MADE WITH MECCANO OUTFIT No. 4 OR WITH NO. 3 AND NO. 3A.)

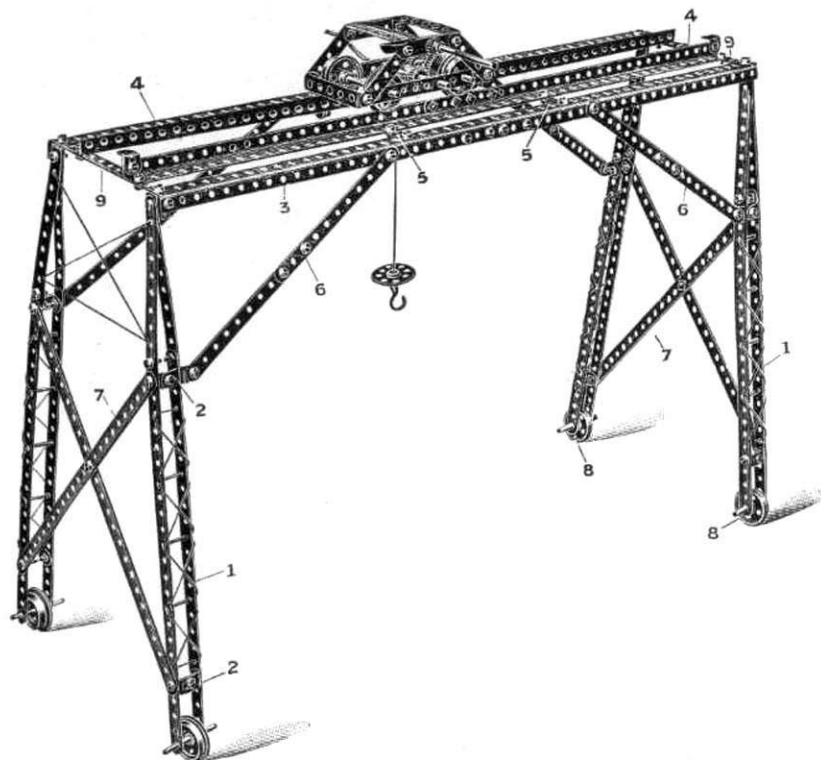

Parts required in addition to Outfits.

PARTS REQUIRED.

12	12 1/2"	Perforated Strips	8	2	—
20	5 1/2"	" "	14	4	2
2	3 1/2"	" "	2	2	—
6	2 1/2"	" "	—	—	1
4	2 3/8"	Bent Strips	—	—	—
8		Angle Girders	8	4	—
32		Angle Brackets	20	18	8
1	3 1/2"	Rod	1	—	—
4	2"	Rods	2	2	2
2		Crank Handles	1	1	—
8		Flanged Wheels	8	4	4
1		Bush Wheel	—	—	—
1	3/4"	Pinion	1	1	—
1	1 1/2"	" "	1	1	—
1		Gear Wheel	1	1	—
1		Pawl	1	1	—
92		Nuts and Bolts	72	42	22
1		Hook	—	—	—

No. 1	No. 2	No. 3
8	2	—
14	4	2
2	2	—
—	—	1
—	—	—
8	4	—
20	18	8
1	—	—
2	2	2
1	1	—
8	4	4
—	—	—
1	1	—
1	1	—
1	1	—
1	1	—
72	42	22
—	—	—

The side frames of this model are each similarly constructed. Each leg 1 is made of 12 1/2" and 5 1/2" perforated strips, overlapped two holes and distended by angle brackets 2 and bolted together at the top, and to angle brackets bolted to the ends of the outer horizontal angle girders 3. The inner angle girders 4 are reversed with their webs up, to form rails for the crane, Fig. 71B. The central parts of the girders 4 are supported by double angle brackets 5, and the outer girders 3 are braced by the diagonal 5 1/2" strips 6 bolted to the legs 1 and the girders 3. Each end pair of legs is also braced by the crossed 12 1/2" strips 7. The whole gantry travels on the flanged wheels 8 carried on 2" rods passed through the lowest holes of the legs 1. 5 1/2" strips 9 connect the outer girders 3 and inner girders 4.

Model No. 80. Girder Crane

(MADE WITH MECCANO OUTFIT NO. 4 OR NO. 3 AND NO. 3A.)

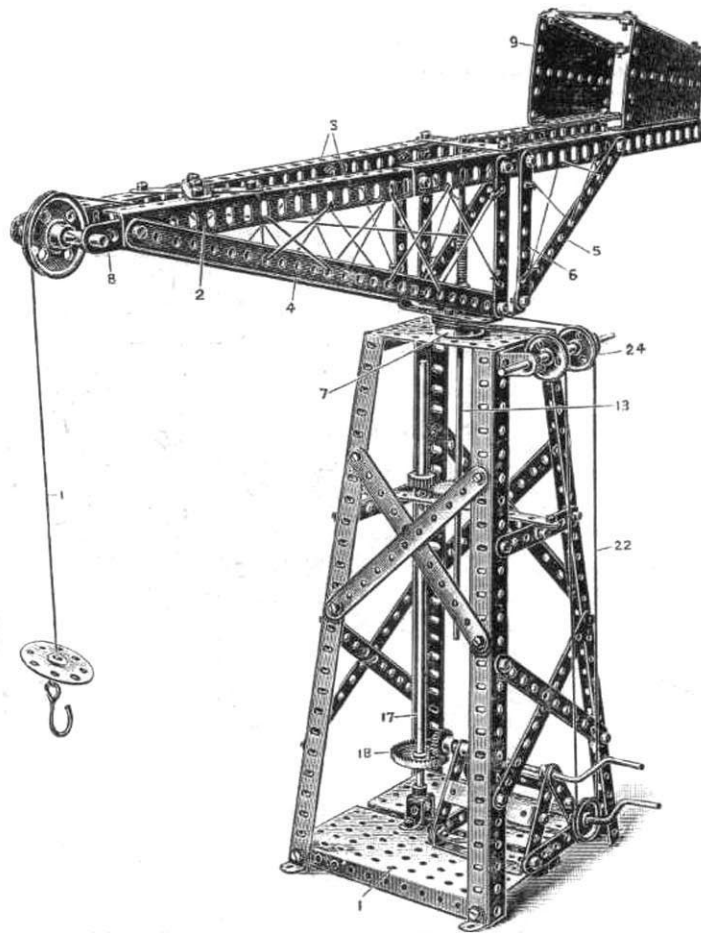

Parts required in addition to Outfits.

PARTS REQUIRED

2	12½"	Perforated Strips	—	—	—
11	5½"	" "	5	—	—
6	3½"	" "	5	4	—
14	2½"	" "	5	2	2
6	2½"	Bent Strips	2	—	—
8		Angle Girders	8	4	—
6		Angle Brackets	—	—	—
2	11½"	Rods	2	2	2
1	3½"	Rod	—	—	—
1	2"	"	—	—	—
2		Crank Handles	1	1	—
1		Flanged Wheel	1	—	—
1	1½"	Pulley Wheel	1	1	—
3	1"	"	—	—	—
1		Bush Wheel	—	—	—
2	¾"	Pinions	2	2	1
		Gear Wheel	1	1	—
		1½" Contrate Wheel	1	1	1
6		Clips	—	—	—
4		Collars and Set Screws	4	4	—
75		Nuts and Bolts	55	25	5
1		Hook	—	—	—
1		Double Bent Strip	1	—	—
1		Large "	1	1	—
2		Large Rectangular Plates	1	1	—
1		Small "	1	1	—
2		Sector Plates	—	—	—

The lower structure of this model is identical with that of Fig. 73. The hoisting cord 1 after passing over the end jib pulley, winds on the 11½" rod 13, as described in Fig. 73. The jib is built up of horizontal angle girders 3, overlapped 8 holes and strengthened by the diagonal 12½" strips 4 and 5½" strips 5 connected to the vertical 3½" strips 6 bolted at the bottom to 2½" bent strips bolted to the flanged wheel 7. 2½" strips 8 extend from the angle girders 3 to carry the jib pulley. The balance weight is formed by two sector plates 9.

Model No. 81. Coal Tip

(MADE WITH MECCANO OUTFIT NO. 4 OR NO. 3 AND NO. 3A.)

Parts required in addition to Outfits.

PARTS REQUIRED.

2	12 1/2"	Perforated Strips		
19	5 1/2"	" "		
3	3 1/2"	" "		
4	3"	" "		
13	2 1/2"	" "		
4	2 1/2"	Bent Strips		
8	12 1/2"	Angle Girder		
28		Angle Brackets		
2	6"	Rods		
4	5"	" "		
3	4"	" "		
1	3 1/2"	Rod		
1		Crank Handle		
6	1"	Pulley Wheels		
2	3/4"	Pinions		
1	1"	Pinion		
1		Gear Wheel		
1		Worm Wheel		
15		Clips		
4		Collars and Set Screws		
110		Nuts and Bolts		
1		Large Bent Strip		
2		Large Rectangular Plates		
3		Small " "		
1		Sector Plates		

No. 1.	No. 2.	No. 3.	No. 4.
13	3	1	
2	1		
4	4	2	
4	1	1	
8	1		
2	2	2	
4	1		
1			
2	2	1	
1	1		
1	1		
9	9	7	3
4	4		
90	60	40	
1	1		
1	1		
3	3		

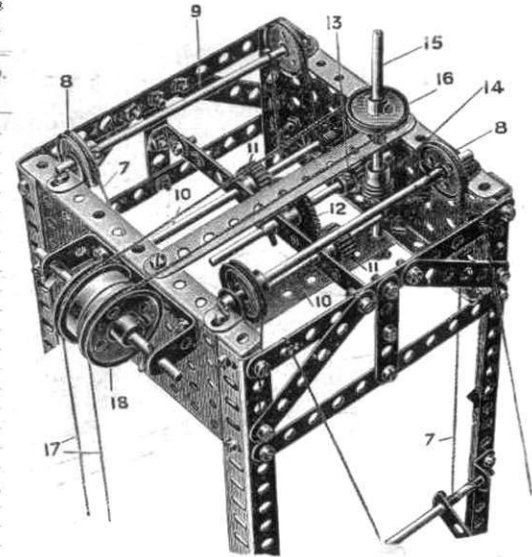
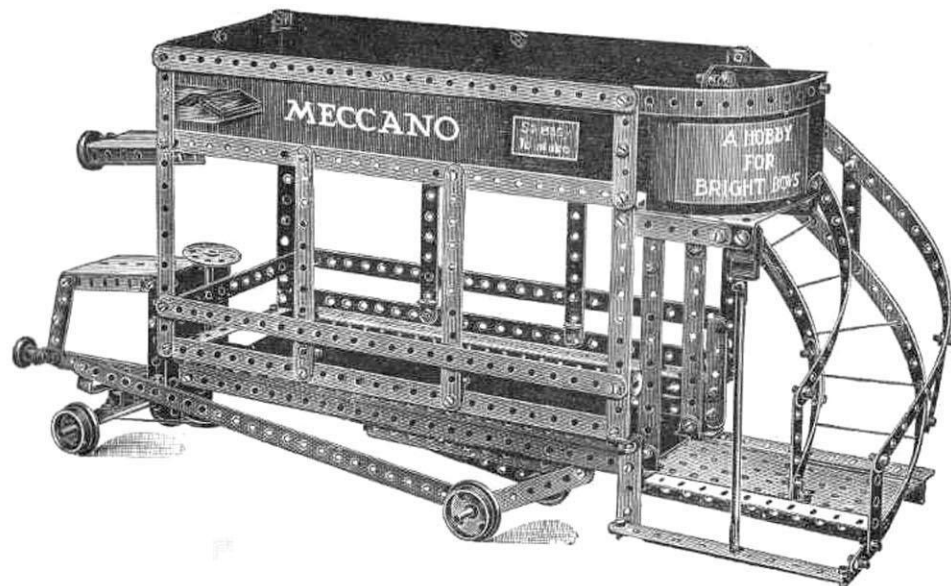

Fig. 81A.

The vertical standards 1 are built up from overlapped angle girders, connected by cross strips 2 and flanged plates 3. The rising and falling platform 4, upon the rails 5 of which the truck 6 is carried, is arranged to be raised or lowered in the framework 1 by the suspension cords 7, one at each corner. These suspension cords are connected to the corners of the platform 4; and pass over four pulleys 8 carried in the head of the frame on spindles 9. The cords 7 after passing over the pulleys 8 are wound on lower spindles 10 (Fig. 81A), fitted with pinions 11 gearing with and being driven by a gear wheel 12. On the same spindle which carries the gear wheel 12 is a pinion 13, driven by a worm 14 on a vertical spindle 15 carrying a pulley 16. The operating cord 17 passes round the pulley 16 and the flange pulleys 18, to a pulley 19 on the crank spindle 20, by means of which the raising or lowering of the platform 4 is controlled. The chute 21, made from a sector plate, is carried from a spindle passed through its inner perforations and secured to the uprights 1, and is supported by cords from its outer perforations.

Model No. 82. Motor Bus

(MADE WITH MECCANO NO. 4 OR NO. 3 AND NO. 3A.)



Parts required in addition to Outfits.

PARTS REQUIRED.		No. 1.	No. 2.	No. 3.
12	12 1/2" Perforated Strips	8	2	2
18	5 1/2" " "	12	2	—
6	3 1/2" " "	5	4	—
2	3" " "	2	2	—
16	2 1/2" " "	7	4	4
1	2 1/2" Bent Strips	—	—	—
6	Angle Girders	6	2	—
31	Angle Brackets	19	17	7
1	6" Rods	1	1	1
3	5" " "	3	—	—
4	Flanged & Grooved Wheels	4	—	—
2	1" Pulley Wheels	—	—	—
1	Bush Wheel	—	—	—
2	3/4" Contrate Wheels	2	2	2
5	Collars and Set Screws	5	5	1
120	Nuts and Bolts	100	70	50
1	Single Bent Strip.	—	—	—
2	Double Bent Strip	2	1	1
1	Large Bent Strip	1	1	—
2	Large Rectangular Plates	1	1	—
1	Small Rectangular Plates	1	1	—
2	Sector Plate	—	—	—

The chassis, Fig. 82A, is built up of angle girders 1, to which is bolted the bonnet, made up of a large flanged plate 2 and sector plate 3, the steering wheel 4 being carried on a spindle pivoted in the plate 2, and secured in position by a collar and set screw 4 on the top, and a double bent strip bolted below the plate, a 1" pulley being secured at the bottom of the spindle, around which a cord is passed twice and connected with each end of the front axle strip. The rear platform 7 is bolted to the girders 1. The superstructure, Fig. 82B, the construction of which is well shown in the figure, is connected to the chassis as follows. The end brackets 6 are bolted to the plate 7 and the strip 10, and the holes 8 to the angle brackets 9. The strips 11 are also bolted to the end vertical strips 12 of the superstructure. The upper ends of the door frame strips 13 are bolted to angle brackets beneath the forward edge of the flanged plate 14. The cardboard decorations shown in this model are not supplied with the outfit.

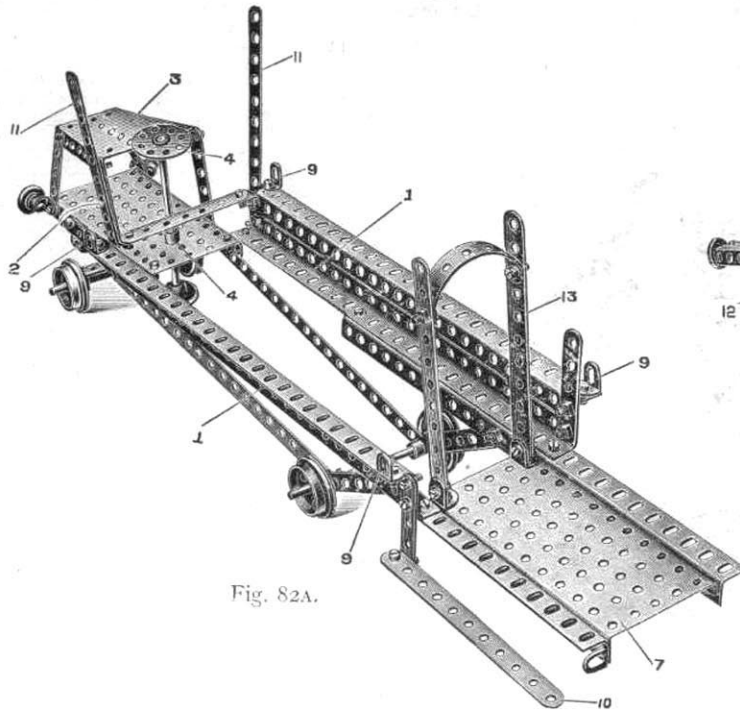

Fig. 82A.

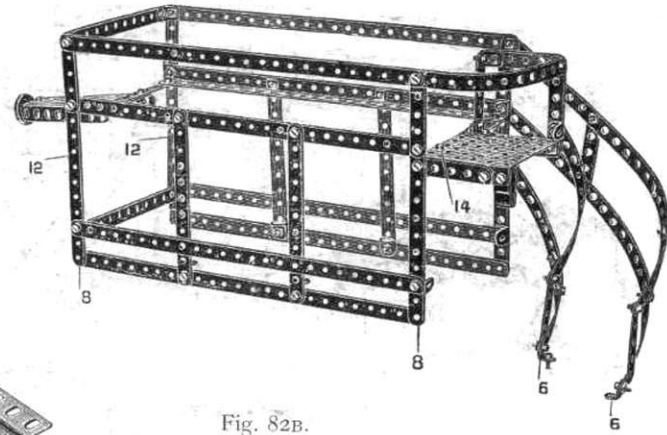

Fig. 82B.

HOW TO CONTINUE

This completes the Models which may be made with MECCANO Outfit No. 5. The next Models are a little more advanced, requiring a number of extra parts to construct them. The necessary parts are all contained in a No. 5a Accessory Outfit, the cost of which will be found in the Price List at the end of the Manual.

Model No. 86. Planing Machine

(MADE WITH MECCANO OUTFIT No. 5 OR No. 4 AND No. 4A.)

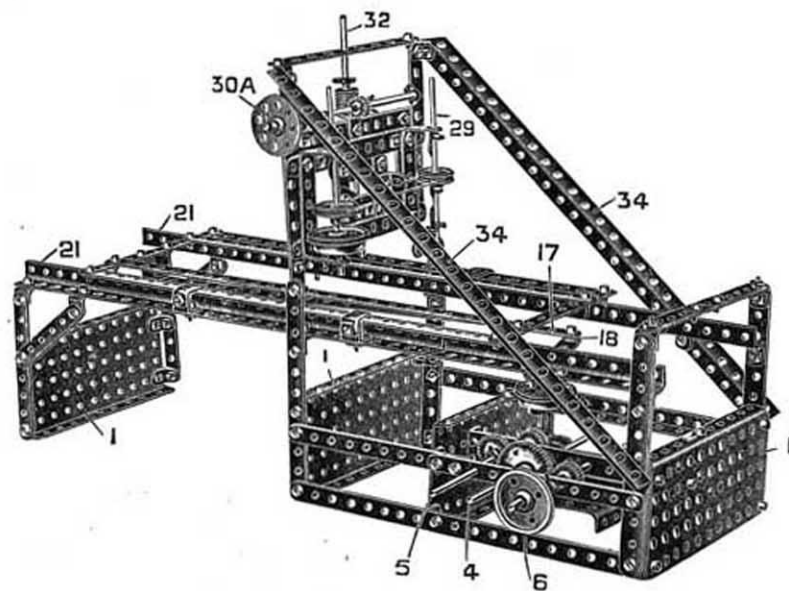

Parts required in addition to Outfits.

PARTS REQUIRED.		No. 1	No. 2	No. 3	No. 4
3	12 $\frac{1}{2}$ " Perforated Strips	—	—	—	—
24	5 $\frac{1}{2}$ " " " "	18	8	6	4
3	3 $\frac{1}{2}$ " " " "	2	1	—	—
4	3" " " "	4	4	2	—
6	2 $\frac{1}{2}$ " " " "	—	—	—	—
3	2" " " "	—	—	—	—
8	12 $\frac{1}{2}$ " Angle Girders	3	3	3	3
45	Angle Brackets	8	4	—	—
1	6" Rod	33	29	19	1
2	5" Rods	1	1	1	—
3	4 $\frac{1}{2}$ " " "	2	—	—	—
2	3 $\frac{1}{2}$ " " "	—	—	—	—
1	2" Rod	2	2	2	2
2	Flanged Wheels	—	—	—	—
1	1 $\frac{1}{2}$ " Pulley Wheel	2	—	—	—
2	1" " "	1	1	—	—
1	$\frac{1}{2}$ " " "	—	—	—	—
1	Bush Wheel	1	1	—	—
2	$\frac{3}{4}$ " Pinion	—	—	—	—
2	$\frac{1}{2}$ " " "	2	2	1	—
2	Gear Wheels	2	1	—	—
1	1 $\frac{1}{2}$ " Contrate Wheel	2	2	1	1
1	Worm Wheel	1	1	1	—
133	Nuts and Bolts	1	1	—	—
27	Keys	118	83	63	23
2	Collars and Set Screws	18	16	5	5
1	Double Bent Strip	2	2	—	—
2	Large " " "	1	—	—	—
4	Large Rectangular Plates	2	2	1	1
1	Small " " "	3	3	2	2
		1	1	—	—

Begin by constructing the gear box Fig. 86A, consisting of three large rectangular plates (1) joined by pairs of 5 $\frac{1}{2}$ " strips (2) overlapped three holes. The strips (2) form bearings for the spindles (3) (4) and (5). The spindle (3) on which is the driving pulley (6) carries pinion (7) meshing with the gear wheel (8) keyed with the pinion (9) on the spindle (4). This pinion (9) meshes with the gear wheel (10) on the spindle (5) which also carries pinion (11) engaging the contrate wheel (12) on the vertical spindle (13). A crank is formed on the flanged wheel (14) by means of two angle brackets, bolted thereon. This crank is pivotally connected to the link (16) Fig. 86B, the other

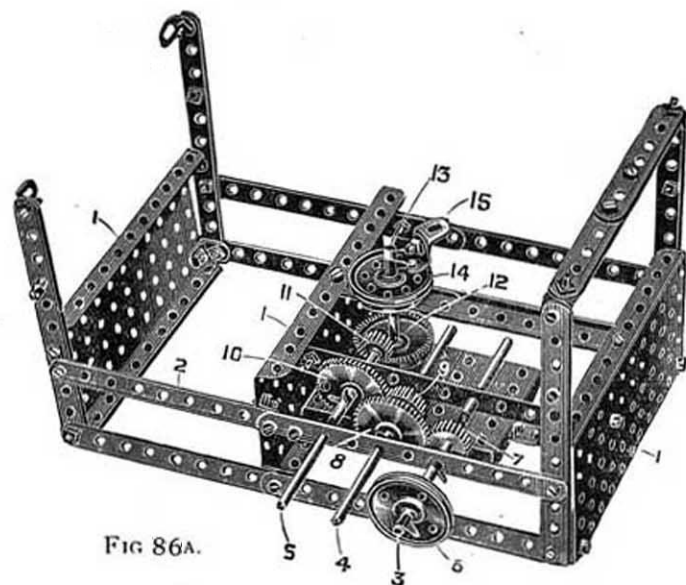

FIG. 86A.

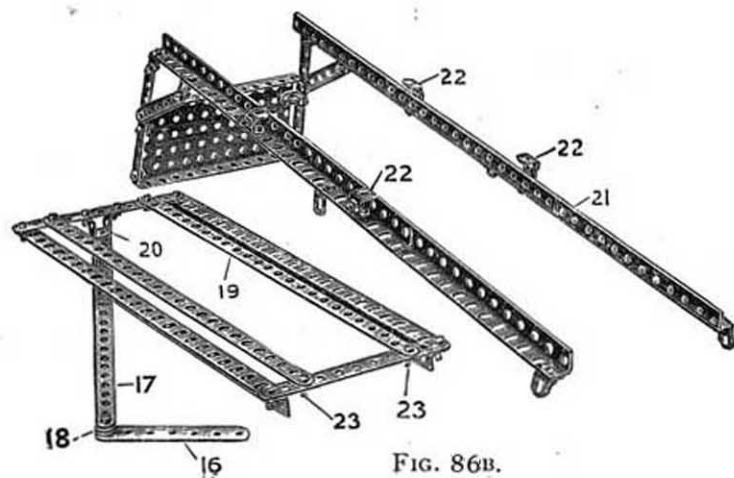

FIG. 86B.

extremity of which is pivotally connected to the connecting rod (17) by a lock-nutted attachment (18). The rod (17) is coupled to the table (19) by the double bent strip (20). The table (19) runs upon the angle girders (21). The angle brackets (22) forming guides for the table are first bolted in position, and the end nuts and bolts (23) of the table removed to enable the table to pass under the angle brackets initially.

Fig. 86C illustrates the mechanism for controlling the traversing and vertical movement of the tool (24). The tool is carried in the plate (25) to which are secured angle-brackets (26) from which the operating cord (27) controlled by the flanged wheel (28A) passes round the pulleys (28) on the spindles (29). The vertical movement of the plate is regulated through the bush wheel (30A) by means of the pinion (30) engaging the worm (31) here acting as a rack, and keyed to the vertically moving spindle (32) guided in the strip (33). The tool head is stayed to the rear plate (1) by the diagonal girders (34).

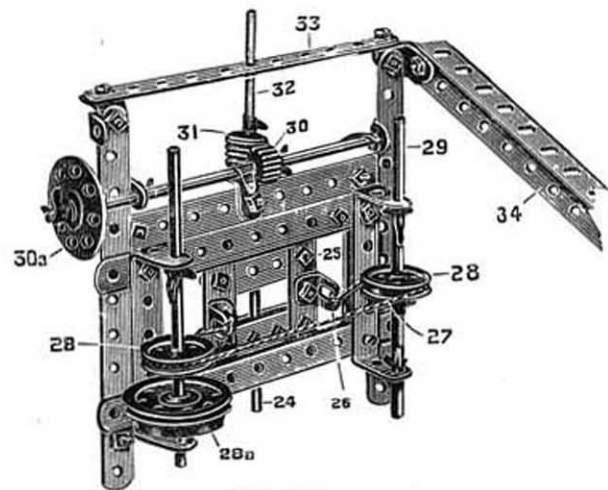

FIG. 86C.

Model No. 87. Lighthouse

(MADE WITH MECCANO OUTFIT NO. 15 OR NO. 4 AND NO. 4A.)

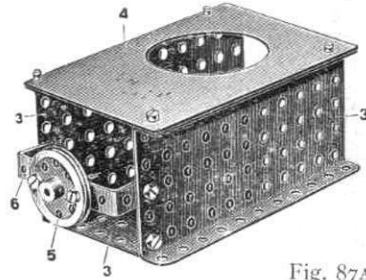
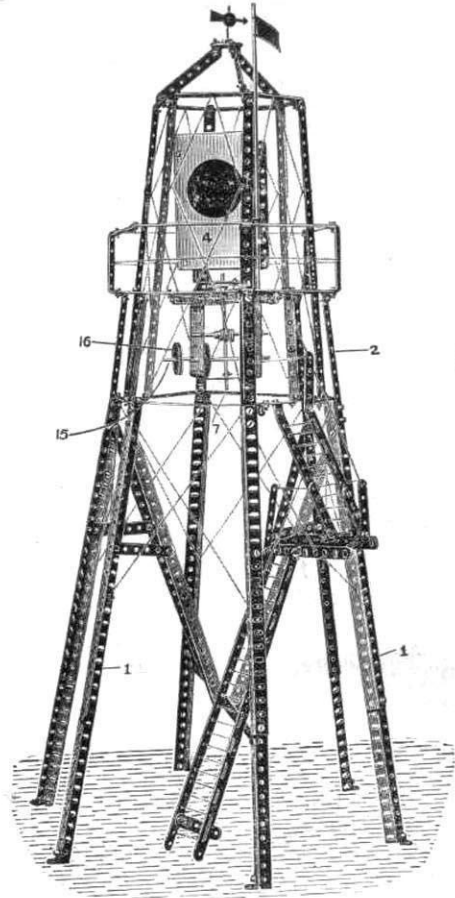

Fig. 87A.

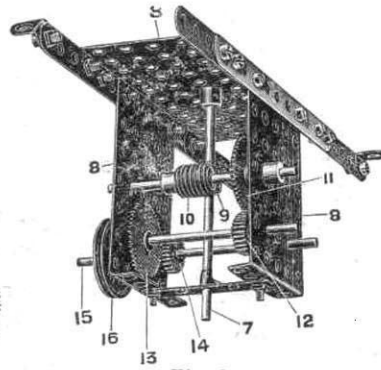

Fig. 87B.

Parts required in addition to Outfits.

PARTS REQUIRED,		No. 1.	No. 2.	No. 3.	No. 4.
14	12 1/2" Perforated Strips	10	4	4	—
20	5 1/2" " "	20	10	8	6
12	3 1/2" " "	11	10	6	6
6	3 1/2" " "	6	6	4	2
9	2 1/2" " "	—	—	—	—
7	2 1/2" Bent Strips	3	1	1	1
12	1 1/2" Angle Girders	12	5	4	4
53	Angle Brackets	41	39	29	17
1	1 1/2" Rod	1	1	1	—
1	5 1/2" " "	1	—	—	—
1	4 1/2" " "	—	—	—	—
2	3 1/2" Rods	2	1	1	1
1	2" Rod	—	—	—	—
1	Bush Wheel	—	—	—	—
2	3/4" Pinions	2	2	1	—
1	1/2" Pinion	1	1	—	—
2	1 1/2" Pulleys	2	2	1	1
2	Gear Wheels	2	2	1	1
1	Worm Wheel	1	1	—	—
4	Collars and Set Screws	4	4	—	—
60	Nuts and Bolts	140	110	90	40
1	Large Bent Strip	1	1	—	—
3	Large Rectangular Plates	2	2	1	1
2	Small " "	2	2	—	—
1	Sector Plate	—	—	—	—

The vertical standards 1 consist of angle girders extended by perforated strips 2 to carry the superstructure. The construction of this superstructure and the means for revolving the light are brought out in the detail views, Figs. 87A, 87B. The lantern (Fig. 87A) is built up from rectangular plates 3 to form three sides, the remaining side being enclosed by a piece of

cardboard 4 in which is cut an aperture. A pulley wheel 5 is bolted to a bent strip 6 carried from the plates 3, as shown in the figures. This pulley wheel 5 is secured to the top of the spindle 7 (Fig. 87B) mounted in a framework made of perforated rectangular plates 8. The spindle 7 carries a pinion 9 driven by a worm 10, on the spindle 7 which is a gear wheel 11 driven by a pinion 12. On the same spindle is another gear wheel 13 which in turn is driven by a pinion 14 on a spindle 15 carrying a pulley 16. Any suitable means may be devised for driving the pulley 16 by an operating cord, and owing to the gear train 14, 13, 12, 11, 10, and 8, the lantern is caused to revolve slowly and a moving beam of light thrown from the lantern head. This is almost an exact copy of the Maplin Lighthouse, which stands on Margate Sands.

Model No. 88. Telpher Line

(MADE WITH MECCANO OUTFIT NO. 3 OR NO. 4 AND NO. 4A.)

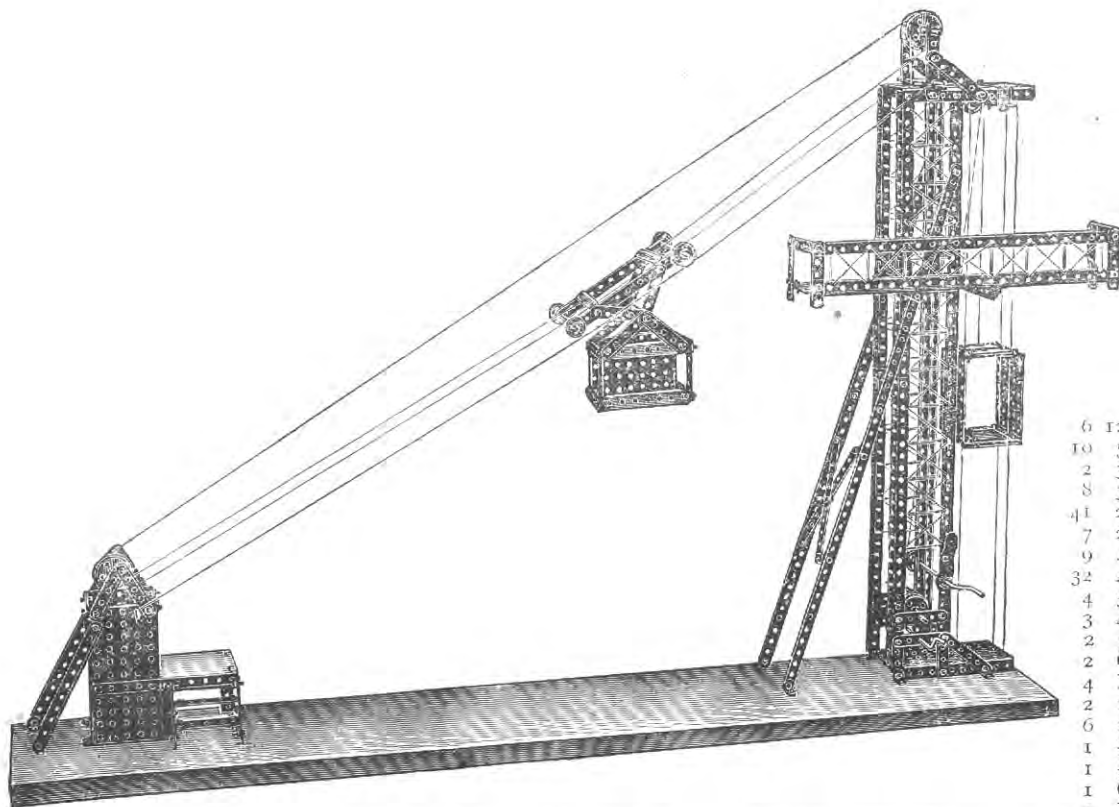

This figure represents a Telpher Line such as is used in hilly countries for transporting loads across intervening valleys. The travelling cage or bucket should be loosely pivoted from the roller cage, so that it may hang vertically when travelling down the inclined ropes. The drawing ropes should be wound once round the suspension pulleys of the bucket.

Parts required in addition to Outfits.

PARTS REQUIRED.

6	12 1/2"	Perforated Strips	2	—	—	—
10	5 1/2"	" "	4	—	—	—
2	3 1/2"	" "	1	—	—	—
8	3 1/2"	" "	8	8	6	4
4	2 1/2"	" "	32	29	20	23
7	2 1/2"	Bent Strips	3	1	1	1
9		Angle Girders	9	5	1	1
32		Angle Brackets	20	18	8	—
4	5"	Rods	4	1	—	—
3	4 1/2"	" "	—	—	—	—
2	3 1/2"	" "	2	1	1	1
2		Crank Handles	1	1	—	—
4		Flanged & Grooved Wheels	4	—	—	—
2	1 1/2"	Pulley Wheels	2	2	1	1
6	1"	" "	—	—	—	—
1	3/4"	Pinion Wheel	1	1	—	—
1	1/2"	" "	1	1	—	—
1		Gear Wheel "	1	1	—	—
1		Pawl	1	1	—	—
14		Nuts and Bolts	12	9	7	2
9		Clips	3	3	1	—
1		Large Bent Strip	1	1	—	—
4		Large Rectangular Plates	3	3	2	2
3		Small Rectangular Plates	3	3	—	—

No. 1	No. 2	No. 3	No. 4
2	—	—	—
4	—	—	—
1	—	—	—
8	8	6	4
32	29	20	23
3	1	1	1
9	5	1	1
20	18	8	—
4	1	—	—
—	—	—	—
2	1	1	1
1	1	—	—
1	1	—	—
1	1	—	—
12	9	7	2
3	3	1	—
1	1	—	—
3	3	2	2
3	3	—	—

Model No. 89. Travelling Gantry (MADE WITH MECCANO OUTFIT NO. 5 OR NO. 4 AND NO. 4A.)

Parts required in addition to Outfits.

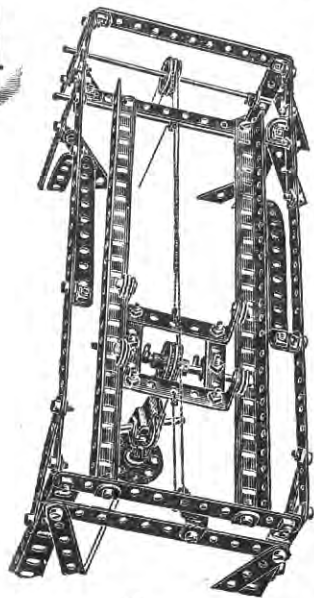
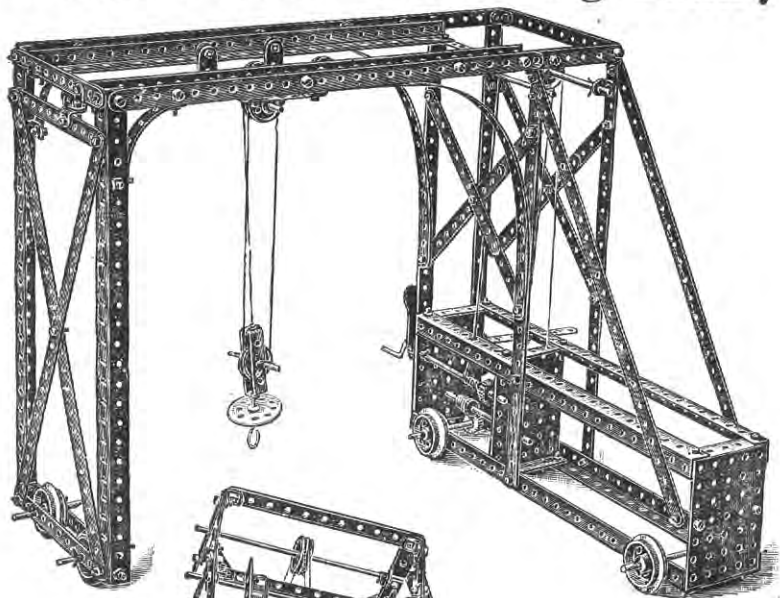

FIG. 89B

PARTS REQUIRED.			No. 1	No. 2	No. 3	No. 4
12	12 1/2"	Perforated Strips	8	2	—	—
16	5 1/2"	" "	10	—	—	—
1	3 1/2"	" "	—	—	—	—
2	3 1/2"	" "	2	2	—	—
3	2 1/2"	" "	—	—	—	—
8		Angle Girders	8	4	—	—
26		Angle Brackets	14	10	—	—
2	6"	Rods	2	2	2	—
1	5"	"	1	—	—	—
2	4 1/2"	"	—	—	—	—
4	2"	"	2	2	1	—
3		Crank Handles	2	2	1	—
6		Flanged & Grooved Wheels	6	2	2	—
6	1"	Pulleys	—	—	—	—
6	1 1/2"	"	6	6	5	5
1		Bush Wheel	—	—	—	—
2	3/4"	Pinion Wheels	2	2	1	—
2	1 1/2"	" "	2	2	—	—
1		Gear Wheel	1	1	—	—
1		Worm Wheel	1	1	—	—
109		Nuts and Bolts	84	59	39	—
1		Pawl	1	1	—	—
1		Hook	—	—	—	—
9		Clips	3	3	1	—
4		Collars and Set Screws	4	4	—	—
2		Single Bent Strips	1	1	1	1
2		Large Bent Strips	2	2	1	1
3		Small Rectangular Plates	3	3	—	—

A most interesting model to the student of mechanics. If carefully constructed, the mechanism will be found to work with the utmost precision and smoothness, and much instruction can be gained by a study of its parts.

The construction is quite straightforward, and hardly needs any description. Care should be taken as to the construction of the clutch mechanism, which is clearly shown in the illustration, Fig. 89A.

As regards the cord for operating the travelling carriage, care must be taken to wind this cord twice round the pulley on the spindle of the traversing handle, to give a good grip. Fig. 89B shows the construction of the top part of the gantry.

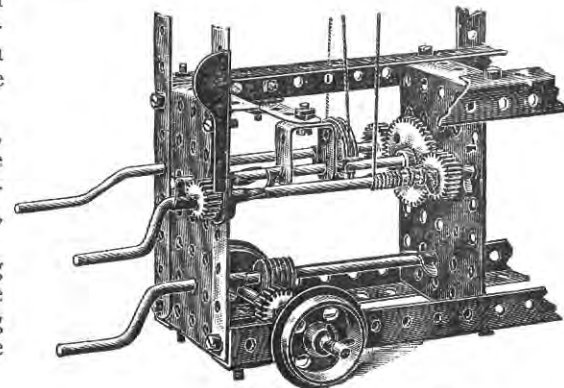

FIG. 89A

Model No. 90. Revolving Aeroplane

(MADE WITH MECCANO OUTFIT NO. 5 OR NO. 4 AND NO. 4A.)

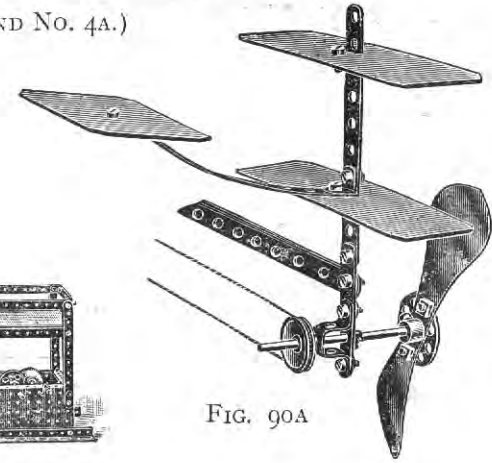
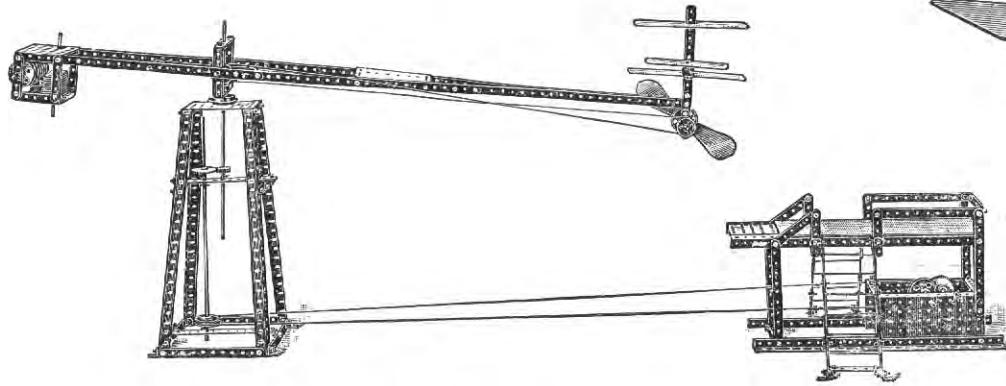

FIG. 90A

*Parts required in addition
to Outfits.*

PARTS REQUIRED.		No. 1	No. 2	No. 3	No. 4
6	12½" Perforated Strips	2	—	—	—
23	5½" " "	17	7	5	3
10	3½" " "	9	8	4	4
2	3" " "	2	2	—	—
9	2½" " "	—	—	—	—
2	2½" Bent Strips	—	—	—	—
8	Angle Girders	8	4	—	—
24	Angle Brackets	12	10	—	—
2	11½" Rods	2	2	2	—
4	5" " "	4	1	—	—
1	4½" " "	—	—	—	—
1	3½" " "	1	1	—	—
1	2" " "	—	—	—	—
1	Crank Handle	—	—	—	—
1	Flanged Wheel	1	—	—	—
2	1½" Pulley Wheels	2	2	1	1

*Parts required in addition
to Outfits.*

PARTS REQUIRED.		No. 1	No. 2	No. 3	No. 4
2	1" Pulley Wheels	—	—	—	—
6	½" Bush " "	6	6	5	5
1	1" Bush Wheel	—	—	—	—
3	¾" Pinions	3	3	2	1
2	Gear Wheels	2	2	1	1
1	¾" Contrate Wheel	1	1	1	—
128	Nuts and Bolts	108	78	58	8
15	Clips	9	9	7	3
2	Propeller Blades	2	2	2	2
1	Double Bent Strip	1	—	—	—
2	Large Bent Strips	2	2	1	1
2	Large Rectangular Plates	1	1	—	—
4	Small Rectangular Plates	4	4	1	1
1	Sector Plate	—	—	—	—

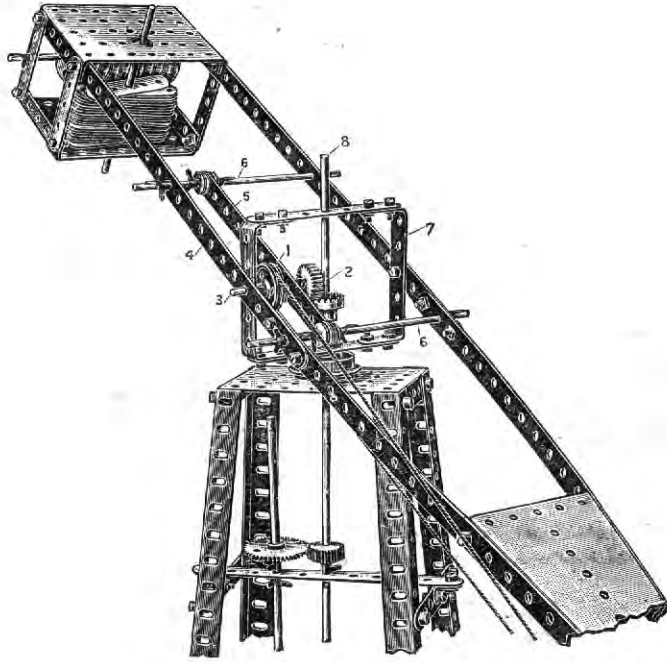

FIG. 90B

As regards the construction of the detailed portion shown in Fig. 90B, the pulley wheel 1 and the pinion 2 are both secured on the short spindle 3 in the following manner: The pulley wheel 1 is first inserted on the spindle 3, after the latter has been passed through the outer strip 4. It is then secured on the spindle, and the $5\frac{1}{2}$ " strip 5, which is loose on both the spindles 6, is then slid on the spindles 6 and the spindle 3 close against the pulley wheel 1. The pinion 2 is then inserted on the spindle 3, and secured in place. During this operation it is necessary to have the swinging arm and the square frame 7 drawn off the main vertical spindle 8, so as to give room for the securing of the pulley 1 and pinion 2, after which the frame 7 may be dropped into place over the spindle 8.

The balance weight is made up of a series of short strips or wheels threaded over the spindles in the shorter arm, and by this means the weight can be adjusted to any nicety.

The driving gear is operated from the crank handle (shown on the right in the sketch), and drives the vertical spindle 8 in the pedestal on the left, upon which a $\frac{3}{4}$ " contrate wheel is secured, engaging the $\frac{3}{4}$ " pinion 2. At the upper end of this spindle is mounted the balanced swinging arm carrying the propeller and aeroplane on its longer limb, and a balance weight on the short one. The operation of the crank will cause the propeller to revolve, and the aeroplane to travel.

Model No. 91. Signal Gantry

(MADE WITH MECCANO OUTFIT NO. 5 OR NO. 4 AND NO. 4A.)

*Parts required in addition
to Outfits.*

PARTS REQUIRED.

3	12½"	Perforated Strips	—	—	—	—
13	5½"	" "	7	—	—	—
16	3½"	" "	15	14	10	10
8	3"	" "	8	8	6	4
8		Angle Girders	8	4	—	—
33		Angle Brackets	21	17	7	—
1	5"	Rod	1	—	—	—
3	4½"	Rods	—	—	—	—
4	1"	Pulley Wheels	—	—	—	—
138		Nuts and Bolts	118	88	68	18
8		Clips	2	2	—	—
4		Large Rectangular Plates	3	3	2	2
5		Small Rectangular Plates	5	5	2	2

No. 1	No. 2	No. 3	No. 4
—	—	—	—
7	—	—	—
15	14	10	10
8	8	6	4
8	4	—	—
21	17	7	—
1	—	—	—
—	—	—	—
118	88	68	18
2	2	—	—
3	3	2	2
5	5	2	2

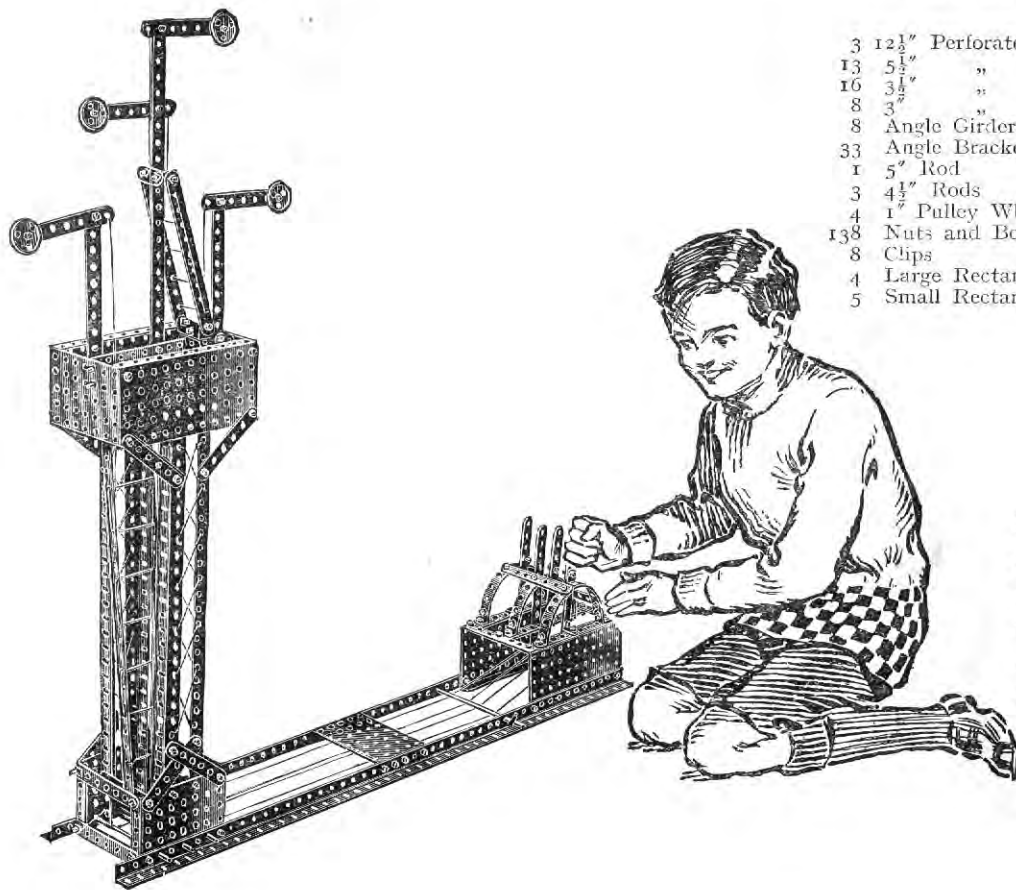

The gantry or upper signal box is made from two large and two small rectangular plates carrying the signal standards. Guide pulleys are pivoted in the base box round which pass the operating cords for the signal arms to the hand levers, shown to the right.

Model No. 92. Extended Tip

(MADE WITH MECCANO OUTFIT NO. 5 OR NO. 4 AND NO. 4A.)

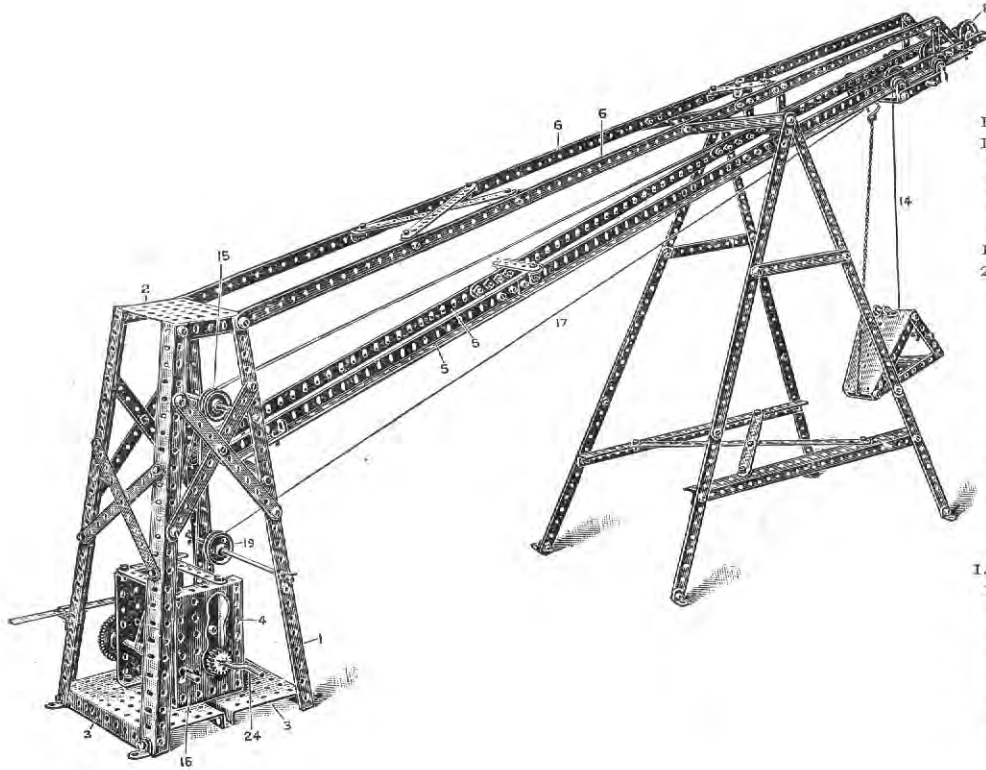

PARTS REQUIRED.

14	12 $\frac{1}{2}$ "	Perforated Strips
17	5 $\frac{1}{2}$ "	" "
7	3 $\frac{1}{2}$ "	" "
2	3	" "
8	2 $\frac{1}{2}$ "	" "
6	2 $\frac{2}{3}$ "	" "
12	12 $\frac{1}{2}$ "	Angle Girders
28		Angle Brackets
2	6"	Rods
1	5"	Rod
1	4 $\frac{1}{2}$ "	"
2	3 $\frac{1}{2}$ "	Rods
2		"
1		Crank Handle
1	1 $\frac{1}{2}$ "	Pulley Wheel
5	1 $\frac{1}{2}$ "	" Wheels
4	1 $\frac{1}{2}$ "	"
1	1 $\frac{3}{4}$ "	Pinion Wheel
1	1 $\frac{1}{2}$ "	"
2		Gear Wheels
1		Pawl
149		Nuts and Bolts
15		Clips
3		Collars and Set Screws
1		Small Chain
2		Single Bent Strips
2		Large Bent Strips
2		Large Rectangular Plates
3		Small " "
1		Eye Piece

Parts required in addition to Outfits.

No. 1	No. 2	No. 3	No. 4
10	4	4	—
11	1	—	—
6	5	1	1
2	2	—	—
—	—	—	—
6	6	6	6
12	8	4	4
16	12	2	—
2	2	2	—
1	—	—	—
—	—	—	—
—	—	—	—
—	—	—	—
—	—	—	—
4	4	3	3
1	1	—	—
1	1	—	—
1	1	—	—
2	2	1	1
1	1	—	—
124	99	79	39
9	9	7	3
3	3	—	—
1	1	1	1
1	1	1	1
2	2	1	1
2	2	1	1
1	1	—	—
3	3	—	—
1	1	1	—

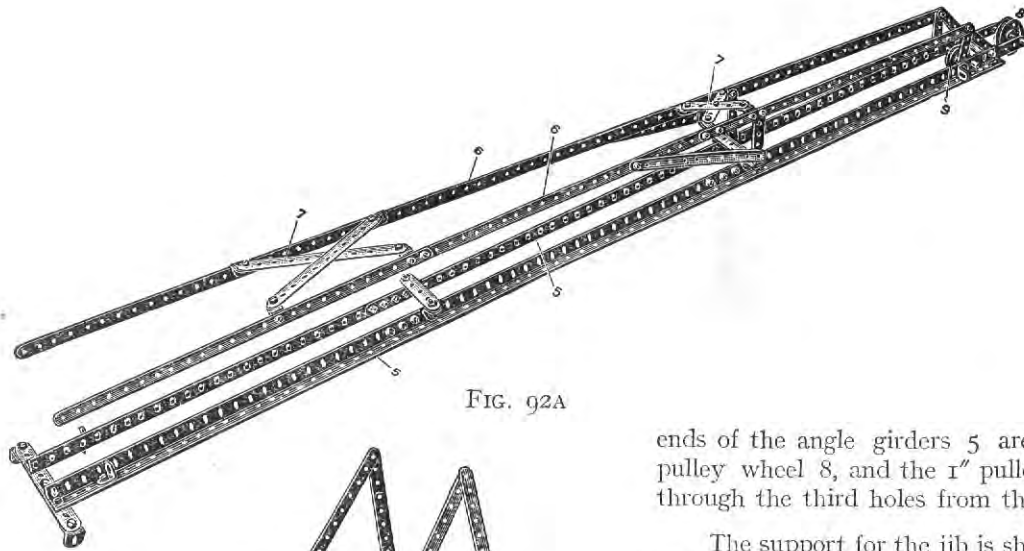

FIG. 92A



FIG. 92B

The main tower of the tip is made from four $12\frac{1}{2}$ " angle girders 1 bolted at the top to a small rectangular plate 2 and at the bottom to two large plates 3; the side plates 4 of the gear box being bolted to the rectangular base plates.

The jib, Fig. 92A, is made from sets of angle girders 5 butted together and coupled by strips, a pair of members 6 being formed from $12\frac{1}{2}$ " strips strengthened by diagonal ties 7. To the

ends of the angle girders 5 are bolted two $3\frac{1}{2}$ " strips to carry the $1\frac{1}{2}$ " pulley wheel 8, and the 1" pulley wheel 9 is carried on an axle passed through the third holes from the end of the angle girders.

The support for the jib is shown in Fig. 92B, and the jib is connected to this support by a $3\frac{1}{2}$ " perforated strip attached by angle brackets to the support and to the angle girders 5.

The trolley Fig. 92C carrying the tip bucket is made from two large bent strips 10, in the upper ends of which are lock-nutted $\frac{1}{2}$ " pulley wheels, the bent ends of the strips being connected by 3" strips 11, in one of the central holes of which is the axle 12 carrying the pulley 13 for the operating cord 14 of the tip bucket. This cord passes round the inner end pulley 9 and back to one of the pulleys 15 and then to the winding shaft 16. The cord 17 for traversing the trolley along the rails is continuous, being given a complete turn round the spindle 18, Fig. 92D, then round the pulley 19 to the trolley, and again from the trolley round the outer pulley 8 back over one of the pulleys 15 to the winding spindle 18.

The tip bucket, as will be seen from Fig. 92C, is made from two sector plates 20 bolted together at their lower edges, and coupled by $2\frac{1}{2}$ " strips at their upper ends; the bucket is supported by a single bent strip 21 engaging the axle passed through the strips. A slack chain 22 connects

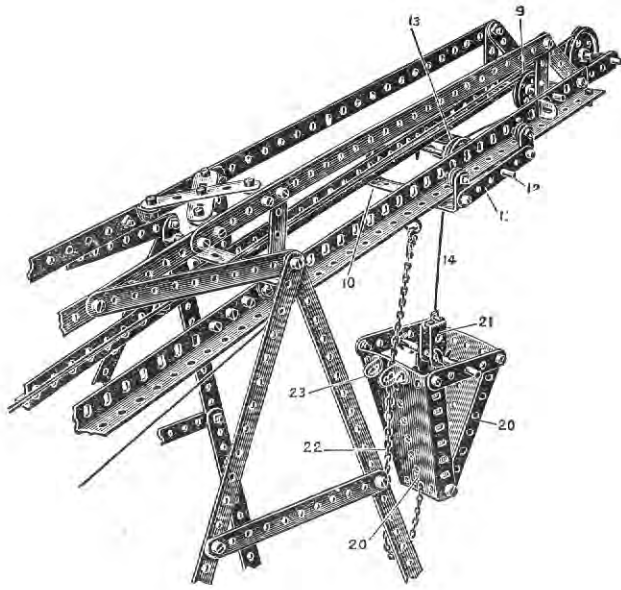

FIG. 92C

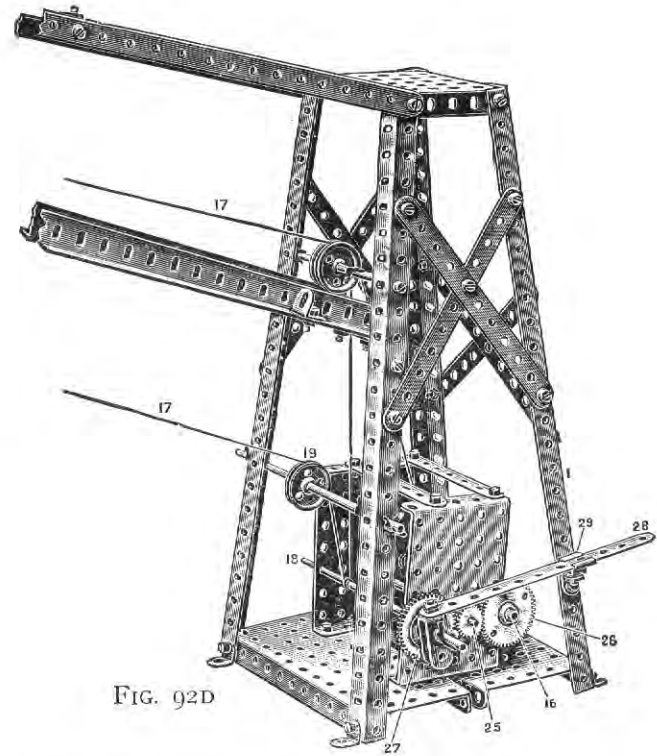

FIG. 92D

the lower end of the tip bucket to a hook on the trolley, the chain passing between angle brackets 23.

To tip the bucket, the cord 14 is lowered until the chain 22 becomes taut, further lowering of the cord 14 then allowing the bracket to swing over.

The cranked spindle 24 is provided at its opposite end with a pinion 25 which is permanently in gear with a $1\frac{1}{2}$ " gear wheel 26 on the spindle 16 controlling the hoisting cord 14. Another $1\frac{1}{2}$ " gear wheel 27 is mounted on the spindle 18 and is so controlled by the lever 28 that it may be thrown in or out of gear with the pinion 25. The lever 28 is supported in an eye piece 29 carried from the corner girder 1.

To cause the bucket trolley to traverse the rails without raising or lowering the bucket, the gear wheel 27 is engaged with the pinion 25, but to lift or lower the bucket, the gear wheel 27 is disengaged, the hoisting wheel 26 only being operated.

Model No. 93. Turn-table Crane

(MADE WITH MECCANO OUTFIT NO: 5 OR NO. 4 AND NO. 4A.)

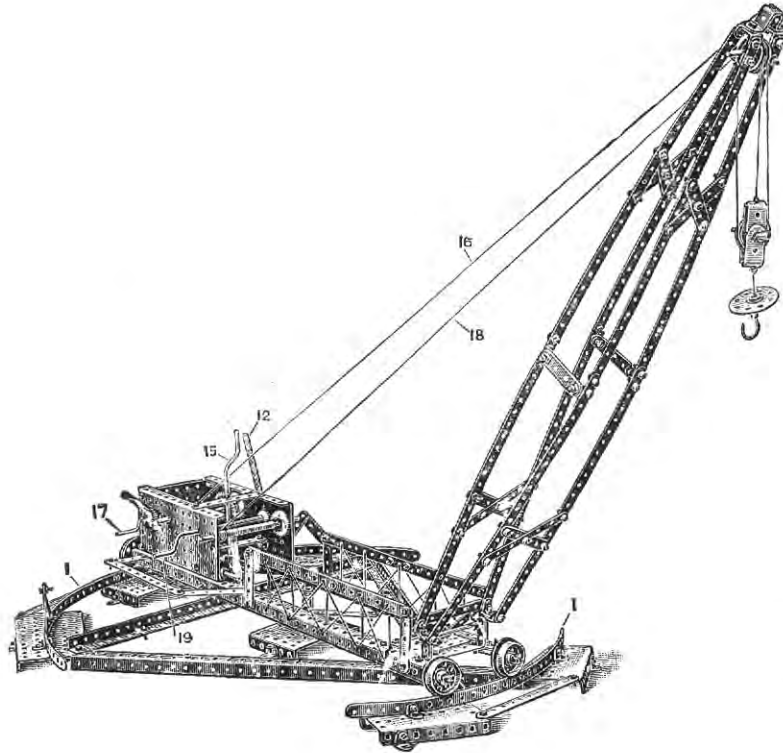

Parts required in addition to Outfits.

PARTS REQUIRED.		No. 1	No. 2	No. 3	No. 4
11	12 1/2" Perforated Strips	7	1	1	—
11	5 1/2" " "	5	—	—	—
7	3 1/2" " "	6	5	1	1
1	3" " "	1	1	—	—
12	2 1/2" " "	3	—	—	—
2	2 1/2" Bent Strips	—	—	—	—
3	2" " "	3	3	3	3
10	12 1/2" Angle Girders	10	6	2	2
45	Angle Brackets	33	31	21	9
1	6" Rod	1	1	1	—
4	5" Rods	4	1	—	—
2	4 1/2" " "	—	—	—	—
1	3 1/2" " "	1	1	1	1
2	2" " "	—	—	—	—
3	Crank Handles	2	2	1	—
5	Flanged Wheels	5	1	1	—
4	1" Pulley Wheels	—	—	—	—
1	Bush Wheel	—	—	—	—
2	3/4" Pinion Wheels	2	2	1	—
2	1 1/2" " "	2	2	—	—
2	Gear Wheels	2	2	1	1
1	1 1/2" Contrate Wheel	1	1	1	—
1	Pawl	1	1	—	—
13	Clips	7	7	5	1
4	Collars and Set Screws	4	4	—	—
152	Nuts and Bolts	132	102	82	32
1	Hook	—	—	—	—
2	Single Bent Strips	1	1	1	1
1	Double Bent Strip	1	—	—	—
1	Large " "	1	1	—	—
4	Large Rectangular Plates	3	3	2	2
5	Small " "	5	5	2	2
2	Sector Plates	—	—	—	—

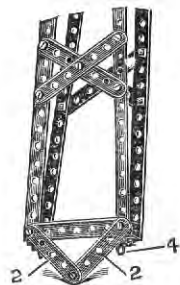

FIG. 93A

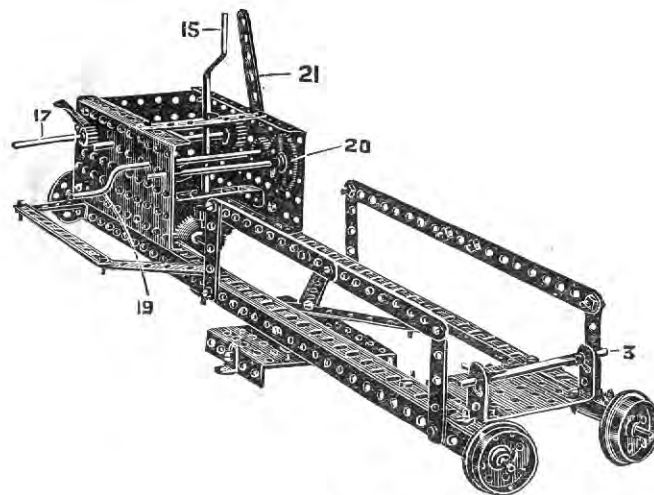

FIG. 93B

This crane, the jib of which is carried from a turn-table, swivels on the rails 1. The jib is braced as shown clearly in the general illustration, the lower part being fitted with diagonal strips 2, Fig. 93A, which act as a stop to limit the elevational movement of the jib, which swivels on the extremities of a $3\frac{1}{2}$ " axle rod 3, Fig. 93B, engaged by angle brackets 4 on the jib.

The circular rails 1 made of curved $12\frac{1}{2}$ " strips, Fig. 93C, supported on perforated plates 4 braced by angle girders 5 overlapped as shown.

The construction of the turn-table is shown in the inverted view, Fig. 93D, the side angle girders 6 being connected by perforated plates 7 and diagonal strips 8. The central hole of these strips 8 is pivotally connected by a bolt to the yoke piece 9 made of a large bent strip, the up-turned ends of which are bolted by angle brackets to a perforated plate 10. The platform swivels about this pivotal connection. The running flanged wheels 11 are mounted on radially placed rods 12, being carried in angle brackets bolted to the plates 7.

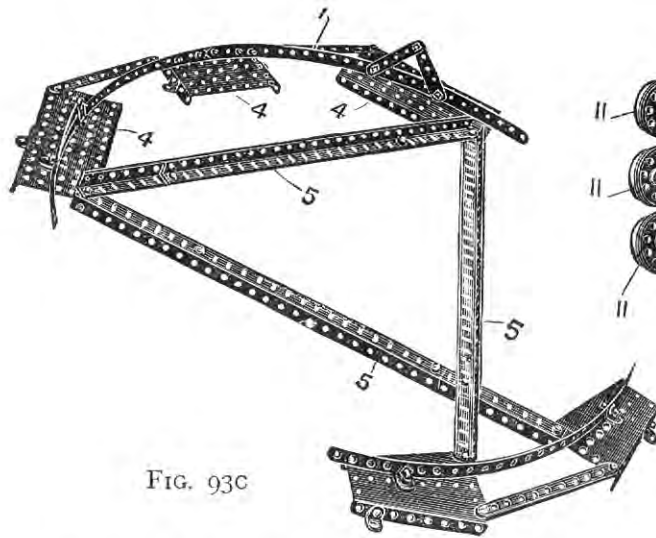

FIG. 93C

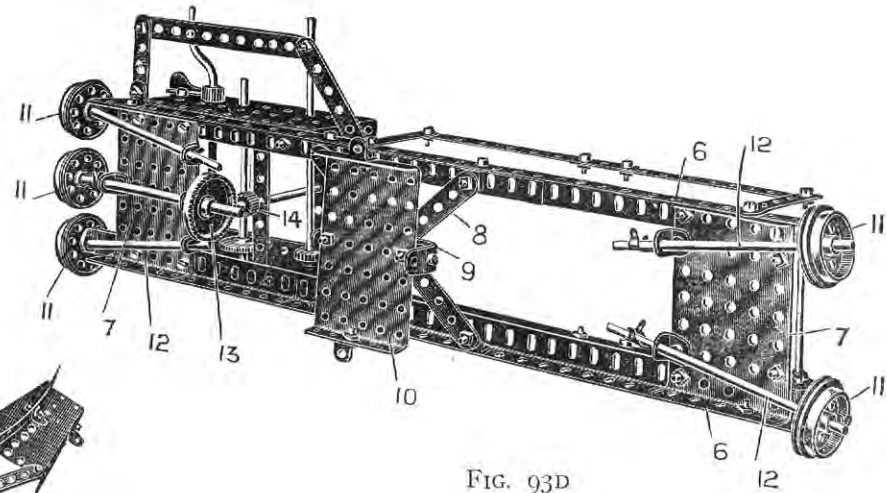

FIG. 93D

The central flanged wheel 11 is driven by the contrate wheel 13 engaged by the pinion 14 mounted on the cranked handle 15, see Fig. 93B. The jib is elevated by the operating cord 16 controlled by the crank handle 17; and the hoisting gear by the cord 18 controlled by the cranked handle 19 meshing by a $\frac{3}{4}$ " pinion with a gear wheel 20 on the winding spindle. The brake gear, the handle 21 of which is shown in the illustration, is similar to that shown in standard detail A.

HOW TO CONTINUE

This completes the models which may be made with MECCANO Outfit No. 5. The next models are a little more advanced, requiring a number of extra parts to construct them. The necessary parts are all contained in a No. 5a Accessory Outfit, the cost of which will be found in the Price List at the end of the Manual.

Model No. 100. Tower Bridge

(MADE WITH MECCANO OUTFIT NO. 6 OR NO. 5 AND NO. 5A.)

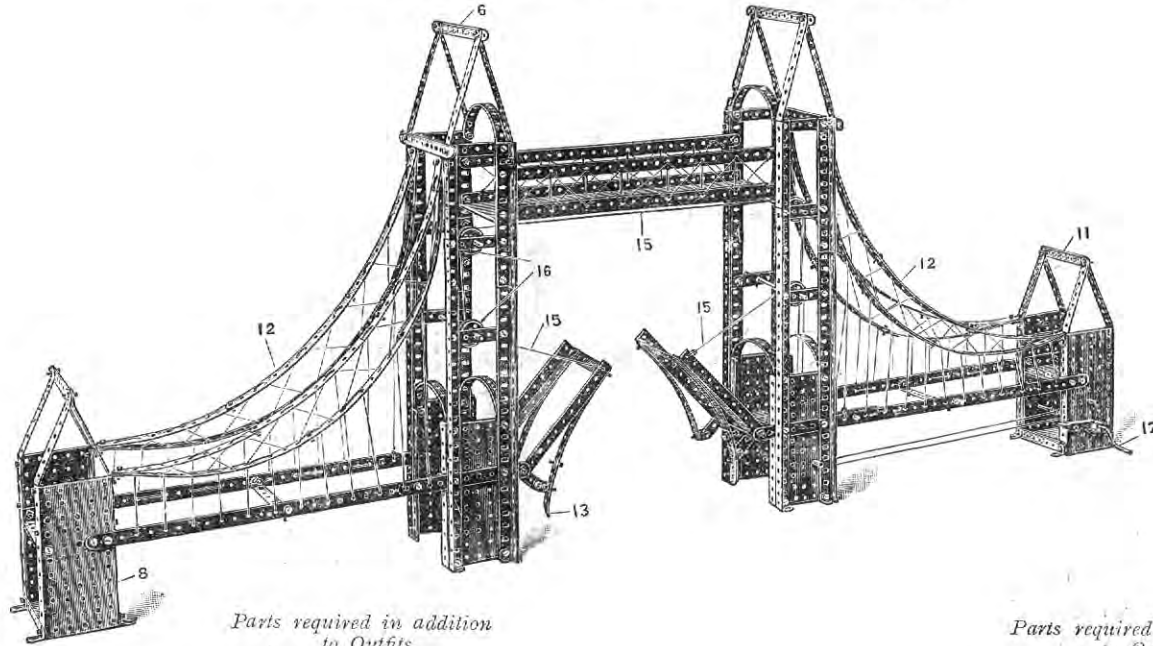

Parts required in addition to Outfits.

Parts required in addition to Outfits.

PARTS REQUIRED.

22	12 $\frac{1}{2}$ "	Perforated Strips
34	5 $\frac{1}{2}$ "	" "
12	3 $\frac{1}{2}$ "	" "
12	2 $\frac{3}{4}$ "	" "
10	12 $\frac{1}{2}$ "	Angle Girders
12	5 $\frac{1}{2}$ "	" "
28		Angle Brackets
4	5"	Rods
2	4 $\frac{1}{2}$ "	" "
1		Crank Handle
6	1"	Pulley Wheels

No. 1	No. 2	No. 3	No. 4	No. 5
18	12	12	8	8
28	18	16	14	10
11	10	6	6	—
3	—	—	—	—
10	6	2	2	1
12	12	12	12	12
16	14	4	—	—
4	1	—	—	—
—	—	—	—	—
—	—	—	—	—

PARTS REQUIRED.

1	3 $\frac{3}{4}$ "	Pinion Wheel
1	1 $\frac{1}{2}$ "	" "
1		Gear Wheel "
1		Pawl
183		Nuts and Bolts
9		Clips
1		Collar and Set Screw
2		Large Bent Strips
2		Springs
8		Large Rectangular Plates
4		Small " "

No. 1	No. 2	No. 3	No. 4	No. 5
1	1	—	—	—
1	1	—	—	—
1	1	—	—	—
1	1	—	—	—
163	133	113	63	23
3	3	1	—	—
—	—	—	—	—
2	2	1	1	—
2	2	2	1	1
7	7	6	6	4
4	4	1	1	—

Tower Bridge

Begin by making the two main towers, the construction of one of which is shown in Fig. 100A. The four uprights 1 are made of angle girders, connected at their lower extremities by large rectangular plates 2 and transverse strips 3. The sides of the tower are connected together by a small rectangular plate 4 across the top of which and at the top of the tower are bolted bent $5\frac{1}{2}$ " strips.

The top gable 6, constructed as shown, is then bolted at its lower edges 7 to the top of the uprights.

The short end towers, one of which is shown to the right of the figure, are built up from two large rectangular plates 8 connected together by a small rectangular plate 9 and two $3\frac{1}{2}$ " strips 10, the gable 11 being then bolted on top.

The catenary member 12 is built up from four curved $12\frac{1}{2}$ " strips overlapped, the lower member by 12 holes and the upper member by 15 holes, so as to produce a longer sweep in the lower member, and are bolted to the vertical angle girders of the higher towers, and by angle brackets to the shorter towers.

The bascules as illustrated in the left-hand corner of the picture are built up of two $5\frac{1}{2}$ " angle girders braced with transverse $3\frac{1}{2}$ " strips, and reinforced with bent $5\frac{1}{2}$ " strips, one of which is provided with a projecting $2\frac{1}{2}$ " strip 13, which bears against the main tower and acts as a stop when the bascules are horizontal. The bascules are hinged by fixing bolts in the end holes 14. The bascules are opened by the cords 15 passing over the guide pulleys 16, and are controlled by the extension spring 18, which normally acts to return them to their closed position. In the right smaller tower is the operating handle 17, on which is secured a $\frac{3}{4}$ " pinion meshed with a gear wheel on the spindle, on which the operating cords 15 are wound.

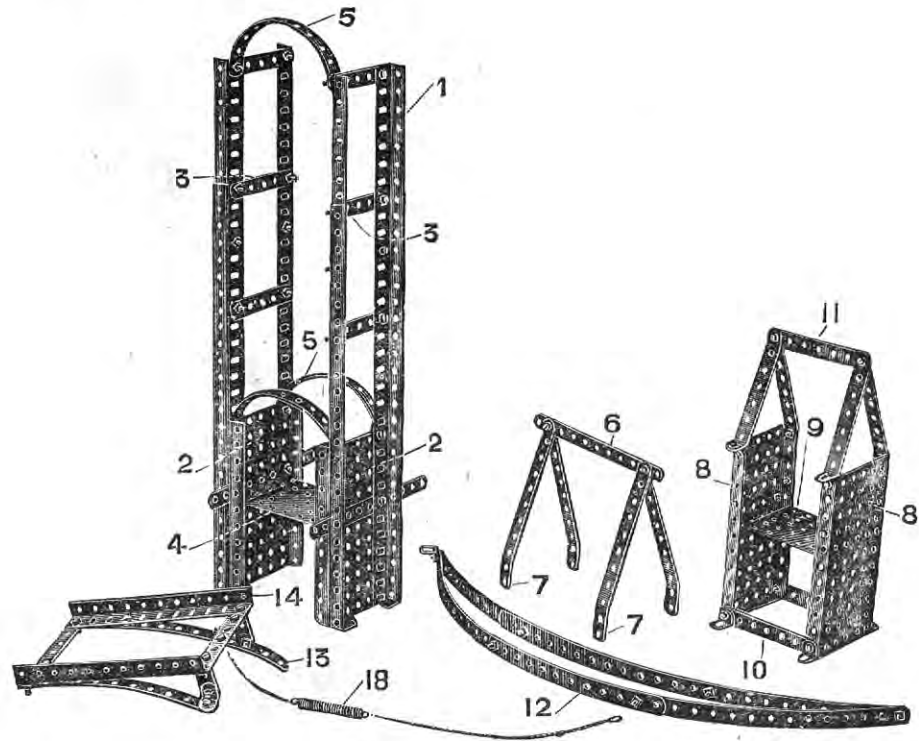

FIG. 100A

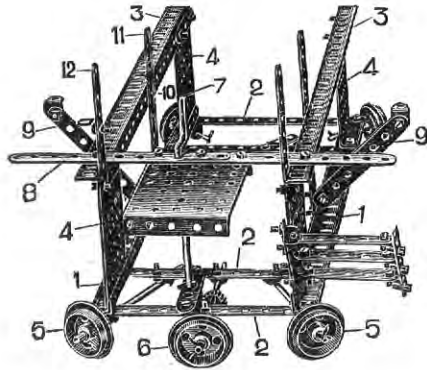

FIG. 101A

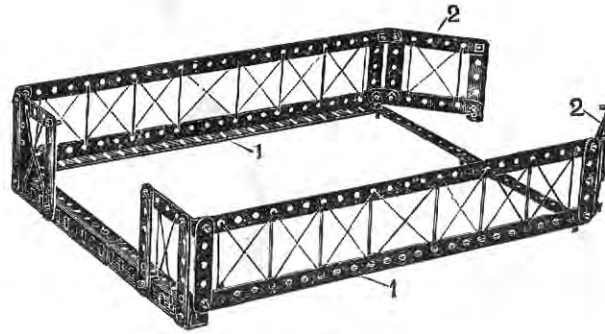

FIG. 101B

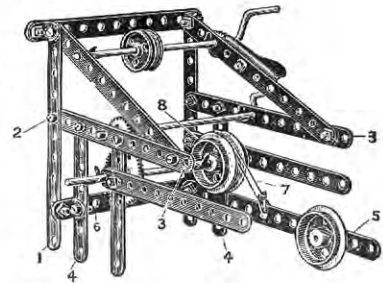

FIG. 101C

In constructing this model, begin by building up the lower wheel carriage Fig. 101A. As will be seen, this consists of two main angle girders 1 connected by four $5\frac{1}{2}$ " cross strips 2, the superstructure made from the upper angle girders 3 and vertical small rectangular plates 4 being then bolted to the lower girders 1. The extreme bolts in these lower girders carry two reversed angle brackets, which form the bearing for the spindles of the flanged wheels 5, the flanged pulley 6 running in bearings formed by angle brackets on the end cross strips being driven from the operating handle 7, carrying a worm engaging the pinion on the spindle of the driven wheel 6. Two $5\frac{1}{2}$ " strips 8 overlapped three holes form with the inclined $3\frac{1}{2}$ " strips 9 supports for the outer gallery frame, Fig. 101B. The outer ends of the inclined strips 9 and the cross strips 8 are bolted to the gallery frame.

The gallery frame, Fig. 101B, is built up of two $12\frac{1}{2}$ " angle girders 1 braced at one end with two $5\frac{1}{2}$ " angle girders overlapped three holes, and at the other end with two $5\frac{1}{2}$ " strips similarly overlapped. The end wings 2 are bolted in the extreme holes to the angle girders 3 in Fig. 101A.

The gear frame mechanism, Fig. 101C, may now be proceeded with, the framework of which is clearly shown in the illustration. The holes 1 and 2 are bolted to the corresponding holes 10 and 11 in the upright strips, Fig. 101A, the holes 3 being bolted to the top holes of the strips 12 in Fig. 101A. The lower holes 4 are bolted to the angle girders 3 in Fig. 101A.

The brake mechanism is effected by means of the weighted lever 5 pivoted in an angle bracket carried from the cross piece 6, the lever being provided with the brake cord 7 which passes over a pair of flanged pulleys 8 secured together on the winding spindle. The jib end pulley is shown in Fig. 101D, the operating cord being fastened to the suspended pulley frame passed round one of the jib pulleys, over the suspended pulley, and then over the other jib pulley to the hoisting spindle.

Model No. 102. Flip Flap

(MADE WITH MECCANO OUTFIT NO. 6 OR NO. 5 AND NO. 5A.)

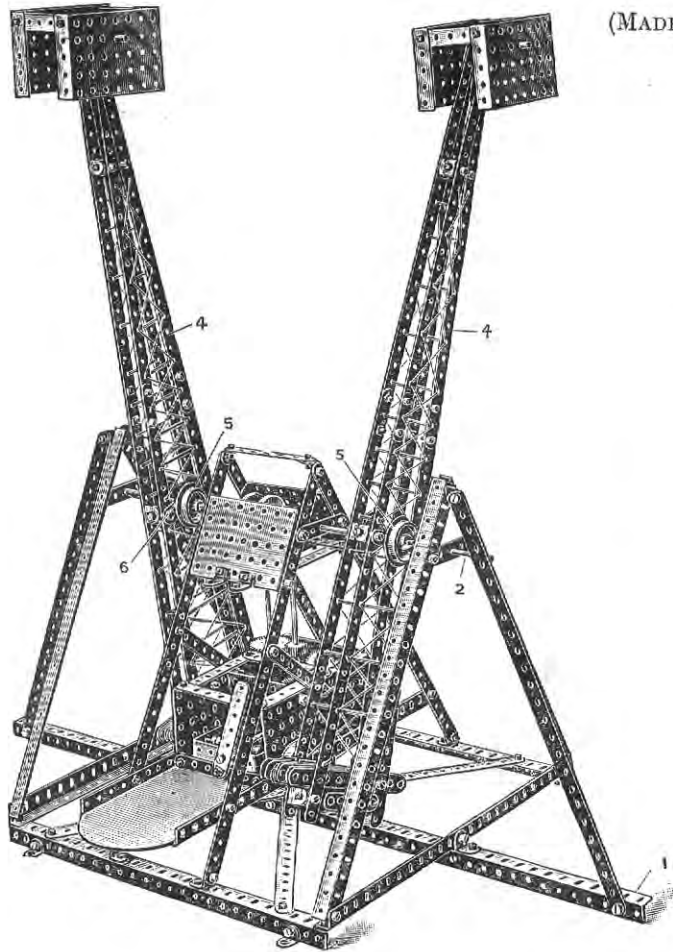

*Parts required in addition
to Outfits.*

PARTS REQUIRED.

24	12½"	Perforated Strips
4	5½"	" "
10	3½"	" "
12	2½"	" "
10	12½"	Angle Girders
1	5½"	" "
44		Angle Brackets
1	8"	Rod
2	6"	Rods
4	5"	" "
2	3½"	" "
4		Flanged Wheels
1	1½"	Pulley Wheel
3	¾"	Pinion Wheels
2	2"	" "
2		Gear Wheels
2	1½"	Contrate Wheels
2	¾"	" "
1		Worm Wheel
161		Nuts and Bolts
12		Clips
4		Collars and Set Screws
1		Large Bent Strip
2		Large Rectangular Plates
8		Small " "

No. 1	No. 2	No. 3	No. 4	No. 5
20	14	14	10	10
—	—	—	—	—
9	8	4	4	—
3	—	—	—	—
10	6	2	2	—
1	1	1	1	—
32	30	20	8	—
1	1	1	1	1
2	2	2	—	—
4	4	1	—	—
2	2	2	2	—
4	—	—	—	—
1	1	—	—	—
3	3	2	1	—
2	2	—	—	—
2	2	1	1	—
2	2	2	1	1
2	2	2	—	—
1	1	1	—	—
141	111	91	41	—
6	6	4	—	—
4	4	—	—	—
1	1	—	—	—
1	1	—	—	—
8	8	5	5	3

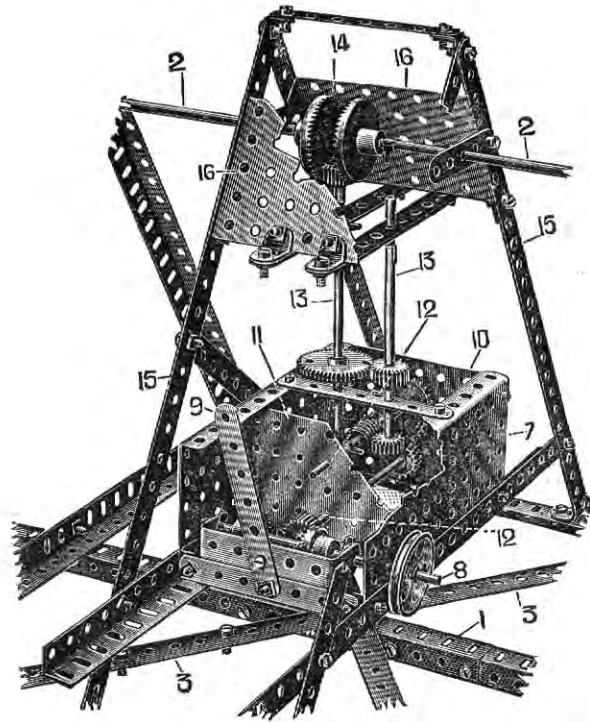

FIG. 102A

The construction of the arms and the main body of the supporting frame is clearly shown in the illustration. The main longitudinal rib 1 is made up from two angle girders butt jointed, not overlapped, the joint being strengthened with a 3" strip bolted through in every hole to the angle girders. By this means of butt-jointing the true alignment of the main axle 2 is secured.

The cross diagonal strips 3 of the base are formed by joining together $12\frac{1}{2}$ " and $5\frac{1}{2}$ " strips and overlapping them together for five holes.

The axle 2 is gripped to the arms 4 by means of the wheels 5 on either side of the arms, which are in turn secured to the arms by means of a pair of nuts and bolts in the wheels, the nuts binding against the short $2\frac{1}{2}$ " cross strip 6 on the arms;

Having constructed the main body of the supporting frame as above described, the operating gear cage, Fig. 102A, is now proceeded with. This is built up of large rectangular plates 7 forming a bearing for the driving spindle 8 operated by the clutch handle 9 and connected together by a small rectangular plate 10 and a similar mid plate 11. These two latter plates form bearings for the longitudinal spindle 12. The vertical spindles 13 drive the $1\frac{1}{2}$ " contrate wheels 14 on the main axles 2, the inclined $12\frac{1}{2}$ " strips 15 being connected near the contrate wheels by the small rectangular plates 16.

Model No. 103. Transporter Bridge

(MADE WITH MECCANO OUTFIT NO. 6 OR
NO. 5 AND NO. 5A.)

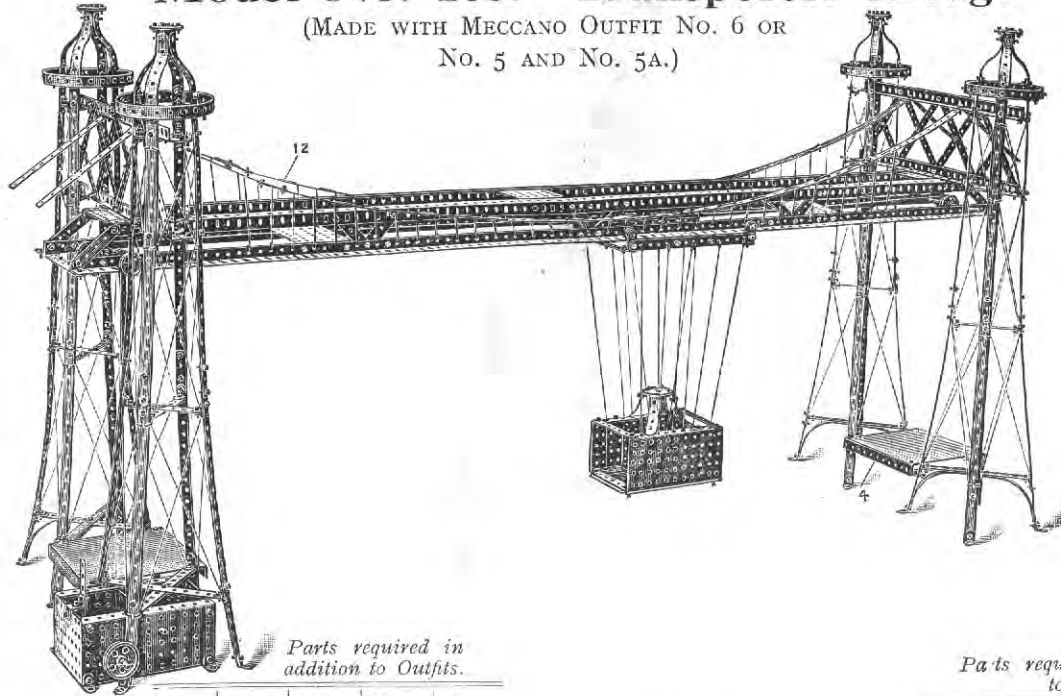

Parts required in
addition to Outfits.

PARTS REQUIRED.

	No. 1	No. 2	No. 3	No. 4	No. 5
46 12 $\frac{1}{2}$ " Perforated Strips	42	32	36	32	32
44 5 $\frac{1}{2}$ " " "	38	24	26	24	18
29 3 $\frac{1}{2}$ " " "	28	27	23	23	12
8 3" " "	8	8	6	4	—
20 2 $\frac{1}{2}$ " " "	11	8	8	2	—
16 2 $\frac{1}{4}$ " Bent Strips	12	10	10	10	—
20 12 $\frac{1}{2}$ " Angle Girders	20	16	12	12	8
10 5 $\frac{1}{2}$ " " "	10	10	10	10	10
118 Angle Brackets	106	104	94	82	65
1 6" Rod	1	1	1	—	—
2 5" Rods	2	—	—	—	—
3 4 $\frac{1}{2}$ " " "	—	—	—	—	—
1 1 $\frac{1}{2}$ " Pulley Wheel	1	1	—	—	—
4 1" " "	—	—	—	—	—
4 1 $\frac{1}{2}$ " " "	4	4	3	3	—

Parts required in addition
to Outfits.

PARTS REQUIRED.

	No. 1	No. 2	No. 3	No. 4	No. 5
5 Bush Wheels	4	4	4	3	3
2 $\frac{3}{4}$ " Pinion Wheels	2	2	1	—	—
1 1 $\frac{1}{2}$ " Pinion Wheel	1	1	—	—	—
1 Gear Wheel	1	1	—	—	—
2 $\frac{3}{4}$ " Contrate Wheels	2	2	2	—	—
1 Worm Wheel	1	1	—	—	—
441 Nuts and Bolts	421	391	371	321	281
8 Clips	2	2	—	—	—
4 Collars and Set Screws	4	4	—	—	—
1 Large Bent Strip	1	1	—	—	—
4 Large Rectangular Plates	3	3	2	2	—
8 Small " "	8	8	5	5	3

In the construction of this model begin by taking two $5\frac{1}{2}$ " strips to form the base portion of each tower. Four curved $5\frac{1}{2}$ " strips are now bolted to the centre of the cross, and bent down to form an attachment for the vertical members 1. At the top of the first $12\frac{1}{2}$ " strip forming the vertical brace, cross strips $3\frac{1}{2}$ " long are now connected by angle brackets. Further $12\frac{1}{2}$ " strips are overlapped on the lower strips, which carry the construction to the crown 2 of the tower, which is made of $3\frac{1}{2}$ " curved strips. The gallery is formed of a $12\frac{1}{2}$ " strip, bent round and secured by angle brackets to the uprights.

The towers are connected at their base by $5\frac{1}{2}$ " angle girders 4 bolted to the angle brackets 3 and at their upper parts by the braced girders 5. The $12\frac{1}{2}$ " angle girders 6 are bolted to the cross strips 7 on the towers in the third hole from the end.

The construction of the main girder is as follows :—

The side frames are built up of four $12\frac{1}{2}$ " angle girders 8 butted together and reinforced at the joints by $5\frac{1}{2}$ " angle girders. The upper elements are constructed of four $12\frac{1}{2}$ " angle girders 9 each overlapped two holes. Small rectangular plates 10 and upper small rectangular plates 11 are bolted to the lower and upper elements respectively. The end upper plates 11 are bolted to the lower angle girders of the braced elements 5.

Fig. 103D shows the construction of the cage, which is built up of side rectangular plates 1 connected across by four $3\frac{1}{2}$ " strips 2. The carrier frame, Fig. 103E, is made of two $5\frac{1}{2}$ " strips overlapped eight holes and bent up to form the brackets on which the trolley wheels are bolted. The runners 3 carried in the bent-up ends of the end members 4 are made to run freely on the shank of the bolts by providing lock nuts on the inside and outside of the turned-up ends of the strips 4.

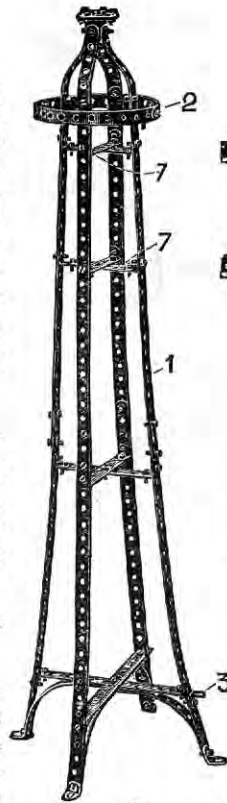

FIG 103A

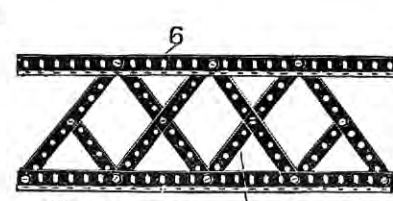

FIG. 103B

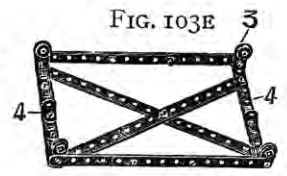

FIG. 103E

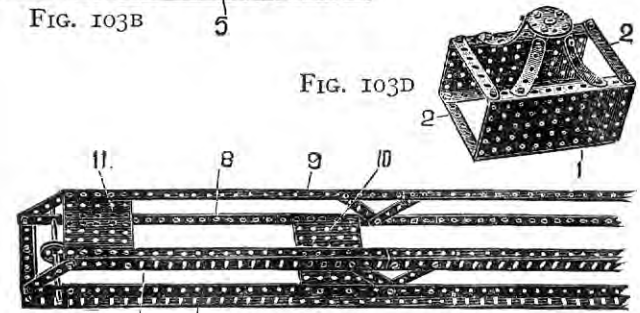

FIG. 103C



FIG. 103D

Model No. 104. Transporter Bridge

(MADE WITH MECCANO OUTFIT NO. 6 OR NO. 5 AND NO. 5A.)

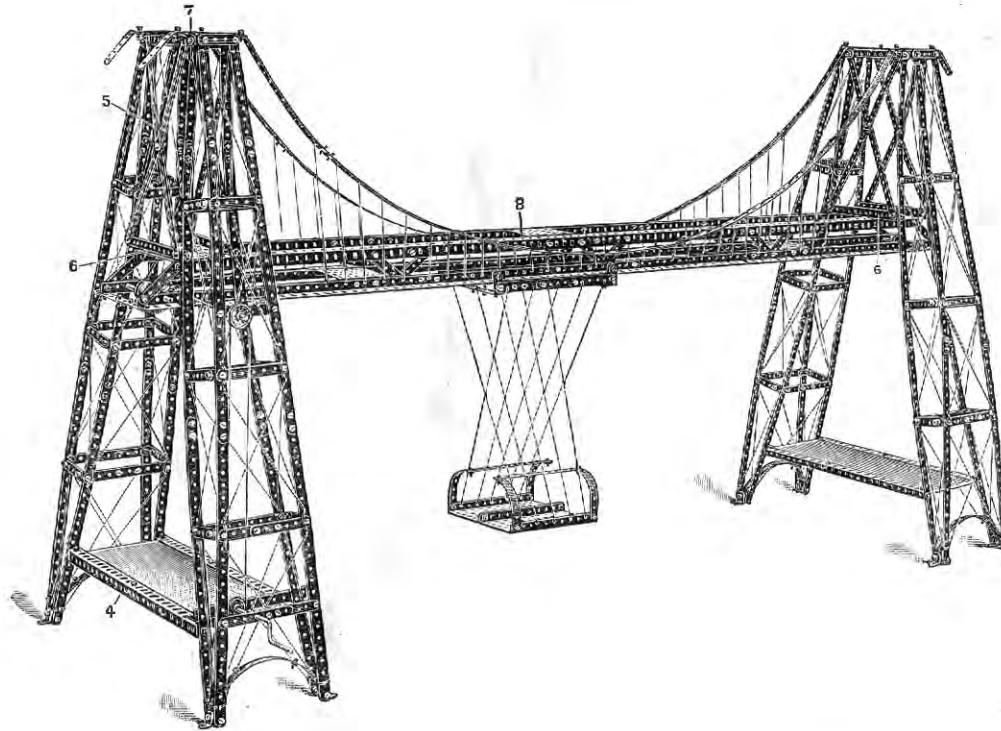

*Parts required in addition to
Outfits.*

PARTS REQUIRED.			No. 1	No. 2	No. 3	No. 4	No. 5
42	12½"	Perforated Strips	36	32	32	28	28
56	5½"	" "	50	40	38	36	30
12	3½"	" "	11	10	6	6	—
23	3"	" "	23	23	21	19	15
24	2½"	" "	15	12	12	6	—
24	2"	" "	24	24	24	24	18
8	2½"	Bent Strips	4	2	2	2	—
20	12½"	Angle Girders	20	16	12	12	8
11	5½"	" "	11	11	11	11	11
104	Angle Brackets		92	90	80	68	51
1	11½"	Rod	1	1	1	—	—
2	4½"	Rods	—	—	—	—	—
1		Crank Handle	—	—	—	—	—
4	1"	Pulley Wheels	—	—	—	—	—
4	4"	" "	4	4	3	3	—
1	1"	Pinion Wheel	1	1	—	—	—
1		Gear Wheel	1	1	—	—	—
381		Nuts and Bolts	361	331	311	261	221
4		Clips	6	4	—	—	—
3		Collars and Set Screws	3	3	—	—	—
2		Large Rectangular Plates	1	1	—	—	—
5		Small " "	5	5	2	2	—

The main girder in this model calls for no particular description, being constructed similarly to that previously described.

The end towers, Fig. 104A, are each made up of a pair of side girders composed of perforated strips 1 bowed at the centres and distanced by the short strips 2 and transverse strips 3. These side girders are connected at their lower ends by 12½" angle girders 4 and at their upper parts by the inclined 5½" strips 5, transverse 5½" angle girders 6 and upper 5½" strips 7. The end rectangular plates of the main girder 8 are bolted to the angle girders 6 of the towers.

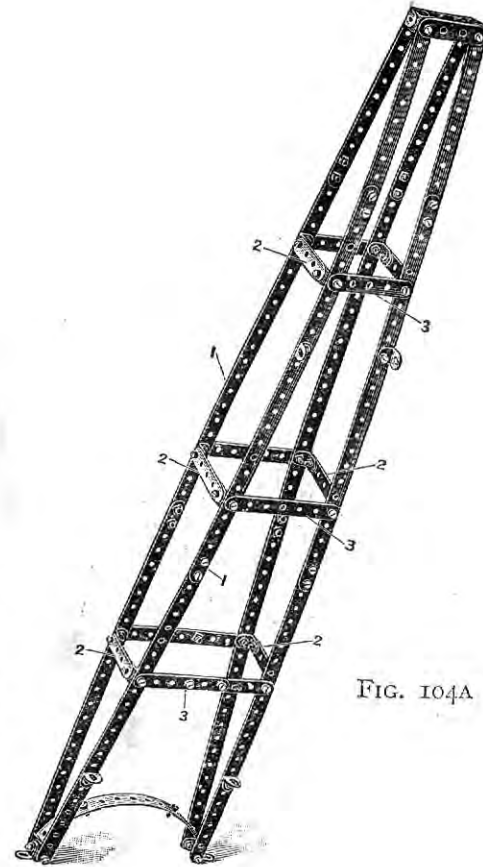
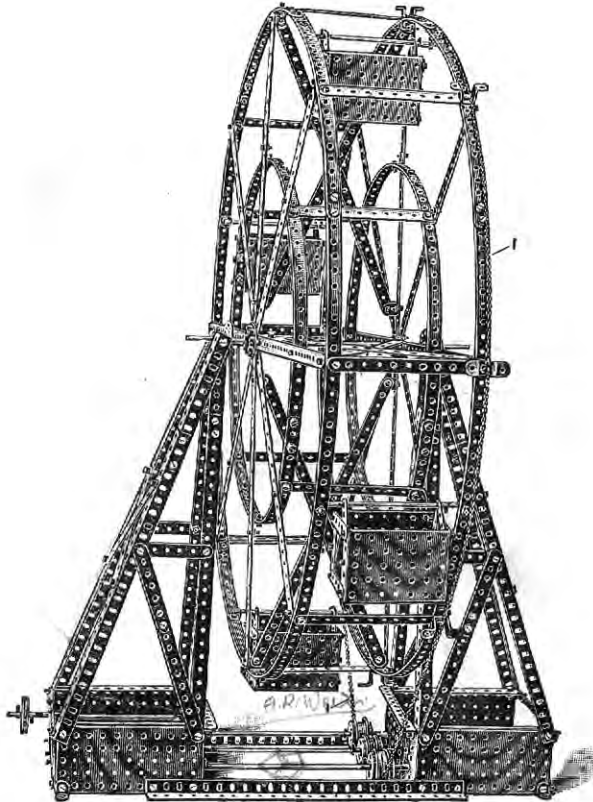

FIG. 104A

Model No. 105. Big Wheel

(MADE WITH MECCANO OUTFIT NO. 6 OR NO. 5 AND NO. 5A.)



*Parts required in addition to
Outfits.*

PARTS REQUIRED.		No. 1	No. 2	No. 3	No. 4	No. 5
46	12 $\frac{1}{2}$ " Perforated Strips	42	36	36	32	32
24	5 $\frac{1}{2}$ " " "	18	8	6	4	—
4	3 $\frac{1}{2}$ " " "	3	2	—	—	—
4	3 " " "	4	4	2	—	—
34	2 $\frac{1}{2}$ " " " "	25	22	22	16	—
10	12 $\frac{1}{2}$ " Angle Girders	10	6	2	2	1
4	5 $\frac{1}{2}$ " " "	4	4	4	4	4
68	Angle Brackets	55	51	44	32	15
4	11 $\frac{1}{2}$ " Rods	4	4	4	2	2
1	8" Rod	1	1	1	1	1
1	6" "	1	1	1	—	—
4	5" Rods	4	1	—	—	—
6	Flanged Wheels	6	2	2	—	—
1	1 $\frac{1}{2}$ " Pulley Wheel	1	1	—	—	—
4	Bush Wheels	3	3	3	2	2
2	$\frac{3}{4}$ " Pinion Wheels	2	2	1	—	—
2	Gear Wheels	2	2	1	1	—
292	Nuts and Bolts	272	242	222	172	132
12	Clips	6	6	4	—	—
4	Collars and Set Screws	4	4	—	—	—
1	Length of Chain	1	1	1	1	1
8	Double Bent Strips	8	7	7	7	7
6	Large Rectangular Plates	5	5	4	4	2
8	Small Rectangular Plates	8	8	5	5	3
2	Sector Plates	—	—	—	—	—

In constructing this model advantage is taken of the new rectangular perforated plates now issued with the Meccano Outfits to form the sides and inner part of the base of the side pedestals and also to form the suspended cages on the wheel.

The driving chain is conveniently kept in position round the periphery of one of the side elements of the wheel by a series of double bent strips bolted on the ends of the spokes.

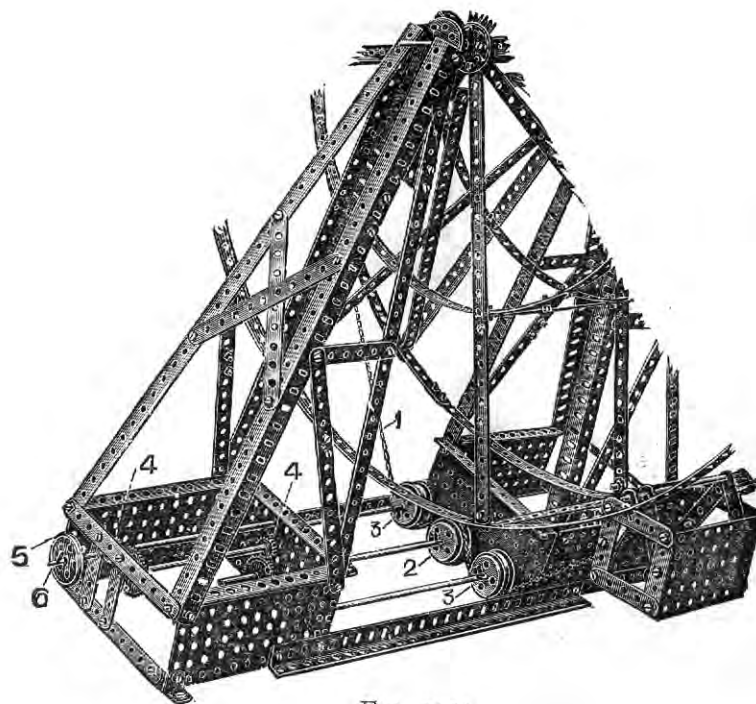
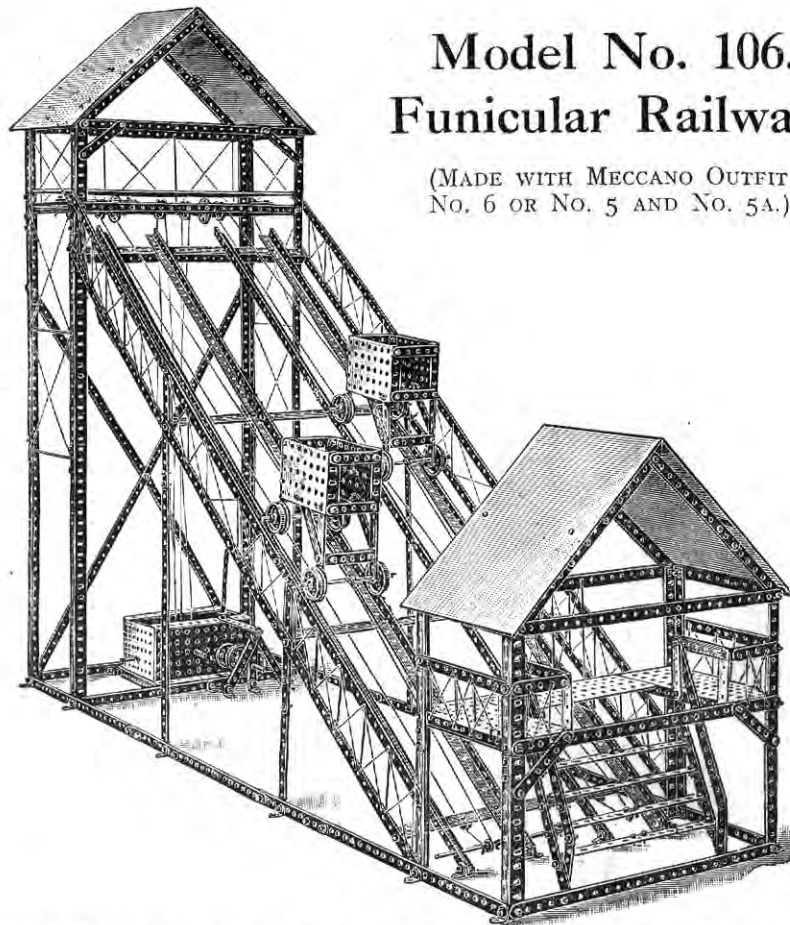

FIG. 105A

In Fig. 105A is shown how the driving chain 1, passing round the driving wheel 2, is held around the circumference thereof by the guide wheels 3. The driving wheel 2 is driven through the gear wheel 4 from a $1\frac{1}{2}$ " pulley wheel 5 carried on the spindle 6.

Model No. 106. Funicular Railway

(MADE WITH MECCANO OUTFIT
NO. 6 OR NO. 5 AND NO. 5A.)



are bolted the latticed side rails 8 supported by the vertical members 9. The $\frac{1}{2}$ " pulleys 10 are bolted by angle brackets to the lower strip 7, and on the transverse spindle 11 opposite these pulleys are secured further $\frac{1}{2}$ " pulleys 12. The ropes for hauling the wagons pass round these lower pulleys 10 and 11, and the pulleys 13 in the upper gear platform of the tower Fig. 106A. The loading platform Fig. 106c is built up from $12\frac{1}{2}$ " girder strips 14 to which are bolted side rectangular plates 15 which are again connected by two small rectangular plates 16. The other constructional details of this loading tower should present no trouble.

The main tower Fig. 106A, inclined rails Fig. 106B, and loading platform Fig. 106c are now coupled together by a series of horizontal $12\frac{1}{2}$ " strips 16 overlapped as shown. The wagons Fig. 106D are made as follows: Two small rectangular plates 17 are connected top and bottom by $2\frac{1}{2}$ " strips 18. The journals for the front axle 19 are made by two $3\frac{1}{2}$ " strips bolted inside the rectangular plates, the axle being threaded through their lower projecting holes. The rear axle journals are made by carrying down two $3\frac{1}{2}$ " strips 20 bolted in their upper holes to the rectangular plates, and braced with the diagonal strips 21 to the sides of the wagon. The axle 22 is again threaded through the lowest holes. One end of the operating cord 23 as shown in this view is secured to this rear axle; the other end, after passing round the pulleys as previously explained, being secured to the front axle 19. The gear box for operating the main hauling shaft 24 is very fully shown in Fig. 106E; the operating cords from the pulleys 25 passing up round the pulleys 26.

The Gear Box is mounted on two perforated plates 27, the angle brackets on which are bolted to the transverse strips 28 at the base of the tower Fig. 106A.

PARTS REQUIRED.

38	$12\frac{1}{2}$ "	Perforated Strips
49	$5\frac{1}{2}$ "	" "
17	$3\frac{1}{2}$ "	" "
23	3"	" "
14	$2\frac{1}{2}$ "	" "
2	$2\frac{1}{2}$ "	Bent Strips
23	$12\frac{1}{2}$ "	Angle Girders
12	$5\frac{1}{2}$ "	" "
84		Angle Brackets
1	$11\frac{1}{2}$ "	Rod
1	8"	" "
4	6"	Rods
2	5"	" "
4	$4\frac{1}{2}$ "	" "
8		Flanged Wheels
1	$1\frac{1}{2}$ "	Pulley Wheel
6	1"	Pulley Wheels
4	$\frac{1}{2}$ "	" "
3		Bush Wheels
3	$\frac{3}{4}$ "	Pinion Wheels
1	$1\frac{1}{2}$ "	Pinion Wheel
2		Gear Wheels
2	$\frac{3}{4}$ "	Contrate Wheels
1		Worm Wheel
413		Nuts and Bolts
14		Clips
4		Collars and Set Screws
1		Double Bent Strip
1		Large " " "
6		Large Rectangular Plates
8		Small " " "

Parts required in addition to Outfits.

No. 1	No. 2	No. 3	No. 4	No. 5
34	28	28	24	24
43	33	31	29	23
16	15	11	11	—
23	23	21	19	15
5	2	2	—	—
—	—	—	—	—
23	19	15	15	11
12	12	12	12	12
72	70	60	48	31
1	1	1	—	—
1	1	1	1	1
4	4	4	2	—
2	2	—	—	—
1	1	1	1	1
8	4	4	—	—
1	1	—	—	—
—	—	—	—	—
4	4	3	3	—
2	2	2	1	1
3	3	2	1	—
1	1	—	—	—
2	2	1	1	—
2	2	2	—	—
1	1	—	—	—
393	363	343	293	253
8	8	6	2	—
4	4	—	—	—
1	—	—	—	—
1	1	—	—	—
5	5	4	4	2
8	8	5	5	3

Begin by constructing the main tower Fig. 106A, the corner pillars 2 of which are made from two $12\frac{1}{2}$ " angle girders and a $5\frac{1}{2}$ " angle girder; the $12\frac{1}{2}$ " girders overlapped three holes and the $5\frac{1}{2}$ " girders two holes. The long tie strips 1 are $12\frac{1}{2}$ ", and the short side tie strips $3\frac{1}{2}$ ". The rear diagonal ties 4 are made from $12\frac{1}{2}$ " strips overlapped. The roof rafters 5 consist of $5\frac{1}{2}$ " strips overlapped five holes.

The arrangement of the gear in the upper platform of this tower is well shown in the detail Fig. 106F. The inclined rails 5 Fig. 106B are made from 4 sets of $12\frac{1}{2}$ " angle girders, butted together and connected by 3" strips. The rails rest on three upper crossing $12\frac{1}{2}$ " angle girders 6, and a lower $12\frac{1}{2}$ " strip 7 to the ends of which

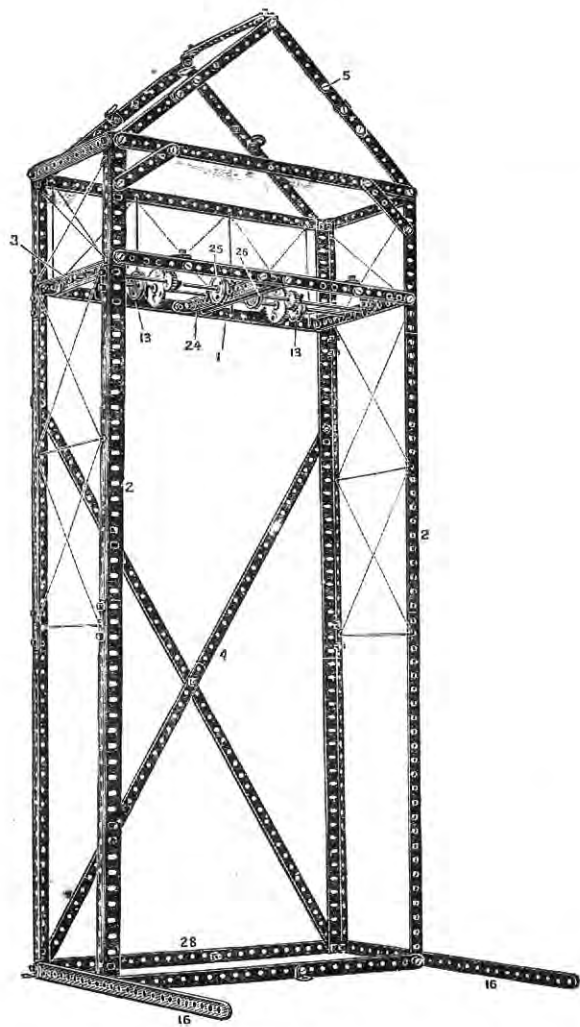

FIG. 106A

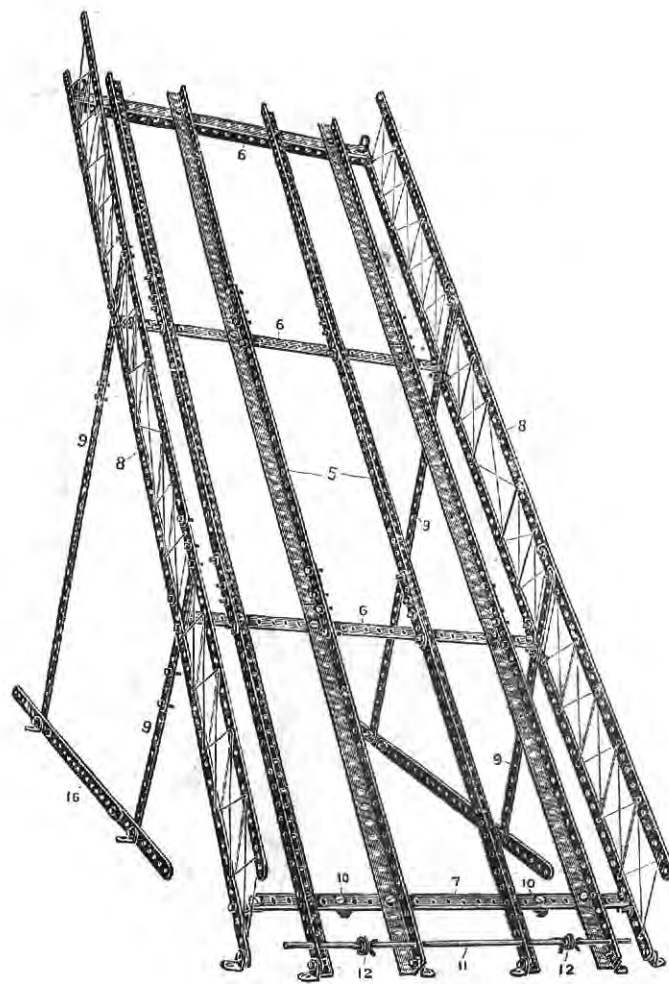

FIG. 106B

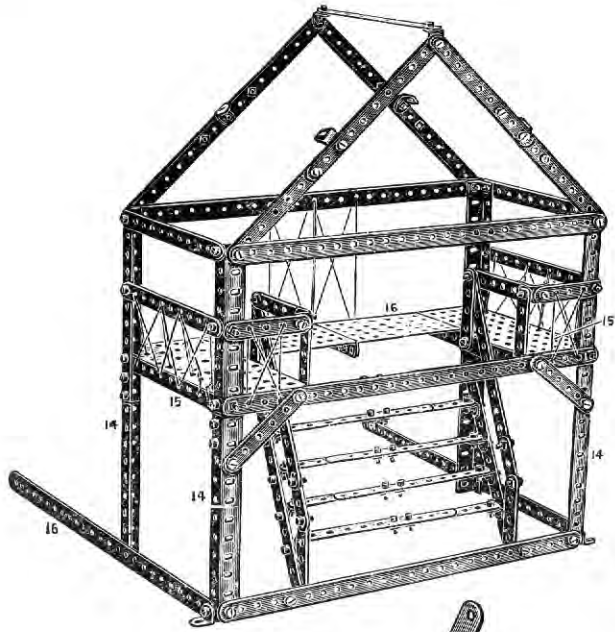

FIG. 106C

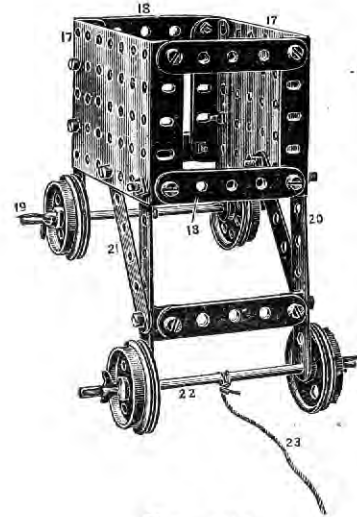

FIG. 106D

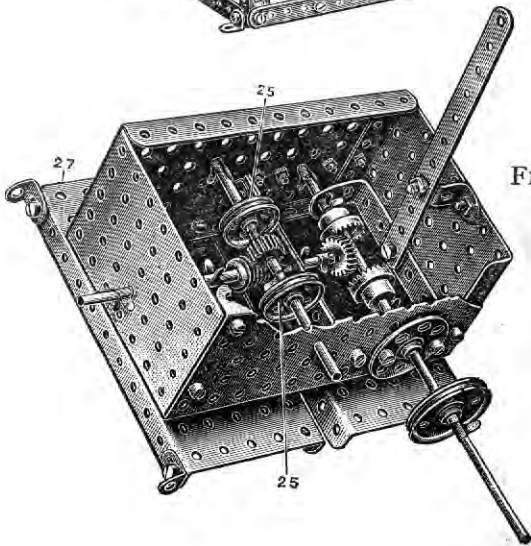

FIG. 106E

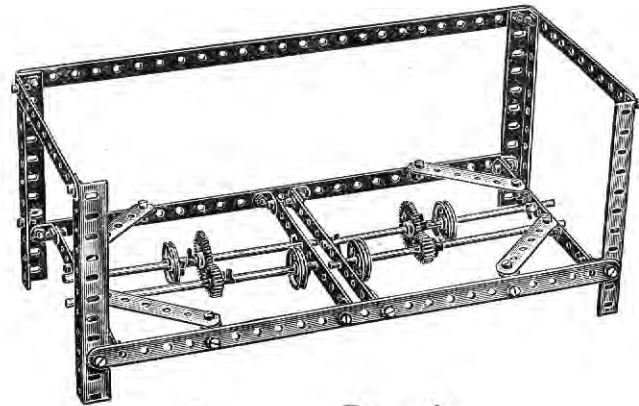
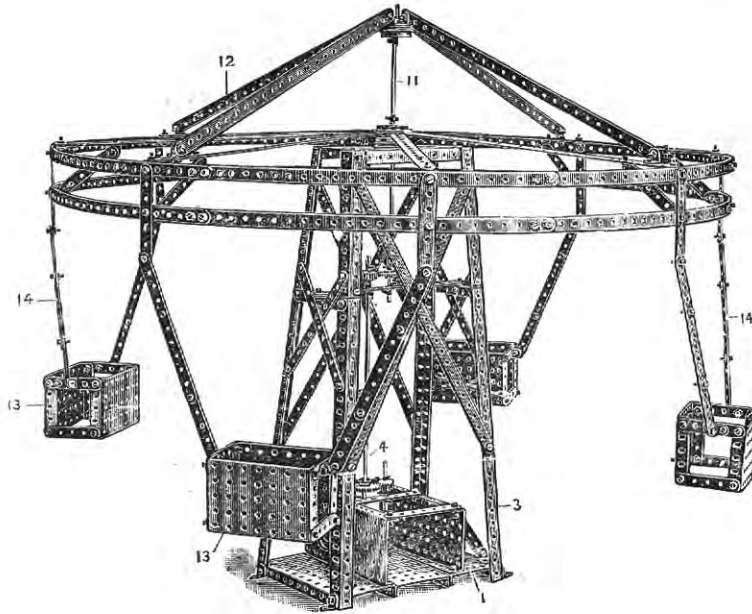

FIG. 106F

Model No. 107. Roundabout

(MADE WITH MECCANO OUTFIT No. 6 OR No. 5 AND No. 5A.)



PARTS REQUIRED.

34	12 $\frac{1}{2}$ "	Perforated Strips
22	5 $\frac{3}{8}$ "	" "
13	3 $\frac{1}{2}$ "	" "
4	3"	" "
16	2 $\frac{3}{8}$ "	" "
4	12 $\frac{1}{2}$ "	Angle Girders
4	5 $\frac{1}{2}$ "	" "
44		Angle Brackets "
2	11 $\frac{1}{2}$ "	Rods
1	6"	" "
1	4 $\frac{1}{2}$ "	" "
1	1 $\frac{1}{2}$ "	Pulley Wheel
1	1"	" "
2		Bush Wheels
2	$\frac{3}{8}$ "	Pinion Wheels
1	1 $\frac{1}{2}$ "	" "
2		Gear Wheels
1		Worm Wheel
235		Nuts and Bolts
4		Collars and Set Screws
6		Large Rectangular Plates
8		Small Rectangular Plates

*Parts required in addition to
Outfits.*

No. 1	No. 2	No. 3	No. 4	No. 5
30	24	24	20	20
16	6	4	2	—
12	11	9	9	—
4	4	2	—	—
7	4	4	—	—
4	—	—	—	—
4	4	4	4	4
32	30	20	8	—
2	2	2	—	—
1	1	1	—	—
—	—	—	—	—
1	1	—	—	—
—	—	—	—	—
2	2	1	—	—
1	1	—	—	—
2	2	1	1	—
1	1	—	—	—
215	185	165	115	75
4	4	—	—	—
5	5	4	4	2
8	8	5	5	3

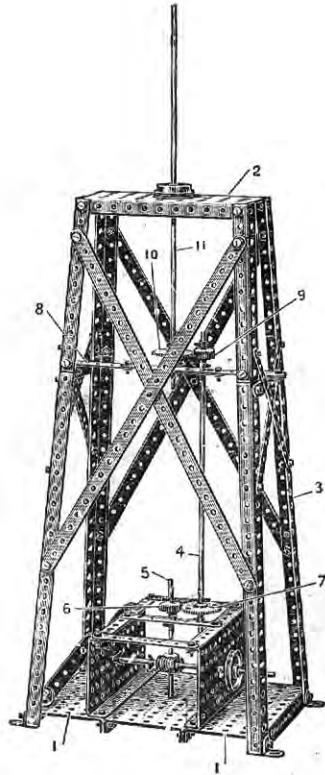

FIG. 107A

Begin by constructing the central tower, Fig. 107A, the base of which consists of three large rectangular plates 1 bolted at their flanges, and the top of one large rectangular plate 2, the corners 3 being each made of a $12\frac{1}{2}$ " angle girder and a $5\frac{1}{2}$ " angle girder overlapped two holes.

The side walls of the lower gear boxes also consist of large rectangular plates, connected across the top by $3\frac{1}{2}$ " strips, the middle one of which forms the bearings for the vertical spindles 4 and 5 connected by a $\frac{3}{4}$ " pinion and gear wheel 6 and 7. The upper end of spindle 4 is journaled in a cross strip 8 and coupled by a $\frac{3}{4}$ " pinion 9 to a gear wheel 10 secured to the spindle 11.

The cross strip 8 is formed by two $5\frac{1}{2}$ " strips overlapped seven holes, and supported at each side of the tower by $3\frac{1}{2}$ " strips.

The ringed frame is made of seven $12\frac{1}{2}$ " strips overlapped two holes, and assembled together quite straight, the outer ends being then bolted together and overlapped three holes. The strips will assume a perfectly circular shape without special bending. The diagonal strips 12 are then bolted to the ringed frame in the third hole from the edge, and a bush wheel secured on the spindle 11. Four radial strips are also bolted to the frame and the lower bush wheel.

The cages 13 are made from small rectangular plates connected across by $2\frac{1}{2}$ " strips, and are supported from the ringed frame by overlapped $5\frac{1}{2}$ " strips 14 as shown.

The other constructional details of the model are very clearly brought out in the illustration.

Model No. 108. Eiffel Tower.

(MADE WITH MECCANO OUTFIT NO. 6 OR NO. 5 AND NO. 5A.)

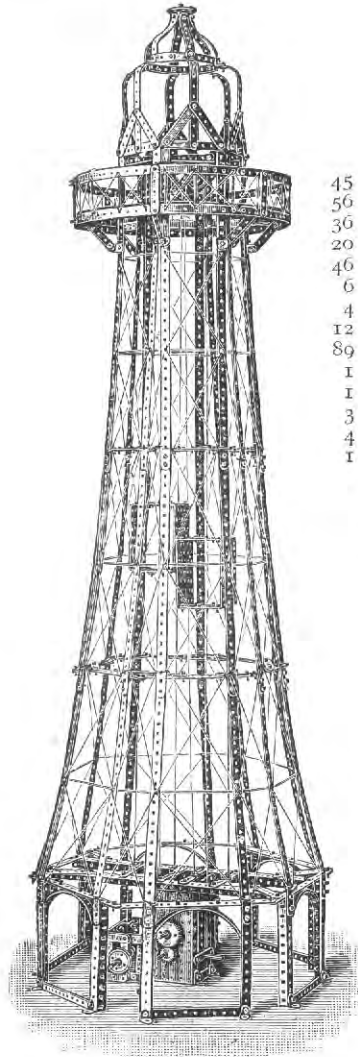

Parts required in addition to
Outfits.

Parts required in addition to
Outfits.

PARTS REQUIRED.	Parts required in addition to Outfits.					PARTS REQUIRED.	Parts required in addition to Outfits.				
	No. 1	No. 2	No. 3	No. 4	No. 5		No. 1	No. 2	No. 3	No. 4	No. 5
45 12 $\frac{1}{2}$ " Perforated Strips	41	35	35	31	31	5 1" Pulley Wheels	—	—	—	—	—
56 5 $\frac{1}{2}$ " " "	50	40	38	36	30	1 Bush Wheel	—	—	—	—	—
36 3 $\frac{1}{2}$ " " "	35	34	30	30	19	3 $\frac{3}{4}$ " Pinion Wheels	3	3	2	1	—
20 3" " "	20	20	18	16	12	1 $\frac{1}{2}$ " Pinion Wheel	1	1	—	—	—
46 2 $\frac{1}{2}$ " " "	36	32	32	28	2	2 Gear Wheels	2	2	1	1	—
6 2" " "	6	6	6	6	—	2 $\frac{3}{4}$ " Contrate Wheels	2	2	2	—	—
4 12 $\frac{1}{2}$ " Angle Girders	4	—	—	—	—	1 Worm Wheel	1	1	—	—	—
12 5 $\frac{1}{2}$ " " "	12	12	12	12	12	404 Nuts and Bolts	384	354	334	284	244
89 Angle Brackets	77	75	65	53	36	14 Clips	8	8	6	2	5
1 6" Rod	1	1	1	—	—	2 Collars and Set Screws	2	2	—	—	—
1 5" " "	1	—	—	—	—	1 Double Bent Strip	1	—	—	—	—
3 4 $\frac{1}{2}$ " Rods	—	—	—	—	—	1 Large Bent Strip	1	1	—	—	—
4 3 $\frac{1}{2}$ " " "	4	3	3	3	2	3 Large Rectangular Plates	2	2	1	1	—
1 1 $\frac{1}{2}$ " Pulley Wheel	1	1	—	—	—	6 Small " "	6	6	3	3	1

Begin by constructing the four platforms, Fig. 108A, which are then assembled and connected to the vertical ribs 1, Fig. 108B, by means of angle brackets. The position of these angle brackets should be carefully noted in Fig. 108A.

The base of the Tower is made from a number of small frames 2, Fig. 108C, which are bolted to the angle brackets 3, Fig. 108A.

The gallery 4 of the Tower, Fig. 108C, is then constructed as clearly shown in the illustration, being composed of three 12 $\frac{1}{2}$ " strips, bolted together in the first holes to form the top ring, the bottom ring being formed in a similar manner and bolted to angle brackets 5 by the inclined strips 6.

The crown 7, Fig. 108C, of the Tower is next built up, the lower strips 8 being bolted to the upper ends 9 of the ribs 1.

The cages 10, Fig. 108C, are made of rectangular plates connected by 2 $\frac{1}{2}$ " strips, the upper pulley wheel case 11 being reversed and bolted over the top to the upper platform 12, Fig. 108A.

The hoisting gear box, the construction of which is clearly brought out in Fig. 108D, is then bolted by bolts 13 to the angle girders 14 in such position that the cords rising from the pulleys 15 pass up through orifices 16 in the lower platform, over the pulleys 23, Fig. 108C. The drive is from the spindle 17 through a clutch gear to a transverse spindle 18 carrying a worm engaging a $\frac{1}{2}$ " pinion on the shaft 20, from which the drive is taken through a gear train to a spindle 21 carrying a pulley 22 round which, and the other pulleys 15, a continuous cord is passed, and connected to the top and bottom of the cages.

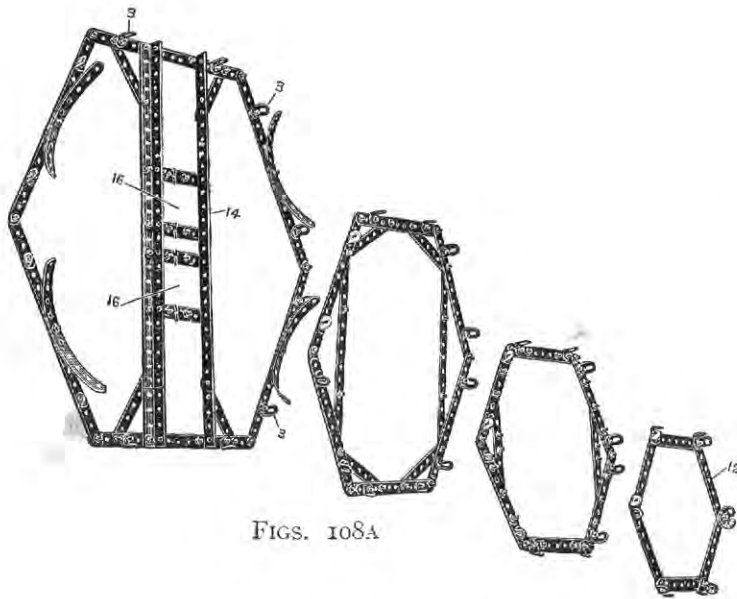

FIGS. 108A

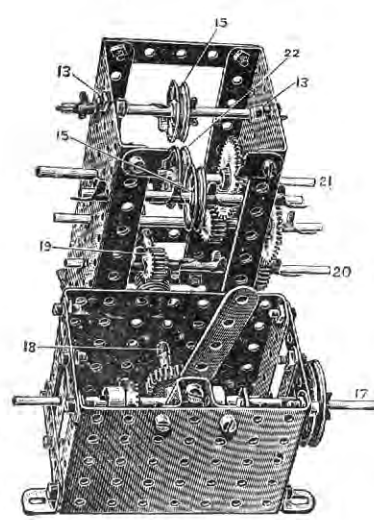
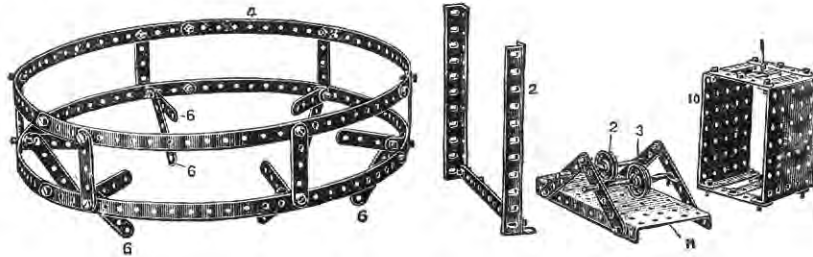

FIG. 108D



FIGS. 108C

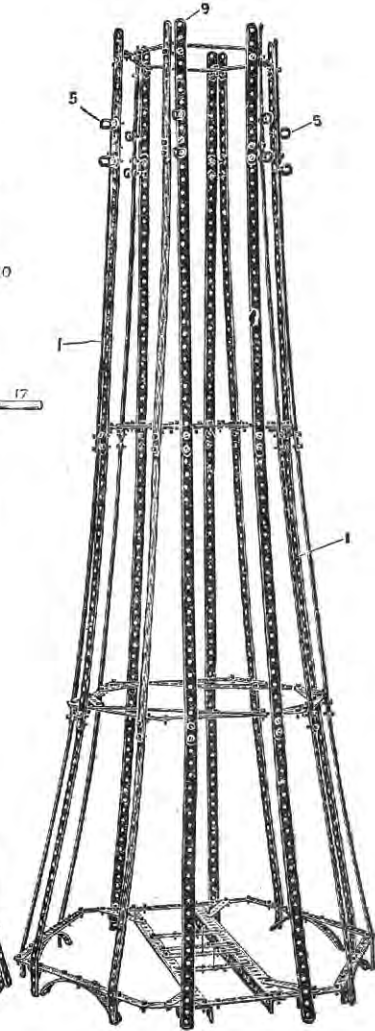
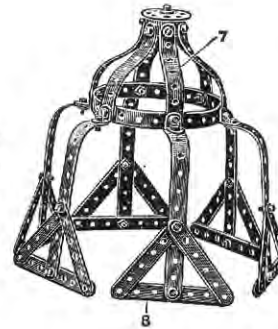

FIG. 108B

Model No. 109. Mechanical Navyy

(MADE WITH MECCANO OUTFIT NO. 6 OR NO. 5 AND NO. 5A.)

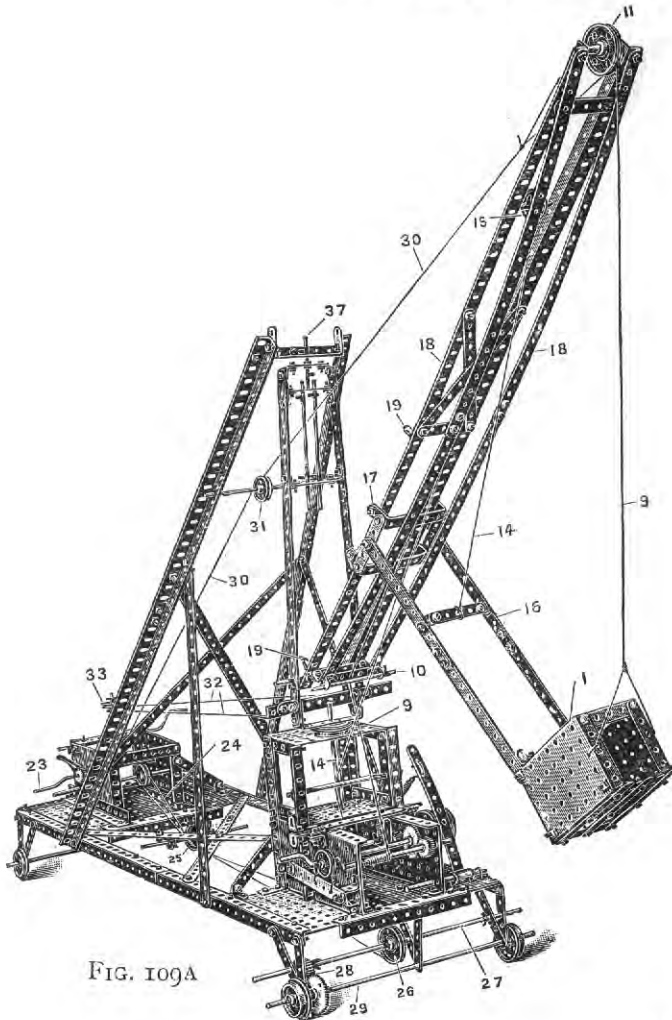

FIG. 109A

Parts required in addition to
Outfits.

PARTS REQUIRED.			No. 1	No. 2	No. 3	No. 4	No. 5
12	12 1/8"	Perforated Strips	8	2	2	—	—
8	5 1/2"	" "	2	—	—	—	—
3	3 1/2"	" "	2	1	—	—	—
11	3"	" "	11	11	9	7	3
18	2 1/8"	" "	9	6	6	—	—
2	2 1/8"	" "	2	2	2	2	—
3	2 1/8"	Bent Strips	—	—	—	—	—
12	12 1/2"	Angle Girders	12	8	4	4	—
12	5 1/2"	" "	12	12	12	12	12
38		Angle Brackets	26	24	14	2	—
3	11 1/2"	Rods	3	3	3	1	1
1	8"	Rod	1	1	1	1	1
1	6"	"	1	1	1	—	—
4	5"	Rods	4	1	—	—	—
4	4 1/2"	"	1	1	1	1	1
2	3 1/2"	"	2	2	2	2	—
3	2"	"	1	1	—	—	—
4		Crank Handles	3	3	2	1	—
7		Flanged Wheels	7	3	3	—	—
2	1 1/8"	Pulley Wheels	2	2	1	1	—
6	1"	" "	—	—	—	—	—
4	1 1/2"	" "	4	4	3	3	—
1		Bush Wheel	—	—	—	—	—
3	3 3/4"	Pinion Wheels	3	3	2	1	—
2	1 1/2"	" "	2	2	—	—	—
2		Gear Wheels	2	2	1	1	—
1		Worm Wheel	1	1	—	—	—
1		Pawl	1	1	—	—	—
24		Clips	18	18	16	12	6
4		Collars and Set Screws	4	4	—	—	—
221		Nuts and Bolts	201	171	151	101	61
2		Hooks	1	1	1	1	1
1		Spring	1	1	1	—	—
1		Single Bent Strip	—	—	—	—	—
1		Double Bent Strip	1	—	—	—	—
4		Large Bent Strips	4	4	3	3	2
8		Large Rectangular Plates	7	7	6	6	4
7		Small Rectangular Plates	7	7	4	4	2
2		Eye Pieces	2	2	—	—	—

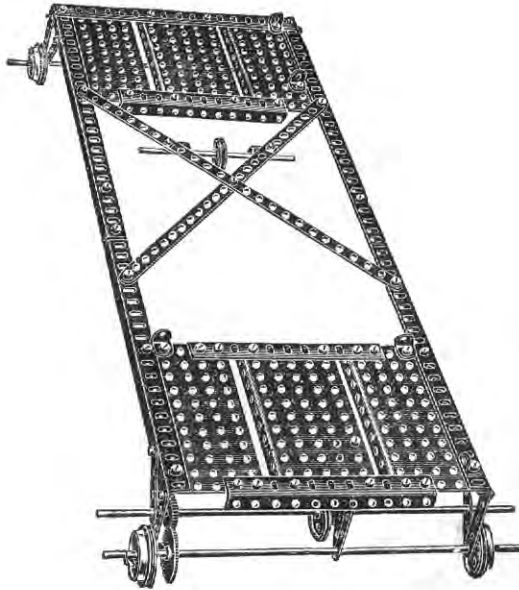

FIG. 109A

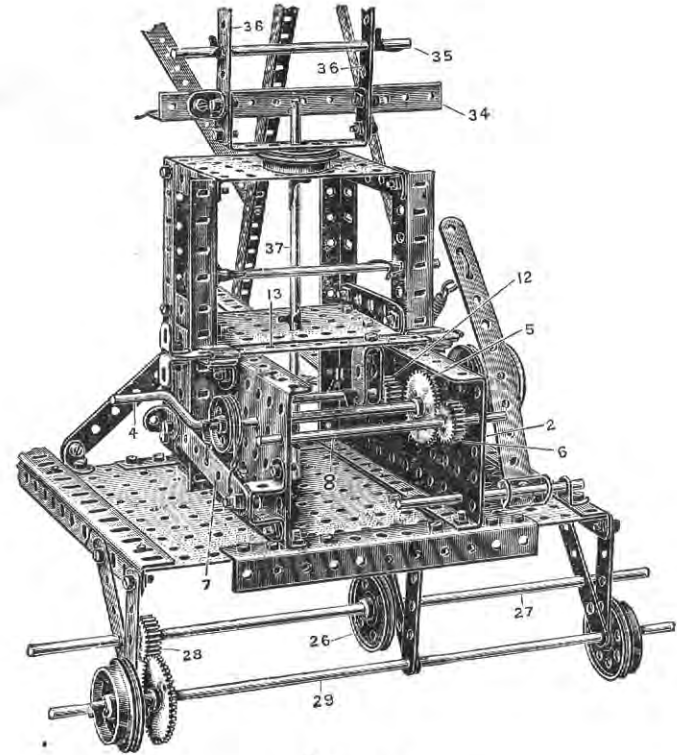

FIG. 109B

With this model, proceed first by constructing the bed frame, Fig. 109A. On the front portion of the bed frame is now mounted the gear box, Fig. 109B, which controls the movements of the bucket 1. The side walls of the gear box 2 consist of two large rectangular plates bolted on the bed plate, Fig. 109A; the crank handle 4 carries the large gear wheel 5 meshing with the $\frac{3}{4}$ " pinion 6. A friction brake mechanism 7 controls the crank handle 4. The winding spindle 8 driven from the crank handle, carries the cord 9 passing round the spindle 10 and the jib end pulley wheel 3 to control the swinging movement of the bucket 1. The rear spindle 11 carrying a $\frac{3}{4}$ " pinion 12 controlled by the clutch strip 13 is adapted to be put in or out of gear with the gear wheel 5. The cord 14 passes from this rear spindle 11 round the jib pulley 15 back to the bucket arm. When, therefore, both spindles 8 and 11 are in gear with the crank

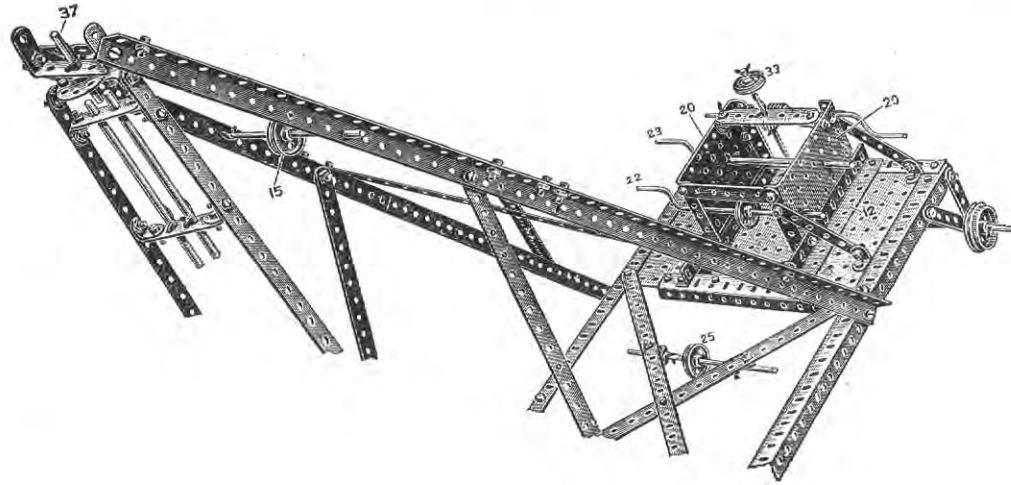

FIG. 109C

handle 4 the bucket partakes of a combined swinging and vertical travelling movement up the jib, the bucket arm 19 being pivoted to a light trolley 17 riding on the edge girders 18 of the jib between stops 19 consisting of angle brackets.

Proceed next with the gear box on the rear platform shown in Fig. 109c. This again consists of two small rectangular plates, bolted by angle girders 21 to the bed frame, and carrying two cranked spindles 22 and 23. The spindle 22 carries a 1" pulley wheel round which passes the cord 24, for causing traversing movement of the bed frame. This cord passes under the pulley wheel 25 and round the front pulley wheel 26, which latter is secured on a spindle 27 geared at 28 to the flanged wheel spindle 29.

The cord 30 for elevating the jib, passes round the pulley wheel 31 and on to the rear cranked spindle 23. The cord 32 for luffing the jib passes round the pulley wheel 33 on the vertical spindle of the gear box, and is connected to the outer ends of the yoke piece 34. The jib of the crane pivots about the spindle 35 mounted in the standard 36, which in turn swivels about the spindles 37.

Meccano is more than a Toy

IT is important to remember that when a boy is playing with MECCANO he is using engineering parts in miniature, and that these parts act in precisely the same way as the corresponding engineering elements would do in actual practice. No other system of model construction could, therefore, be correct. Other toys which attempt the same object by other methods must avail themselves of other constructive elements which are not correct engineering elements. Consequently, though a boy may succeed in building playthings with them, they are merely toys and nothing else, and his mind, as regards proper mechanical construction and methods, is distorted instead of instructed. He thus learns wrong principles, and, when his ambition tempts him to invent or construct more elaborate models, he will be stopped by the deficiencies of his non-mechanical system.

THE SCIENCE OF MECHANICS TAUGHT BY MECCANO.

Apart from its great attraction as a pleasure-giving hobby, Meccano has a distinct and unique value as an educative force of the highest order. Whilst extracting fun and amusement from the construction of such models as the Telfer Span, the various Cranes, Wagons, Elevators, Towers, Bridges, &c., and playing with them after they have been constructed, the user is acquiring a thorough and valuable knowledge of the important principles of mechanical construction. If the information thus acquired proves of no practical or material value, it at least enables the boy or man to take a more keen and more intelligent interest in those mechanical and engineering wonders which, in these remarkable times of invention and progress, confront us at every turn. On the other hand, however, it has on very many occasions been a source of satisfaction and pride to us to learn that, through the stimulating influence of Meccano many a boy has been impelled to take up seriously the study of mechanics.

Four years ago, in the "Hornby System of Mechanical Demonstration," we gave 37 examples demonstrating the main elementary fundamentals of mechanics and mechanical science, and these have been found to be of the very greatest use to students. We have introduced a selection of these examples into the Meccano Manual this year, and they will be found on the following pages. It is hoped that they will prove both useful and instructive even to those who appreciate Meccano simply for the fun and pleasure which they derive from it.

Centrifugal Governor.

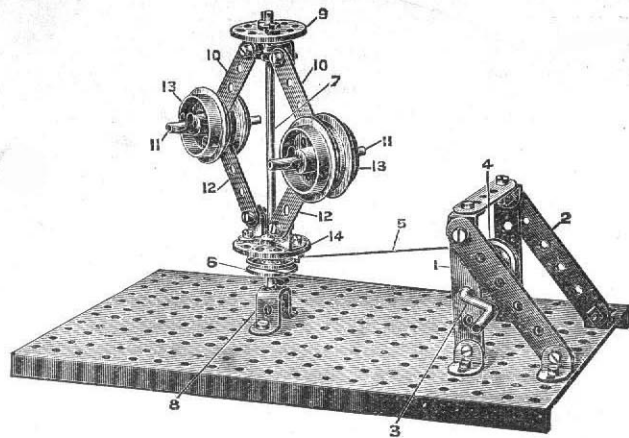

This model shows the fundamental principle of a centrifugal type of governor. At the top of the spindle 7 is secured a bush wheel 9, connected to which are two angle brackets, and on these angle brackets are pivoted the upper links 10. Short spindles 11 pass through the ends of these links 10 and through the ends of the lower links 12, the wheels 13, which correspond to the ball weights of an ordinary governor, are secured on the spindles 11. The lower ends of the links 12 are bolted to brackets on the lower bush wheel 14, this lower wheel 14 being capable of riding loosely up the spindle 7. On rotating the crank 3 it will be found that the tendency of the weights 13 to fly outwards causes the bush wheel 14 to rise up the spindle. This principle is taken advantage of to govern an engine.

Universal Crosshead.

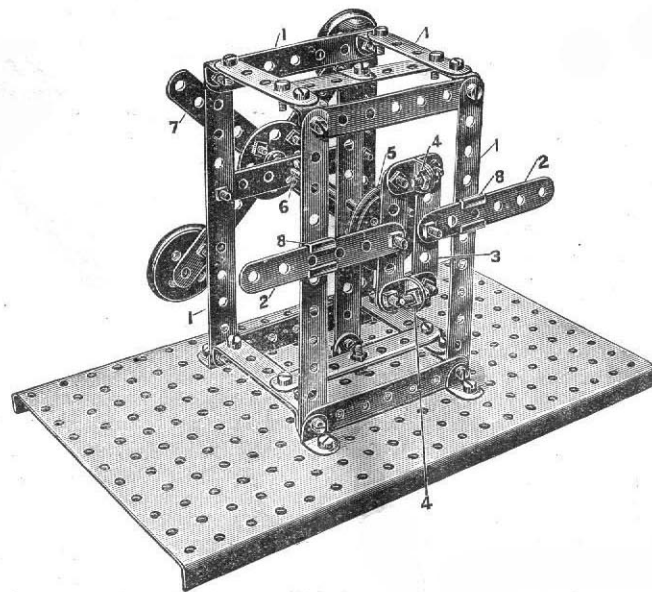

This model shows a construction which is frequently adopted in pumps and similar mechanism. It is known as a universal crosshead. At the nearest side is mounted a moving frame constructed of two straight strips 2 connected to another pair of cross strips 3, bolted at their ends by angle brackets 4 to form a slot. This slot engage the projecting shank of a bolt screwed in a bush wheel 5, which is secured upon a short spindle 6, passing through a middle vertical strip and the back framework. Four strips 7 bolted to a bush wheel secured on the outer end of the spindle 6 act as a fly wheel. The front strips 2 are guided in the eye pieces 8. By reciprocating the front frame by one or other of the strips 2 in the guides 8, it will be seen that the slotted guides 3 operate on the projecting bolt of the wheel 5 and rotate the shaft 6.

Hooke's Coupling.

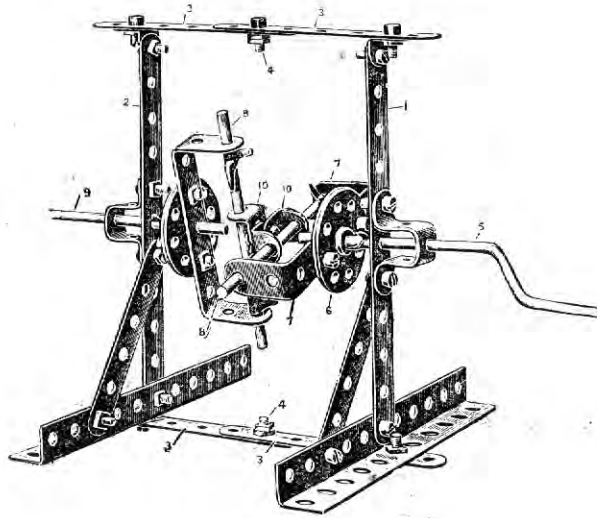

This shows an apparatus known as Hooke's coupling, which is designed for use in situations where it is required to connect together two rotating shafts which are not in line. It will be found that this model will convey a thorough understanding of what is otherwise a very complicated and elusive movement. On the crank shaft 5 is keyed the wheel 6, to which is bolted the bent armed strip 7. Across the ends of this bent strip 7 is fitted the short spindle 8, an exactly similar duplicate formation is provided for the shaft 9 in the side frame 2. The cross shafts 8 are coupled by pairs of angle brackets 10, arranged back to back. The shafts 5 and 9 are now coupled together in such a manner that even if the side frames 1 and 2 are moved about the bolts 4 to a position such that the shafts 5 and 9 are inclined to each other, the coupling will still rotatively connect the one shaft to the other.

Block and Tackle.

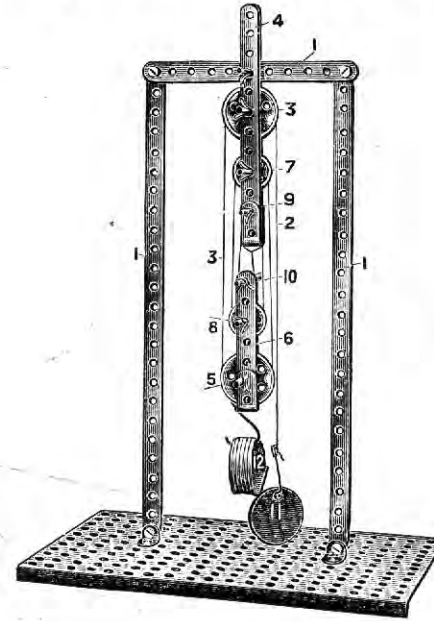

This is an arrangement showing the more usual application of a pulley system in the case of a block and tackle. There is only one continuous cord 2 in this case, which passes round the top pulley 3, pivotally mounted in the strips 4 which are fixed to the frame work 1. The cord then passes round the lower pulley 5, also pivotally mounted in the movable frame work 6, then over the next top fixed pulley 7, and then to the lower movable pulley 8; from thence to the small upper pulley 9, and finally round the corresponding lower pulley 10, and is fixed to the end of the bent strip attached to 4. The effect of the force 11 in raising the weight 12 is found by counting the number of cords which spring from the lower movable pulley block 6 to the fixed block 4.

Lever.

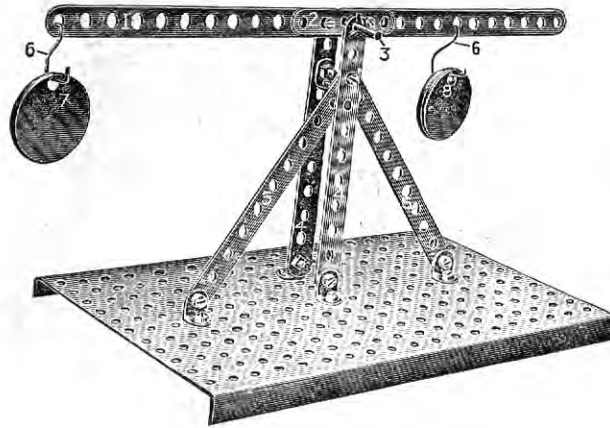

This example serves to determine the principle of equilibrium of an ordinary lever. Through the strengthening strip 2 is passed the short shaft 3, which is supported in the uprights 4. The hooks 6 are for supporting the weights. By selecting a certain number of disc weights and suspending them in various holes on each side of the spindle 3, it will be found that any weight 7 on one side of the spindle multiplied by the arm or distance—that is, the number of holes—from the spindle 3, will be equal to the weight 8 multiplied by its arm or distance, or number of holes, from the spindle 3. The weight at any side multiplied by its arm or distance from the spindle 3 is called the moment of the force, or weight, about the fulcrum 3, and it is necessary in order that the lever should balance that the moments on each side of the fulcrum should be equal.

Jib Crane.

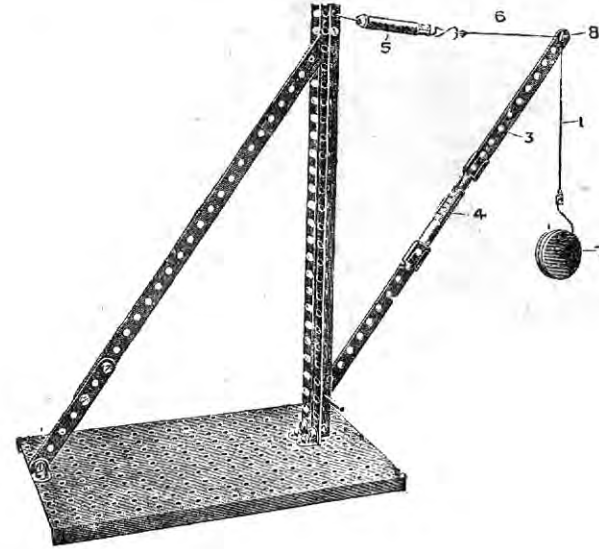

This model serves to illustrate how the forces in the tie and jib of a simple crane may be determined. If any weights be suspended by the cord 1 from the extremity of the jib 3, it will be found that the compression spring balance 4 and the tension spring balance 5 register various forces. The angles formed by the jib 3 and the tie 6 should be carefully noted, and a triangle then drawn with its sides parallel respectively to the vertical cord 1, the jib 3, and the tie 6. It will be found that the sides of the triangle so drawn are in direct proportion to the values of the weight 7 and the forces on the jib 3, and the tie rod 6.

Simple Roof Truss.

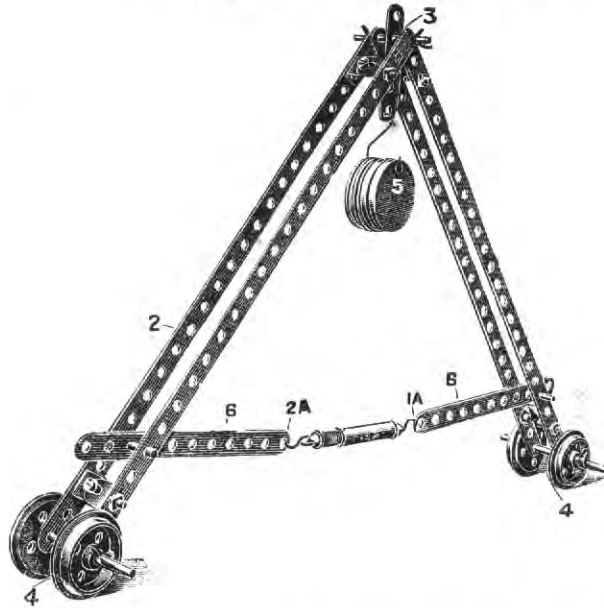

This apparatus serves to determine the forces acting in the different members of a simple triangular roof truss. The two main side members 1 and 2 are pivoted together at 3, and are furnished at their lower ends with wheels 4, so that when the weight 5 is suspended from the top pivot 3 the pulleys 4 allow of the members 1 and 2 expanding freely when resting on a flat support. The ends 1a and 2a are connected to the tension spring balance before the load 5 is applied, and shows the actual force set up on the tie rod 6 by the mere weight of the structure itself, due to the sloping rafters 1 and 2. If the load 5 be then hung from the pivot 3 it will be found that a considerable force is set up in the spring balance; this force is a tension force, because of the two ends 4 of the sloping rafters tending to move away from each other.

Inclined Plane

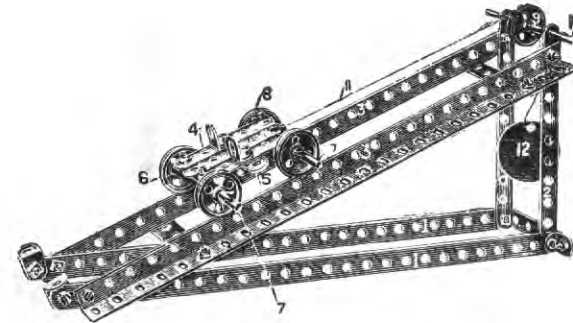

This is an example to illustrate the principle of the inclined plane. The main frame work is constructed of the horizontal strips 1 carrying the vertical strips 2. A pair of inclined angle girders 3 are bolted to the lower strips 1 and the uprights 2. A carriage, consisting of a series of strips 4 bolted to a cross strip 5 and to angle brackets 6, which carry the shafts 7, is adapted to roll on its wheels 8 along the upper edges of the angle girders 3. A pulley 9 mounted on a short shaft 10 rotates in the top perforations of the uprights 2, a cord 11 is passed over this pulley 9 to the carriage 4, and is provided at its lower end with a hook, upon which a series of weights 12 may be suspended. The form of the apparatus shown is suitable for finding the conditions of equilibrium of a smooth body on a smooth inclined plane when the line of action is parallel to the plane. By withdrawing the spindle 10 and inserting it with its pulley at a lower position in the upright strips 2, the cord 11 may be arranged to act horizontally on the carriage 4. This arrangement gives the second condition of the inclined plane where the line of direction of the force maintaining equilibrium acts horizontally.

Standard Details for use in the Construction of Models on the Meccano Principle

A—A Brake Mechanism suitable for controlling winding or similar spindles.

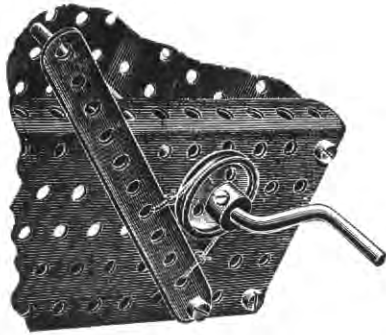

B—Type of Reversing Gear.

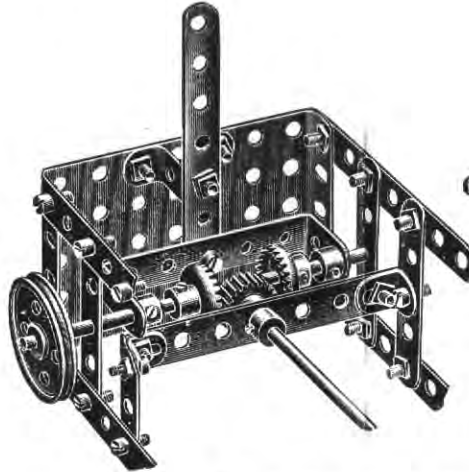

C—Worm and Worm Gear.

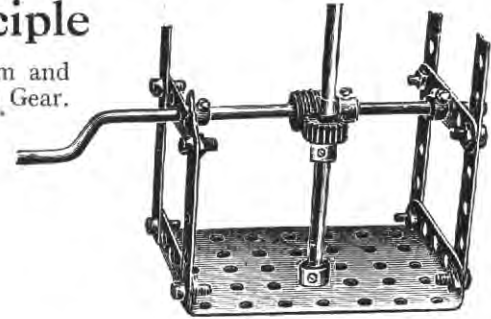

G—Method of operating a fast and loose pulley with a belt drive, one of the flanged wheels on the main shaft being secured whilst the other runs freely.

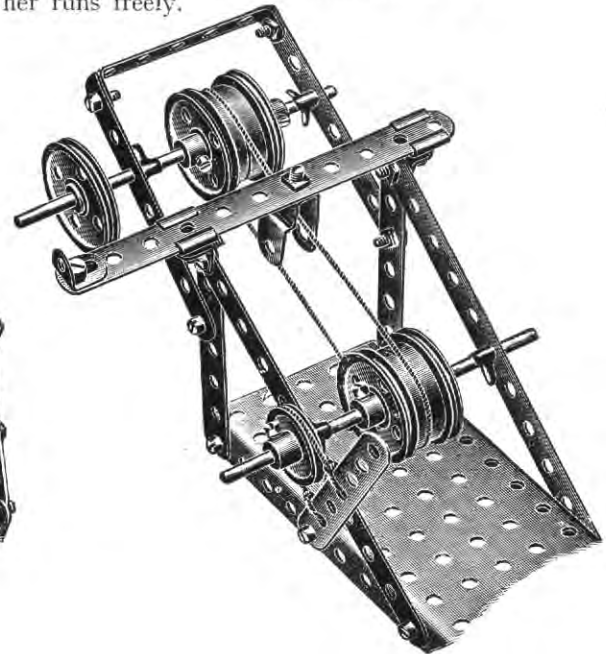

D—Method of locking swivelling connections with double nuts



E—Pawl and Pinion or Ratchet Gear; used also as a brake.

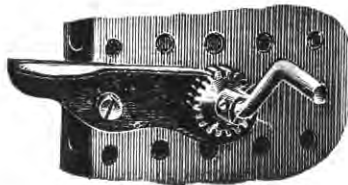

F—Spring Controlled Band Friction Brake.



H—Simple Extended Bearing suitable for longitudinal or rotary movement of spindles.

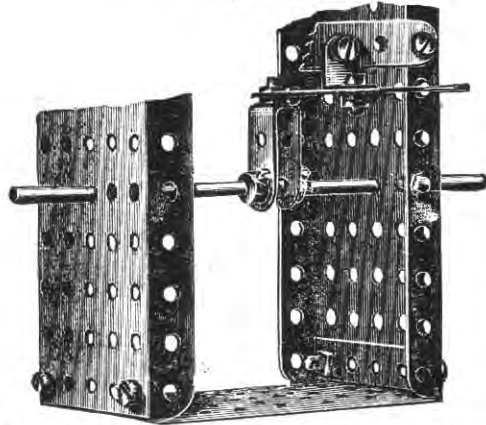

K—Swivel Bearing providing for combined sliding and oscillating movement of a strip.

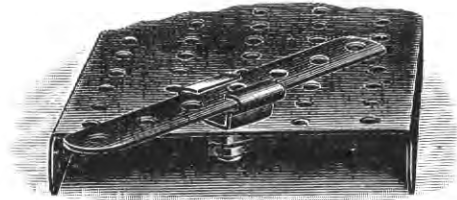

N—Crank formed with $1\frac{1}{2}$ " pulley wheel and strip, lock-nutted.



I—Gear Connection for coupling two shafts at right angles.

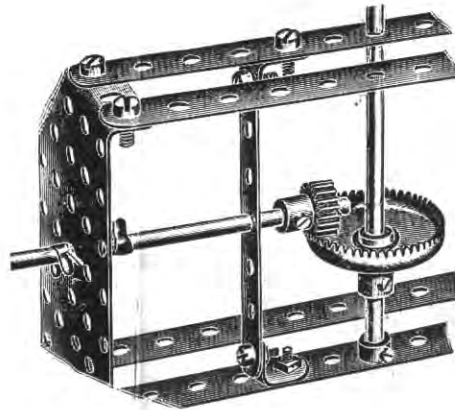

L—Jockey Pulley Arrangement for increasing grip in a driving band.

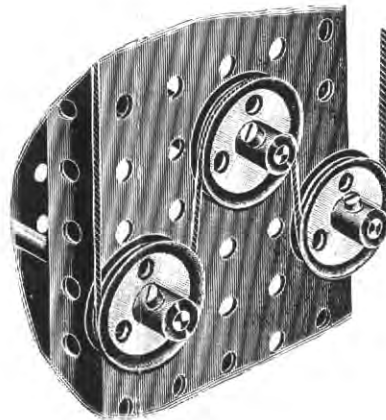

J—Purchase Pulley.

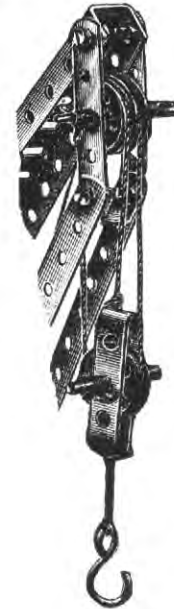

M—Reinforced Bearing for spindles.

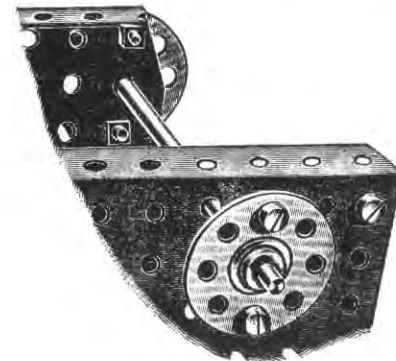

O—Extended bearing for a spindle formed by a double bent strip bolted to a perforated plate.

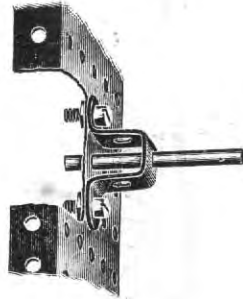

P—Footstep bearing for a vertical spindle formed by bolting a double bent strip to a perforated plate.

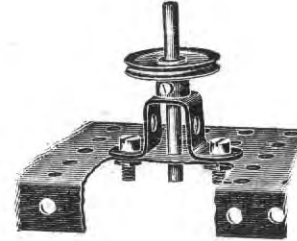

Q—Overhung support for $\frac{1}{2}$ " pulley. The bolt spindle for the pulley is nutted on each side of the angle bracket.

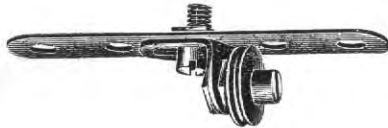

R—Overhung support for larger pulley. The screwed end of the bolt is entered in the wheel boss and nipped by the set screw.



Meccano Motors (Patent Pending).

One of the principal merits of Meccano is that all the models which it makes are *working* models. No greater pleasure for any boy can be imagined, than for him to take a number of elementary parts, piece them together with his own hands and in his own way, and then to see the results of his efforts and skill move and work in a precise and scientific way. The Meccano Motors will encourage this very natural pleasure. They have been designed on Meccano lines, and solely to work Meccano models, to each one of which they give life and movement. They are built into and become part of each model. To such models as Cranes, Wagons, Windmills, Roundabouts, &c., they are an indispensable addition to Meccano. They are driven by a powerful spring, and are quite free from the dangers and disadvantages of steam or electrically driven motors.

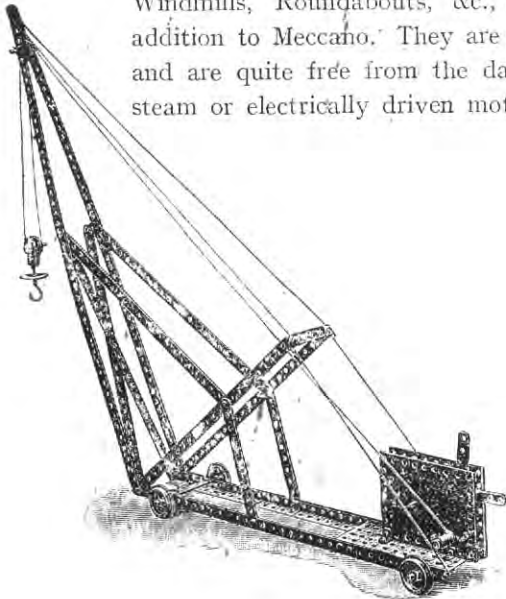

This illustration shows just how a No. 1 Meccano Motor is used in connection with the Travelling Jib Crane described on page 20. Full instructions accompany each Motor, and there is no difficulty in using it.

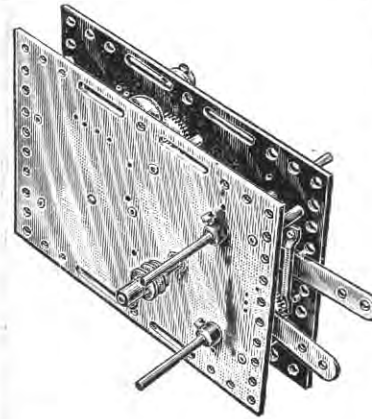

THE NO. 2 MECCANO MOTOR.

The No. 1 Motor may be used in connection with Outfits Nos. 1 to 3. It has a stopping and starting motion, and the movement can be reversed.

PRICE 9/6

The No. 2 Motor is suitable for driving models made with Outfits Nos. 4 to 6. There are three driving spindles, one of which has a clutch movement, and each can be worked independently. It has also a starting button and a reversing movement.

PRICE 28/6

Contents of Outfits.

DESCRIPTION OF PARTS.										0	0A	1	1A	2	2A	3	3A	4	4A	5	5A	6
12 $\frac{1}{2}$ "	Perforated Strips	—	4	4	6	10	—	10	4	14	—	14	34	48
5 $\frac{1}{8}$ "	"	4	2	6	10	16	2	18	2	20	6	26	34	60
3 $\frac{1}{2}$ "	"	—	1	1	1	2	4	6	—	6	11	17	19	36
3"	"	—	—	—	—	—	2	2	2	4	4	8	16	24
2 $\frac{1}{2}$ "	"	9	—	9	3	12	—	12	6	18	26	44	4	48
2 $\frac{1}{2}$ "	Bent Strip	—	4	4	2	6	—	6	—	6	6	12	4	16
2"	Perforated Strips	—	—	—	—	—	—	—	—	—	6	6	18	24
12 $\frac{1}{2}$ "	Perforated Angle Girders	—	—	—	4	4	4	8	—	8	—	12	12	24
5 $\frac{1}{2}$ "	"	—	—	—	—	—	—	—	—	—	—	—	12	12
Angle	Brackets	12	—	12	2	14	10	24	12	36	17	53	67	120
11 $\frac{1}{2}$ "	Rods	—	—	—	—	—	—	—	2	2	—	2	2	4
6"	"	—	—	—	—	—	—	—	2	2	—	2	2	4
5"	"	—	—	—	3	3	1	4	—	4	—	4	—	4
4 $\frac{1}{2}$ "	"	2	1	3	—	3	—	3	—	3	—	3	1	4
3 $\frac{1}{2}$ "	"	—	—	1	1	1	—	1	—	1	—	2	2	4
2"	"	2	—	2	—	2	—	2	2	4	—	4	1	5
	Crank Handles	1	1	1	—	1	1	2	1	3	—	3	1	4
	Flanged and Grooved Wheels	—	—	—	4	4	—	4	4	8	—	8	—	8
1 $\frac{1}{2}$ "	Pulley Wheels	—	—	—	—	1	1	1	1	1	—	1	2	—
1"	"	4	2	6	—	6	—	6	—	6	—	6	—	6
$\frac{1}{2}$ "	"	1	—	—	—	—	1	1	—	1	5	6	—	6
	Bush Wheels	1	—	1	—	1	—	1	1	1	—	2	2	3
$\frac{3}{4}$ "	Pinion Wheels	—	—	—	—	—	1	1	1	1	2	—	2	1
$\frac{1}{2}$ "	"	—	—	—	—	2	2	—	2	—	2	—	2	2
	Gear Wheels	—	—	—	—	—	1	1	—	1	1	2	—	2
1 $\frac{1}{2}$ "	Contrate Wheels	—	—	—	—	—	—	1	1	1	—	1	1	2
$\frac{3}{4}$ "	"	—	—	—	—	—	—	2	2	—	2	—	2	2
	Worm Wheel	—	—	—	—	—	1	1	—	1	—	1	—	1
	Pawl	—	—	—	—	—	2	2	—	2	—	2	—	2
	Spanner	—	—	—	1	1	—	1	1	2	—	2	—	2
	Spring Cord	—	—	—	—	—	—	—	—	—	—	—	1	1
	Clips	4	2	6	—	6	2	8	4	12	6	18	6	24
	Collar and Set Screws	—	—	—	—	4	4	2	6	—	6	6	6	12
	Screw Driver	1	—	1	—	1	—	1	—	1	—	1	1	2
	Nuts and Bolts	20	—	20	30	50	20	70	50	120	40	160	290	450
	Hook	1	—	1	—	1	—	1	—	1	—	1	1	2
	Hanks Cord	—	1	1	1	2	1	3	1	4	2	6	—	6
	Cards Cord	1	—	1	—	1	—	1	—	1	1	2	1	3
	Propeller Blades	—	—	—	—	—	—	—	—	—	2	2	—	2
	Chain	—	—	—	—	—	—	—	—	—	1	1	1	1
	Springs	—	—	—	—	—	—	—	1	1	—	1	1	2
	Single Bent Strips	1	—	1	—	1	—	1	—	1	1	2	—	2
	Double Bent Strips	—	—	—	1	1	—	1	—	1	—	1	7	8
	Large Bent Strips	—	—	—	—	—	—	1	1	1	1	2	2	4
	Large Rectangular Plates	1	—	1	—	1	1	2	—	2	2	4	4	8
	Small Rectangular Plates	—	—	—	—	3	3	1	4	1	5	3	3	8
	Sector Plates	1	1	2	—	2	—	2	—	2	—	2	—	2
	Windmill Sails	—	—	—	4	4	—	4	—	4	—	4	—	4
	Eye Pieces	—	—	—	—	—	—	—	—	—	2	2	—	2
	Rubber Bands	—	—	—	—	—	—	—	—	—	2	2	2	4
	Manual of Instructions	1	1	1	—	1	—	1	—	1	—	1	—	1

Price List of Additional Parts

			s. d.
1.—Perforated Strips, 12½" long	per bdl. (½ doz.)		1 3
2.— " " 5½" "	" "		0 8
3.— " " 3½" "	" "		0 6
4.— " " 3" "	" "		0 6
5.— " " 2½" "	" "		0 6
6.— " " 2" "	" "		0 4
8.—Angle Girders, 12½" long	" "		1 9
9.— " " 5½" "	" "		0 10
12.—Angle Brackets	(dozen)		0 10
13.—Axle Rod, 11½" long	each	0 5
14.— " " 6" "	" "	0 4
15.— " " 5" or 4½" long	" "	0 4
16.— " " 3½" long	" "	0 2
17.— " " 2" "	" "	0 2
19.—Crank Handle	" "	0 5
20.—Flanged and Grooved Wheel	" "	1 3
21.—Pulley Wheel, 1½" diameter	" "	0 10
22.— " " 1" " fast	" "	0 7
22A.— " " 1" " loose	" "	0 4
23.— " " ½" "	" "	0 4
24.—Bush Wheel	" "	0 10
25.—Pinion Wheel, ¾" diameter	" "	1 3
26.— " " ½" "	" "	0 10
27.—Gear Wheel, 1½" "	" "	1 6
28.—Contrate Wheel, 1½" diameter	" "	2 0
29.— " " 3" "	" "	1 8
32.—Worm Wheel	" "	1 3
33.—Pawl	" "	0 5
34.—Spanner	" "	0 5

			s. d.
35.—Spring Clips	per box (dozen)		0 10
36.—Screw Driver	each	0 5
37.—Nuts and Bolts	per box (dozen)		0 10
37A.—Nuts	" "	" "	0 4
39.—Card Cord (Special)	each	0 2
40.—Hank Cord	" "	0 2
41.—Propeller Blades	per pair	0 10
42.—Chain	12ft. lengths, each		1 8
43.—Spring	" "	0 4
44.—Single Bent Strip	" "	0 4
45.—Double Bent Strip	" "	0 4
46.—Large Bent Strip	" "	0 5
47.—Dynamometer	" "	8 6
49.—Disc Weights, 20 grammes	" "	0 7
50.—Large Perforated Stand (Scientific)	" "	2 6
51.—Eye Piece	" "	0 4
52.—Perforated Rectangular Plate, Large	" "	0 7
53.— " " " Small	" "	0 6
54.—Perforated Sector Plate	" "	0 5
55.—Rubber Bands	" "	0 2
56.—Book of Instructions	" "	1 0
57.—Hook	" "	0 2
57A.—Hook (Scientific)	" "	0 2
58.—Spring Cord, 40" long	" "	1 3
59.—Collar and Set Screws	" "	0 4
60.—2½" Bent Strip	per ½ dozen		0 10
61.—Windmill Sails	each	0 4
62.—Crank	" "	0 7
63.—Coupling	" "	0 7

Price List

No. 0.	Meccano Outfit	5/-
No. 1.	”	”	8/6
No. 2.	”	”	16/6
No. 3.	”	”	25/-
No. 4.	”	”	40/-
No. 5.	”	”	70/-
						Packed in neat and well-made cardboard box			
Do.	”	Presentation Outfit	90/-
						Packed in well-made walnut stained box with lock and key			
No. 6.	”	”	”		Ditto		ditto		160/-
<hr/>									
No. 0A.	Meccano Accessory Outfit				(containing sufficient parts to convert a Meccano No. 0 into a No. 1 Outfit)				4/6
No. 1A.	”	”	”		(containing sufficient parts to convert a No. 1 into a No. 2 Outfit)				9/6
No. 2A.	”	”	”		(containing sufficient parts to convert a No. 2 into a No. 3 Outfit)				10/6
No. 3A.	”	”	”		(containing sufficient parts to convert a No. 3 into a No. 4 Outfit)				18/6
No. 4A.	”	”	”		(containing sufficient parts to convert a No. 4 into a No. 5 Outfit)				24/-
						Packed in neat and well-made cardboard box			
Do.	”	”	”		Packed in well made walnut stained box with lock and key				58/6
No. 5A.	”	”	”		(containing sufficient parts to convert a No. 5 into a No. 6 Outfit)				58/6
						Packed in neat and well-made cardboard box			
Do.	”	”	”		Packed in well made walnut stained box with lock and key				82/6

