

MECCANO



(PATENTED)

(TRADE MARK 12633)

INSTRUCTIONS

For the whole series of Models,
comprising thirteen progressive outfits

1/- net.

Copyright by MECCANO LIMITED, LIVERPOOL, throughout the World

MECCANO PATENTS

GREAT BRITAIN

22962-13		577272
20535-13		577207
21117-12		
2085-11		
587-01		

Further Patents Pending

CANADA

151243. Oct. 21, 1913
78564. Dec. 9, 1902

Further Patents Pending

AUSTRALIA

18850 | 11649

Further Patents Pending

NEW ZEALAND

14407

Further Patents Pending

UNITED STATES OF AMERICA

1079245. Nov. 18, 1913
745928. (Pending)

Further Patents Pending

FRANCE

312704		19305
458842		435853
1705		4909

Further Patents Pending

GERMANY

578955		570825
553578		485392
455056		455057

Further Patents Pending

BELGIUM

157984

Further Patents Pending

SWITZERLAND

22385

Further Patents Pending

HOW TO MAKE MODELS AND TOYS WITH MECCANO

THE first piece of advice we would give to the beginner in Meccano is that he commences with Model No. 1, and that he erects every model in turn up to the capacity of his outfit. By that time he will have grown so familiar with the various parts of Meccano, and will see its possibilities so clearly, that he will with little difficulty be able to build many other models of his own invention.

The charm of Meccano lies greatly in its endless variety, and until the user has commenced to apply his own inventive faculties to the hobby, he is not getting the enjoyment out of it which he should.

Every part of the outfit should first be taken from its box, examined, and its name and number, as contained in the illustrations of Meccano parts over leaf, committed to memory. The standard details shown at the end of the Manual should also be carefully studied, so that the instructions for making the various models may be followed easily and rapidly.

The parts are all standardised, and are interchangeable, and they will be found to fit together easily and without forcing. The holes in the strips are of equal distance apart. The axles fit any of the holes, and their position in the various designs may be ascertained by counting the holes.

All the models shown are built upon sound and standard engineering principles, and the parts employed represent the main mechanical parts used in machinery, such as levers, beams, wheels, axles, pulleys, worm wheels, screws, bolts, &c., so that as an introduction to the serious study of Mechanics the value of Meccano is very great indeed.

Each model may be taken to pieces, and the same parts may be used to make up other models. Additional parts can always be purchased from your dealer or from us.

We are at all times glad to correspond with users of Meccano, and to assist them by suggestions or criticisms when difficulties occur with new models.

For the convenience of users of Meccano we have compiled a series of standard details frequently occurring in the construction of our models; and we would particularly draw attention to the illustrations of these at the end of this Manual.

Meccano Parts and Prices



		s.	d.
No. 1.	Perforated Strip, 12 $\frac{1}{2}$ " long, ($\frac{1}{2}$ doz.)	1	3
" 2.	" " 5 $\frac{1}{2}$ " " "	0	8
" 3.	" " 3 $\frac{1}{2}$ " " "	0	6
" 4.	" " 3" " "	0	6
" 5.	" " 2 $\frac{1}{2}$ " " "	0	6
" 6.	" " 2" " "	0	4

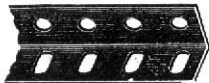

" 8.	Angle Girder, 12 $\frac{1}{2}$ " long ... ($\frac{1}{2}$ doz.)	1	9
" 9.	" " 5 $\frac{1}{2}$ " " "	0	10



" 10.	Flat Bracket ... ($\frac{1}{2}$ doz.)	0	4
-------	--	---	---



" 11.	Double Bracket (see page 5) each	0	2
-------	----------------------------------	---	---



" 12.	Angle Bracket (dozen)...	0	10
-------	--------------------------	---	----



" 13.	Axle Rod, 11 $\frac{1}{2}$ " or 8" long ... each	0	5
" 14.	" " 6" long ... "	0	4
" 15.	" " 5" or 4 $\frac{3}{8}$ " long ... "	0	4
" 16.	" " 3 $\frac{1}{2}$ " long ... "	0	2
" 17.	" " 2" " " " " " "	0	2



" 19.	Crank Handle... ..	0	5
-------	--------------------	---	---



	s.	d.
No. 20. Flanged and Grooved Wheel each	1	3



" 21.	Pulley Wheel, 1 $\frac{1}{2}$ " dia., with set screw, each	0	10
" 22.	" " 1" " " "	0	7



" 22A.	Pulley Wheel 1" dia. without set screw, each	0	4
" 23.	" " 1" " " "	0	4



" 24.	Bush Wheel each	0	10
-------	------------------------	---	----



" 25.	Pinion Wheel, $\frac{3}{4}$ " dia. each	1	3
" 26.	" " $\frac{1}{2}$ " " " "	0	10



" 27.	Gear Wheel, 1 $\frac{1}{2}$ " dia. each	1	6
-------	---	---	---



	s.	d.	
No. 28.	Contrate Wheel, 1 $\frac{1}{2}$ " dia. each	2	0
" 29.	" " $\frac{3}{4}$ " " " "	1	8



" 32.	Worm Wheel ... each	1	3
-------	---------------------	---	---



" 33.	Pawl	0	5
-------	-------------	---	---



" 34.	Spanner	0	5
-------	----------------	---	---



" 35.	Spring Clip per box (doz.)	0	10
-------	----------------------------	---	----









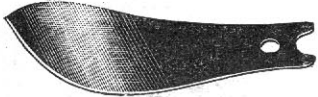

" 36.	Screw Driver ... each	0	5
-------	-----------------------	---	---



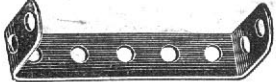





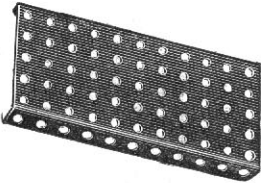
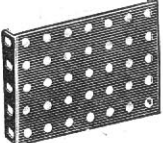
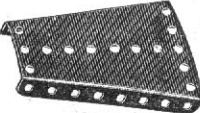

" 37.	Nuts and Bolts, per box (doz.)	0	10
" 37A.	Nuts	0	4
" 40.	Hank of Cord ... each	0	2

Meccano Parts and Prices *(continued)*

			
No. 41.	Propeller Blades	per pair	s. d. 0 10
„ 42.	Chain, 12' length	... each	1 8
			
„ 43.	Spring	„	0 4
			
„ 44.	Cranked Bent Strip	„	0 4
			
„ 45.	Double Bent Strip	„	0 4
			
„ 46.	Large Bent Strip	„	0 5
			
„ 47.	Dynamometer, tension and compression (combined)	„	8 6
			
„ 47A.	Dynamometer (tension)	„	5 0
			
„ 49.	Disc Weights, 20 grms.	„	0 7

Aus.

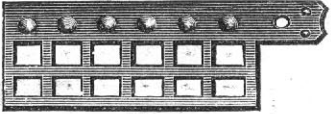
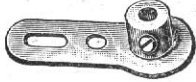
			
No. 50.	Eye Piece	each	s. d. 0 4
„ 51.	Perforated Flanged Plate (Scientific), $9\frac{1}{2}'' \times 5\frac{1}{2}''$, each	2 6	
			
„ 52.	Perforated Flanged Plate, $5\frac{1}{2}'' \times 2\frac{1}{2}''$, each	0 7	
			
„ 53.	Perforated Flanged Plate, $3\frac{1}{2}'' \times 2\frac{3}{4}''$, each	0 6	
			
„ 54.	Perforated Sector Plate, ..	0 5	
„ 56.	Book of Instructions	1 0	
			
No. 57.	Hook	„	0 2

			
No. 57A.	Hook (Scientific)	each	s. d. 0 2
			
„ 58.	Spring Cord, 40' long	„	1 3
			
„ 59.	Collar and Set Screw	„	0 4
			
„ 60.	Bent Strip, $2\frac{1}{2}''$ long, per $\frac{1}{2}$ doz.	0 10	
			
„ 61.	Windmill Sail... ..	each	0 4
			
„ 62.	Crank (see page 4)	„	0 7
			
„ 63.	Coupling (see page 4) ..	„	0 7
„ 64.	Ship's Funnel	per pair	0 2
„ 65.	Centre Fork	„	0 2

New Meccano Coupling

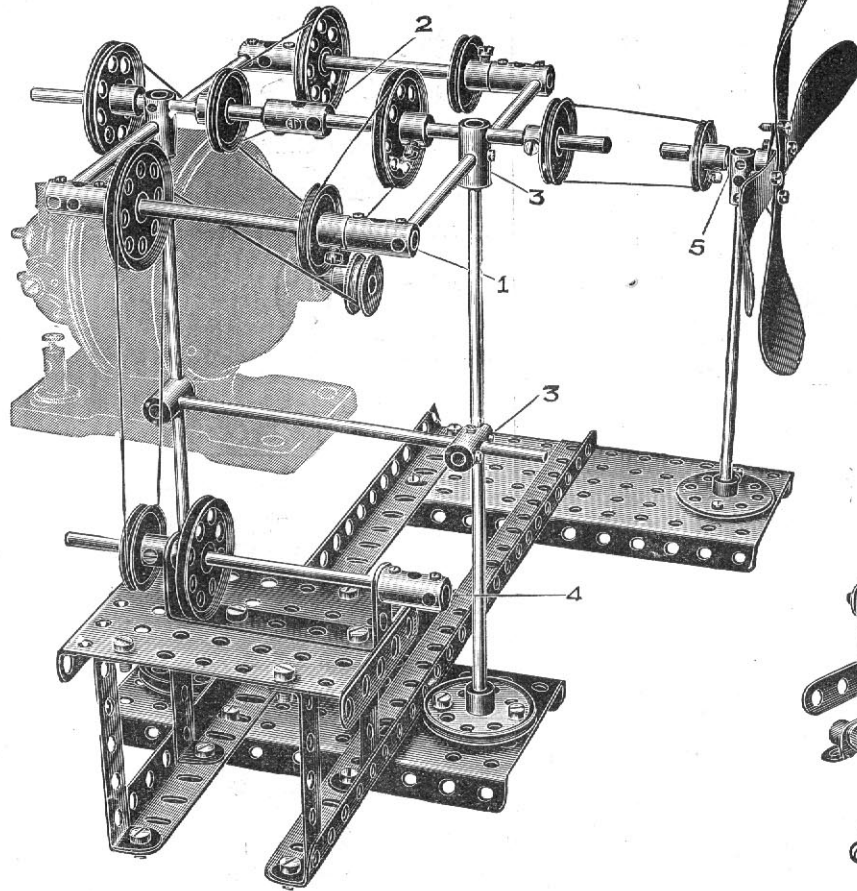

This illustration shows some of the uses to which the newly-invented MECCANO COUPLING may be applied (see Part 63, page 3):—

- | | |
|----------------------------------|---------------------------|
| No. 1. Bearing for Countershaft. | No. 4. Chuck. |
| „ 2. Coupling for Shafting. | „ 5. Bearing for Spindle. |
| „ 3. Bearing for Shafting. | |

New Meccano Crank

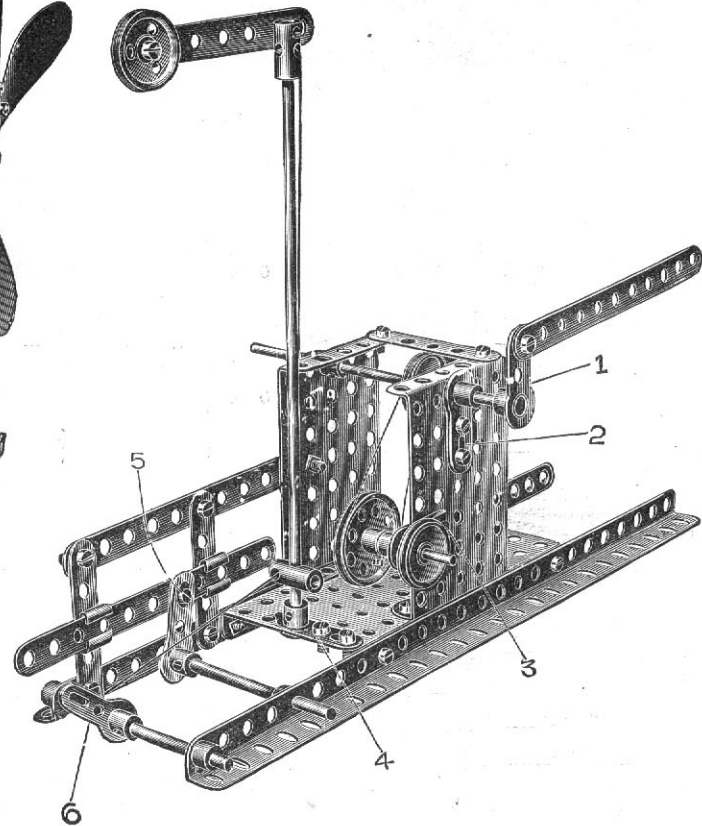

This illustration shows some of the uses to which the newly-invented MECCANO CRANK may be applied (see Part 62, page 3):—

- | | |
|--------------------------|--------------------------|
| No. 1. Crank. | No. 4. Footstep Bearing. |
| „ 2. Reinforced Bearing. | „ 5. Rocking Lever. |
| „ 3. Extended Bearing. | „ 6. Operating Lever. |

New Meccano Double Bracket.

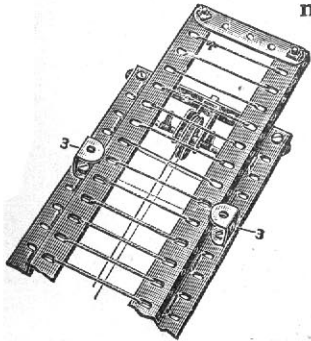
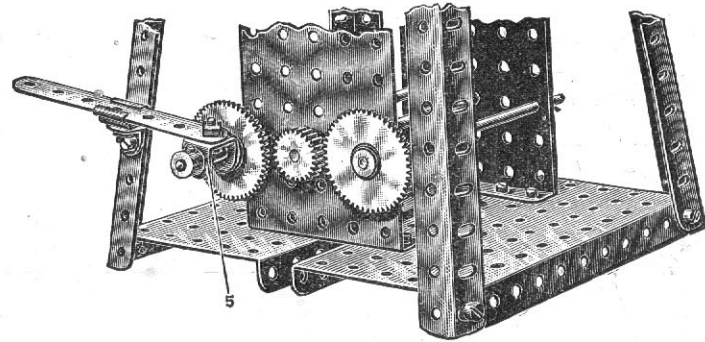
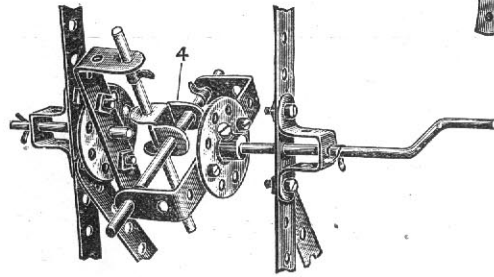
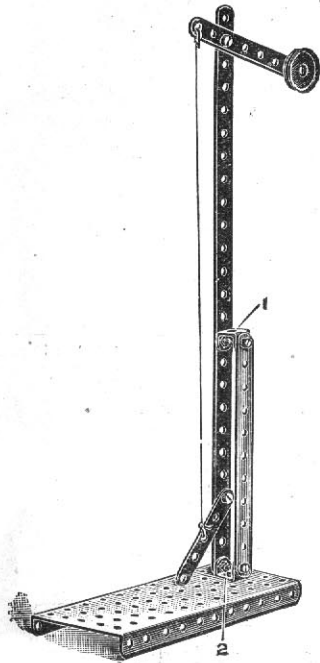

This illustration shows some of the uses to which the newly-invented **MECCANO DOUBLE BRACKET** may be applied (see Part 11, page 2) :—

- No. 1. Distancing Bracket.
- „ 2. „ Foot Bracket.
- „ 3. Guide Bracket.
- „ 4. Reversed Double Bearing for Cross Shafts.
- „ 5. Pivotal Sliding Bracket.
- „ 6. Distending Bracket for Side Frames of Crane.
- „ 7. Slung Bracket for Pulleys of Crane Tie.

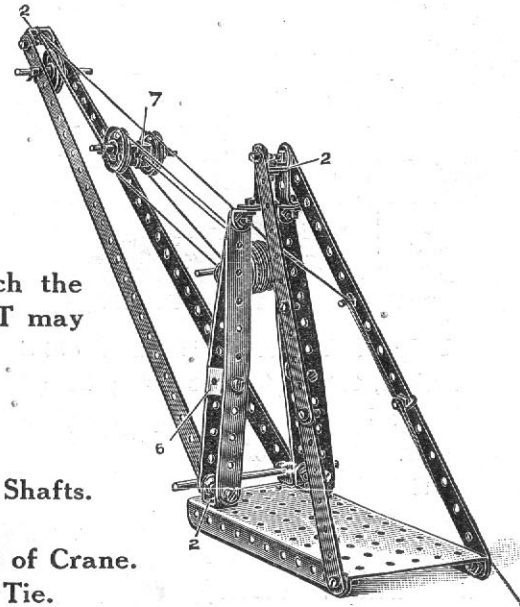

Types of Trucks and Luggage Carts

(MADE WITH MECCANO OUTFIT No. 1.)

MODEL No. 1

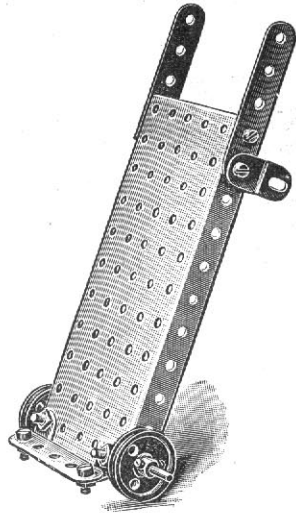

PARTS REQUIRED.

3 of No.	5
2 " "	10
2 " "	12
1 " "	15
2 " "	22
8 " "	37
1 " "	52

The body of the Truck is made of a flanged plate, two $2\frac{1}{2}$ " strips being bolted through flat brackets to the upper end to form shafts. The lip of the Truck consists of a $2\frac{1}{2}$ " strip bolted to the plate by angle brackets. On an axle passed through the end holes of the flanges are secured a pair of 1" pulley wheels, with set screws.

MODEL No. 2

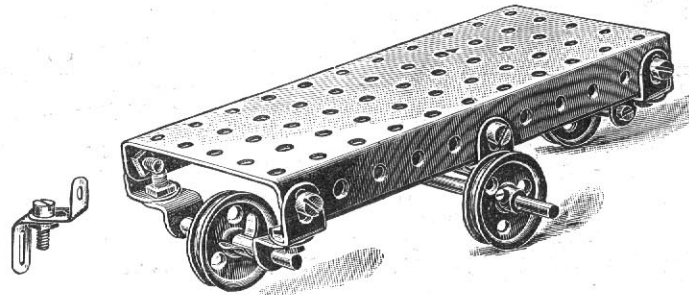

FIG. 2A.

PARTS REQUIRED.

2 of No.	10
8 " "	12
1 " "	15
2 " "	17
2 " "	22
2 " "	22A
4 " "	35
10 " "	37
1 " "	52

In a Revolver Truck the two end wheels are always raised just a little higher than the two centre wheels with a moderate amount of play on the axles, so that the Truck may be quickly revolved upon the centre wheels.

The bearings for the end axles are formed by connecting two angle brackets together, as shown in Fig. 2A, and bolting them in each end hole at the sides of the plate.

The two centre bearings are formed of flat brackets, and bolted in the centre holes of each flanged side of the plate.

It will be noted that the elongated holes of the bearings are bolted on the outside of the plate flanges. This enables the end wheels to be raised and the centre wheels to be lowered for the purpose already mentioned.

The axle carrying the two centre wheels is then placed in position, and the wheels having set screws are secured to this axle, while the two end wheels run freely on the rods, the latter being held in position by clips.

Types of Trucks and Luggage Carts *(continued)*

(MADE WITH MECCANO OUTFIT No. 1.)

MODEL No. 3

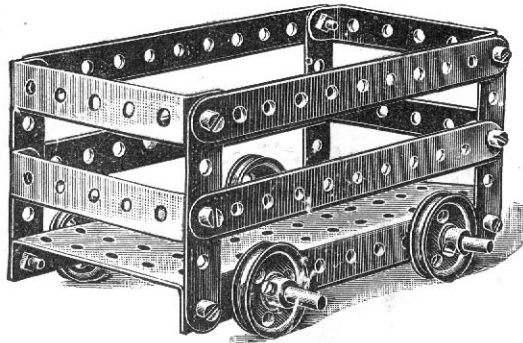

PARTS REQUIRED.

4 of No. 2	4 of No. 22
4 " " 5	12 " " 37
4 " " 60	1 " " 52
2 " " 15	

Fix the four upright $2\frac{1}{2}$ " strips at each corner of the plate first; then attach the $2\frac{1}{2}$ " bent strips and $5\frac{1}{2}$ " side strips to the uprights by means of nuts and bolts. Insert two axles through the third holes from each end of the plate; push on the wheels, and secure them in position by the set screws.

This is a very neat little model, and very simple to make.

MODEL No. 4

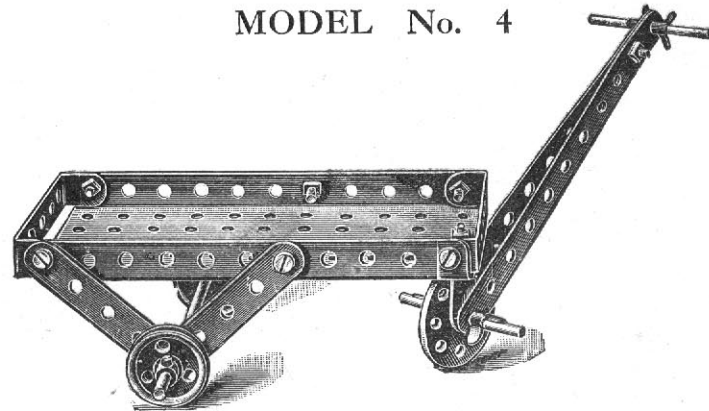

PARTS REQUIRED.

2 of No. 2	2 of No. 22
4 " " 5	1 " " 24
2 " " 60	9 " " 37
1 " " 15	4 " " 35
2 " " 17	1 " " 44
	1 of No. 52

In connection with the construction of this Model, it will only be necessary to state that the front swivelling support is formed by connecting loosely a cranked bent strip in the centre end hole of the plate, by a bolt with two nuts on the upper side, locked (see standard detail D), to prevent it from working out, and that the axle carrying the hind wheels is passed through the end holes of the $2\frac{1}{2}$ " diagonal side strips which form the bearings.

Types of Trucks and Luggage Carts—(continued)

MODEL No. 6

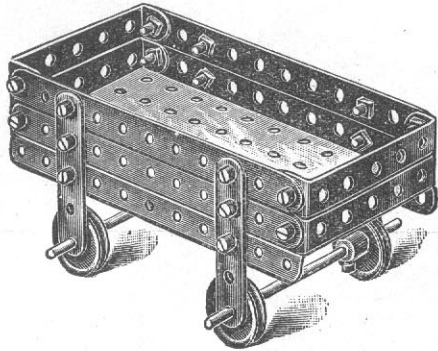

PARTS REQUIRED.

4 of No. 2	4 of No. 22
4 " " 5	20 " " 37
4 " " 60	1 " " 52
2 " " 15	

(MADE WITH MECCANO OUTFIT NO. 1.)

MODEL No. 5

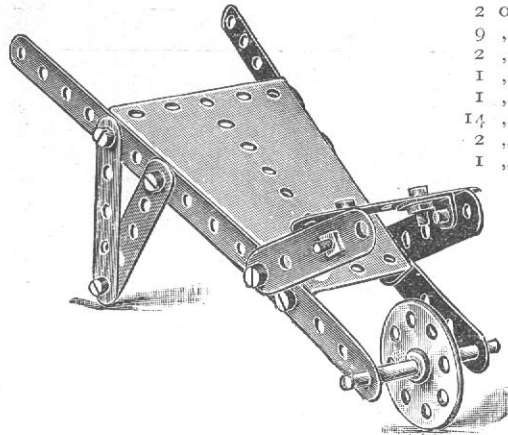

PARTS REQUIRED.

2 of No. 2
9 " " 5
2 " " 12
1 " " 17
1 " " 24
14 " " 37
2 " " 35
1 " " 54

MODEL No. 8

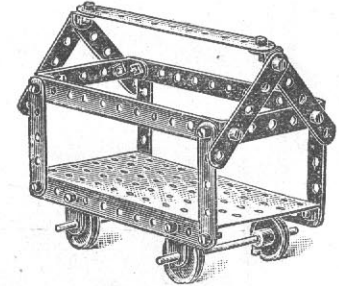

PARTS REQUIRED.

3 of No. 2	2 of No. 15
8 " " 5	4 " " 22
2 " " 60	20 " " 37
4 " " 10	1 " " 52
2 " " 12	

MODEL No. 7

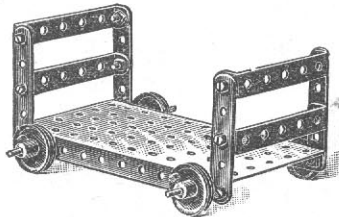

PARTS REQUIRED.

4 of No. 5	4 of No. 22
4 " " 60	12 " " 37
2 " " 15	1 " " 52

The only point to be noted in this Model is that the floor plate of the Barrow is made from a sector plate, to the sides of which the arm strips are secured, made up from two $5\frac{1}{2}$ " strips bolted on the inside of the sector plate; the $2\frac{1}{2}$ " strips carrying the wheel axle being bolted on the outside of the sector plate.

MODEL No. 9

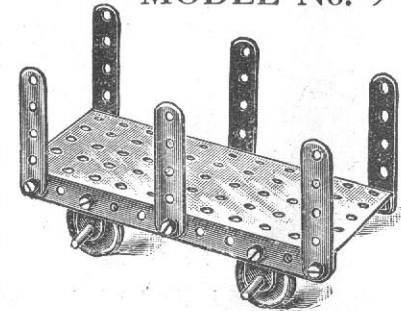

PARTS REQUIRED.

6 of No. 5	4 of No. 22
4 " " 10	10 " " 37
2 " " 15	1 " " 52

Types of Trucks and Luggage Carts—(continued)

(MADE WITH MECCANO OUTFIT NO. I.)

MODEL No. 10

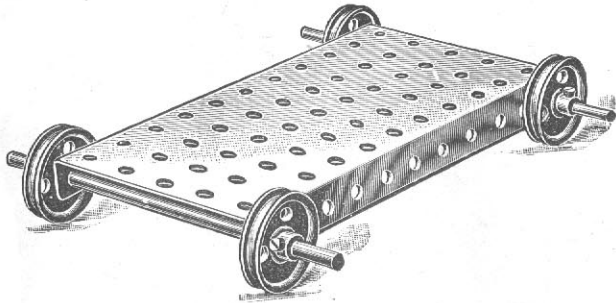

PARTS REQUIRED.

2	of No. 15
4	" " 22
1	" " 52

MODEL No. 12

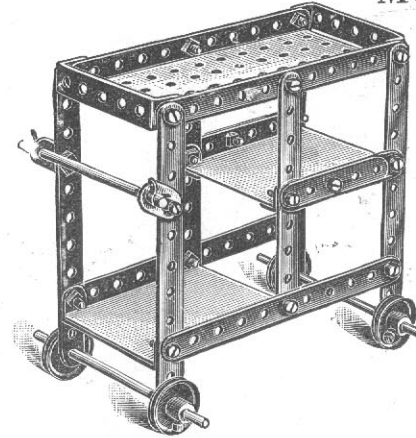

PARTS REQUIRED.

6	of No. 2
8	" " 5
4	" " 60
2	" " 10
4	" " 12
3	" " 15
4	" " 22
2	" " 35
20	" " 37
1	" " 52

MODEL No. 11

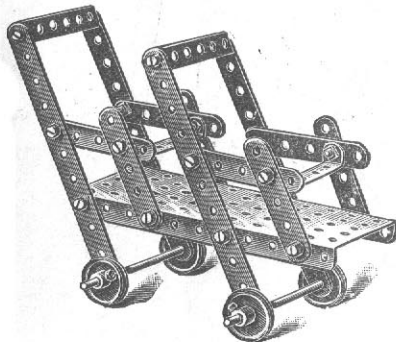

PARTS REQUIRED.

4	of No. 2
8	" " 5
4	" " 60
2	" " 15
4	" " 22
20	" " 37
1	" " 52

The two lower platforms are constructed out of pieces of ordinary cardboard, their outer edges resting on $2\frac{1}{2}$ " bent strips and their inner edges on angle brackets.

MODEL No. 13

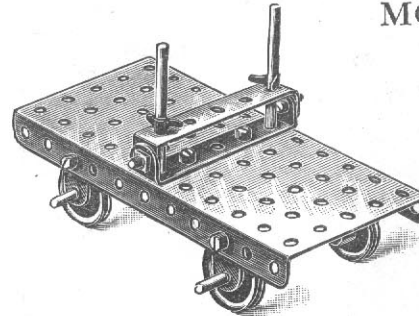

PARTS REQUIRED.

2	of No. 60
4	" " 10
2	" " 15
2	" " 17
4	" " 22
2	" " 35
8	" " 37
1	" " 52

MODEL No. 14 Luggage Truck

(MADE WITH MECCANO OUTFIT NO. 1.)

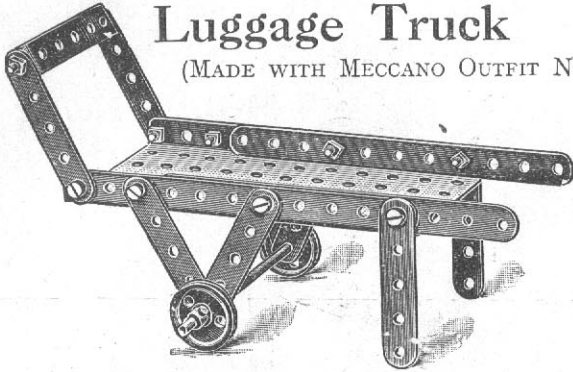

PARTS REQUIRED.

2 of No. 2	2 of No. 22
8 " " 5	10 " " 37
1 " " 60	1 " " 52
1 " " 15	

MODEL No. 15. Well Windlass

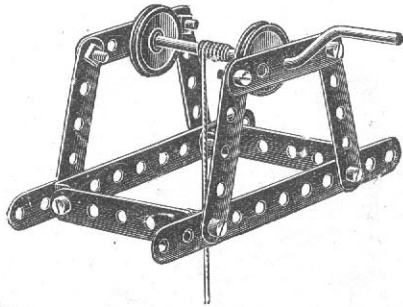

PARTS REQUIRED.

2 of No. 2
8 " " 5
4 " " 12
1 " " 19
2 " " 22
12 " " 37

MODEL No. 16. Windmill

(MADE WITH MECCANO OUTFIT NO. 1.)

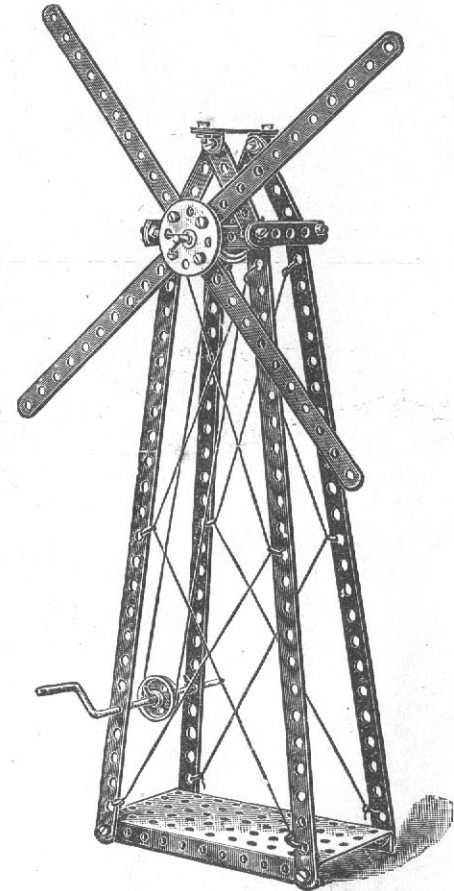

PARTS REQUIRED.

4 of No. 1
4 " " 2
7 " " 5
2 " " 12
1 " " 15
1 " " 19
2 " " 22
1 " " 24
4 " " 35
20 " " 37
1 " " 52
2 " " 60

This Model may be driven by
the No. 1 Meccano Spring Motor.

MODEL No. 17

Seesaw

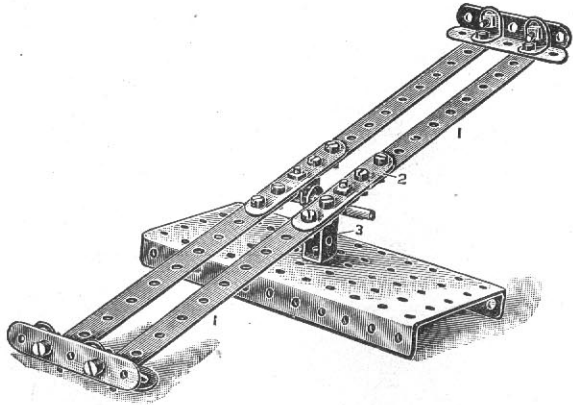

Make the Seesaw first. Commence with one side by connecting two $5\frac{1}{2}$ " strips 1 together with a $2\frac{1}{2}$ " strip 2, as shown in the illustration. An angle bracket is then bolted to the central hole of the short strip on its under side to form a bearing for the spindle. It is to be noted that the angle bracket is bolted with the head of the bolt downward, to clear the spindle. The other side of the Seesaw is formed in a similar manner.

Now connect these two together at each end by two $2\frac{1}{2}$ " strips and two angle brackets. Next bolt the cranked bent strip 3 to the centre of the flanged plate; bring the two centre brackets on the under side of the Seesaw in line with the top holes in the bent strip, and pass through the short rod, fixing a clip on each side to keep it in position.

(MADE WITH
MECCANO OUTFIT
No. 1.)

PARTS REQUIRED.

4 of No.	2
6 " "	5
6 " "	12
1 " "	17
19 " "	37
2 " "	35
1 " "	44
1 " "	52

MODEL No. 18

Bath Chair

(MADE WITH MECCANO OUTFIT No 1.)

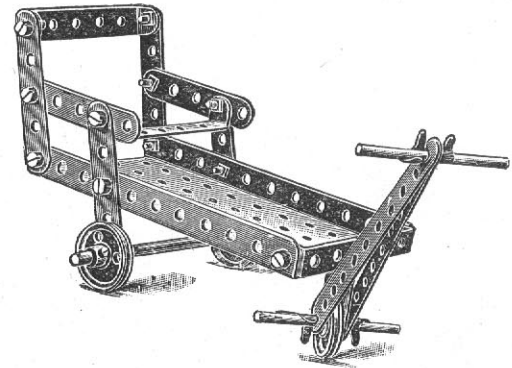

PARTS REQUIRED.

2 of No.	2	3 of No.	22
6 " "	5	14 " "	37
3 " "	60	4 " "	35
1 " "	15	1 " "	44
2 " "	17	1 " "	52

MODEL No. 19

Endless Rope Railway

(MADE WITH MECCANO OUTFIT No. 1.)

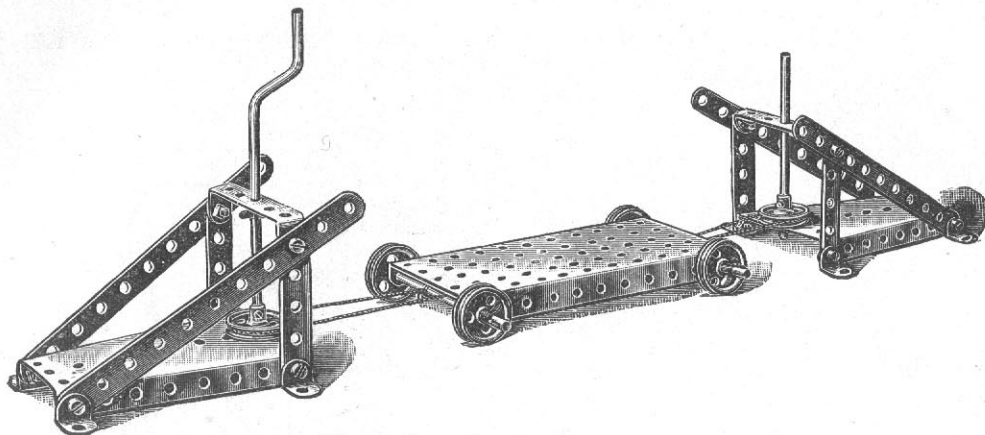

PARTS REQUIRED.

4 of No.	2	2 of No.	22A
4 " "	5	4 " "	35
8 " "	12	12 " "	37
3 " "	15	1 " "	52
1 " "	19	2 " "	54
4 " "	22	2 " "	60

This is an attractive little combination working model, which will well repay a little trouble in making.

The truck is connected to an endless cord which passes from a pulley attached to a bracket at one end to another pulley carried on the crank handle shown. In the illustration the two pulleys are shown close together to save space, but they may, of course, be placed at any desired distance apart.

A length of cord is formed into an endless rope running over the two pulleys, and the truck is attached to one side of the string, so that by rotating the handle in one direction or another the truck is moved as desired.

MODEL No. 20

Swing

(MADE WITH MECCANO OUTFIT No. 1.)

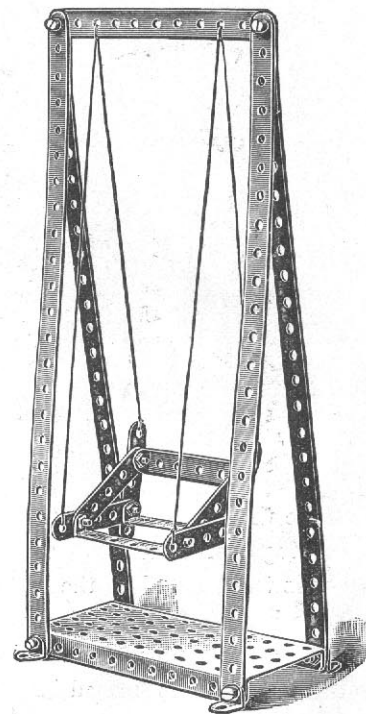

PARTS REQUIRED.

4 of No.	1	4 of No.	12
1 " "	2	12 " "	37
6 " "	5	1 " "	52
		3 of No.	60

MODEL No. 21 Step Ladder

(MADE WITH MECCANO OUTFIT No. 1.)

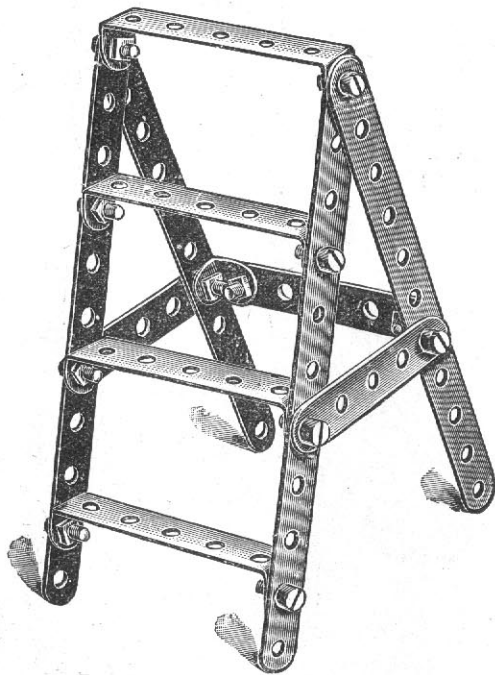

PARTS REQUIRED.

4	of	No. 2
3	"	5
4	"	60
2	"	12
12	"	37

MODEL No. 22 Travelling Ladder

(MADE WITH MECCANO OUTFIT No. 1.)

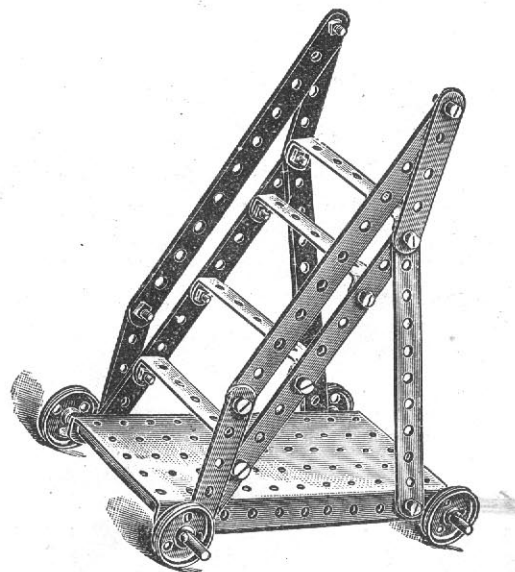

PARTS REQUIRED.

6	of	No. 2	4	of	No. 22
4	"	5	16	"	37
4	"	60	1	"	52
2	"	15			

MODEL No. 23 Go Chair

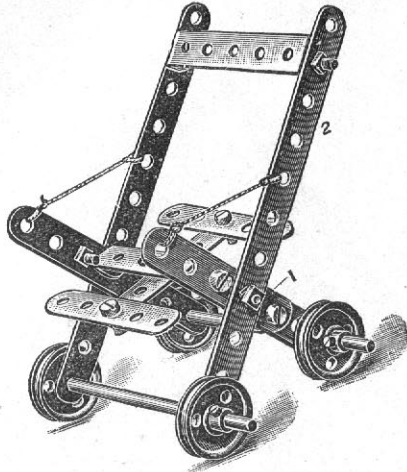

(MADE WITH
MECCANO OUTFIT
No. 1.)

PARTS REQUIRED.

2 of No.	2
7 " "	5
2 " "	60
2 " "	15
4 " "	22
13 " "	37

Proceed to construct one side of this Model first by taking two $2\frac{1}{2}$ " strips 1 and bolting them together overlapped three holes; after which attach diagonally a $5\frac{1}{2}$ " strip 2 in the fourth hole from the bottom, and with the same bolt a $2\frac{1}{2}$ " bent strip on the inside. The other side is constructed in a similar manner. The sides are then brought together and connected by the $2\frac{1}{2}$ " bent strip.

The seat is then formed by bolting a $2\frac{1}{2}$ " strip at right angles with the central $2\frac{1}{2}$ " bent strip, and a further $2\frac{1}{2}$ " strip at each end.

The back is formed by connecting a $2\frac{1}{2}$ " bent strip in the second hole from the top of the two $5\frac{1}{2}$ " side strips. Two axle rods are then passed through the bottom holes, and the wheels placed in position, and secured by clips.

MODEL No. 24 Cot on Wheels

(MADE WITH MECCANO OUTFIT No. 1.)

PARTS REQUIRED

4 of No.	2
6 " "	5
3 " "	60
2 " "	12
4 " "	22
17 " "	37

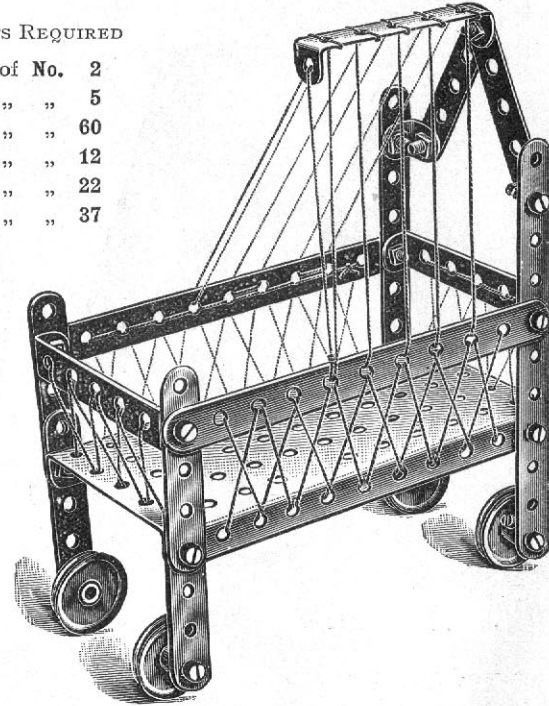

In the construction of this Model it will only be necessary to say that the two front uprights are formed by $2\frac{1}{2}$ " strips overlapped two holes. The wheels are secured, as shown in standard detail R, in the bottom holes.

MODEL No. 25 Telpher Span

(MADE WITH MECCANO OUTFIT No. 1.)

PARTS REQUIRED.

2 of No. 1	1	1 of No. 19
2 " " 2	2	3 " " 22
6 " " 5	5	2 " " 22A
3 " " 60	60	20 " " 37
4 " " 12	12	6 " " 35
2 " " 15	15	1 " " 44
1 " " 17	17	1 " " 52
		2 " " 54

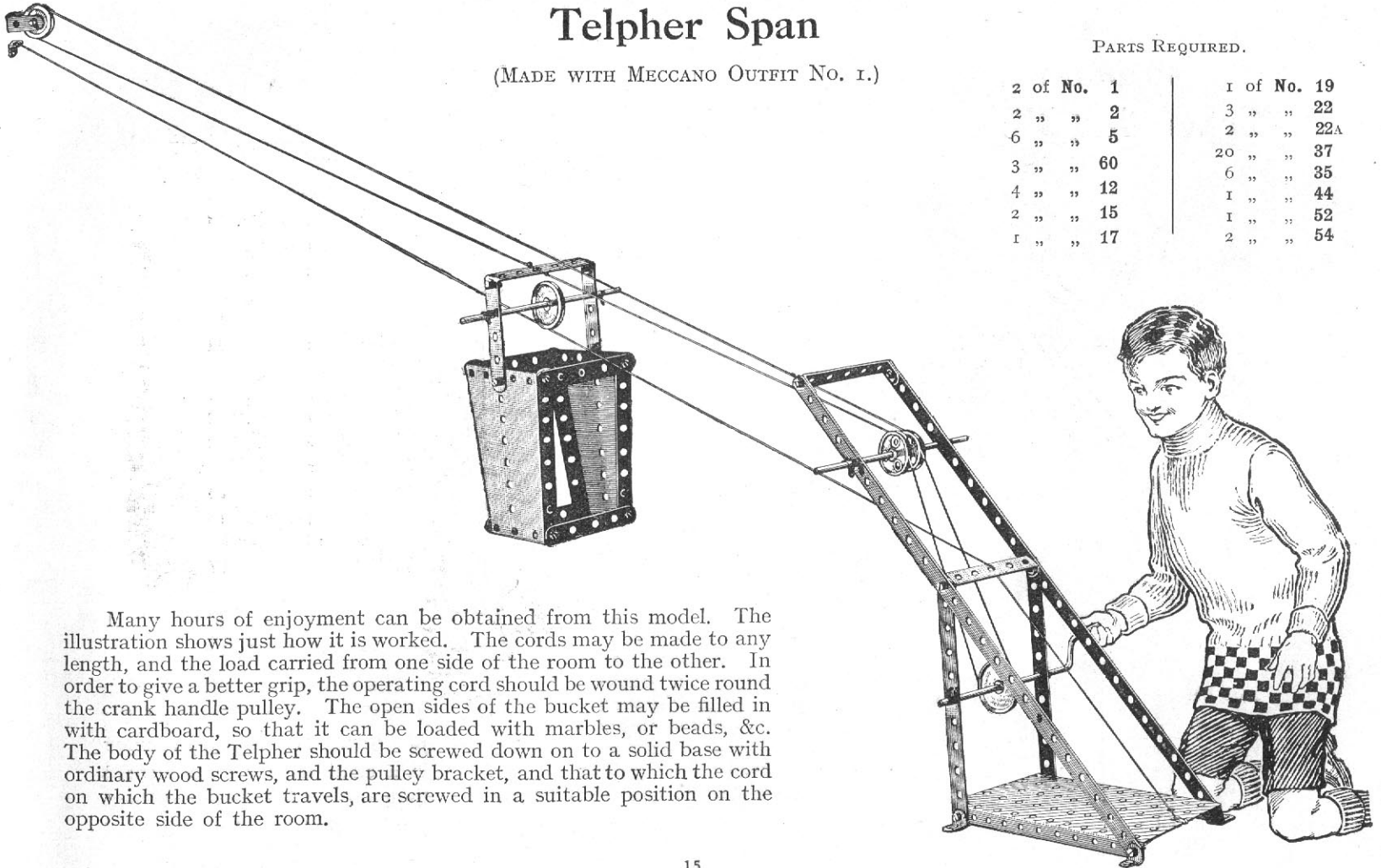

Many hours of enjoyment can be obtained from this model. The illustration shows just how it is worked. The cords may be made of any length, and the load carried from one side of the room to the other. In order to give a better grip, the operating cord should be wound twice round the crank handle pulley. The open sides of the bucket may be filled with cardboard, so that it can be loaded with marbles, or beads, &c. The body of the Telpher should be screwed down on to a solid base with ordinary wood screws, and the pulley bracket, and that to which the cord on which the bucket travels, are screwed in a suitable position on the opposite side of the room.

Types of Cranes

(MADE WITH MECCANO OUTFIT NO. I.)

MODEL No. 26
Travelling Jib Crane

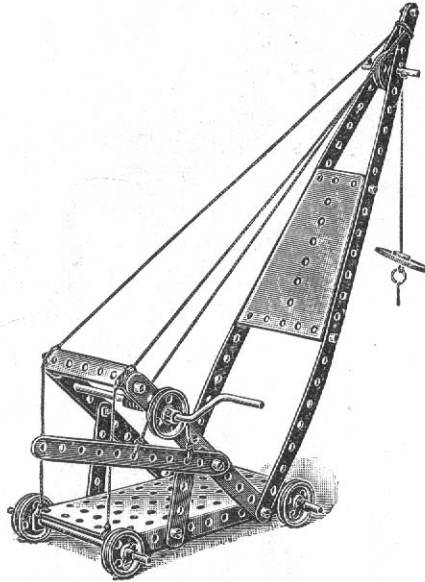

PARTS REQUIRED.

2 of No.	1	2 of No.	22A
3 "	2	1 "	24
2 "	5	15 "	37
1 "	60	1 "	57
2 "	15	5 "	35
1 "	17	1 "	52
1 "	19	1 "	54
4 "	22		

MODEL No. 27
Swivelling Crane

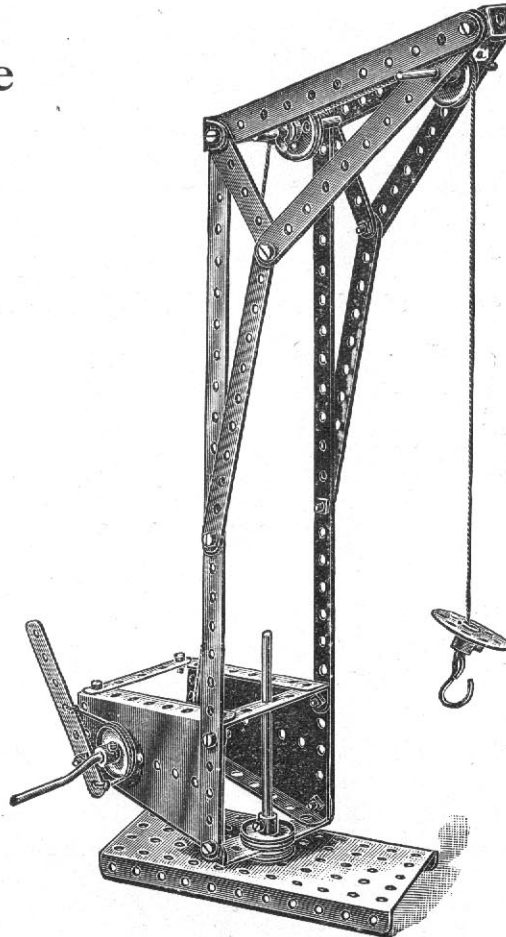

PARTS REQUIRED.

2 of No.	1
6 "	2
1 "	3
4 "	5
3 "	60
1 "	11
1 "	15
2 "	17
1 "	19
4 "	22
2 "	22A
1 "	24
4 "	35
18 "	37
1 "	57
1 "	44
1 "	52
2 "	54

The hoisting cord after passing over the pulley at the end of the jib, passes over a pulley running in a cranked bent strip secured by a nut and bolt to the $2\frac{1}{2}$ " bent strip at the back of the jib.

Types of Cranes—(continued)

(MADE WITH MECCANO OUTFIT NO. 1.)

MODEL No. 28

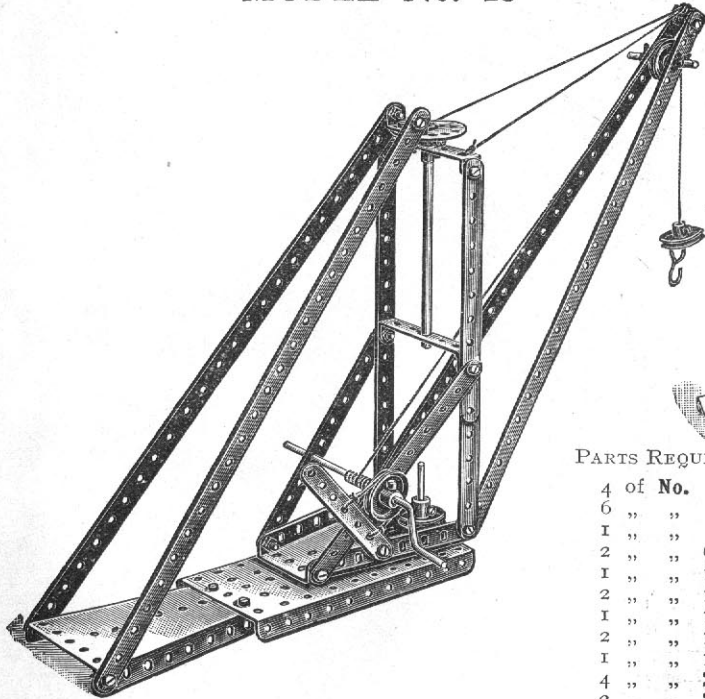

PARTS REQUIRED.

4	of	No.	1
6	"	"	2
1	"	"	3
2	"	"	60
1	"	"	11
2	"	"	12
1	"	"	15
2	"	"	17
1	"	"	19
4	"	"	22
2	"	"	22A
1	"	"	24
4	"	"	35
20	"	"	37
1	"	"	57
1	"	"	52
2	"	"	54

MODEL No. 29

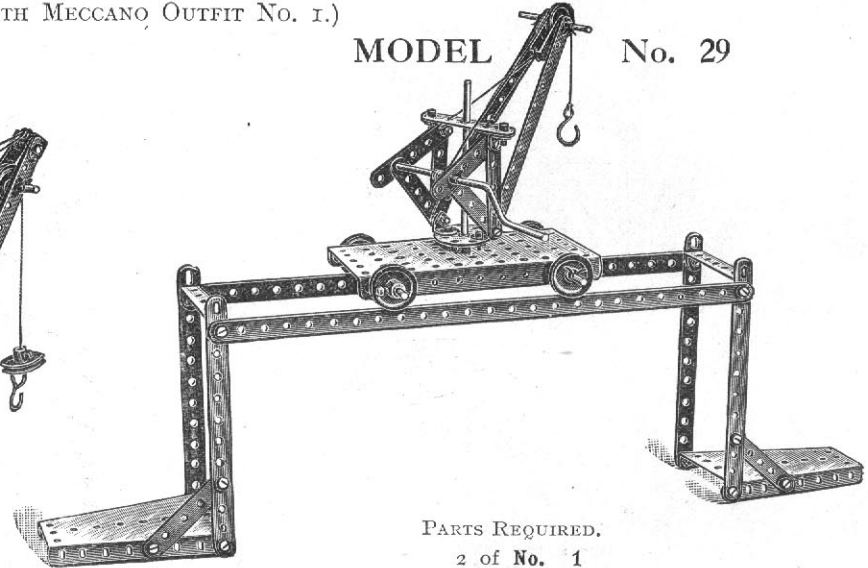

PARTS REQUIRED.

2	of	No.	1
6	"	"	2
9	"	"	5
2	"	"	60
4	"	"	10
4	"	"	12
3	"	"	15
1	"	"	17
1	"	"	19
4	"	"	22
2	"	"	22A
1	"	"	24
6	"	"	35
20	"	"	37
1	"	"	57
1	"	"	44
1	"	"	52
2	"	"	54

MODEL No. 30 Swivelling Jib Crane

(MADE WITH MECCANO OUTFIT NO. I.)

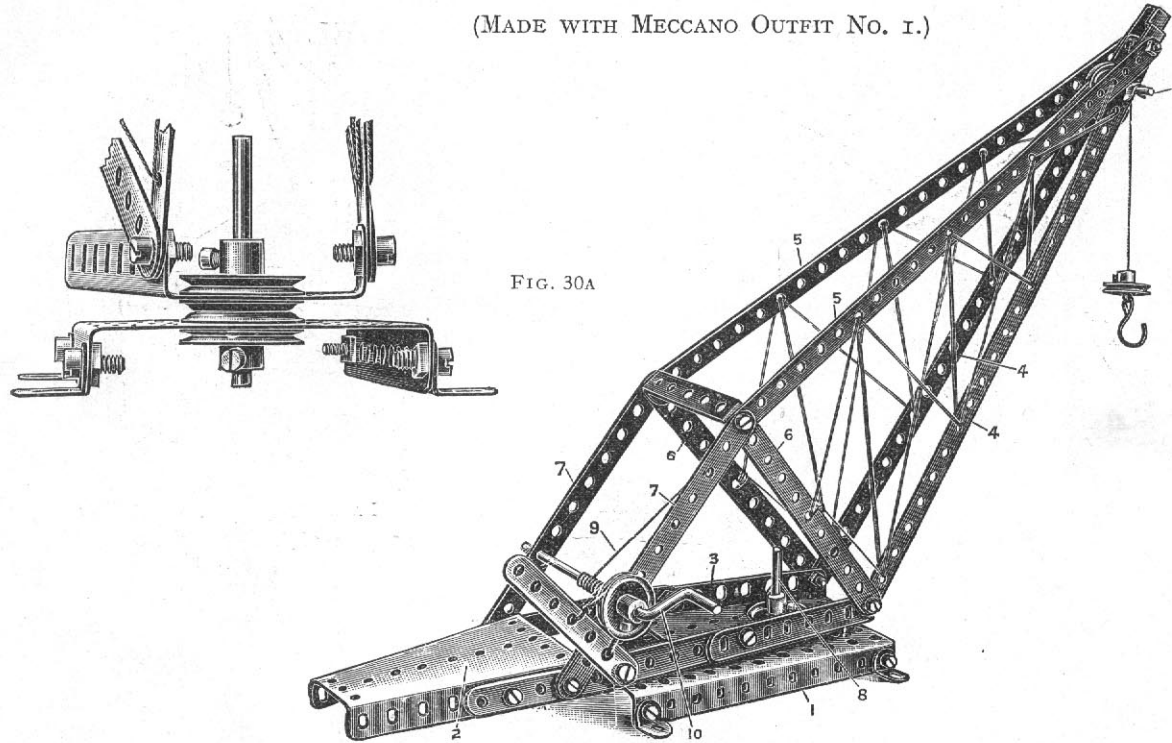

FIG. 30A

PARTS REQUIRED.

4	of	No.	1
6	"	"	2
I	"	"	3
I	"	"	60
4	"	"	12
2	"	"	17
I	"	"	19
4	"	"	22
2	"	"	22A
3	"	"	35
18	"	"	37
I	"	"	44
I	"	"	52
2	"	"	54

The fixed base of this Crane is a perforated flanged plate 1, and the swivelling base of the Crane is formed by two sector plates 2 and 3. The jib is formed from two $1\frac{1}{2}$ " strips 4 bolted to the ends of the sector plate 3, two other $1\frac{1}{2}$ " strips 5 being bolted to the top of the strips 4 and to cross strips 6, the outer ends of these latter strips being stayed by strips 7 bolted to the other sector plate. The upper structure of the Crane swivels about a rod 8, and is secured as shown in Fig. 30A. The winding rope 9 is operated by the crank handle 10 and passes over a pulley in the head of the Crane on a short rod 11.

MODEL No. 31

Turntable Gangway

(MADE WITH MECCANO OUTFIT No. 1.)

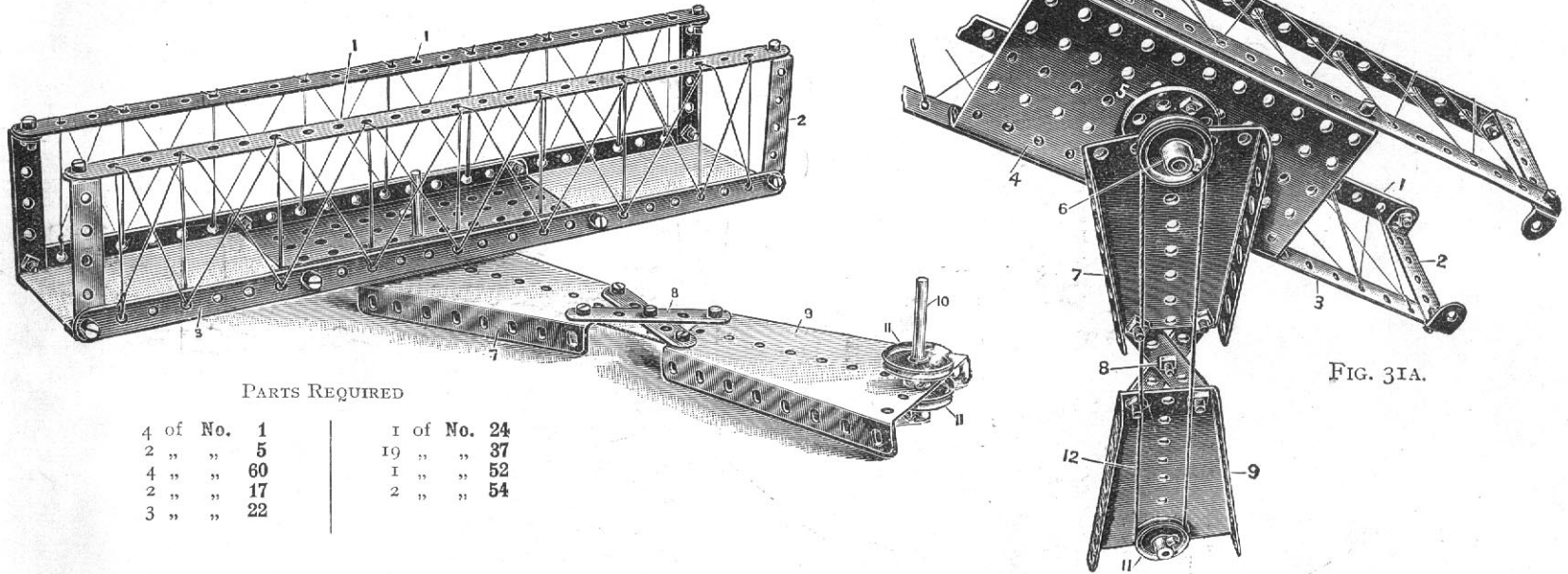

FIG. 31A.

PARTS REQUIRED

4 of No.	1	1 of No.	24
2 " "	5	19 " "	37
4 " "	60	1 " "	52
2 " "	17	2 " "	54
3 " "	22		

The side frames of the gangway are made of $12\frac{1}{2}$ " strips 1 bolted by means of $2\frac{1}{2}$ " bent strips 2 to lower strips 3, the strips 3 and 1 being set at right angles to each other, and the side frames being connected by a perforated flanged plate 4. A bush wheel 5 is bolted to the under side of the flanged plate and fitted with a rod on which is mounted a 1" pulley 6, the rod passing through one of the end holes of a sector plate 7. This sector plate 7 is connected by diagonal strips 8 to another sector plate 9, through the end hole of which a rod 10 is threaded carrying two 1" pulleys 11. An operating cord 12 passes from the pulley 11 to the pulley 6. In this way the gangway may be rotated by operating the spindle 10.

Types of Railway Signals

(MADE WITH MECCANO OUTFIT No. 1.)

MODEL No. 32

MODEL No. 33

MODEL No. 34

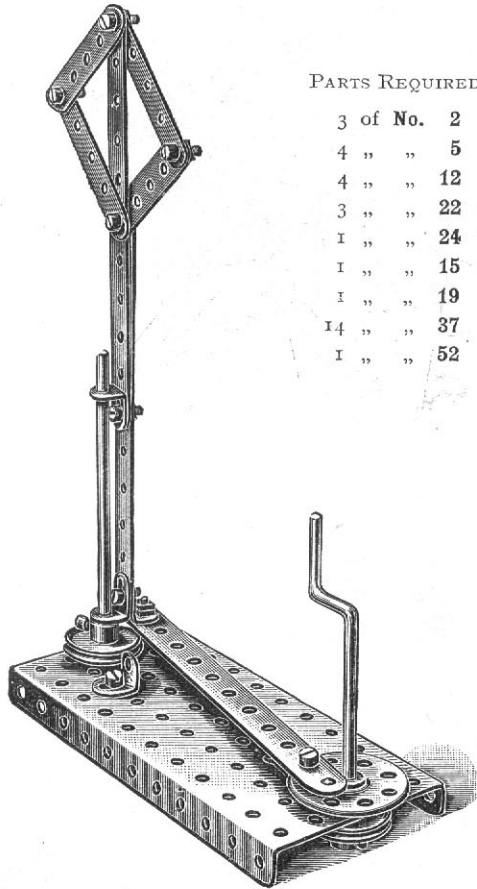

PARTS REQUIRED

3 of No.	2
4 " "	5
4 " "	12
3 " "	22
1 " "	24
1 " "	15
1 " "	19
14 " "	37
1 " "	52

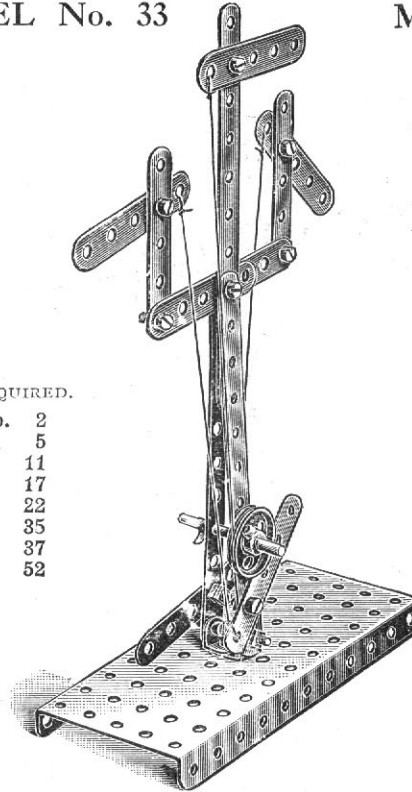

PARTS REQUIRED.

3 of No.	2
9 " "	5
1 " "	11
1 " "	17
1 " "	22
1 " "	35
16 " "	37
1 " "	52

PARTS REQUIRED.

2 of No.	1
2 " "	2
1 " "	3
4 " "	12
1 " "	17
2 " "	22
19 " "	37
2 " "	35
1 " "	52
1 " "	54

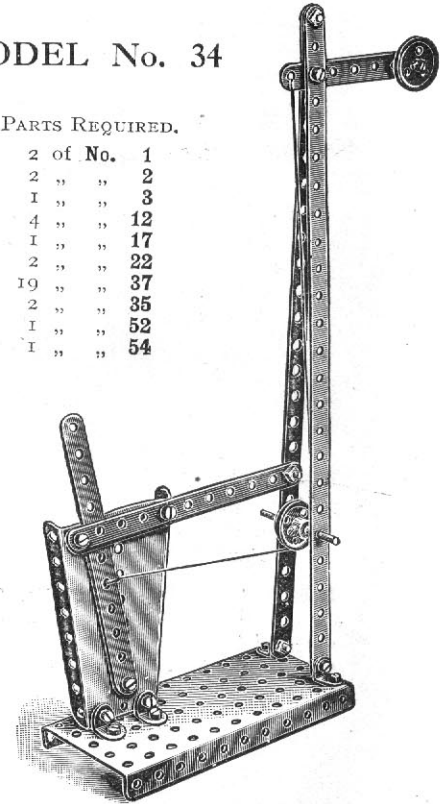

The two outside signals of this Model are operated by the levers pivoted to the upright, and the centre signal by the pulley wheel. The cord operating this latter signal is securely tied round the pulley wheel so that when the wheel is turned the signal is raised or lowered.

In fixing the lever to the lower end of the sector plate, lock the nuts, as shown in standard detail D, so as to prevent the screw from working out.

Types of Scales

(MADE WITH MECCANO OUTFIT NO. I.)

MODEL No. 35

MODEL No. 36

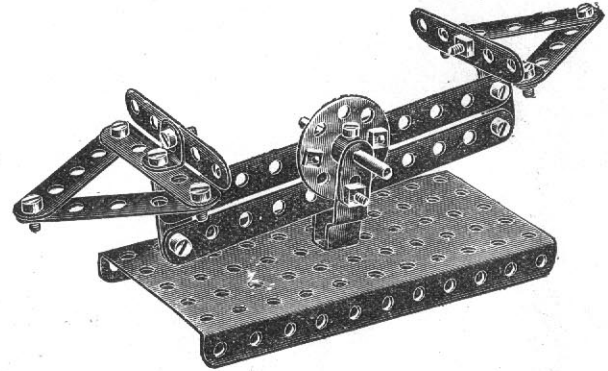
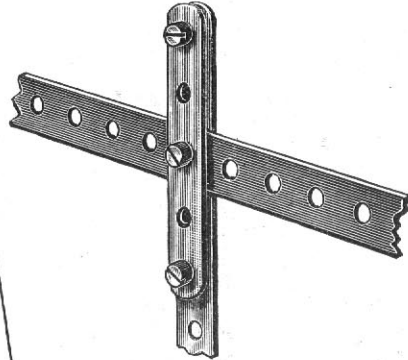
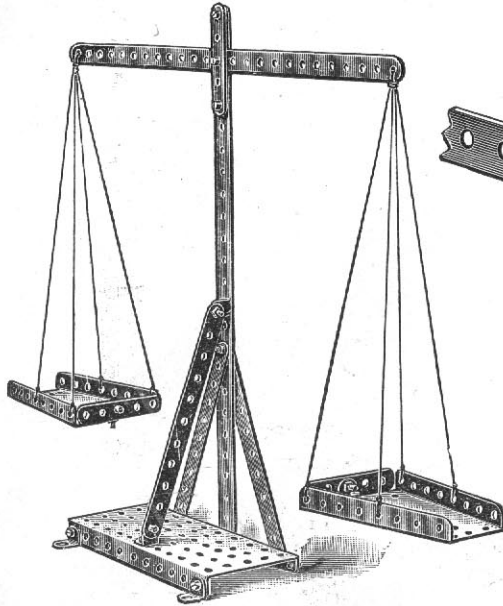

PARTS REQUIRED.

2 of No. 1	4 of No. 12
3 " " 2	19 " " 37
1 " " 5	1 " " 52
2 " " 60	2 " " 54

The scale beam of this model is pivoted in a slot at the top of the upright standard. This slot is formed by bolting a $2\frac{1}{2}$ " strip to the standard, nuts being placed between the strip and the standard before screwing up. These nuts hold the strip and the standard at the required distance apart to give the beam free play.

PARTS
REQUIRED.

2 of No. 2
8 " " 5
4 " " 10
4 " " 12
1 " " 17
1 " " 24
19 " " 37
1 " " 44
1 " " 52

MODEL No. 37

Joy Wheel

(MADE WITH MECCANO OUTFIT NO. 1.)

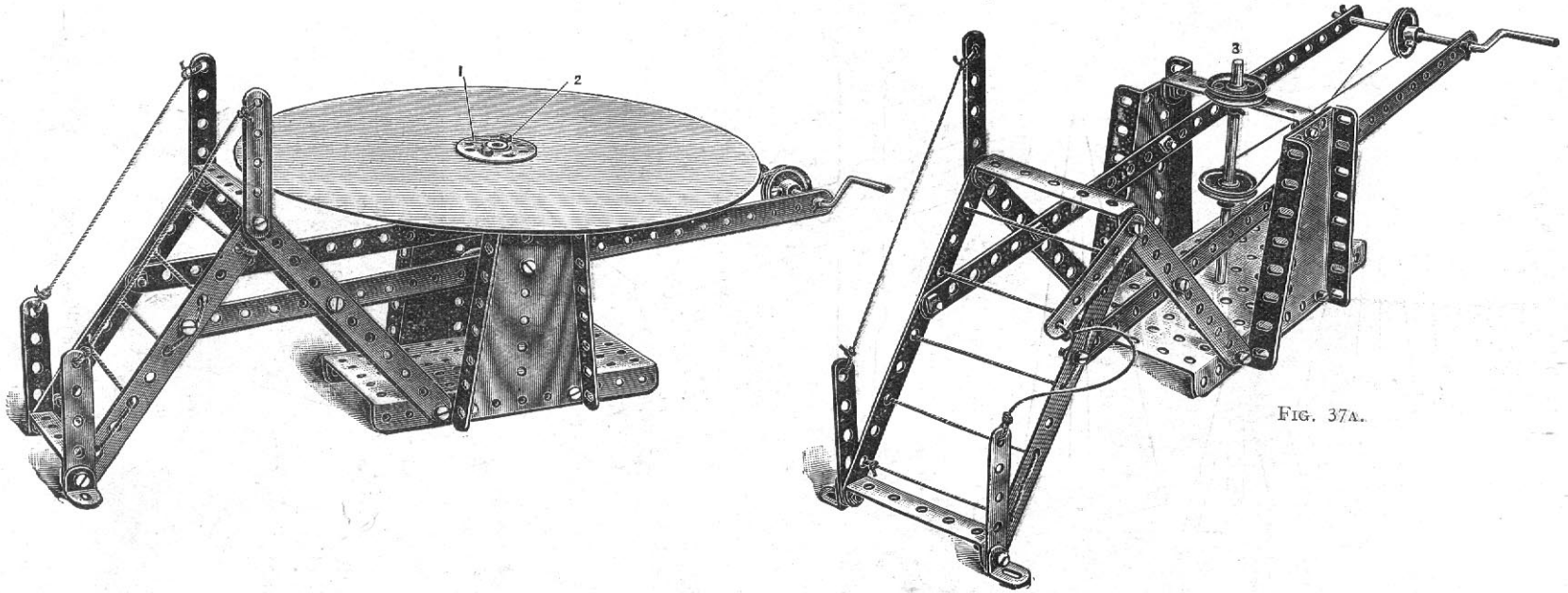

FIG. 37A.

PARTS REQUIRED.

2 of No. 1	3 of No. 22
4 " " 2	1 " " 24
4 " " 5	3 " " 35
3 " " 60	20 " " 37
2 " " 12	1 " " 52
1 " " 15	2 " " 54
1 " " 19	

The driving mechanism and construction of the framework of this model are clearly brought out in Fig. 37A. Cut out a circular piece of cardboard, 8" in diameter, and in the centre of the disc fix a bush wheel 1 by nuts and bolts 2. The eye of the bush wheel is then threaded over the top of the vertical spindle 3, and secured by its set screw.

MODEL No. 38 Round-about

(MADE WITH MECCANO OUTFIT NO. I.)

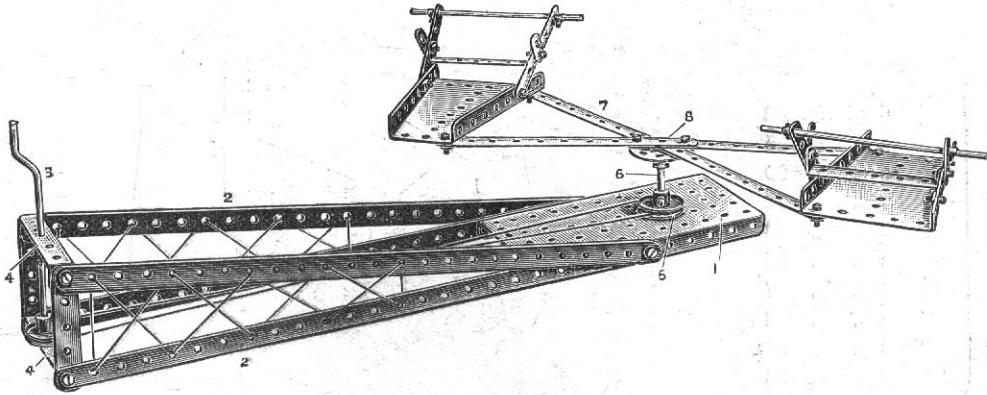

PARTS REQUIRED.

4 of	No. 1
4 "	" 2
6 "	" 5
4 "	" 10
2 "	" 15
1 "	" 17
1 "	" 19
3 "	" 22
1 "	" 24
5 "	" 35
20 "	" 37
1 "	" 52
2 "	" 54
4 "	" 60

In this model, begin by making the platform from the flanged plate 1 and 12½" strips 2. The bearings of the crank handle 3 are formed in 2½" bent strips 4. The drive from the pulley on the crank is taken to a 1" pulley 5, fast on the spindle 6, another similar pulley being secured to the spindle beneath the flanged plate. The arms 7, formed of four 5½" strips, are bolted to a bush wheel 8 fast on the spindle 6.

MODEL No. 39 Motor Cart

(MADE WITH MECCANO OUTFIT NO. I.)

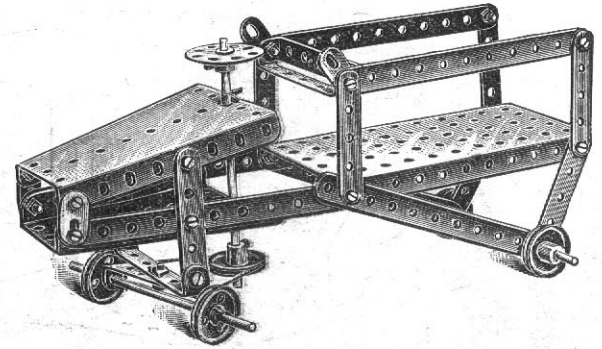

PARTS REQUIRED.

6 of	No. 2
8 "	" 5
4 "	" 10
3 "	" 15
3 "	" 22
2 "	" 22A
1 "	" 24
3 "	" 35
20 "	" 37
1 "	" 52
2 "	" 54
4 "	" 60

MODEL No. 40

Snow Plough

(MADE WITH MECCANO OUTFIT NO. 1.)

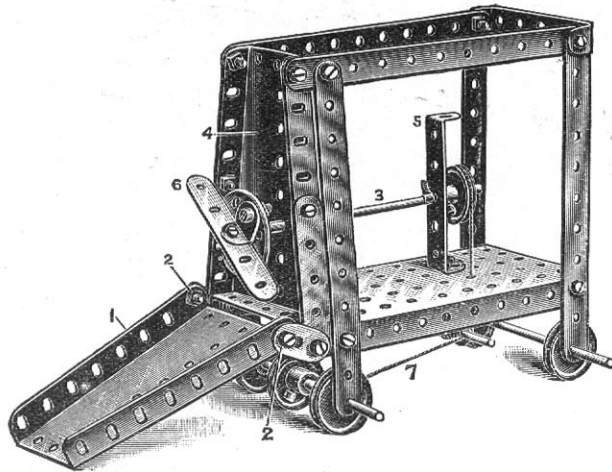

PARTS REQUIRED.

6 of No.	2
3 "	5
2 "	60
2 "	10
1 "	12
3 "	15
1 "	17
4 "	22
2 "	22A
1 "	24
4 "	35
19 "	37
1 "	44
1 "	52
2 "	54

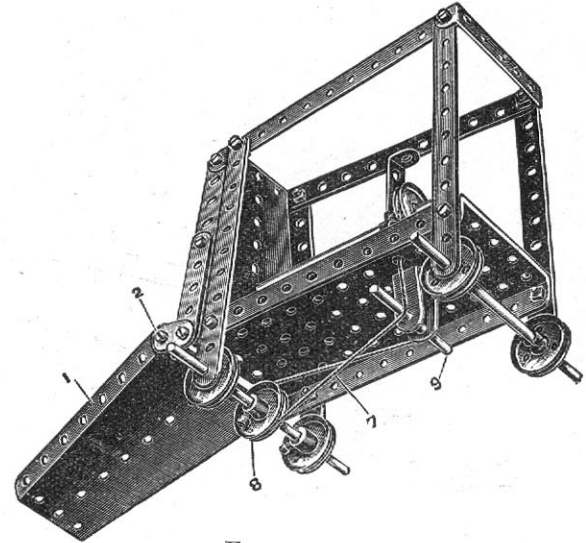
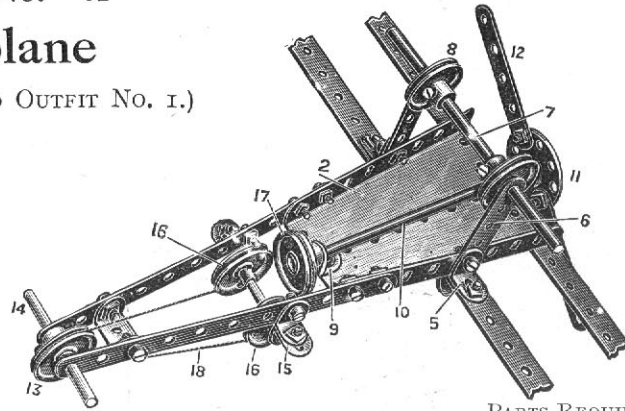
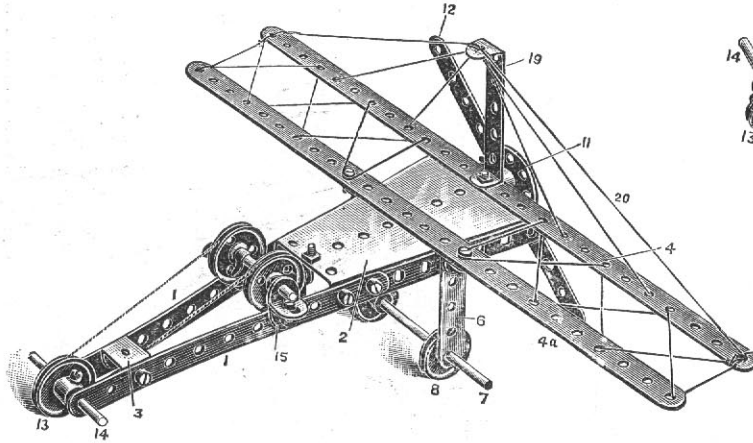

FIG. 40A.

The construction of the framework of this Model presents no difficulty. The sector plate 1 forming the plough is loosely pivoted on the bolts 2. The axle 3 is mounted in the front sector plate 4 and the $2\frac{1}{2}$ " bent strip 5. A $2\frac{1}{2}$ " strip 6 is bolted by angle brackets to a bush wheel on the front of the axle and forms a dispersing propeller for the snow after it rises up the inclined sector plate 1. A continuous cord 7 is passed round a 1" pulley wheel 8 and round a short axle 9 and a 1" pulley wheel on the propeller axle. In this way, as the plough is moved along the track, the propeller is revolved.

MODEL No. 41 Monoplane

(MADE WITH MECCANO OUTFIT NO. I.)



PARTS REQUIRED.

2 of No.	1
2 " "	2
4 " "	5
1 " "	11
8 " "	12
2 " "	15
1 " "	17
4 " "	22
2 " "	22A
1 " "	24
2 " "	35
18 " "	37
1 " "	54
1 " "	60

Begin by bolting two $5\frac{1}{2}$ " strips 1 to the ends of a sector plate 2; these strips are connected together at the tail by a double angle bracket 3. The two $12\frac{1}{2}$ " strips 4 and 4A are then bolted to the sector plate 2, the outer strip 4 being bolted direct, and the inner strip 4A by means of angle brackets 5 which also are bolted to the supports 6 which carry a rod 7 on which are mounted the wheels 8. Angle brackets 9 are then bolted to the ends of the sector plate 2, and a rod 10 to form the shaft of the propeller 12 is threaded in these angle brackets and fitted at the forward end with a bush wheel 11 to which are bolted two $2\frac{3}{4}$ " perforated strips 12 to form the propeller blades. In the extreme end of the strips 1, a 1" pulley wheel 13 is mounted on a short rod 14, and carried from double reversed angle brackets 15 connected to the side strips 1 is a pair of inch pulleys 16 round which and the rear pulley 13 and another pulley 17 on the shaft 10 is passed a continuous cord 18. As the monoplane is moved along the table, the rear wheel 13 drives the propeller 12. At the front of the sector plate 2 is fitted a $2\frac{1}{2}$ " bent strip 19 from the top of which are carried ties 20 to the front strip 4 of the wings.

MODEL No. 42. Potter's Wheel MODEL No. 43 Drilling Machine

(MADE WITH MECCANO OUTFIT No. I.)

(MADE WITH MECCANO OUTFIT No. I.)

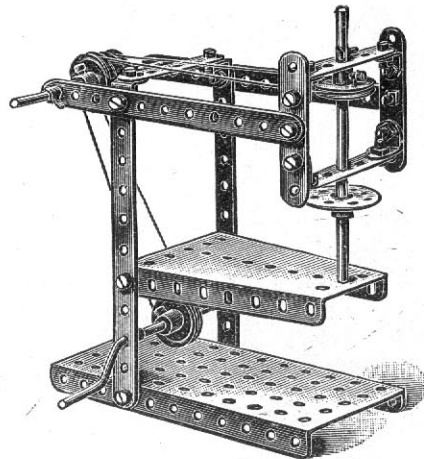
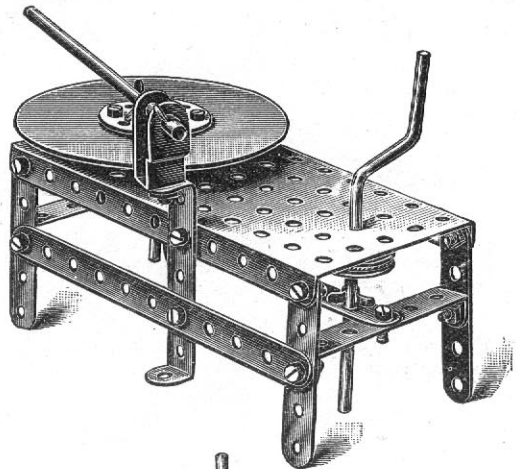

PARTS REQUIRED.

4	of No.	2
5	" "	5
6	" "	12
2	" "	15
I	" "	19
4	" "	22
I	" "	24
4	" "	35
18	" "	37
I	" "	52
I	" "	54

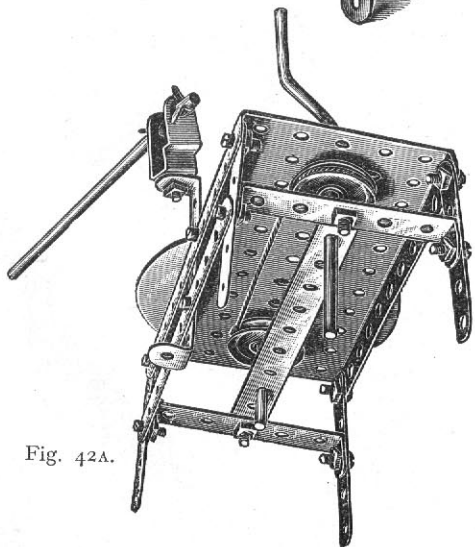
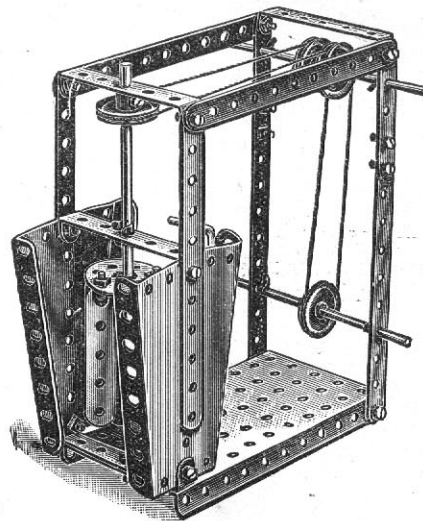

Fig. 42A.

PARTS REQUIRED.

2	of No.	2
4	" "	5
3	" "	60
I	" "	15
I	" "	17
I	" "	19
2	" "	22
I	" "	24
3	" "	35
16	" "	37
I	" "	44
I	" "	52



MODEL No. 44 Churn

(MADE WITH MECCANO OUTFIT No. I.)

PARTS REQUIRED.

6	of No.	2
4	" "	5
2	" "	12
2	" "	15
I	" "	19
2	" "	22
2	" "	22A
I	" "	24
5	" "	35
19	" "	37
I	" "	52
2	" "	54
3	" "	60

MODEL No. 45
High Level Bridge

(MADE WITH MECCANO OUTFIT NO. 1.)

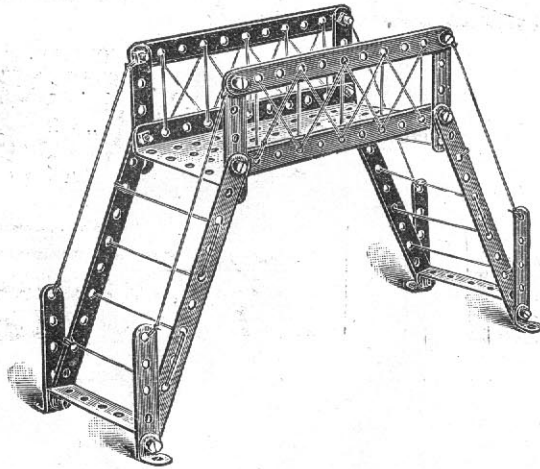

PARTS REQUIRED.

6 of No. 2	4 of No. 12
8 " " 5	12 " " 37
2 " " 60	1 " " 52

MODEL No. 46. **Tip Wagon**

(MADE WITH
 MECCANO OUTFIT
 No. 1.)

PARTS REQUIRED.

1 of No. 2
4 " " 5
2 " " 60
5 " " 12
3 " " 15
4 " " 22
15 " " 37
2 " " 35
1 " " 52

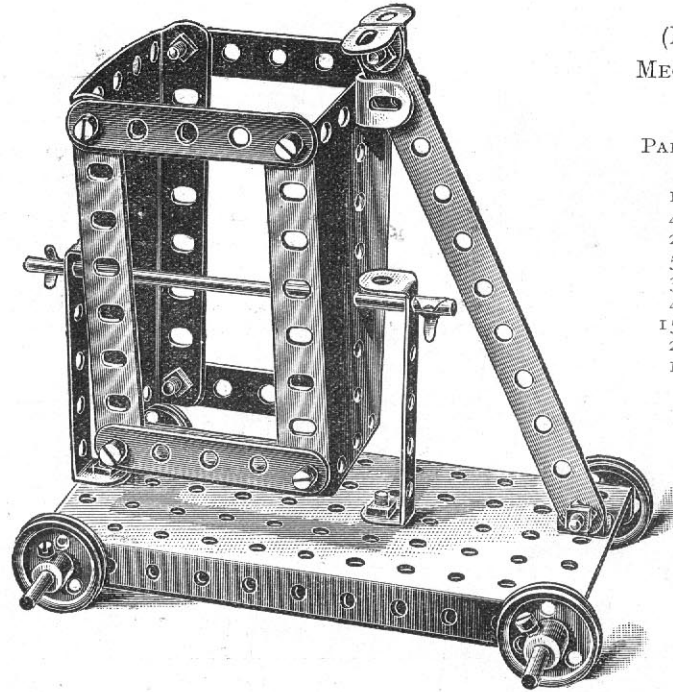

FIG. 46A.

This interesting Model represents a Tip Wagon, such as is used on constructional or embankment work for carrying loads of earth, &c., along a track in such manner that the load may be readily tipped to one side or the other at any required position.

The sides of the Tip consist of sector plates connected at the top and bottom by $2\frac{1}{2}$ " strips. The pivoted lever strip at the end engages between a pair of inclined angle brackets, see Fig. 46A, to lock the Tip. By releasing the lever, the Tip may be swung to either side. To enable the Model to hold material, a bent piece of cardboard may be inserted resting on the axle.

Hoisting Block

MODEL No. 47

(MADE WITH MECCANO OUTFIT No. 1.)

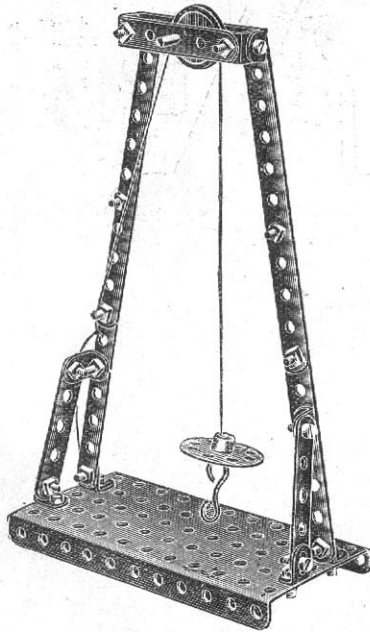

PARTS REQUIRED

4	of	No.	2
3	"	"	5
8	"	"	12
1	"	"	17
1	"	"	22
1	"	"	24
22	"	"	37
1	"	"	52
1	"	"	57
1	"	"	60

Pit Headgear

MODEL No. 48

(MADE WITH MECCANO OUTFIT No. 1.)

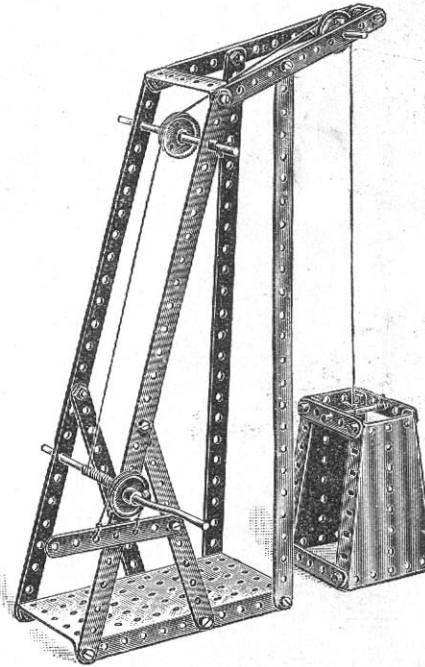

PARTS REQUIRED.

4	of	No.	1
4	"	"	2
1	"	"	3
4	"	"	5
1	"	"	11
1	"	"	15
1	"	"	17
1	"	"	19
3	"	"	22
2	"	"	35
24	"	"	37
1	"	"	52
2	"	"	54

MODEL No. 49 Tower Wagon

(MADE WITH MECCANO OUTFIT NO. 1.)

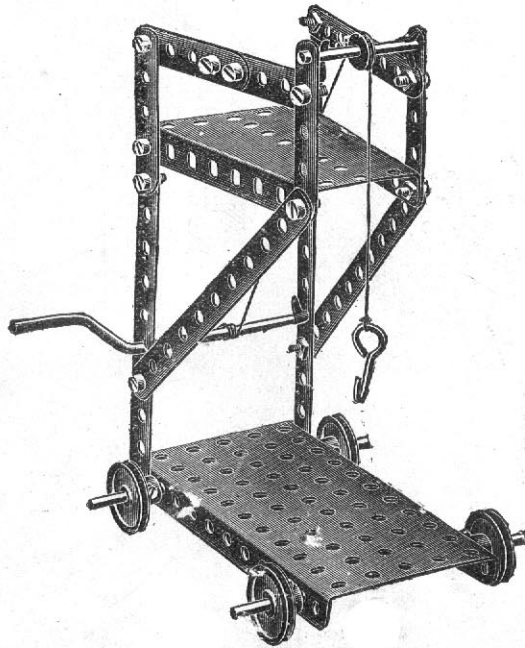

PARTS REQUIRED.

4 of No. 2	1 of No. 23
8 " " 5	4 " " 35
2 " " 15	18 " " 37
1 " " 17	1 " " 52
1 " " 19	1 " " 54
4 " " 22	1 " " 57

MODEL No. 50 Ship

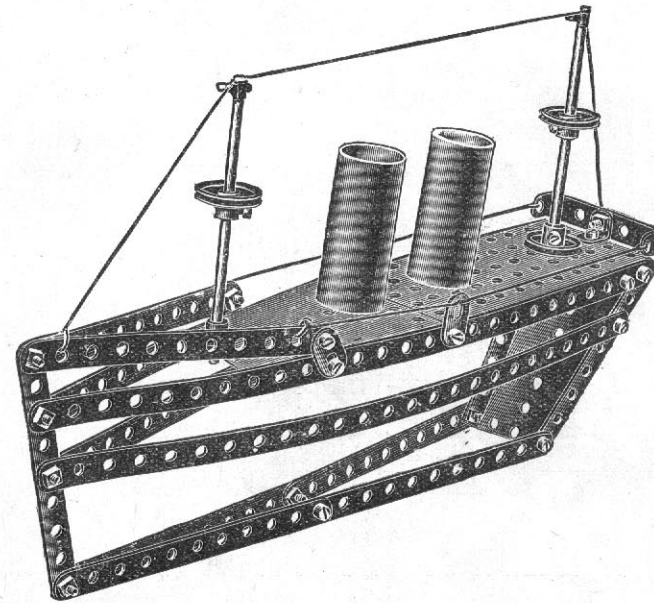

The bow of this ship is formed by two $2\frac{1}{2}$ " strips overlapped one hole, and the funnels rest on two 1" pulley wheels bolted to the plates.

PARTS REQUIRED.

4 of No. 1	4 of No. 22
6 " " 2	2 " " 22A
2 " " 5	2 " " 35
1 " " 60	22 " " 37
4 " " 10	1 " " 52
1 " " 12	2 " " 54
2 " " 15	

MODEL No. 51 Drop Stamp

(MADE WITH MECCANO OUTFIT No. 1.)

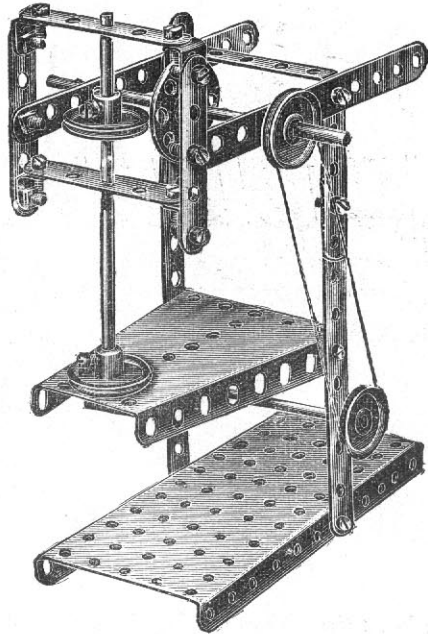

The stamp of this model is raised and dropped by a $2\frac{1}{2}$ " strip attached to a bush wheel similar to Model No. 54.

PARTS REQUIRED.

4 of No. 2	4 of No. 22
7 " " 5	1 " " 24
1 " " 60	2 " " 35
4 " " 12	20 " " 37
2 " " 15	1 " " 52
1 " " 19	

MODEL No. 52 Automatic Dial Press

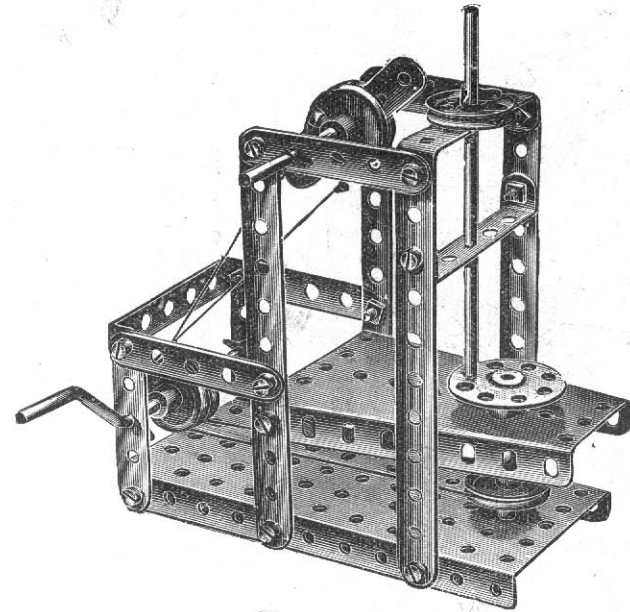

PARTS REQUIRED.

4 of No. 2	2 of No. 22A
7 " " 5	1 " " 24
3 " " 60	6 " " 35
2 " " 15	18 " " 37
1 " " 17	1 " " 52
1 " " 19	1 " " 54
4 " " 22	

MODEL No. 53 Level Crossing Barrier

(MADE WITH MECCANO OUTFIT NO. 1.)

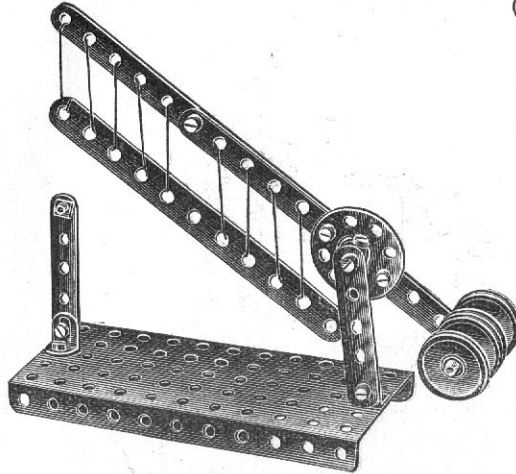

PARTS REQUIRED.

3 of No.	2
2 " "	5
2 " "	12
1 " "	17
4 " "	22
1 " "	24
9 " "	37
1 " "	52

MODEL No. 55 Polishing Spindle

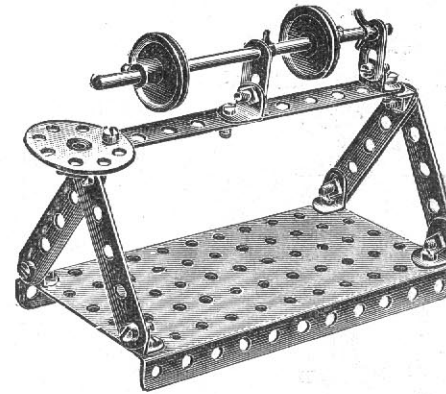

PARTS REQUIRED.

1 of No.	2
4 " "	5
2 " "	10
8 " "	12
1 " "	15
2 " "	22
1 " "	24
2 " "	35
15 " "	37
1 " "	52

MODEL No. 54 Ore Crusher

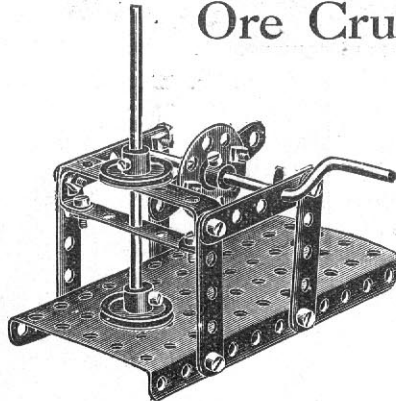

PARTS REQUIRED.

8 of No.	5
2 " "	12
1 " "	15
1 " "	19
2 " "	22
1 " "	24
2 " "	35
12 " "	37
1 " "	52
1 " "	60

MODEL No. 56 Buffing Spindle

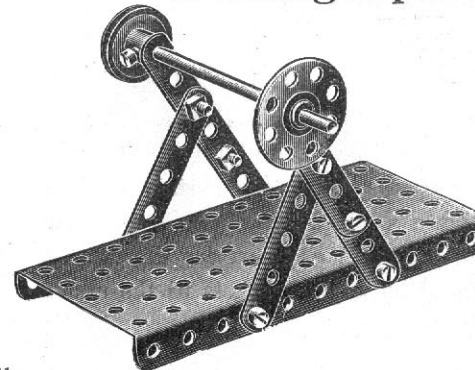

PARTS REQUIRED.

6 of No.	5
1 " "	15
1 " "	22
1 " "	24
8 " "	37
1 " "	52

Types of Lathes

(MADE WITH MECCANO OUTFIT No. 1.)

MODEL No. 57

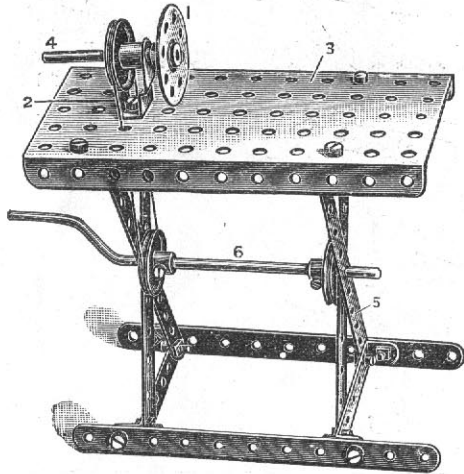

PARTS REQUIRED.

6 of No.	2
2 " "	60
4 " "	12
1 " "	17
1 " "	19
3 " "	22
1 " "	24
17 " "	37
1 " "	44
1 " "	52

This is a very interesting little model, and much amusement can be derived by fixing a piece of modelling clay on the face of the bush wheel 1 and turning various shapes. A single bent strip 2 bolted to the flanged plate 3 carries the spindle 4 of the head-stock. The diagonal legs 5 carrying the driving spindle 6 are bolted by angle brackets to the under side of the plate 3.

MODEL No. 58

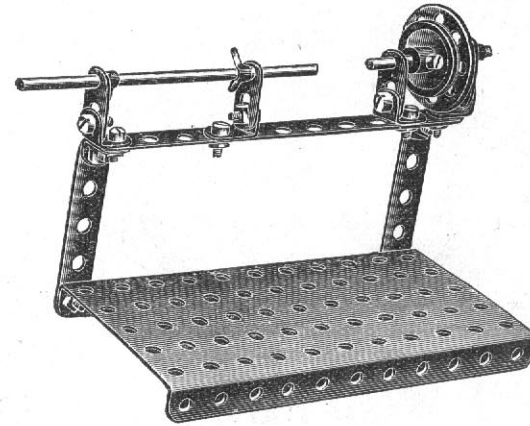

PARTS REQUIRED.

1 of No.	2	1 of No.	22
2 " "	5	1 " "	24
4 " "	10	3 " "	35
6 " "	12	12 " "	37
1 " "	15	1 " "	52
1 " "	17		

MODEL No. 59 Swivelling Crane

(MADE WITH MECCANO OUTFIT NO. 1.)

PARTS REQUIRED.

4	of	No.	2
4	"	"	5
4	"	"	12
2	"	"	17
1	"	"	19
3	"	"	22
1	"	"	22A
2	"	"	35
16	"	"	37
1	"	"	44
1	"	"	52
1	"	"	54
1	"	"	57
1	"	"	60

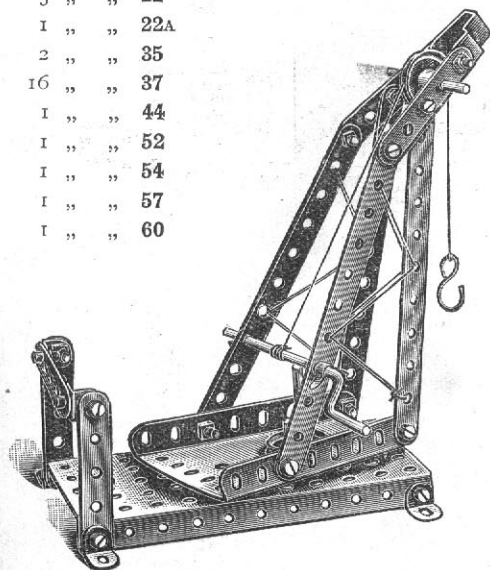

MODEL No. 60 Racing Motor

(MADE WITH MECCANO OUTFIT NO. 1.)

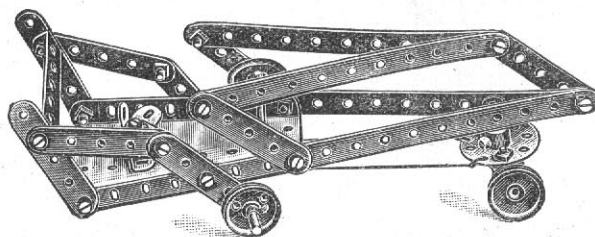
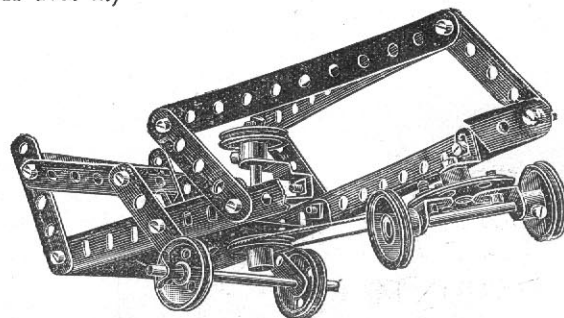

FIG. 60A.

PARTS REQUIRED.

4	of	No.	2	2	of	No.	22A
9	"	"	5	1	"	"	24
2	"	"	10	2	"	"	35
1	"	"	11	21	"	"	37
4	"	"	12	1	"	"	44
1	"	"	15	1	"	"	54
2	"	"	17	1	"	"	60
4	"	"	22				

The sector plate of the Crane in this model is pivoted to the base as in Model No. 30A.

MODEL No. 61

Gangway

(MADE WITH MECCANO OUTFIT No. 1.)

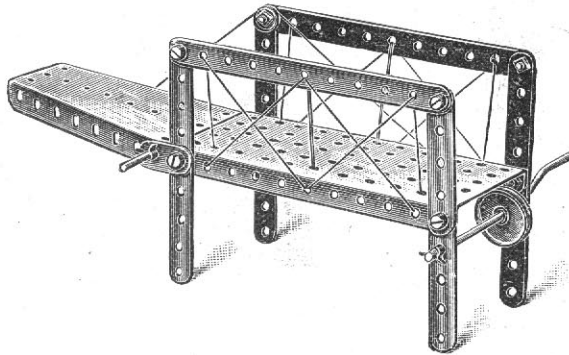

PARTS REQUIRED.

2	of No.	2
8	" "	5
2	" "	10
1	" "	15
1	" "	19
1	" "	22
1	" "	22A
3	" "	35
8	" "	37
1	" "	52
1	" "	54

MODEL No. 62

Stamping Mill

(MADE WITH MECCANO OUTFIT No. 1.)

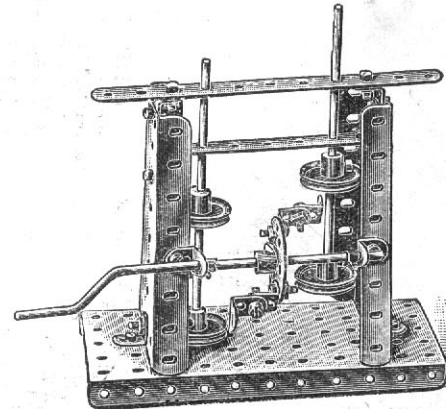

PARTS REQUIRED.

1	of No.	2
1	" "	3
12	" "	12
2	" "	15
1	" "	19
4	" "	22
1	" "	24
2	" "	35
18	" "	37
1	" "	52
2	" "	54

Model No. 62.—This model shows the usual type of Stamp for crushing ore. The stamps are lifted by means of angle brackets bolted to a bush wheel on the cranked handle, engaging the upper 1" pulley wheels on the Stamp spindles.

HOW TO CONTINUE

This completes the Models which may be made with Meccano Outfit No. 1. The next Models are a little more advanced, requiring a number of extra parts to construct them. The necessary parts are all contained in a No. 1A Accessory Outfit, the cost of which will be found in the Price List at the end of the Manual.

MODEL No. 63
Ladder on Wheels

(MADE WITH MECCANO OUTFIT NO. 2 OR NO. 1 AND NO. 1A.)

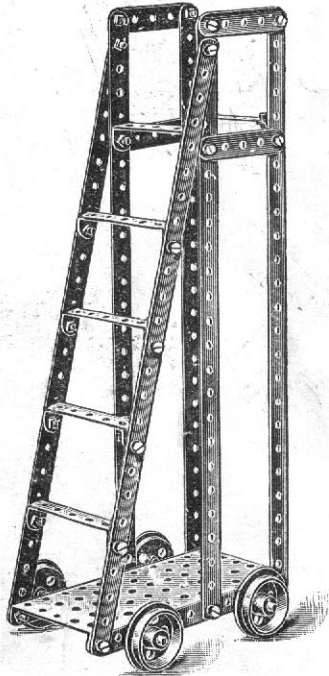

PARTS REQUIRED.

6 of No.	1
4 " "	5
2 " "	15
4 " "	20
24 " "	37
1 " "	52
6 " "	60

MODEL No. 64
Tipping Motor Wagon

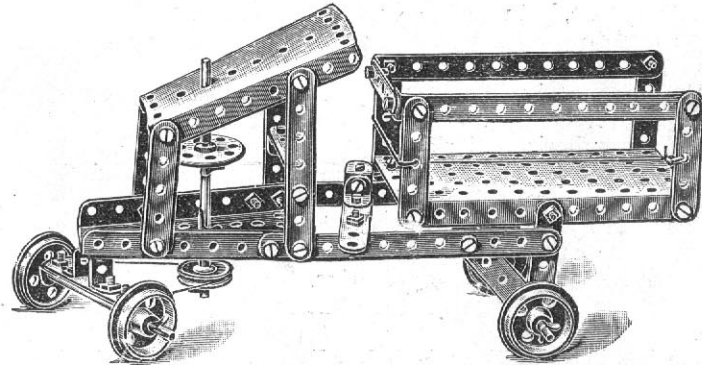

PARTS REQUIRED.

4 of No.	2
2 " "	3
12 " "	5
5 " "	12
3 " "	15
4 " "	20
1 " "	22
1 " "	24
38 " "	37
1 " "	45
1 " "	52
2 " "	54
3 " "	60

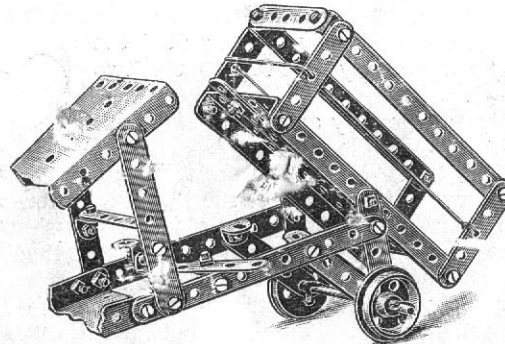

MODEL No. 65. Travelling Jib Crane

(MADE WITH MECCANO OUTFIT NO. 2 OR NO. 1 and NO. 1A.)

This is so important a model that we have thought it best to give a detailed description of it, making use of engineering terms. It can be erected from a study of the illustration alone, but we strongly recommend our enthusiastic young friend to carefully read our instructions, and to make himself familiar with the correct technical description and terms. This model will well repay the time expended on a close and careful study.

The lower horizontal sides of the Crane should first be put together. Each side consists of an angle girder joined at one end to a flanged plate, two holes overlapping, and at the other end by a $2\frac{1}{2}$ " strip. The winch frame is formed of two sector plates bolted to the flanged plate and connected together at their tops by two $2\frac{1}{2}$ " strips. The wheel axles are inserted through appropriate holes in the ends of the horizontal frame.

The bearings for the winch handle are formed by two holes in the sector plates; the winch handle has a pulley wheel and a strip is pivoted to the right-hand sector plate, to form a brake wheel and lever.

Each side of the jib is constructed of two $12\frac{1}{2}$ " strips, jointed together by overlapping; at the top where the sides meet a pulley is fixed on a short length of spindle, and at the bottom the two sides are respectively screwed to the two ends of the horizontal base.

The jib is braced by two diagonally arranged $12\frac{1}{2}$ " strips attached to the sides of the jib by angle pieces.

From each side of the jib two $12\frac{1}{2}$ " strips are carried to a truss member, formed of two $12\frac{1}{2}$ " strips united together, secured at one end to the screws at the base of the jib, and united at their other ends by a $2\frac{1}{2}$ " bent strip. The truss frame is connected to the horizontal base by two $5\frac{1}{2}$ " strips as shown.

The rope by which the weight is raised has one end fixed to the end of the jib; it is then passed round the pulley block, then over the jib pulley, and finally connected to the winch handle.

The Crane is further strengthened by strings to represent tie rods, which connect the ends of the jib, the truss frame, and the winch frame as shown. The joint between the truss frame, the side frame, and the jib, should be made with a single pair of screws which should also carry the angle pieces for the cross bracing of the Crane.

PARTS REQUIRED.

10 of No.	1	5 of No.	35
3 " "	2	1 " "	44
3 " "	5	1 " "	52
1 " "	60	2 " "	54
2 " "	8		
4 " "	12		
2 " "	12		
2 " "	17		
1 " "	19		
4 " "	20		
2 " "	22		
1 " "	22 ^A		
1 " "	24		
35 " "	37		
1 " "	57		

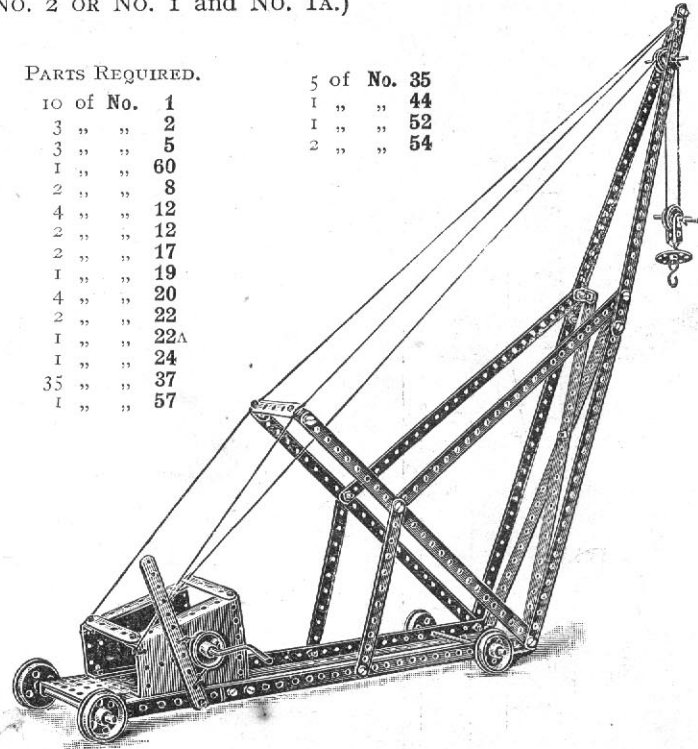

MODEL No. 66 Small Windmill

(MADE WITH MECCANO OUTFIT No. 2.)

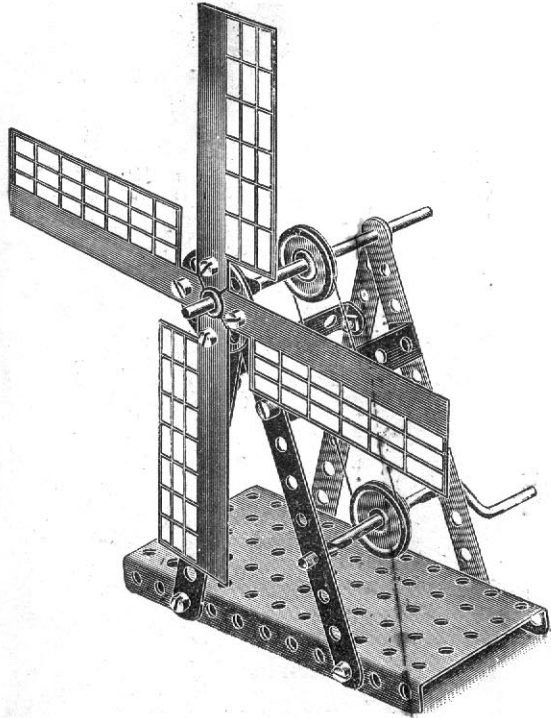

PARTS REQUIRED.

4	of	No.	2
2	"	"	60
1	"	"	15
1	"	"	19
2	"	"	22
1	"	"	24
12	"	"	37
3	"	"	35
1	"	"	52
4	"	"	61

MODEL No. 67 Windmill

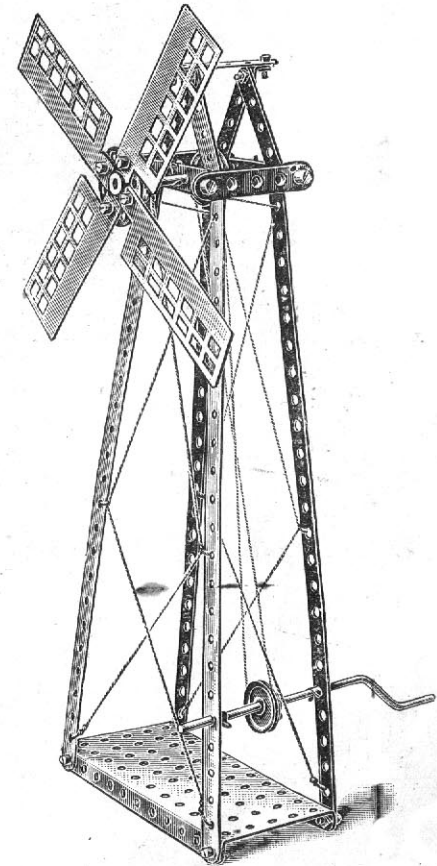

PARTS REQUIRED.

4	of	No.	1
7	"	"	5
2	"	"	60
2	"	"	12
1	"	"	15
1	"	"	19
2	"	"	22
1	"	"	24
20	"	"	37
4	"	"	35
1	"	"	52
4	"	"	61

This model may be driven by the No. 1 Meccano Spring Motor

MODEL No. 68. Windmill

(MADE WITH MECCANO OUTFIT NO. 2 OR NO. 1 AND NO. 1A.)

PARTS REQUIRED.

10 of No. 1	1 of No. 15
13 " " 2	1 " " 19
2 " " 3	2 " " 22
2 " " 5	1 " " 24
4 " " 8	4 " " 35
4 " " 12	45 " " 37
	2 " " 54

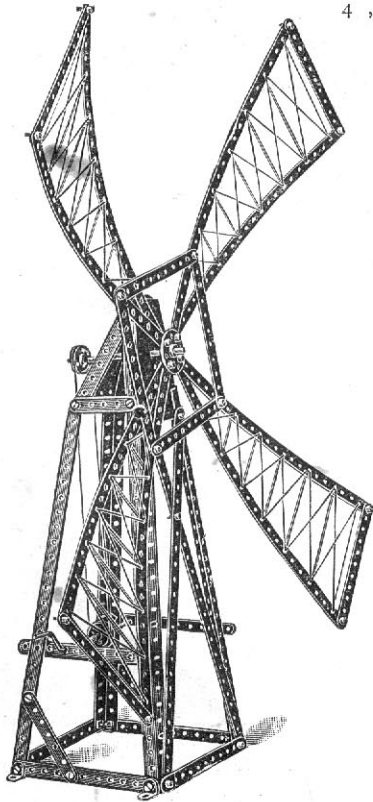

This model requires no special instructions. We would, however, say that this model may be driven by the No. 1 Meccano Spring Motor.

This model also lends itself to further decorations by means of coloured ribbons used in the place of the cord lacings; or as streamers.

MODEL No. 69. Wheel

PARTS REQUIRED.

5 of No. 1
12 " " 2
2 " " 5
4 " " 8
4 " " 11
2 " " 15
3 " " 20
2 " " 22
44 " " 37

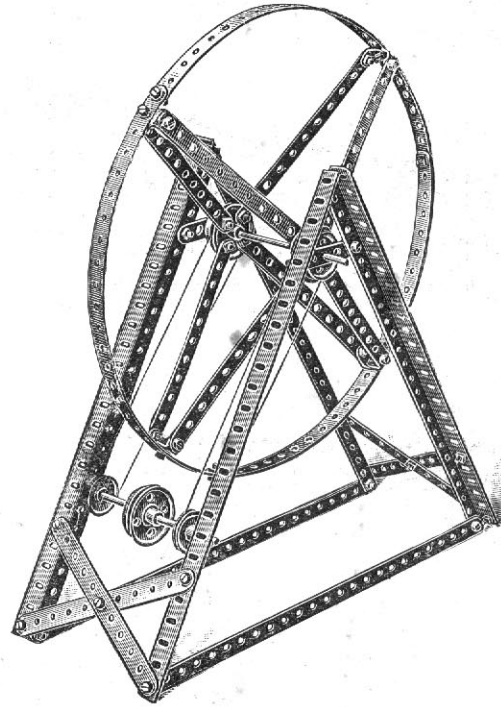

The only point calling for description in this model, which is otherwise very clearly shown, is the wheel. This is made from three $12\frac{1}{2}$ " strips to form the outer hoop, the spokes being made from pairs of $5\frac{1}{2}$ " strips bolted to flanged wheels mounted on a spindle. These flanged wheels are secured in their splayed position on the spindle by set screws.

MODEL No. 70. Swing Bridge

(MADE WITH MECCANO NO. 2 OR NO. 1 AND NO. 1A.)

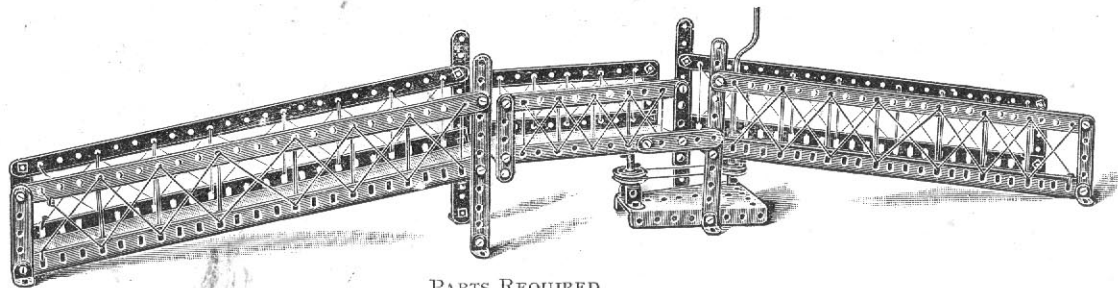

PARTS REQUIRED.

4 of No. 1	8 of No. 12	1 of No. 24	1 of No. 52
6 " " 2	1 " " 17	1 " " 35	1 " " 54
9 " " 5	1 " " 19	31 " " 37	4 " " 60
4 " " 8	2 " " 22	1 " " 45	

FIG. 70A

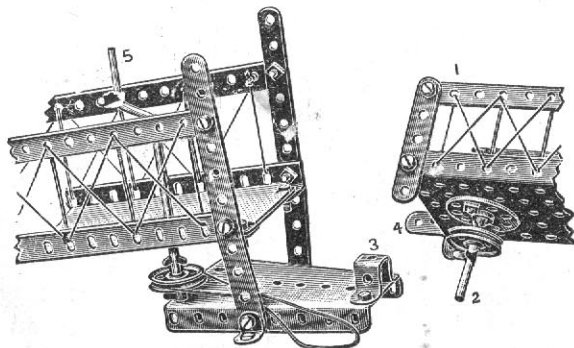

The action for swinging the middle section of the Bridge will be made clearer by the detail Fig. 70A, the middle section 1 being fitted with a spindle 2 journaled in the double bent strip 3; the upper end of the spindle being secured to a bush wheel.

A short strip 4 acts as a stop against the middle section of the Bridge swinging past the central position. The operating cord passes round pulleys on the spindles 2 and crank handle 5.

MODEL No. 71

Railway Foot Bridge and Signals

(MADE WITH MECCANO OUTFIT NO. 2 OR NO. 1 AND NO. 1A.)

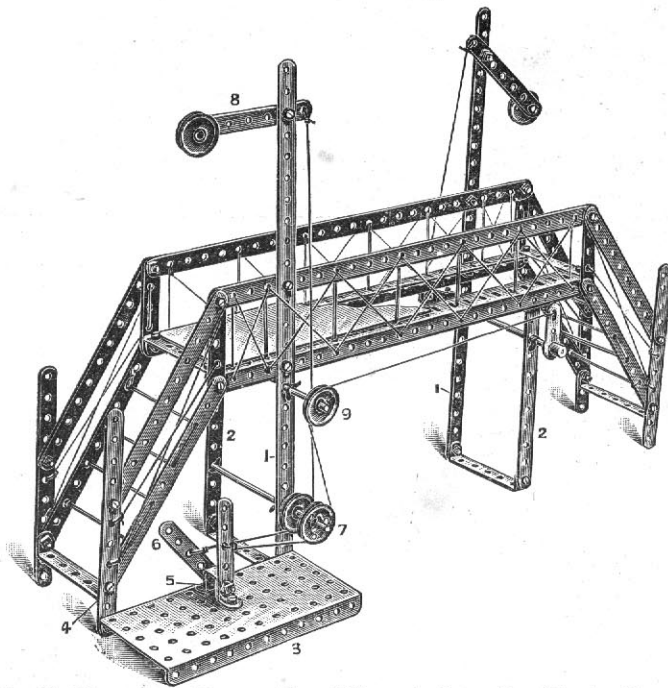

PARTS REQUIRED.

4 of No.	1
14 " "	2
2 " "	3
8 " "	5
3 " "	15
2 " "	8
2 " "	22A
3 " "	22
43 " "	37
1 " "	51
6 " "	35
1 " "	45
4 " "	60
2 " "	62

The structure of the Bridge may be readily followed from the illustration, being built up from a series of perforated strips. The vertical signal posts 1 are bolted to the side rails of the Bridge and form feet for it. Opposite each signal post another foot consisting of a $5\frac{1}{2}$ " perforated strip 2 is disposed. A flanged plate 3 is bolted by its flange to the vertical strips 4 of the Bridge, and a double bent strip 5 bolted to the plate 3 forms the casing for the point-operating levers 6. These point-operating levers are pivotally bolted to the double bent strip 5, and operating cords from each point lever are led over a pair of grooved pulleys 7 carried on an axle rod passing through the feet of the bridge. One of the cords passes direct to the signal 8, the other being led over a grooved pulley 9 and secured to a crank 10, carried upon a rod passing through the feet of the Bridge, this rod being furnished at its far end with another crank to which is secured another cord operating the other signal arm.

MODEL No. 72. Motor Van

(MADE WITH MECCANO OUTFIT NO. 2 OR NO. 1 AND NO. 1A.)

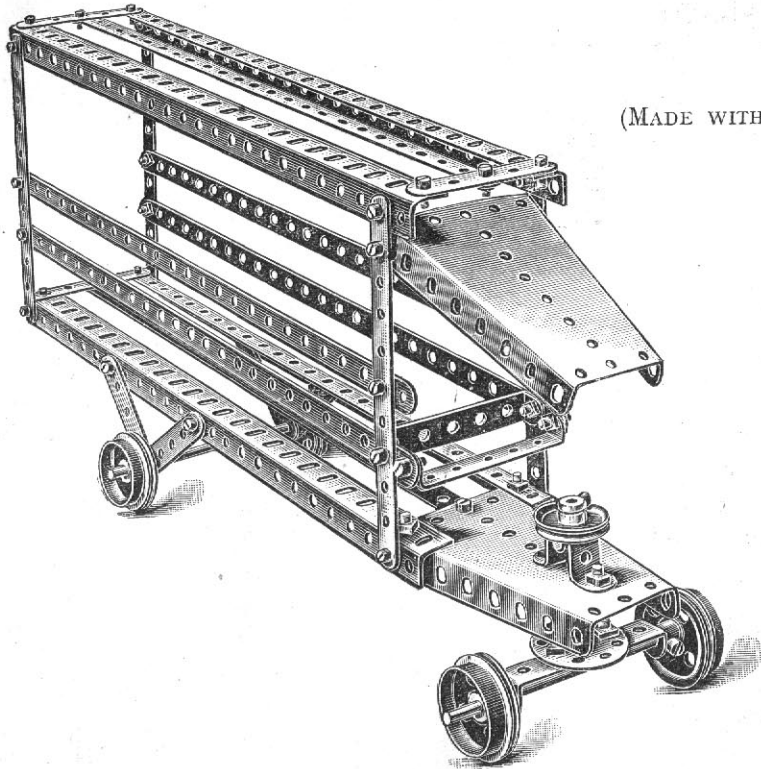

PARTS REQUIRED.

6 of No.	1
4 " "	2
7 " "	5
4 " "	8
2 " "	15
1 " "	17
4 " "	20
2 " "	22
1 " "	24
40 " "	37
1 " "	45
2 " "	54
3 " "	60

The only portion of this model calling for a description is the steering gear. The steering shaft, to which is secured the steering handle, passes through a double bent strip bolted to the steering platform, consisting of a sector plate. The arrangement of the gear beneath the platform is shown in Fig. 72A. A 1" pulley wheel is secured on the spindle immediately below the platform, and a bush wheel affixed below this on the end of the spindle. A 2½" bent strip bolted to the bush wheel forms the bearings for the spindle of the running wheels. By fitting the 1" pulley below the platform, the running wheels are maintained at a requisite distance, to give clearance from the platform flanges.

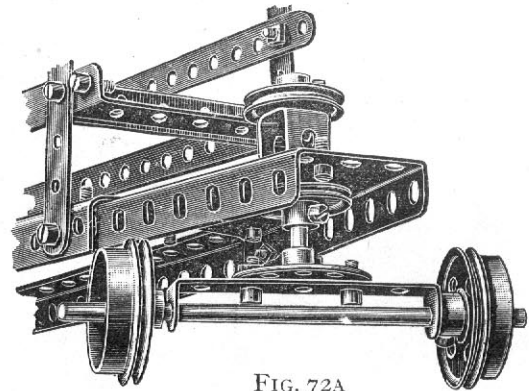
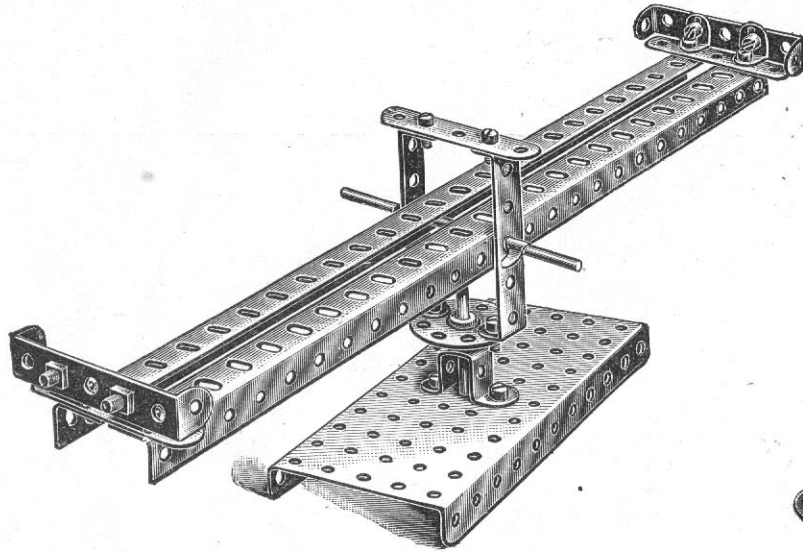

FIG. 72A

MODEL No. 73 Roundabout Seesaw

(MADE WITH MECCANO OUTFIT NO. 2 OR NO. 1 AND NO. IA.)



PARTS REQUIRED.

3 of No. 5	2 of No. 35
2 " " 8	14 " " 37
4 " " 12	1 " " 45
1 " " 15	1 " " 52
1 " " 24	4 " " 60

MODEL No. 74. Three-Arm Signal

(MADE WITH MECCANO OUTFIT
NO. 2 OR NO. 1 AND NO. IA.)

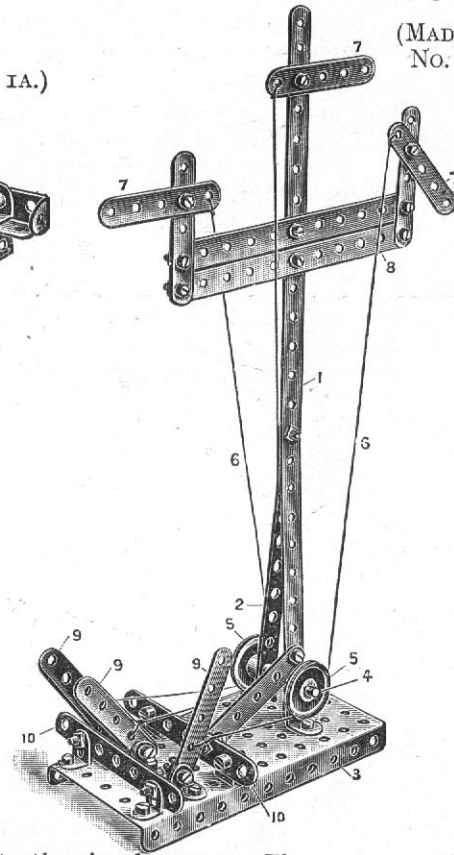

PARTS REQUIRED.

1 of No. 1
3 " " 2
2 " " 3
9 " " 5
10 " " 12
1 " " 17
2 " " 22
37 " " 37
1 " " 52

A flanged plate forms the base of this model, a $12\frac{1}{2}$ " strip 1 being bolted to a $5\frac{1}{2}$ " strip 2, the feet of both these strips being connected to the flanged plate 3 by angle brackets. A rod 4 is passed through the lower holes of the strips 1 and 2 and is fitted with guide pulleys 5 leading the actuating cords 6

to the signal arms 7. The cord operating the central arm is run under the rod 4. The signal arms 7 are carried from transverse strips 8. The operating cords 6 are led to three strips 9, pivoted to angle brackets bolted to the flanged plate, and transverse strips 10 are bolted to the perforated plate in the front and rear of the pivoted strips 9, to limit their movement.

MODEL No. 75. Extensible Ladder on Running Carriage

(MADE WITH MECCANO OUTFIT NO. 2 OR NO. 1 AND NO. 1A.)

The bed of the lower carriage framework 1 is formed by bolting two $1\frac{1}{2}$ " strips to the sides of a large flanged plate 2, and two sector plates 3 bolted to the flanged plate by their flanges to form the sides, and a bearing for the spindle 4 carrying the operating cord 5 to raise the ladder from a horizontal position. The strips 6 form a support for the ladder when in this horizontal position. Angle brackets 7, Fig. 75A, form pivots for the lower part 8 of the ladder, and are carried from the supports 9. The upper part of the ladder 10, Fig. 75B, is slidably guided and retained on the lower ladder 8 by double brackets 11. The extension of the ladder is effected by the cranked spindle 12, round a pulley 13, on which and another 14, carried as shown in Fig. 75A, the cord 15 is passed, the ends of which are secured to the lower part of the movable ladder

PARTS REQUIRED.

	2 of	No.	1
	9	"	2
	2	"	3
	12	"	5
	4	"	8
	2	"	11
	4	"	12
	4	"	15
	1	"	19
	4	"	20
	4	"	22
	1	"	22A
	1	"	24
	6	"	35
	47	"	37
	1	"	44
	1	"	52
	2	"	54
	5	"	60

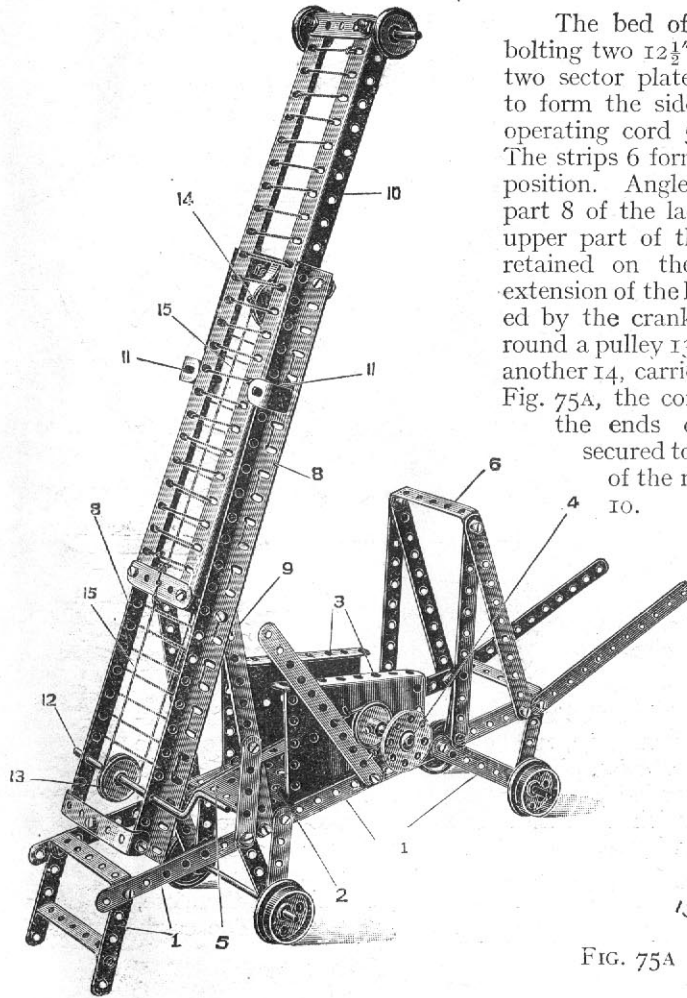

FIG. 75A

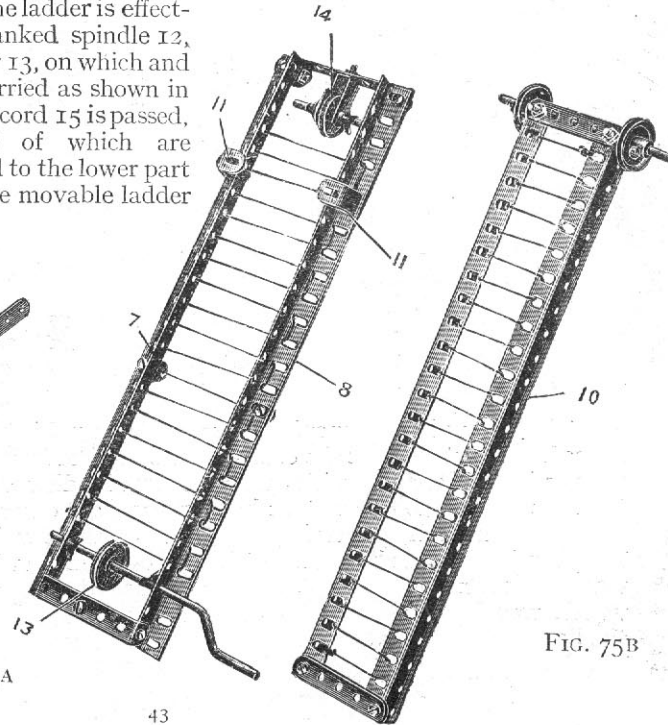
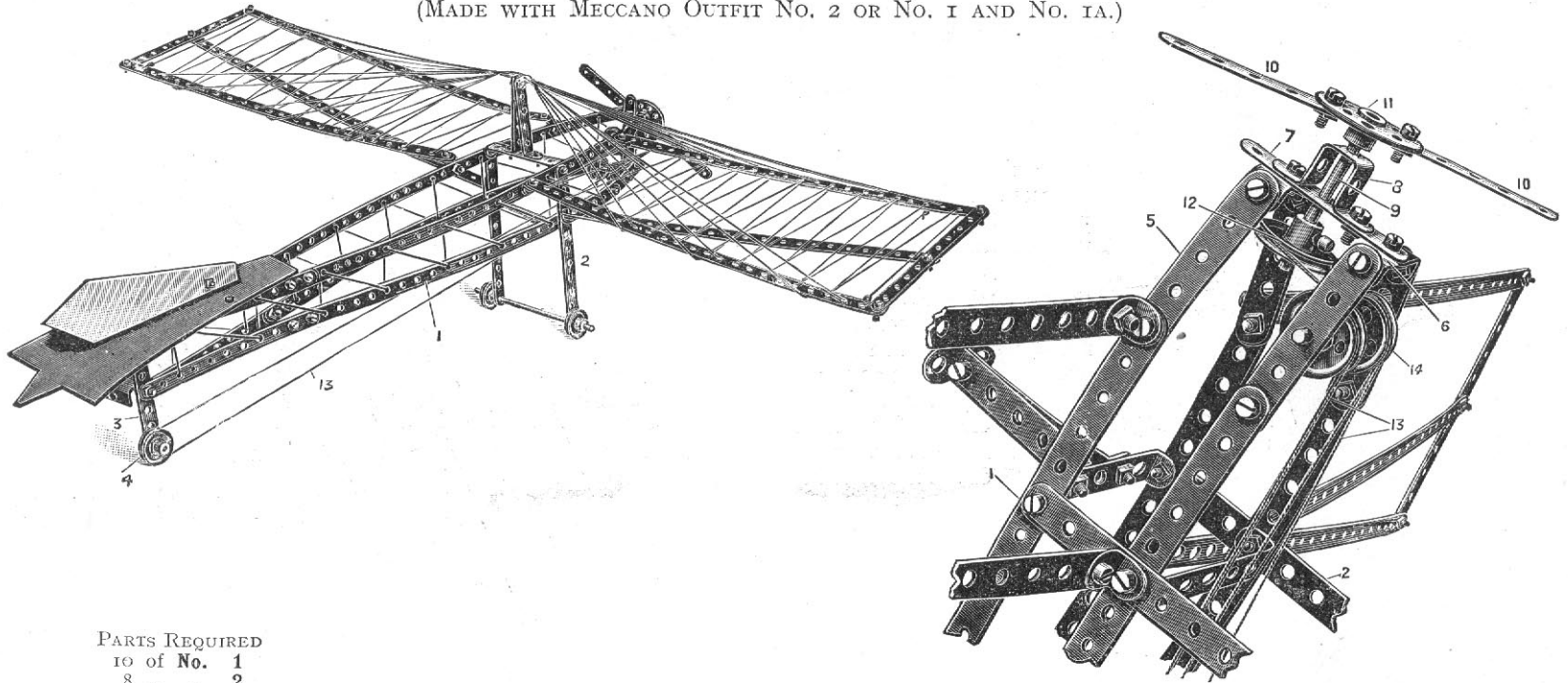

FIG. 75B

MODEL No. 76. Monoplane

(MADE WITH MECCANO OUTFIT NO. 2 OR NO. 1 AND NO. 1A.)



PARTS REQUIRED

10 of No.	1
8 " "	2
1 " "	3
7 " "	5
2 " "	11
9 " "	12
1 " "	15
1 " "	17
3 " "	22
1 " "	24
1 " "	35
48 " "	37
1 " "	45
4 " "	60

The body of the Monoplane is made from $12\frac{1}{2}$ " strips 1 extended at the rear by $5\frac{1}{2}$ " strips overlapped, and distended at the centre by the vertical framework 2, and bolted together at the tail outside the vertical $3\frac{1}{2}$ " strip 3 which carries the rear landing wheel 4, pivoted as shown in the standard detail R at the end of the book. The body strips 1 are extended by $2\frac{1}{2}$ " strips 5 bolted to angle brackets 6 to a vertical $2\frac{1}{2}$ " strip 7 carrying a double bent strip 8 which forms the bearing for the propeller spindle 9. The propeller is made by bolting $2\frac{1}{2}$ " strips 10 to a bush wheel 11 secured on the shaft 9, and a 1" pulley wheel 12 is secured on the other end of the shaft, a continuous cord 13 being passed from the landing wheel 4 round two pulley wheels 14, and the wheel 12. By moving the model along the table, therefore, the propeller is rotated. The other details will be clearly followed from the illustrations. The cardboard forming the tail is not provided in the outfit.

MODEL No. 77

Carrier Tricycle

(MADE WITH MECCANO OUTFIT NO. 2 OR NO. 1 AND NO. 1A.)

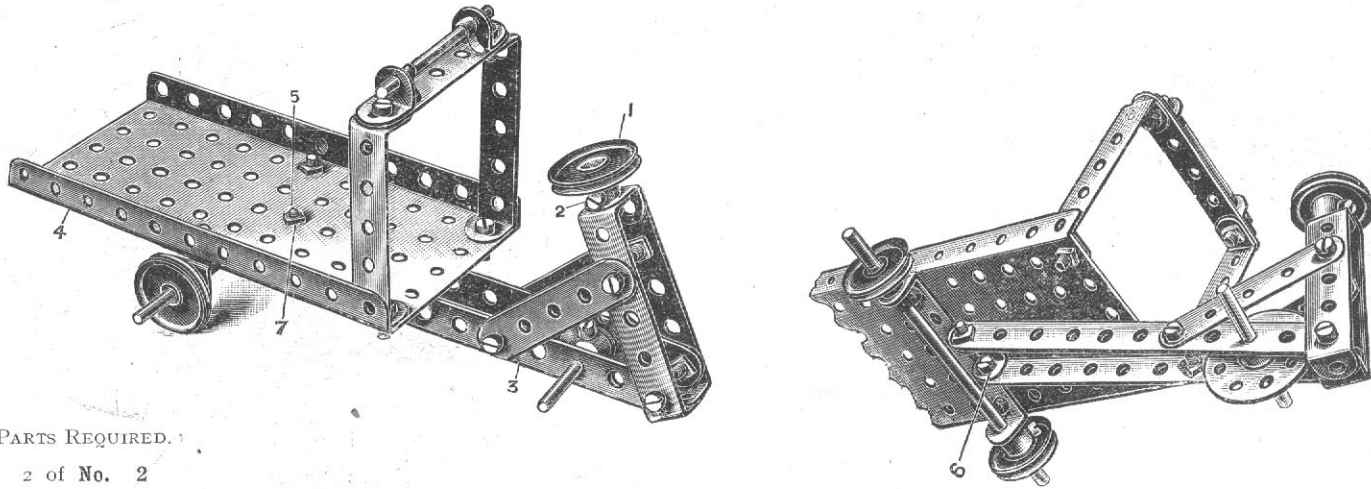

PARTS REQUIRED.

2	of	No.	2
3	"	"	5
1	"	"	11
2	"	"	12
1	"	"	15
2	"	"	17
3	"	"	22
1	"	"	24
2	"	"	35
16	"	"	37
1	"	"	52
5	"	"	60

The general construction of this model is shown clearly in the illustrations. The seat 1 is a 1" pulley which is secured by its set screw 2 to a bolt passed from beneath into the bush of the wheel. The rear frame 3 is pivoted to the rectangular plate 4 about a bolt 5, passed through a double bracket 6, between which and the plate 5 a lock-nut (see standard detail D at the end of the book) is inserted, the upper nut 7 securing the frame 3 in place.

MODEL No. 78. Mechanical Navyy

MODEL No. 79. Motor Van

(MADE WITH MECCANO OUTFIT No. 2, OR NO. 1 AND NO. 1A.)

PARTS REQUIRED.

6	of	No.	1
5	"	"	2
2	"	"	3
5	"	"	5
4	"	"	8
1	"	"	10
1	"	"	17
3	"	"	15
1	"	"	19
4	"	"	20
1	"	"	22
2	"	"	22A
6	"	"	35
43	"	"	37
1	"	"	52
2	"	"	54
2	"	"	60

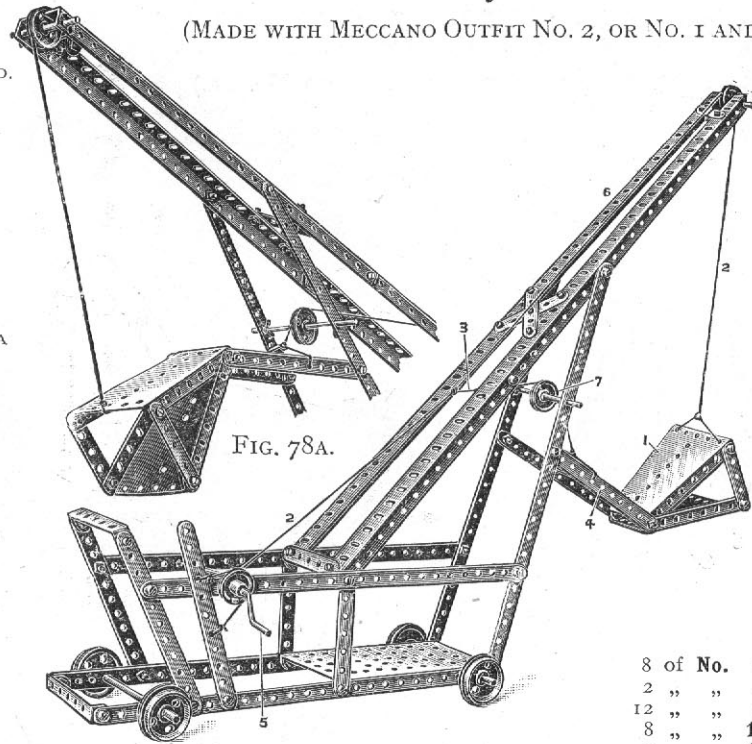
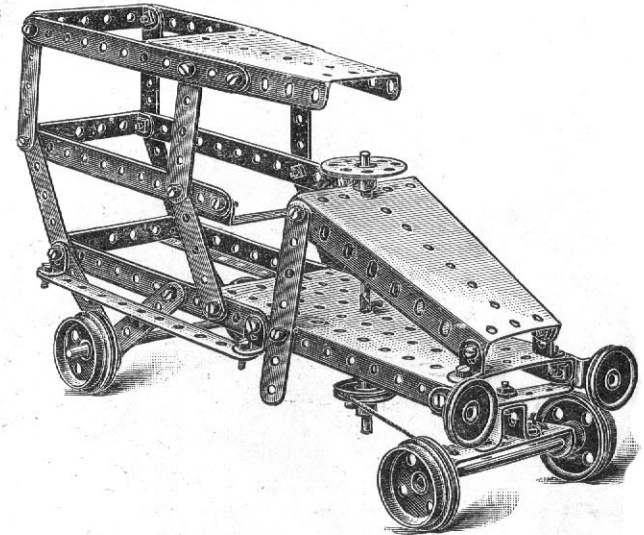

FIG. 78A.

This is a model of an apparatus used for excavating canals, docks, railway cuttings, &c. The jib 6 is fixed, and the grab bucket 1 is pivoted at the ends of the 5½" strips 4 which are in turn pivoted to the jib. The operating cord 2 passing round the cranked handle and connected to the bucket 1 is coupled to another cord 3, which passes over a pulley 7 and is connected to the 5½" strips 4. This arrangement gives the scooping position shown and an emptying position illustrated in the detail Fig. 78A.



PARTS REQUIRED.

8	of	No.	2	4	of	No.	20	1	of	No.	45
2	"	"	3	3	"	"	22	1	"	"	52
12	"	"	5	1	"	"	24	2	"	"	54
8	"	"	12	1	"	"	35	6	"	"	60
3	"	"	15	40	"	"	37				

The steering wheel rod 4½" is fitted below with a 1" pulley, round which the steering cord is given a complete turn to ensure a good grip and is then connected to the outer holes of a 2½" bent strip, which forms the bearing for the front wheel axle, and which is pivoted to another 2½" bent strip reversed, bolted to the flanges of a flanged plate beneath the sector plate. The double bent strip is lock-nutted as in standard detail D.

MODEL No. 80. Roundabout MODEL No. 81. Ferry Gangways

(MADE WITH MECCANO OUTFIT No. 2, OR No. 1 AND No. 1A.)

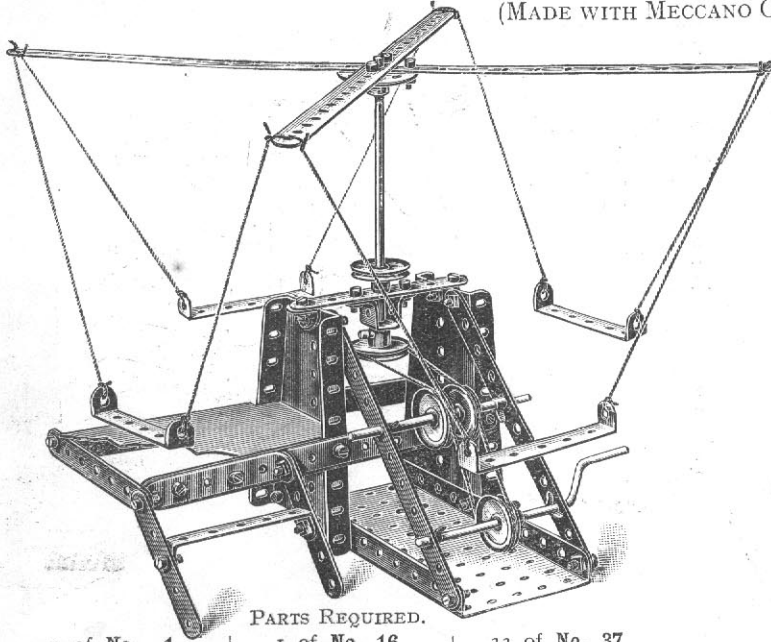

PARTS REQUIRED.

2 of No. 1	1 of No. 16	33 of No. 37
4 " " 2	1 " " 19	1 " " 45
2 " " 3	3 " " 22	1 " " 52
4 " " 5	2 " " 22A	2 " " 54
3 " " 12	1 " " 24	6 " " 60
1 " " 15	4 " " 35	

The side frames of this model are sector plates bolted to a flanged plate for the base, and connected across at the top by a $2\frac{1}{2}$ " strip beneath which is bolted a double bent strip forming the bearing for the spindle of the Roundabout arms. The driving cord passes from a 1" pulley on the cranked handle over two loose pulleys and round a pulley fixed on the spindle. The platform for mounting the suspended boats is carried from the main structure by overlapped $5\frac{1}{2}$ " and $2\frac{1}{2}$ " strips.

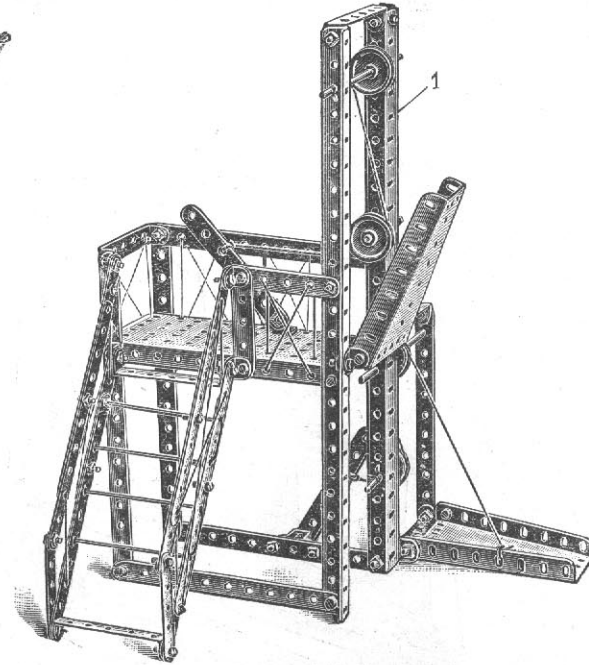

The vertical standard 1 is built up from two angle girders, the slotted holes overlapped to form a channel section girder.

PARTS REQUIRED.

14 of No. 2	2 of No. 22
2 " " 3	2 " " 22A
6 " " 5	6 " " 35
3 " " 8	50 " " 37
2 " " 10	1 " " 45
7 " " 12	1 " " 52
2 " " 15	2 " " 54
2 " " 17	6 " " 60

MODEL No. 82. Steamship

(MADE WITH MECCANO OUTFIT NO. 2 OR NO. 1 AND NO. 1A.)

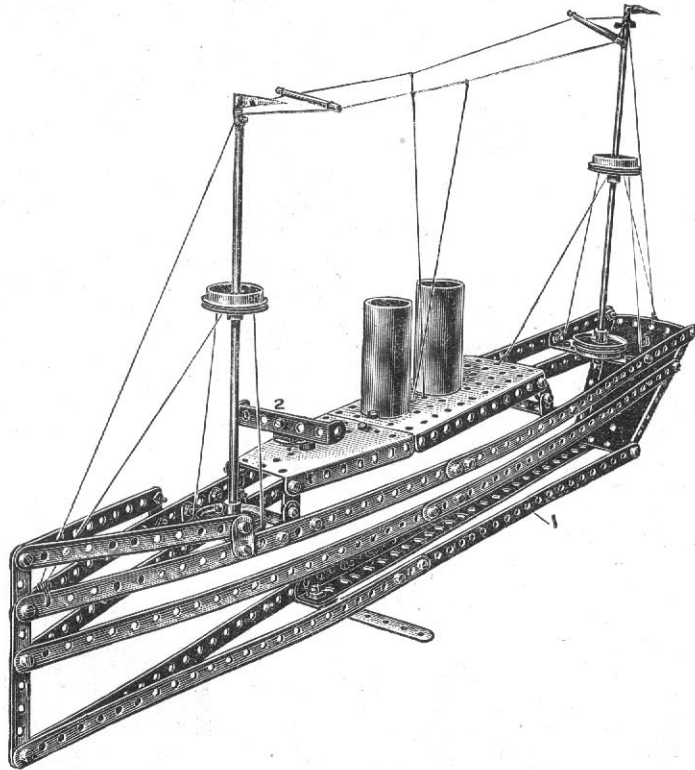

PARTS REQUIRED.

10	of	No.	1
3	"	"	2
2	"	"	3
4	"	"	5
2	"	"	8
6	"	"	10
12	"	"	12
4	"	"	15
2	"	"	17
4	"	"	20
2	"	"	22
1	"	"	24
2	"	"	35
59	"	"	37
1	"	"	52
2	"	"	54
2	"	"	60

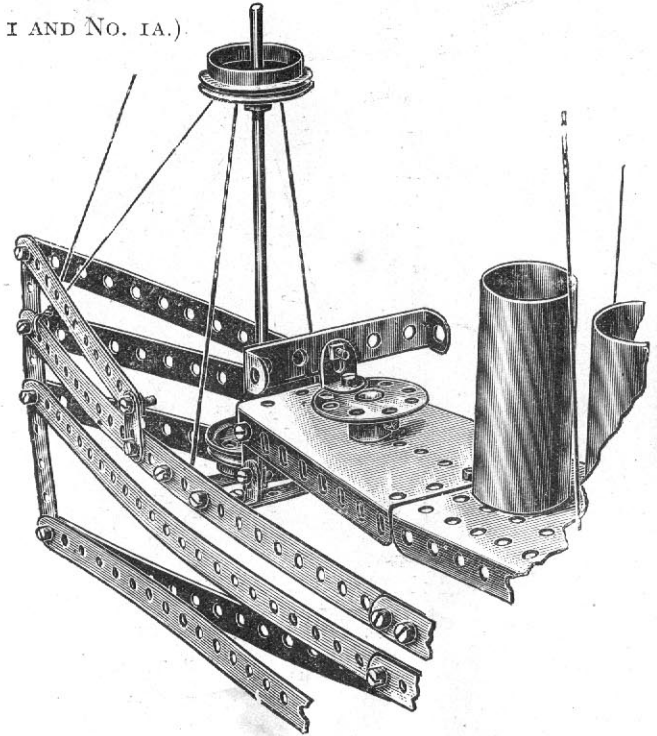

This is a model the construction of which will interest boys. The rear keel plates 1 are of angle girders to give rigidity. A $2\frac{1}{2}$ " bent strip 2 is bolted by an angle bracket to a bush wheel to form the bridge, the upper deck being made from a large flanged plate and a sector plate, connected together by a $2\frac{1}{2}$ " strip beneath. The funnels rest over fast pulley wheels connected to the plates by bolts passed through the plates and nipped in the bushes of the pulley wheels.

MODEL No. 83. Embossing Machine

(MADE WITH MECCANO OUTFIT NO. 2 OR NO. 1 AND NO. 1A.)

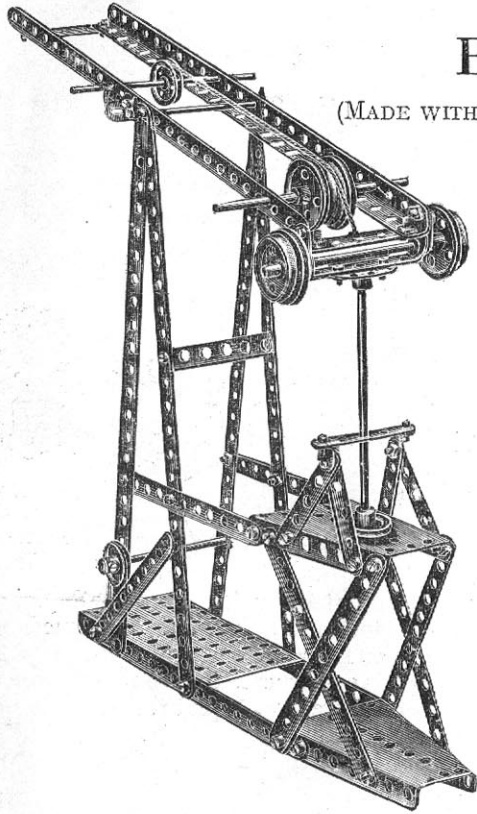

PARTS REQUIRED.

4 of No. 1	4 of No. 20
9 " " 2	2 " " 22
7 " " 5	1 " " 22A
2 " " 8	1 " " 24
2 " " 10	5 " " 35
3 " " 12	43 " " 37
4 " " 15	1 " " 12
1 " " 16	2 " " 54
1 " " 19	2 " " 60

HOW TO CONTINUE

This completes the models which may be made with MECCANO Outfit No. 2. The next models are a little more advanced, requiring a number of extra parts to construct them. The necessary parts are all contained in a No. 2A Accessory Outfit, the cost of which will be found in the Price List at the end of the Manual.

MODEL No. 84. Swing Bridge

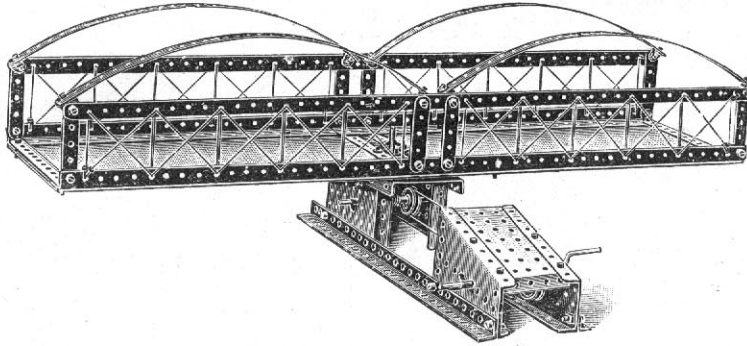

(MADE WITH MECCANO OUTFIT NO. 3 OR NO. 2 AND NO. 2A.)

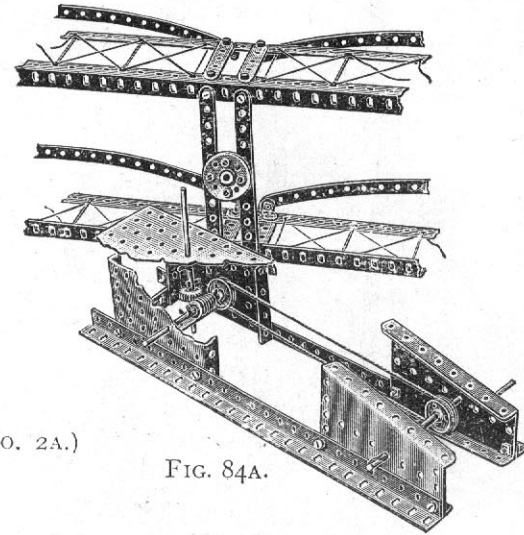

FIG. 84A.

PARTS REQUIRED.

8	of	No.	1
4	"	"	2
8	"	"	5
6	"	"	8
10	"	"	12
2	"	"	15
1	"	"	19
2	"	"	22
1	"	"	24
1	"	"	26
1	"	"	32
3	"	"	35
60	"	"	37
1	"	"	52
3	"	"	53
2	"	"	54
2	"	"	59
1	"	"	60

This is a fine engineering model of the highest value to the young student, and any thought and care expended on its construction will be well repaid.

The base portion containing the perpendicular axle actuated by the worm and pinion should be constructed first. This, as will be seen by the illustration, Fig. 84A, is formed by connecting a small flanged plate to an angle girder three holes from one end and a sector plate at the other end to form one side of the base. The other side is constructed in a similar manner. These two sides are then connected together at one end by a large flanged plate containing the spindle, upon which the bridge swings, and at the other by a small flanged plate. A $2\frac{1}{2}$ " bent strip is connected to the angle girders to carry the lower portion of the perpendicular axle upon which the bridge swings. A $\frac{3}{4}$ " pinion is secured to this axle, which is operated by the horizontal spindle upon which is secured a worm wheel. A pulley wheel is also secured to this spindle around which a driving rope passes from the pulley at the other end of the base secured to a crank handle, as shown in the illustration.

The platform is constructed by connecting two angle girders in the third holes. Two $2\frac{1}{2}$ " strips are attached to these in the centre and one at each end, with two $12\frac{1}{2}$ " strips along the top. Two $12\frac{1}{2}$ " strips are curved and connected by four angle brackets to form one side of the bridge. The other side is formed in a similar manner, and both are connected together by $5\frac{1}{2}$ " strips at the end and in the centre. Attached to the two $5\frac{1}{2}$ " strips in the centre is a bush wheel upon which the platform rotates.

MODEL No. 85. Tower Wagon

(MADE WITH MECCANO OUTFIT No. 3 OR No. 2 AND No. 2A.)

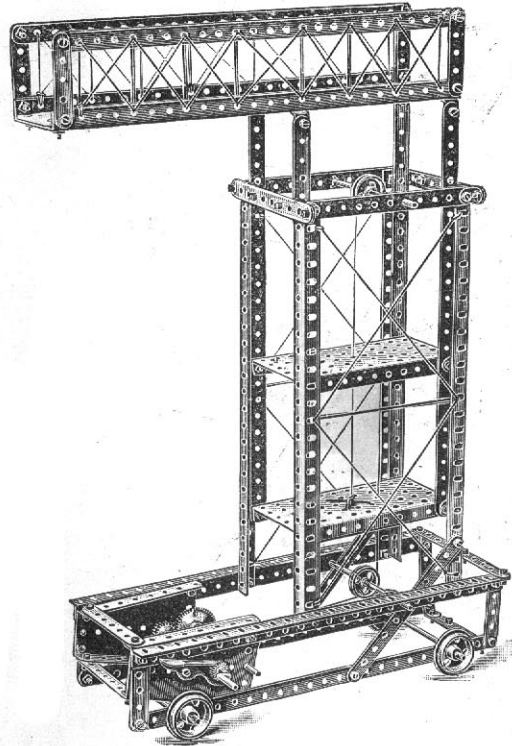

This is a representation of a wagon used for repairing overhead electrical wires carrying the current for street cars. Each part is shown clearly in our illustration, and little difficulty will be experienced in its construction.

PARTS REQUIRED.

8 of No.	1
4 " "	2
6 " "	3
2 " "	4
11 " "	5
8 " "	8
14 " "	12
5 " "	15
1 " "	19
4 " "	20
2 " "	22
1 " "	25
1 " "	26
1 " "	27
1 " "	33
6 " "	35
69 " "	37
2 " "	52
2 " "	54
2 " "	60

MODEL No. 86. Pile Driver

(MADE WITH MECCANO OUTFIT No. 3 OR No. 2 AND No. 2A.)

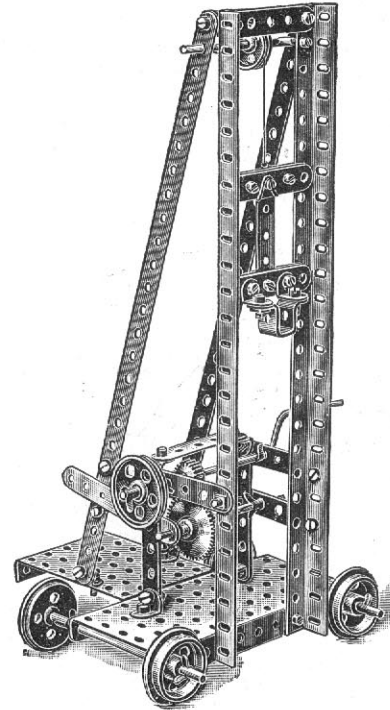

PARTS REQUIRED.

2 of No.	1
1 " "	3
2 " "	4
8 " "	5
2 " "	8
4 " "	12
4 " "	15
1 " "	19
4 " "	20
1 " "	21
1 " "	22
1 " "	25
1 " "	27
4 " "	35
40 " "	37
1 " "	45
1 " "	52
1 " "	53
2 " "	60

This illustration shows a model pile driver in which the pile head is guided on the two vertical angle girders. The raising of the pile head is controlled from the main driving shaft through the pinion and gear wheel. This latter is mounted on the end of the pivoted lever, and in order to drop the pile head the lever is raised to free the gear wheel. A grooved pulley is fitted on the lever shaft to enable the model to be driven from an engine.

MODEL No. 87. Cake Walk

(MADE WITH MECCANO OUTFIT NO. 3 OR NO. 2 AND NO. 2A.)

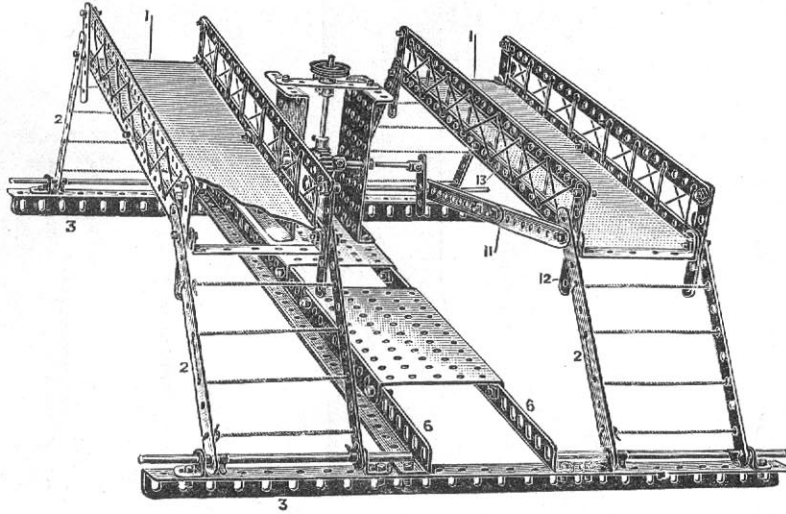

PARTS REQUIRED.

8	of	No.	1
12	"	"	2
9	"	"	5
6	"	"	8
8	"	"	12
6	"	"	15
1	"	"	22
1	"	"	26
1	"	"	32
8	"	"	35
62	"	"	37
2	"	"	52
2	"	"	53
3	"	"	59
6	"	"	60
2	"	"	62

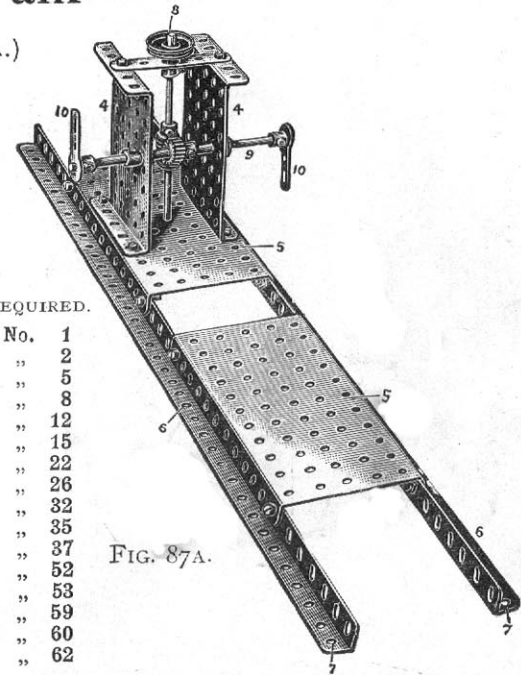
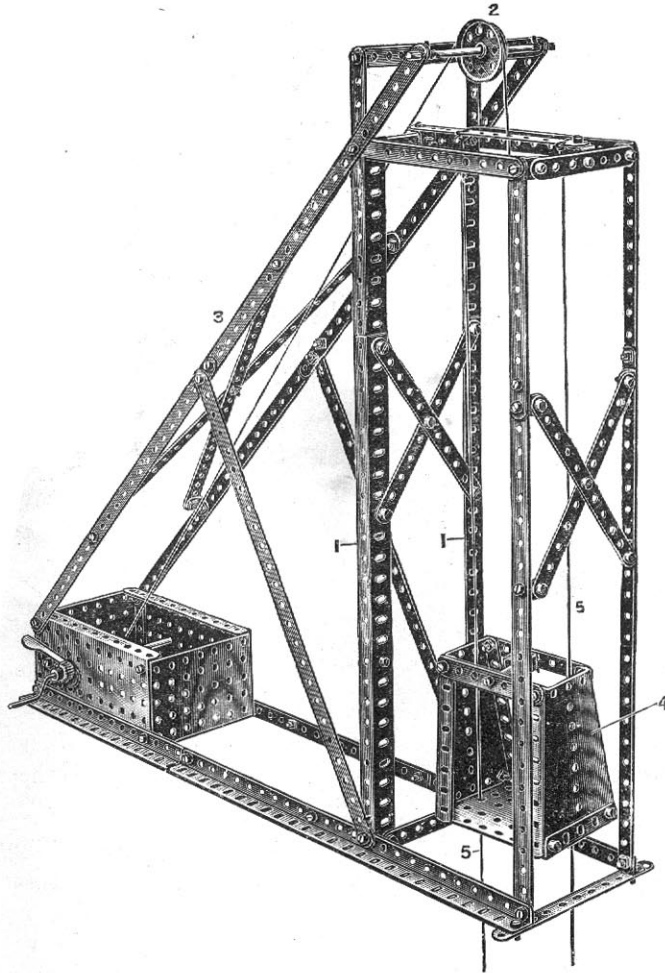

FIG. 87A.

This model comprises two side platforms 1 carried upon $5\frac{1}{2}$ " strips 2 pivoted to angle brackets bolted to angle girders 3. The gear box, Fig. 87A, consists of small flanged plates 4 bolted to a large flanged plate 5, which in turn is bolted to angle girders 6 overlapped fourteen holes. It is necessary to bolt the flanges to the flanged plate 5 outside the vertical parts of the angle girders 6 so that the end holes 7 shall register with the holes in the angle girders 3. The platforms 1 are rocked from a vertical shaft 8 gearing with a shaft 9 by a worm and pinion, the ends of the shaft 9 being fitted with cranks 10 pivotally bolted to connecting rods 11 formed of two $5\frac{1}{2}$ " strips overlapped two holes. The strips 11 are also pivotally bolted to the end strips 2, a vertical $2\frac{1}{2}$ " strip 12, and the lower end hole of the lower strip 13 of each side platform, so as to give free rocking movement.

MODEL No. 88. Pit Headgear

(MADE WITH MECCANO OUTFIT No. 3 OR No. 2 AND No. 2A.)



PARTS REQUIRED.

10 of No.	1	1 of No.	21
10 " "	2	1 " "	26
6 " "	3	1 " "	33
4 " "	5	76 " "	37
8 " "	8	6 " "	35
1 " "	11	2 " "	52
14 " "	12	3 " "	53
1 " "	15	2 " "	54
1 " "	17	1 " "	59
1 " "	19		

This model shows the principle upon which minerals are raised from below the ground. The main uprights 1 are formed of angle girders overlapped, and the pulley 2, over which passes the winding rope 2, is carried on an axle rod passed through $2\frac{1}{2}$ " strips and the end hole of the diagonal bracing strips 3 made from $12\frac{1}{2}$ " strips overlapped three holes. The cage is made from sector plates 4 connected by $3\frac{1}{2}$ " strips at the top and a small flanged plate at bottom through the side holes in which the guide ropes 5 pass. The gear box is made from large flanged plates at the side and small flanged plates at the end.

MODEL No. 89. Level Crossing Gate

(MADE WITH MECCANO OUTFIT NO. 3 OR NO. 2 AND NO. 2A.)

PARTS REQUIRED.

9 of No. 2	16 of No. 12
4 " " 3	4 " " 15
2 " " 4	4 " " 22
6 " " 5	54 " " 37
4 " " 60	2 " " 52
6 " " 8	

This model, if constructed with care, is a most admirable one, as the gates are opened simultaneously by the operation of one lever.

To construct it, commence by taking two angle girders and connecting them together in the second hole from each end with a $3\frac{1}{2}$ " strip placed perpendicularly between them to form the supports of one pair of gates as shown in Fig. 89. The supports for the other pair of gates are arranged in a similar manner. These two structures are connected by two other angle girders and two flanged plates, as shown in the illustration.

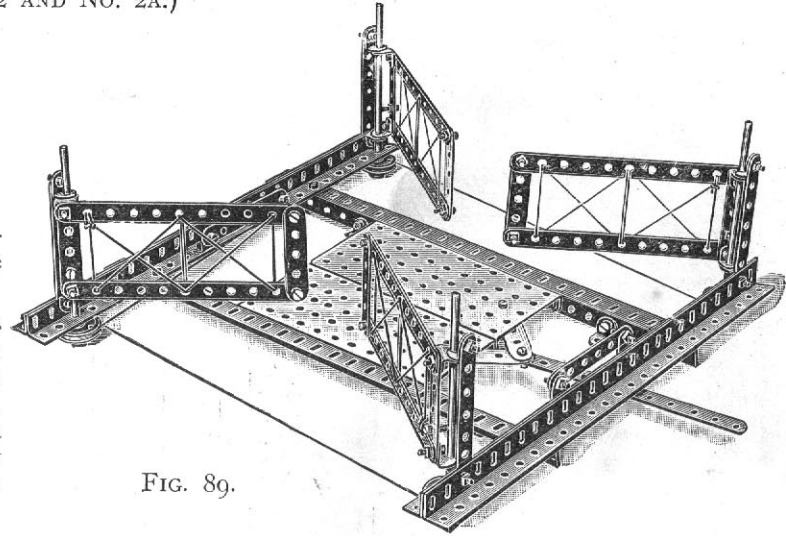

FIG. 89.

The gates are formed by connecting two $5\frac{1}{2}$ " strips with a $2\frac{1}{2}$ " strip at the outer end of the gate and a $2\frac{1}{2}$ " bent strip at the inner end, to permit the axle rods to pass through upon which the gates swing.

Fig. 89A is an inverted view showing the arrangement of operating cord α which is passed from the operating lever 2, around the corner pulleys 3, and back to the lever 2. In order to obtain a better grip on the pulleys it is desirable to wind the operating cord twice around them. It is to be noted that the cord α is wound in opposite directions around the diagonal pairs of pulleys 3.

Pinching screws 4 are fitted in the inner sides of the gates to grip them to the spindles 5 so that all rotate together.

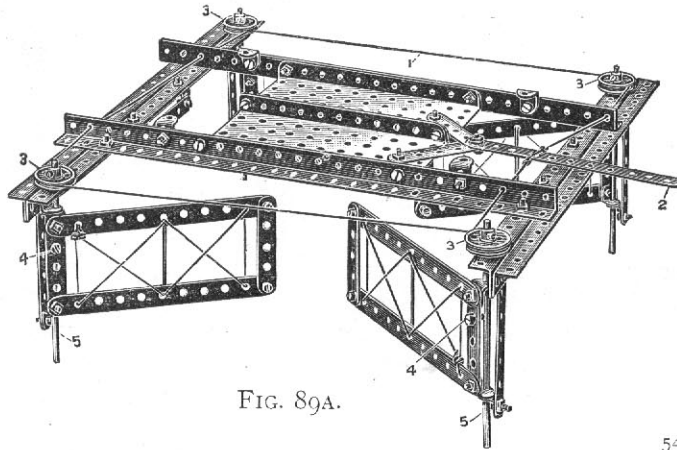
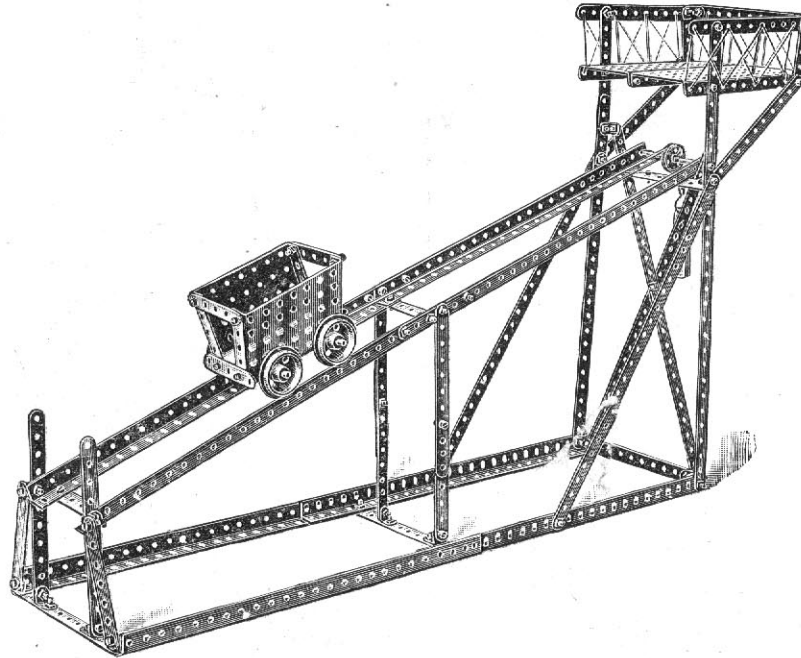

FIG. 89A.

MODEL No. 90. Inclined Delivery Chute

(MADE WITH MECCANO OUTFIT NO. 3 OR NO. 2 AND NO. 2A.)



PARTS REQUIRED.

6 of No.	1
16 " "	2
4 " "	3
2 " "	4
8 " "	5
8 " "	8
16 " "	12
3 " "	15
4 " "	20
1 " "	22A
2 " "	35
70 " "	37
2 " "	52
2 " "	53
1 " "	57

This model furnishes an illustration of the inclined plane. The loading platform at the extreme right delivers a load into the truck, which being now heavier than the balance weight, runs down the incline, and when at the bottom discharges its load by tipping. The weight immediately overcoming the empty truck returns it quickly to the loading platform.

MODEL No. 91. Fire Escape

(MADE WITH MECCANO OUTFIT NO. 3 OR NO. 2 AND NO. 2A.)

PARTS REQUIRED

2 of	No.	1
2	"	1
4	"	2
3	"	3
2	"	4
4	"	5
1	"	60
4	"	8
2	"	11
18	"	12
5	"	15
2	"	19
4	"	20
3	"	22
1	"	23
2	"	26
2	"	33
48	"	37
8	"	35

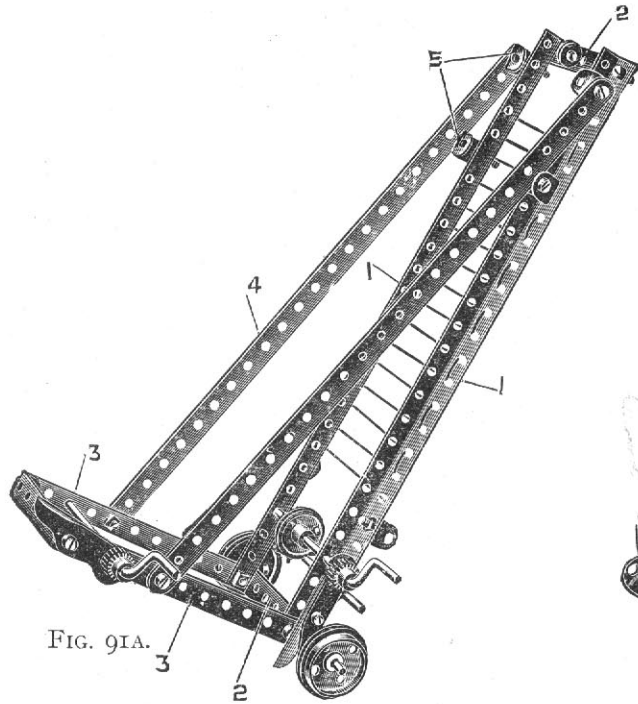

FIG. 91A.

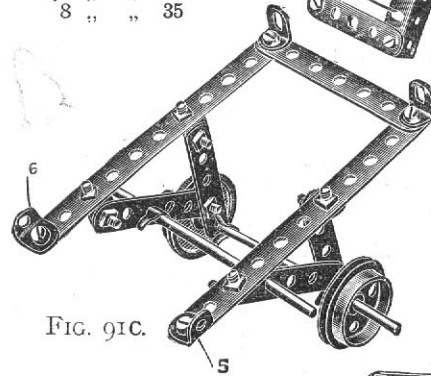

FIG. 91C.

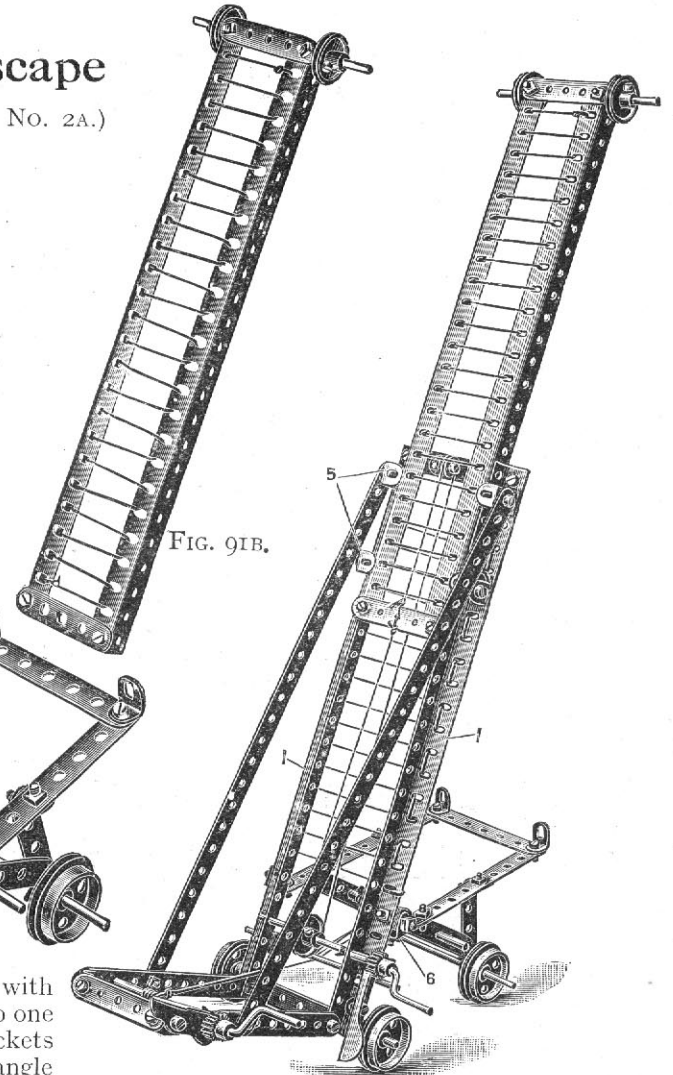
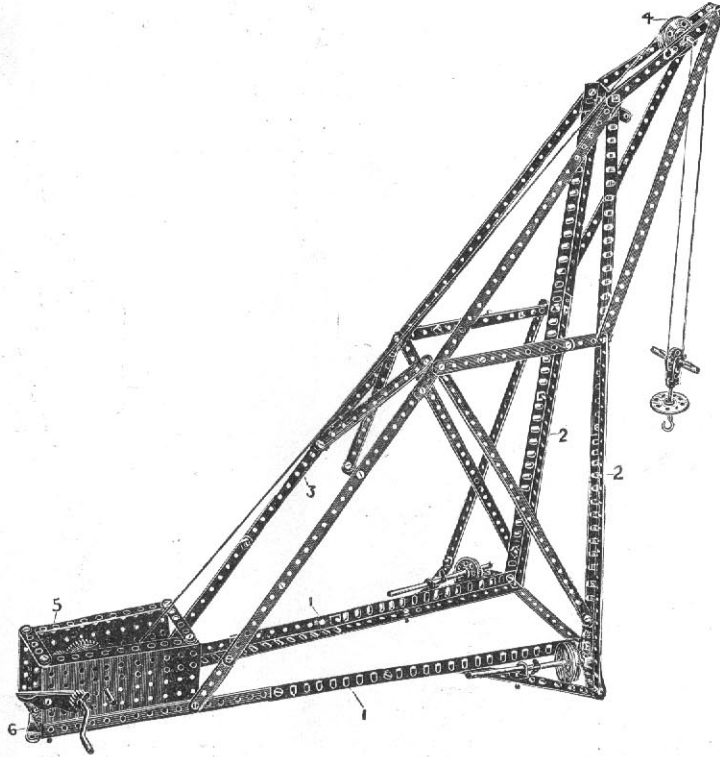

FIG. 91B.

In constructing this model, take two angle girders 1 and tie these together with $3\frac{1}{2}$ " strips 2 at top and bottom. $5\frac{1}{2}$ " strips 3 are then attached at right angles to one end of the frame, diagonal stays 4 tying these short strips to the angle brackets attached to the frame. The sliding ladder, Fig. 91B, is constructed from two angle girders reversed to those of the main frame, the angle girders of the sliding ladder being tied together by two $2\frac{3}{4}$ " strips, and being retained and guided in the main carriage by the short angle brackets 5 which act as clips. The framework of the running truck, Fig. 91C, is very simply constructed, and is pivotally attached by angle brackets 6 to the main frame.

MODEL No. 92. Rotating Crane

(MADE WITH MECCANO OUTFIT NO. 3 OR NO. 2 AND NO. 2A.)



PARTS REQUIRED.

10	of No.	1
13	" "	2
3	" "	3
1	" "	4
5	" "	5
8	" "	8
1	" "	11
12	" "	12
3	" "	15
2	" "	17
1	" "	19
2	" "	20
1	" "	21
1	" "	22
1	" "	24
1	" "	25
1	" "	26
1	" "	27
1	" "	33
4	" "	35
4	" "	37
61	" "	44
1	" "	45
2	" "	52
4	" "	55
1	" "	57

The lower horizontal ribs 1 and main vertical members 2 are made of angle girders overlapping nine holes; and the diagonal ties 3 of two $12\frac{1}{2}$ " strips and one $5\frac{1}{2}$ " strip, the $12\frac{1}{2}$ " strips being overlapped three holes, and the lower $5\frac{1}{2}$ " strip seven holes.

The pulley 4 is carried in a nosing made of two $5\frac{1}{2}$ " strips and two $12\frac{1}{2}$ " strips connected at their apex by angle brackets. The rear swivel point of the crane is made by bolting the gear box 5 to a double bent strip 6 secured to the floor. The crane runs on the flanged wheels 7, the spindles of which are secured in their position by collars and set screws.

MODEL No. 93. Travelling Swivel Crane

(MADE WITH MECCANO OUTFIT No. 3 OR NO. 2 AND NO. 2A.)

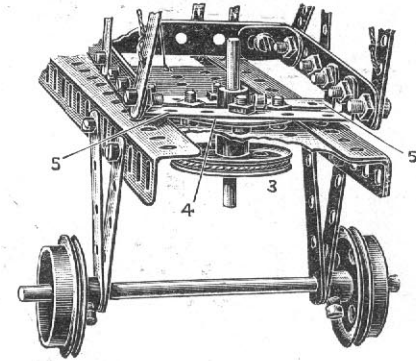
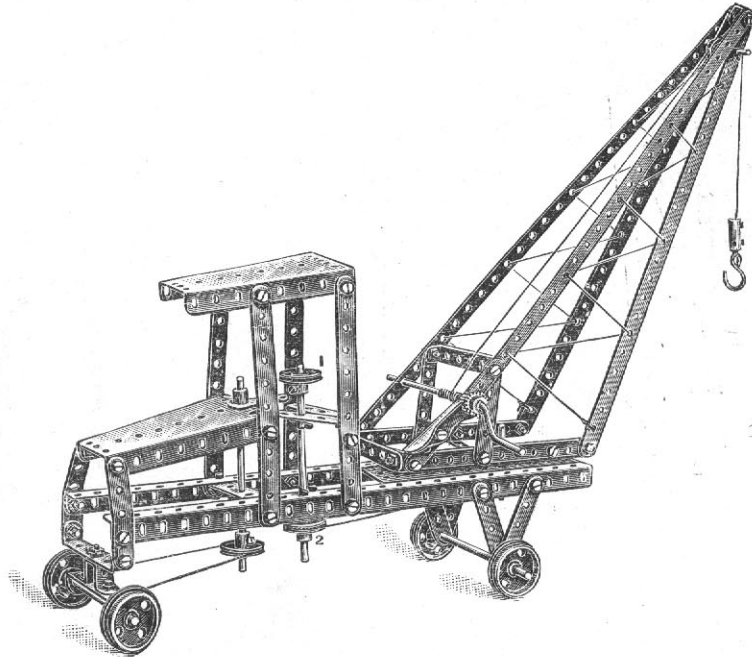

FIG. 93A.

The steering mechanism of this model is the same as in Model No. 79. The swivelling action of the jib is controlled by a handwheel 1 on an axle rod, at the foot of which is another 1" pulley 2, round which passes the operating cord to a 1½" pulley 3 on a 2" rod, to which is secured a bush wheel 4 bolted to 2½" bent strips 5, Fig. 93A. Bolts are inserted in four holes of the bush wheel, the heads of which keep the crane from tilting sideways as it swivels.

PARTS REQUIRED.

4 of No.	1	1 of No.	22A
6 "	2	1 "	24
2 "	3	1 "	26
11 "	5	1 "	33
2 "	8	6 "	35
1 "	11	51 "	37
2 "	12	1 "	45
3 "	15	1 "	52
1 "	16	2 "	54
2 "	17	1 "	57
1 "	19	6 "	60
4 "	20	1 "	62
1 "	21	1 "	63
3 "	22		

MODEL No. 94. Railway Wagon Swivel Crane

(MADE WITH MECCANO OUTFIT NO. 3 OR NO. 2 AND NO. 2A.)

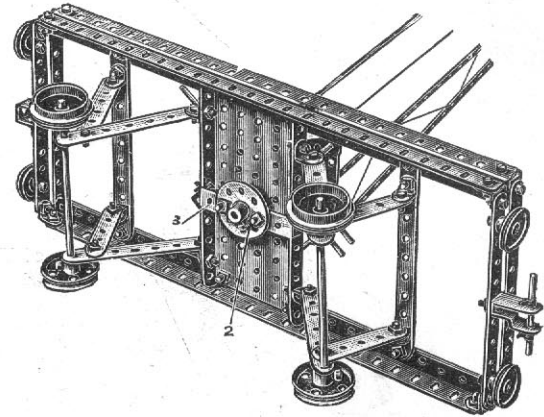
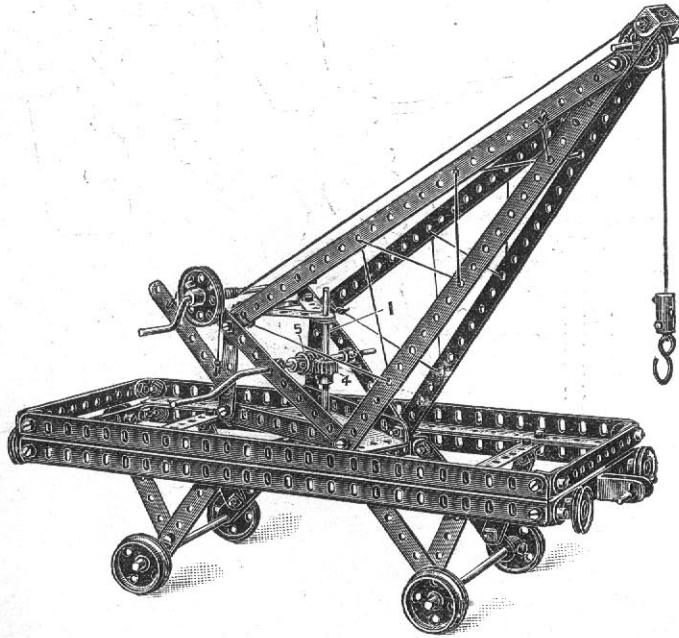

PARTS REQUIRED.

4	of	No.	1	I	of	No.	22A
8	"	"	2	I	"	"	24
5	"	"	3	I	"	"	26
9	"	"	5	I	"	"	32
4	"	"	8	5	"	"	35
1	"	"	11	69	"	"	37
16	"	"	12	I	"	"	44
3	"	"	15	I	"	"	45
2	"	"	17	I	"	"	52
2	"	"	19	I	"	"	54
4	"	"	20	I	"	"	57
1	"	"	21	2	"	"	59
4	"	"	22	2	"	"	60

The swivelling action of this model is obtained as follows: The spindle 1 is fixed against rotation in a bush wheel 2 bolted to a cross $2\frac{1}{2}$ " bent strip 3 beneath the wagon. The pinion 4 on the spindle 1 is therefore fixed, and when the worm 5 is rotated by the cranked handle the whole crane rotates about the pinion.

MODEL No. 95. Lever Balanced Luffing Jib Crane

(MADE WITH MECCANO OUTFIT NO. 3 OR NO. 2 AND NO. 2A.)

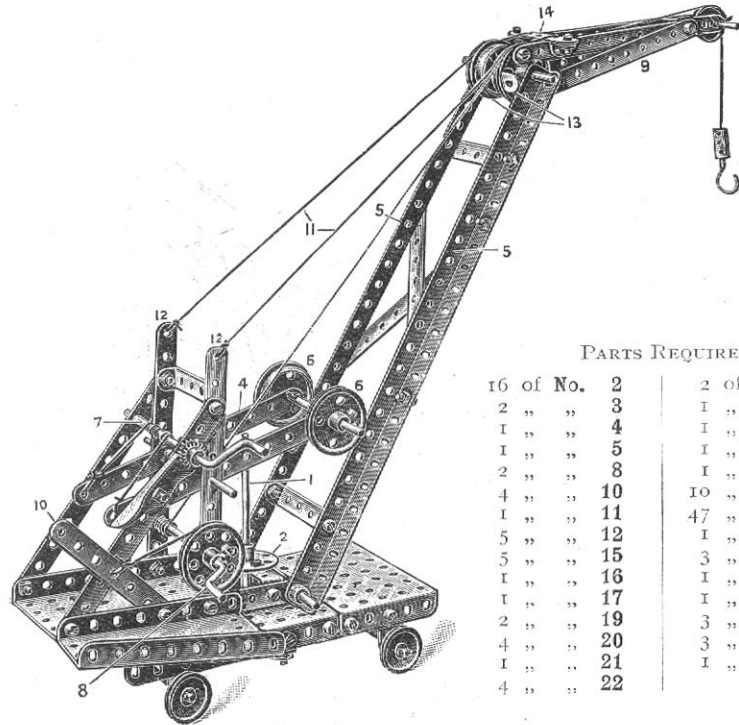

PARTS REQUIRED.

16 of No.	2	2 of No.	22A
2 "	3	1 "	23
1 "	4	1 "	24
1 "	5	1 "	26
2 "	8	1 "	33
4 "	10	10 "	35
1 "	11	47 "	37
5 "	12	1 "	52
5 "	15	3 "	53
1 "	16	1 "	54
1 "	17	1 "	57
2 "	19	3 "	59
4 "	20	3 "	60
1 "	21	1 "	63
4 "	22		

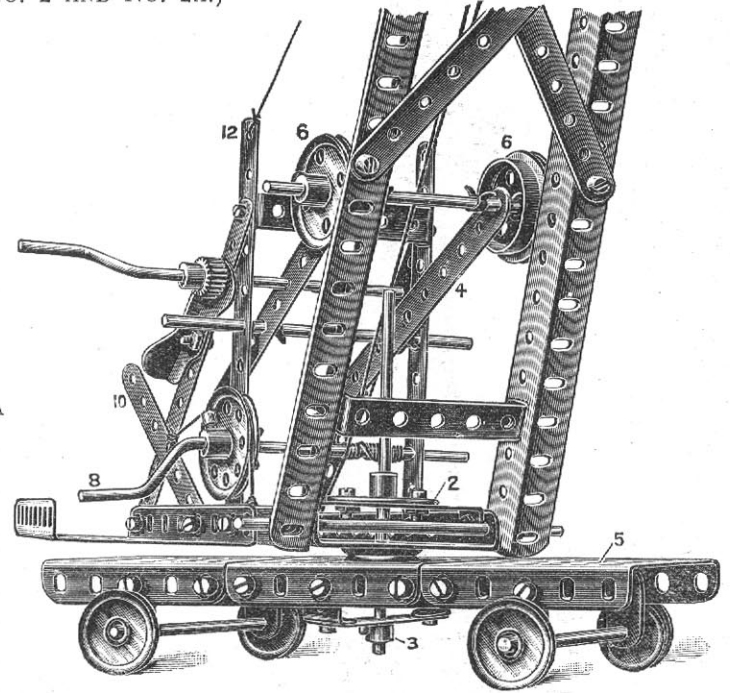
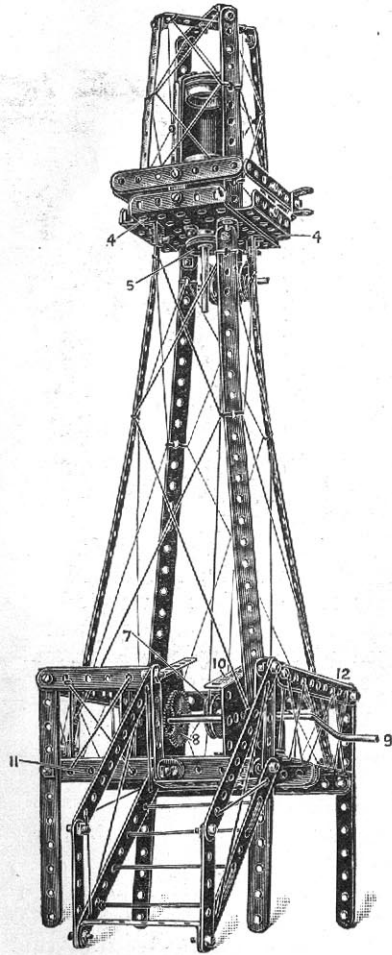

FIG. 95A.

The trolley platform is made up of three small flanged plates fastened together by $5\frac{1}{2}$ " strips on the inside of their flanges. The crane pivots about a rod 1 fixed in a bush wheel 2, and provided at its foot with a collar 3, as shown in detail, Fig. 95A. The luffing of the jib is effected by the pivoted strips 4 engaging the angle girders 5 of the jib by means of the flanged wheels 6, the strips 4 being connected to a double winding cord on the cranked handle axle 7. The load is raised by the cranked handle 8 and is swung out by the balanced lever 9 as the jib is luffed. A brake handle 10 is fitted (see standard detail A). The cords 11 are fixed at 12, carried over the flanged wheels 13, and fixed to the $2\frac{1}{2}$ " strip 14. The base 15 is made from three small flanged plates fastened together by a $5\frac{1}{2}$ " strip bolted to the inside of the flanges.

MODEL No. 96. Revolving Lighthouse

(MADE WITH MECCANO OUTFIT NO. 3 OR NO. 2 AND NO. 2A.)



PARTS REQUIRED.

4 of No.	1	2 of No.	22A
12 " "	2	1 " "	25
4 " "	3	1 " "	27
1 " "	4	4 " "	35
6 " "	5	73 " "	37
4 " "	10	1 " "	44
1 " "	11	1 " "	45
20 " "	12	2 " "	52
2 " "	16	2 " "	53
1 " "	17	2 " "	54
1 " "	19	1 " "	59
2 " "	20	6 " "	60
2 " "	22		

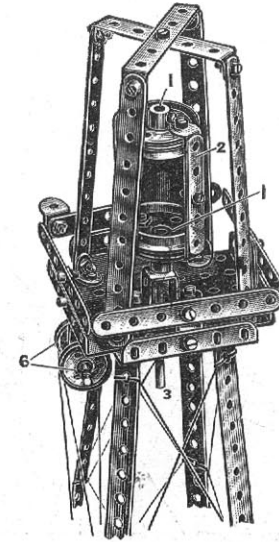

The revolving lantern is made from two flanged wheels 1 distanced by $2\frac{1}{2}$ " bent strips 2, the lower wheel fixed to a rod 3 passed through two crossed flanged plates 4, and has a 1" pulley 5 fixed beneath, round which the operating cord passes and is led over two 1" pulley wheels 6 to a lower pulley wheel 7 on an axle rod driven by gear wheels 8 from the cranked handle 9. The cranked handle and the gear wheels being journalled in sector plates 10 forming the side frames, which are bolted to two flanged plates 11 separated to fit within the $5\frac{1}{2}$ " strips 12 of the railing framework of the platform.

HOW TO CONTINUE

This completes the models which may be made with MECCANO Outfit No. 3. The next Models are a little more advanced, requiring a number of extra parts to construct them. The necessary parts are all contained in a No. 3A Accessory Outfit, the cost of which will be found in the Price List at the end of the Manual.

MODEL No. 97. Flying Machine

(MADE WITH MECCANO OUTFIT NO. 4 OR NO. 3 AND NO. 3A.)

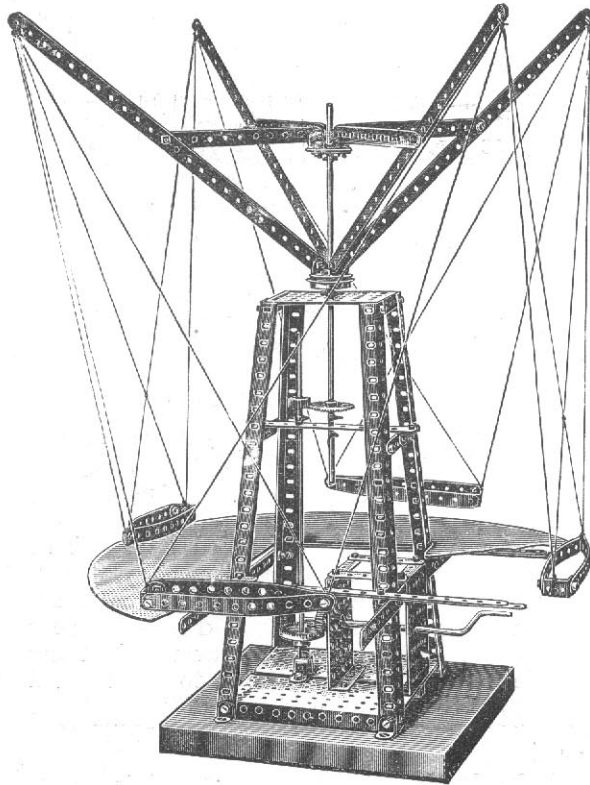

PARTS REQUIRED.

8 of No.	1	2 of No.	24
13 " "	2	2 " "	25
2 " "	3	1 " "	27
2 " "	5	1 " "	28
4 " "	8	74 " "	37
4 " "	11	1 " "	45
18 " "	12	2 " "	52
2 " "	13	3 " "	53
1 " "	19	4 " "	59

Most boys will have seen the Maxim Flying Machine at work, and will hardly fail to be interested in constructing a working model of it.

The main frame is composed of four angle girders connected at the bottom by two large flanged plates separated one hole apart and connected together by two small flanged plates carrying the crank handle, and at the top by a small flanged plate. Across the centre on opposite sides in the ninth hole down is attached a $3\frac{1}{2}$ " strip connected together by a $5\frac{1}{2}$ " strip. These transverse $3\frac{1}{2}$ " and $5\frac{1}{2}$ " strips and the small flanged plate at the top carry the perpendicular spindle upon which the upper structure revolves. A bush wheel is secured to this spindle to support the four arms, which are attached by four angle brackets. A pulley wheel is placed between this bush wheel and the perforated plate. The arms are supported by means of $5\frac{1}{2}$ " strips connected to a bush wheel secured on to the spindle, and the boats are connected to these by cord arranged as shown in the illustration. The platform is supported by four $12\frac{1}{2}$ " strips attached to the sides of the main framework. The manner of constructing the mechanism for operating the model is clearly shown in the illustration.

MODEL No. 98. Travelling Crane

(MADE WITH MECCANO OUTFIT NO. 4 OR NO. 3 AND NO. 3A)

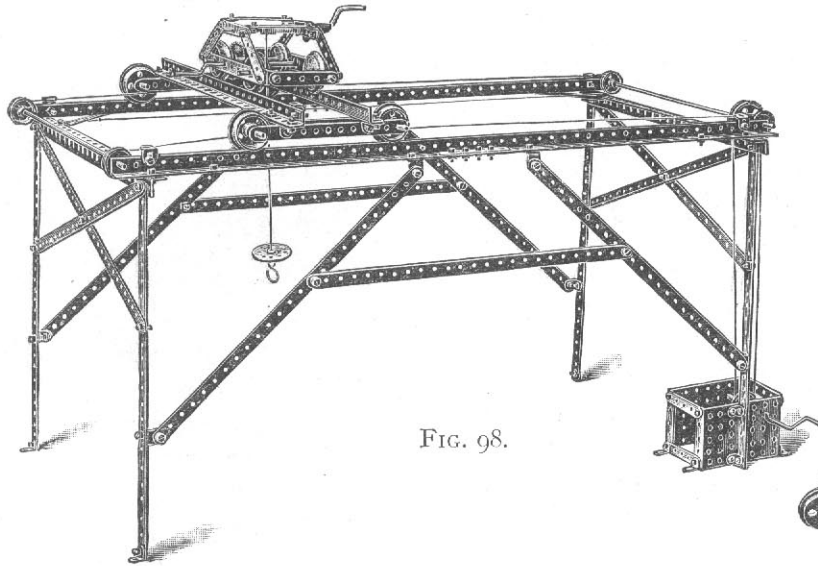

FIG. 98.

Separate views are given of two distinct parts composing the travelling crane. Fig. 98 is a complete view of the structure showing the braced gantry carrying a rail at each side. The rails are formed by angle girders butt-jointed. Fig. 98A shows the construction of the travelling gantry with two pairs of wheels so arranged as to fit the gauge of the rails. The gantry is caused to travel to and fro on the rails by a cord which is connected to the gantry by a nut and bolt 1 and passes over a pulley at each end of the rail, secured to the rod. On one of these rods is secured a $1\frac{1}{2}$ " pulley carrying the driving cord, which passes over a pulley wheel secured to the crank handle. The winch Fig. 98B again is arranged to run on the gantry rails of 98A, and is provided with a cranked hoisting axle 2 and another axle 3 for traversing the winch.

PARTS REQUIRED.

14 of No.	1	5 of No.	22
6 " "	2	1 " "	24
4 " "	4	1 " "	25
10 " "	5	1 " "	26
8 " "	8	1 " "	27
26 " "	12	1 " "	33
2 " "	13	4 " "	35
2 " "	15	98 " "	37
4 " "	17	2 " "	53
3 " "	19	1 " "	57
8 " "	20	4 " "	59
1 " "	21	4 " "	60

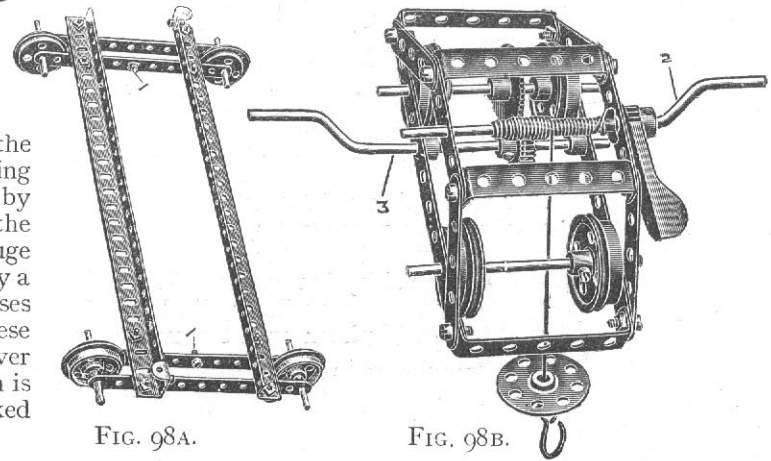

FIG. 98A.

FIG. 98B.

MODEL No. 99. Viaduct Bridge

(MADE WITH MECCANO OUTFIT NO. 4 OR NO. 3 AND NO. 3A.)

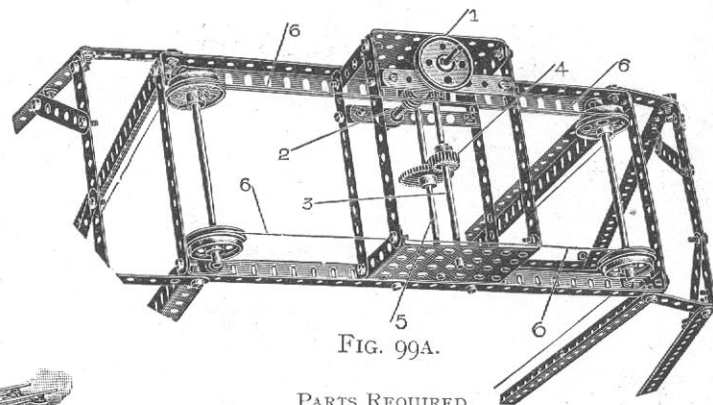
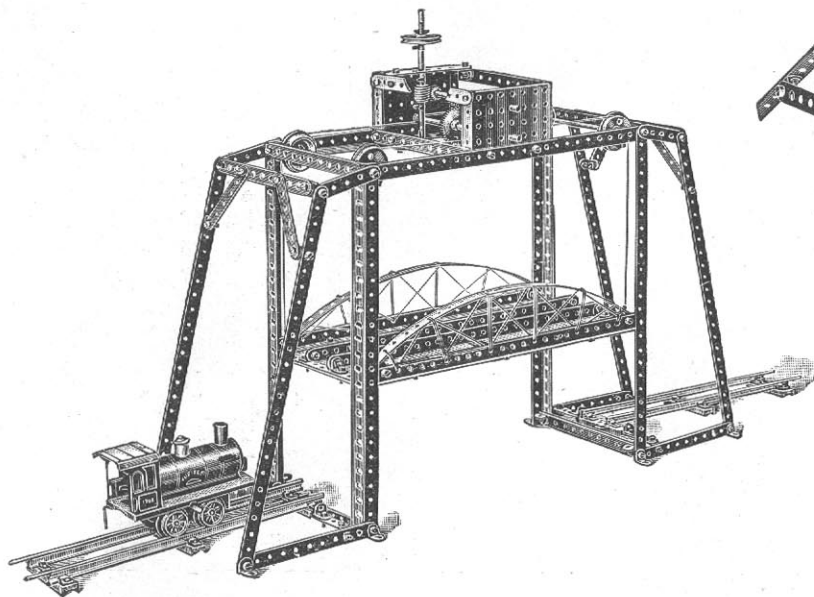

FIG. 99A.

PARTS REQUIRED.

8 of No.	1	4 of No.	20
17 " "	2	1 " "	25
2 " "	3	1 " "	26
4 " "	4	1 " "	27
4 " "	5	1 " "	32
8 " "	8	2 " "	35
32 " "	12	90 " "	37
2 " "	14	2 " "	53
3 " "	15	4 " "	59

This model shows the construction of a suspended viaduct bridge, the central girder platform when lowered permitting the locomotive to pass along the continuous track, which is raised to enable ships to pass along the waterway beneath the gantry. The central movable girder platform is suspended from the corner cords, passing over the four pulley wheels, and is raised or lowered by the operation of the gear mechanism in the gear box, Fig. 99A, on the top of the gantry. The grooved pulley wheel 1 on the vertical driving shaft may be operated from an engine or motor. The shaft carries a worm 2 gearing with a $\frac{1}{2}$ " pinion on a transverse shaft 3 which has a $\frac{3}{4}$ " pinion 4, which in turn gears with a gear wheel on the winding spindle 5 to operate the lifting cords. As will be seen by reference to Fig. 99A the operating cords are led on to the winding spindle 5 in opposite directions, so that when the spindle is being continuously driven in one direction all four cords 6 wind on or off simultaneously.

The side rails and locomotive shown in the illustration are not included in the Outfit.

MODEL No. 100. Elevated Jib Crane

(MADE WITH MECCANO OUTFIT NO. 4 OR NO. 3 AND NO. 3A.)

PARTS REQUIRED.

4 of No.	1	2 of No.	25
7 " "	2	1 " "	27
2 " "	3	1 " "	28
11 " "	5	9 " "	35
4 " "	8	64 " "	37
2 " "	11	1 " "	45
11 " "	12	2 " "	46
2 " "	13	2 " "	52
2 " "	15	3 " "	53
3 " "	17	1 " "	54
4 " "	20	1 " "	57
1 " "	21	4 " "	59
5 " "	22	4 " "	60
1 " "	24		

FIG. 100A.

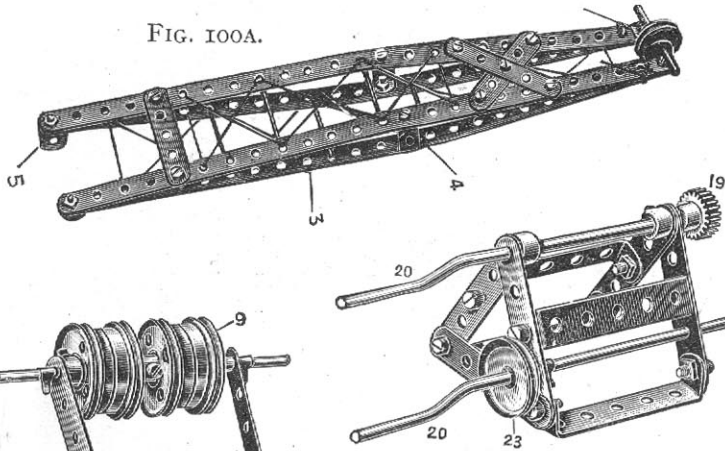
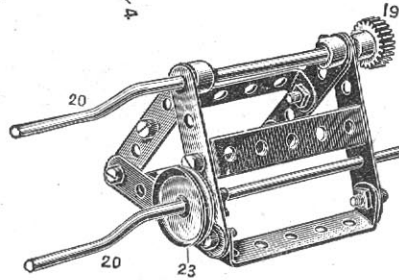

FIG. 100C.



The base of the main frame is composed of two large flanged plates 1, to the outer corners of which are bolted the vertical angle girders 2. The jib, Fig. 100A, is made from $1\frac{1}{2}$ " strips 3 distended centrally by double brackets 4 and bolted together at the ends. Angle brackets 5 form the pivots for the jib about a spindle 6 mounted in the end holes 7 of the flanges of the sector plate 8 forming the base of the upper gear box, Fig. 100B. The balance weight 9 is composed of several flanged wheels carried from $5\frac{1}{2}$ " strips 10. The hoisting cord 11 passes over the jib end pulley to the guide pulley 12, and winds on the upper end of the vertical spindle 13, carried in the angle bracket 14 and the top plate 15. The vertical spindle 13 is operated by a gear wheel 16 meshing with a $\frac{3}{4}$ " pinion on the other vertical spindle 17, which is driven by a contrate wheel 18 from a $\frac{3}{4}$ " pinion 19, Fig. 100C, on the cranked spindle 20. The swivelling of the jib is effected from the cranked spindle 21 by the continuous cord 22 which passes

round the pulley wheel 23 over the pulley wheel 24, and round the $1\frac{1}{2}$ " pulley wheel 25, bolted to the under surface of the base

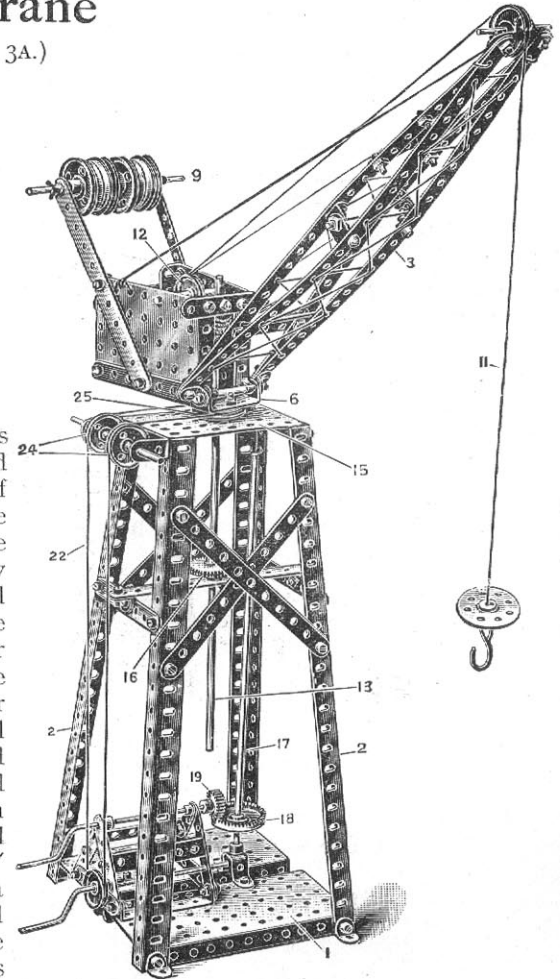
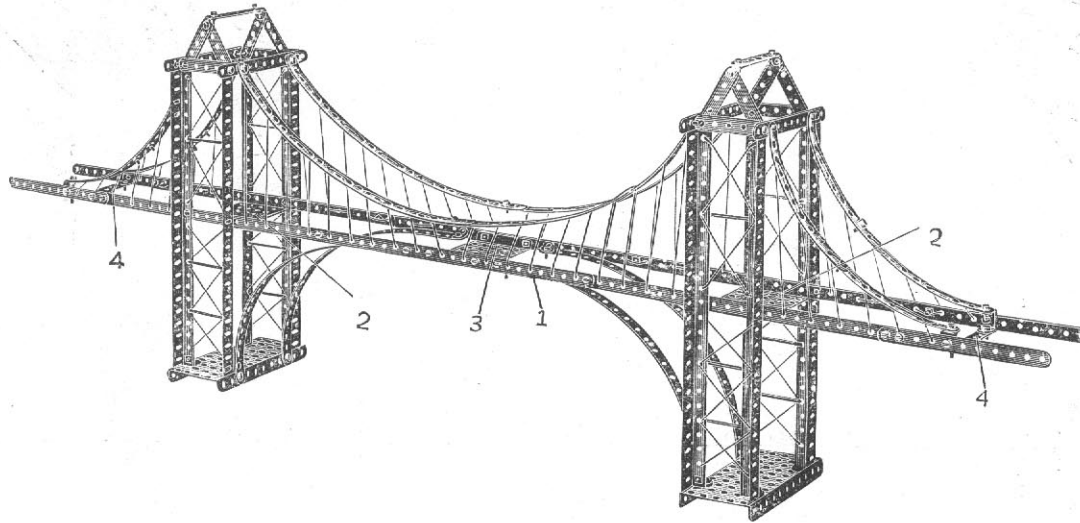

FIG. 100B.

MODEL No. 101. Suspension Bridge

(MADE WITH MECCANO NO. 4 OR NO. 3 AND NO. 3A.)



PARTS REQUIRED.

14	of	No.	1
16	"	"	2
2	"	"	3
2	"	"	4
12	"	"	5
8	"	"	8
4	"	"	11
22	"	"	12
98	"	"	37
2	"	"	52
3	"	"	53

The end towers of this model are built up from four angle girders carried from large flanged plates at the base.

The rail track platform 1 is coupled to the towers by small flanged plates 2. A third small flanged plate 3 being disposed at the centre of the track platform. $3\frac{1}{2}$ " strips 4 connect the side strips of the girder platform at each-end. Any suitable track rails may be laid across the girder platform.

MODEL No. 102. Warehouse with Elevator

(MADE WITH MECCANO OUTFIT NO. 4 OR NO. 3 AND NO. 3A.)

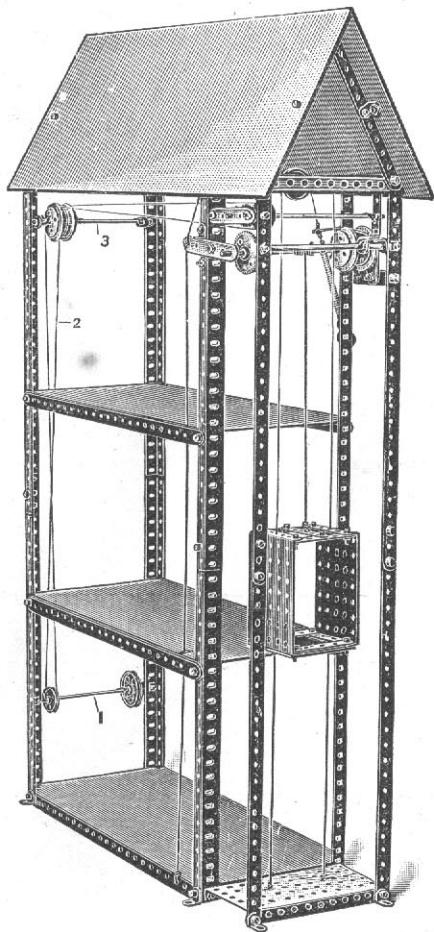

PARTS REQUIRED.

13	of	No.	1
8	"	"	2
2	"	"	3
1	"	"	4
7	"	"	5
8	"	"	8
29	"	"	12
2	"	"	14
3	"	"	15
2	"	"	17
4	"	"	20
1	"	"	21
4	"	"	22
1	"	"	25
1	"	"	27
6	"	"	35
86	"	"	37
1	"	"	43
2	"	"	52
2	"	"	53
1	"	"	57

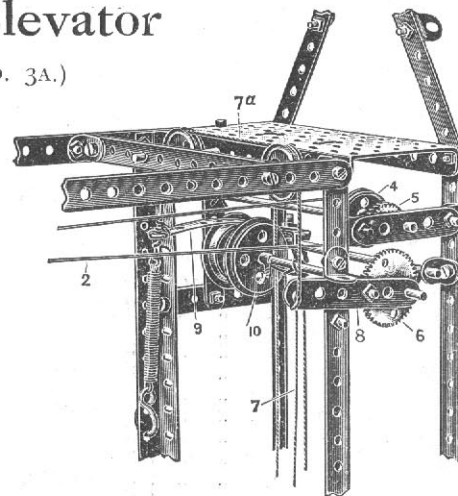

The structure of the warehouse is built up of corner members made from pairs of angle girders overlapped three holes and bolted together in the middle hole. These are connected at the sides by $12\frac{1}{2}$ " strips, and at the ends, top, and bottom by $5\frac{1}{2}$ " strips, and a large flanged plate to form the floor for the elevator arrangement.

The driving shaft 1 is connected to the grooved pulley 4 by belt 2 passing over loose pulleys and shaft 3. The shaft carrying the pulley 4 is fitted with a $\frac{3}{4}$ " pinion 5, and is adapted to be geared with the gear wheel 6 by operating the cord 7 controlling the lever 8 which carries the wheel spindle. The cord 7 is extended over pulleys at 7a and connected to a brake band 9 engaging the brake driven pulley 10, formed of two flanged wheels butted together and secured to the winding spindle. The one operation of throwing the gear wheel 6 into engagement with the driving pinion 5, simultaneously releases the brake 9 and enables the cage to be hoisted. By only partially releasing the operating cord 7 the gears 5 and 6 are disconnected without the brake 9 being engaged, the cage is then allowed to descend freely.

MODEL No. 103. Cable Railway

(MADE WITH MECCANO OUTFIT NO. 4 OR NO. 3 AND NO. 3A.)

PARTS REQUIRED.

3	of	No.	2
2	"	"	4
1	"	"	5
2	"	"	8
6	"	"	12
6	"	"	15
4	"	"	20
1	"	"	21
2	"	"	22
2	"	"	25
1	"	"	27
2	"	"	29
2	"	"	35
28	"	"	37
1	"	"	46
2	"	"	52
3	"	"	53
2	"	"	54
2	"	"	59

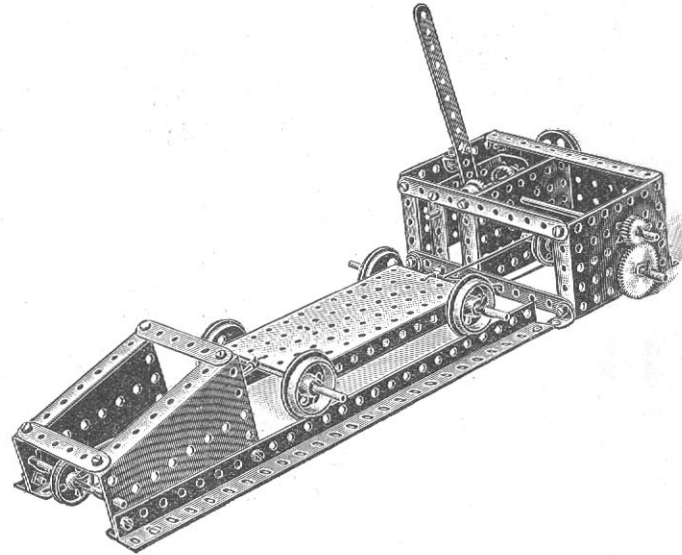

Our illustration hardly does this excellent model justice, owing to the parts having to be so crowded together. This is a very fine model, both instructive and highly interesting.

The driving power is received at the outer $1\frac{1}{2}$ " pulley, and is transmitted through the clutch mechanism and the pinion and gear wheels to the lower spindle on which the driving pulley is fixed, the driving rope passing round this pulley and the second pulley at the end of the rails, all as shown in the drawing.

In fixing the lever for operating the clutch mechanism, the nuts should be locked to prevent the screw working out. Only one section of rails is shown in the design, but they may be extended as desired.

MODEL No. 104. Swivelling and Luffing Jib Crane

(MADE WITH MECCANO OUTFIT NO. 4 OR NO. 3 AND NO. 3A.)

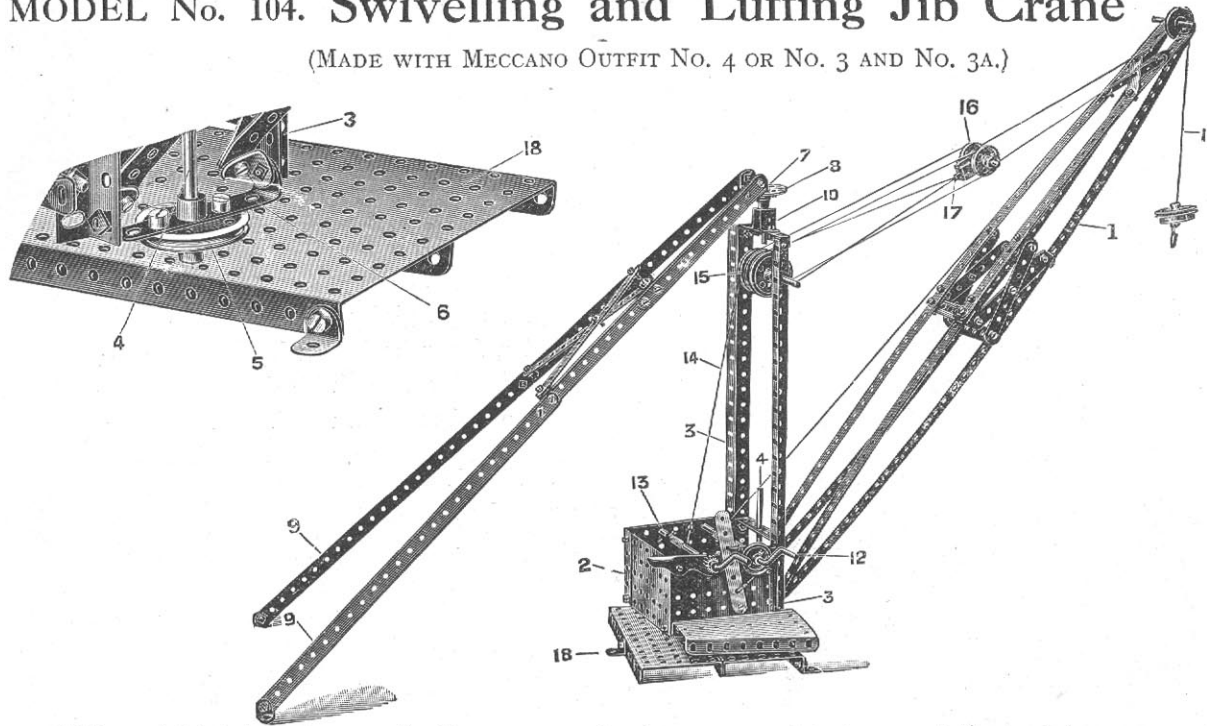

PARTS REQUIRED.

IO of	No.	1
6	"	2
5	"	3
2	"	5
1	"	11
21	"	12
2	"	15
2	"	17
2	"	19
4	"	20
1	"	21
3	"	22
2	"	24
1	"	26
1	"	33
7	"	35
78	"	37
2	"	52
3	"	53
1	"	54
1	"	57
4	"	60

This model is interesting as affording an example of a crane used to transport the load from say a ship's deck on to a quay by "luffing" or altering the angle of the jib. The jib 1 and its gear box 2, as well as the vertical angle girders 3, all swivel about pivots, the lower one formed by a spindle 4 secured in a pulley wheel 5 bolted to a $2\frac{1}{2}$ " bent strip 6, which is also bolted to the girders 3. The upper pivot is a spindle 7 fixed to a bush wheel 8 bolted by angle brackets to the shear legs 9. A double bent strip 10 forms a strong bearing for the spindle 7. The hoisting cord 11 passes round the end jib pulley on to the cranked winding spindle 12. The "luffing" or raising of the jib is controlled by the cranked spindle 13, the cord 14 from which passes over one of the flanged wheels 15 round one of the pair of pulley wheels 16, back round another flanged wheel 15, then round the remaining pulley wheel 16, again round the last flanged wheel 15, and is made fast to the single bent strip 17 between the pulley wheels 16. Cords are connected to the ends of the spindle of the pulley wheels 16 and the end of the jib. The feet of the shear legs 9, and the angle brackets on the flanges of the base flanged plates 18, carrying the spindle 4, should be screwed to some suitable wooden base.

MODEL No. 105. Drilling Machine

(MADE WITH MECCANO OUTFIT NO. 4 OR NO. 3 AND NO. 3A.)

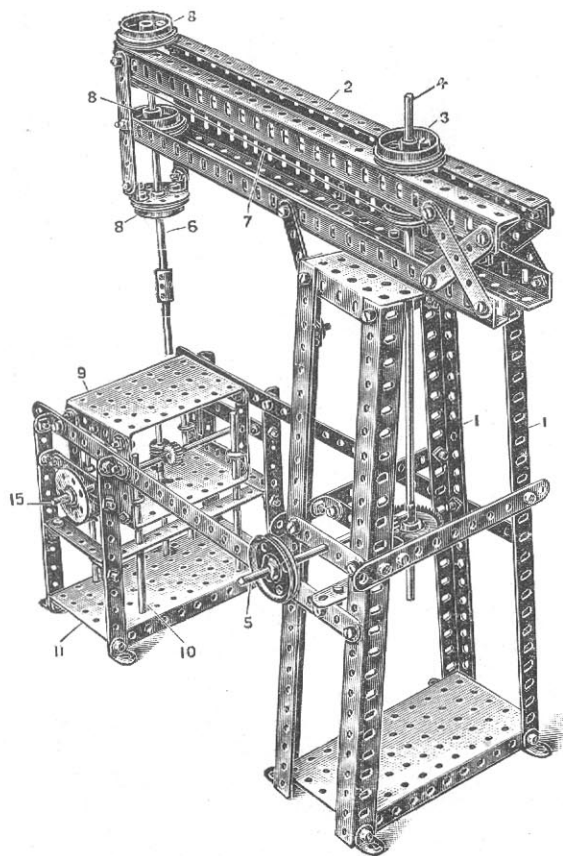

The main tower built up of top and bottom perforated plates with angle girder corner pieces, supports the driller arm made up of four angle girders 2. The lower angle girders of the arm 2 are bolted to the top flanged plate, and a flanged wheel 3 bolted to the top angle girders forms the upper bearing for the driving shaft 4, driven from the main shaft 5 through a pinion and contrate wheel.

The drive from the shaft 4 is conveyed to the drilling spindle 6 by cord 7 passing round grooved pulleys on the spindles 4 and 6. The spindle 6 is journalled in flanged wheels 8 carried from the arm 2.

The drilling table 9 is arranged to rise and fall on the vertical spindles 10, Fig. 105A. These spindles 10 being held in the perforated plate 11, and framing strips 12, and passing through the end holes in the perforated plate 9A of the table and guide angle brackets 13 bolted to the table walls. The vertical movement of the table is effected by the pinion 14 secured to the operating shaft 15 meshing with the worm wheel 16 carried on a spindle 17 rigidly secured with collars and set screws to the table, the worm 16 acting as a rack.

MODEL No. 105. Drilling Machine *(continued)*

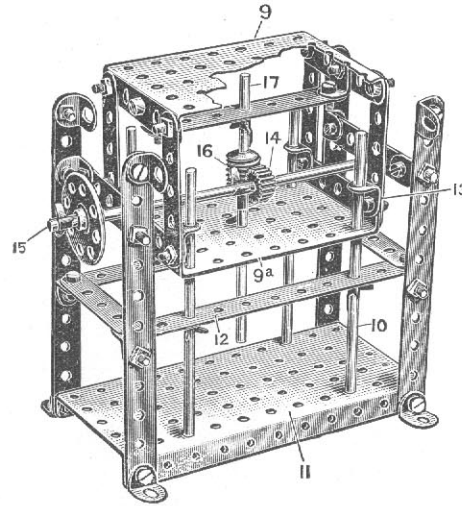

FIG. 105A.

PARTS REQUIRED.

2	of	No.	1
9	"	"	2
3	"	"	3
2	"	"	4
9	"	"	5
8	"	"	8
2	"	"	11
22	"	"	12
1	"	"	13
2	"	"	14
6	"	"	15
1	"	"	17
4	"	"	20
1	"	"	21
2	"	"	22
1	"	"	24
2	"	"	26
1	"	"	28
1	"	"	32
8	"	"	35
96	"	"	37
2	"	"	52
3	"	"	53
4	"	"	59
5	"	"	60
1	"	"	63

MODEL No. 106. Travelling Crane

(MADE WITH MECCANO OUTFIT NO. 4 OR NO. 3 AND NO. 3A.)

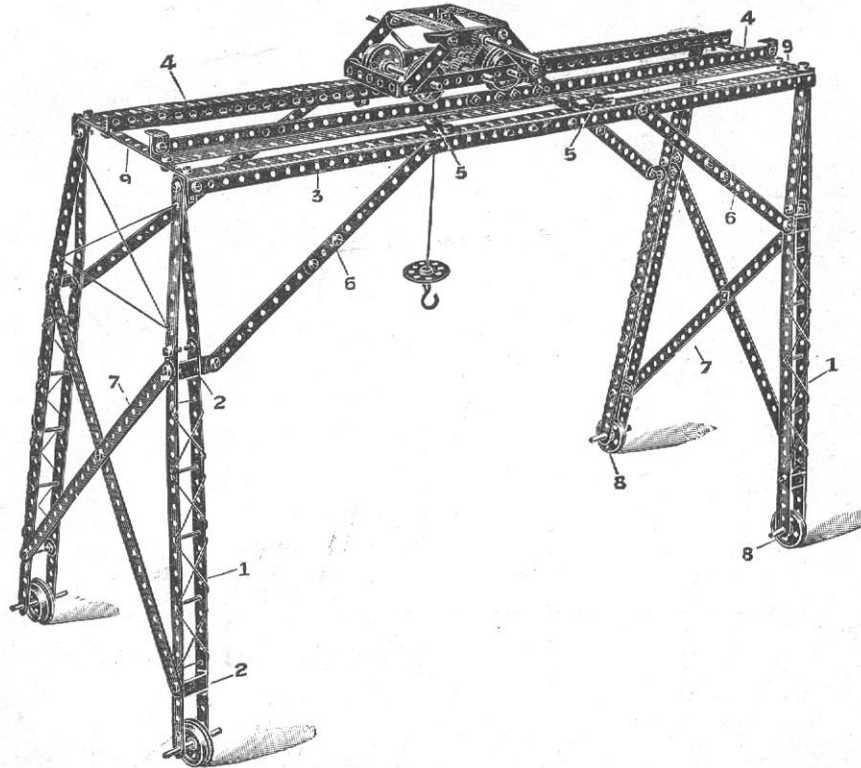

PARTS REQUIRED.

12	of	No.	1
20	"	"	2
2	"	"	4
6	"	"	5
8	"	"	8
4	"	"	10
8	"	"	11
8	"	"	12
1	"	"	16
4	"	"	17
2	"	"	19
8	"	"	20
1	"	"	24
1	"	"	25
1	"	"	26
1	"	"	27
1	"	"	33
80	"	"	37
1	"	"	57
4	"	"	60

The side frames of this model are similarly constructed. Each leg 1 is made of $12\frac{1}{2}$ " and $5\frac{1}{2}$ " perforated strips overlapped two holes and distended by double brackets 2 and bolted together at the top, and to angle brackets bolted to the ends of the outer horizontal angle girders 3. The inner angle girders 4 are reversed with their webs up, to form rails for the crane. The central parts of the girders 4 are supported by flat brackets 5, and the outer girders 3 are braced by the diagonal $5\frac{1}{2}$ " strips 6 bolted to the legs 1 and the girders 3. Each end pair of legs is also braced by the crossed $12\frac{1}{2}$ " strips 7. The whole gantry travels on the flanged wheels 8 carried on 2" rods passed through the lowest holes of the legs 1. $5\frac{1}{2}$ " strips 9 connect the outer girders 3 and inner girders 4. The winch is constructed as shown in Fig. 98B.

MODEL No. 107. Girder Crane

(MADE WITH MECCANO OUTFIT No. 4 OR No. 3 AND No. 3A.)

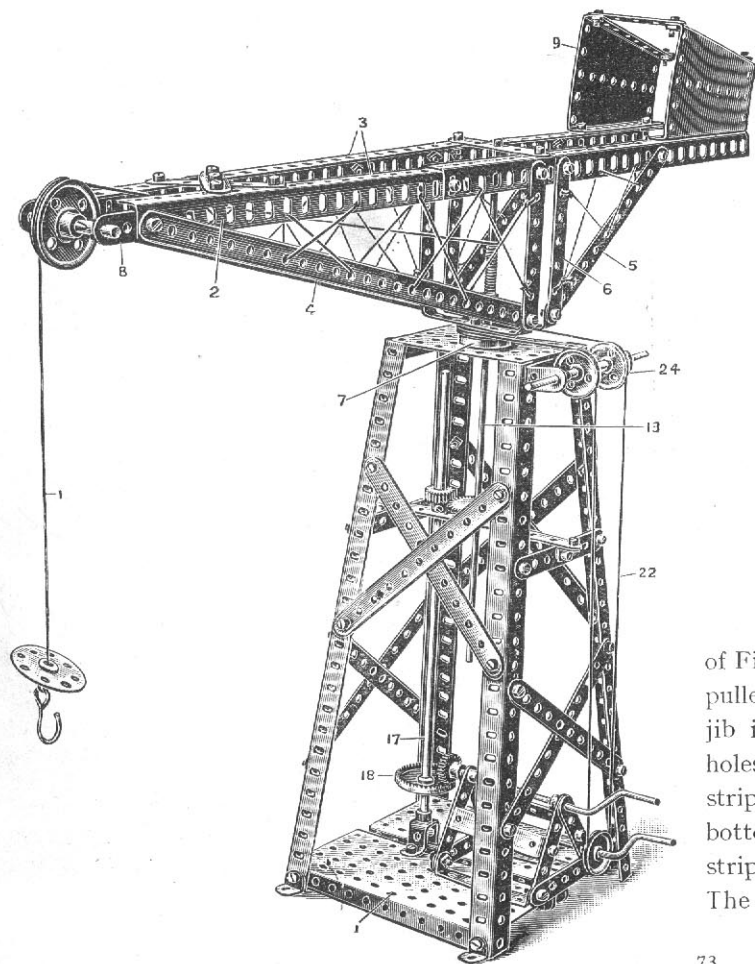

PARTS REQUIRED.

2 of No.	1	2 of No.	25
11 "	2	1 "	27
6 "	3	1 "	28
14 "	5	6 "	35
8 "	8	75 "	37
6 "	12	1 "	45
2 "	13	1 "	46
1 "	16	2 "	52
1 "	17	1 "	53
2 "	19	2 "	54
1 "	20	1 "	57
1 "	21	4 "	59
3 "	22	6 "	60
1 "	24		

The lower structure of this model is identical with that of Fig. 100. The hoisting cord 1 after passing over the end jib pulley, winds on the $11\frac{1}{2}$ " rod 13, as described in Fig. 100. The jib is built up of horizontal angle girders 3, overlapped 8 holes and strengthened by the diagonal $12\frac{1}{2}$ " strips 4 and $5\frac{1}{2}$ " strips 5 connected to the vertical $3\frac{1}{2}$ " strips 6 bolted at the bottom to $2\frac{1}{2}$ " bent strips bolted to the flanged wheel 7. $2\frac{1}{2}$ " strips 8 extend from the angle girders 3 to carry the jib pulley. The balance weight is formed by two sector plates 9.

MODEL No. 108. Coal Tip

(MADE WITH MECCANO OUTFIT NO. 4 OR NO. 3 AND NO. 3A.)

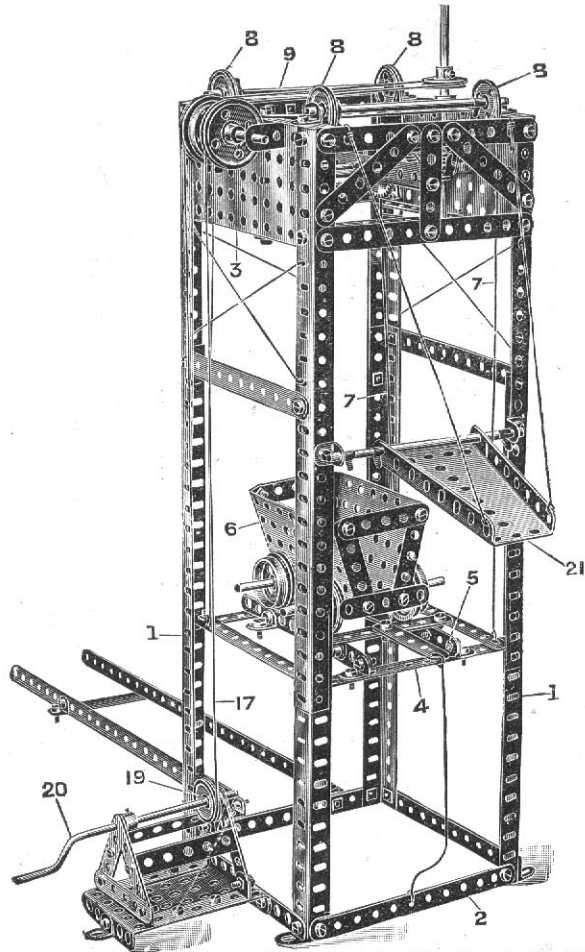

PARTS REQUIRED.

2	of	No.	1
19	"	"	2
3	"	"	3
4	"	"	4
13	"	"	5
8	"	"	8
28	"	"	12
2	"	"	14
7	"	"	15
1	"	"	16
1	"	"	19
6	"	"	22
2	"	"	25
1	"	"	26
1	"	"	27
1	"	"	32
15	"	"	35
110	"	"	37
1	"	"	46
2	"	"	52
3	"	"	53
1	"	"	54
4	"	"	59
4	"	"	60

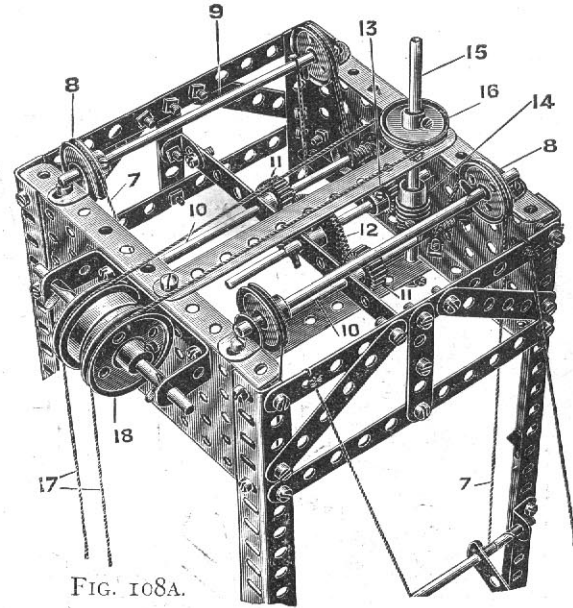
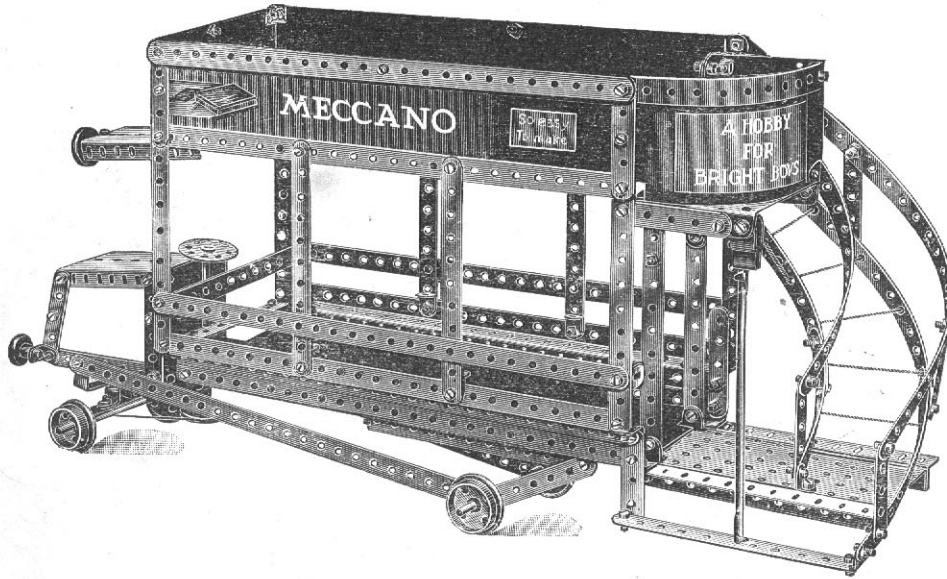

FIG. 108A.

The vertical standards 1 are built up from overlapped angle girders, connected by cross strips 2 and flanged plates 3. The rising and falling platform 4, upon the rails 5 of which the truck 6 is carried, is arranged to be raised or lowered in the framework 1 by the suspension cords 7, one at each corner. These suspension cords are connected to the corners of the platform 4, and pass over four pulleys 8 carried in the head of the frame on spindles 9. The cords 7 after passing over the pulleys 8 are wound on lower spindles 10 (Fig. 108A), fitted with pinions 11 gearing with and being driven by a gear wheel 12. On the same spindle which carries the gear wheel 12 is a pinion 13, driven by a worm 14 on a vertical spindle 15 carrying a pulley 16. The operating cord 17 passes round the pulley 16 and the flange pulleys 18, to a pulley 19 on the crank spindle 20, by means of which the raising or lowering of the platform 4 is controlled. The chute 21, made from a sector plate, is carried from a spindle passed through its inner perforations and secured to the uprights 1, and is supported by cords from its outer perforations.

MODEL No. 109. Motor Bus

(MADE WITH MECCANO OUTFIT No. 4 OR No. 3 AND No. 3A.)



PARTS REQUIRED.

12 of No.	1
18 "	2
6 "	3
2 "	4
16 "	5
6 "	8
31 "	12
1 "	14
3 "	15
4 "	20
2 "	22
1 "	24
2 "	29
120 "	37
1 "	44
2 "	45
1 "	46
2 "	52
1 "	53
2 "	54
5 "	59
1 "	60

The chassis, Fig. 109A, is built up of angle girders 1, to which is bolted the bonnet, made up of a large flanged plate 2 and sector plate 3, the steering wheel 4 being carried on a spindle pivoted in the plate 2, and secured in position by a collar and set screw 4 on the top, and a double bent strip bolted below the plate, a 1" pulley being secured at the bottom of the spindle, around which a cord is passed twice and connected with each end of the front axle strip. The rear platform 7 is bolted to the girders 1. The superstructure, Fig. 109B, the construction of which is well shown in the figure, is connected to the chassis as follows. The end brackets 6 are bolted to the plate 7 and the strip 10, and the holes 8 to the angle brackets 9. The strips 11 are also bolted to the end vertical strips 12 of the superstructure. The upper ends of the door frame strips 13 are bolted to angle brackets beneath the forward edge of the flanged plate 14. The cardboard decorations shown in this model are not supplied with the outfit.

MODEL No. 109. Motor Bus (continued)

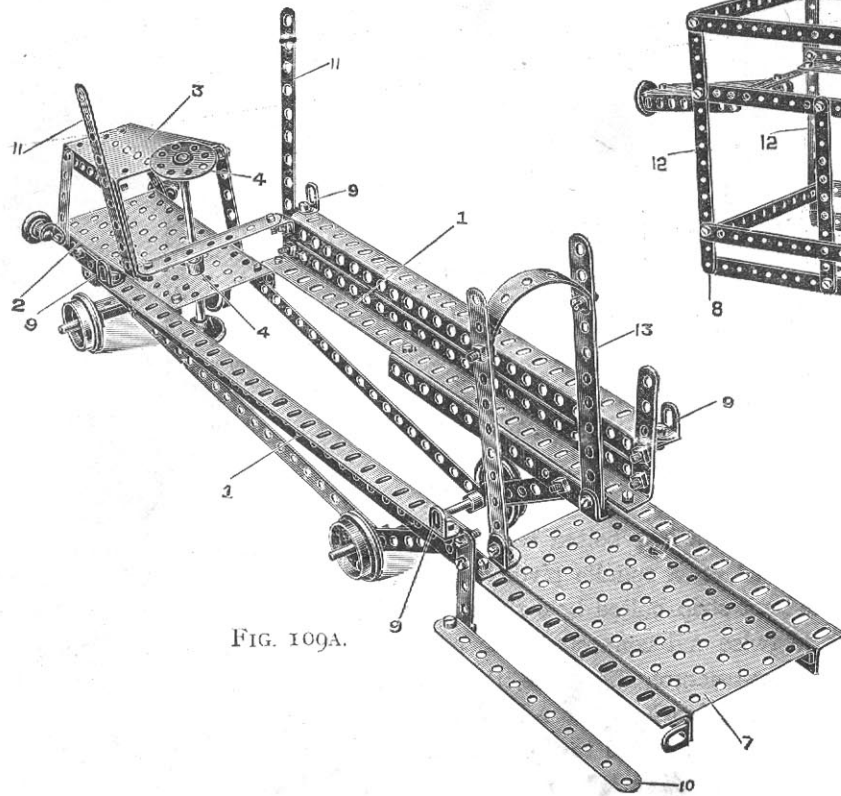

FIG. 109A.

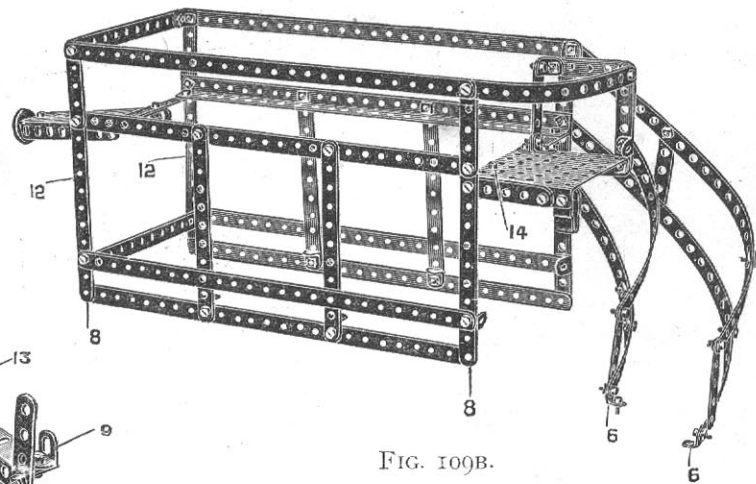
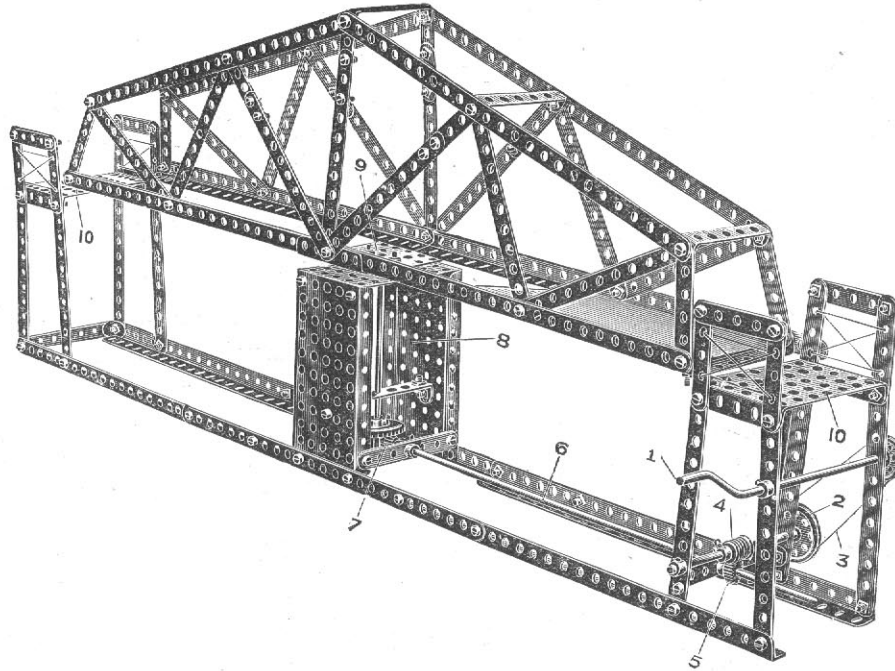

FIG. 109B.

MODEL No. 110. Swing Bridge

(MADE WITH MECCANO OUTFIT NO. 4 OR NO. 3 AND NO. 3A.)



PARTS REQUIRED.

6	of	No.	1
22	"	"	2
6	"	"	3
4	"	"	4
19	"	"	5
8	"	"	8
6	"	"	12
1	"	"	13
2	"	"	15
1	"	"	16
1	"	"	19
1	"	"	21
1	"	"	22
1	"	"	24
2	"	"	26
1	"	"	28
1	"	"	32
85	"	"	37
2	"	"	52
4	"	"	53
4	"	"	59
5	"	"	60
1	"	"	63

The construction of this model will be quite apparent from the illustration. The crank handle 1 drives a pulley 2 by means of the cord 3. On the pulley spindle 2 is fixed a worm 4 geared with a $\frac{1}{2}$ " pinion 5 on the axle 6, another $\frac{1}{2}$ " pinion on the end of which drives a contrate wheel 7 on the vertical spindle 8 which carries the bridge, this spindle being secured to a bush wheel fastened to the underside of the small flanged plate 9 in the centre of the bridge. By operating the handle 1 the bridge may be swung round to the open position, or its ends brought opposite to the landing platforms 10

MODEL No. 111. Battleship

(MADE WITH MECCANO OUTFIT NO. 4 OR NO. 3 AND NO. 3A.)

The main lines of the model can be easily followed from the illustration, the upper structure and bridge being built up separately as shown in Fig. IIIA. The base of the upper structure is made from two large flanged plates 1, to the ends of which are bolted two sector plates 2 carrying the fore and aft guns. These are made from flanged pulley wheels 3 on vertical spindles 4 forming the pivot of the gun, the gun itself being formed from pieces of axle rod 5, to the ends of which are gripped two couplings 6 threaded on the vertical rod 4 and held in place by collars 7. Above the large flanged plates 1 two smaller flanged plates 8 are bolted, which carry the masts 9 stepped into 1" pulley wheels 10 and secured beneath by collars. The outer flanges of the plates 1 are bolted to the gunwale strips 11. The funnels 12 are made from the metal cylinders supplied, which are sprung over the 1" pulley wheels 13 and closed at the top by other pulley wheels.

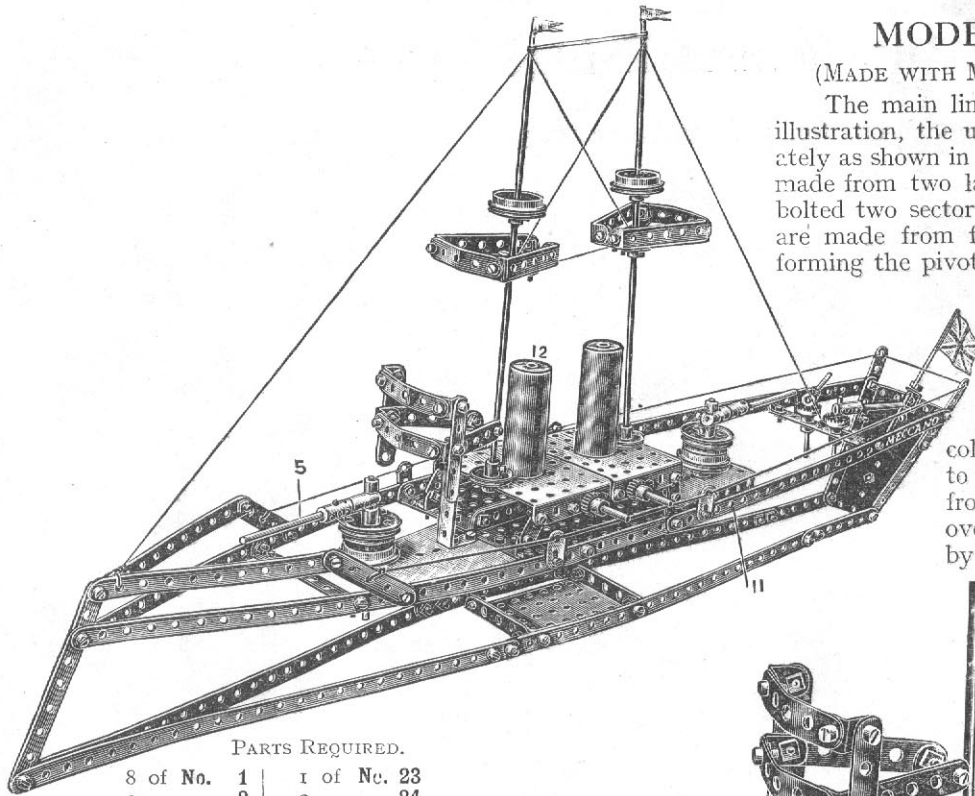

PARTS REQUIRED.

8 of No.	1	1 of No.	23
2 "	2	2 "	24
5 "	3	2 "	25
14 "	5	2 "	26
8 "	10	2 "	29
1 "	11	1 "	35
19 "	12	101 "	37
2 "	13	1 "	46
2 "	14	2 "	52
1 "	15	3 "	53
4 "	16	3 "	54
4 "	17	8 "	59
6 "	20	8 "	60
4 "	22	6 "	63
2 "	22A		

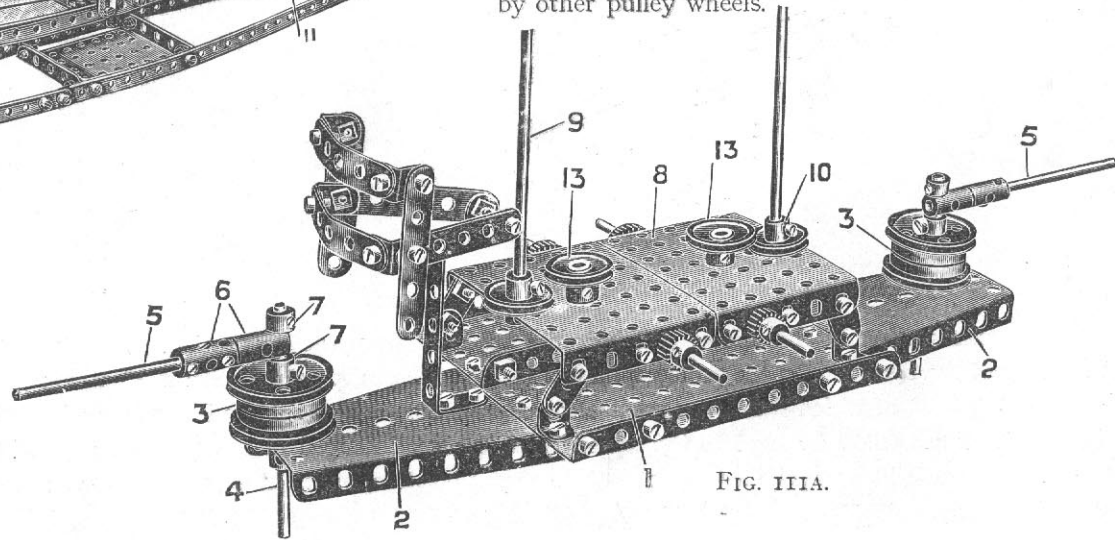
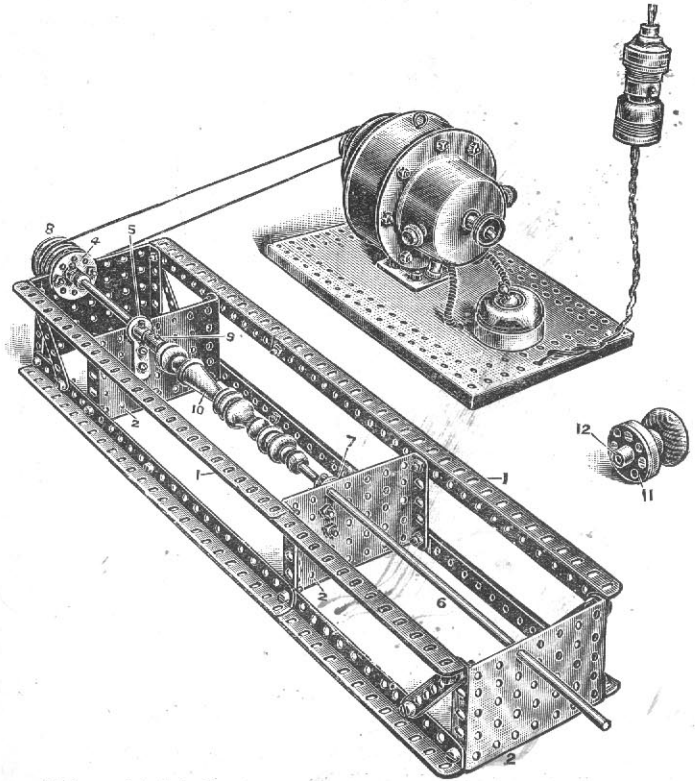

FIG. IIIA.

MODEL No. 112. Turning Lathe

(MADE WITH MECCANO OUTFIT NO. 4 OR NO. 3 AND NO. 3A.)



PARTS REQUIRED.

4 of No.	4
8 "	8
1 "	13
1 "	14
2 "	20
1 "	24
30 "	37
4 "	53
1 "	59
2 "	62

This model is but one example of the great practical possibilities to which the Meccano system of construction may be applied. The illustration shows a model lathe, the framework of which is built very rigidly of overlapped angle girders 1, to which are bolted by their flanges four small flanged plates 2, the fast headstock of the lathe being provided by a 5" rod, one end journalled in a bush wheel 4 bolted to the end plate, and the other journalled in the boss of a crank 5. The loose headstock is formed by an axle 6 journalled in the end plate 2, and a crank 7 bolted to the inner plate. The drive from the motor is carried round two flanged wheels 8 butted together on the headstock spindle, on the other end of which is gripped a coupling 9 by one of its screws, this coupling being also secured to a centre fork driven into the article 10 to be turned. The detail view to the right shows how a knob or other article may be screwed to a bush wheel 11, the base 12 of which is gripped by its screw to the headstock spindle to form a chuck or face plate. The electric motor shown in the illustration is one-thirtieth horse-power. The price of this motor will be found at the end of the Manual.

MODEL No. 113. Dutch Windmill

(MADE WITH MECCANO OUTFIT NO. 4 OR NO. 3 AND NO. 3A.)

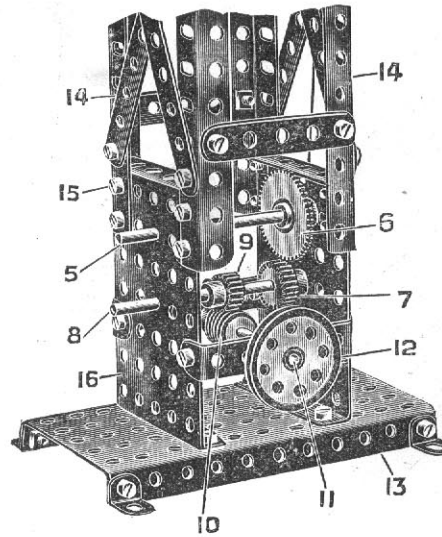
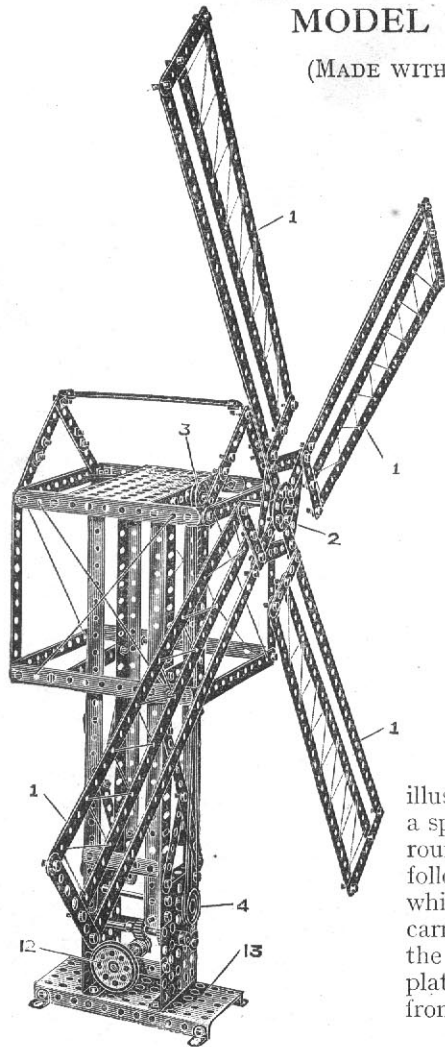

PARTS REQUIRED.

12 of No.	1
19 "	2
4 "	3
4 "	4
14 "	5
4 "	8
22 "	12
1 "	14
3 "	16
1 "	21
2 "	22
1 "	24
1 "	25
1 "	26
1 "	27
1 "	32
120 "	37
2 "	52
2 "	53
3 "	59
2 "	60

FIG. 113A.

The construction of the sails 1 of the mill will be readily followed from the illustration. They are bolted to an inner strip frame 2 and to a bush wheel fixed on a spindle, on which is also mounted a pulley wheel 3, the driving cord passing round this pulley wheel to a lower pulley wheel 4, the driving of which will be followed from the detail. The pulley wheel 4 is on the outer end of the shaft 5, on which is fitted a gear wheel 6 driven by a pinion $\frac{3}{4}$ " 7 on the axle 8, this axle also carrying a pinion $\frac{1}{2}$ " 9 engaged by a worm 10 on the driving shaft 11, which carries the driving pulley 12. This driving gear is enclosed in two small side flanged plates 16 bolted to a base plate 13, the vertical stroke of the mill being made from corner angle girders 14 bolted at 15 to the side plates 16.

MODEL No. 114.

Vertical Saw

(MADE WITH MECCANO OUTFIT NO. 4 OR NO. 3 AND NO. 3A.)

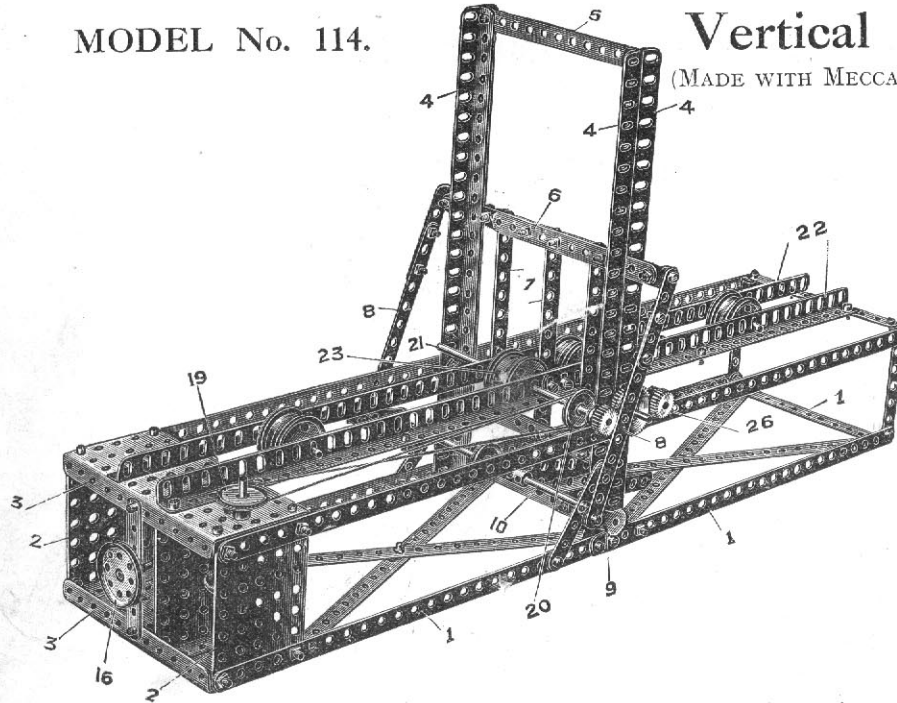

PARTS REQUIRED.

I2 of No.	1	2 of No.	25
I2 "	2	2 "	26
4 "	3	I "	27
2 "	4	I "	28
5 "	5	I "	32
8 "	8	2 "	35
20 "	12	99 "	37
I "	14	I "	45
5 "	15	2 "	52
I "	16	I "	53
3 "	17	3 "	54
8 "	20	I "	59
I "	21	2 "	62
3 "	22	I "	63

This model represents a log-sawing machine in which a number of saws are moved vertically up and down while the log is fed forward to the saws and cut into planks. The base-framework of the model is formed of strips 1 connected to small flanged plates 2, forming the sides, and large flanged plates 3, forming the top and bottom of the gear box. Angle girders 4 are bolted to the strips 1 to form vertical guides for the saw frame, a strip 5 being bolted between the flanges and the angle girders to give clearance for the frame strips 6 carrying saws 7 which slide between the angle girders 4. The frame 6 is moved vertically up and down by the connecting rods 8 lock-nutted to the ends of the upper strips 6, and cranks 9 secured on the end of an axle rod 10. This rod 10 is driven by a cord 11 passing over a pulley wheel 12 on a rod 13, which is driven by a pinion 14 engaging with a worm on the driving shaft 15, this driving shaft being fitted with a driving pulley 16. To provide for the travel of the logs, the other end of the rod 13 is fitted with a pinion 17 engaging a contrate wheel 18 on a vertical spindle, the upper end of which is fitted with a pulley wheel 19, the driving cord passing round this pulley 19 to a similar pulley 20 on an axle 21 journalled in the vertical webs of the angle girder rails 22. This rod 21 carries the flanged wheels 23, and is geared by a pinion 24 engaging a gear wheel 25 to another pinion 26 carrying another pair of flanged wheels. The log is carried along on these flanged wheels through the saws 7.

MODEL No. 114. Vertical Saw (continued)

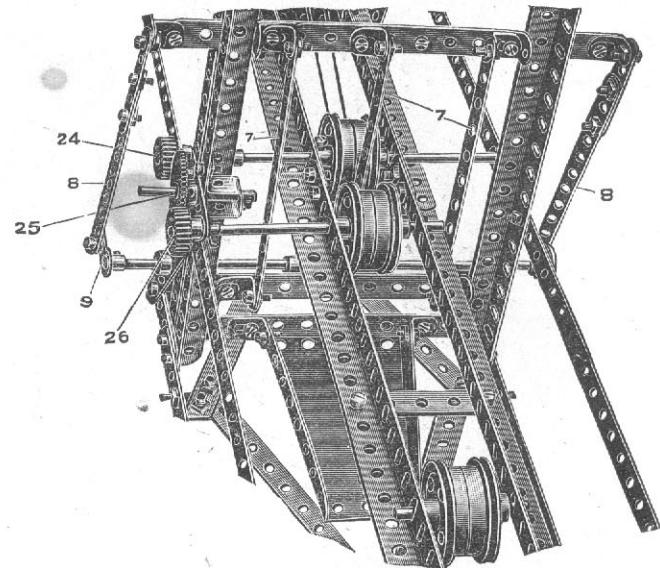
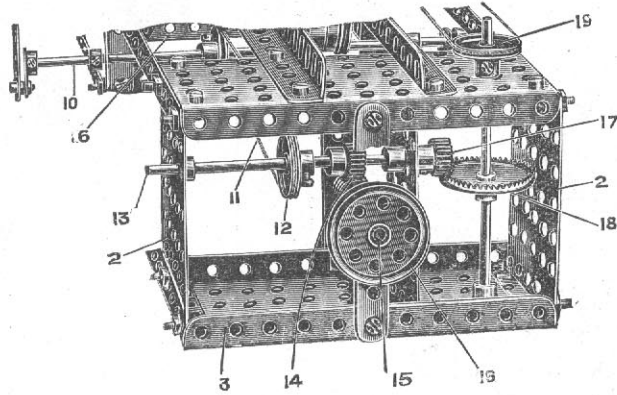

FIG. 114A.

HOW TO CONTINUE

This completes the models which may be made with MECCANO Outfit No. 4. The next models are a little more advanced, requiring a number of extra parts to construct them. The necessary parts are all contained in a No. 4a Accessory Outfit, the cost of which will be found in the Price List at the end of the Manual.

MODEL No. 115. Planing Machine

(MADE WITH MECCANO OUTFIT NO. 5 OR NO. 4 AND NO. 4A.)

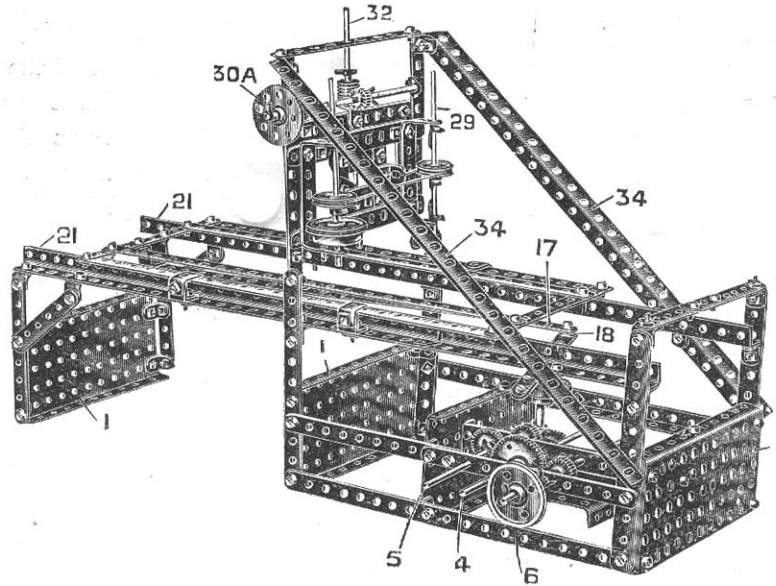

PARTS REQUIRED.

	3 of No.	1
25	"	2
1	"	3
4	"	4
6	"	5
3	"	6
8	"	8
4	"	11
36	"	12
1	"	14
5	"	15
2	"	16
1	"	17
1	"	20
2	"	21
2	"	22
1	"	23
1	"	24
2	"	25
2	"	26
2	"	27
1	"	28
1	"	32
1	"	35
4	"	37
127	"	45
1	"	46
2	"	52
4	"	53
1	"	59
5	"	62
1	"	

Begin by constructing the gear box, Fig. 115A, consisting of three large flanged plates 1 joined by pairs of $5\frac{1}{2}$ " strips 2 overlapped three holes. The strips 2 form bearings for the spindles 3, 4, and 5. The spindle 3, on which is the driving pulley 6, carries a pinion 7 meshing with the gear wheel 8 secured with the pinion 9 on the spindle 4. This pinion 9 meshes with the gear wheel 10 on the spindle 5, which also carries a pinion 11 engaging the contrate wheel 12 on the vertical spindle 13. A crank piece 14 is secured to the spindle 13, and is pivotally connected to the link 16, Fig. 115B, the other extremity of which is pivotally connected to the connecting rod 17 by a lock-nutted attachment 18. The rod 17 is coupled to the table 19 by the double bent strip 20. The table 19 runs upon the angle girders 21. The double

MODEL No. 115. Planing Machine *(continued)*

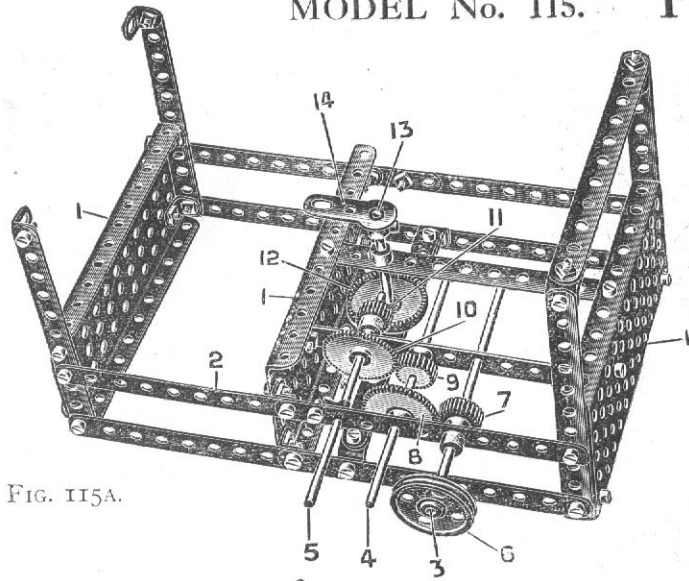

FIG. 115A.

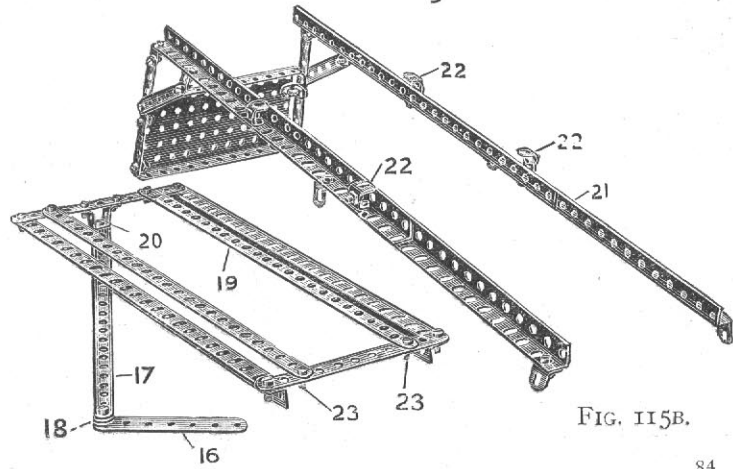

FIG. 115B.

brackets 22 forming guides for the table are first bolted in position, and the end nuts and bolts 23 of the table removed to enable the table to pass under the angle brackets initially.

Fig. 115C illustrates the mechanism for controlling the traversing and vertical movement of the tool 24. The tool is carried in the plate 25 to which are secured angle brackets 26 from which the operating cord 27 controlled by the flanged wheel 28A passes round the pulleys 28 on the spindles 29. The vertical movement of the plate is regulated through the bush wheel 30A by means of the pinion 30 engaging the worm 31 here acting as a rack, and secured to the vertically moving spindle 32 guided in the strip 33. The tool head is stayed to the rear plate 1 by the diagonal girders 34.

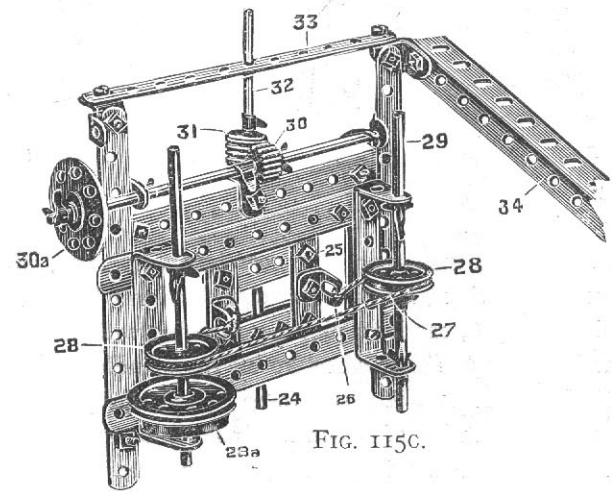

FIG. 115C.

MODEL No. 116. Lighthouse

(MADE WITH MECCANO OUTFIT NO. 5 OR NO. 4 AND NO. 4A.)

PARTS REQUIRED.

14	of	No.	1	1	of	No.	24
26	"	"	2	2	"	"	25
12	"	"	3	1	"	"	26
6	"	"	4	2	"	"	27
9	"	"	5	1	"	"	32
12	"	"	8	160	"	"	37
53	"	"	12	1	"	"	46
1	"	"	13	3	"	"	52
2	"	"	15	2	"	"	53
2	"	"	16	1	"	"	54
1	"	"	17	4	"	"	59
2	"	"	21	7	"	"	60

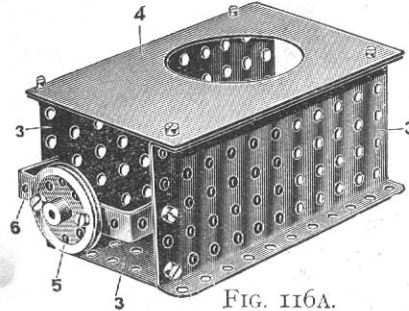
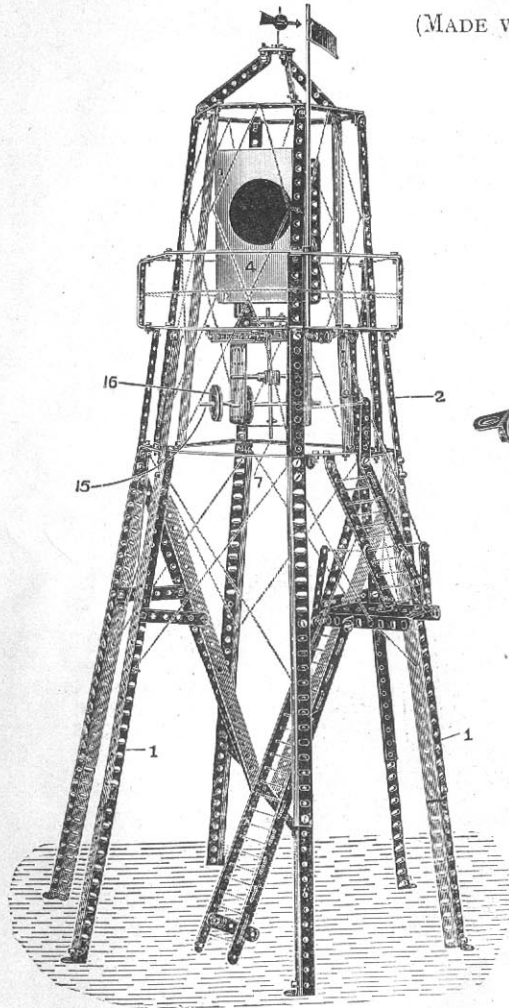

FIG. 116A.

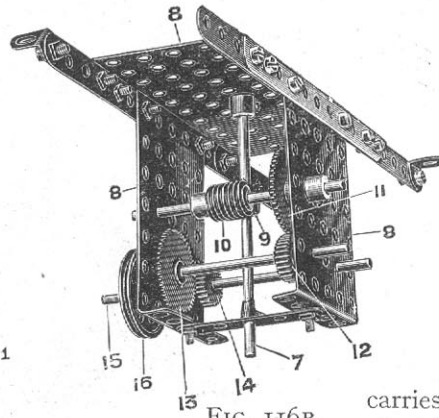

FIG. 116B.

The vertical standards 1 consist of angle girders extended by perforated strips 2 to carry the superstructure. The construction of this superstructure and the means for revolving the light are brought out in the detail views, Figs. 116A, 116B. The lantern (Fig. 116A) is built up from flanged plates 3 to form three sides, the remaining side being enclosed by a piece of cardboard 4 in which is cut an aperture. A pulley wheel 5 is bolted to a bent strip 6 carried from the plates 3, as shown in the figures. This pulley wheel 5 is secured to the top of the spindle 7 (Fig. 116B) mounted in a framework made of flanged plates 8. The spindle 7

carries a pinion 9 driven by a worm 10, on the spindle of which is a gear wheel 11 driven by a pinion 12. On

the same spindle is another gear wheel 13, which in turn is driven by a pinion 14 on a spindle 15 carrying a pulley 16. Any suitable means may be devised for driving the pulley 16 by an operating cord, and owing to the gear train 14, 13, 12, 11, 10, and 8, the lantern is caused to revolve slowly and a moving beam of light thrown from the lantern head. This is almost an exact copy of the Maplin Lighthouse, which stands on Margate Sands.

MODEL No. 117. Telpher Line

(MADE WITH MECCANO OUTFIT NO. 5 OR NO. 4 AND NO. 4A.)

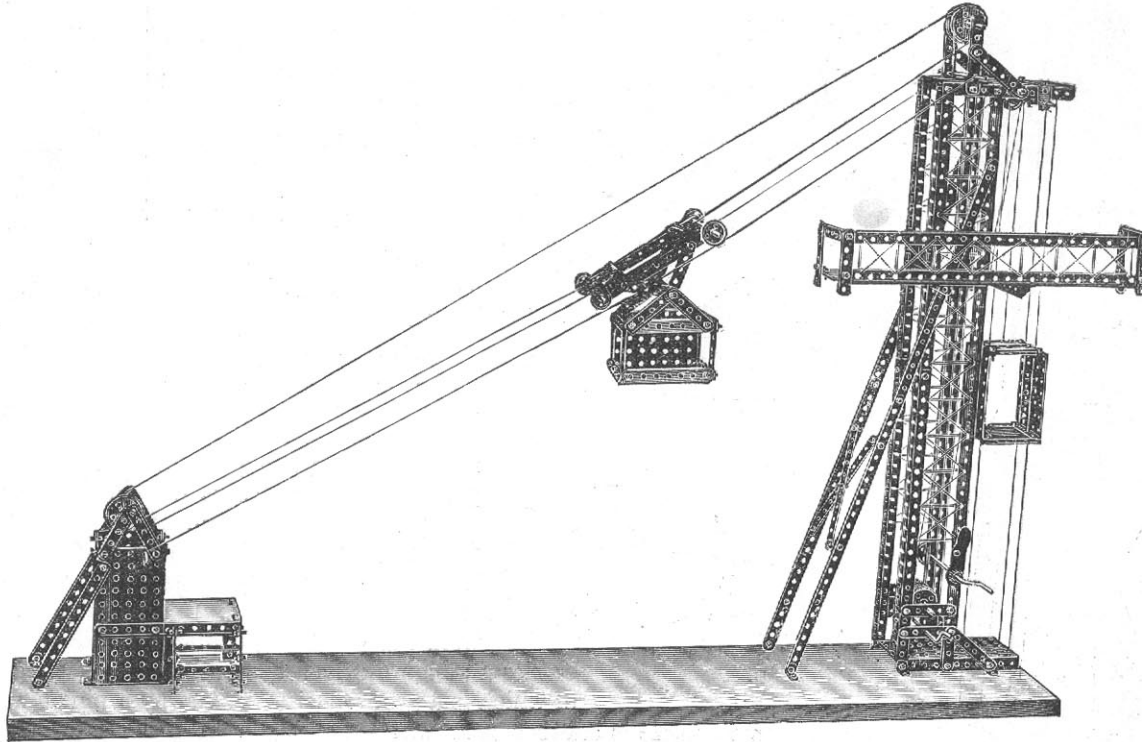

PARTS REQUIRED.

6	of	No.	1
10	"	"	2
2	"	"	3
8	"	"	4
41	"	"	5
9	"	"	8
32	"	"	12
7	"	"	15
2	"	"	16
2	"	"	19
4	"	"	20
2	"	"	21
4	"	"	22
2	"	"	22A
1	"	"	25
1	"	"	26
1	"	"	27
1	"	"	33
9	"	"	35
141	"	"	37
1	"	"	46
4	"	"	52
3	"	"	53
7	"	"	60

This figure represents a Telpher Line such as is used in hilly countries for transporting loads across intervening valleys. The travelling cage or bucket should be loosely pivoted from the roller cage, so that it may hang vertically when travelling down the inclined ropes. The drawing ropes should be wound once round the suspension pulleys of the bucket.

MODEL No. 118. Travelling Gantry

(MADE WITH MECCANO OUTFIT NO. 5 OR NO. 4 AND NO. 4A.)

PARTS REQUIRED.

12 of No.	1	2 of No.	22A
16 " "	2	6 " "	23
1 " "	3	1 " "	24
2 " "	4	2 " "	25
3 " "	5	2 " "	26
8 " "	8	1 " "	27
1 " "	11	1 " "	32
26 " "	12	1 " "	33
2 " "	14	9 " "	35
3 " "	15	109 " "	37
4 " "	17	2 " "	46
3 " "	19	3 " "	53
6 " "	20	1 " "	57
4 " "	22	4 " "	59

A most interesting model to the student of mechanics. If carefully constructed, the mechanism will be found to work with the utmost precision and smoothness, and much instruction can be gained by a study of its parts.

The construction is quite straightforward, and hardly needs any description. Care should be taken as to the construction of the clutch mechanism, which is clearly shown in the illustration, Fig. 118A.

As regards the cord for operating the travelling carriage, care must be taken to wind this cord twice round the pulley on the spindle of the traversing handle, to give a good grip. Fig. 118B shows the construction of the top part of the gantry.

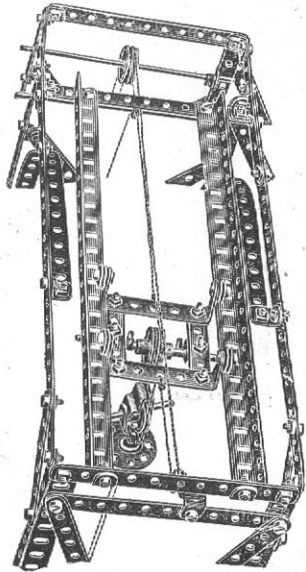
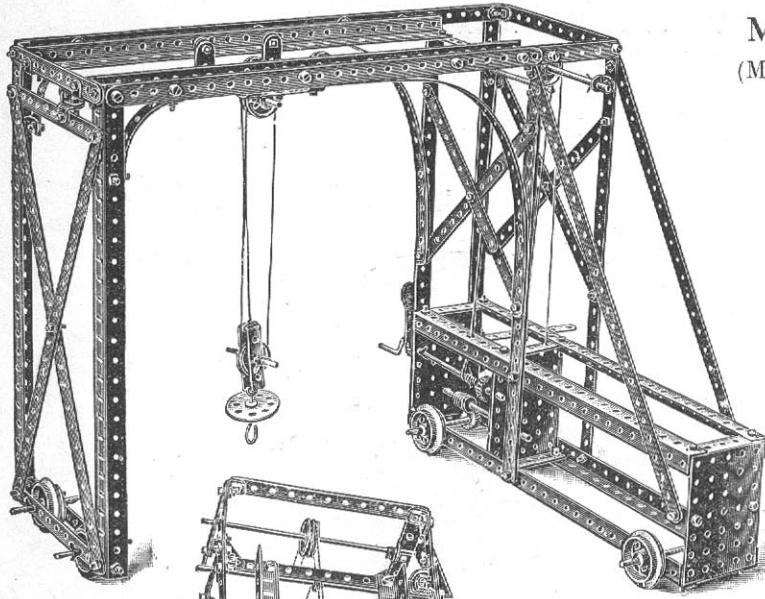

FIG. 118B.

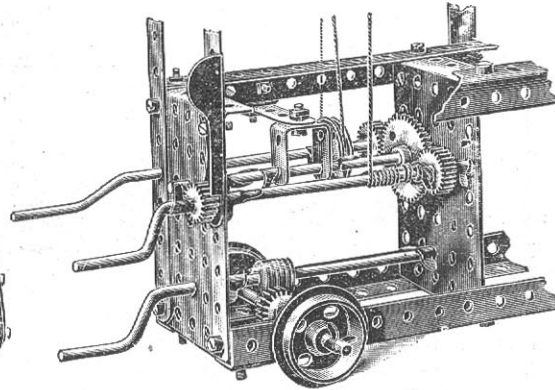

FIG. 118A.

MODEL No. 119. Revolving Aeroplane

(MADE WITH MECCANO OUTFIT NO. 5 OR NO. 4 AND NO. 4A.)

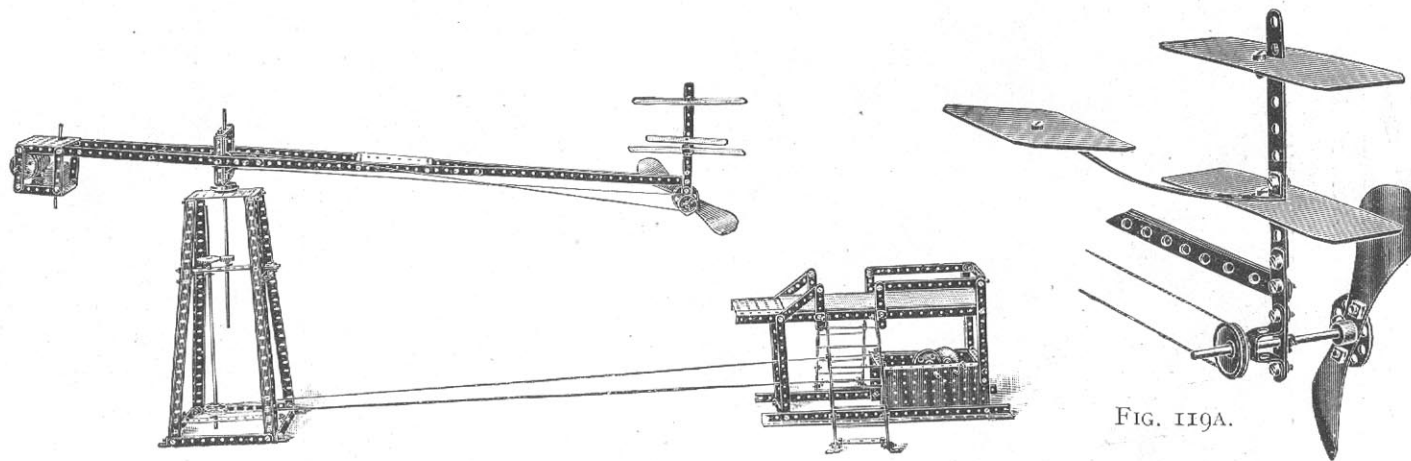

FIG. 119A.

PARTS REQUIRED

6	of	No.	1
23	"	"	2
10	"	"	3
2	"	"	4
9	"	"	5
8	"	"	8
24	"	"	12
2	"	"	13
5	"	"	15
1	"	"	16
1	"	"	17
1	"	"	19
1	"	"	20
2	"	"	21

PARTS REQUIRED.

2	of	No.	22
6	"	"	23
1	"	"	24
3	"	"	25
2	"	"	27
1	"	"	29
15	"	"	35
128	"	"	37
2	"	"	41
1	"	"	45
2	"	"	46
2	"	"	52
4	"	"	53
1	"	"	54
2	"	"	60

MODEL No. 119. Revolving Aeroplane (continued)

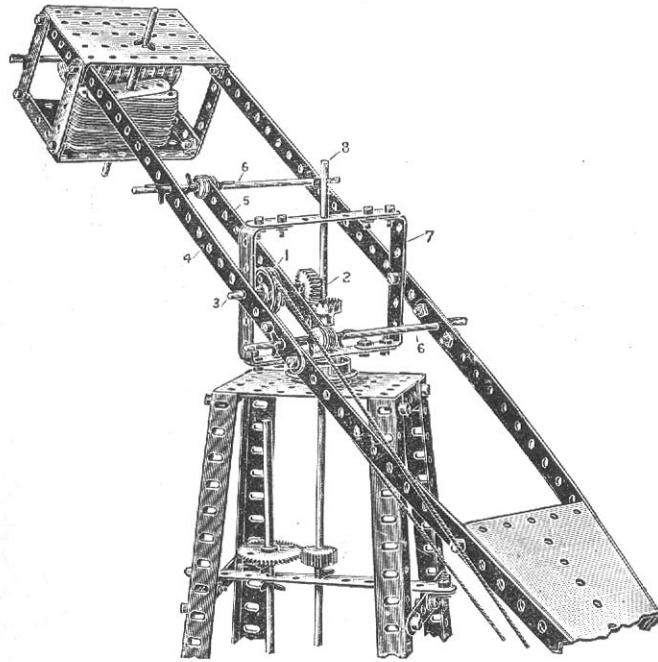

FIG. 119B.

As regards the construction of the detailed portion shown in Fig. 119B, the pulley wheel 1 and the pinion 2 are both secured on the short spindle 3 in the following manner: The pulley wheel 1 is first inserted on the spindle 3, after the latter has been passed through the outer strip 4. It is then secured on the spindle, and the $5\frac{1}{2}$ " strip 5, which is loose on both the spindles 6, is then slid on the spindles 6 and the spindle 3 close against the pulley wheel 1. The pinion 2 is then inserted on the spindle 3, and secured in place. During this operation it is necessary to have the swinging arm and the square frame 7 drawn off the main vertical spindle 8, so as to give room for the securing of the pulley 1 and pinion 2, after which the frame 7 may be dropped into place over the spindle 8.

The balance weight is made up of a series of short strips or wheels threaded over the spindles in the shorter arm, and by this means the weight can be adjusted to any nicety.

The driving gear is operated from the crank handle (shown on the right in the sketch), and drives the vertical spindle 8 in the pedestal on the left, upon which a $\frac{3}{4}$ " contrate wheel is secured, engaging the $\frac{3}{4}$ " pinion 2. At the upper end of this spindle is mounted the balanced swinging arm carrying the propeller and aeroplane on its longer limb, and a balance weight on the short one. The operation of the crank will cause the propeller to revolve, and the aeroplane to travel.

MODEL No. 120. Railroad Signals

(MADE WITH MECCANO OUTFIT NO. 5 OR NO. 4 AND NO. 4A.)

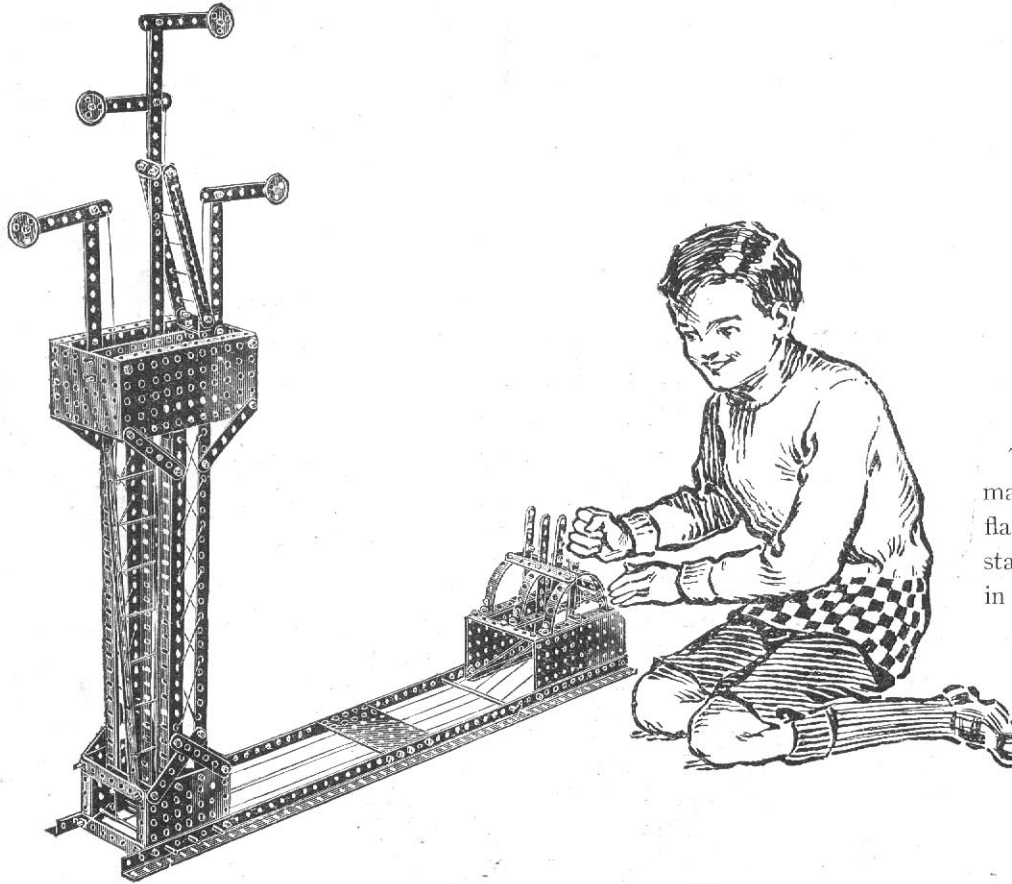

PARTS REQUIRED.

3	of No.	1
13	" "	2
16	" "	3
8	" "	4
8	" "	8
1	" "	11
31	" "	12
4	" "	15
4	" "	22
8	" "	35
137	" "	37
4	" "	52
5	" "	53

The gantry or upper signal box is made from two large and two small flanged plates carrying the signal standards. Guide pulleys are pivoted in the base box round which pass the operating cords for the signal arms to the hand levers, shown to the right.

MODEL No. 121. Extended Tip

(MADE WITH MECCANO OUTFIT NO. 5 OR NO. 4 AND NO. 4A.)

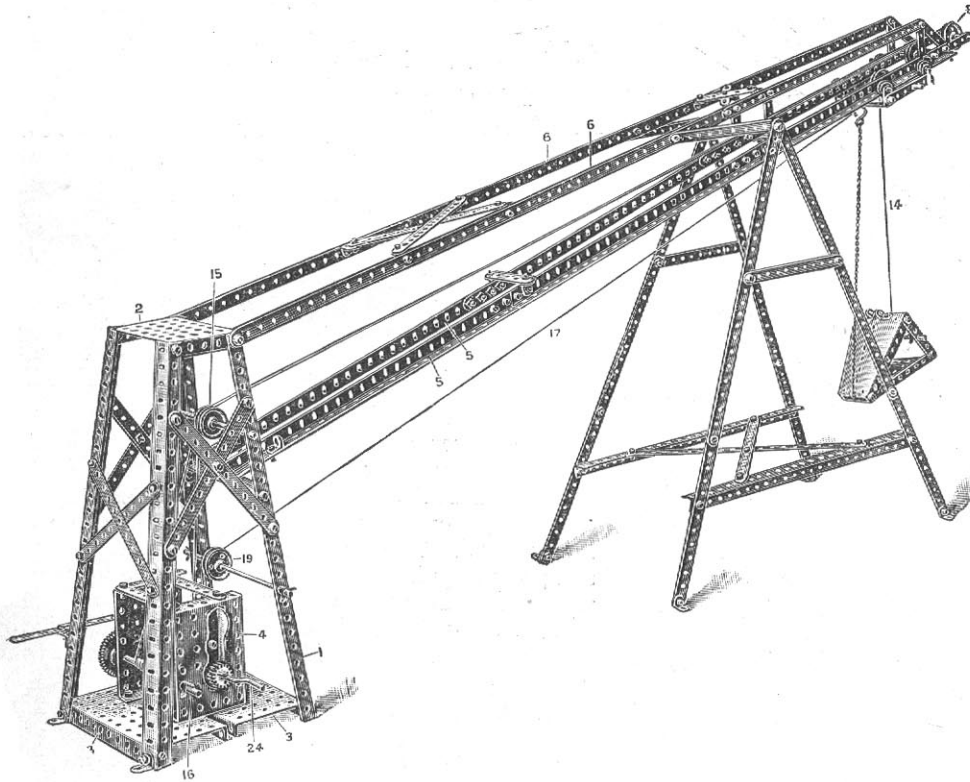

PARTS REQUIRED.

14	of	No.	1
17	"	"	2
7	"	"	3
2	"	"	4
8	"	"	5
6	"	"	6
12	"	"	8
2	"	"	11
26	"	"	12
2	"	"	14
2	"	"	15
2	"	"	16
2	"	"	17
1	"	"	19
1	"	"	21
4	"	"	22
1	"	"	22A
4	"	"	23
1	"	"	25
1	"	"	26
2	"	"	27
1	"	"	33
148	"	"	37
15	"	"	35
1	"	"	42
1	"	"	44
2	"	"	46
2	"	"	52
3	"	"	53
1	"	"	50
3	"	"	59

MODEL No. 121.

Extended Tip (continued)

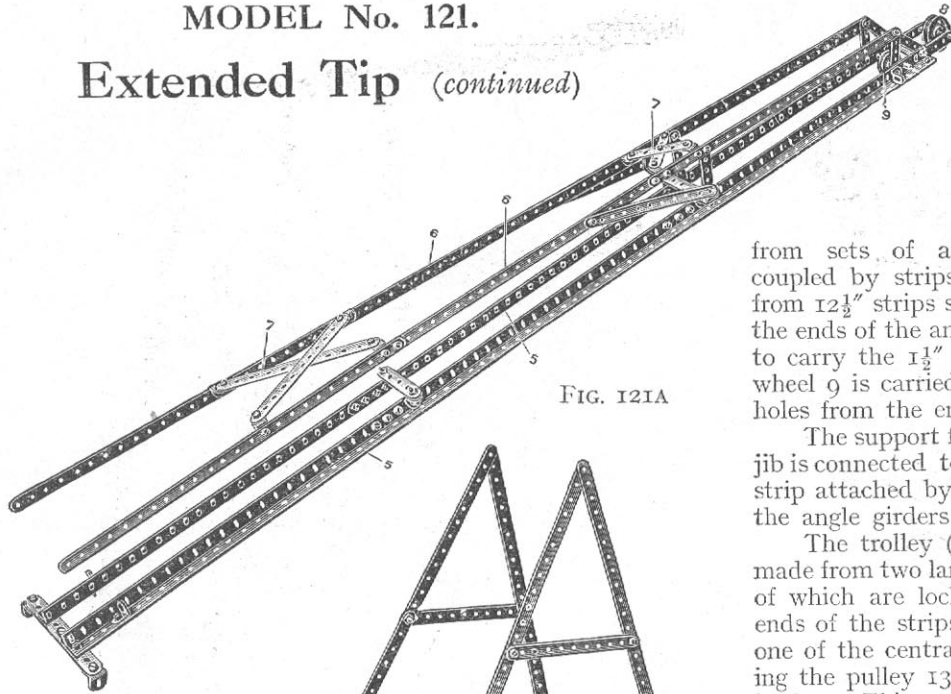

FIG. 121A

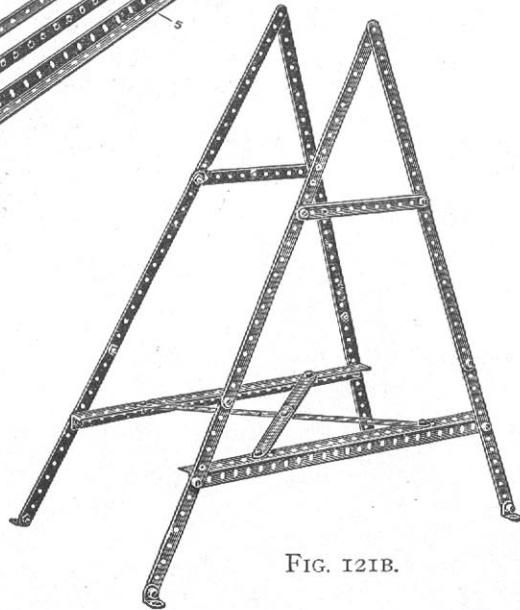

FIG. 121B.

The main tower of the tip is made from four $12\frac{1}{2}$ " angle girders 1 bolted at the top to a small flanged plate 2 and at the bottom to two large plates 3; the side plates 4 of the gear box being bolted to the flanged base plates.

The jib, Fig. 121A, is made from sets of angle girders 5 butted together and coupled by strips, a pair of members 6 being formed from $12\frac{1}{2}$ " strips strengthened by diagonal ties 7. To the ends of the angle girders 5 are bolted two $3\frac{1}{2}$ " strips to carry the $1\frac{1}{2}$ " pulley wheel 8, and the 1" pulley wheel 9 is carried on an axle passed through the third holes from the end of the angle girders.

The support for the jib is shown in Fig. 121B, and the jib is connected to this support by a $3\frac{1}{2}$ " perforated strip attached by angle brackets to the support and to the angle girders 5.

The trolley (Fig. 121C) carrying the tip bucket is made from two large bent strips 10, in the upper ends of which are lock-nutted $\frac{1}{2}$ " pulley wheels, the bent ends of the strips being connected by 3" strips 11, in one of the central holes of which is the axle 12 carrying the pulley 13 for the operating cord 14 of the tip bucket. This cord passes round the inner end pulley 9 and back to one of the pulleys 15 and then to the winding shaft 16. The cord 17 for traversing the trolley along the rails is continuous, being given a complete turn round the spindle 18 (Fig. 121D) then round the pulley 19 to the trolley, and again from the trolley round the outer pulley 8 back over one of the pulleys 15 to the winding spindle 18.

The tip bucket, as will be seen from Fig. 121C, is made from two sector plates 20 bolted together at their lower edges, and coupled by $2\frac{1}{2}$ " strips at their upper ends; the bucket is supported by a single bent strip 21 engaging the axle passed through the strips. A slack

MODEL No. 121.
 Extended Tip (continued)

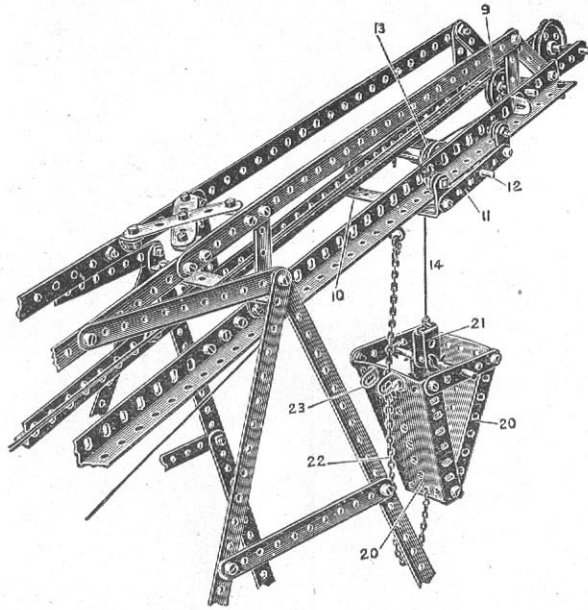

FIG. 121C.

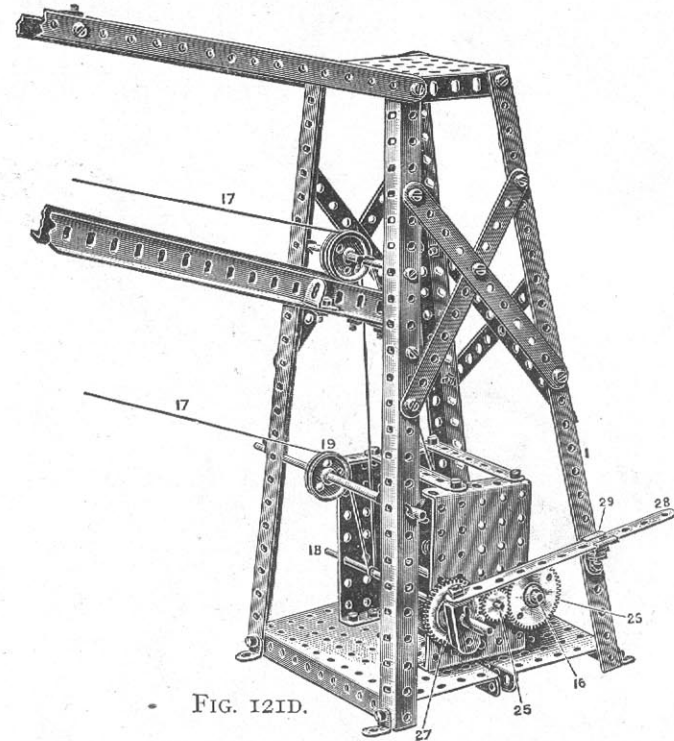

FIG. 121D.

chain 22 connects the lower end of the tip bucket to a hook on the trolley, the chain passing between angle brackets 23.

To tip the bucket, the cord 14 is lowered until the chain 22 becomes taut, further lowering of the cord 14 then allowing the bracket to swing over.

The cranked spindle 24 is provided at its opposite end with a pinion 25 which is permanently in gear with a $1\frac{1}{2}$ " gear wheel 26 on the spindle 16 controlling the hoisting cord 14. Another $1\frac{1}{2}$ " gear wheel 27 is mounted on the spindle 18 and is so controlled by the lever 28 that it may be thrown in or out of gear with the pinion 25. The lever 28 is supported in an eye piece 29 carried from the corner girder 1.

To cause the bucket trolley to traverse the rails without raising or lowering the bucket, the gear wheel 27 is engaged with the pinion 25, but to lift or lower the bucket, the gear wheel 27 is disengaged, the hoisting wheel 26 only being operated.

MODEL No. 122. Turn-table Crane

(MADE WITH MECCANO OUTFIT NO. 5 OR NO. 4 AND NO. 4A.)

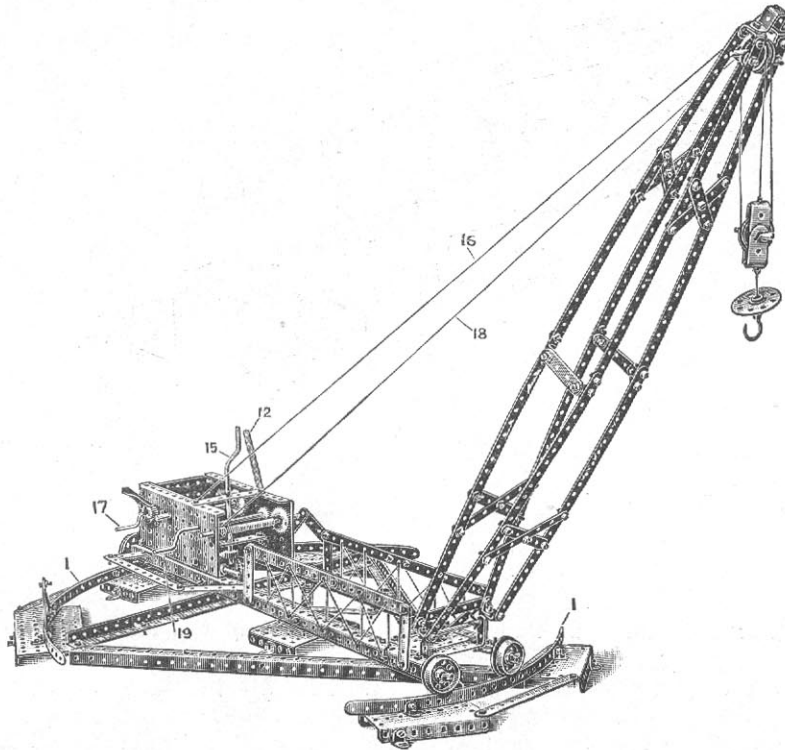

PARTS REQUIRED.

11 of No.	1	2 of No.	25
11 "	2	2 "	26
7 "	3	2 "	27
1 "	4	1 "	28
12 "	5	1 "	33
3 "	6	13 "	35
10 "	8	152 "	37
2 "	11	2 "	44
41 "	12	1 "	45
1 "	14	1 "	46
6 "	15	4 "	52
1 "	16	5 "	53
2 "	17	2 "	54
3 "	19	1 "	57
5 "	20	4 "	59
4 "	22	2 "	60
1 "	24		

MODEL No. 122. Turn-table Crane (continued)

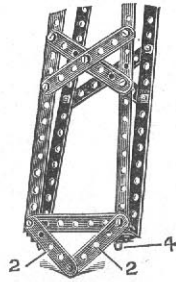

FIG. 122A.

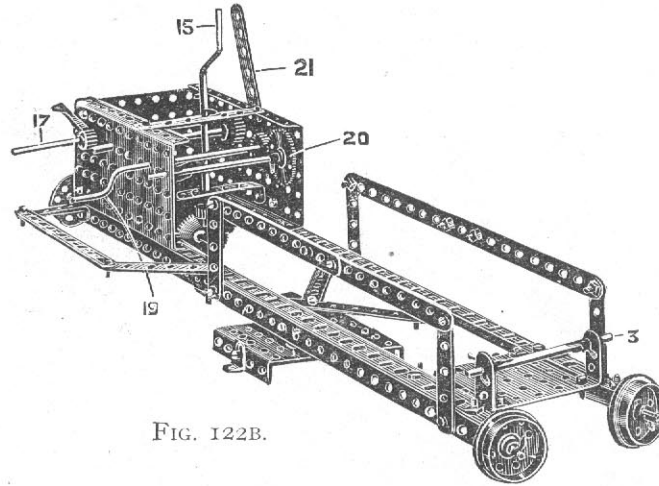

FIG. 122B.

This crane, the jib of which is carried from a turn-table, swivels on the rails 1. The jib is braced as shown clearly in the general illustration, the lower part being fitted with diagonal strips 2, Fig. 122A, which act as a stop to limit the elevational movement of the jib, which swivels on the extremities of a $3\frac{1}{2}$ " axle rod 3, Fig. 122B, engaged by angle brackets 4 on the jib.

The circular rails 1 made of curved $12\frac{1}{2}$ " strips, Fig. 122C, supported on perforated plates 4 braced by angle girders 5 overlapped as shown.

The construction of the turn-table is shown in the inverted view, Fig. 122D, the side angle girders 6 being connected by perforated plates 7 and diagonal strips 8. The central hole of these strips 8 is pivotally connected by a bolt to the yoke piece 9 made of a large bent strip, the up-turned ends of which are bolted by angle brackets to a flanged plate 10. The platform swivels about this pivotal connection. The running flanged wheels 11 are mounted on radially placed rods 12, being carried in angle brackets bolted to the plates 7.

MODEL No. 122. Turn-table Crane (continued)

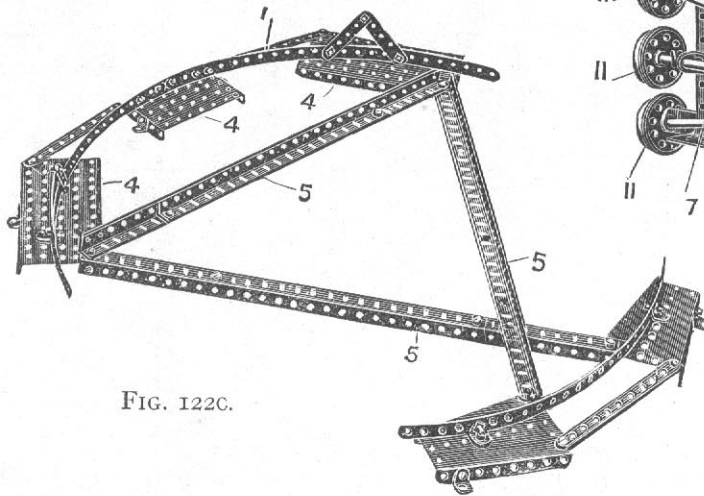

FIG. 122C.

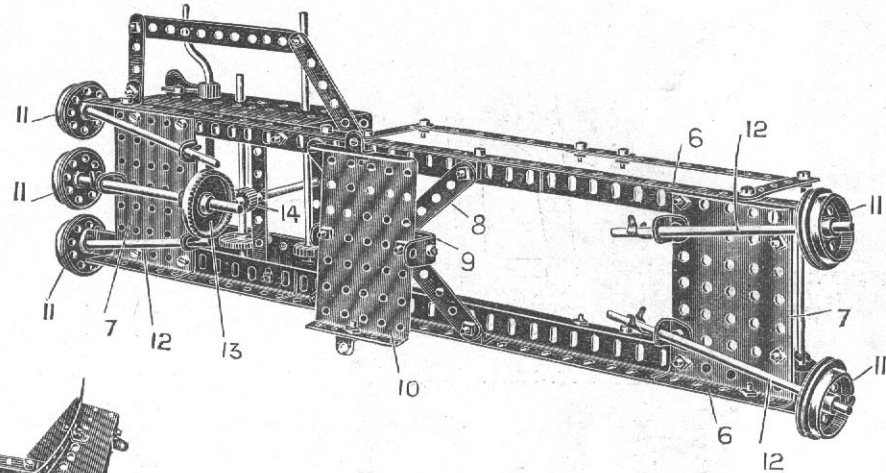
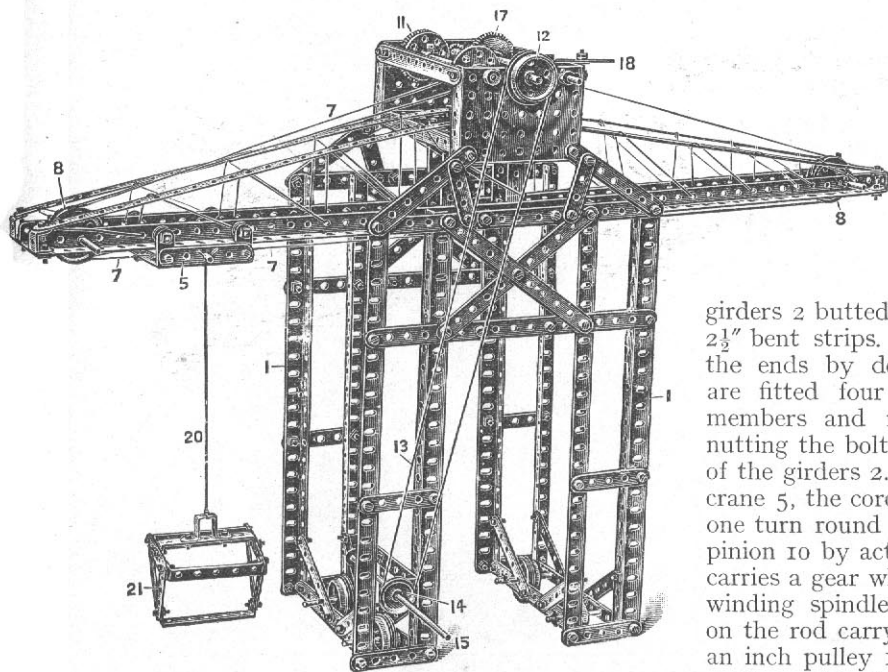

FIG. 122D.

The central flanged wheel 11 is driven by the contrate wheel 13 engaged by the pinion 14 mounted on the cranked handle 15, see Fig. 122B. The jib is elevated by the operating cord 16 controlled by the crank handle 17; and the hoisting gear by the cord 18 controlled by the cranked handle 19 meshing by a $\frac{3}{4}$ " pinion with a gear wheel 20 on the winding spindle. The brake gear, the handle 21 of which is shown in the illustration, is similar to that shown in standard detail A.

MODEL No. 123. Travelling Gantry Crane

(MADE WITH MECCANO OUTFIT NO. 5 OR NO. 4 AND NO. 4A.)



PARTS REQUIRED.

4 of No. 1	2 of No. 16	10 of No. 35
18 " " 2	4 " " 17	143 " " 37
5 " " 3	1 " " 19	1 " " 45
8 " " 4	6 " " 20	2 " " 46
20 " " 5	2 " " 21	1 " " 52
4 " " 6	1 " " 22	2 " " 53
12 " " 8	1 " " 22A	6 " " 59
4 " " 11	4 " " 23	9 " " 60
7 " " 12	2 " " 24	1 " " 63
2 " " 14	1 " " 25	
1 " " 15	2 " " 27	

The construction of the vertical frames of this model is clearly shown in the illustration, they being made from angle girders 1. The gantry girder consists of angle girders 2 butted together by $2\frac{1}{2}$ " strips and supported to the plate 25 by $2\frac{1}{2}$ " bent strips. These girders are also braced by strips 3 connected at the ends by double brackets 4. The travelling frame 5, to which are fitted four $\frac{1}{2}$ " pulley wheels 6, carried on the ends of the end members and made to run freely on the shank of the bolts by nutting the bolts on each side of the members, runs on the flanges of the girders 2. The ends of the traversing cord 7 are secured to the crane 5, the cord passing over one of the end pulley wheels 8, and given one turn round the axle 16, which is engaged and disengaged with the pinion 10 by actuating the lever 18 pivoted at 19. A third spindle 9 carries a gear wheel 11, which is driven by the pinion 10 and forms the winding spindle for raising or lowering the load. A flanged wheel 12 on the rod carrying the pinion 10 is driven by a cord 13 passing round an inch pulley 14 on the crank spindle 15. The raising or lowering cord 20 for the bucket 21 passes over a pulley 22 in the travelling frame 5 and thence round one of the pulleys 8 to the spindle 9. The head gear box is fixed in position by bolting the lower corner holes 23 at the top of the standard frames 1, and to the angle brackets 24 of the girder rail frame, these brackets being bolted to a large flanged plate 25.

MODEL No. 123. Travelling Gantry Crane *(continued)*

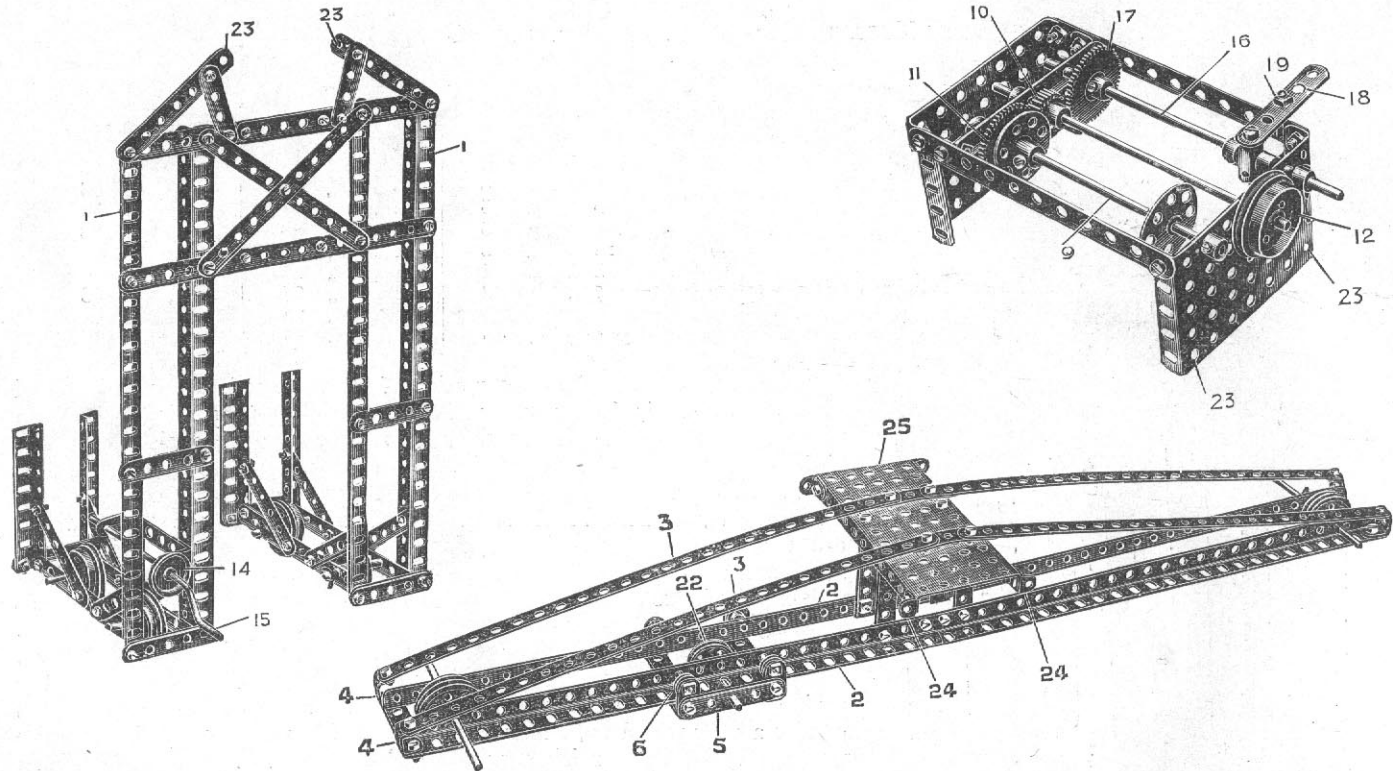

HOW TO CONTINUE

This completes the models which may be made with MECCANO Outfit No. 5. The next models are a little more advanced, requiring a number of extra parts to construct them. The necessary parts are all contained in a No. 5a Accessory Outfit, the cost of which will be found in the Price List at the end of the Manual.

MODEL No. 124. Tower Bridge

(MADE WITH MECCANO OUTFIT No. 6 OR No. 5 AND No. 5A.)

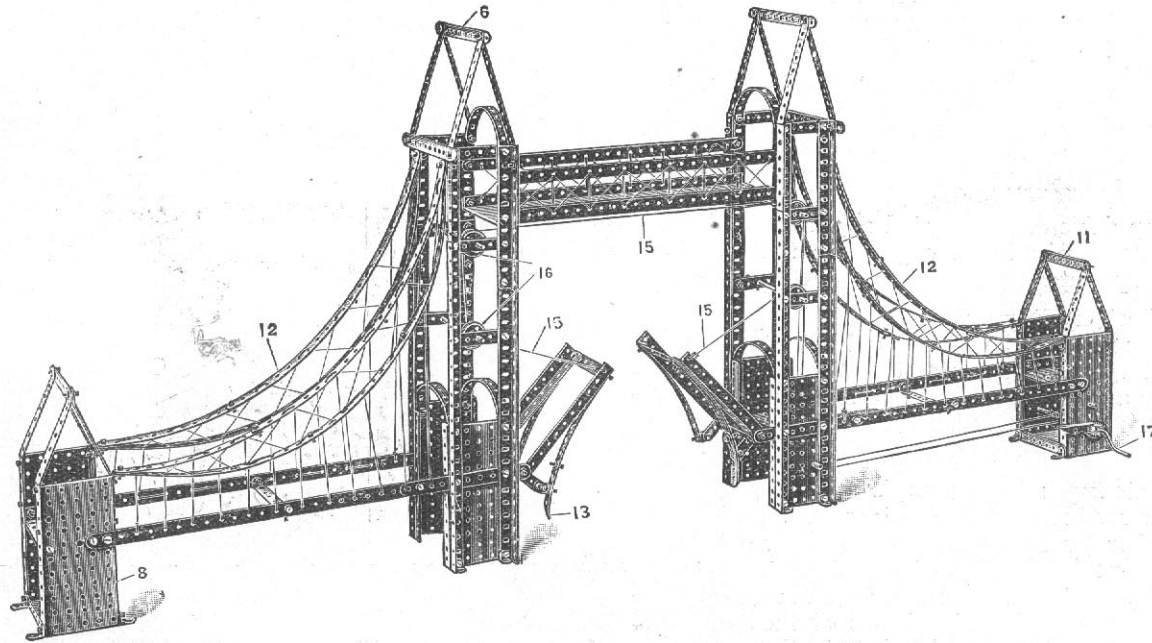

PARTS REQUIRED.

22	of	No.	1
34	"	"	2
12	"	"	3
12	"	"	5
10	"	"	8
12	"	"	9
28	"	"	12
6	"	"	15
1	"	"	19
6	"	"	22

PARTS REQUIRED.

1	of	No.	25
1	"	"	26
1	"	"	27
1	"	"	33
9	"	"	35
183	"	"	37
2	"	"	43
2	"	"	46
8	"	"	52
4	"	"	53
1	"	"	59

MODEL No. 124. Tower Bridge (continued)

Begin by making the two main towers, the construction of one of which is shown in Fig. 124A. The four uprights 1 are made of angle girders, connected at their lower extremities by large flanged plates 2 and transverse strips 3. The sides of the tower are connected together by a small flanged plate 4 across the top of which and at the top of the tower are bolted bent $5\frac{1}{2}$ " strips.

The top gable 6, constructed as shown, is then bolted at its lower edges 7 to the top of the uprights.

The short end towers, one of which is shown to the right of the figure, are built up from two large flanged plates 8 connected together by a small flanged plate 9 and two $3\frac{1}{2}$ " strips 10, the gable 11 being then bolted on top.

The catenary member 12 is built up from four curved $12\frac{1}{2}$ " strips overlapped, the lower member by 12 holes and the upper member by 15 holes, so as to produce a longer sweep in the lower member, and are bolted to the vertical angle girders of the higher towers, and by angle brackets to the shorter towers.

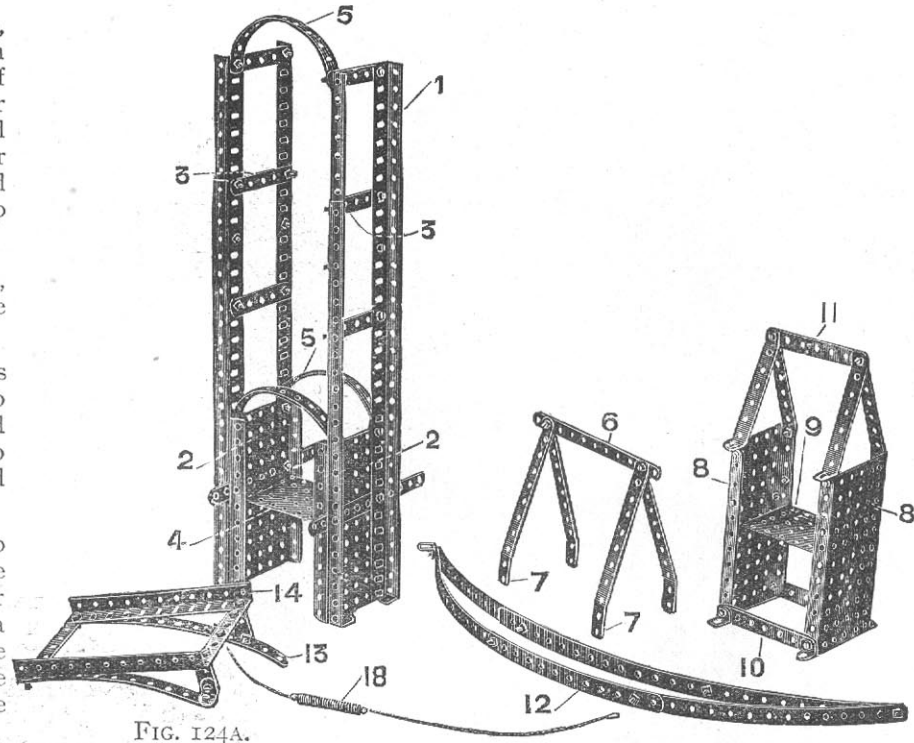

FIG. 124A.

The bascules as illustrated in the left-hand corner of the picture are built up of two $5\frac{1}{2}$ " angle girders braced with transverse $3\frac{1}{2}$ " strips, and reinforced with bent $5\frac{1}{2}$ " strips, one of which is provided with a projecting $2\frac{1}{2}$ " strip 13, which bears against the main tower and acts as a stop when the bascules are horizontal. The bascules are hinged by fixing bolts in the end holes 14. The bascules are opened by the cords 15 passing over the guide pulleys 16, and are controlled by the extension spring 18, which normally acts to return them to their closed position. In the right smaller tower is the operating handle 17, on which is secured a $\frac{3}{4}$ " pinion meshed with a gear wheel on the spindle, on which the operating cords 15 are wound.

MODEL No. 125. Rotating Crane

(MADE WITH MECCANO OUTFIT NO. 6 OR NO. 5 AND NO. 5A.)

PARTS REQUIRED.

4	of	No.	1
37	"	"	2
18	"	"	3
11	"	"	4
18	"	"	5
1	"	"	6
16	"	"	8
2	"	"	9
2	"	"	11
43	"	"	12
1	"	"	14
3	"	"	15
5	"	"	17
3	"	"	19
8	"	"	20
2	"	"	21
6	"	"	22
1	"	"	24
1	"	"	25
2	"	"	26
1	"	"	27
1	"	"	32
1	"	"	33
6	"	"	35
172	"	"	37
1	"	"	42
2	"	"	44
1	"	"	46
5	"	"	53
1	"	"	57
4	"	"	59
3	"	"	60

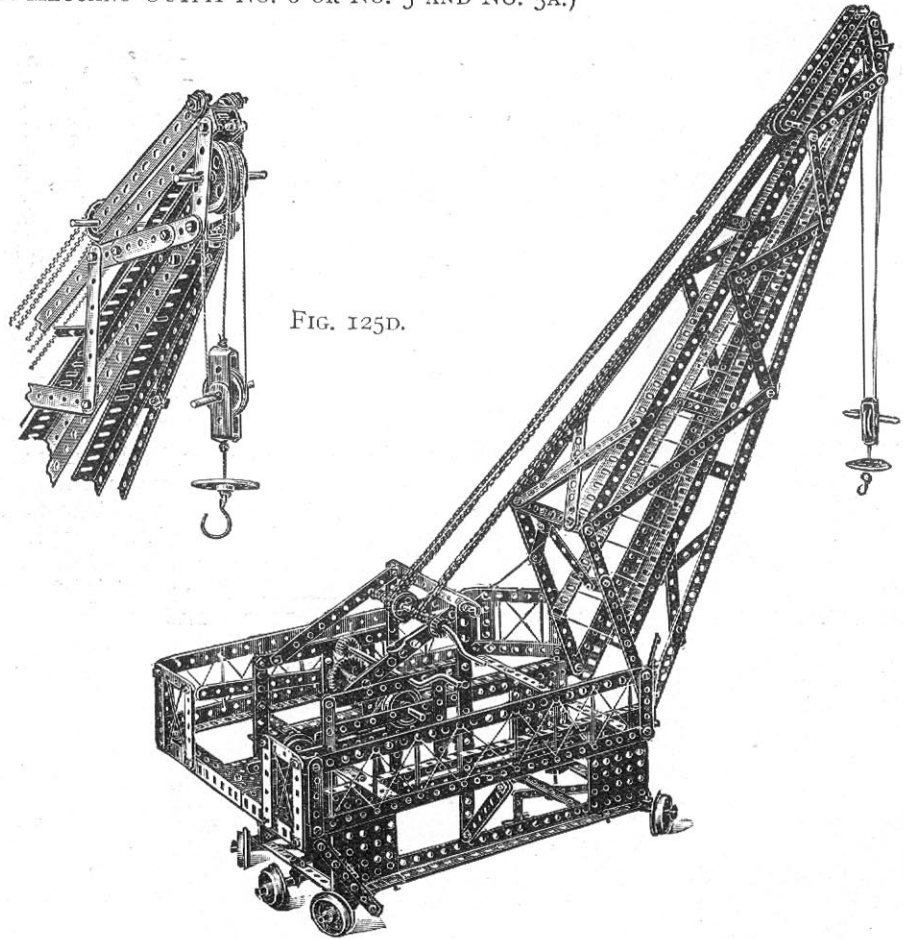

FIG. 125D.

MODEL No. 125. Rotating Crane (continued)

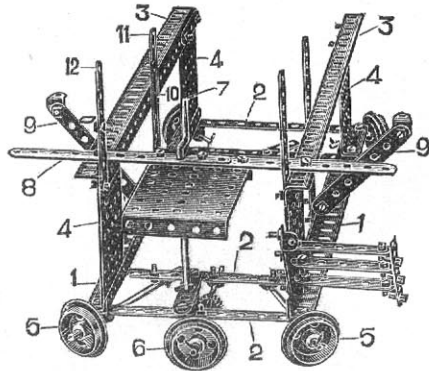

FIG. 125A.

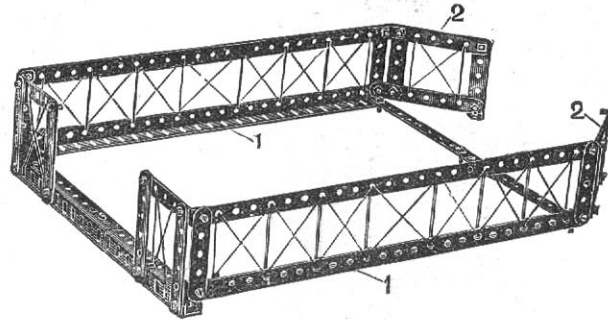

FIG. 125B.

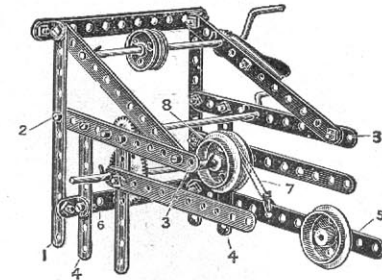

FIG. 125C.

In constructing this model, begin by building up the lower wheel carriage Fig. 125A. As will be seen, this consists of two main angle girders 1 connected by four $5\frac{1}{2}$ " cross strips 2, the superstructure made from the upper angle girders 3 and vertical small flanged plates 4 being then bolted to the lower girders 1. The extreme bolts in these lower girders carry two reversed angle brackets, which form the bearing for the spindles of the flanged wheels 5, the flanged pulley 6 running in bearings formed by angle brackets on the end cross strips being driven from the operating handle 7, carrying a worm engaging the pinion on the spindle of the driven wheel 6. Two $5\frac{1}{2}$ " strips 8 overlapped three holes form with the inclined $3\frac{1}{2}$ " strips 9 supports for the outer gallery frame, Fig. 125B. The outer ends of the inclined strips 9 and the cross strips 8 are bolted to the gallery frame.

The gallery frame, Fig. 125B, is built up of two $12\frac{1}{2}$ " angle girders 1 braced at one end with two $5\frac{1}{2}$ " angle girders overlapped three holes, and at the other end with two $5\frac{1}{2}$ " strips similarly overlapped. The end wings 2 are bolted in the extreme holes to the angle girders 3 in Fig. 125A.

The gear frame mechanism, Fig. 125C, may now be proceeded with, the framework of which is clearly shown in the illustration. The holes 1 and 2 are bolted to the corresponding holes 10 and 11 in the upright strips, Fig. 125A, the holes 3 being bolted to the top holes of the strips 12 in Fig. 125A. The lower holes 4 are bolted to the angle girders 3 in Fig. 125A.

The brake mechanism is effected by means of the weighted lever 5 pivoted in an angle bracket carried from the cross piece 6, the lever being provided with the brake cord 7 which passes over a pair of flanged pulleys 8 secured together on the winding spindle. The jib end pulley is shown in Fig. 125D, the operating cord being fastened to the suspended pulley frame passed round one of the jib pulleys, over the suspended pulley, and then over the other jib pulley to the hoisting spindle.

MODEL No. 126. Flip Flap

(MADE WITH MECCANO OUTFIT NO. 6 OR NO. 5 AND NO. 5A.)

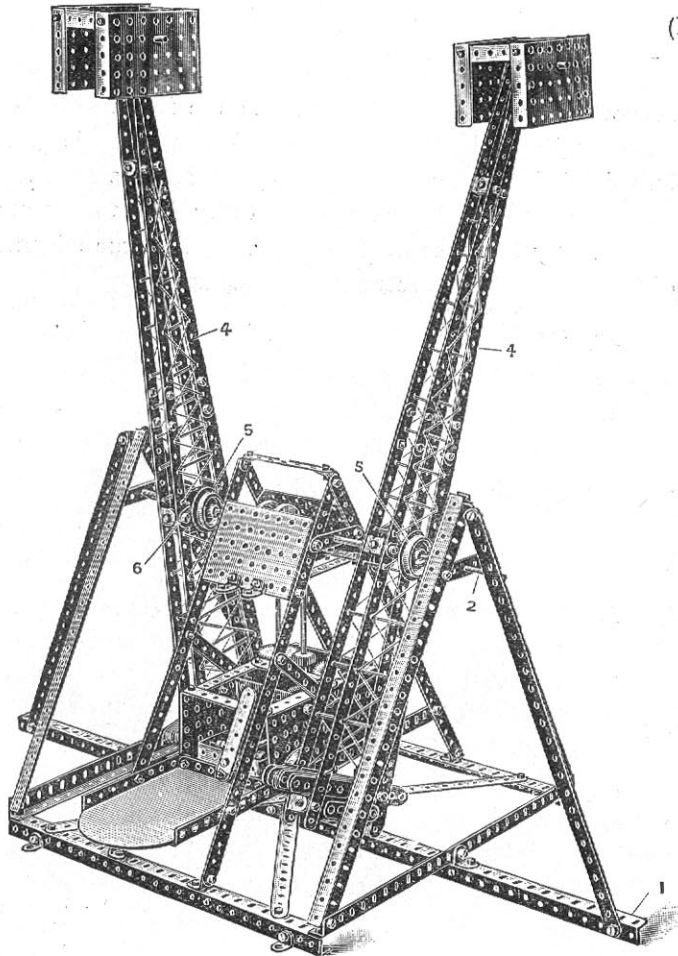

PARTS REQUIRED.

24	of	No.	1
4	"	"	2
10	"	"	3
12	"	"	5
10	"	"	8
1	"	"	9
12	"	"	11
20	"	"	12
1	"	"	13
2	"	"	14
4	"	"	15
2	"	"	16
4	"	"	20
1	"	"	21
3	"	"	25
2	"	"	26
2	"	"	27
2	"	"	28
2	"	"	29
1	"	"	32
149	"	"	37
12	"	"	35
1	"	"	46
2	"	"	52
8	"	"	53
4	"	"	59

MODEL No. 126. Flip Flap (continued)

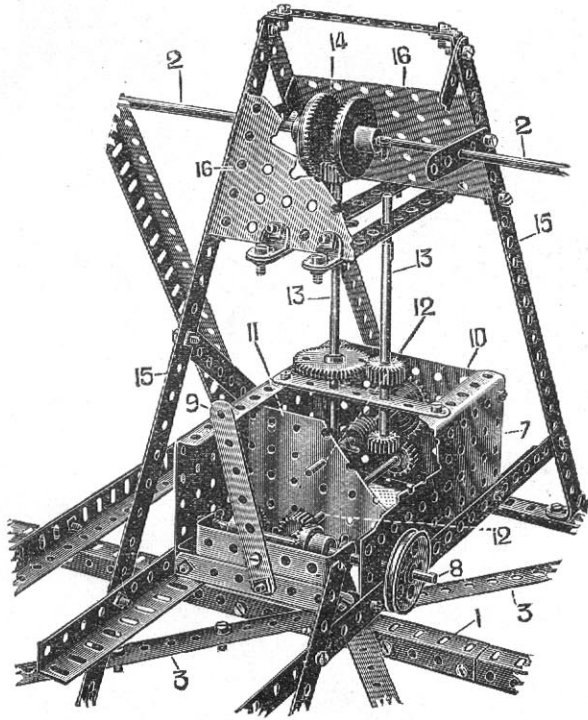

FIG. 126A.

The construction of the arms and the main body of the supporting frame is clearly shown in the illustration. The main longitudinal rib 1 is made up from two angle girders butt jointed, not overlapped, the joint being strengthened with a 3" strip bolted through in every hole to the angle girders. By this means of butt-jointing the true alignment of the main axle 2 is secured.

The cross diagonal strips 3 of the base are formed by joining together $12\frac{1}{2}$ " and $5\frac{1}{2}$ " strips and overlapping them together for five holes.

The axle 2 is gripped to the arms 4 by means of the wheels 5 on either side of the arms, which are in turn secured to the arms by means of a pair of nuts and bolts in the wheels, the nuts binding against the short $2\frac{1}{2}$ " cross strip 6 on the arms.

Having constructed the main body of the supporting frame as above described, the operating gear cage, Fig. 126A, is now proceeded with. This is built up of large flanged plates 7 forming a bearing for the driving spindle 8 operated by the clutch handle 9 and connected together by a small flanged plate 10 and a similar mid plate 11. These two latter plates form bearings for the longitudinal spindle 12. The vertical spindles 13 drive the $1\frac{1}{2}$ " contrate wheels 14 on the main axles 2, the inclined $12\frac{1}{2}$ " strips 15 being connected near the contrate wheels by the small flanged plates 16.

MODEL No. 127. Transporter Bridge

(MADE WITH MECCANO OUTFIT NO. 6 OR NO. 5 AND NO. 5A.)

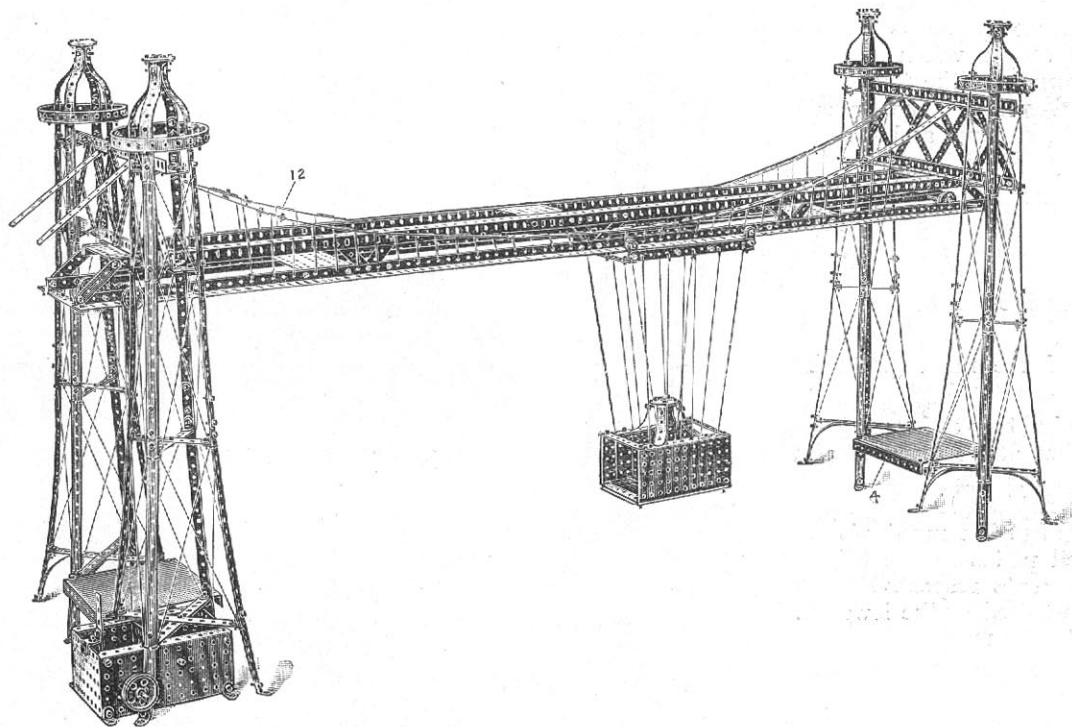

PARTS REQUIRED.

46 of	No.	1
44	" "	2
29	" "	3
8	" "	4
20	" "	5
20	" "	8
10	" "	9
118	" "	12
1	" "	14
5	" "	15
1	" "	21
4	" "	22
4	" "	23
5	" "	24
2	" "	25
1	" "	26
1	" "	27
2	" "	29
1	" "	32
44	" "	37
8	" "	35
1	" "	46
4	" "	52
8	" "	53
4	" "	59
16	" "	60

MODEL No. 127. Transporter Bridge *(continued)*

In the construction of this model begin by taking two $5\frac{1}{2}$ " strips to form the base portion of each tower. Four curved $5\frac{1}{2}$ " strips are now bolted to the centre of the cross, and bent down to form an attachment for the vertical members 1. At the top of the first $12\frac{1}{2}$ " strips forming the vertical brace, cross strips $3\frac{1}{2}$ " long are now connected by angle brackets. Further $12\frac{1}{2}$ " strips are overlapped on the lower strips, which carry the construction to the crown 2 of the tower, which is made of $3\frac{1}{2}$ " curved strips. The gallery is formed of a $12\frac{1}{2}$ " strip, bent round and secured by angle brackets to the uprights.

The towers are connected at their base by $5\frac{1}{2}$ " angle girders 4 bolted to the angle brackets 3 and at their upper parts by the braced girders 5. The $12\frac{1}{2}$ " angle girders 6 are bolted to the cross strips 7 on the towers in the third hole from the end.

The construction of the main girder is as follows:—

The side frames are built up of four $12\frac{1}{2}$ " angle girders 8 butted together and reinforced at the joints by $5\frac{1}{2}$ " angle girders. The upper elements are constructed of four $12\frac{1}{2}$ " angle girders 9 each overlapped two holes. Small flanged plates 10 and upper small flanged plates 11 are bolted to the lower and upper elements respectively. The end upper plates 11 are bolted to the lower angle girders of the braced elements 5.

Fig. 127D shows the construction of the cage, which is built up of side flanged plates 1 connected across by four $3\frac{1}{2}$ " strips 2. The carrier frame, Fig. 127E, is made of two $5\frac{1}{2}$ " strips overlapped eight holes and bent up to form the brackets on which the trolley wheels are bolted. The $\frac{1}{2}$ " pulleys 3 carried in the bent-up ends of the end members 4 are made to run freely on the shank of the bolts by providing lock nuts on the inside and outside of the turned-up ends of the strips 4.

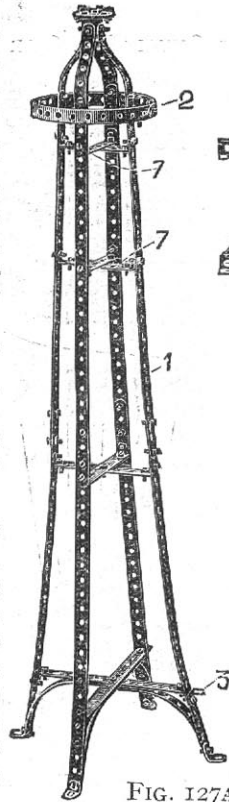

FIG. 127A.

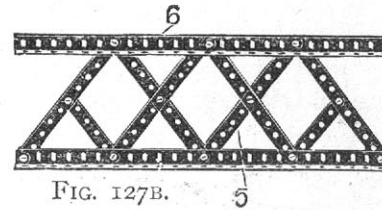

FIG. 127B.

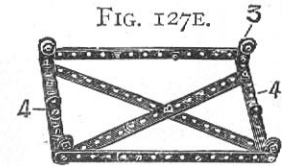

FIG. 127E.

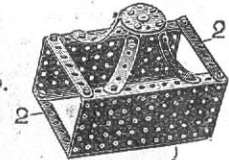

FIG. 127D.

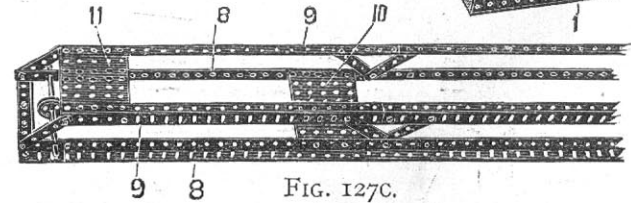
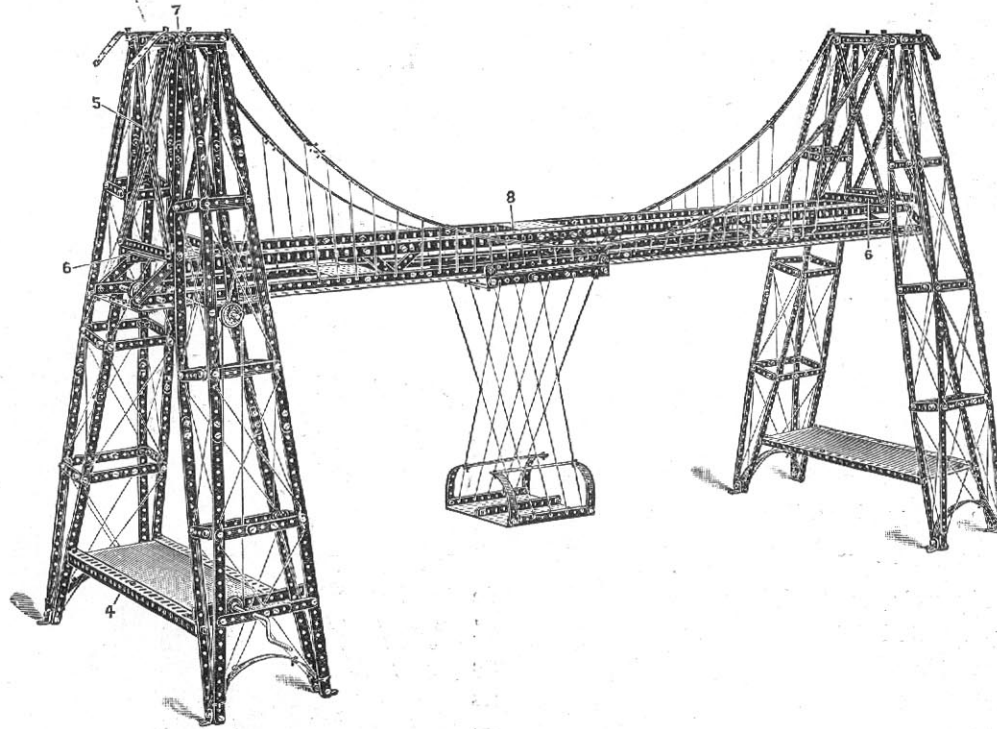

FIG. 127C.

MODEL No. 128. Transporter Bridge

(MADE WITH MECCANO OUTFIT NO. 6 OR NO. 5 AND NO. 5A.)



MODEL No. 128. Transporter Bridge *(continued)*

PARTS REQUIRED.

42	of	No.	1
56	"	"	2
12	"	"	3
23	"	"	4
24	"	"	5
24	"	"	6
20	"	"	8
11	"	"	9
16	"	"	11
72	"	"	12
1	"	"	13
2	"	"	15
1	"	"	19
4	"	"	22
4	"	"	23
1	"	"	25
1	"	"	27
4	"	"	35
38	"	"	37
2	"	"	52
5	"	"	53
3	"	"	59
8	"	"	60

The main girder in this model calls for no particular description, being constructed similarly to that previously described.

The end towers, Fig. 128A, are each made up of a pair of side girders composed of perforated strips 1 bowed at the centres and distanced by the short strips 2 and transverse strips 3. These side girders are connected at their lower ends by $12\frac{1}{2}$ " angle girders 4 and at their upper parts by the inclined $5\frac{1}{2}$ " strips 5, transverse $5\frac{1}{2}$ " angle girders 6 and upper $5\frac{1}{2}$ " strips 7. The end flanged plates of the main girder 8 are bolted to the angle girders 6 of the towers.

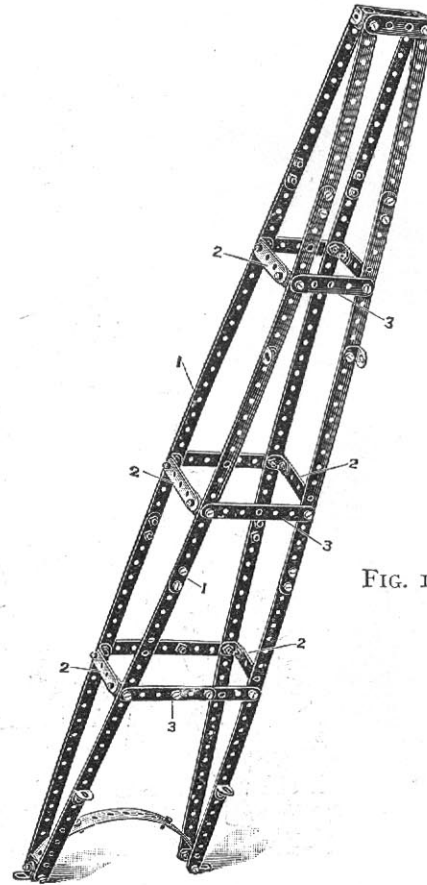
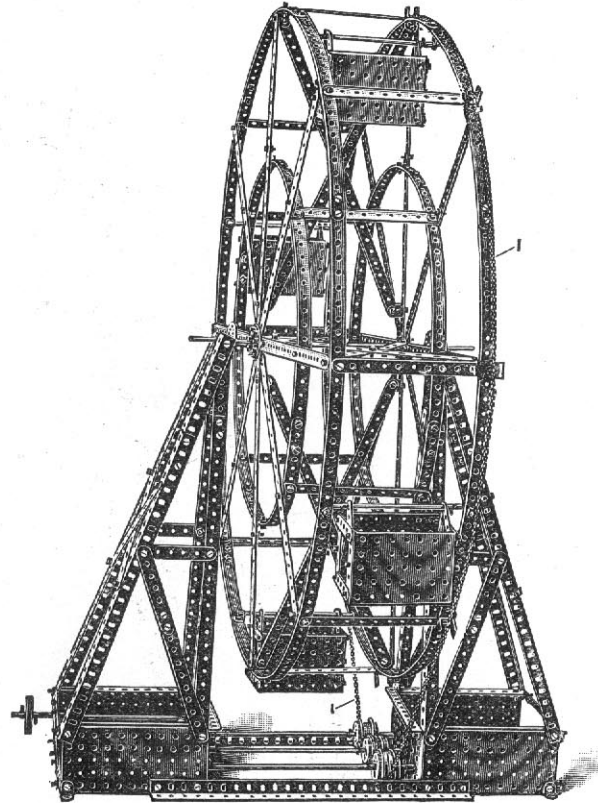

FIG. 128A.

MODEL No. 129. Big Wheel

(MADE WITH MECCANO OUTFIT NO. 6 OR NO. 5 AND NO. 5A.)



PARTS REQUIRED.

46 of No.	1
24 " "	2
4 " "	3
4 " "	4
34 " "	5
10 " "	8
4 " "	9
8 " "	11
68 " "	12
5 " "	13
1 " "	14
4 " "	15
6 " "	20
1 " "	21
4 " "	24
2 " "	25
2 " "	27
12 " "	35
292 " "	37
1 " "	42
6 " "	52
8 " "	53
2 " "	54
4 " "	59

MODEL No. 129. Big Wheel (continued)

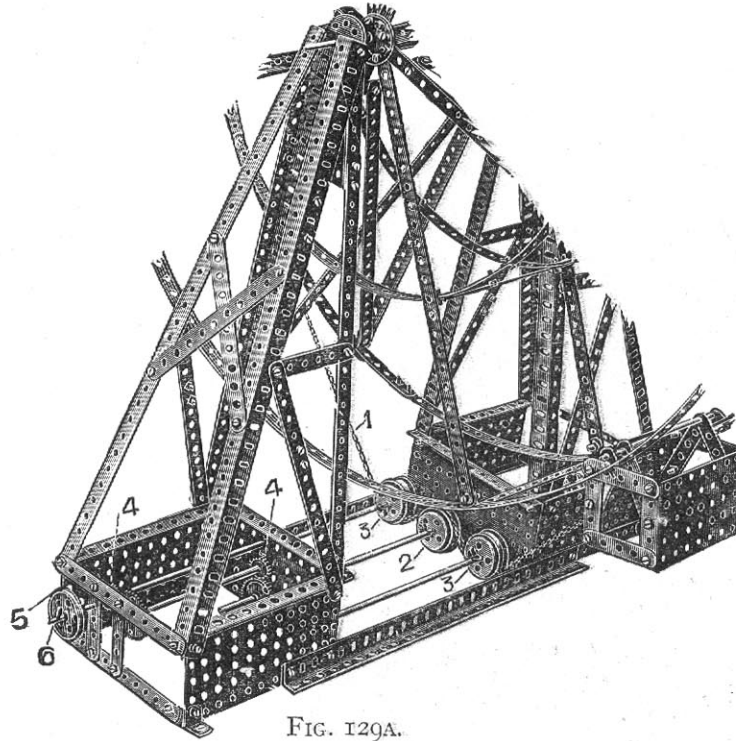

FIG. 129A.

In constructing this model flanged plates are used to form the sides and inner part of the base of the side pedestals and also to form the suspended cages on the wheel.

The driving chain is conveniently kept in position round the periphery of one of the side elements of the wheel by a series of double angle brackets bolted on the ends of the spokes.

In Fig. 129A is shown how the driving chain 1, passing round the driving wheel 2, is held around the circumference thereof by the guide wheels 3. The driving wheel 2 is driven through the gear wheel 4 from a $1\frac{1}{2}$ " pulley wheel 5 carried on the spindle 6.

MODEL No. 130. Funicular Railway

(MADE WITH MECCANO OUTFIT NO. 6
OR NO. 5 AND NO. 5A.)

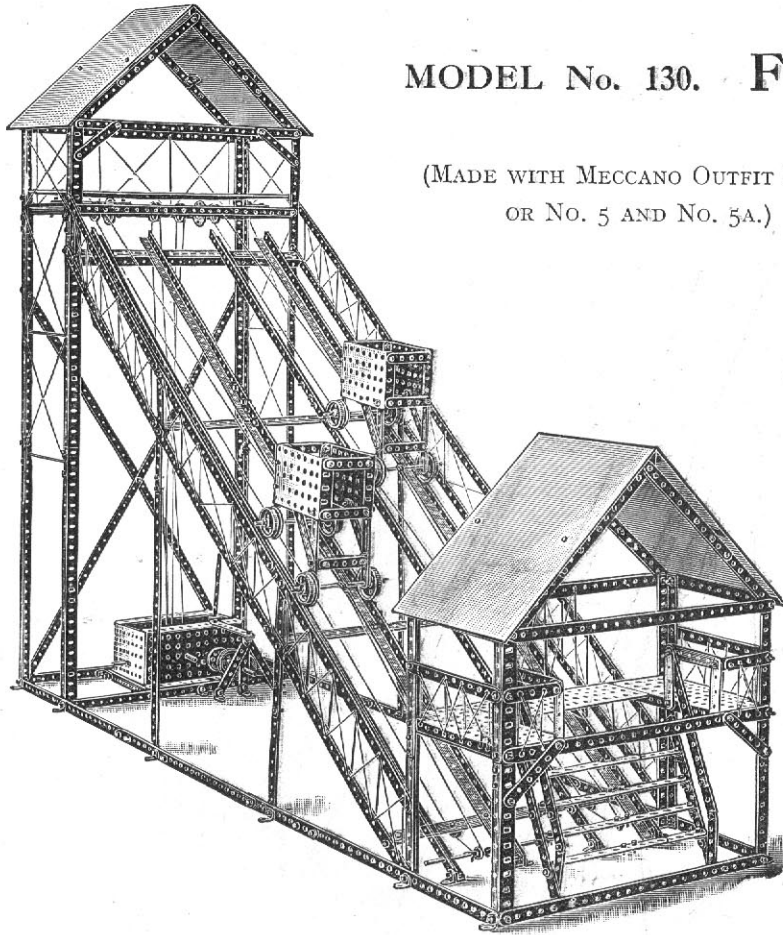

PARTS REQUIRED.

38 of No.	1	4 of No.	23
49 " "	2	3 " "	24
17 " "	3	3 " "	25
23 " "	4	1 " "	26
14 " "	5	2 " "	27
23 " "	8	2 " "	29
12 " "	9	1 " "	32
2 " "	11	14 " "	35
80 " "	12	411 " "	37
2 " "	13	1 " "	45
4 " "	14	1 " "	46
6 " "	15	6 " "	52
8 " "	20	8 " "	53
1 " "	21	4 " "	59
6 " "	22	2 " "	60

Begin by constructing the main tower Fig. 130A, the corner pillars 2 of which are made from two $12\frac{1}{2}$ " angle girders and a $5\frac{1}{2}$ " angle girder; the $12\frac{1}{2}$ " girders overlapped three holes and the $5\frac{1}{2}$ " girders two holes. The long tie strips 1 are $12\frac{1}{2}$ ", and the short side tie strips 3 $5\frac{1}{2}$ ". The rear diagonal ties 4 are made from $12\frac{1}{2}$ " strips overlapped. The roof rafters 5 consist of $5\frac{1}{2}$ " strips overlapped five holes.

The arrangement of the gear in the upper platform of this tower is well shown in the detail Fig. 130F. The inclined rails 5 Fig. 130B are made from 4 sets of $12\frac{1}{2}$ " angle girders, butted together and connected by 3" strips. The rails rest on three upper crossing $12\frac{1}{2}$ " angle girders 6, and a lower $12\frac{1}{2}$ " strip 7 to the ends of which are bolted the latticed side rails 8 supported by the vertical members 9. The $\frac{1}{2}$ " pulleys 10 are bolted by angle brackets to the lower strip 7, and on the transverse spindle 11 opposite these pulleys are secured further $\frac{1}{2}$ " pulleys 12. The ropes for hauling the wagons pass round these lower pulleys 10 and 11, and the pulleys 13 in the upper gear platform of the tower Fig. 130A. The loading platform Fig. 130C is built up from $12\frac{1}{2}$ " girder strips 14 to which are bolted side flanged plates 15 which are again connected by two small flanged plates 16. The other constructional details of this loading tower should present no trouble.

The main tower Fig. 130A, inclined rails Fig. 130B, and loading platform Fig. 130C are now coupled together by a series of horizontal $12\frac{1}{2}$ " strips 16 overlapped as shown.

The wagons Fig. 130D are made as follows: Two small flanged plates 17 are connected top and bottom by $2\frac{1}{8}$ " strips 18. The journals for the front axle 19 are made by two $3\frac{1}{2}$ " strips bolted inside the flanged plates, the axle being threaded through their lower projecting holes. The rear axle journals are made by carrying down two $3\frac{1}{2}$ " strips 20 bolted in their upper holes to the flanged plates, and braced with the diagonal strips 21 to the sides of the wagon. The axle 22 is again threaded through the lowest holes. One end of the operating cord 23 as shown in this view is secured to this rear axle; the other end, after passing round the pulleys as previously explained, being secured to the front axle 19. The gear box for operating the main hauling shaft 24 is very fully shown in Fig. 130E, the operating cords from the pulleys 25 passing up round the pulleys 26.

The Gear Box is mounted on two perforated plates 27, the angle brackets on which are bolted to the transverse strips 28 at the base of the tower Fig. 130A.

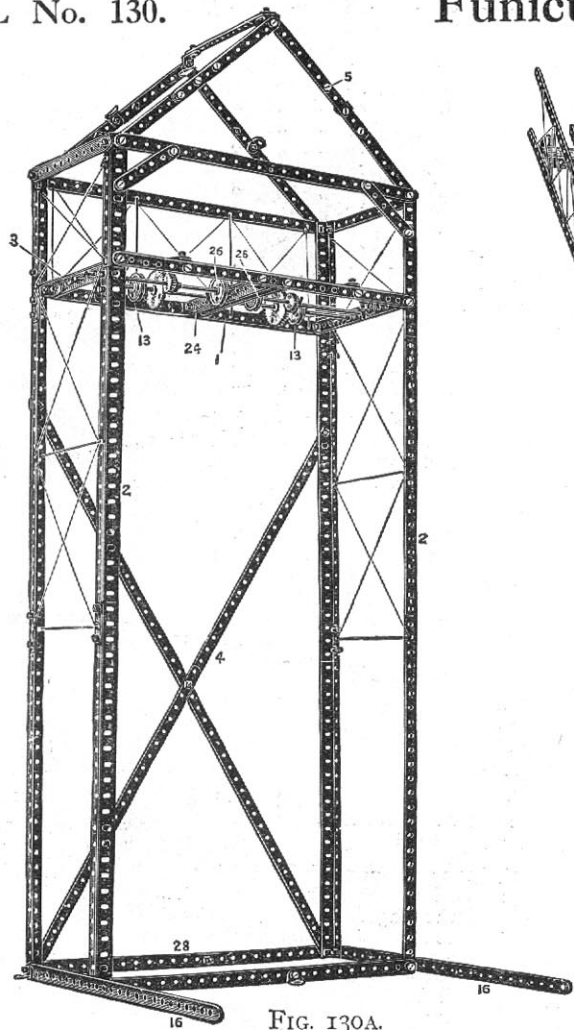

FIG. 130A.

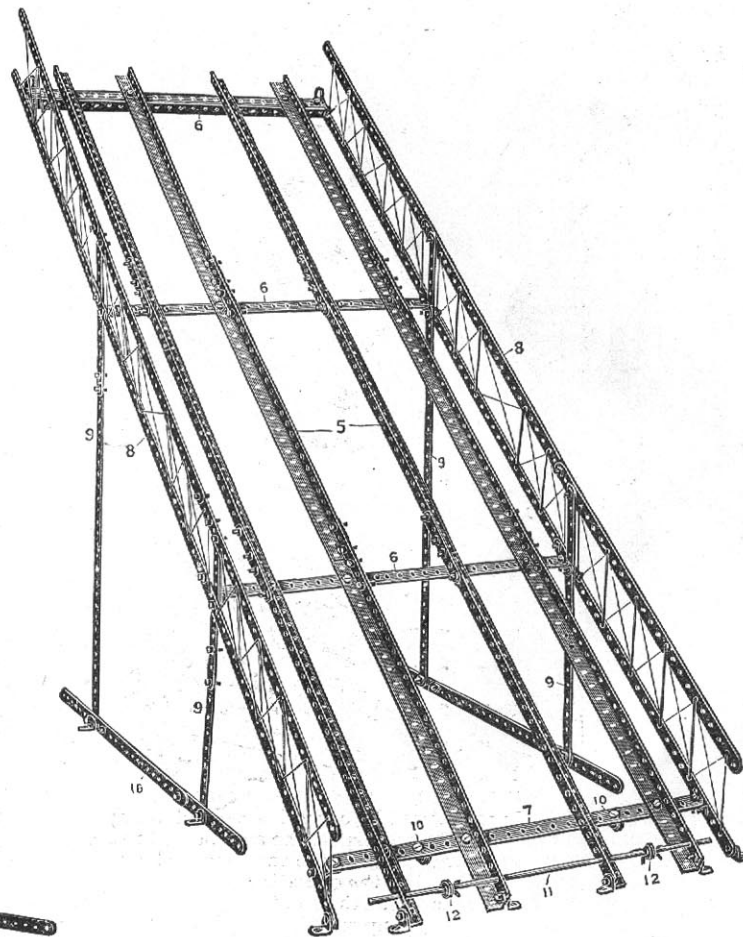

FIG. 130B.

MODEL No. 130. Funicular Railway (continued)

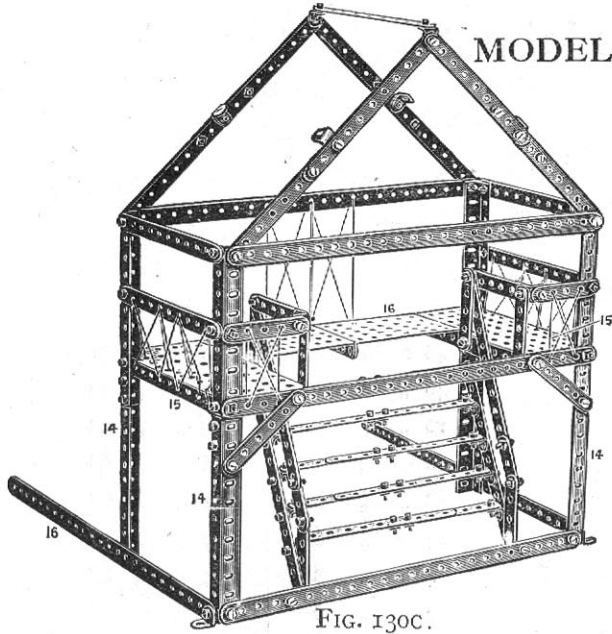

FIG. 130C.

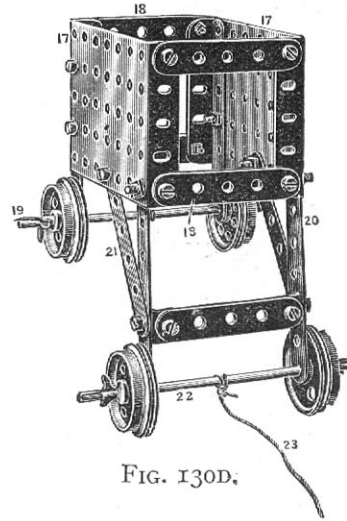

FIG. 130D.

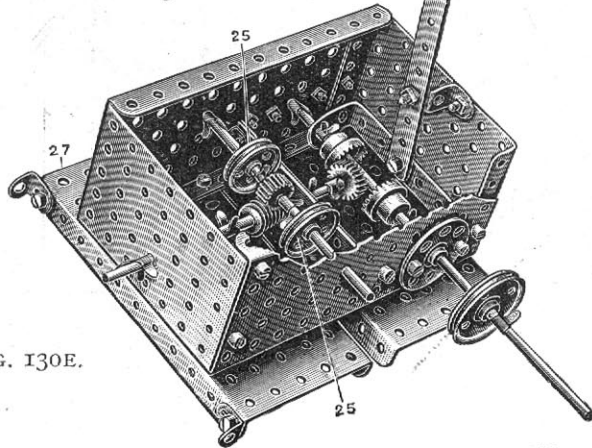

FIG. 130E.

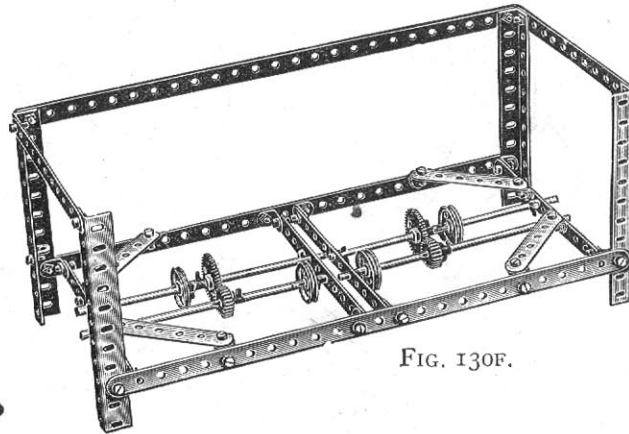
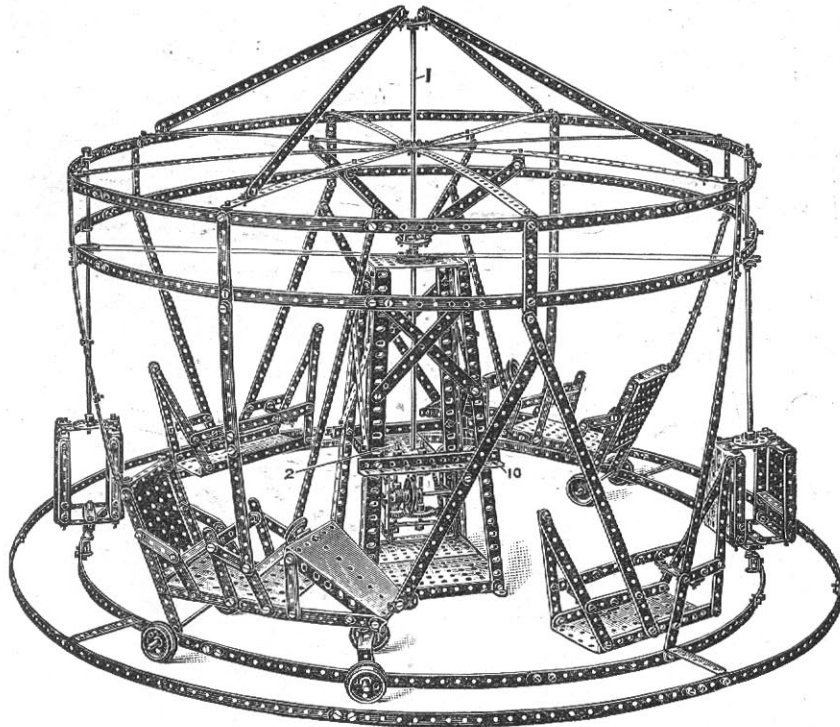

FIG. 130F.

MODEL No. 131. Roundabout

(MADE WITH MECCANO OUTFIT No. 6 OR No. 5 AND No. 5A.)



PARTS REQUIRED.

48 of No.	1	2 of No.	21
40 " "	2	4 " "	22
16 " "	3	5 " "	24
8 " "	4	2 " "	25
28 " "	5	1 " "	26
24 " "	6	2 " "	27
4 " "	8	394 " "	37
2 " "	9	4 " "	45
2 " "	11	2 " "	46
76 " "	12	7 " "	52
4 " "	13	7 " "	53
4 " "	15	2 " "	54
3 " "	16	11 " "	59
2 " "	17	16 " "	60
8 " "	20	1 " "	63

MODEL No. 131. Roundabout (continued)

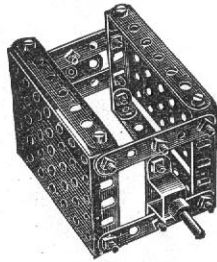

FIG. 131B.

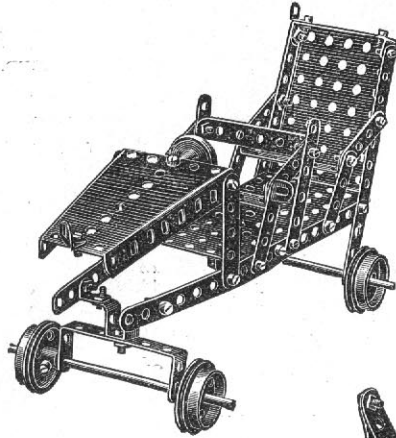

FIG. 131C.

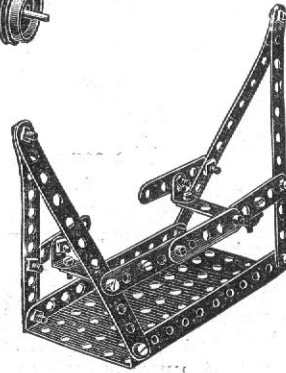

FIG. 131D.

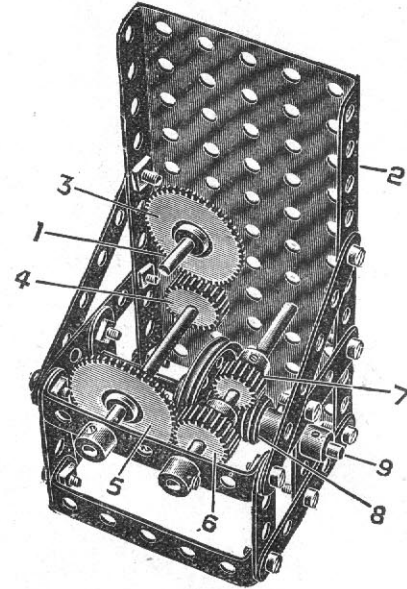
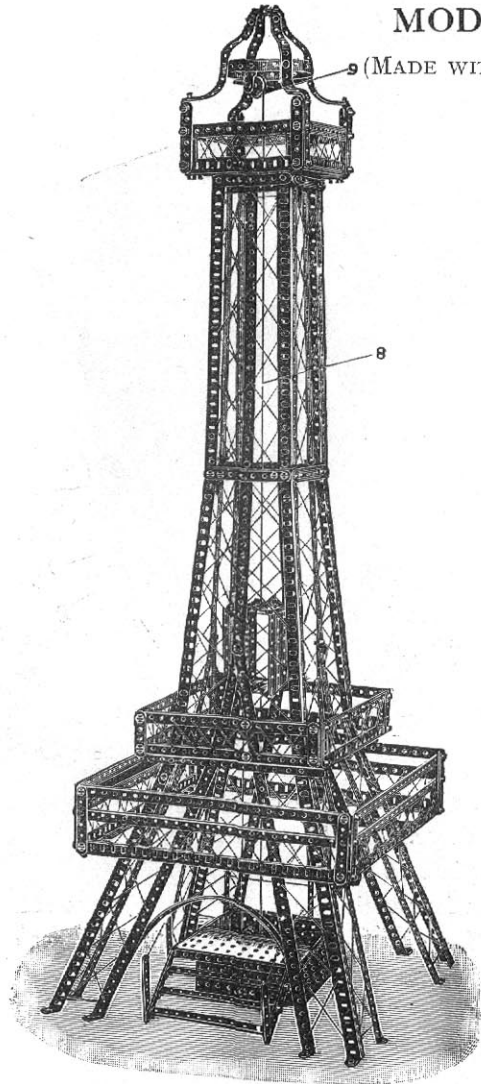

FIG. 131A.

The construction of the different suspended carriages is brought out in the detail views. The central spindle 1 carrying the roundabout frame is fitted beneath the flanged plate 2 with a gear wheel 3 driven by a $\frac{3}{4}$ " pinion 4, and on the same spindle a gear wheel 5 driven by another $\frac{3}{4}$ " pinion 6. On the same spindle as this pinion 6 is a $\frac{1}{2}$ " pinion 7 driven by a worm 8 on the spindle 9. The central standard carrying the gear box is built up from four angle girders diagonally braced and bolted together at the top by a small flanged plate and at the bottom by two large flanged plates, the inner flanges of which are bolted together. The flanged plate 2 carrying the gear box is bolted to angle girders 10.

MODEL No. 132. Eiffel Tower

(MADE WITH MECCANO OUTFIT NO. 6 OR NO. 5 AND NO. 5A.)



PARTS REQUIRED.

28 of No.	1	1 of No.	24
40 " "	2	2 " "	25
17 " "	3	1 " "	26
23 " "	4	1 " "	27
12 " "	5	2 " "	29
8 " "	6	1 " "	32
16 " "	8	1 " "	37
12 " "	9	1 " "	44
60 " "	12	1 " "	45
1 " "	14	1 " "	46
3 " "	15	3 " "	52
1 " "	17	4 " "	53
1 " "	21	6 " "	59
2 " "	22		

The corner members of the tower Fig. 132A, are made of angle girders butted together and connected by 3" strips inside. The top 1 of the framework is connected by 3½" strips and the middle 2 of the framework by two 3½" strips overlapped six holes so as to give a slight splay, and is connected at the front at 3 by 5½" strips overlapped five holes, and at the sides on the same level by two 5½" strips overlapped nine holes. The splay of the base of the tower is obtained by bending out the corner angle girders and bolting them in that position by the 12½" strips 4. The framework may then be screwed down to a base. The platform 5, Fig. 132B, is then put over the top of the tower and bolted on to the ends of the strips 4 by angle brackets. In the same way the platform 6, Fig. 132B, is passed over the tower and bolted to angle brackets on the strips 3. The crown top is then fitted.

The elevator gear box, Fig. 132C, is made from flanged plates, the pulley 7 round which passes the cord 8 to the pulley 9 at the top of the tower being carried on a shaft 10 fitted with a gear wheel 11 driven by a ¾" pinion 12 carried on the shaft 13, this latter shaft has also a ½" pinion 14 and driven by a worm 15, this worm being on a shaft carrying a ¾" pinion in a reversing gear (see standard detail B). The elevator cage Fig. 132E is constructed as shown.

MODEL No. 132. Eiffel Tower (continued)

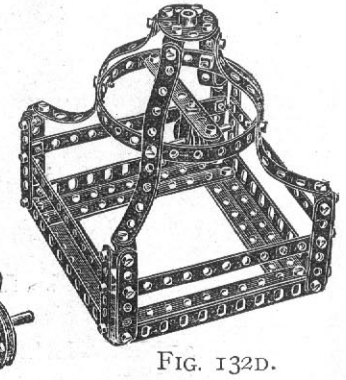
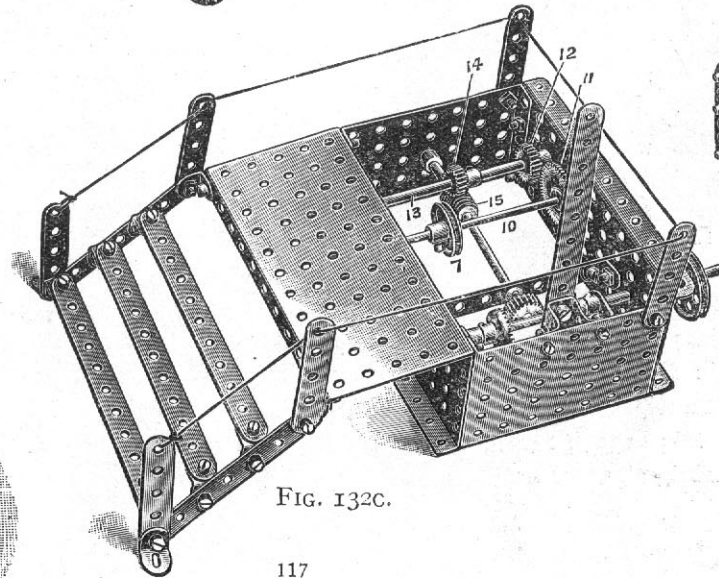
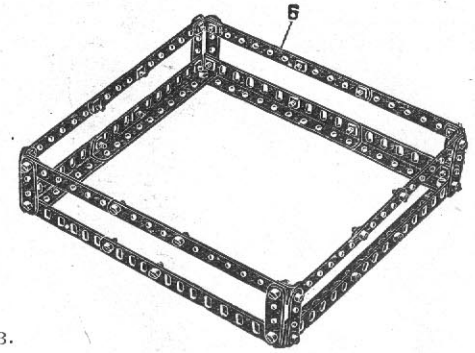
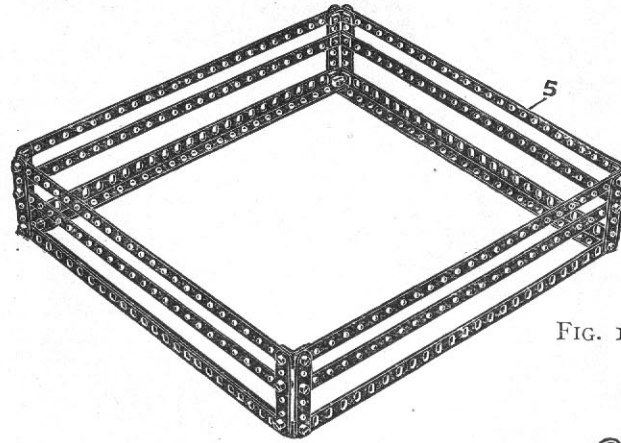
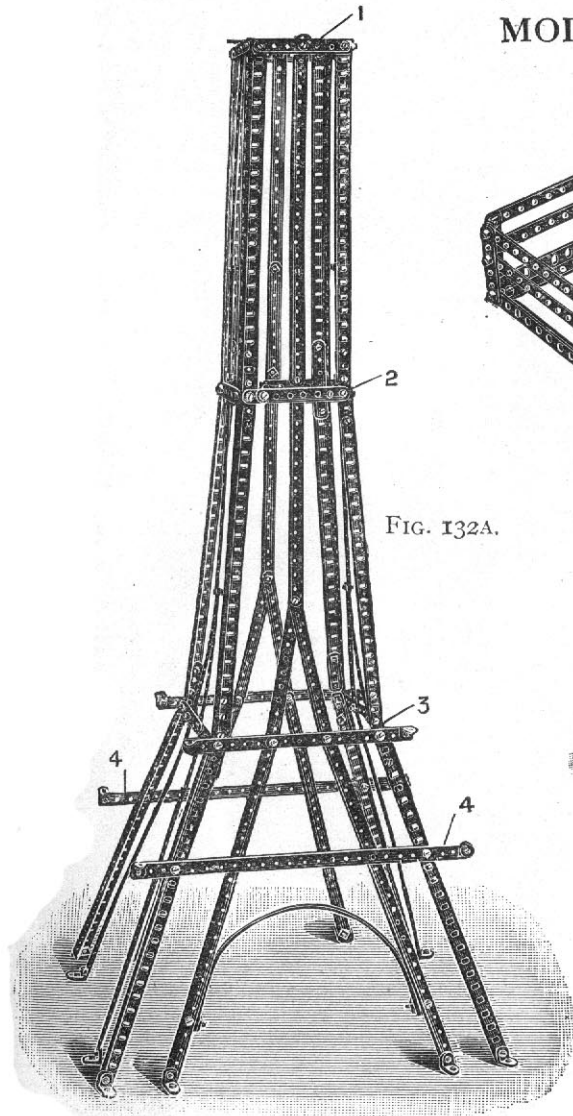

MODEL No. 133.

Mechanical Navy

(MADE WITH MECCANO OUTFIT NO. 6 OR NO. 5 AND NO. 5A.)

PARTS
REQUIRED.

12	of No.	1
8	" "	2
3	" "	3
11	" "	4
18	" "	5
2	" "	6
12	" "	8
12	" "	9
1	" "	11
36	" "	12
4	" "	13
1	" "	14
8	" "	15
2	" "	16
3	" "	17
4	" "	19
7	" "	20
2	" "	21
6	" "	22

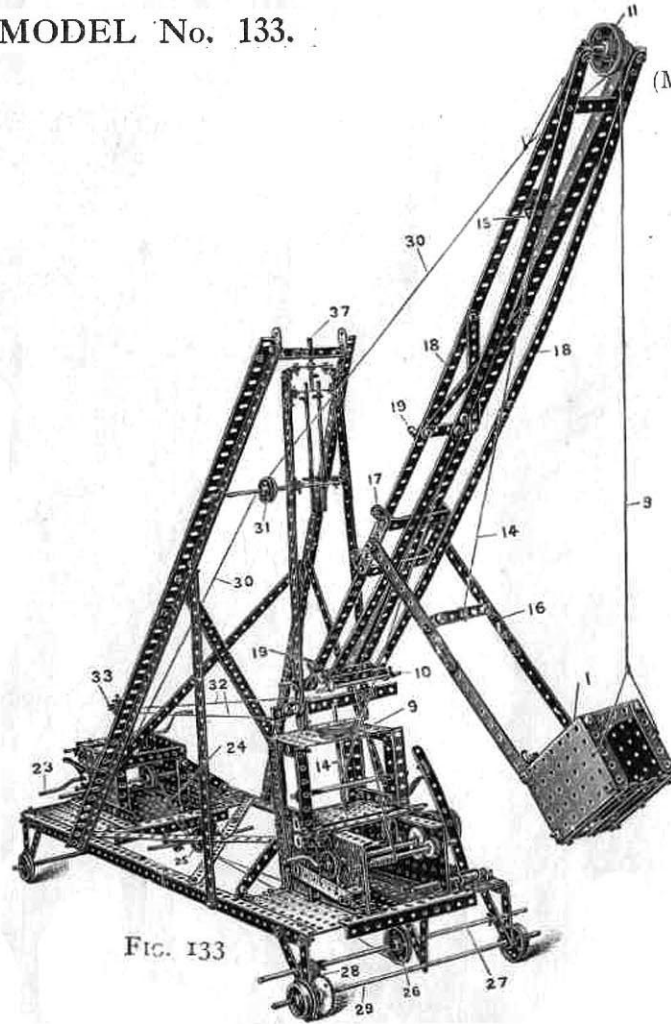

FIG. 133

PARTS
REQUIRED.

4	of No.	23
1	" "	24
3	" "	25
2	" "	26
2	" "	27
1	" "	32
1	" "	33
24	" "	35
321	" "	37
1	" "	43
1	" "	44
1	" "	45
4	" "	46
2	" "	51
8	" "	52
7	" "	53
2	" "	57
4	" "	59
3	" "	60

MODEL No. 133. Mechanical Navy *(continued)*

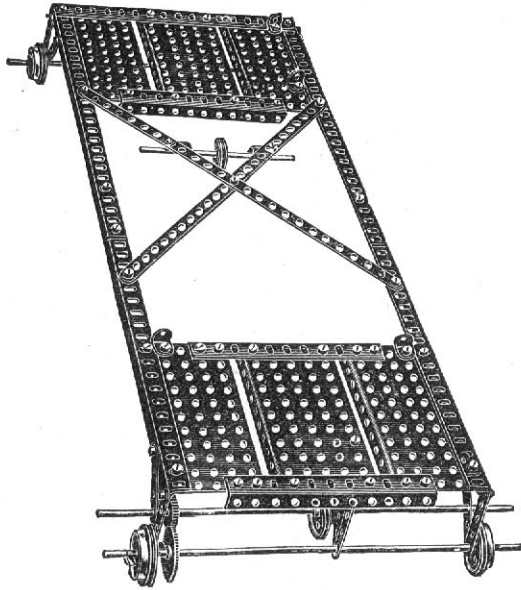

FIG. 133A.

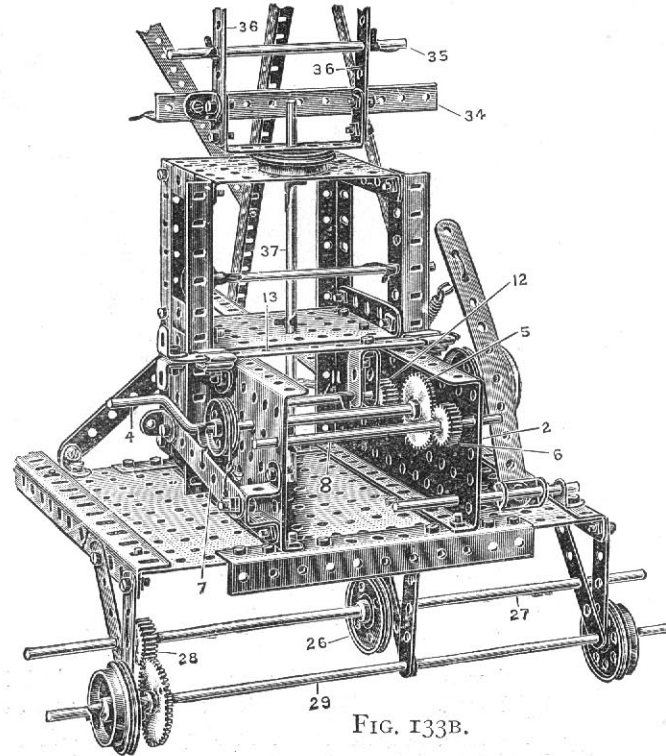

FIG. 133B.

With this model, proceed first by constructing the bed frame, Fig. 133A. On the front portion of the bed frame is now mounted the gear box, Fig. 133B, which controls the movements of the bucket 1. The side walls of the gear box 2 consist of two large flanged plates bolted on the bed plate, Fig. 133A; the crank handle 4 carries the large gear wheel 5, meshing with the $\frac{3}{4}$ " pinion 6. A friction brake mechanism 7 controls the crank handle 4. The winding spindle 8, driven from the crank handle 4, carries the cord 9 passing round the spindle 10 and the jib end pulley wheel 3 to control the swinging movement of the bucket 1. The rear spindle 11 carrying a $\frac{3}{4}$ " pinion 12 controlled by the clutch strip 13 is adapted to be put in or out of gear with the gear wheel 5. The cord 14 passes from this rear spindle 11 round the jib pulley 15 back to the bucket arm. When, therefore, both spindles 8 and 11 are in gear with the crank handle 4

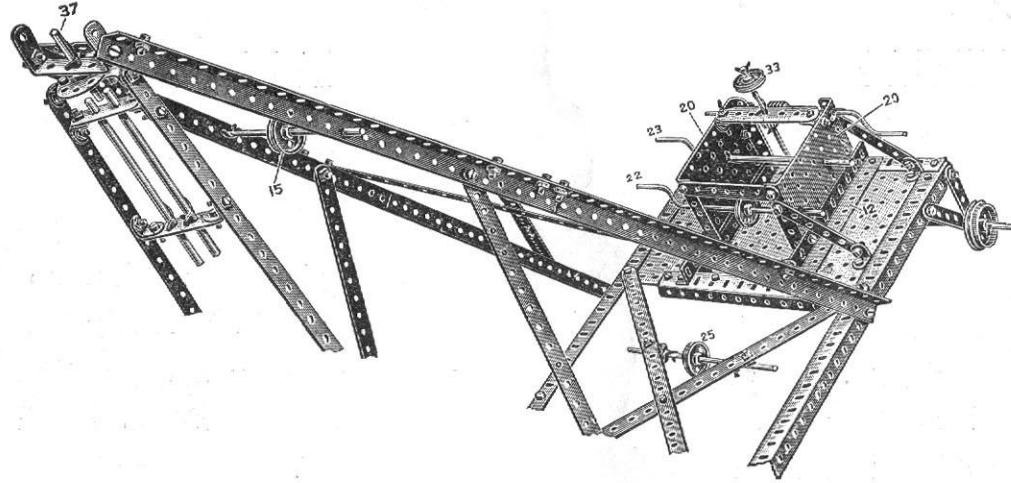

FIG. 109C

handle 4 the bucket partakes of a combined swinging and vertical travelling movement up the jib, the bucket arm 19 being pivoted to a light trolley 17 riding on the edge girders 18 of the jib between stops 19 consisting of angle brackets.

Proceed next with the gear box on the rear platform shown in Fig. 109c. This again consists of two small rectangular plates, bolted by angle girders 21 to the bed frame, and carrying two cranked spindles 22 and 23. The spindle 22 carries a 1" pulley wheel round which passes the cord 24, for causing traversing movement of the bed frame. This cord passes under the pulley wheel 25 and round the front pulley wheel 26, which latter is secured on a spindle 27 geared at 28 to the flanged wheel spindle 29.

The cord 30 for elevating the jib, passes round the pulley wheel 31 and on to the rear cranked spindle 23. The cord 32 for luffing the jib passes round the pulley wheel 33 on the vertical spindle of the gear box, and is connected to the outer ends of the yoke piece 34. The jib of the crane pivots about the spindle 35 mounted in the standard 36, which in turn swivels about the spindles 37.

MECCANO IS MORE THAN A TOY

IT is important to remember that when a boy is playing with Meccano he is using engineering parts in miniature, and that these parts act in precisely the same way as the corresponding engineering elements would do in actual practice. No other system of model construction could, therefore, be correct. Other toys which attempt the same object by other methods must avail themselves of other constructive elements which are not correct engineering elements. Consequently, though a boy may succeed in building playthings with them, they are merely toys, and nothing else, and his mind, as regards proper mechanical construction and methods, is distorted instead of instructed. He thus learns wrong principles, and when his ambition tempts him to invent or construct more elaborate models he will be stopped by the deficiencies of his non-mechanical system.

THE SCIENCE OF MECHANICS TAUGHT BY MECCANO.

Apart from its great attraction as a pleasure-giving hobby, Meccano has a distinct and unique value as an educative force of the highest order. Whilst extracting fun and amusement from the construction of such models as the Telpher Span, the various Cranes, Wagons, Elevators, Towers, Bridges, &c., and playing with them after they have been constructed, the user is acquiring a thorough and valuable knowledge of the important principles of mechanical construction. If the information thus acquired proves of no practical or material value, it at least enables the boy or man to take a more keen and more intelligent interest in those mechanical and engineering wonders which, in these remarkable times of invention and progress, confront us at every turn. On the other hand, however, it has on very many occasions been a source of satisfaction and pride to us to learn that, through the stimulating influence of Meccano many a boy has been impelled to take up seriously the study of mechanics.

Some few ago, in the "Hornby System of Mechanical Demonstration," we gave 37 examples demonstrating the main elementary fundamentals of mechanics and mechanical science, and these have been found to be of the very greatest use to students. We have introduced a selection of these examples into the Meccano Manual this year, and they will be found on the following pages. It is hoped that they will prove both useful and instructive even to those who appreciate Meccano simply for the fun and pleasure which they derive from it.

Centrifugal Governor.

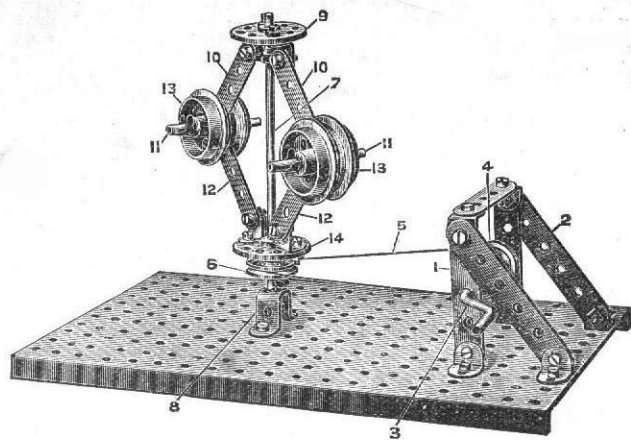

This model shows the fundamental principle of a centrifugal type of governor. At the top of the spindle 7 is secured a bush wheel 9, connected to which are two angle brackets, and on these angle brackets are pivoted the upper links 10. Short spindles 11 pass through the ends of these links 10 and through the ends of the lower links 12, the wheels 13, which correspond to the ball weights of an ordinary governor, are secured on the spindles 11. The lower ends of the links 12 are bolted to brackets on the lower bush wheel 14, this lower wheel 14 being capable of riding loosely up the spindle 7. On rotating the crank 3 it will be found that the tendency of the weights 13 to fly outwards causes the bush wheel 14 to rise up the spindle. This principle is taken advantage of to govern an engine.

Universal Crosshead.

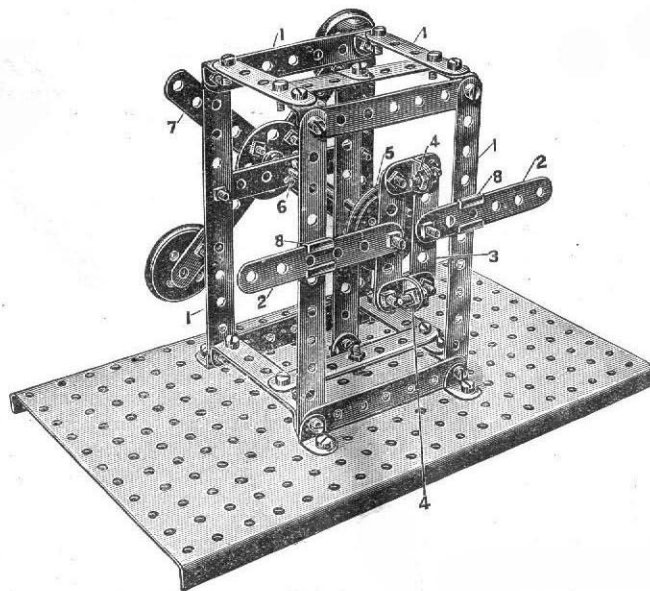

This model shows a construction which is frequently adopted in pumps and similar mechanism. It is known as a universal crosshead. At the nearest side is mounted a moving frame constructed of two straight strips 2 connected to another pair of cross strips 3, bolted at their ends by angle brackets 4 to form a slot. This slot engage the projecting shank of a bolt screwed in a bush wheel 5, which is secured upon a short spindle 6, passing through a middle vertical strip and the back framework. Four strips 7 bolted to a bush wheel secured on the outer end of the spindle 6 act as a fly wheel. The front strips 2 are guided in the eye pieces 8. By reciprocating the front frame by one or other of the strips 2 in the guides 8, it will be seen that the slotted guides 3 operate on the projecting bolt of the wheel 5 and rotate the shaft 6.

Hooke's Coupling.

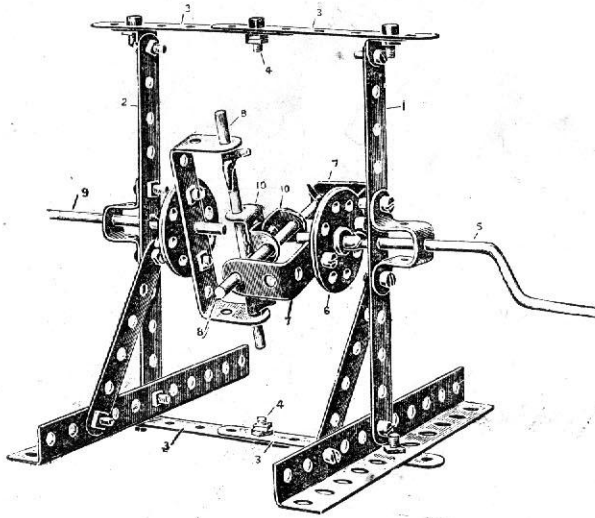

This shows an apparatus known as Hooke's coupling, which is designed for use in situations where it is required to connect together two rotating shafts which are not in line. It will be found that this model will convey a thorough understanding of what is otherwise a very complicated and elusive movement. On the crank shaft 5 is keyed the wheel 6, to which is bolted the bent armed strip 7. Across the ends of this bent strip 7 is fitted the short spindle 8, an exactly similar duplicate formation is provided for the shaft 9 in the side frame 2. The cross shafts 8 are coupled by pairs of angle brackets 10, arranged back to back. The shafts 5 and 9 are now coupled together in such a manner that even if the side frames 1 and 2 are moved about the bolts 4 to a position such that the shafts 5 and 9 are inclined to each other, the coupling will still rotatively connect the one shaft to the other.

Block and Tackle.

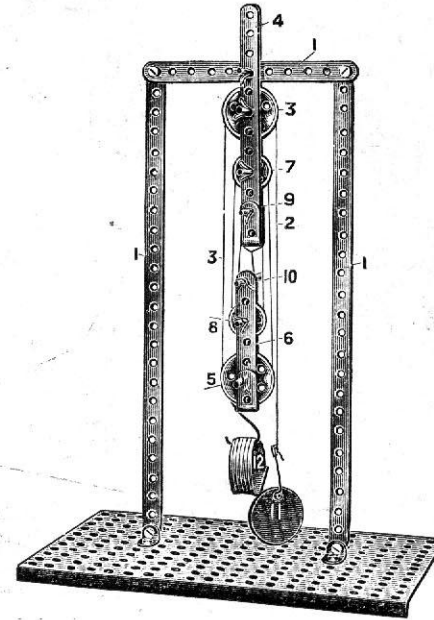

This is an arrangement showing the more usual application of a pulley system in the case of a block and tackle. There is only one continuous cord 2 in this case, which passes round the top pulley 3, pivotally mounted in the strips 4 which are fixed to the frame work 1. The cord then passes round the lower pulley 5, also pivotally mounted in the movable frame work 6, then over the next top fixed pulley 7, and then to the lower movable pulley 8; from thence to the small upper pulley 9, and finally round the corresponding lower pulley 10, and is fixed to the end of the bent strip attached to 4. The effect of the force 11 in raising the weight 12 is found by counting the number of cords which spring from the lower movable pulley block 6 to the fixed block 4.

Lever.

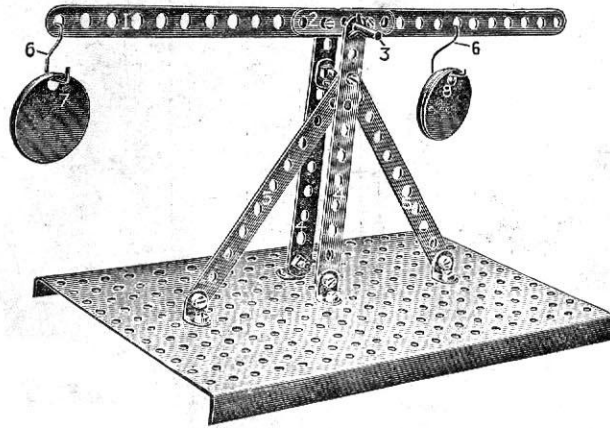

This example serves to determine the principle of equilibrium of an ordinary lever. Through the strengthening strip 2 is passed the short shaft 3, which is supported in the uprights 4. The hooks 6 are for supporting the weights. By selecting a certain number of disc weights and suspending them in various holes on each side of the spindle 3, it will be found that any weight 7 on one side of the spindle multiplied by the arm or distance—that is, the number of holes—from the spindle 3, will be equal to the weight 8 multiplied by its arm or distance, or number of holes, from the spindle 3. The weight at any side multiplied by its arm or distance from the spindle 3 is called the moment of the force, or weight, about the fulcrum 3, and it is necessary in order that the lever should balance that the moments on each side of the fulcrum should be equal.

Jib Crane.

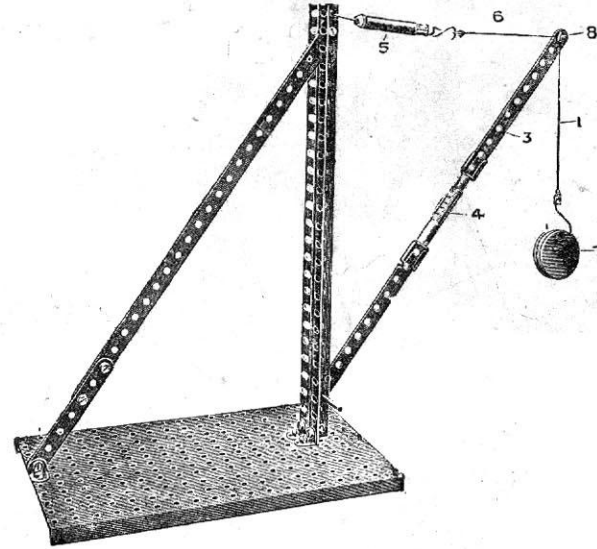

This model serves to illustrate how the forces in the tie and jib of a simple crane may be determined. If any weights be suspended by the cord 1 from the extremity of the jib 3, it will be found that the compression spring balance 4 and the tension spring balance 5 register various forces. The angles formed by the jib 3 and the tie 6 should be carefully noted, and a triangle then drawn with its sides parallel respectively to the vertical cord 1, the jib 3, and the tie 6. It will be found that the sides of the triangle so drawn are in direct proportion to the values of the weight 7 and the forces on the jib 3, and the tie rod 6.

Simple Roof Truss

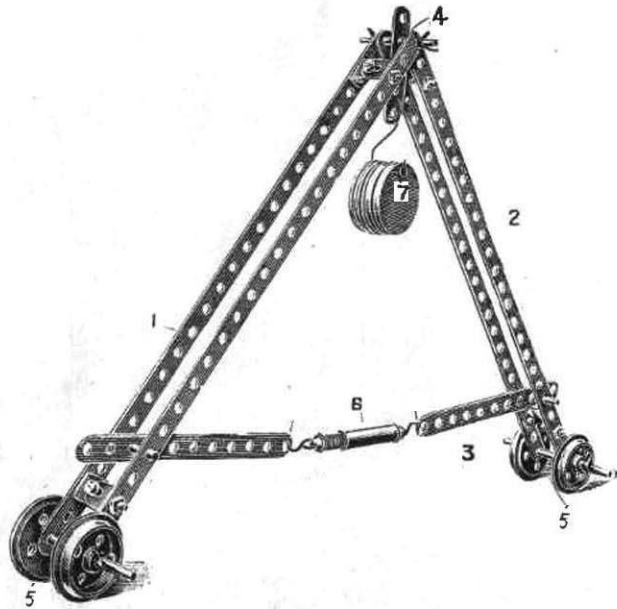

This is an apparatus for finding out the stresses in a roof-truss. The material in the inclined girders 1, 2, of any rooftruss frame are in compression, but the tie rod represented by the cord 3 is in tension, that is to say it is being pulled apart. The compression members in such a roof-truss are, therefore, made rigid so that they will not bend, but the tie rod 3 being in tension could not possibly bend, and is usually, therefore, made of thin bar or rod. The two compression members are pivotally connected at the apex by a rod 4 and large wheels 5 are fitted at the feet.

The cord 3 connects across to the axles of the wheels 5 and a spring balance 6 for registering the pull is inserted. Various weights 7 should be hung on the rod 4 and the different pulls registered by the spring balance 6 should be noted, and these results should be tabulated by the student. When this has been done a number of weights the angle between the compression girders 1 and 2 should be altered by shortening or lengthening the string 3 and a new series of experiments with different weights 7 should be conducted and the results tabulated.

Inclined Plane

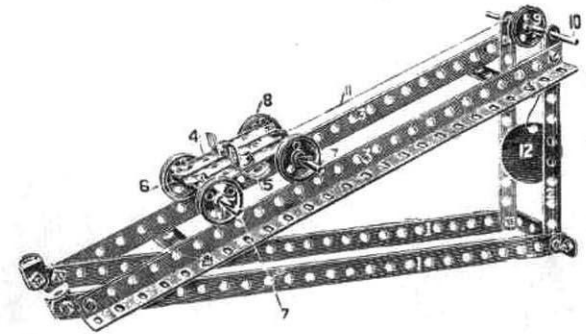

This is an example to illustrate the principle of the inclined plane. The main frame work is constructed of the horizontal strips 1 carrying the vertical strips 2. A pair of inclined angle girders 3 are bolted to the lower strips 1 and the uprights 2. A carriage, consisting of a series of strips 4 bolted to a cross strip 5 and to angle brackets 6, which carry the shafts 7, is adapted to roll on its wheels 8 along the upper edges of the angle girders 3. A pulley 9 mounted on a short shaft 10 rotates in the top perforations of the uprights 2, a cord 11 is passed over this pulley 9 to the carriage 4, and is provided at its lower end with a hook, upon which a series of weights 12 may be suspended. The form of the apparatus shown is suitable for finding the conditions of equilibrium of a smooth body on a smooth inclined plane when the line of action is parallel to the plane. By withdrawing the spindle 10 and inserting it with its pulley at a lower position in the upright strips 2, the cord 11 may be arranged to act horizontally on the carriage 4. This arrangement gives the second condition of the inclined plane where the line of direction of the force maintaining equilibrium acts horizontally.

Standard Details for use in the Construction of Models on the Meccano Principle

A—A Brake Mechanism suitable for controlling winding or similar spindles.

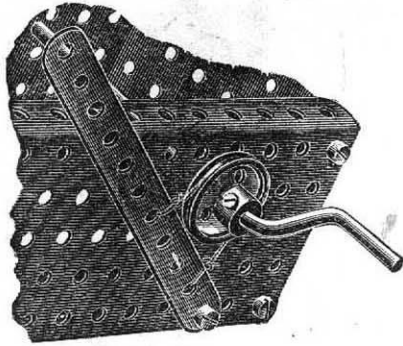

B—Type of Reversing Gear.

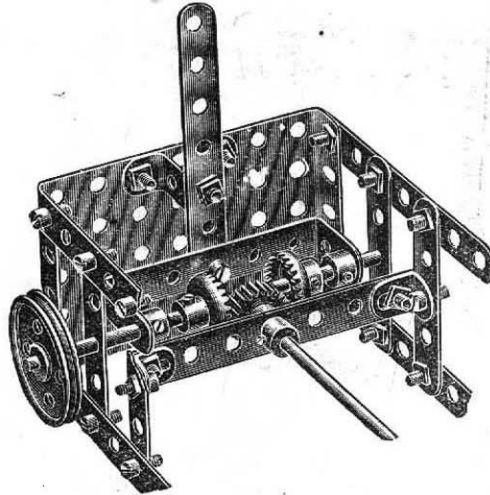

C—Worm and Worm Gear.

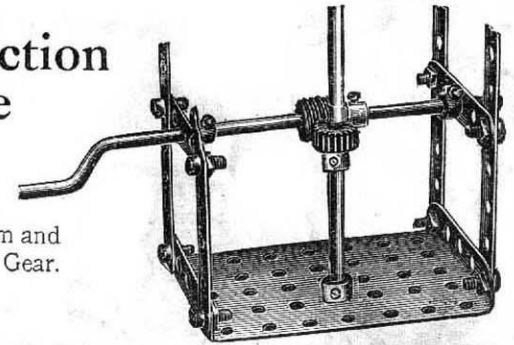

G—Method of operating a fast and loose pulley with a belt drive, one of the flanged wheels on the main shaft being secured whilst the other runs freely.

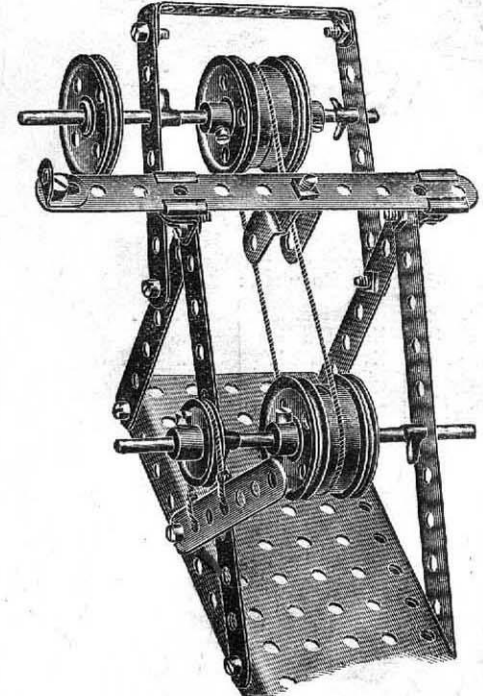

D—Method of locking swivelling connections with double nuts.

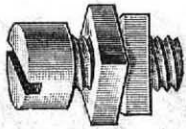

E—Pawl and Pinion or Ratchet Gear; used also as a brake.

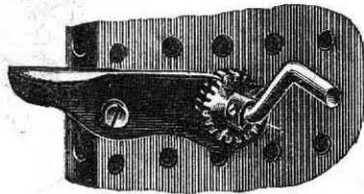

F—Spring controlled Band Friction Brake.

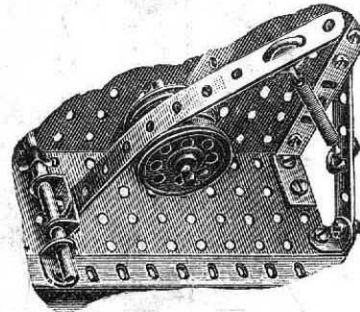

H—Simple Extended Bearing suitable for longitudinal or rotary movement of spindles.

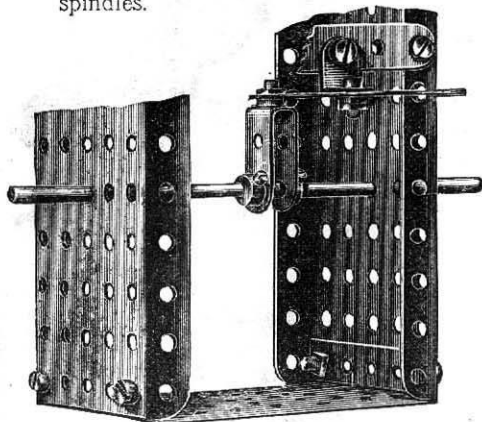

K—Swivel Bearing providing for combined sliding and oscillating movement of a strip.

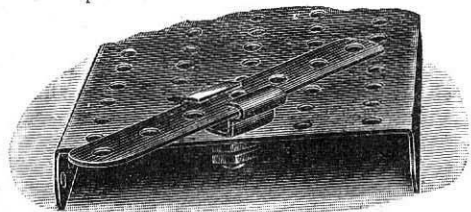

N—Crank formed with $1\frac{1}{2}$ " pulley wheel and strip, lock-nutted. (See detail D.)

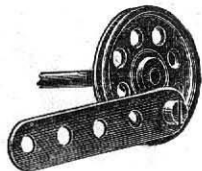

I—Gear Connection for coupling two shafts at right angles.

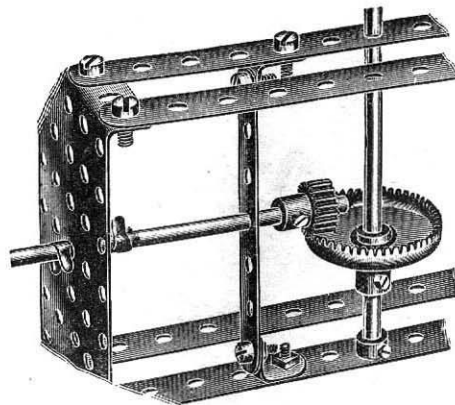

L—Jockey Pulley Arrangement for increasing grip in a driving band.

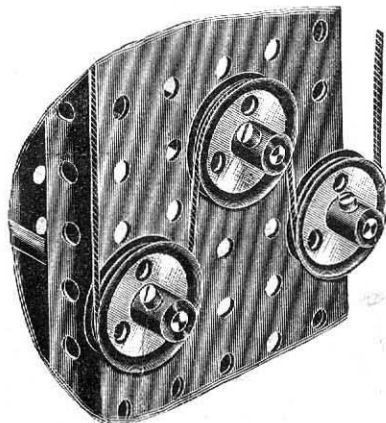

J—Purchase Pulley.

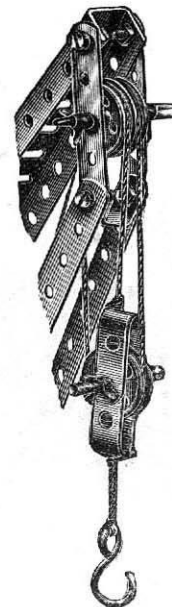

M—Reinforced Bearing for spindles.

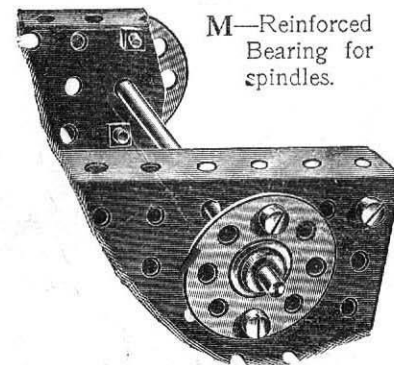

O—Extended bearing for a spindle formed by a double bent strip bolted to a perforated plate.

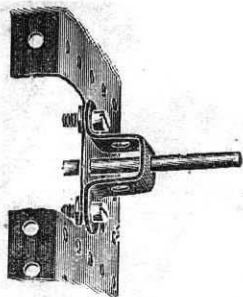

P—Footstep bearing for a vertical spindle formed by bolting a double bent strip to a perforated plate.

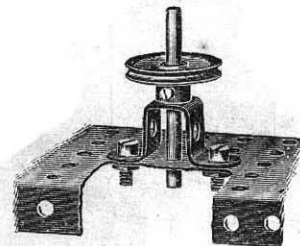

Q—Overhung support for $\frac{1}{2}$ " pulley. The bolt spindle for the pulley is nipped on each side of the angle bracket.

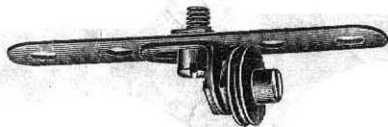

R—Overhung support for larger pulley. The screwed end of the bolt is entered in the wheel boss and nipped by the set screw.



MECCANO MOTORS

ONE of the principal merits of Meccano is that all the models which it makes are *working models*. No greater pleasure for any boy can be imagined, than for him to take a number of elementary parts, piece them together with his own hands and in his own way, and then to see the results of his efforts and skill move and work in a precise and scientific way. The Meccano Motors will encourage this very natural pleasure. They have been designed on Meccano lines, and are specially suited to work Meccano models, to each one of which they give life and movement.

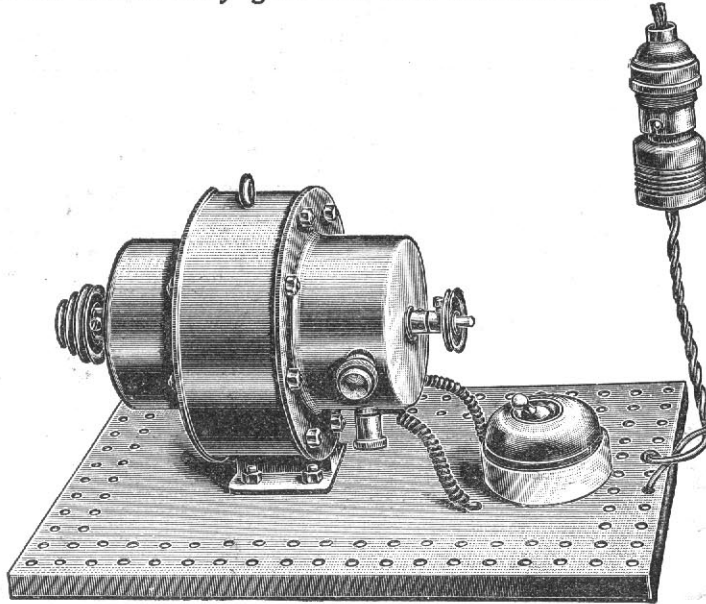

The field coils are former wound, and are protected with best quality Empire cloth and good tapes, and when completed are thoroughly insulated by dipping in good-quality shellac varnish. They are then stoved and baked previous to placing in the magnet frame. All standard machines are of the series-wound type. The advantage of this is that they can be started on full load without damage to the motor. No bad effects will result from the sudden stoppage or jamming of the motor. This is a very important feature.

Meccano Electric Motor

The Meccano Electric Motor differs from all previous types of electric motors, being totally enclosed, thus eliminating all fear of shock. This is absolutely essential where the motor is to be run by inexperienced users in the home. It has a very high finish of nickel-plating, and it is designed on sound mechanical principles. It is intended to be used in connection with models where a greater power is required than is provided by the spring motors, e.g. for working such models as the lathe shown on page 79, or a number of models at one time. It provides for continuous running, and the motion is started and stopped by the simple movement of a switch. This switch is fitted to the base of the motor, and is connected with a flexible wire attached to an adaptor to enable it to be readily connected to any lampholder.

It is necessary to see that the motor purchased corresponds to the voltage of the current with which it is to be connected. Care should be taken not to use a 110-volt motor on a current of 230 volts, as the effect would be to damage it.

Specification

The machines are of the self-contained type, and are so arranged that they can be turned through angles of 90° or 180°, thus allowing the motor to be bolted to either the wall or ceiling, or in fact used in any convenient position.

The field frame consists of substantial cast-iron casing of good permeability, cast in one piece including the pole-pieces, and is of the Bi-polar type.

Meccano Motors *(continued)*

The **armature shaft** is of special mild steel designed to operate safely under the most severe working conditions. The armature core is built up of good-quality iron of the highest permeability, and each disc is carefully insulated and assembled directly on to the shaft between strong end-plates. The armature is of the slotted-drum type.

The **winding** is of the symmetrical drum type, each coil being carefully wound by experienced armature winders, and the coils are carefully insulated, varnished, and stoved. The coils when wound are held in position by fibre strips, which are placed in the mouth of the slots. The armature insulation has been given most careful attention, and is of fine-quality micanite. After the armature is completed, it is thoroughly dried at a temperature of about 200°.

The **commutator** consists of the requisite number of hard-drawn copper segments of high conductivity and ample depth, insulated with mica. After assembly the whole is subjected to heavy hydraulic pressure whilst at a high temperature, and when in such position the insulating rings and sleeve are also under great pressure.

The **brush-holders** are of substantial design, and of the box type, the brush being kept on the commutator by direct pressure from springs fitted in the holders.

Each machine before despatching is subjected to a six-hours' test, run at full load, and its various parts are coupled up to run in a clockwise direction, when looked at from the commutator.

The motors are of one-thirtieth horse-power, and their speed is about 1,500 revolutions per minute, fully loaded.

Meccano electric motors are made either for 200 to 230 volts direct current, 100 to 120 volts direct current, or for 110 alternating current.

The essentials of an electric motor for running Meccano models are, that it shall be of the totally-enclosed and slow-speed type. The Meccano Electric Motor has been specially designed for the purpose, is practically "fool proof," and is finished, adjusted, and tested, regardless of cost. We recommend that no other type of motor be used for running Meccano Models. Our full guarantee is behind it. All the parts are interchangeable, and can be replaced at any time.

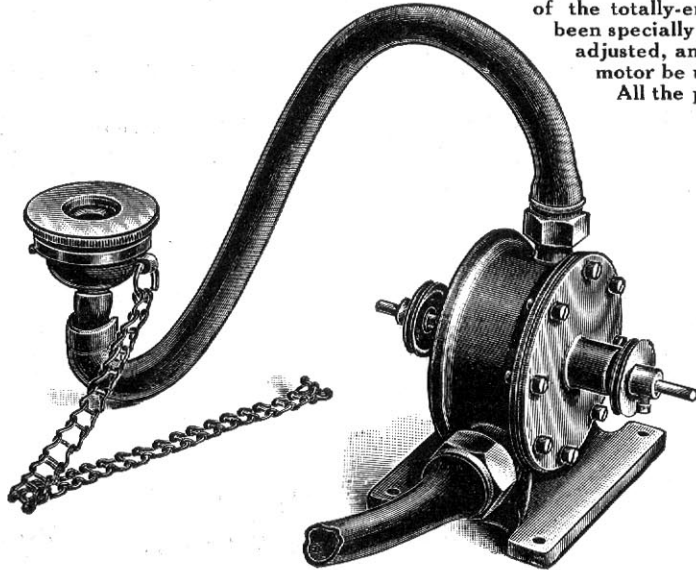

Price of either type .. 75/-

The **Meccano Water Motor** provides for the continuous working of models by the simple expedient of attaching it to any convenient water tap. It is an admirable substitute for the Meccano Electric Motor where electric current is not available. It is supplied with two tubes, one with an adaptor for attachment to the water tap, and the other to carry away the waste water. It is of one-sixtieth horse-power, at a pressure of 30lbs.

Meccano Water Motor, complete with tubes and fitting.

Price 16/6

Meccano Motors *(continued)*

The Meccano Spring Motors

The **Meccano Spring Motor** contains its own motive power in a simple and convenient form. It can be built into, and becomes part of, the model it drives.

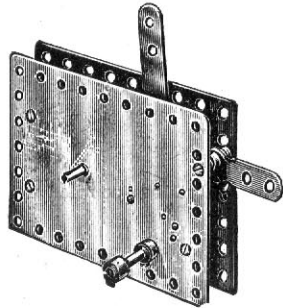

The No. 1 Meccano Spring Motor may be used in connection with Outfits Nos. 1 to 3. It has a stopping and starting motion, and the movement can be reversed.

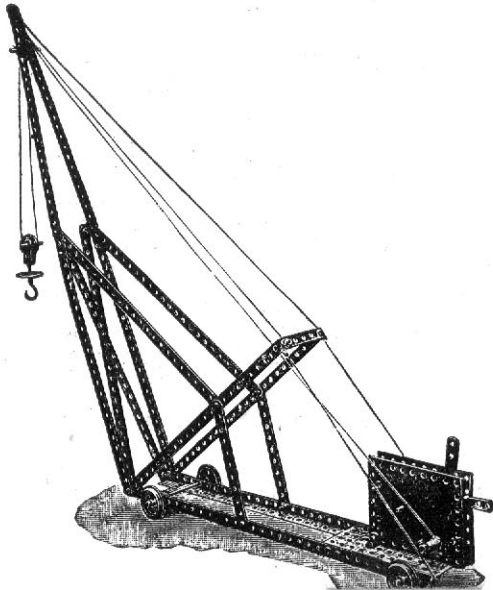

This illustration shows just how a No. 1 Meccano Motor is used in connection with a Travelling Jib Crane. Full instructions accompany each Motor, and there is no difficulty in using it.

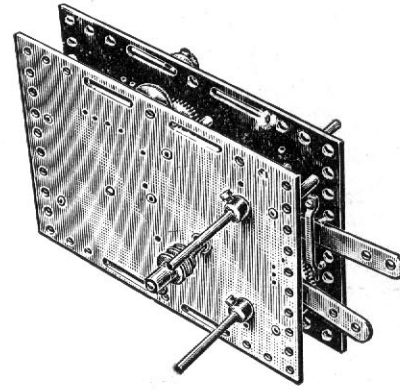

The No. 2 Meccano Spring Motor is suitable for driving models made with Outfits Nos. 4 to 6. There are three driving spindles, one of which has a clutch movement, and each can be worked independently. It has also a starting button and a reversing movement.

PRICES:

No. 1 Meccano Spring Motor ..	9/6
No. 2 " " " ..	28/6

Contents of Outfits

No.	DESCRIPTION OF PARTS.	0	0A	I	1A	2	2A	3	3A	4	4A	5	5A	6
1	12 ¹ / ₂ " Perforated Strips	—	4	4	6	10	—	10	4	14	—	14	34	48
2	5 ¹ / ₂ " " " "	4	—	6	10	16	2	18	4	22	4	14	34	60
3	3 ¹ / ₂ " " " "	—	1	1	1	—	4	6	—	6	11	17	10	36
4	2 ¹ / ₂ " " " "	—	—	—	—	—	2	2	—	4	4	8	16	24
5	2 ¹ / ₂ " " " "	9	—	9	3	12	—	12	8	20	24	44	4	48
6	2 ¹ / ₂ " " " "	—	—	—	—	—	—	—	—	6	6	18	18	24
8	12 ¹ / ₂ " Perforated Angle Girders	—	—	—	4	4	4	8	—	8	4	12	12	24
9	7 ¹ / ₂ " " " "	—	—	—	—	—	—	—	—	—	—	12	12	12
10	Flat Brackets	4	—	4	—	4	—	4	4	8	—	8	—	8
11	Double Brackets	—	1	1	—	4	—	4	4	4	—	4	4	16
12	Angle Brackets	8	4	12	3	12	12	24	12	36	17	53	67	120
13	11 ¹ / ₂ " Rods	—	—	—	—	—	—	—	—	—	—	—	2	4
13A	8 ¹ / ₂ " " " "	—	—	—	—	—	—	—	—	—	—	—	1	1
14	6 ¹ / ₂ " " " "	—	—	—	—	—	—	—	2	2	—	2	—	4
15	5 ¹ / ₂ " " " "	—	—	—	5	3	1	4	—	4	—	4	—	4
15A	4 ¹ / ₂ " " " "	2	1	3	—	3	—	3	3	3	—	3	—	4
16	3 ¹ / ₂ " " " "	—	—	—	1	1	1	2	2	4	—	4	—	5
17	2 ¹ / ₂ " " " "	—	—	2	—	2	—	2	2	4	—	4	—	4
19	Crank Handles	1	—	1	—	1	1	2	1	3	—	4	1	8
20	Flanged and Grooved Wheels	—	—	—	4	4	—	4	4	8	—	8	—	8
21	1 ¹ / ₂ " Pulley Wheels	—	—	—	—	—	1	1	1	1	1	2	—	2
22	1 ¹ / ₂ " " (fast)	4	—	4	—	4	—	4	4	4	—	4	—	4
22A	1 ¹ / ₂ " " (loose)	—	2	2	—	2	—	2	2	2	—	2	—	6
23	1 ¹ / ₂ " " " "	—	—	—	—	—	—	—	—	—	—	—	—	—
24	Bush Wheels	1	—	1	—	1	—	1	1	2	—	2	3	5
25	3 ¹ / ₂ " Pinion Wheels	—	—	—	—	—	1	1	1	2	—	2	—	3
26	1 ¹ / ₂ " " " "	—	—	—	—	—	2	2	—	2	—	2	—	2
27	Gear Wheels	—	—	—	—	—	1	1	1	1	—	2	—	2
28	1 ¹ / ₂ " Contrate Wheels	—	—	—	—	—	—	—	1	1	—	1	1	2
29	3 ¹ / ₂ " " " "	—	—	—	—	—	—	—	2	2	—	2	—	2
31	Worm Wheels	—	—	—	—	—	1	1	1	1	—	1	—	1
32	Pawl	—	—	—	—	—	2	2	2	2	—	2	—	2
33	Spanner	—	1	1	—	1	—	1	1	2	—	2	—	2
34	Spring Clips	4	2	0	—	6	6	12	6	18	—	18	6	24
35	Screwdriver	1	—	1	—	1	—	1	1	1	—	1	1	2
37	Nuts and Bolts	25	5	30	25	55	25	80	50	130	45	175	200	465
40	Hanks Cord	1	—	1	1	2	1	3	1	4	—	6	—	6
41	Propeller Blades	—	—	—	—	—	—	—	—	—	—	—	—	—
42	Chain	—	—	—	—	—	—	—	—	—	1	1	1	1
43	Springs	—	—	—	—	—	—	—	1	1	—	1	—	2
44	Cranked Bent Strip	1	—	1	—	1	—	1	1	1	—	2	—	2
45	Double Bent Strip	—	—	—	1	1	—	—	1	2	—	2	—	4
46	Large Bent Strip	—	—	—	—	—	—	—	1	1	2	3	1	2
51	Eye Pieces	—	—	—	—	—	—	—	—	—	—	—	1	1
52	Perforated Flanged Plates, 5 ¹ / ₂ " x 9 ¹ / ₂ "	1	—	1	—	1	1	2	1	2	2	4	4	8
53	" " " " " 3 ¹ / ₂ " x 2 ¹ / ₂ "	—	—	—	—	—	3	3	3	3	—	3	3	3
54	" " " " " Sector Plates	1	1	2	—	2	—	2	1	3	—	3	—	3
56	Manual of Instructions	1	1	1	—	1	—	1	1	1	—	1	—	2
57	Hook	1	—	1	—	1	—	1	—	1	—	1	—	1
58	Spring Cord	—	—	—	—	—	—	—	—	—	—	—	—	—
59	Collars and Set Screws	—	—	—	—	—	4	4	4	8	—	8	4	12
60	2 ¹ / ₂ " Bent Strips	1	3	4	—	6	—	6	2	8	1	9	7	16
61	Windmill Sails	—	—	—	4	4	—	4	—	4	—	4	—	4
62	Crank	—	—	—	—	2	—	2	—	2	—	2	—	2
63	Couplings	—	—	—	—	—	1	1	5	6	—	6	—	6
64	Funnels	—	—	—	—	2	—	2	—	—	—	2	—	2
65	Centre Fork	—	—	—	—	—	—	—	1	1	—	1	—	1

Price List

No. 0.	Meccano Outfit	5/-	
No. 1.	”	”	8/6	
No. 2.	”	”	16/6	
No. 3.	”	”	25/-	
No. 4.	”	”	40/-	
No. 5.	”	”	Packed in neat and well-made cardboard box			70/-	
Do.	”	Presentation Outfit							90/-	
No. 6.	”	”	”	”	Packed in well-made walnut stained box with lock and key			160/-		
					Ditto	ditto	ditto			
<hr/>										
No. 0A.	Meccano Accessory Outfit	(containing sufficient parts to convert a Meccano No. 0 Outfit into a No. 1)							4/6	
No. 1A.	”	”	”	(containing sufficient parts to convert a No. 1 Outfit into a No. 2)					9/6	
No. 2A.	”	”	”	(containing sufficient parts to convert a No. 2 Outfit into a No. 3)					10/6	
No. 3A.	”	”	”	(containing sufficient parts to convert a No. 3 Outfit into a No. 4)					18/6	
No. 4A.	”	”	”	(containing sufficient parts to convert a No. 4 Outfit into a No. 5)					24/-	
No. 5A.	”	”	”	Packed in neat and well-made cardboard box						58/6
				Packed in well made walnut stained box with lock and key						58/6
Do.	”	”	”	(containing sufficient parts to convert a No. 5 Outfit into a No. 6)					58/6	
				Packed in neat and well-made cardboard box						82/6
				Packed in superior oak cabinet with lock and key						82/6



Meccano Outfits, Motors and Parts.

REVISED PRICES.

MECCANO OUTFITS.

No.					s.	d.
0.	6	0
1.	10	0
2.	20	0
3.	30	0
4.	50	0
5.	Carton	84	0
5.	Wood	110	0
6.	200	0

ACCESSORY OUTFITS.

0A.	5	6
1A.	11	0
2A.	12	0
3A.	22	0
4A.	28	0
5A.	Carton	70	0
5A.	Wood	100	0

MECCANO MOTORS.

Spring Motor	10	0
Electric Motor	13	6
"	20	0

MECCANO OUTFITS WITH ELECTRIC MOTORS.

1x.	Outfit	22	6
2x.	"	32	6
3x.	"	48	0

MECCANO PARTS.

No.					s.	d.
1.	Perforated Strips,	12 $\frac{1}{2}$ " long	$\frac{1}{2}$ doz.	..	1	6
2.	"	5 $\frac{1}{2}$ "	"	"	0	8
3.	"	3 $\frac{1}{2}$ "	"	"	0	6
4.	"	3	"	"	0	6
5.	"	2 $\frac{1}{2}$ "	"	"	0	6
6.	"	2	"	"	0	6
8.	Angle Girders	12 $\frac{1}{2}$ " long	$\frac{1}{2}$ doz.	..	2	0
9.	"	5 $\frac{1}{2}$ "	"	"	1	0
10.	Flat Brackets	0	4
11.	Double Brackets	0	2
12.	Angle Brackets	..	per doz.	..	1	0
13.	Axle Rods,	11 $\frac{1}{2}$ " long	0	6
13A.	"	8"	0	6
14.	"	6"	0	4
15.	"	5"	0	4
15A.	"	4 $\frac{1}{2}$ "	0	4
16.	"	3 $\frac{1}{2}$ "	0	2
17.	"	2"	0	2
18A.	"	1"	0	2
19.	"	0	6
19A.	Wheels,	3in. diam.	0	6
20.	Flanged and Grooved Wheels	1	6
20A.	Pulley	2" dia., with set screw	each	..	0	6
21.	"	1 $\frac{1}{2}$ "	"	"	1	0
22.	"	1"	"	"	0	8
22A.	"	1"	without	"	0	4
23.	"	$\frac{3}{4}$ "	"	"	0	4
23A.	"	$\frac{1}{2}$ "	with	"	0	8
24.	Bush Wheels	1	0
25.	Pinion Wheels,	$\frac{3}{4}$ " diam.	1	6
26.	"	$\frac{1}{2}$ "	1	0
27.	50 teeth to gear with	$\frac{3}{4}$ " pinion,	1	8
27A.	56	"	"	"	2	0
28.	Contrate Wheels,	1 $\frac{1}{2}$ " diam.	2	6
29.	"	$\frac{3}{4}$ "	2	0
32.	Worm Wheels	1	6

No.					s.	d.	
33.	Pawls	each	0	6	
34.	Spanners	0	6	
35.	Spring Clips	..	per box of doz.	..	1	0	
36.	Screw Drivers	each	0	6	
37.	Nuts and Bolts	..	per box of doz.	..	1	0	
37A.	Nuts	..	"	"	0	4	
38.	Washers	doz.	0	4	
40.	Hanks of Cord	each	0	2	
41.	Propeller Blades	..	per pair	..	1	0	
43.	Springs	each	0	4	
44.	Cranked Bent Strips	0	4	
45.	Double Bent Strips	0	4	
46.	Large Bent Strips	0	6	
50.	Eye Pieces	0	4	
52.	Perforated Flanged Plates,	5 $\frac{1}{2}$ " by	
		2 $\frac{1}{2}$ "	each	0	8
53.	Perforated Flanged Plates,	3 $\frac{1}{2}$ " by	
		2 $\frac{1}{2}$ "	each	0	6
54.	Perforated Sector Plates	0	6	
56.	Instruction Manuals	1	6	
57.	Hooks	each	0	2	
58.	Spring Cords,	40" long	1	6	
59.	Collars and Set Screws	each	0	4	
60.	Bent Strips,	2 $\frac{1}{2}$ "	per $\frac{1}{2}$ doz.	..	1	0	
61.	Windmill Sails	each	0	4	
62.	Cranks	0	8	
63.	Couplings	0	9	
64.	Ship's Funnels	0	2	
65.	Centre Forks	0	2	
94.	Sprocket Chains	..	per length	..	1	0	
95.	Sprocket Wheels	..	2" diam.	..	1	0	
96.	"	..	1"	..	0	8	
99.	Girder Strips,	12 $\frac{1}{2}$ " long,	$\frac{1}{2}$ doz.	..	3	0	
100.	Girder Strips,	5 $\frac{1}{2}$ " long,	$\frac{1}{2}$ doz.	..	2	0	
101.	Healds, for Looms	..	per doz.	..	1	6	