

# MECCANO



SUPPLEMENTARY  
MANUAL OF INSTRUCTIONS

MANUAL D'INSTRUCTIONS  
SUPPLÉMENTAIRES

Price  
Prix 6d.

No. 14 S.  
PRINTED IN ENGLAND  
IMPRIMÉ EN ANGLETERRE

MECCANO LIMITED, LIVERPOOL, ENG.

COPYRIGHT 1916  
MECCANO LTD.  
DEPOSÉ 1916

### Buffers—Tampons

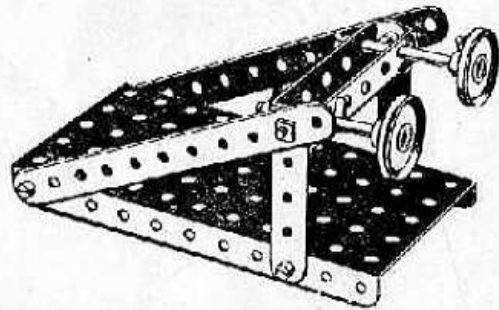

2 No. 2	4 No. 35
2 " 5	6 " 37
2 " 17	1 " 52
2 " 22	2 " 60

### Torpedo Destroyer Contre-Torpilleur

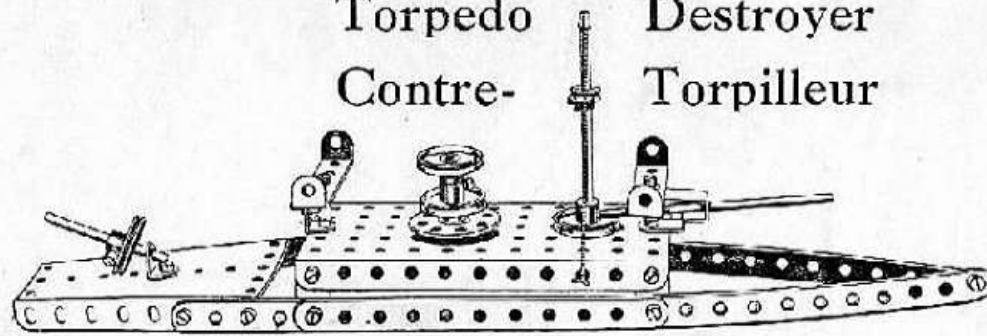

4 No. 2	1 No. 17	19 No. 37
2 " 5	4 " 22	1 " 44
4 " 10	1 " 23	1 " 52
1 " 11	1 " 24	1 " 54
1 " 12	3 " 35	2 " 60
2 " 15A		

### Scales—Balance

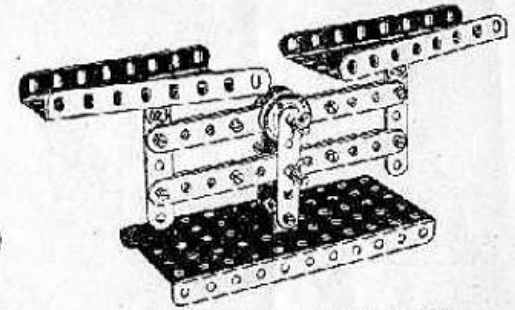

4 No. 2	2 No. 22A
8 " 5	4 " 35
1 " 11	19 " 37
2 " 12	1 " 52
2 " 17	2 " 54

### Metal Saw Scie à Métaux

4 No. 2	1 No. 19
5 " 5	2 " 22
1 " 10	1 " 24
8 " 12	2 " 35
1 " 17	23 " 37
	1 No. 52
	2 " 60

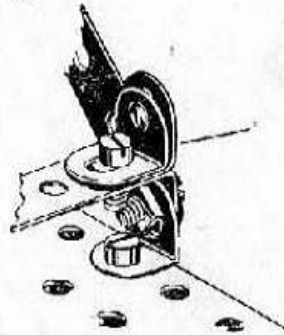
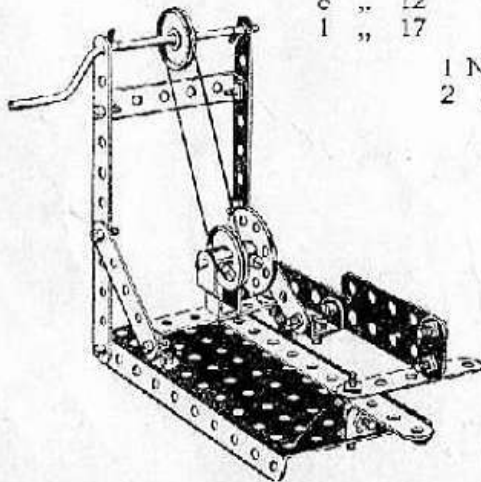

### Anchor Ancre

2 No. 2
3 " 5
4 " 10
4 " 12
11 " 37
1 " 57

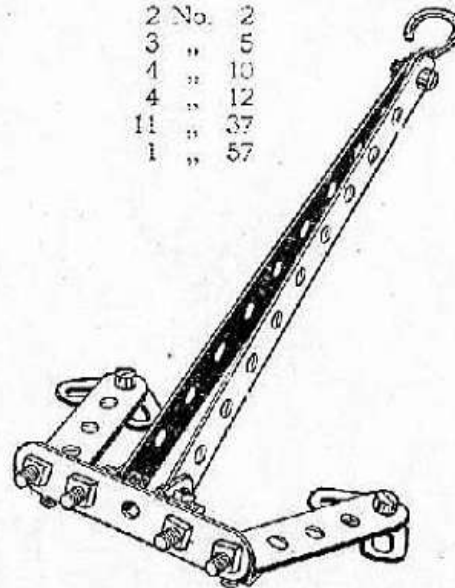

### Stamping Machine Machine à Estamper

4 No. 2
8 " 5
2 " 12
2 " 15A
1 " 19
4 " 22
1 " 24
3 " 35
20 " 37
1 " 52
2 " 60

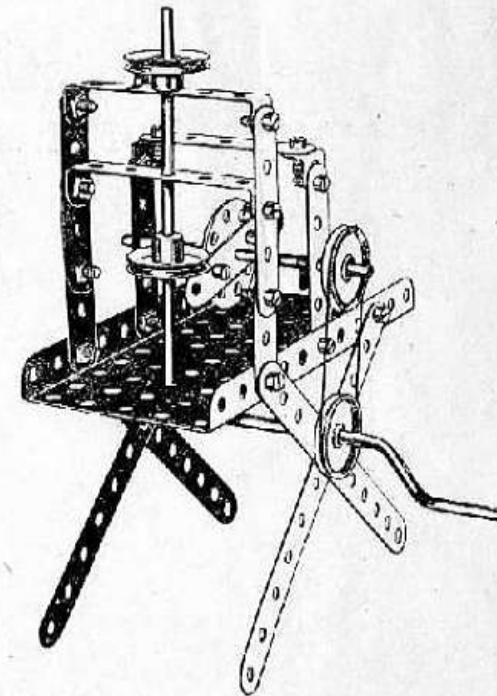

### Sharpshooter Gun Canon de Précision

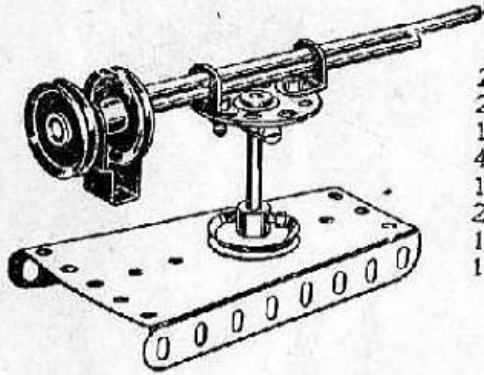

- 2 No. 12
- 2 " 15A
- 1 " 17
- 4 " 22
- 1 " 24
- 2 " 37
- 1 " 44
- 1 " 54

### Spinning Top Devidoir à Fil

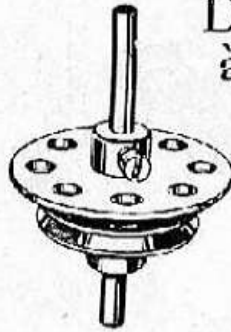

- 1 No. 17
- 1 " 22
- 1 " 24

### Roulette Wheel Roulette

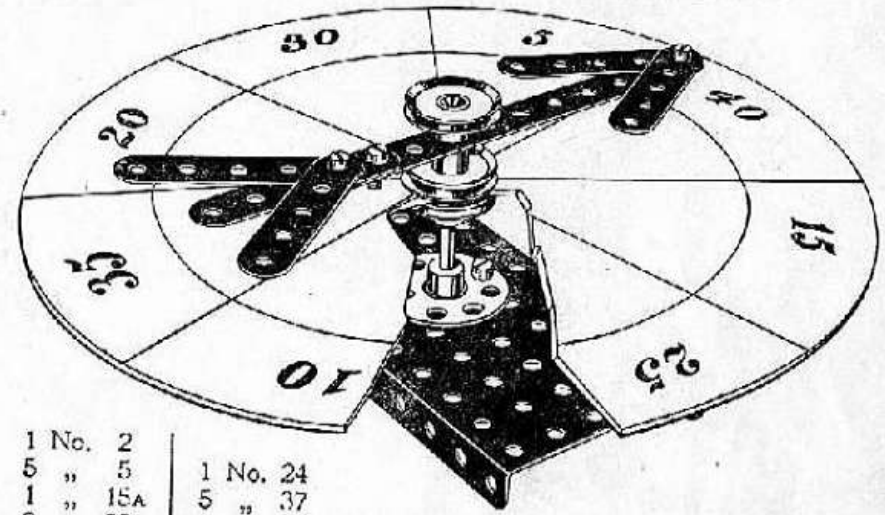

- |         |          |
|---------|----------|
| 1 No. 2 | 1 No. 24 |
| 5 " 5   | 5 " 37   |
| 1 " 15A | 1 " 52   |
| 3 " 22  |          |

### Anti-Aircraft Gun Canon Anti Avion

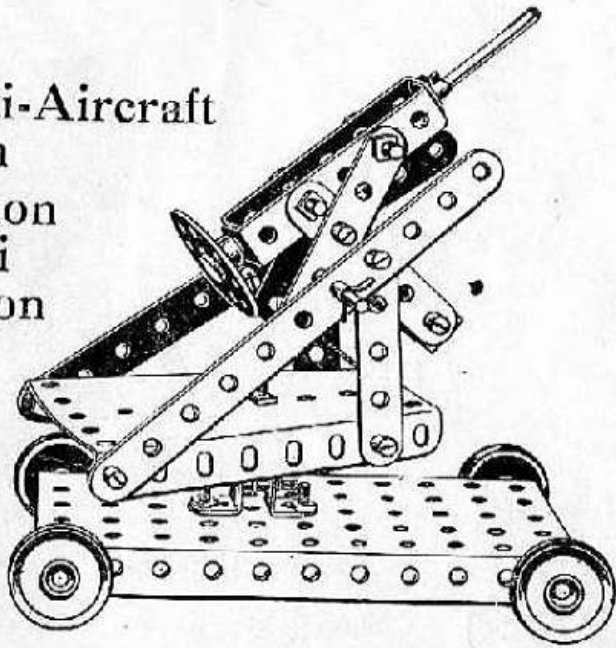

- |         |          |          |
|---------|----------|----------|
| 2 No. 2 | 4 No. 22 | 1 No. 44 |
| 6 " 5   | 1 " 24   | 1 " 52   |
| 4 " 12  | 5 " 35   | 1 " 54   |
| 2 " 15A | 23 " 37  | 2 " 60   |

### Band Saw Scie à Ruban

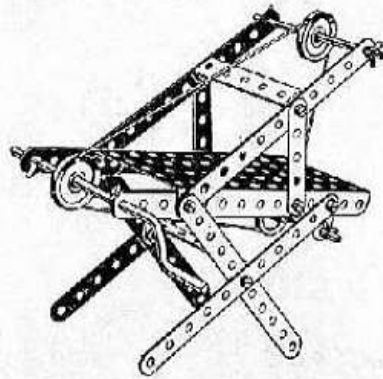

- |         |          |
|---------|----------|
| 6 No. 2 | 3 No. 22 |
| 4 " 5   | 6 " 35   |
| 2 " 10  | 10 " 37  |
| 2 " 15A | 1 " 52   |
| 1 " 19  | 2 " 60   |

### Punching Machine Emporte Pièce

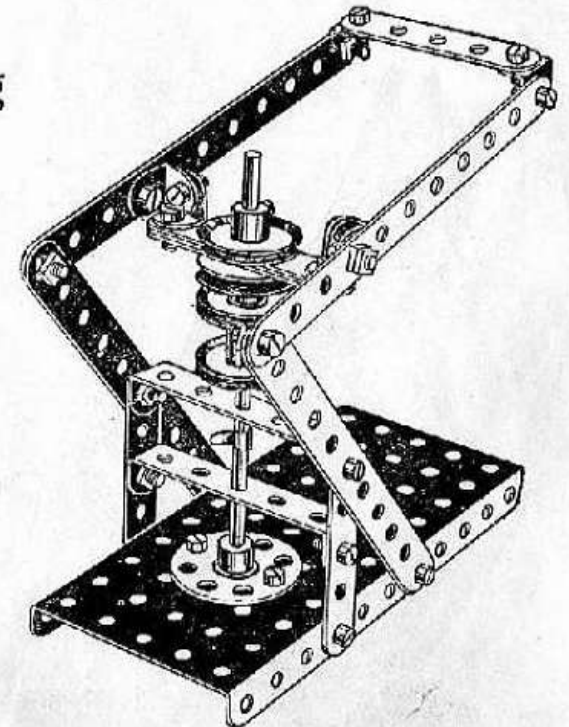

- 4 No. 2
- 7 " 5
- 6 " 12
- 1 " 15A
- 4 " 22
- 1 " 24
- 1 " 35
- 22 " 37
- 1 " 52
- 2 " 60

### Timber Drag Triqueballe

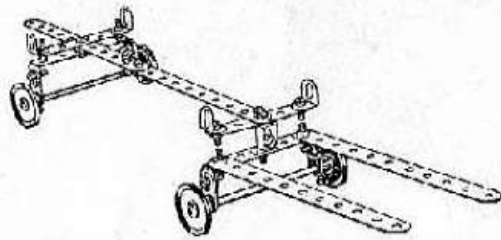

4 No. 2	4 No. 22
4 " 10	18 " 37
6 " 12	3 " 60
2 " 15A	

### Steering Truck Truck sur Essieux Mobiles

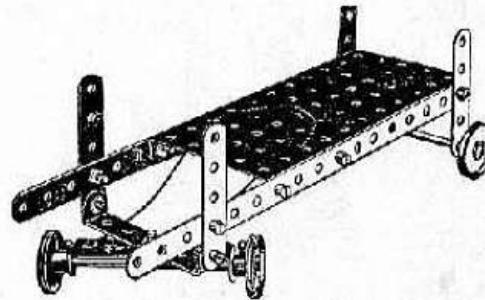

2 No. 2	11 No. 37
4 " 5	1 " 52
2 " 15A	2 " 60
4 No. 22	

### Boiler Truck Truck pour Chaudières

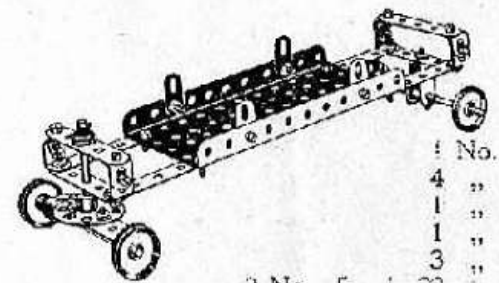

	1 No. 17
4 " 22	1 " 23
1 " 24	3 " 35
8 No. 5	23 " 37
4 " 10	1 " 44
8 " 12	1 " 52
2 " 15A	1 " 60

### Rocking Chair

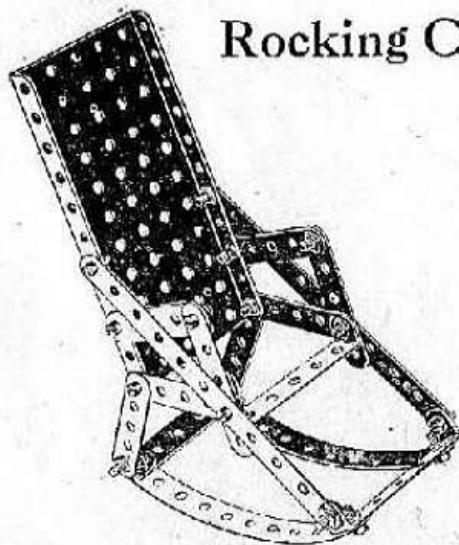

4 No. 2	18 No. 37
9 " 5	1 " 52
2 " 12	1 " 60

### Lurry—Wagonnette

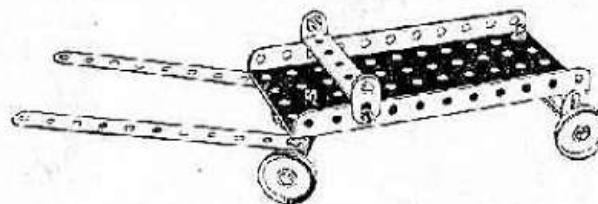

2 No. 2	13 No. 37
4 " 10	1 " 24
2 " 12	1 " 52
2 " 15A	2 " 60
4 No. 22	

### Telegraph Code Key Clavier de Code Télégraphique

3 No. 2	1 No. 22
1 " 10	12 " 37
5 " 12	1 " 52

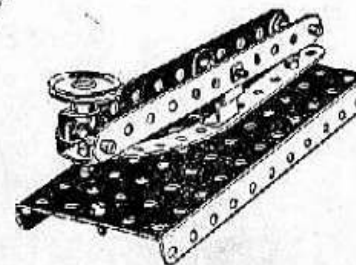

### Watch Stand Porte-Montre

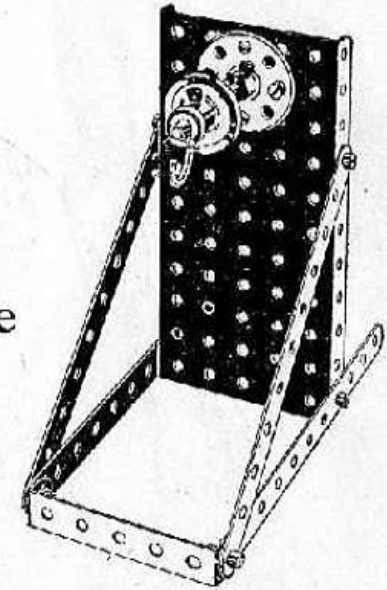

4 No. 2	1 No. 35
1 " 17	8 " 37
1 " 22	1 " 52
1 " 23	1 " 57
1 " 24	1 " 60

Drop Hammer  
Marteau à Déclic

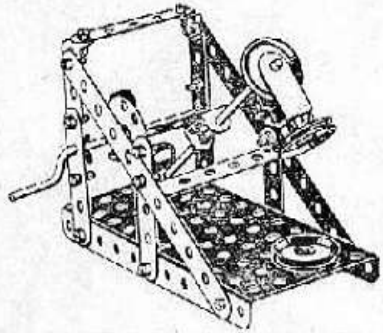

2 No.	2	3 No.	22
7 "	5	1 "	24
6 "	12	23 "	37
1 "	15A	1 "	44
1 "	19	1 "	52
	2 No.		60

Furrowing Roller  
Sillonneuse

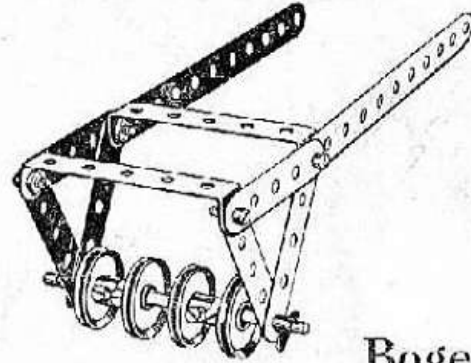

Bogey Truck  
Truck à Bogie

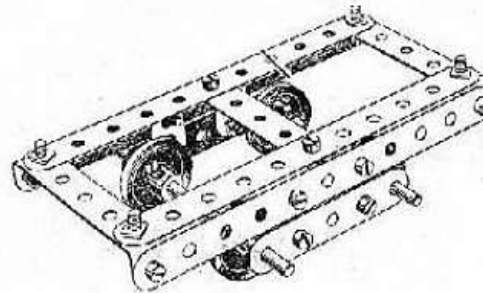

4 No.	2	4 No.	22
3 "	5	18 "	37
4 "	10	2 "	60
2 "	15A		

Hay Tedder  
Petite Faneuse

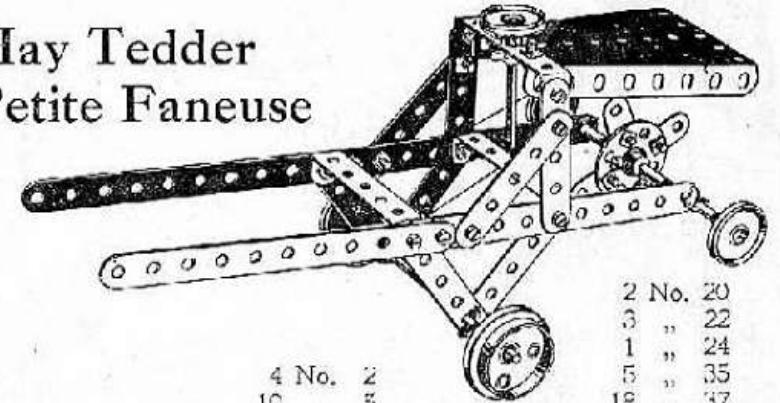

4 No.	2
10 "	5
2 "	15A
1 "	17

2 No.	20
3 "	22
1 "	24
5 "	35
18 "	37
1 "	54
3 "	60

Sleigh—Traineau

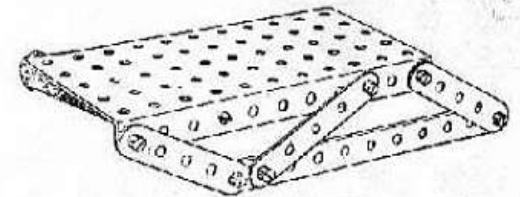

2 No.	2
6 "	5
12 "	37
1 "	52

Double-Drop Hammer

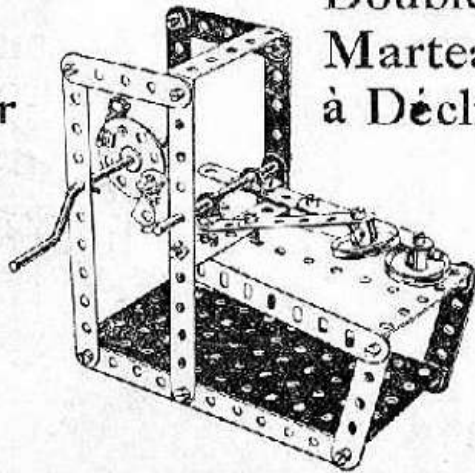

Double-Marteau à Déclic

4 No.	2	1 No.	19	22 No.	37
8 "	5	2 "	22	1 "	52
8 "	12	1 "	24	1 "	54
1 "	15A	4 "	35	2 "	60

Ticca Gharry  
Pousse-Pousse Indien

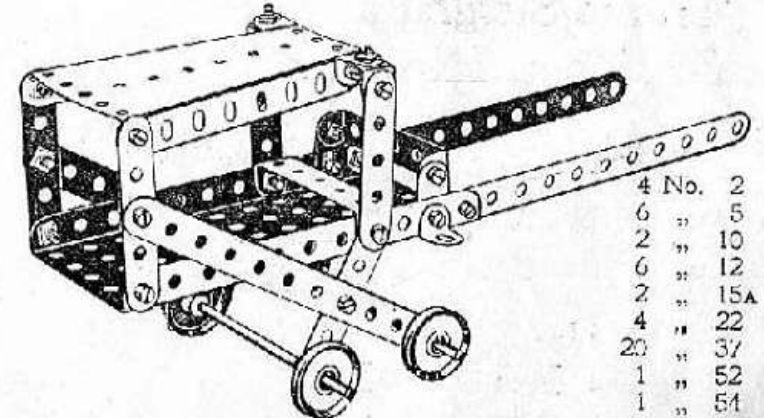

1 No.	2
2 "	5
6 "	37
2 "	60

4 No.	2
6 "	5
2 "	10
6 "	12
2 "	15A
4 "	22
20 "	37
1 "	52
1 "	54
2 "	60

Grill—Gril

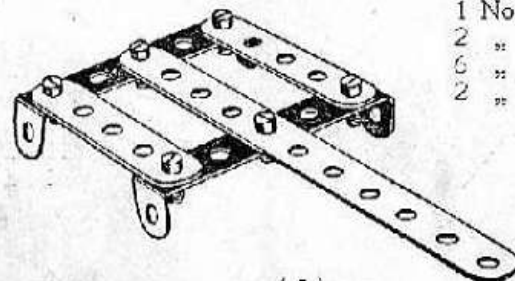

# Gong

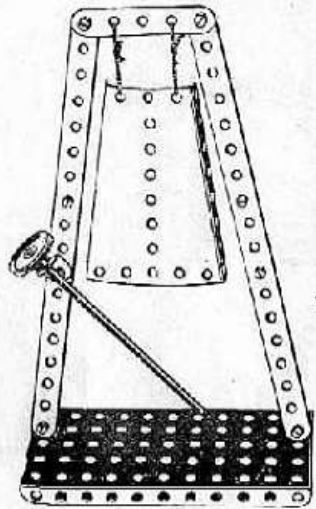

2	No.	2
1	"	5
3	"	12
1	"	15A
1	"	22
10	"	37
1	"	52
1	"	54

# Invalid Chair Chaise de Malade



4	No.	2	22	No.	37
8	"	5	1	"	52
2	"	10	1	"	54
2	"	15A	2	"	60
4	"	22			

# Deck Chair Chaise de Pont

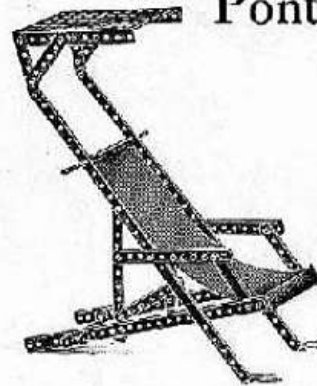

4	No.	1	1	No.	15A
4	"	2	30	"	37
1	"	3	1	"	52
6	"	5	2	"	60
6	"	12			

# Rock Drill Foret à Roc

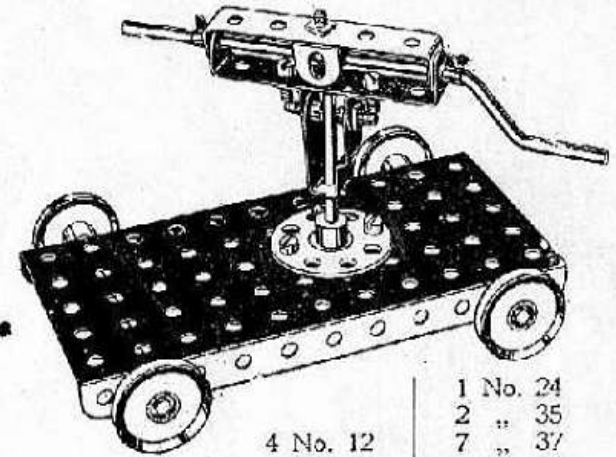

		1	No.	24
		2	"	35
4	No.	7	"	37
1	"	1	"	44
1	"	1	"	52
4	"	2	"	60

# Hatchet Hachette

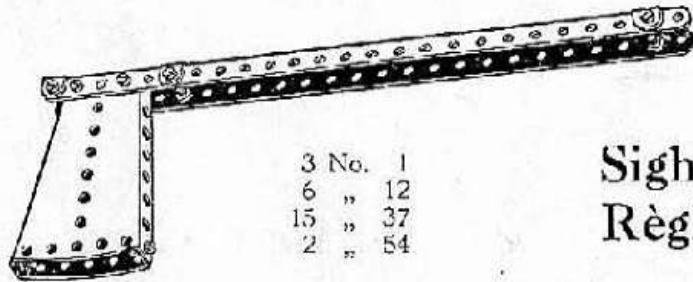

3	No.	1
6	"	12
15	"	37
2	"	54

# Sighting Rule Règle-Mireuse

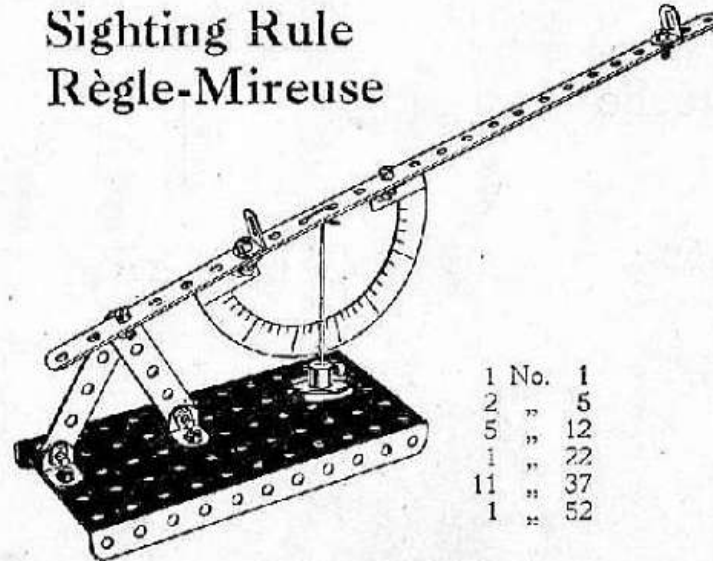

1	No.	1
2	"	5
5	"	12
1	"	22
11	"	37
1	"	52

# Horse Sleigh Traineau Hippomobile

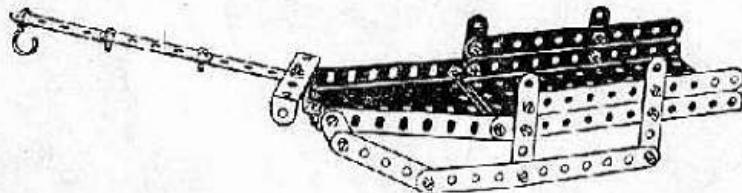

4	No.	2	25	No.	37
9	"	5	1	"	52
4	"	10	1	"	54
2	"	12	1	"	57

# Motor Van Tapissière Automobile

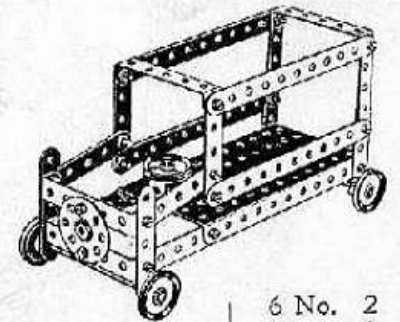

		6	No.	2
		1	"	3
		9	"	5
2	No.	1	"	11
4	"	22	"	37
1	"	22A	"	52
1	"	24	"	60

Invalid Chair  
Chaise  
d'Invalide

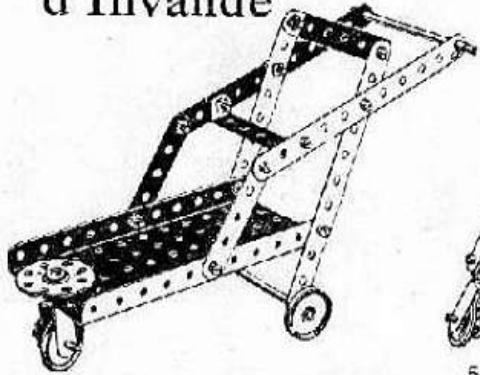

4 No. 2	1 No. 24
2 " 5	2 " 35
2 " 15A	13 " 37
1 " 18	1 " 44
3 " 22	2 " 60

Foot Cycle  
Patinette

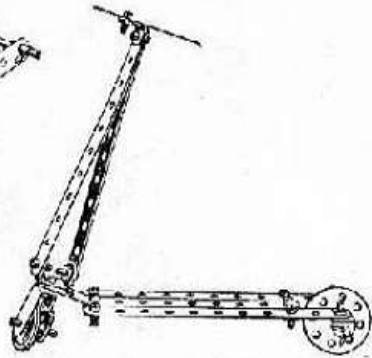

5 No. 2	1 No. 22
1 " 5	1 " 24
4 " 10	4 " 35
1 " 11	15 " 37
3 " 12	1 " 44
2 " 17	

Coster's Barrow  
Voiture-  
Fruitière

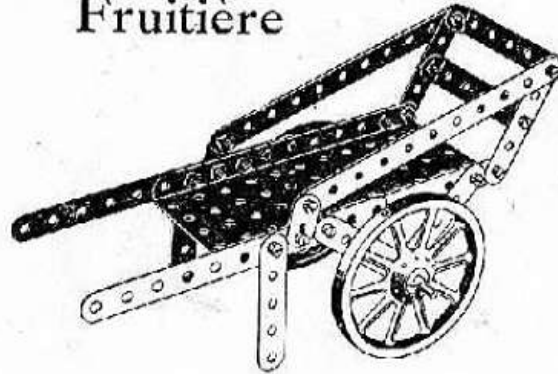

4 No. 2	4 No. 35
8 " 5	16 " 37
2 " 10	1 " 52
1 " 15A	2 " 60
2 " 19A	

Cart  
Charrette

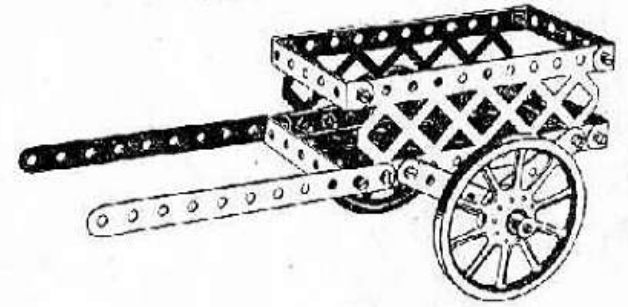

4 No. 2	2 No. 22	2 No. 59
4 " 5	15 " 37	4 " 60
1 " 15	1 " 44	2 " 100
2 " 19A	1 " 52	

Mail Bag  
Hanger  
Porte-  
manteau

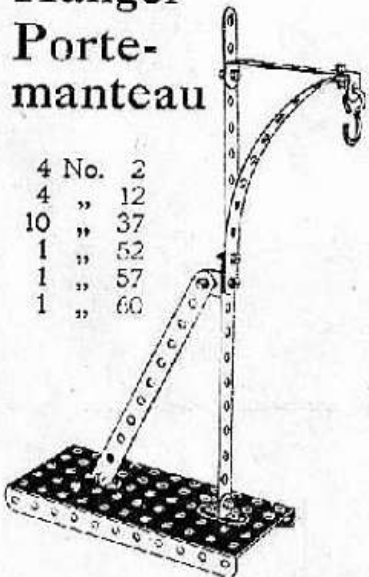

4 No. 2
4 " 12
10 " 37
1 " 52
1 " 57
1 " 60

Bed Table  
Somno

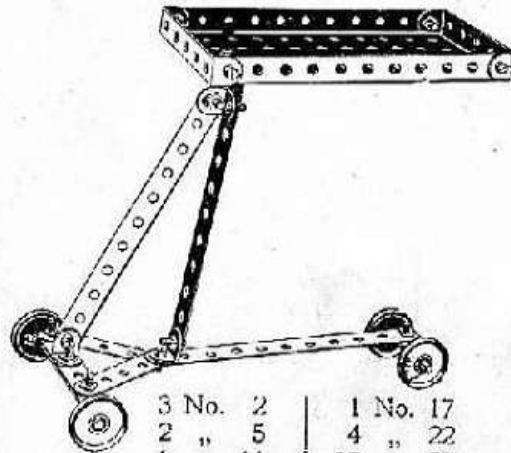

3 No. 2	1 No. 17
2 " 5	4 " 22
1 " 11	15 " 37
4 " 12	1 " 52
1 " 15A	3 " 60

Motor Lurry  
Wagonette  
Automobile

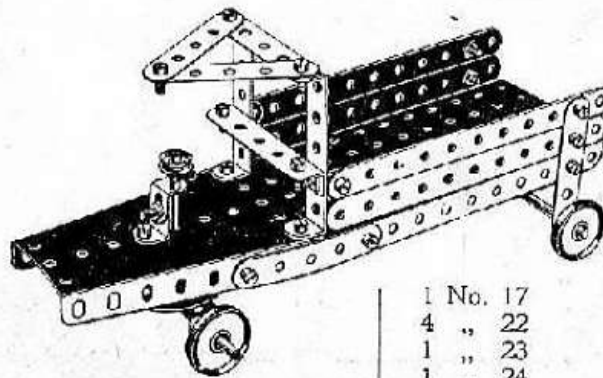

	1 No. 17
	4 " 22
	1 " 23
	1 " 24
	2 " 35
	25 " 37
4 No. 2	1 " 52
8 " 5	1 " 54
8 " 12	2 " 60
2 " 15A	

Forge Bellows  
Forge à  
Soufflets

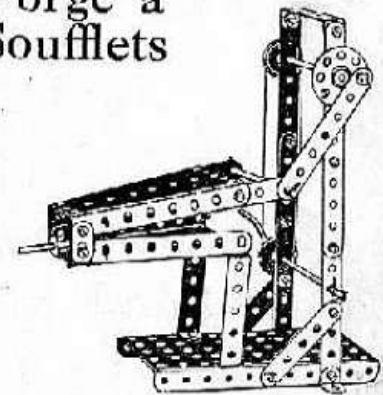

4 No. 2	1 No. 19
1 " 3	2 " 22
2 " 5	1 " 24
2 " 10	5 " 35
1 " 11	25 " 37
2 " 12	1 " 52
2 " 15A	2 " 54
1 " 17	3 " 60

Jib Crane  
Grue à Flèche

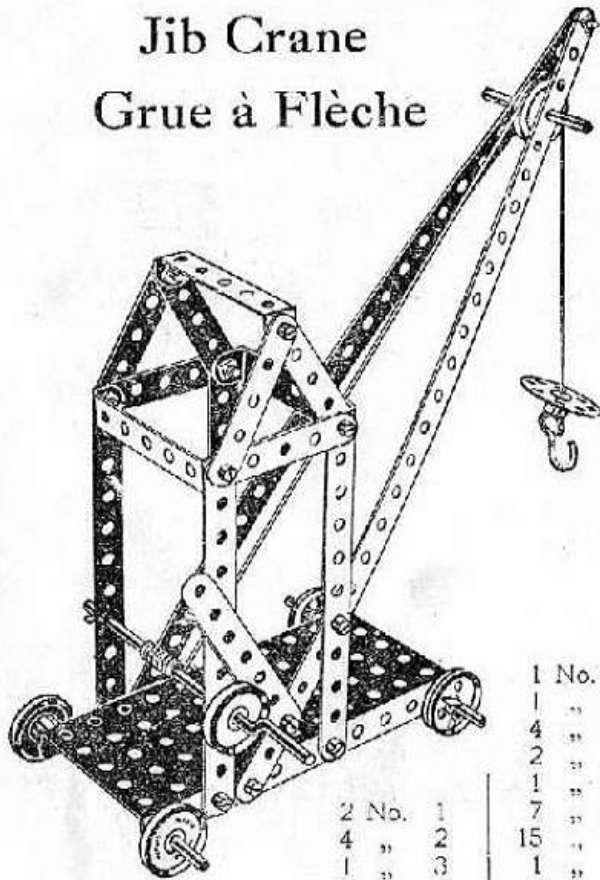

2 No.	1	1 No.	17
4 "	2	1 "	19
1 "	3	4 "	22
6 "	5	2 "	22A
2 "	15A	1 "	24
		7 "	35
		15 "	37
		1 "	52
		1 "	57
		3 "	60

Mountain Transport  
Transport de Montagne

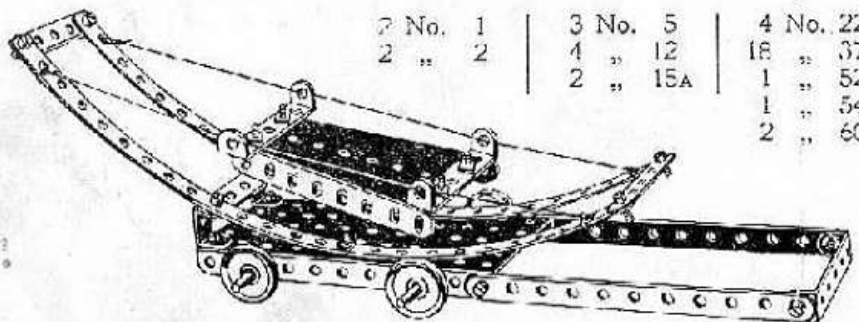

2 No.	1	3 No.	5	4 No.	22
2 "	2	4 "	12	18 "	37
		2 "	15A	1 "	52
				1 "	54
				2 "	60

Lawn Mower  
Tondeuse à Gazon

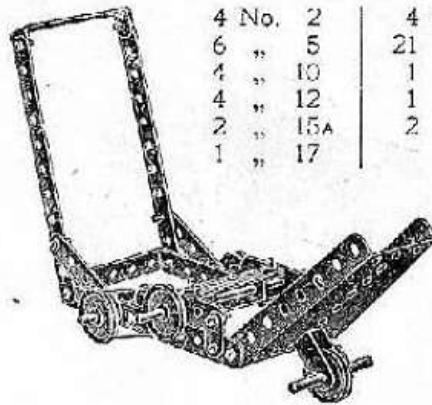

4 No.	2	4 No.	22
6 "	5	21 "	37
4 "	10	1 "	44
4 "	12	1 "	54
2 "	15A	2 "	60
1 "	17		

Music Stand  
Pupitre à Musique

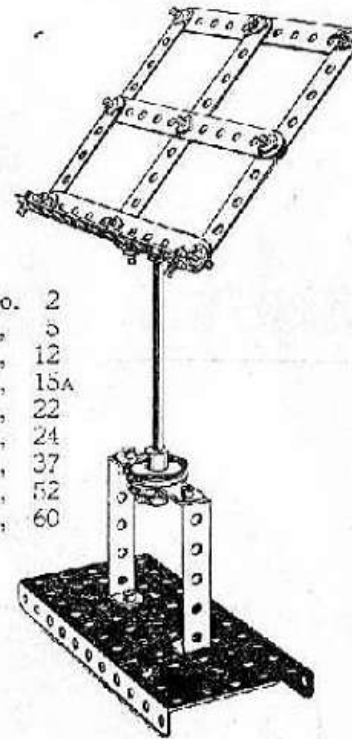

4 No.	2
7 "	5
3 "	12
1 "	15A
2 "	22
1 "	24
16 "	37
1 "	52
2 "	60

Maize Sheller  
Décortiqueuse

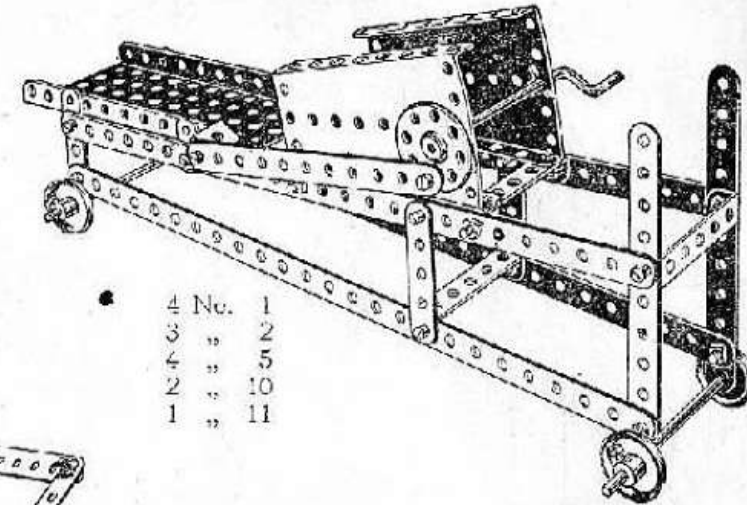

4 No.	1
3 "	2
4 "	5
2 "	10
1 "	11

2 No.	15	26 No.	37
1 "	19	1 "	52
4 "	22	2 "	54
1 "	24	4 "	60
2 "	35		

Devil Wall  
Pare-Balles

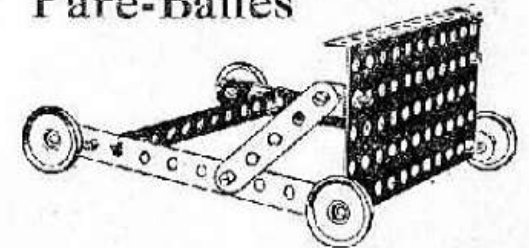

3 No.	2	4 No.	22
2 "	5	18 "	37
6 "	12	1 "	52



## Mechanical Hammers Marteaux Mécaniques

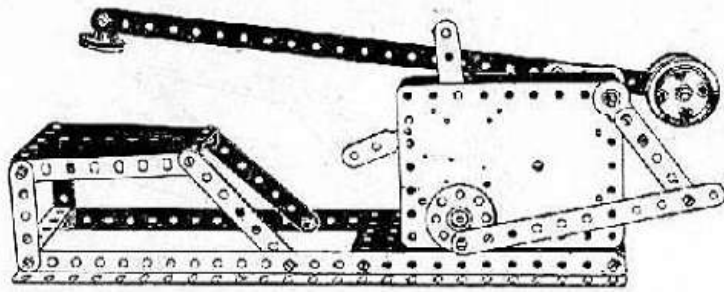

1 No.	1	4 No.	12	26 No.	37
1 "	2	1 "	17	1 "	52
2 "	3	2 "	20	1 "	54
2 "	5	1 "	22	1 "	60
2 "	8	1 "	24	2 "	62

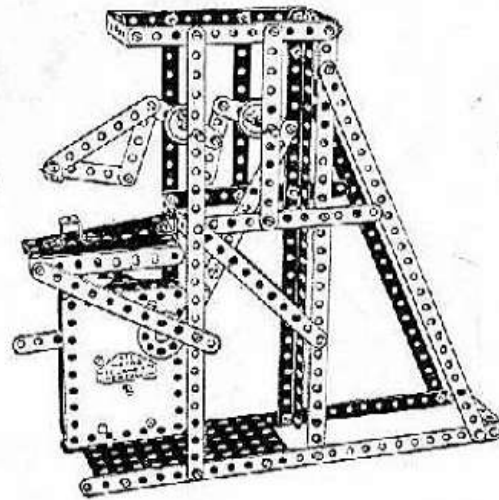

6 No.	1
11 "	2
1 "	3
7 "	5
2 "	8
3 "	12
2 "	15A
4 "	22
1 "	24
4 "	35
48 "	37
1 "	45
1 "	52
1 "	54
2 "	60

## Baby Chair Chaise d'Enfant

8 No.	2
2 "	3
10 "	5
6 "	12
2 "	17
4 "	22
32 "	37
6 "	60

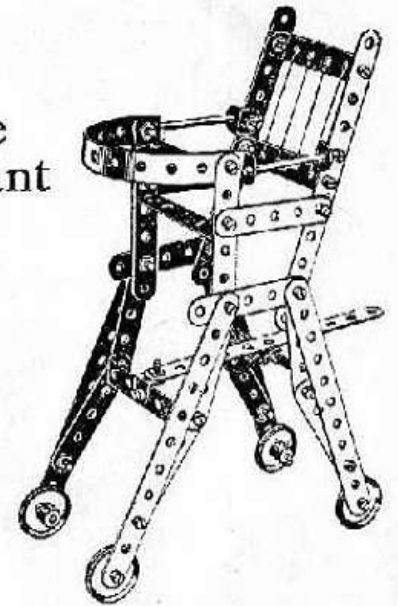

## Needlework Basket Travaillusc

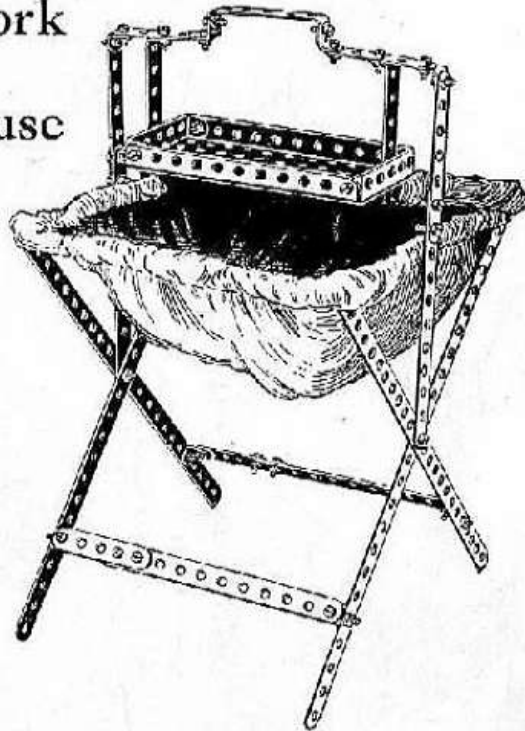

4 No.	1
6 "	2
2 "	3
6 "	5
12 "	12
46 "	37
1 "	52
3 "	60

## Candy Puller Etireuse de Pâte de Guimauve

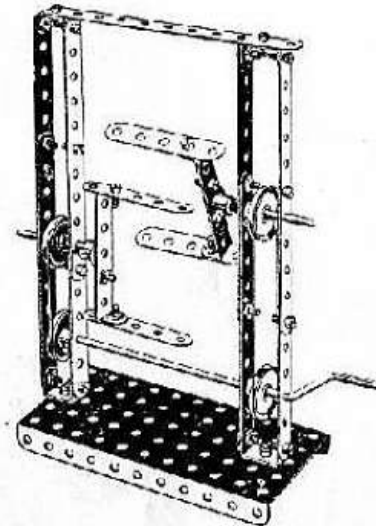

9 No.	2
4 "	5
4 "	11
2 "	17
1 "	19
4 "	22
2 "	35
26 "	37
1 "	52
2 "	60
2 "	62

## Try-your-Strength Machine Enregistreur de Force Musculaire

2 No.	1
3 "	2
2 "	5
2 "	8
4 "	12
1 "	16
2 "	17
1 "	18
4 "	22
1 "	24
29 "	37
1 "	44
1 "	45
1 "	52
1 "	54
4 "	60
1 "	62

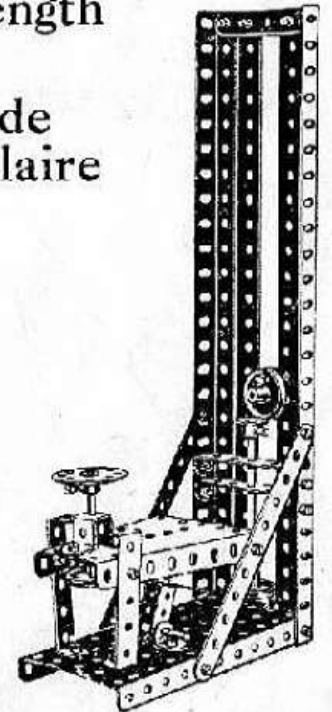

# Designing Machine Machine à Dessiner

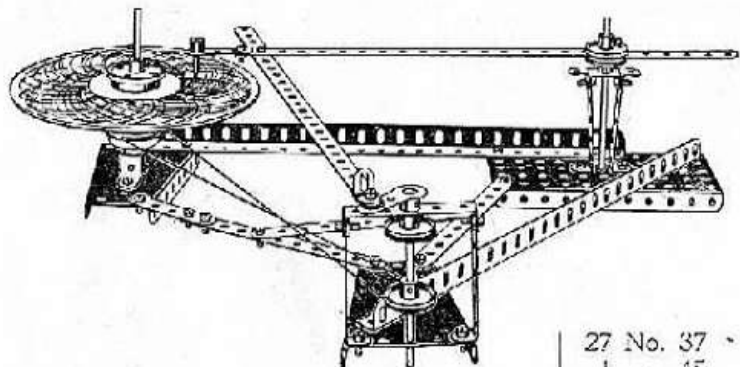

2 No. 1	1 No. 12	4 No. 22	27 No. 37
3 " 2	2 " 15A	1 " 24	1 " 45
2 " 8	1 " 16	1 " 35	1 " 52
1 " 11	1 " 20		2 " 54
			5 " 60
			2 " 62

# Crossbow—Arbalète

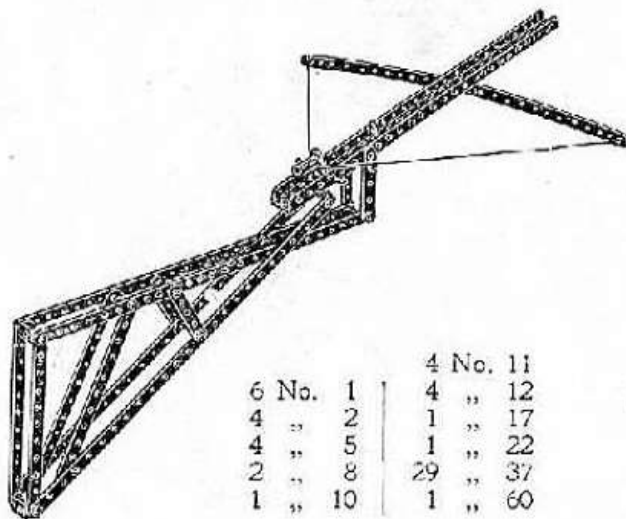

6 No. 1	4 No. 11
4 " 2	4 " 12
4 " 5	1 " 17
2 " 8	1 " 22
1 " 10	29 " 37
	1 " 60

# Lathe—Tour

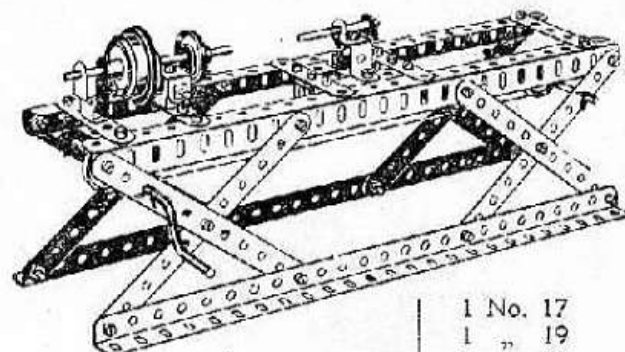

8 No. 2	4 No. 8	1 No. 17
7 " 5	3 " 11	1 " 19
	4 " 12	1 " 20
	1 " 15A	4 " 22
	1 " 16	6 " 35
		41 " 37
		1 " 44
		1 " 45

# Dwarf Derrick

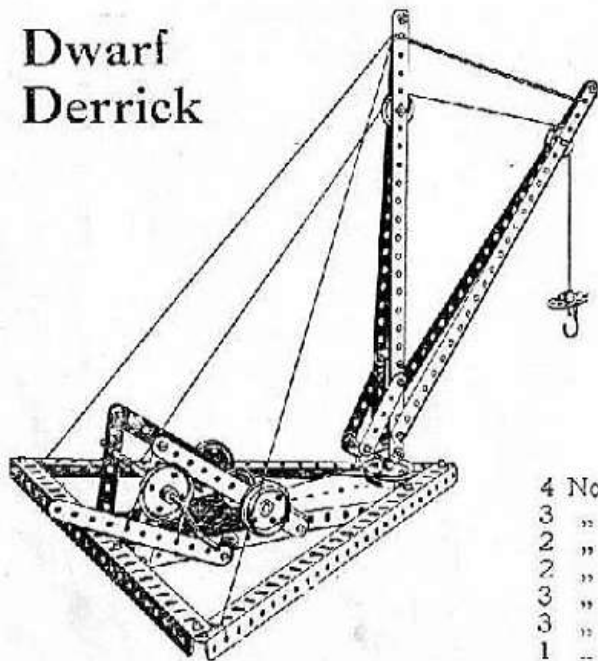

4 No. 1	1 No. 19
3 " 2	4 " 20
2 " 3	2 " 22
2 " 5	2 " 22A
3 " 8	1 " 23
3 " 11	1 " 24
1 " 15A	4 " 35
1 " 17	39 " 37
	1 " 45
	1 " 52
	1 " 54
	1 " 57
	1 " 62

# Derrick Nain

# Potato Reaper Recolteuse de Patates

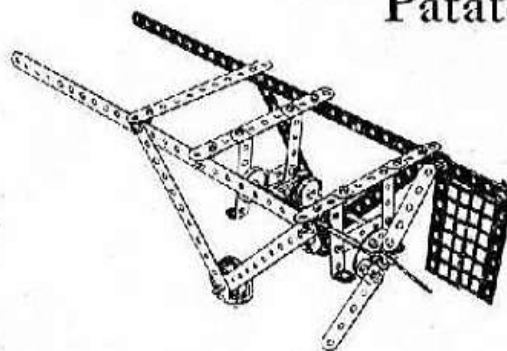

2 No. 1	1 No. 15A	5 No. 35
8 " 2	2 " 20	31 " 37
4 " 5	2 " 22	4 " 60
10 " 12	2 " 22A	2 " 61
2 " 15	1 " 24	

# Embossing Machine Machine à Gaufrer

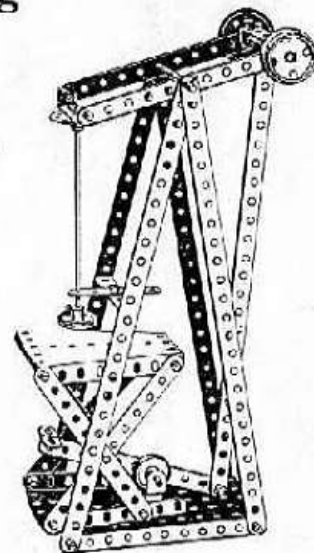

5 No. 1
7 " 2
1 " 5
1 " 15
2 " 15A
1 " 18
2 " 20
2 " 22
1 " 24
4 " 35
23 " 37
1 " 44
1 " 52
2 " 54
3 " 60

Gong

6	No.	1
4	"	2
2	"	5
2	"	8
2	"	11
1	"	15
1	"	22
27	"	37
1	"	54

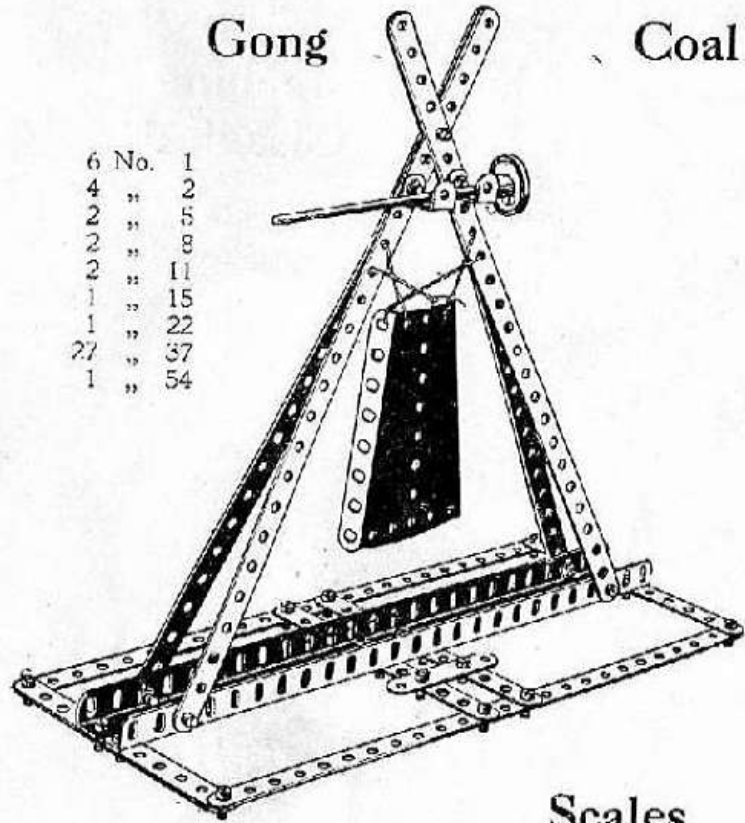

Coal Shaker

Cribleur à Charbon

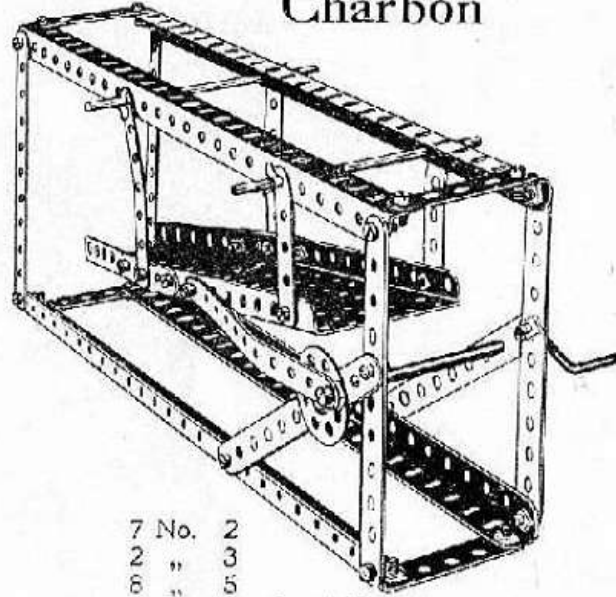

7	No.	2	5	No.	35
2	"	3	30	"	37
6	"	5	1	"	52
4	"	8	1	"	54
2	"	15A			
1	"	19			
1	"	24			

Hay Stacker  
Faneuse

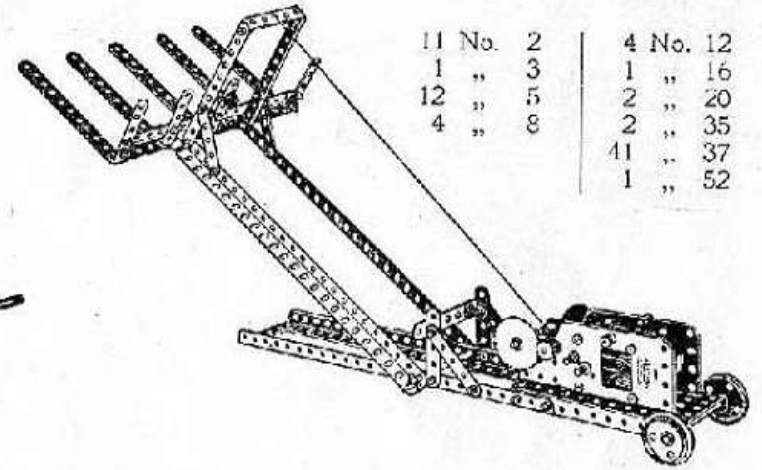

11	No.	2	4	No.	12
1	"	3	1	"	16
12	"	5	2	"	20
4	"	8	2	"	35
			41	"	37
			1	"	52

Scales  
Balance

1	No.	1
6	"	2
5	"	5
4	"	10
4	"	12
1	"	17
2	"	22A
2	"	35
32	"	37
1	"	52
2	"	54
5	"	60

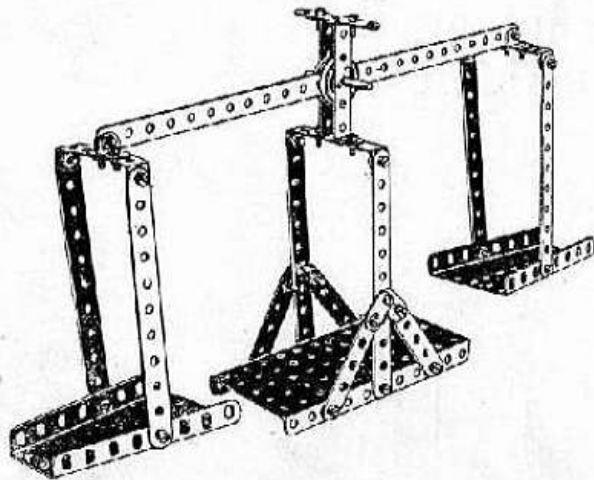

Coaster  
Côtier

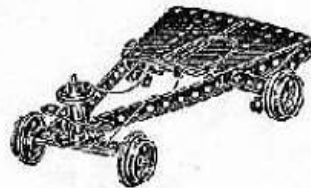

2	No.	2
5	"	5
1	"	15
1	"	16
1	"	17
4	"	20
1	"	22
1	"	24
12	"	37
1	"	45
2	"	54
1	"	60

Aéroplage

3	No.	1
1	"	2
3	"	5
4	"	12
2	"	15
1	"	16
4	"	22
2	"	22A
1	"	24
6	"	35
15	"	37
1	"	44
1	"	52
1	"	54
2	"	60

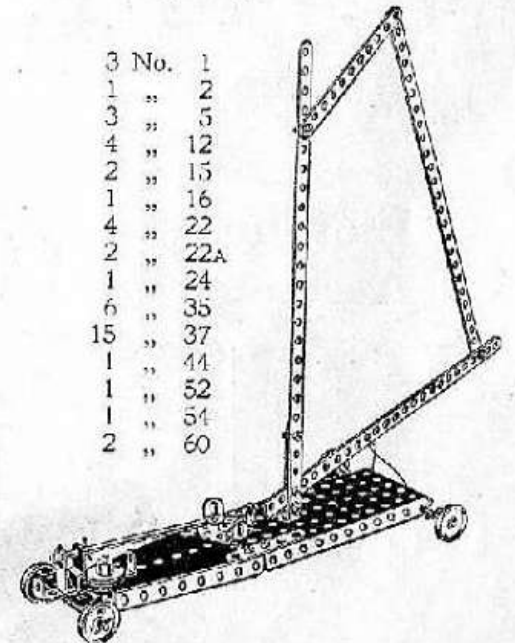

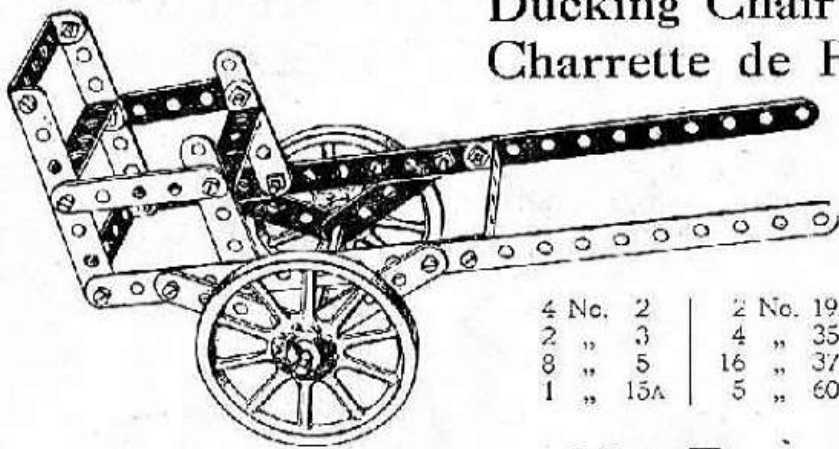

Ducking Chair  
Charrette de Poney

4 No.	2	2 No.	19A
2 "	3	4 "	35
8 "	5	16 "	37
1 "	15A	5 "	60

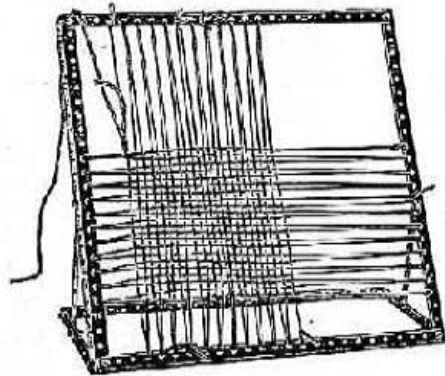

Mat Frame  
Câdre à Tisser

1 No.	1
4 "	2
4 "	8
2 "	12
14 "	37

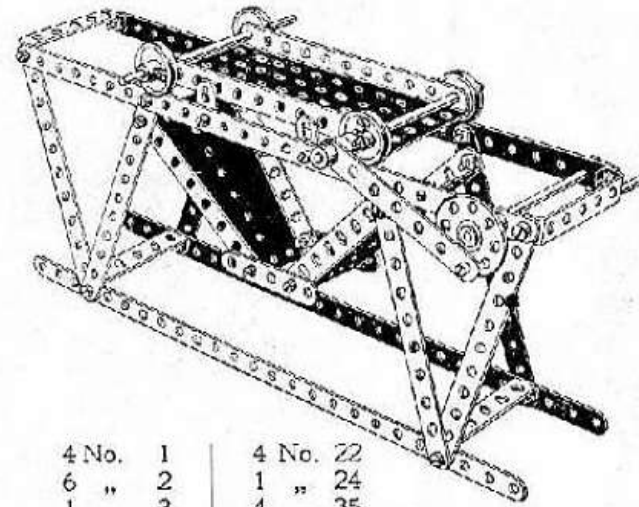

Sifter  
Tamiseur

4 No.	1	4 No.	22
6 "	2	1 "	24
1 "	3	4 "	35
2 "	5	26 "	37
4 "	10	1 "	52
2 "	15A	2 "	54
1 "	19	4 "	60

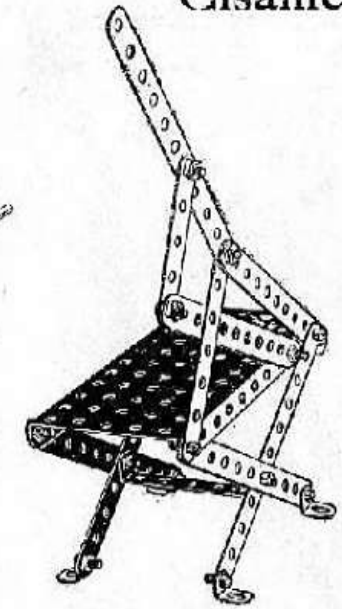

Cutting Machine  
Cisailles

8 No.	2
1 "	3
1 "	5
4 "	12
20 "	37
1 "	52

Elevator  
Ascenseur

1 No.	1	2 No.	22A
10 "	2	5 "	35
1 "	3	44 "	37
10 "	5	1 "	44
4 "	8	1 "	52
4 "	12	2 "	54
1 "	15A	5 "	60
1 "	17		
1 "	19		
1 "	22		

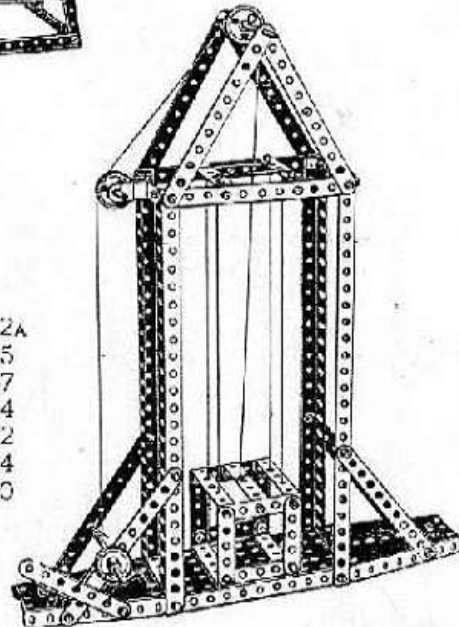

Spinning Top  
Dévidoir à Fil

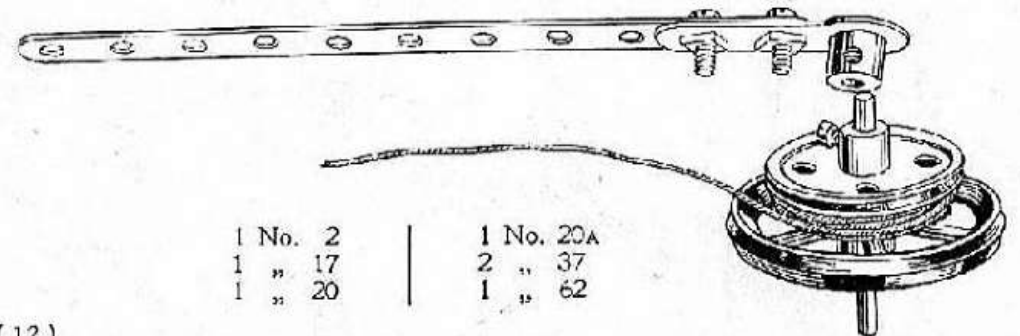

1 No.	2	1 No.	20A
1 "	17	2 "	37
1 "	20	1 "	62

### Locomotive

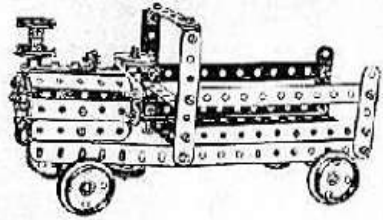

4 No.	2	1 No.	16	46 No.	37
2 "	3	1 "	17	1 "	45
7 "	5	4 "	20	1 "	52
4 "	10	4 "	22	1 "	54
1 "	11	1 "	23	6 "	60
8 "	12	1 "	24	2 "	62
2 "	15A	3 "	35		

### Flax Cleaner

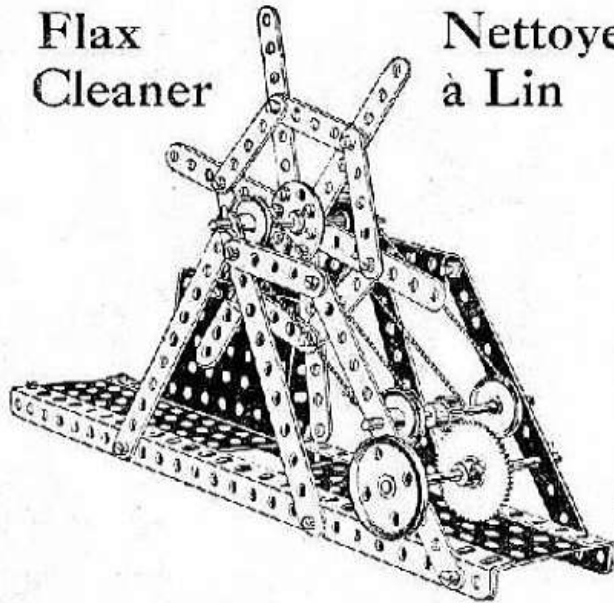

6 No.	2
6 "	3
8 "	5
2 "	8
2 "	15A
1 "	16
2 "	21
4 "	22
1 "	24
1 "	26
1 "	27A
3 "	35
28 "	37
2 "	57

### Nettoyeuse à Lin

### Oscillating Steam Engine

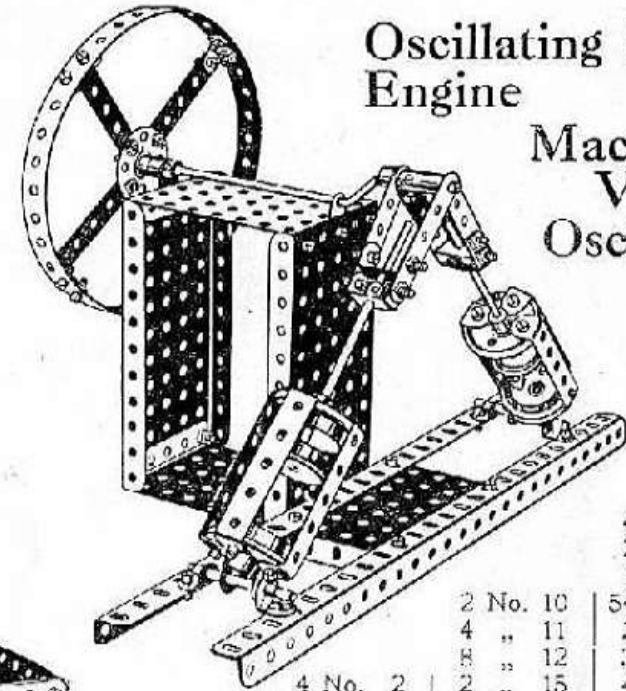

### Machine à Vapeur Oscillante

4 No.	20	4 No.	20
2 "	22	2 "	22
1 "	24	1 "	24
2 "	37	5 1/2 "	37
4 "	52	2 "	52
8 "	53	3 "	53
2 "	59	4 "	59
2 "	60	6 "	60
1 "	63	1 "	63

### Easel Chevalet

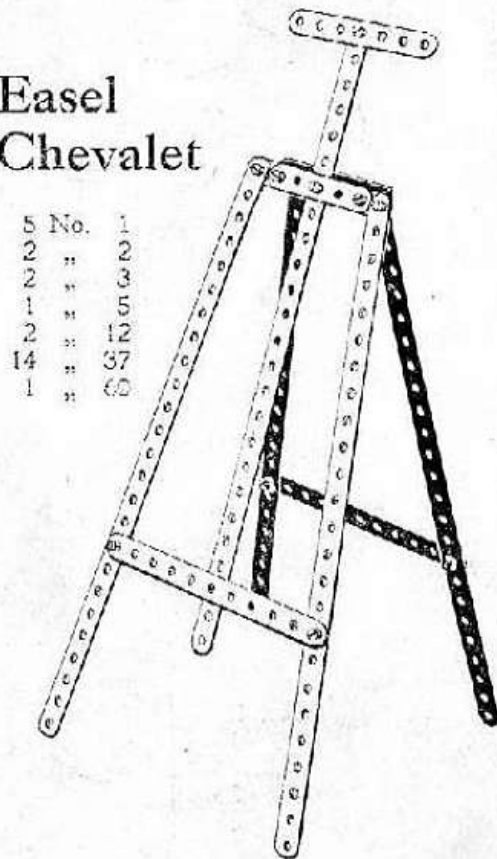

5 No.	1
2 "	2
2 "	3
1 "	5
2 "	12
14 "	37
1 "	60

### Coffee Grinder Moulin à Café

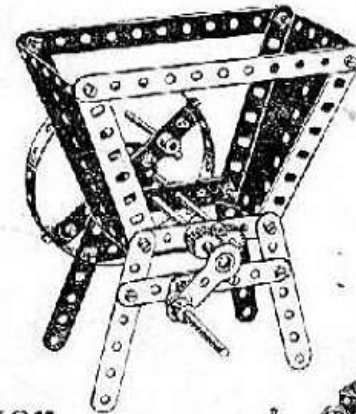

1 No.	1	2 No.	17
2 "	2	1 "	24
6 "	3	2 "	26
2 "	4	28 "	37
4 "	5	2 "	54
4 "	12	4 "	59
1 "	15	2 "	62
1 "	16		

### Wire Rope Maker Machine à faire le câble en fil de fer

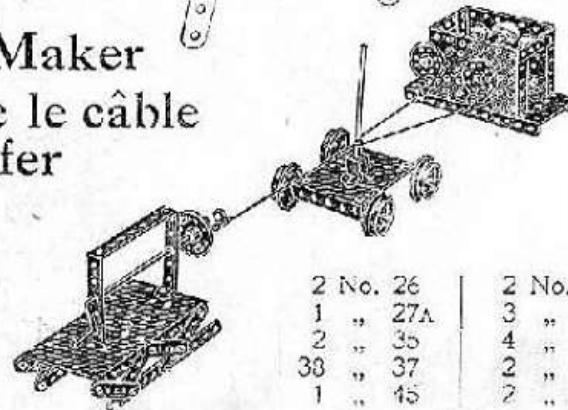

2 No.	2	3 No.	15
1 "	3	2 "	15A
10 "	5	2 "	19
3 "	11	4 "	20
8 "	12	1 "	24

2 No.	26	2 No.	52
1 "	27A	3 "	53
2 "	35	4 "	59
38 "	37	2 "	60
1 "	45	2 "	62

### Lace Jennier Métier à Dentelle

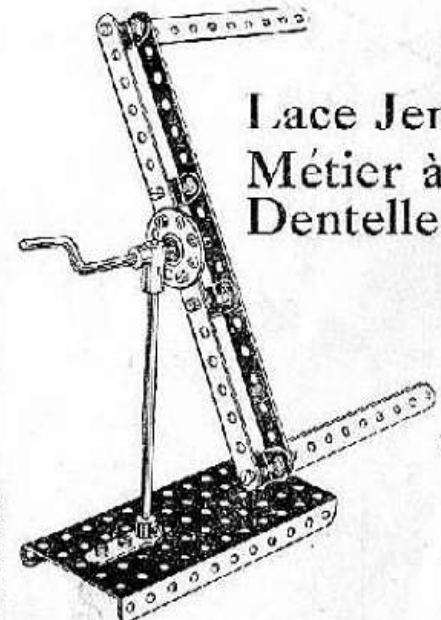

8 No.	2
4 "	11
1 "	15
1 "	19
1 "	24
14 "	37
1 "	52
1 "	59
1 "	62
1 "	63

Actuated See-Saw  
Balancoire à va-et-vient  
Horizontal

1	No.	2	4	No.	35
2	"	3	27	"	37
3	"	8	2	"	52
3	"	15	3	"	53
3	"	15A	4	"	59
4	"	20	1	"	62
1	"	21			
1	"	22			
1	"	24			
1	"	26			
1	"	27			

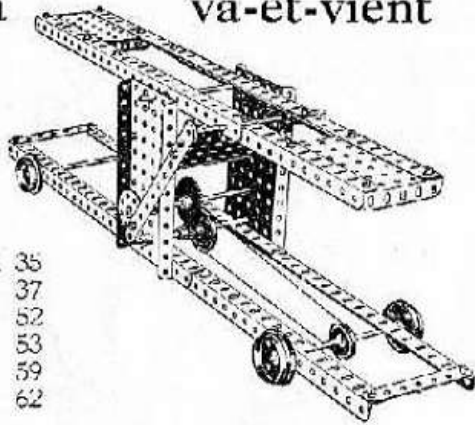

Tip Wagon  
Wagon Basculant

2	No.	1	4	No.	15	1	No.	23	2	No.	52
1	"	2	2	"	15A	1	"	24	3	"	53
6	"	3	1	"	16	1	"	26	1	"	54
2	"	4	1	"	17	1	"	27	4	"	59
11	"	5	4	"	20	4	"	35	6	"	60
4	"	8	1	"	21	65	"	37	2	"	62
9	"	12	3	"	22	1	"	45			

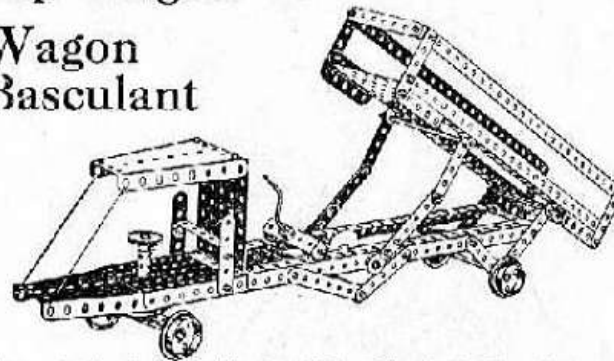

Demonstration Scales  
Balance de Démonstration

5	No.	1
10	"	2
6	"	3
12	"	5
4	"	8
2	"	11
5	"	12
1	"	16
2	"	20
1	"	24
49	"	37
2	"	52
3	"	53
2	"	54

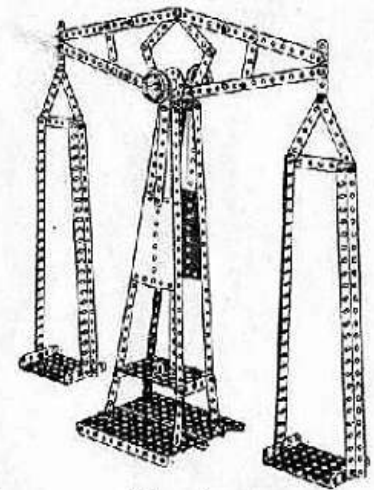

Ice Boat  
Yacht-  
Traineau

Motor Dump Truck  
Truck-Deversoir-  
Automobile

2	No.	1	1	No.	27	3	No.	53
6	"	3	1	"	32	2	"	54
2	"	4	2	"	35	4	"	59
12	"	5	54	"	37	4	"	60
4	"	8	1	"	45	2	"	62
6	"	12	1	"	52	1	"	63
3	"	15A						
2	"	16						
1	"	17						
1	"	19						
4	"	20						
1	"	22						
1	"	24						

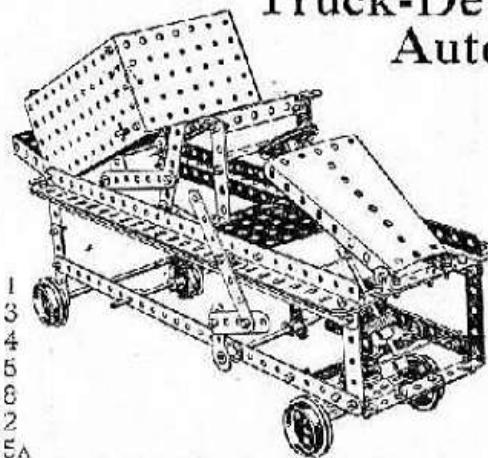

Lawn Swing  
Balancoire de Jardin

9	No.	1	2	No.	15A	1	No.	52
9	"	2	2	"	16	4	"	59
6	"	3	1	"	24	6	"	60
12	"	5	6	"	35	2	"	62
8	"	8	65	"	37	1	"	63

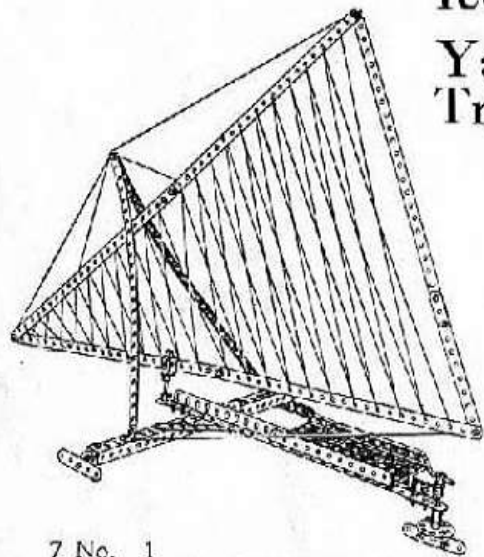
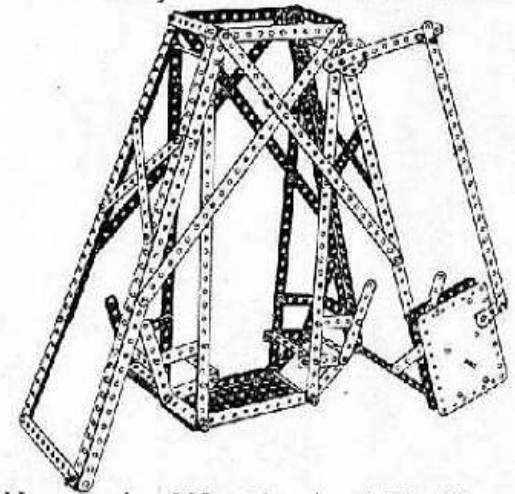

7	No.	1	3	No.	11	39	No.	37
1	"	2	6	"	12	1	"	52
2	"	3	2	"	17	3	"	59
3	"	5	1	"	19	2	"	62
2	"	8	1	"	24	1	"	63
2	"	10						

**"Drop the Nigger"  
"Lachez le Nègre"**

1	No.	1
6	"	3
8	"	8
1	"	12
3	"	15A
1	"	17
1	"	22
6	"	35
33	"	37
1	"	44
2	"	53
2	"	54
3	"	59
4	"	60
1	"	63

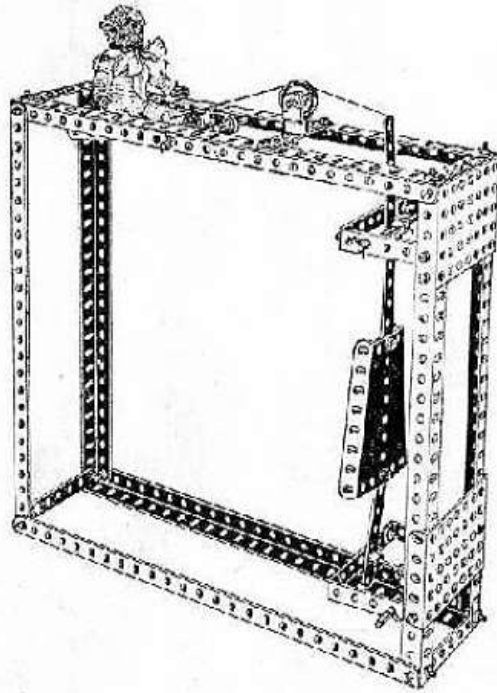

**Conductor's  
Punch  
Poinçon  
de  
Rece-  
veur**

3	No.	5
1	"	11
1	"	15A
1	"	22
9	"	37
1	"	43
2	"	53
1	"	59

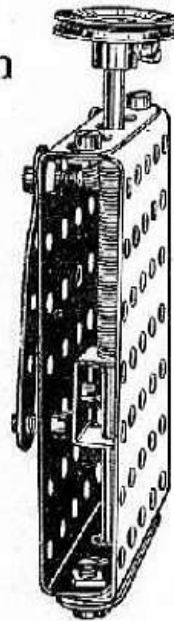

**Rattle  
Crécelle**

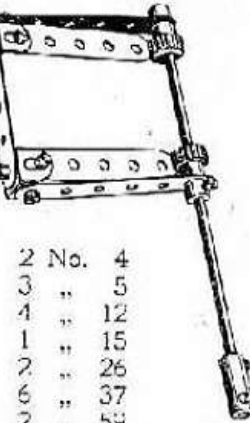

2	No.	4
3	"	5
4	"	12
1	"	15
2	"	26
6	"	37
2	"	59
1	"	63

**Roundabout**

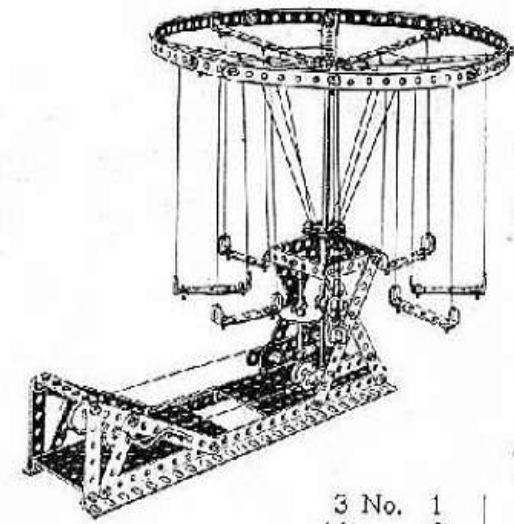

3	No.	1
14	"	2
2	"	3
2	"	4

**Manège**

12	No.	5
2	"	8
24	"	12
3	"	15
1	"	16
1	"	19
1	"	21
4	"	22
2	"	26
1	"	27
1	"	32
68	"	37
12	"	38
2	"	52
4	"	59
4	"	60
1	"	63

**Perambulator  
Voiturette**

3	No.	1
10	"	2
12	"	5
2	"	10
12	"	12
3	"	15A
1	"	16
4	"	19A
2	"	22
10	"	35
45	"	37
1	"	52
3	"	60



**Scarifier  
Scarificateur**

6	No.	2
3	"	3
10	"	5
6	"	12
1	No.	17
1	"	22
22	"	37
2	"	59

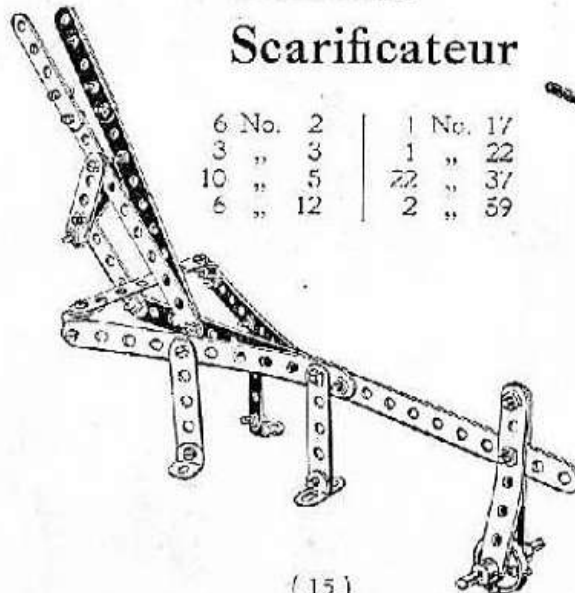

**Field Gun and Carriage  
Canon de Campagne et Caisson**

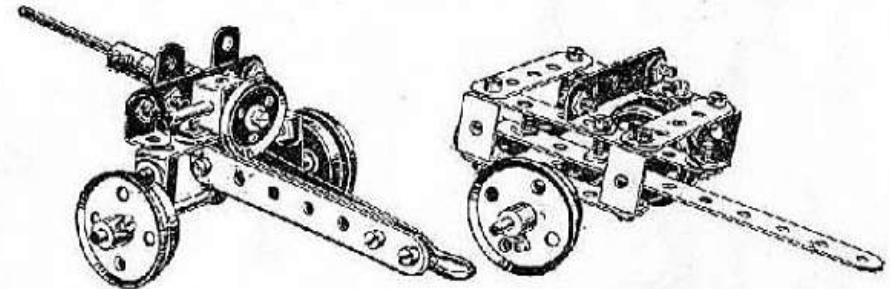

1	No.	2
5	"	3
12	"	5
2	"	10
4	"	11
5	"	12
2	No.	15A
1	"	16
1	"	17
4	"	20
1	"	22
1	"	32
27	No.	37
1	"	45
1	"	57
2	"	59
2	"	60
1	"	63

# Locomotive Crane Grue-Locomotive

2 No.	1	1 No.	21	1 No.	57
2 "	2	1 "	22	2 "	59
2 "	3	1 "	24	5 "	60
3 "	11	1 "	26	1 "	63
2 "	12	1 "	33		
2 "	15A	2 "	35		
1 "	17	38 "	37		
1 "	18	2 "	52		
1 "	19	3 "	53		
4 "	20	1 "	54		

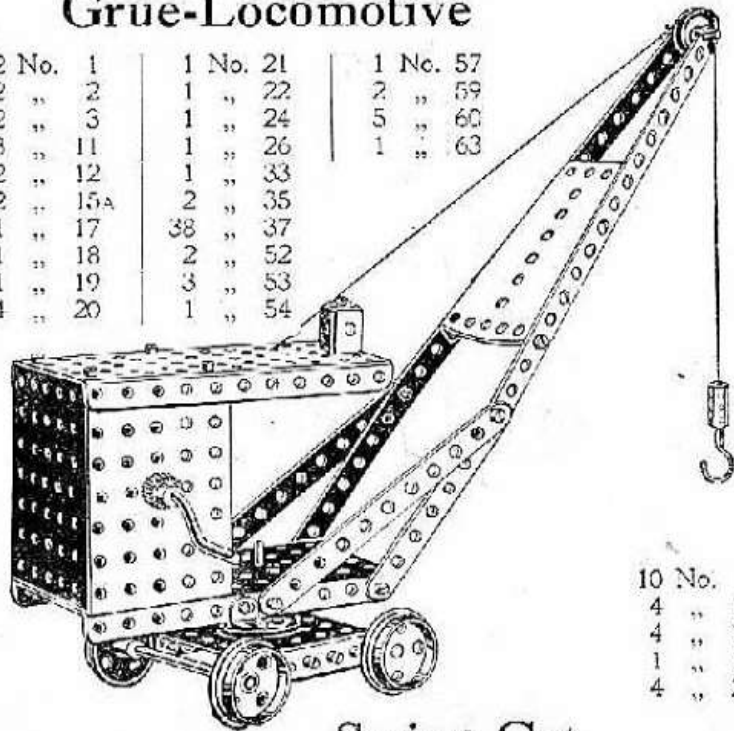

10 No.	2	20 No.	37
4 "	10	1 "	52
4 "	12	2 "	53
1 "	19	2 "	54
4 "	22		

# Oil Cake Chopper Coupe-Tourteau

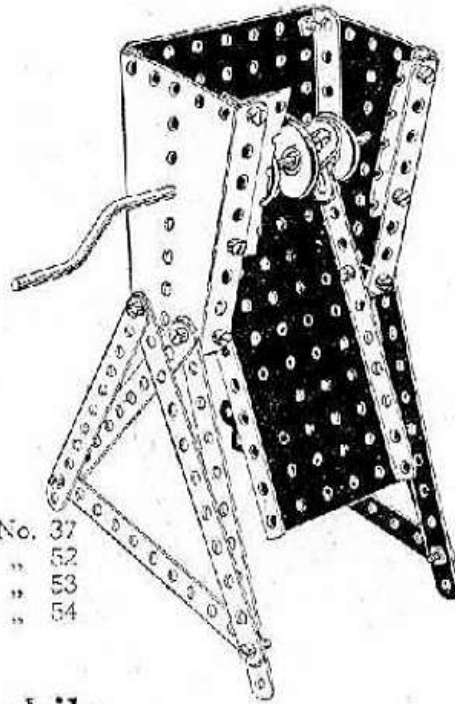

# Swing Cot Bercelonnette

10 No.	1	20 No.	12
14 "	2	2 "	17
2 "	5	2 "	22
2 "	6	62 "	37
2 "	8	2 "	62
2 "	11		

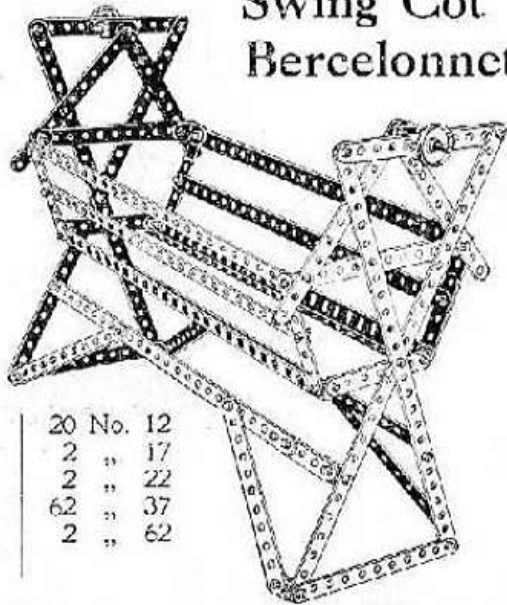

# Automobile

2 No.	2	4 No.	20
6 "	3	3 "	22
2 "	8	1 "	24
4 "	12	38 "	37
2 "	15	1 "	45
2 "	17	1 "	46
		1 "	52
		1 "	54
		3 "	59
		7 "	60

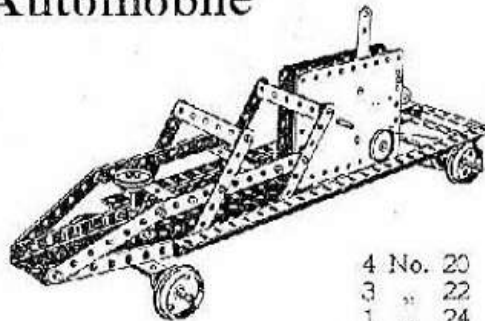

# Band Saw Scie à Ruban

4 No.	2	2 No.	17
4 "	5	1 "	20A
1 "	8	1 "	21
3 "	11	1 "	22
3 "	12	1 "	26
1 "	16	1 "	27A
		21 "	37
		2 "	52
		2 "	59
		1 "	60

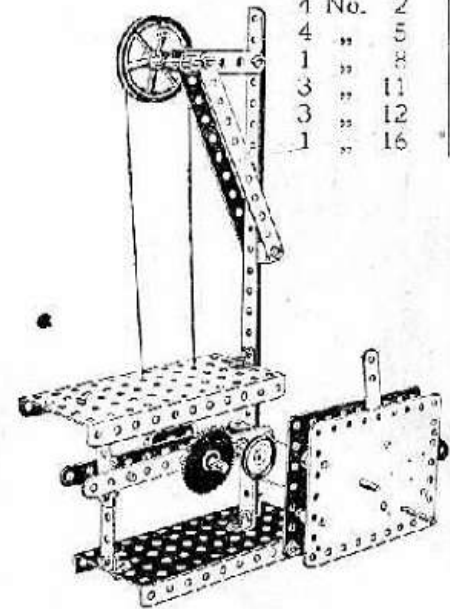

# Rocking Chair

2 No.	1	48 No.	37
13 "	2	2 "	53
8 "	5	3 "	60
2 "	10		
2 "	11		
11 "	12		

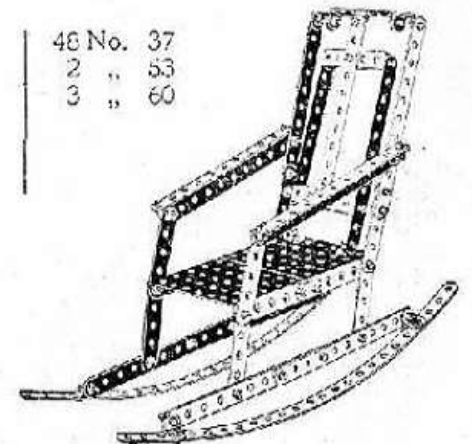



### Swing Balancoire

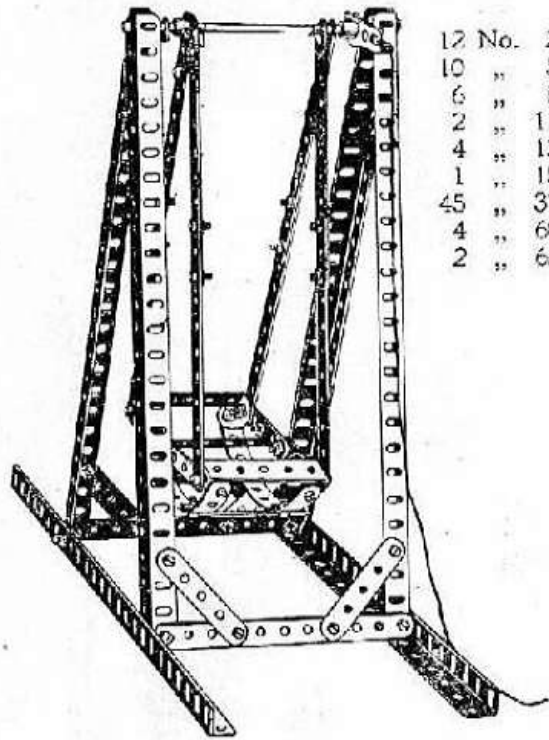

12	No.	2
10	"	5
6	"	8
2	"	11
4	"	12
1	"	15
45	"	37
4	"	60
2	"	62

### Automatic Swing Boat Balancoire Russe

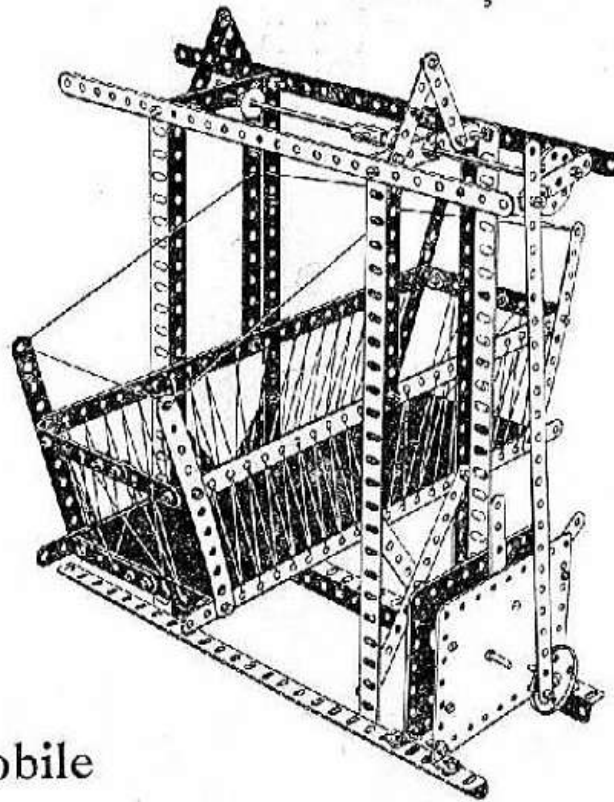

7	No.	1
10	"	2
3	"	3
12	"	5
4	"	8
12	"	12
2	"	15
1	"	21
1	"	24
66	"	37
2	"	59
2	"	62
1	"	63

### Swing Balancoire

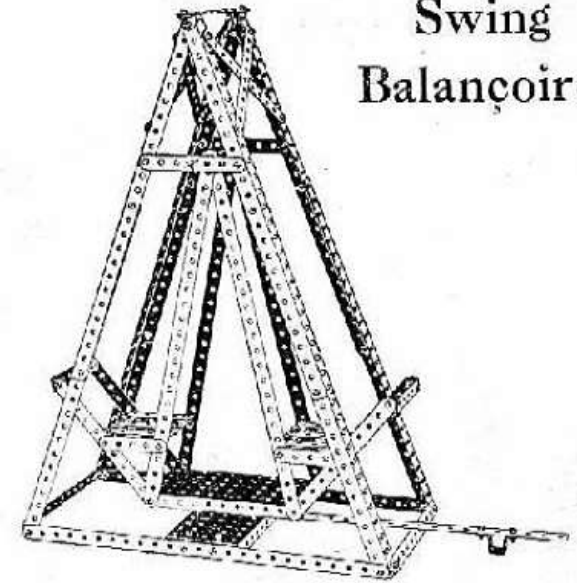

7	No.	1	1	No.	15
11	"	2	6	"	35
2	"	3	67	"	37
10	"	5	1	"	45
8	"	8	2	"	52
6	"	12	6	"	60

### Automobile

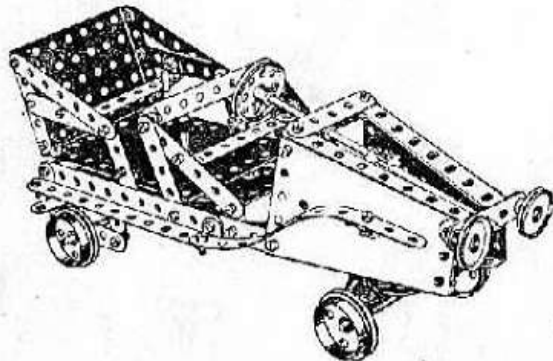

8	No.	2	1	No.	21
5	"	3	2	"	22
4	"	4	1	"	24
9	"	5	2	"	26
6	"	10	1	"	28
28	"	12	1	"	29
1	"	14	17	"	37
1	"	15	1	"	45
1	"	15A	1	"	53
1	"	17	2	"	54
4	"	20	4	"	59
			2	"	60

### Harmonograph Harmonographe

1	No.	2	1	No.	27A
4	"	3	2	"	29
1	"	4	1	"	32
2	"	5	27	"	37
2	"	14	2	"	45
2	"	17	2	"	52
1	"	19	8	"	59
2	"	24	4	"	60
2	"	26			

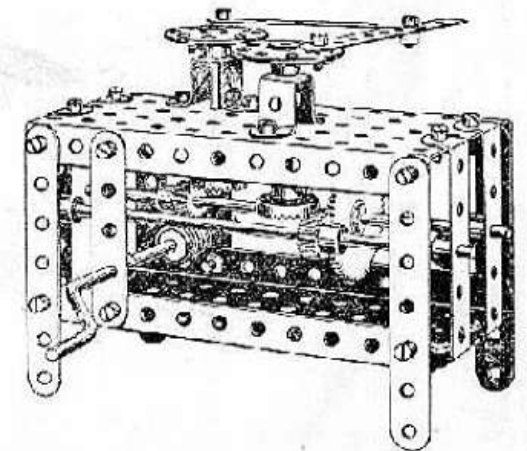

# Armoured Motor Car Automobile Blindée

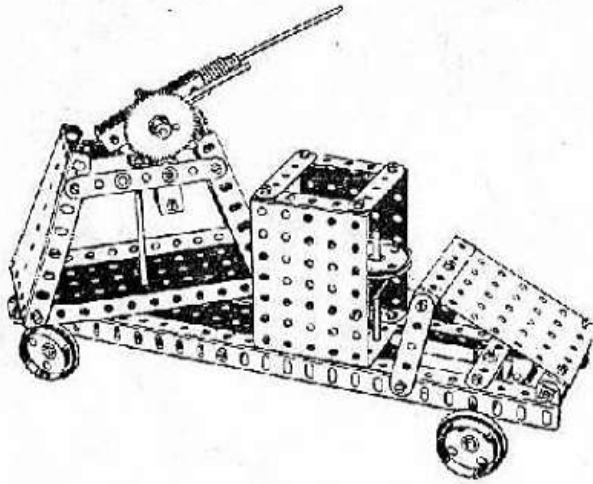

2	No.	3
9	"	5
2	"	8
2	"	11
2	"	12
2	"	15
2	"	15A
1	"	16
3	"	17
4	"	20
1	"	21
4	"	22
1	"	24
1	"	26
1	"	27
1	"	32
43	"	37
1	"	45
2	"	52
3	"	53
2	"	54
1	"	59
7	"	60
1	"	62
1	"	63

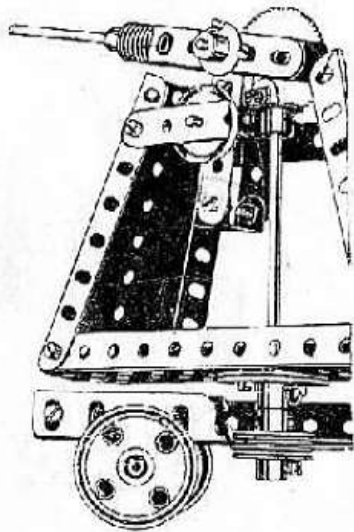

# Armoured Motor Tricycle Auto Tricycle Armé

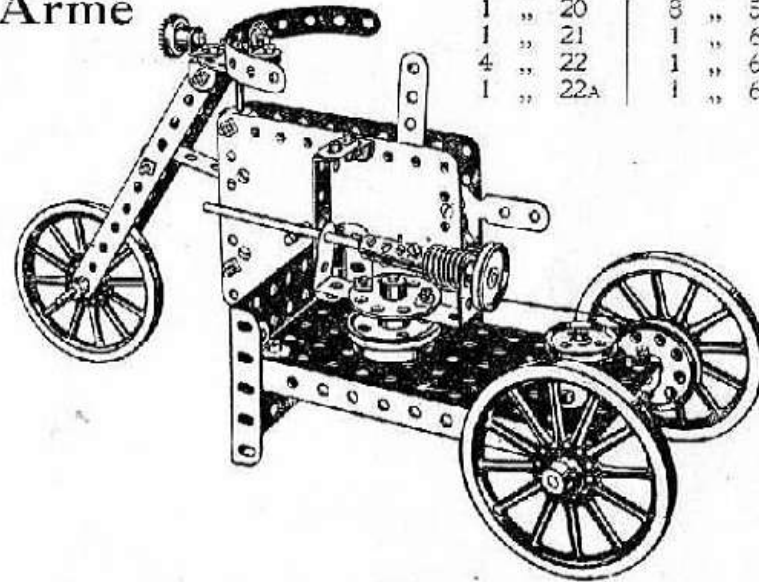

4	No.	2
1	"	5
1	"	10
3	"	11
6	"	12
2	"	15
1	"	17
1	"	18
1	"	20
1	"	21
4	"	22
1	"	22A

2	No.	24
1	"	29
1	"	33
29	"	37
2	"	45
1	"	46
1	"	52
1	"	53
8	"	59
1	"	60
1	"	62
1	"	63

# Chocolate Mixer Mélangeur à Chocolat

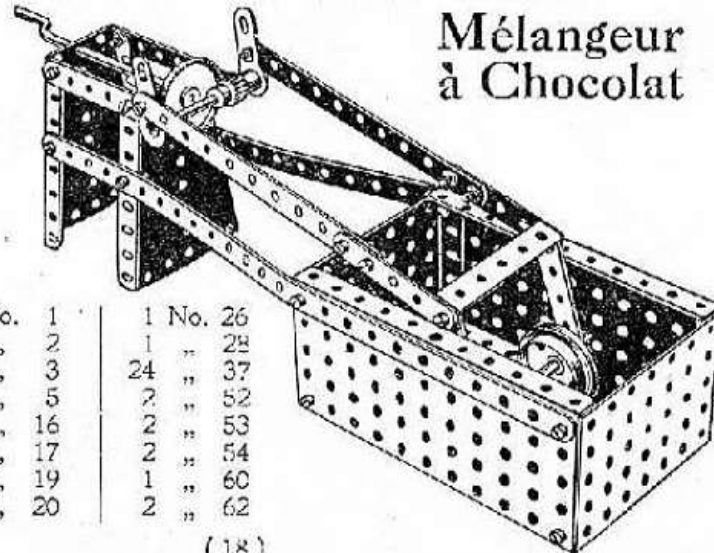

2	No.	1
2	"	2
2	"	3
4	"	5
1	"	16
1	"	17
1	"	19
2	"	20
1	No.	26
1	"	28
24	"	37
2	"	52
2	"	53
2	"	54
1	"	60
2	"	62

# Elevator Ascenseur

4	No.	1
20	"	2
4	"	3
2	"	4
2	"	5
8	"	8
9	"	12
2	"	14
1	"	15
2	"	17
1	"	19
3	"	22
1	"	26
1	"	27A
1	"	33
74	"	37
1	"	44
2	"	52
2	"	53
5	"	59
1	"	63

