

MECCANO



(TRADE MARK 296321)

INSTRUCTIONS

BOOK No. 1

1/-

Copyright by MECCANO LIMITED, LIVERPOOL, throughout the World

No. 19A

ENGLISH EDITION.

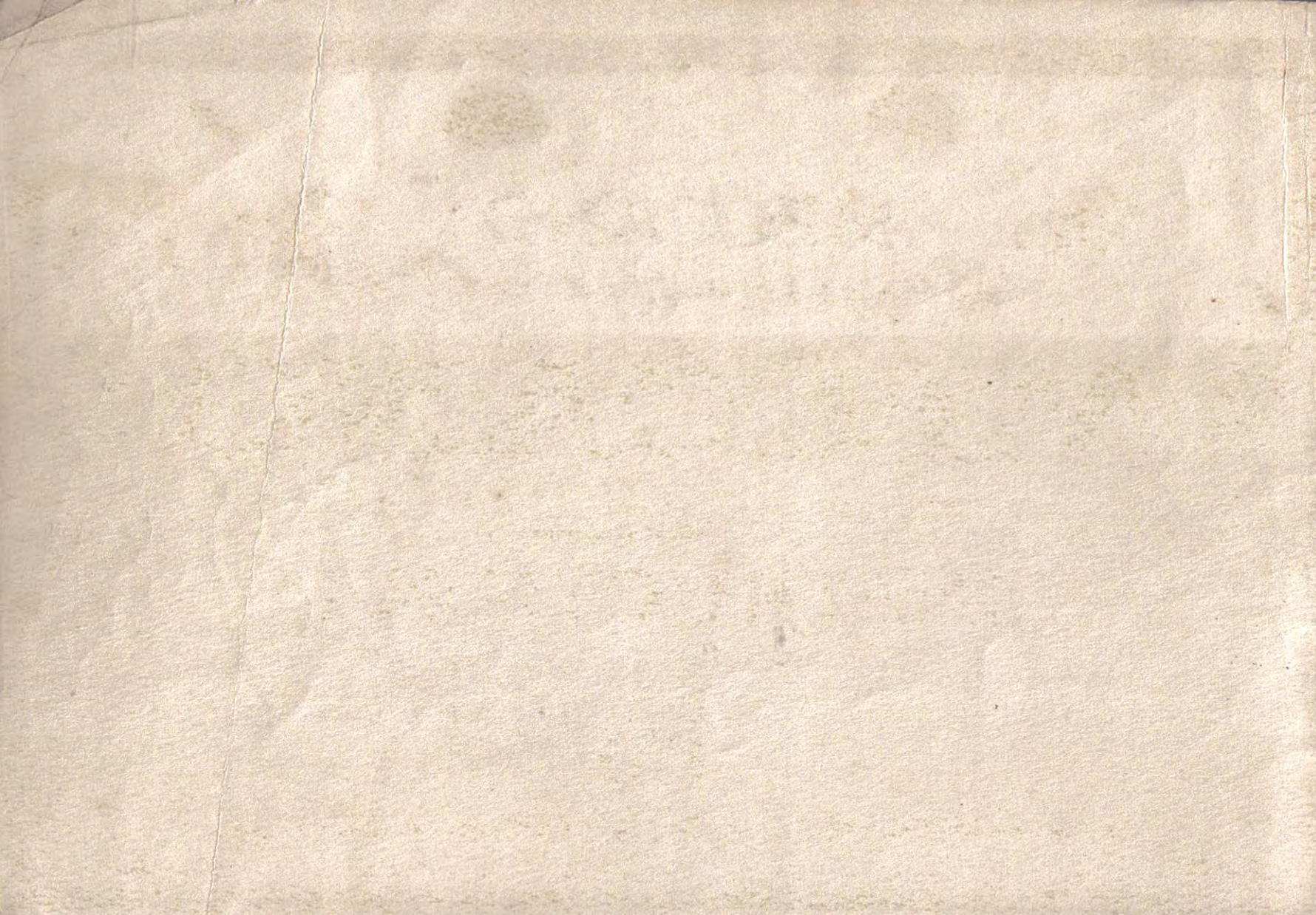

MECCANO

Hornby's Original System, First Patented 1901

PATENTS & DESIGNS,
GREAT BRITAIN:

577,272

577,207

648,958

22,962-13

20,535-13

21,117-12

4564-15

2085-11

4183-14

3869-14

103,537-17

PATENTED THROUGHOUT THE WORLD

To Meccano Boys

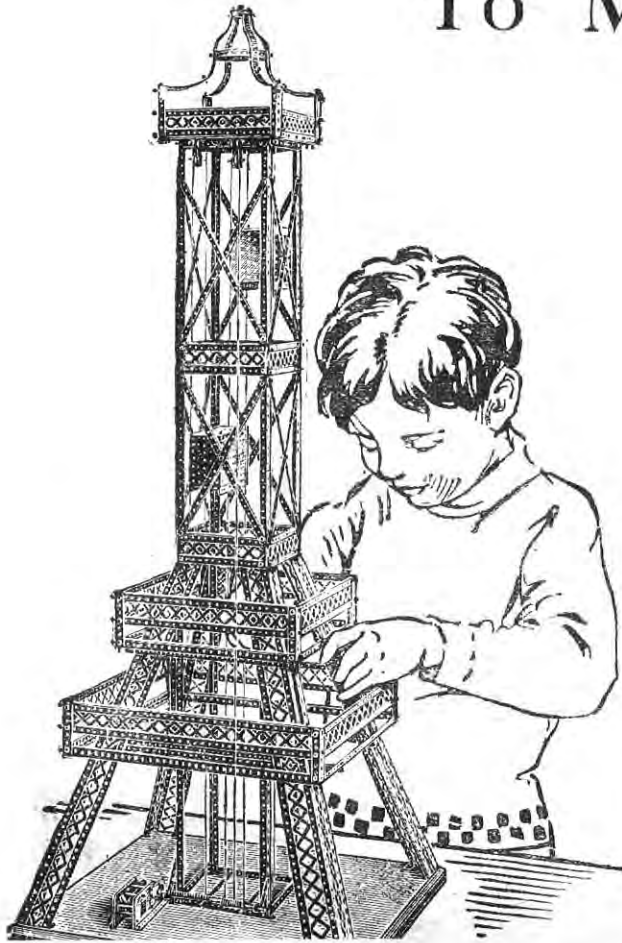

YOUR Meccano Outfit contains a number of accurately made and finished engineering parts, which enable you to duplicate any and every movement known to mechanism.

The value of a constructional system does not lie in the number of parts which it contains, but entirely in the uses to which the various parts can be put. It is a sweeping statement to make, but a perfectly true one, that Meccano will do all and more than all other constructional toys put together, and that no other system will do the same as Meccano. Every other metal constructional toy is an imitation of Meccano, which was the first toy of its kind. *The genius and knowledge and experience are in the Meccano parts.* Each part will fill a hundred different purposes in a perfect manner, and there is no limit to the uses to which they can be applied.

Meccano is sold as a children's toy, to give them fun, interest them, and instruct them in the fascinating wonders of engineering, but every day sees a fresh use for it. Engineers and architects use it for designing models and inventing movements. Professors and teachers in technical schools use it to demonstrate mechanical principles to their students. We have received enthusiastic letters from inventors who have designed practical commercial machines with Meccano parts for weaving and other purposes. It is largely used in institutions for the blind, for teaching patients, and in very many children's hospitals it brings happiness and relief to thousands of afflicted ones.

To Meccano Boys—(continued).

There is no hard work attached to building Meccano models. All the work and thought have been put into the parts when they were designed, and all you have to do is to follow the instructions, and screw the parts together.

Bright boys are inventing new Meccano models every day, and sending them in to win prizes in our big competitions. These new models will be included in subsequent editions which we shall publish from time to time, and which you should look out for and secure as they are published. Notification of these will be made in the **Meccano Magazine** and through your dealers. If you are not already a Subscriber to the **Meccano Magazine**, we strongly recommend that you write us at once to have your name placed on our list so that you may not miss any of the pleasures of Meccano.

MECCANO PRIZE COMPETITIONS

MONEY AND FAME FOR MECCANO BOYS. Each year there is a big Meccano Prize Competition, in which we offer big prizes in money, and new Meccano Outfits to clever boys, who are able to design new models. Send your own ideas in, and get your share of the prize money. Be sure to ask your dealer for full particulars and entry forms. If you have any difficulty send us a postcard, and we will see that you get what you want. There are no entrance fees or restrictions of any kind.

IMPORTANT NOTICE.—In some of the models throughout this manual we have made use of the Meccano Braced Girder, large wheels, sprocket wheels and chain, etc., which are only supplied in the Inventor's Accessory Outfit, or as separate parts. We have employed these parts, as they improve the appearance and working of the models, and they also form a suggestion for the use of the Inventor's Accessory Outfit, but in every case the same models may be effectively built with the parts contained in the regular Meccano outfits.

Types of Trucks and Luggage Carts

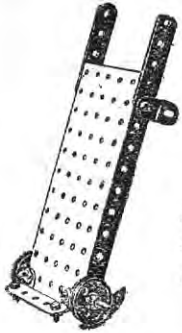

Model No. 1

Parts Required:

3 of No. 5	1 of No. 15A
2 " " 10	2 " " 22
2 " " 12	8 " " 37
1 of No. 52	

Model No. 2

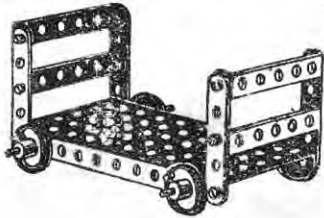

Parts

Required:

4 of No. 5
4 " " 60
2 " " 15A
4 " " 22
12 " " 37
1 " " 52

Model No. 3

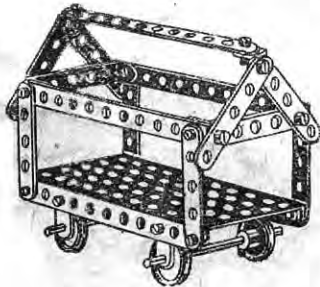

Parts Required:

3 of No. 2
8 " " 5
2 " " 60
4 " " 10
2 " " 12
2 " " 15A
4 " " 22
20 " " 37
1 " " 52

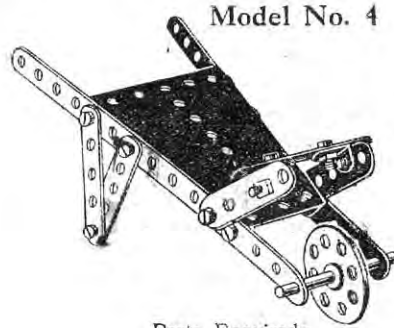

Model No. 4

Parts Required:

2 of No. 2	1 of No. 24
9 " " 5	2 " " 35
2 " " 12	14 " " 37
1 " " 17	1 " " 54

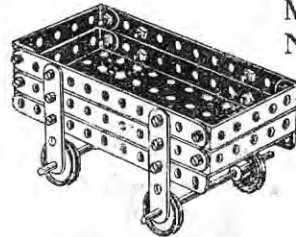

Model No. 5

Parts Required:

4 of No. 2	4 of No. 22
4 " " 5	20 " " 37
4 " " 60	1 " " 52
2 " " 15A	

Model No. 6

Parts Required:

4 of No. 2
4 " " 5
4 " " 60
2 " " 15A
4 " " 22
12 " " 37
1 " " 52

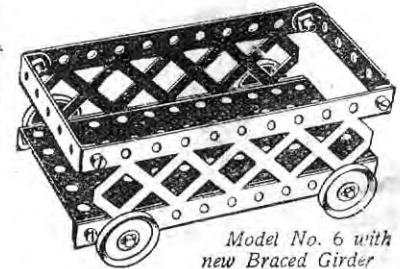
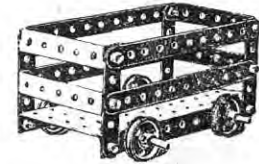

Model No. 6 with new Braced Girder

Model No. 7

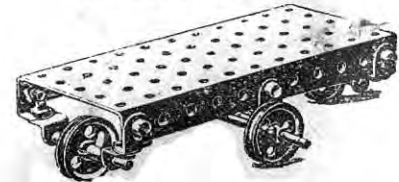

Parts Required:

2 of No. 10	2 of No. 22A
8 " " 12	4 " " 35
1 " " 15A	10 " " 37
2 " " 17	1 " " 52
2 " " 22	



Fig. 7A

Types of Trucks and Luggage Carts

Model No. 8. Luggage Barrow



Parts required:

2 of No. 2	
8 of No. 5	10 of No. 37
1 " " 16	1 " " 52
2 " " 22	1 " " 60

Model No. 9 - Timber Truck

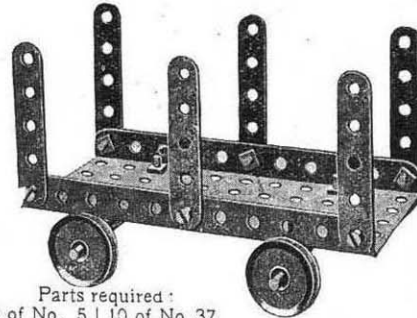

Parts required:

6 of No. 5	10 of No. 37
2 " " 16	1 " " 52
4 " " 22	2 " " 60

Model No. 10 - Timber Truck

Parts required:

2 of No. 16	4 of No. 37
2 " " 17	1 " " 52
4 " " 22	2 " " 60
4 " " 35	

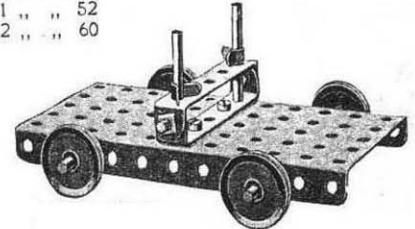

Model No. 11. Flat Truck

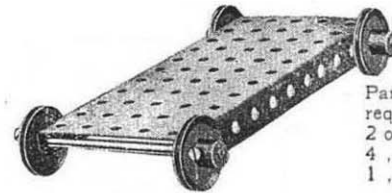

Parts required:

2 of No. 16
4 " " 22
1 " " 52

Model No. 12 Luggage Cart

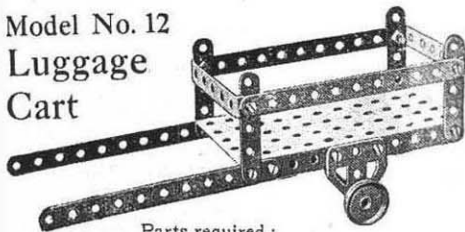

Parts required:

4 of No. 2	14 of No. 37
4 " " 5	1 " " 52
1 " " 16	2 " " 60
2 " " 22	2 " " 126A

Model No. 13 Coster's Barrow

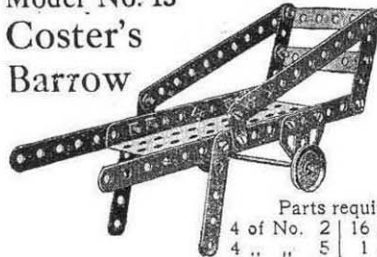

Parts required:

4 of No. 2	16 of No. 37
4 " " 5	1 " " 52
1 " " 16	2 " " 60
2 " " 22	2 " " 126A

Model No. 14 Luggage Cart

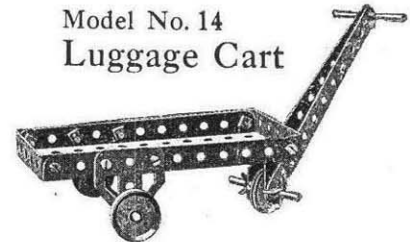

Parts required:

2 of No. 2	9 of No. 37
1 " " 16	1 " " 44
2 " " 17	1 " " 52
3 " " 22	2 " " 60
4 " " 35	2 " " 126A

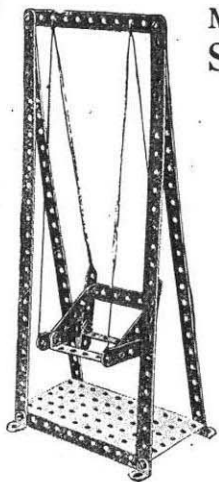

Model No. 15
Swing

- Parts required
- | | |
|----------|----|
| 4 of No. | 1 |
| 1 " " | 2 |
| 6 " " | 5 |
| 4 " " | 12 |
| 12 " " | 37 |
| 1 " " | 52 |
| 3 " " | 60 |

Model No. 16 Bath Chair

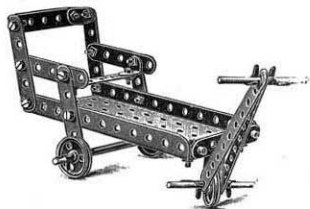

- Parts required
- | | | | |
|----------|-----|----------|-----|
| 2 of No. | 2 | 3 of No. | 22A |
| 9 " " | 5 | 6 " " | 35 |
| 6 " " | 12 | 20 " " | 37 |
| 1 " " | 15A | 1 " " | 44 |
| 2 " " | 17 | 1 " " | 52 |

Model No. 17
Windmill

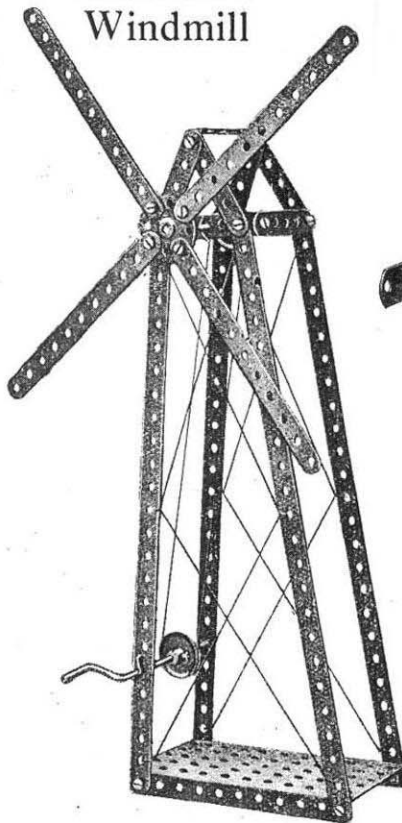

Model No. 18 - Well Windlass

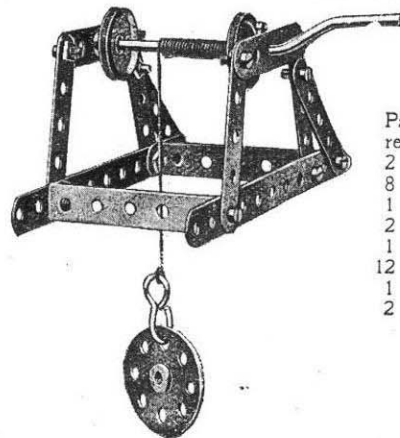

- Parts required:
- | | |
|----------|----|
| 2 of No. | 2 |
| 8 " " | 5 |
| 1 " " | 19 |
| 2 " " | 22 |
| 1 " " | 24 |
| 12 " " | 37 |
| 1 " " | 57 |
| 2 " " | 60 |

Model No. 19
Endless Rope
Railway

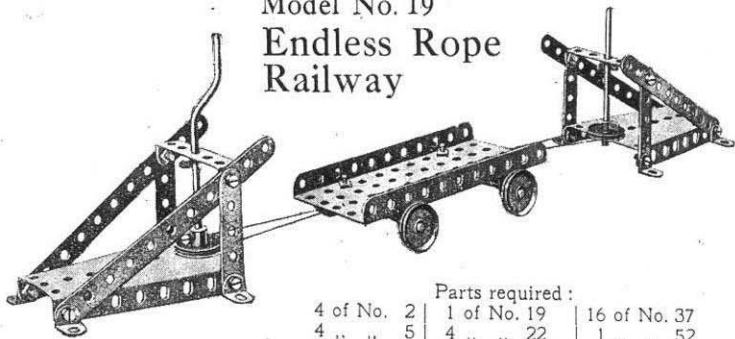

- Parts required:
- | | | | | | |
|----------|----|----------|-----|-----------|----|
| 4 of No. | 2 | 1 of No. | 19 | 16 of No. | 37 |
| 4 " " | 5 | 4 " " | 22 | 1 " " | 52 |
| 8 " " | 12 | 2 " " | 22A | 2 " " | 54 |
| 3 " " | 16 | 4 " " | 35 | 4 " " | 60 |

Model No. 20
See-Saw

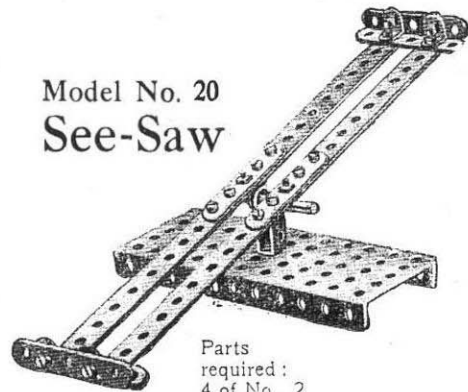

- Parts required:
- | | | | |
|----------|----|----------|----|
| 4 of No. | 1 | 2 of No. | 22 |
| 4 " " | 2 | 1 " " | 24 |
| 7 " " | 5 | 4 " " | 35 |
| 2 " " | 12 | 20 " " | 37 |
| 1 " " | 16 | 1 " " | 52 |
| 1 " " | 19 | 3 " " | 60 |

- Parts required:
- | | |
|----------|----|
| 4 of No. | 2 |
| 6 " " | 5 |
| 6 " " | 12 |
| 1 " " | 17 |
| 15 " " | 37 |
| 1 " " | 44 |
| 1 " " | 52 |

Model No. 21

Travelling Ladder

Parts Required:

- 6 of No. 2
- 4 " " 5
- 2 " " 15A
- 4 " " 22
- 16 " " 37
- 1 " " 52
- 4 " " 60

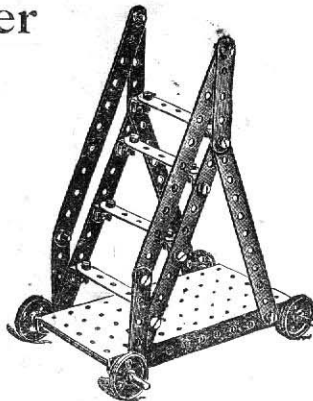

Model No. 22

Step Ladder

Parts Required:

- | | |
|------------|-------------|
| 4 of No. 2 | 2 of No. 12 |
| 3 " " 5 | 12 " " 37 |
| | 4 " " 60 |

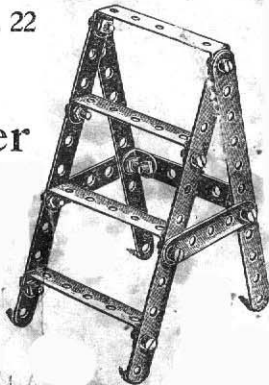

Model No. 23 Telpher Span

Parts Required:

- | | | |
|------------|-------------|--------------|
| 2 of No. 1 | 1 of No. 17 | 20 of No. 37 |
| 2 " " 2 | 1 " " 19 | 1 " " 44 |
| 6 " " 5 | 3 " " 22 | 1 " " 52 |
| 4 " " 12 | 2 " " 22A | 2 " " 54 |
| 2 " " 15A | 6 " " 35 | 3 " " 60 |

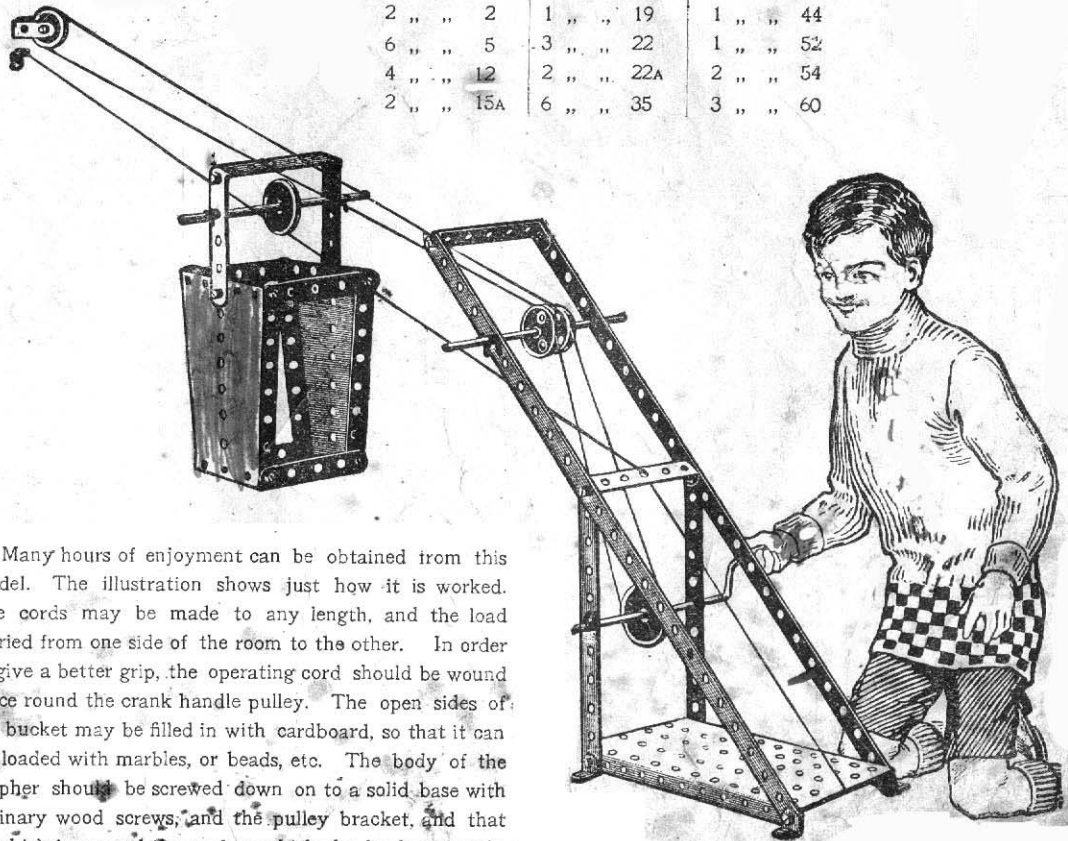

Many hours of enjoyment can be obtained from this model. The illustration shows just how it is worked. The cords may be made to any length, and the load carried from one side of the room to the other. In order to give a better grip, the operating cord should be wound twice round the crank handle pulley. The open sides of the bucket may be filled in with cardboard, so that it can be loaded with marbles, or beads, etc. The body of the Telpher should be screwed down on to a solid base with ordinary wood screws, and the pulley bracket, and that to which is secured the cord on which the bucket travels, are screwed in a suitable position on the opposite side of the room.

Model No. 24 Travelling Jib Crane

Parts Required:

2 of No.	1
3 " "	2
2 " "	5
2 " "	15A
1 " "	17
1 " "	19
4 " "	22
2 " "	22A
1 " "	24
5 " "	35
15 " "	37
1 " "	52
1 " "	54
1 " "	57
1 " "	60

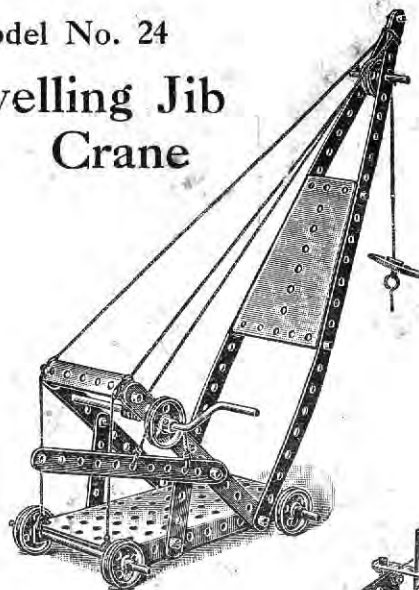

Types of Cranes

Model No. 25 Jib Crane

Parts Required:

4 of No.	1	4 of No.	35
6 " "	2	20 " "	37
1 " "	3	1 " "	52
1 " "	11	2 " "	54
2 " "	12	1 " "	57
1 " "	15A	2 " "	60
2 " "	17		
1 " "	19		
4 " "	22		
2 " "	22A		
1 " "	24		

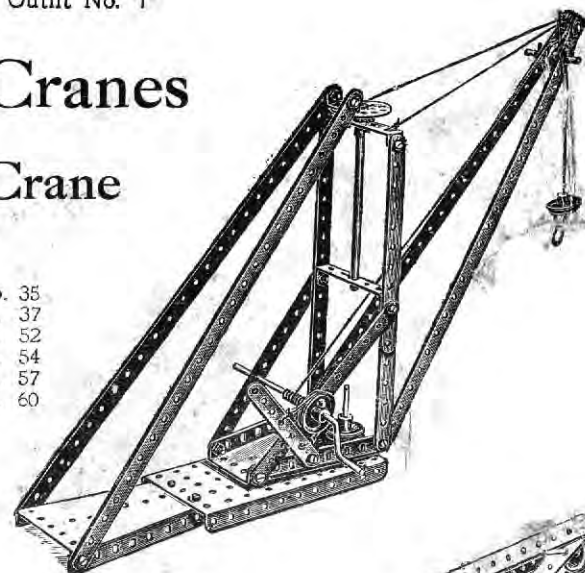

Model No. 26 Overhead Crane

Parts Required:

2 of No.	1	2 of No.	22A
6 " "	2	1 " "	24
9 " "	5	6 " "	35
4 " "	10	20 " "	37
4 " "	12	1 " "	44
3 " "	15	1 " "	52
1 " "	17	2 " "	54
1 " "	19	1 " "	57
4 " "	22	2 " "	60

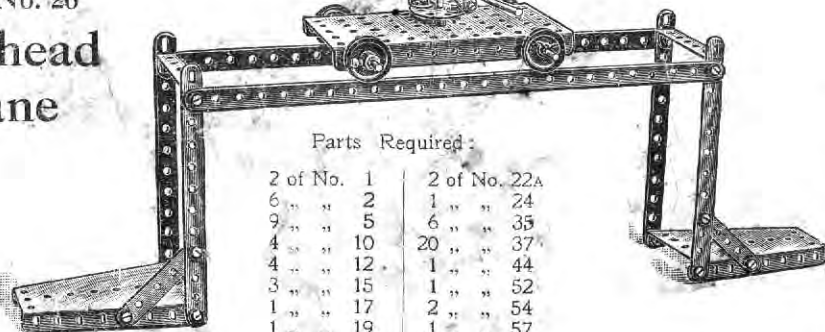

Model No. 27 Swivelling Crane

Parts Required:

2 of No.	1	2 of No.	22A
6 " "	2	1 " "	24
1 " "	3	4 " "	35
4 " "	5	18 " "	37
1 " "	11	1 " "	44
1 " "	15A	1 " "	52
2 " "	17	2 " "	54
1 " "	19	1 " "	57
4 " "	22	3 " "	60

The hoisting cord after passing over the pulley at the end of the jib, passes over a pulley running in a cranked bent strip secured by a nut and bolt to the 2 1/2" bent strip at the back of the jib.

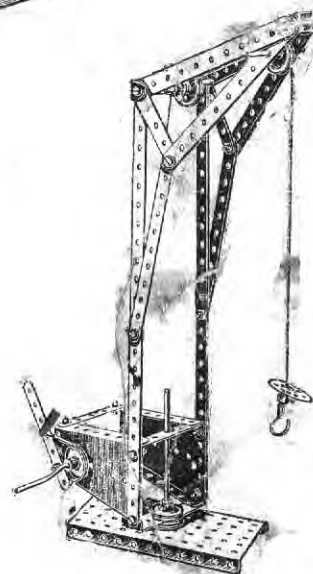

Model No. 28

Swivelling Jib Crane

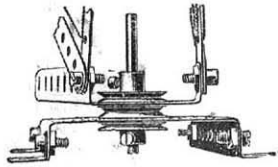
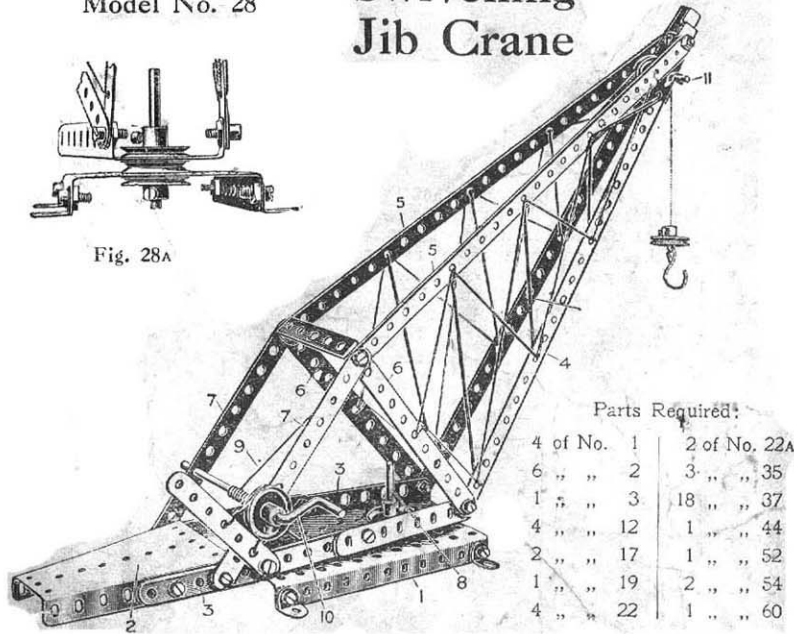

Fig. 28A



Parts Required:

4 of No. 1	2 of No. 22A
6 " " 2	3 " " 35
1 " " 3	18 " " 37
4 " " 12	1 " " 44
2 " " 17	1 " " 52
1 " " 19	2 " " 54
4 " " 22	1 " " 60

The fixed base of this Crane is a perforated flanged plate 1, and the swivelling base of the Crane is formed by two sector plates 2 and 3. The jib is formed from two 12½" strips 4 bolted to the ends of the sector plate 3, two other 12½" strips 5 being bolted to the top of the strips 4 and to cross strips 6, the outer ends of these latter strips being stayed by strips 7 bolted to the other sector plate. The upper structure of the Crane swivels about a rod 8, and is secured as shown in Fig. 28A. The winding rope 9 is operated by the crank handle 10 and passes over a pulley in the head of the Crane on a short rod 11.

Model No. 29 Turntable Gangway

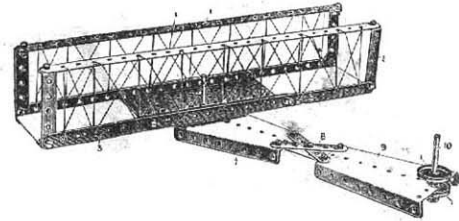

Parts Required:

4 of No. 1	19 of No. 37
2 " " 5	1 " " 52
2 " " 17	2 " " 54
3 " " 22	4 " " 60
1 " " 24	

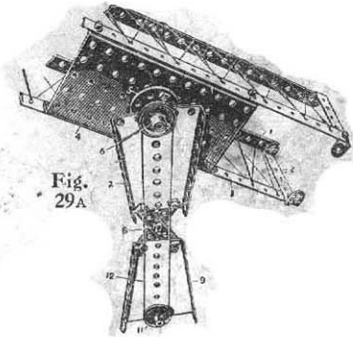
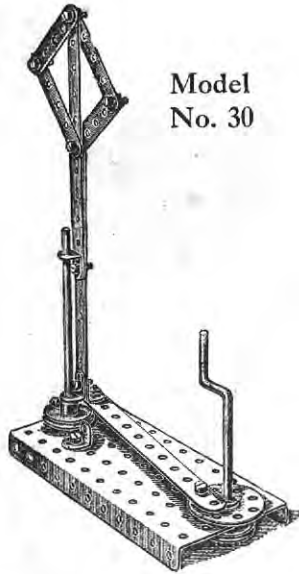

Fig. 29A

The side frames of the gangway are made of 12½" strips 1 bolted by means of 2½" bent strips 2 to lower strips 3, the strips 3 and 1 being set at right angles to each other, and the side frames being connected by a perforated flanged plate 4. A bush wheel 5 is bolted to the underside of the flanged plate and fitted with a rod on which is mounted a 1" pulley 6, the rod passing through one of the end holes of a sector plate 7. This sector plate 7 is connected by diagonal strips 8 to another sector plate 9, through the end hole of which a rod 10 is threaded carrying two 1" pulleys 11. An operating cord 12 passes from the pulley 11 to the pulley 6. In this way the gangway may be rotated by operating the spindle 10.

Types of Railway Signals



Model No. 30

Parts Required:

3 of No. 2	3 of No. 22
4 " " 5	1 " " 24
4 " " 12	14 " " 37
1 " " 15A	1 " " 52
1 " " 19	

Model No. 33
Scales

Parts Required:

4 of No. 2	2 of No. 22A
8 " " 5	4 " " 35
1 " " 11	19 " " 37
2 " " 12	1 " " 52
2 " " 17	2 " " 54

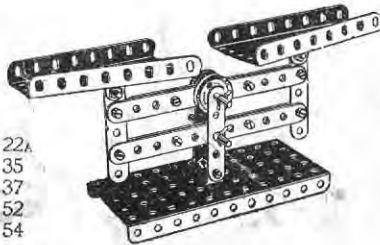

Model No. 31

In fixing the lever to the lower end of the sector plate, lock the nuts, so as to prevent the screw from working out.

Parts Required:

2 of No. 1
2 " " 2
1 " " 3
4 " " 12
1 " " 17
2 " " 22
19 " " 37
2 " " 35
1 " " 52
1 " " 54

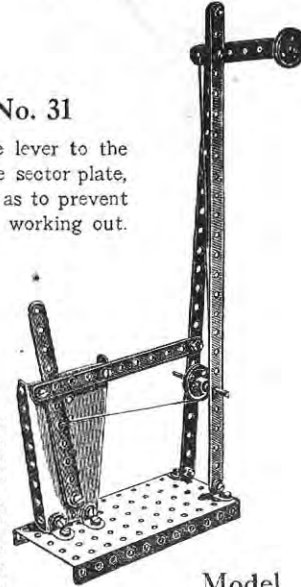

Model No. 34

The scale beam of this model is pivoted in a slot at the top of the upright standard. This slot is formed by bolting a 2½ in. strip to the standard, nuts being placed between the strip and the standard before screwing up. These nuts hold the strip and the standard at the required distance apart to give the beam, free play.

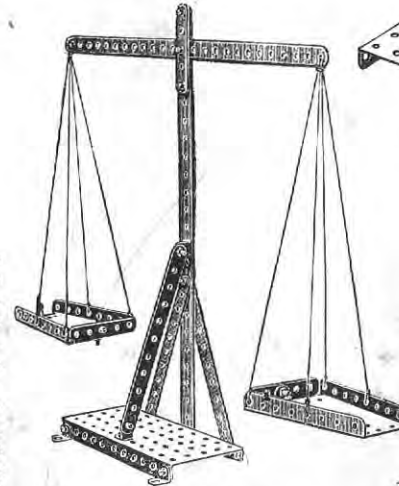

Model No. 32

Parts Required:

3 of No. 2	1 of No. 22
9 " " 5	1 " " 35
1 " " 11	16 " " 37
1 " " 17	1 " " 52

The two outside signals of this Model are operated by the levers pivoted to the upright, and the centre signal by the pulley wheel. The cord operating this latter signal is securely tied round the pulley wheel so that when the wheel is turned the signal is raised or lowered.

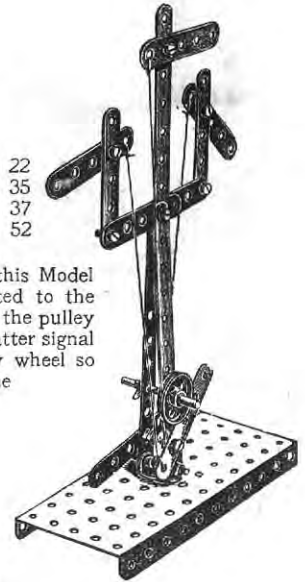

Scales

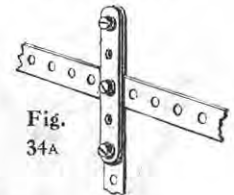
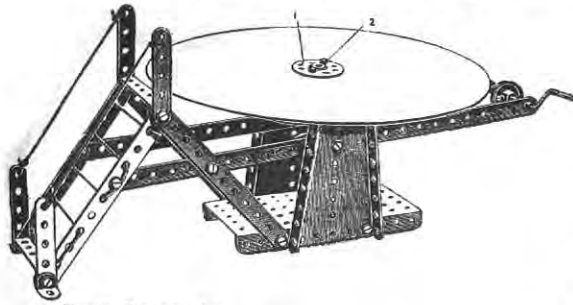

Fig. 34A

Parts Required:

2 of No. 1	19 of No. 37
3 " " 2	1 " " 52
1 " " 5	2 " " 54
4 " " 12	2 " " 60

Model No. 35 Joy Wheel



Parts Required:

2 of No. 1	3 of No. 22
4 " " 2	1 " " 24
4 " " 5	3 " " 35
2 " " 12	20 " " 37
1 " " 15A	1 " " 52
1 " " 19	2 " " 54
	3 " " 60

The driving mechanism and construction of the framework of this model are clearly brought out in Fig. 35A. Cut out a circular piece of card-board, 8" in diameter, and in the centre of the disc fix a bush wheel 1 by nuts and bolts 2. The eye of the bush wheel is then threaded over the top of the vertical spindle 3, and secured by its set-screw. The rotating table is cut out of a piece of ordinary card-board.

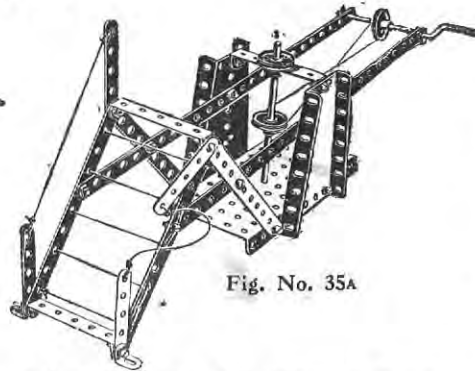
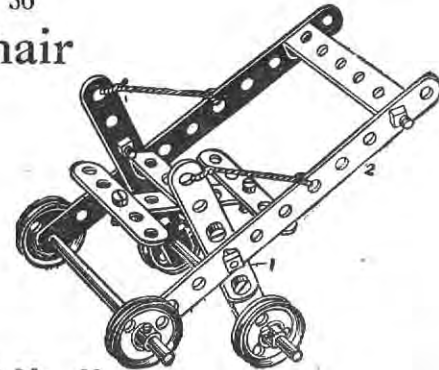

Fig. No. 35A

Model No. 36 Go Chair

Parts Required:

2 of No. 2
7 " " 5
2 " " 15A
4 " " 22
13 " " 37
2 " " 60



Model No. 38

Cot on Wheels

Parts Required:

4 of No. 2	4 of No. 22
6 " " 5	17 " " 37
2 " " 12	3 " " 60

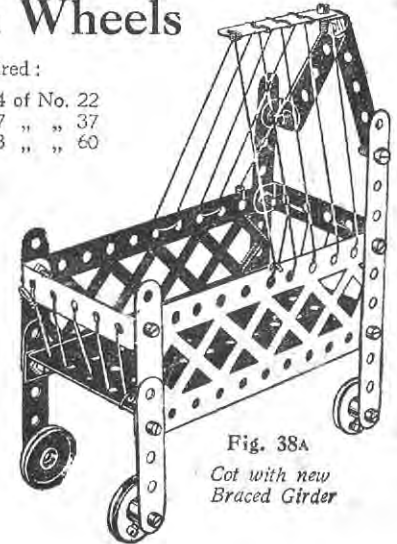

Fig. 38A
Cot with new
Braced Girder

Parts Required:

4 of No. 1
4 " " 2
6 " " 5
4 " " 10
2 " " 15A
1 " " 17
1 " " 19
3 " " 22
1 " " 24
5 " " 35
20 " " 37
1 " " 52
2 " " 54
4 " " 60

Model No. 37

Roundabout

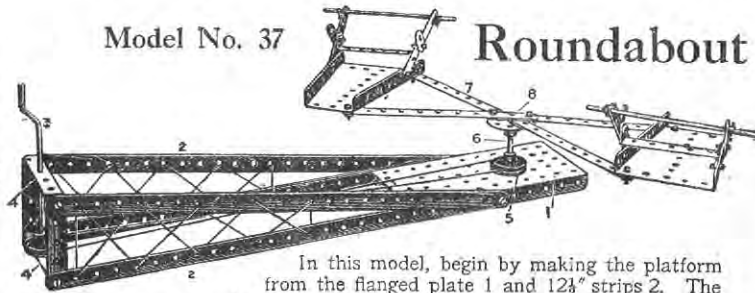

In this model, begin by making the platform from the flanged plate 1 and 12 1/2" strips 2. The bearings of the crank handle 3 are formed in 2 1/2" bent strips 4. The drive from the pulley on the crank is taken to a 1" pulley 5, fast on the spindle 6, another similar pulley being secured to the spindle beneath the flanged plate. The arms 7, formed of four 5 1/2" strips, are bolted to a bush wheel 8 fast on the spindle 6.

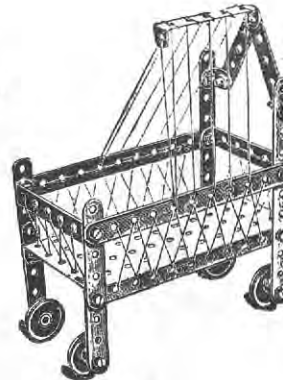

Model No. 39

Snow Plough

Fig. No. 39A

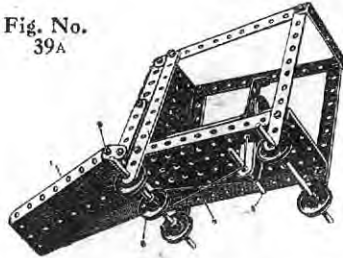

Parts Required :

6 of No.	2	2 of No.	22A
3 " "	5	1 " "	24
2 " "	60	4 " "	35
2 " "	10	19 " "	37
1 " "	12	1 " "	44
3 " "	15A	1 " "	52
1 " "	17	2 " "	54
4 " "	22		

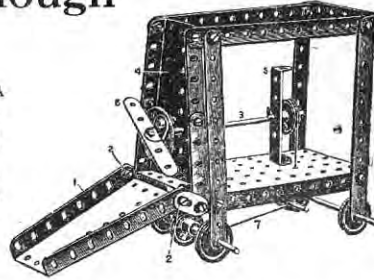

The construction of the framework of this Model presents no difficulty. The sector plate 1 forming the plough is loosely pivoted on the bolts 2. The axle 3 is mounted in the front sector plate 4 and the 2½" bent strip 5. A 2½" strip 6 is bolted by angle brackets to a bush wheel on the front of the axle and forms a dispersing propeller for the snow after it rises up the inclined sector plate 1. A continuous cord 7 is passed round a 1" pulley wheel 8 and round a short axle 9 and a 1" pulley wheel on the propeller axle. In this way, as the plough is moved along the track, the propeller is revolved.

Model No. 40

Motor Cart

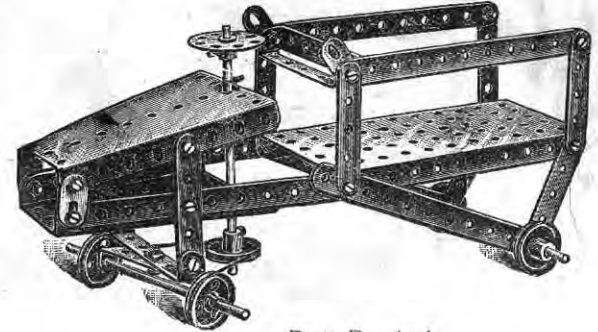

Parts Required :

6 of No.	2	1 of No.	24
8 " "	5	3 " "	35
4 " "	10	20 " "	37
3 " "	15A	1 " "	52
3 " "	22	2 " "	54
2 " "	22A	4 " "	60

Model No. 41

Monoplane

Fig. No. 41A

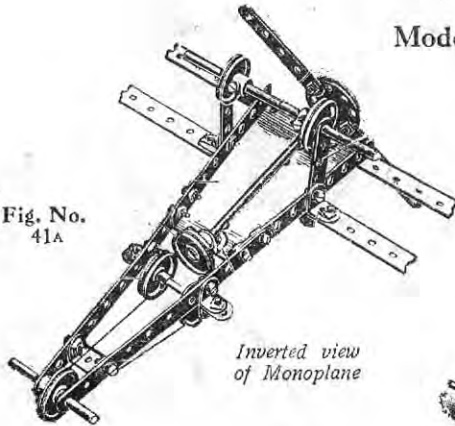

Inverted view of Monoplane

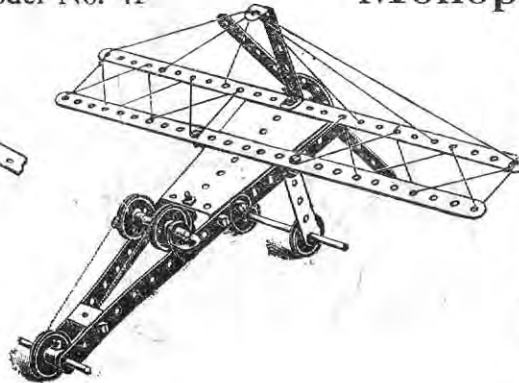

Parts Required :

2 of No.	1
2 " "	2
4 " "	5
1 " "	11
8 " "	12
2 " "	15A
1 " "	17
4 " "	22
2 " "	22A
1 " "	24
2 " "	35
18 " "	37
1 " "	54
1 " "	60

Fig. No. 41B

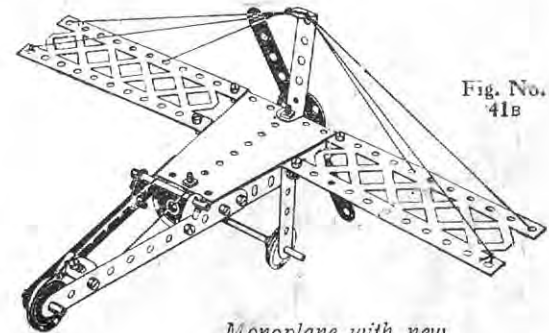

Monoplane with new Meccano Braced Girder

Model No. 42

Drilling Machine

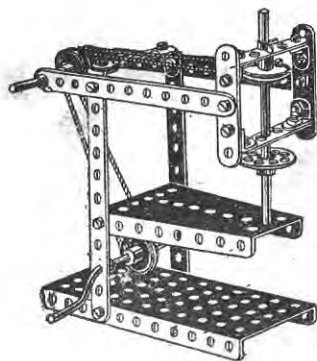

Parts Required :

4 of No.	2
5 "	5
6 "	12
2 "	15A
1 "	19
4 "	22
1 "	24
4 "	35
18 "	37
1 "	52
1 "	54

Model No. 43

Pit Headgear

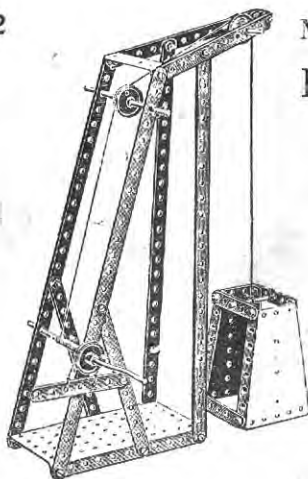

Parts Required :

4 of No.	1
4 "	2
1 "	3
4 "	5
1 "	11
1 "	15A
1 "	17
1 "	19
3 "	22
2 "	35
24 "	37
1 "	52
2 "	54

Model No. 44

Hoisting Block

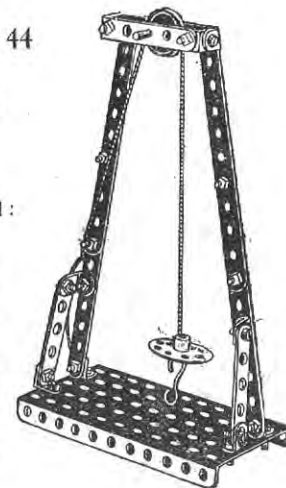

Parts Required :

4 of No.	2
3 "	5
8 "	12
1 "	17
1 "	22
1 "	24
22 "	37
1 "	52
1 "	57
1 "	60

Model No. 45

Churn

Parts Required :

6 of No.	2
4 "	5
2 "	12
2 "	15
1 "	19
2 "	22
2 "	22A
1 "	24
5 "	35
19 "	37
1 "	52
2 "	54
3 "	60

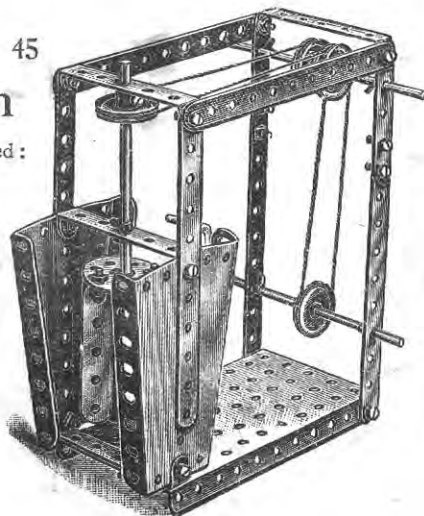

Model No. 46 Potter's Wheel

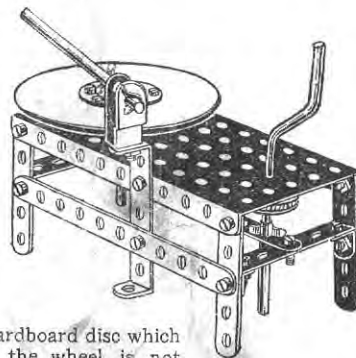

The cardboard disc which forms the wheel is not provided in the outfit.

Parts Required.

2 of No.	2
4 "	5
1 "	15A
1 "	17
1 "	19
2 "	22
1 "	24
3 "	35
16 "	37
1 "	44
1 "	52
3 "	60

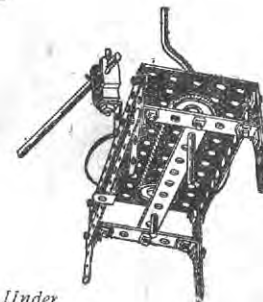

Under View of Potter's Wheel

Fig. 46A

Model No. 47

Torpedo Destroyer

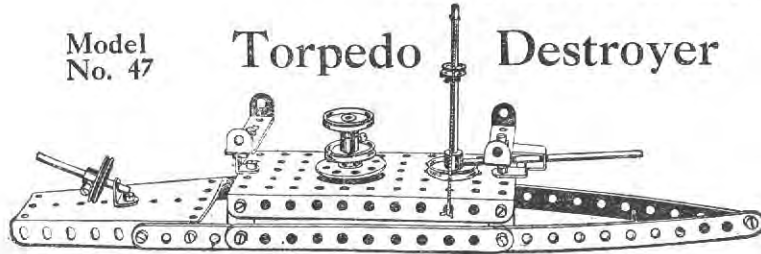

Parts Required :	4 of No. 2	1 of No. 17	19 of No. 37
	2 " " 5	4 " " 22	1 " " 44
	4 " " 10	1 " " 23	1 " " 52
	1 " " 11	1 " " 24	1 " " 54
	1 " " 12	3 " " 35	2 " " 60
	2 " " 15A		

Model No. 48 Drop Stamp

Parts Required :

4 of No. 2	4 of No. 22
7 " " 5	1 " " 24
4 " " 12	2 " " 35
2 " " 15A	20 " " 37
1 " " 19	1 " " 52
	1 " " 60

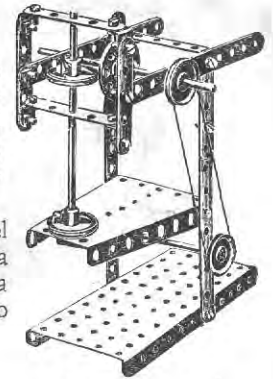

The stamp of this model is raised and dropped by a 2 1/2" strip attached to a bush wheel similar to Model No. 55.

Model No. 49

Tower Wagon

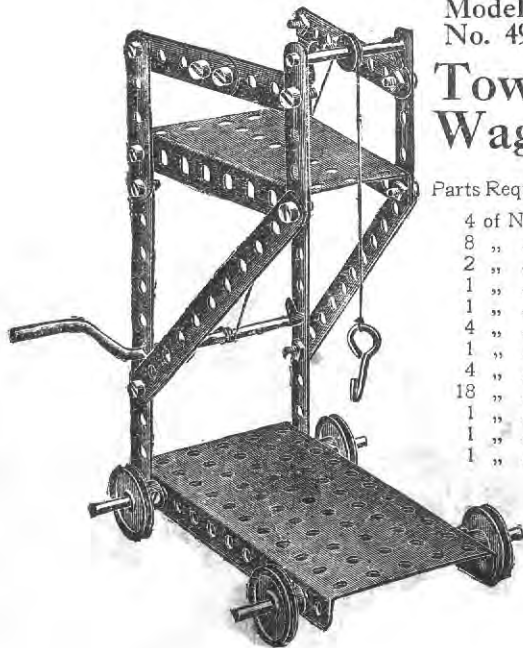

Parts Required :

4 of No. 2
8 " " 5
2 " " 15A
1 " " 17
1 " " 19
4 " " 22
1 " " 23
4 " " 35
18 " " 37
1 " " 52
1 " " 54
1 " " 57

Model No. 50 Automatic Dial Press

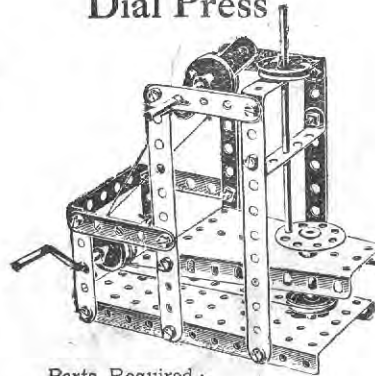

Parts Required :

4 of No. 2	2 of No. 22A
7 " " 5	1 " " 24
2 " " 15A	6 " " 35
1 " " 17	18 " " 37
1 " " 19	1 " " 52
4 " " 22	1 " " 54
	3 " " 60

Model No. 51

Tip Wagon

Parts Required :

1 of No. 2
4 " " 5
5 " " 12
3 " " 15A
4 " " 22
15 " " 37
2 " " 35
1 " " 52
2 " " 54
2 " " 60

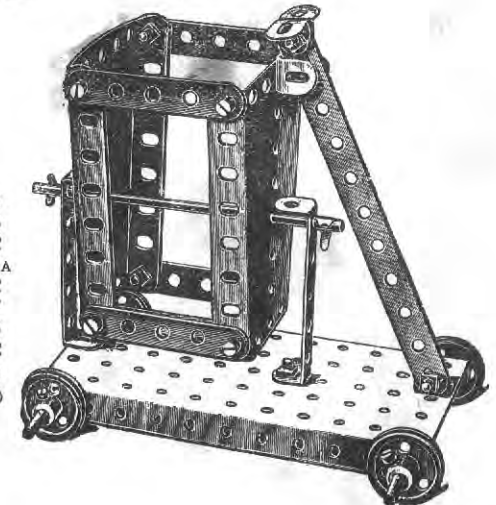

Model No. 52 Polishing Spindle

Parts Required:

- 1 of No. 2
- 4 " " 5
- 2 " " 10
- 8 " " 12
- 1 " " 15A
- 2 " " 22
- 1 " " 24
- 2 " " 35
- 15 " " 37
- 1 " " 52

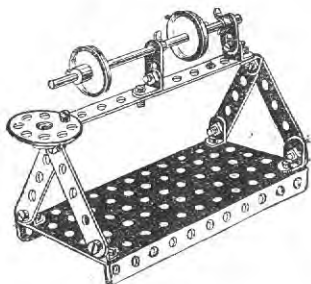

Model No. 53 High Level Bridge

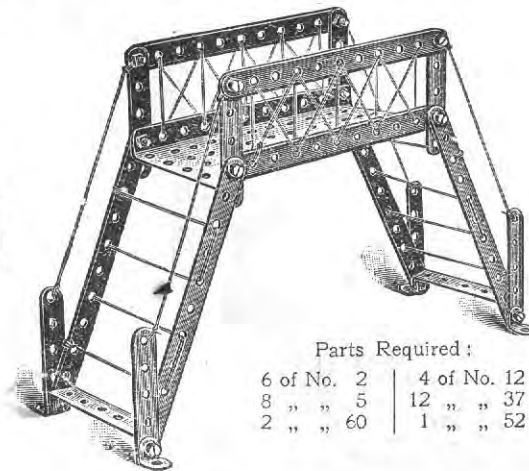
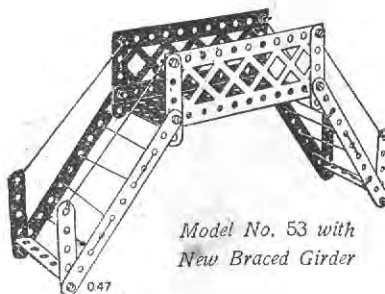

Parts Required:

- | | |
|------------|-------------|
| 6 of No. 2 | 4 of No. 12 |
| 8 " " 5 | 12 " " 37 |
| 2 " " 60 | 1 " " 52 |

Model No. 54 Level Crossing

Parts Required:

- 3 of No. 2
- 2 " " 5
- 2 " " 12
- 1 " " 17
- 4 " " 22
- 1 " " 24
- 9 " " 37
- 1 " " 52

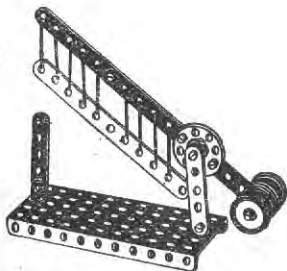

Model No. 55

Ore Crusher

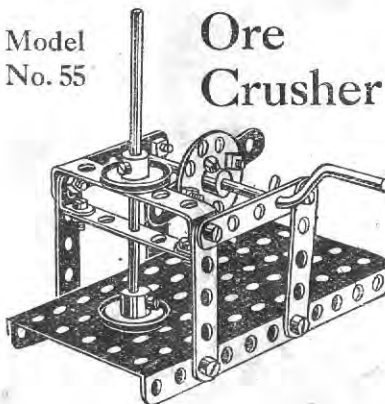

Parts Required:

- | | | |
|------------|-------------|-------------|
| 8 of No. 5 | 1 of No. 19 | 2 of No. 35 |
| 2 " " 12 | 2 " " 22 | 12 " " 37 |
| 1 " " 15A | 1 " " 24 | 1 " " 52 |
| | | 1 " " 60 |

Model No. 56 Buffing Spindle

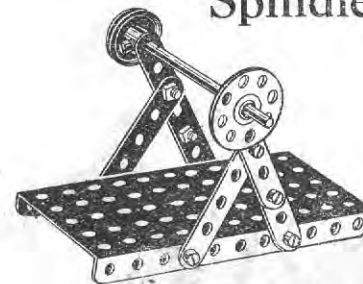

Parts Required:

- | | |
|------------|-------------|
| 6 of No. 5 | 1 of No. 24 |
| 1 " " 15A | 8 " " 37 |
| 1 " " 22 | 1 " " 52 |

Model No. 57

Metal Saw

Parts Required:

4 of No. 2	1 of No. 19
5 " " 5	2 " " 22
1 " " 10	1 " " 24
8 " " 12	2 " " 35
1 " " 17	23 " " 37
	1 of No. 52
	2 " " 60

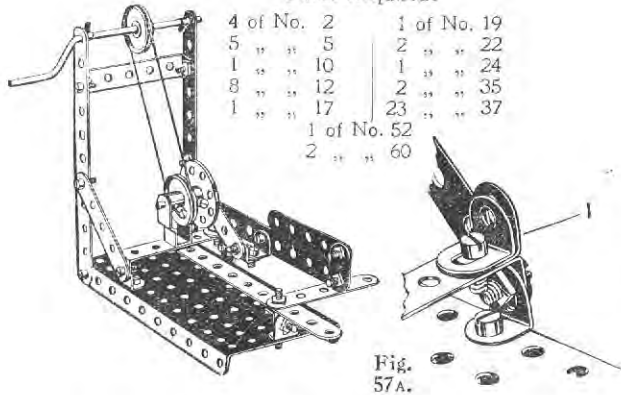

Fig. 57A.

Model No. 58

Coronation Chair

Parts Required:

4 of No. 2	9 " " 5	2 " " 10	2 " " 12	19 " " 37	1 " " 52
------------	---------	----------	----------	-----------	----------

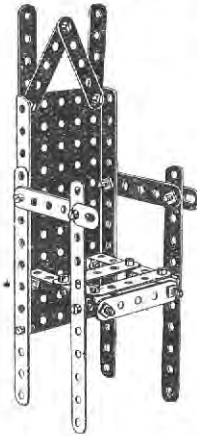

Model No. 59 Gangway

Parts Required:

2 of No. 2	8 " " 5	2 " " 10	1 " " 15A	1 " " 19	1 " " 22	1 " " 22A	3 " " 35	8 " " 37	1 " " 52	1 " " 54
------------	---------	----------	-----------	----------	----------	-----------	----------	----------	----------	----------



With new MECCANO Braced Girder

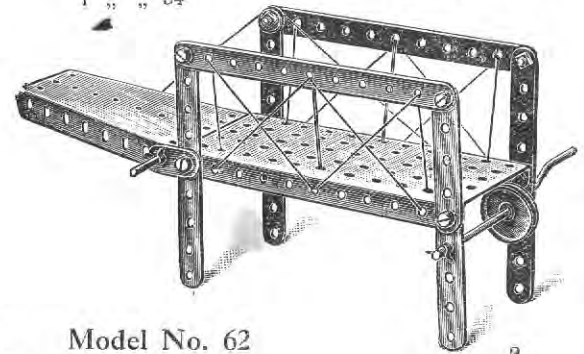

Model No. 60

Lathe

Parts Required:

6 of No. 2	2 " " 60	4 " " 12	1 " " 17	1 " " 19	3 " " 22	1 " " 24	17 " " 37	1 " " 44	1 " " 52
------------	----------	----------	----------	----------	----------	----------	-----------	----------	----------

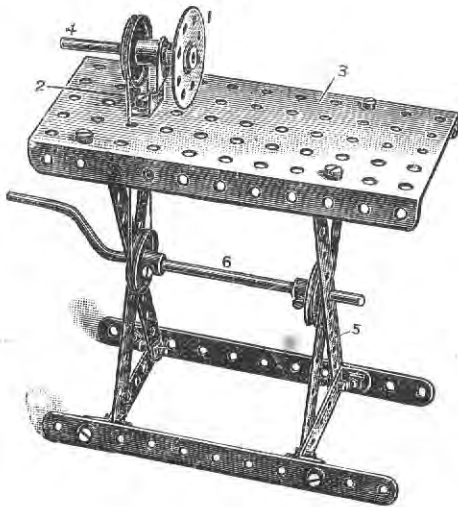

Model No. 61

Buffers

Parts Required:

2 of No. 2	2 " " 5	2 " " 17	2 " " 22	4 of No. 35	6 " " 37	1 " " 52	2 " " 60
------------	---------	----------	----------	-------------	----------	----------	----------

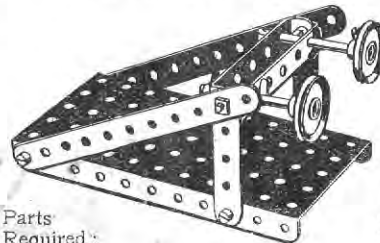

Model No. 62

Stamping Mill

Parts Required:

1 of No. 2	1 " " 3	12 " " 12	2 " " 15A	1 " " 19	4 " " 22	1 " " 24	2 " " 35	18 of No. 37	1 " " 52	2 " " 54
------------	---------	-----------	-----------	----------	----------	----------	----------	--------------	----------	----------

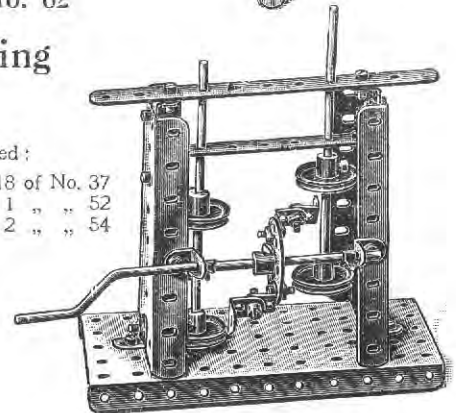

Model No. 63 **Ticca Gharry**

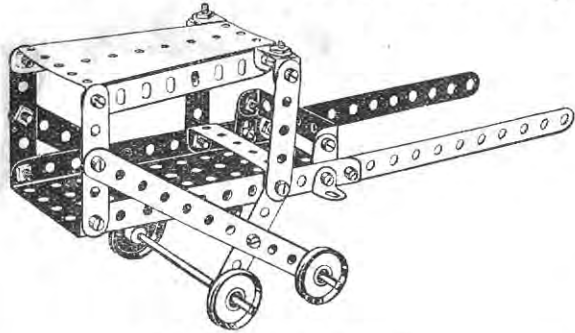

	4 of No. 2	4 of No. 22
Parts	6 " " 5	20 " " 37
Required :	2 " " 10	1 " " 52
	6 " " 12	1 " " 54
	2 " " 15A	2 " " 60

Model No. 64
Sharpshooter Gun

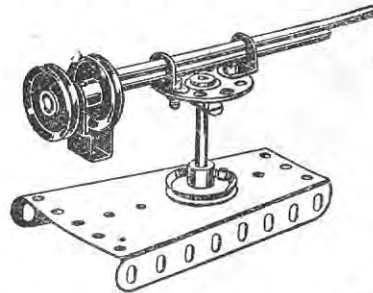

Parts Required :

2 of No. 12
2 " " 15A
1 " " 17
4 " " 22
1 " " 24
2 " " 37
1 " " 44
1 " " 54

Model No. 65
Sleigh

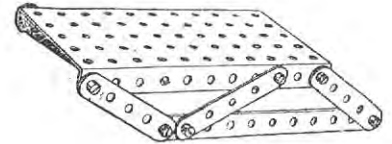

Parts Required :

2 of No. 2
6 " " 5
12 " " 37
1 " " 52

Model No. 66

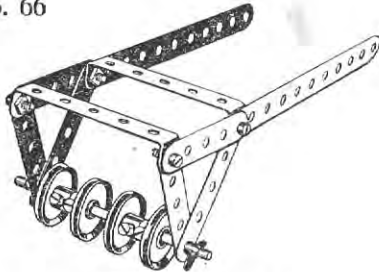

Furrowing Roller

	2 of No. 2	2 of No. 35
Parts	6 " " 5	4 " " 37
Required :	1 " " 15A	2 " " 60
	4 " " 22	

Anti-Aircraft Gun

Model No. 67

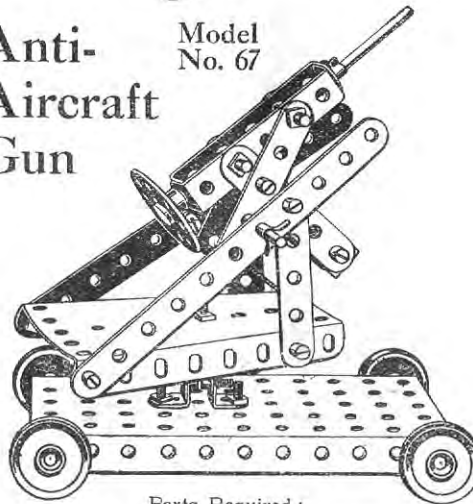

Parts Required :

2 of No. 2	4 of No. 22	1 of No. 44
6 " " 5	1 " " 24	1 " " 52
4 " " 12	5 " " 35	1 " " 54
2 " " 15A	23 " " 37	2 " " 60

Stamping Machine

Model No. 68

Parts Required :

4 of No. 2
8 " " 5
2 " " 12
2 " " 15A
1 " " 19
4 " " 22
1 " " 24
3 " " 35
20 " " 37
1 " " 52
2 " " 60

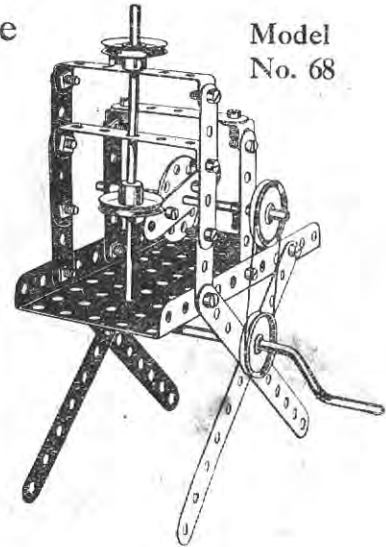

Model No. 69 Timber Drag

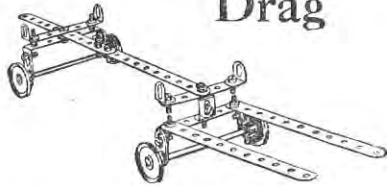

Parts Required:	4 of No. 2	4 of No. 22
	4 " " 10	18 " " 37
	6 " " 12	3 " " 60
	2 " " 15A	

Steering Truck

Model No. 70

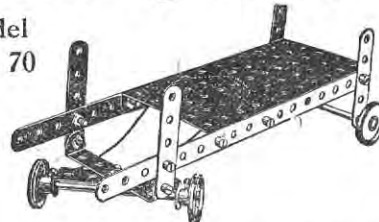

Parts Required:	2 of No. 2	11 of No. 37
	4 " " 5	1 " " 52
	2 " " 15A	2 " " 60
	4 of No. 22	

Boiler Truck

Model No. 71

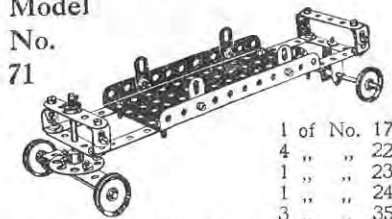

Parts Required:	8 of No. 5	1 of No. 17
	4 " " 10	4 " " 22
	8 " " 12	1 " " 23
	2 " " 15A	1 " " 24
		3 " " 35
		23 " " 37
		1 " " 44
		1 " " 52
		1 " " 60

Model No. 73 Lurry

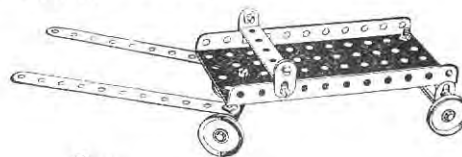

Parts Required:	2 of No. 2	13 of No. 37
	4 " " 10	1 " " 24
	2 " " 12	1 " " 52
	2 " " 15A	2 " " 60
	4 of No. 22	

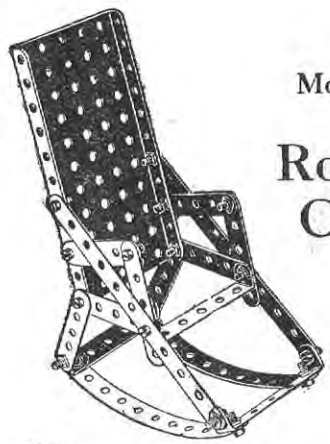

Model No. 72 Rocking Chair

Parts Required:	4 of No. 2	18 of No. 37
	9 " " 5	1 " " 52
	2 " " 12	1 " " 60

Model No. 74 Watch Stand



Parts Required:	4 of No. 2	1 of No. 35
	1 " " 17	8 " " 37
	1 " " 22	1 " " 52
	1 " " 23	1 " " 57
	1 " " 24	1 " " 60

Model No. 75 Telegraph Code Key

Parts Required:

3 of No. 2	1 of No. 22
1 " " 10	12 " " 37
5 " " 12	1 " " 52

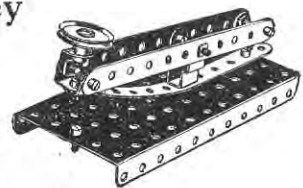

Model
No. 76

Drop Hammer

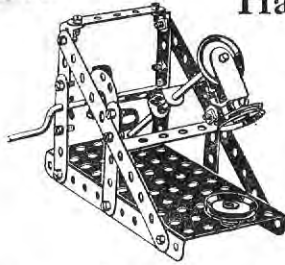

Parts Required:	2 of No. 2	3 of No. 22
	7 " " 5	1 " " 24
	6 " " 12	23 " " 37
	1 " " 15A	1 " " 44
	1 " " 19	1 " " 52
	2 of No. 60	

Model
No. 79

Double- Drop Hammer

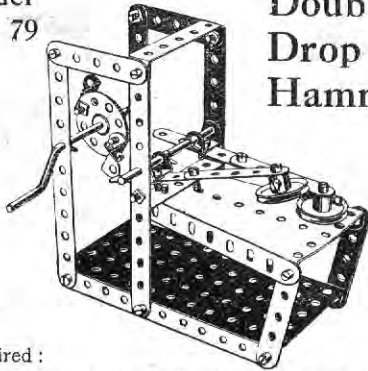

Parts Required:	4 of No. 2	1 of No. 19	22 of No. 37
	8 " " 5	2 " " 22	1 " " 52
	8 " " 12	1 " " 24	1 " " 54
	1 " " 15A	4 " " 35	2 " " 60

Model
No. 77

Roulette Wheel

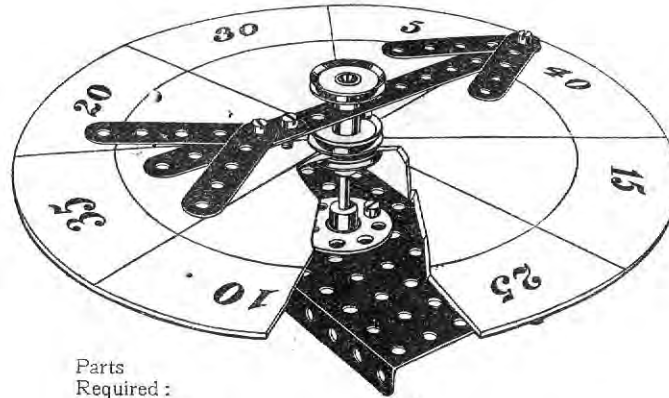

Parts
Required:

1 of No. 2
5 " " 5
1 " " 15A
3 " " 22
1 " " 24
5 " " 37
1 " " 52

Cut out a circular piece of cardboard and mark as shown to form scoring board. This is clamped between two 1" pulley wheels. The pointer revolves freely on the upright spindle and is held in position by another 1" pulley wheel.

Model No. 80

Bogey Truck

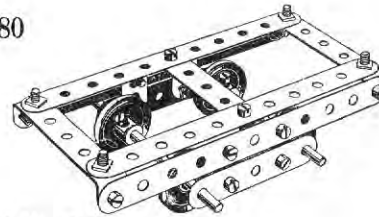

Parts
Required:

4 of No. 2	4 of No. 22
3 " " 5	18 " " 37
4 " " 10	2 " " 60
2 " " 15A	

Model
No. 78

Spinning Top

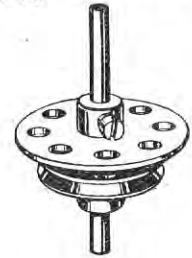

Parts Required:	1 of No. 17
	1 " " 22
	1 " " 24

Band Saw

Model
No. 81

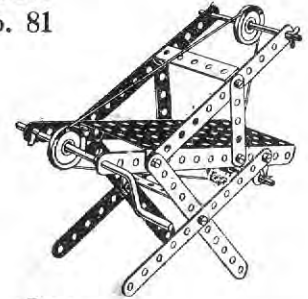

Parts
Required:

6 of No. 2	3 of No. 22
4 " " 5	6 " " 35
2 " " 10	10 " " 37
2 " " 15A	1 " " 52
1 " " 19	2 " " 60

Gong

Model No. 82

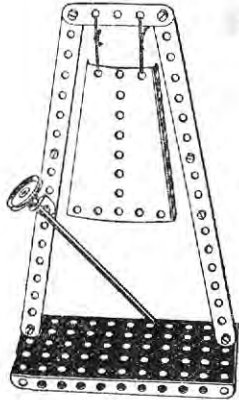

- Parts Required:
- 2 of No. 2
 - 1 " " 5
 - 3 " " 12
 - 1 " " 15A
 - 1 " " 22
 - 10 " " 37
 - 1 " " 52
 - 1 " " 54

Model No. 83

Horse Sleigh

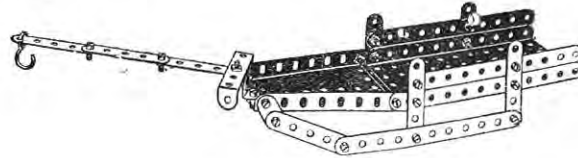

- | | | |
|-----------|------------|--------------|
| Parts | 4 of No. 2 | 25 of No. 37 |
| Required: | 9 " " 5 | 1 " " 52 |
| | 4 " " 10 | 1 " " 54 |
| | 2 " " 12 | 1 " " 57 |

Model No. 84

Motor Van

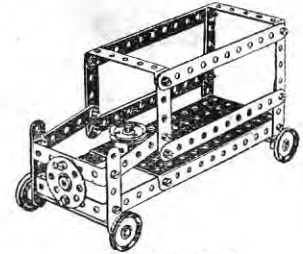

Parts Required:

- | | | |
|------------|--------------|--------------|
| 6 of No. 2 | 2 of No. 15A | 22 of No. 37 |
| 1 " " 3 | 4 " " 22 | 1 " " 52 |
| 9 " " 5 | 1 " " 22A | 4 " " 60 |
| 1 " " 11 | 1 " " 24 | |

Model No. 85

Rock Drill

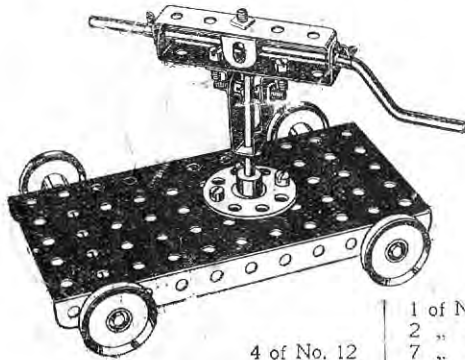

- | | | |
|-----------------|-------------|-------------|
| Parts Required: | 4 of No. 12 | 1 of No. 24 |
| | 1 " " 15A | 2 " " 35 |
| | 1 " " 19 | 7 " " 37 |
| | 1 " " 22 | 1 " " 44 |
| | | 1 " " 52 |
| | | 2 " " 60 |

Model No. 86

Bed Table

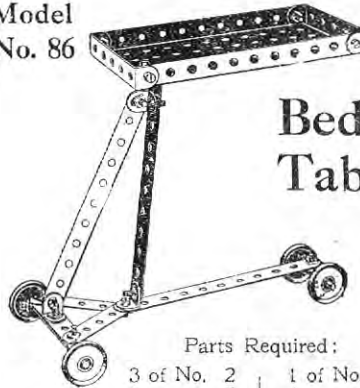

Parts Required:

- | | |
|------------|-------------|
| 3 of No. 2 | 1 of No. 17 |
| 2 " " 5 | 4 " " 22 |
| 1 " " 11 | 15 " " 37 |
| 4 " " 12 | 1 " " 52 |
| 1 " " 15A | 3 " " 60 |

Model No. 87

Motor Lurry

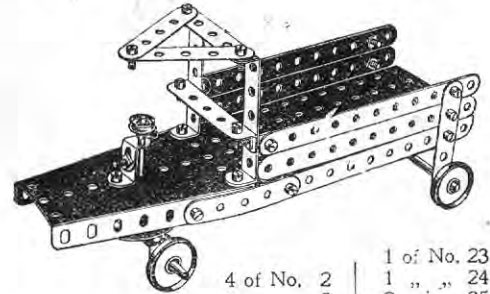

- | | | |
|-----------------|------------|-------------|
| Parts Required: | 4 of No. 2 | 1 of No. 23 |
| | 8 " " 5 | 1 " " 24 |
| | 8 " " 12 | 2 " " 35 |
| | 2 " " 15A | 25 " " 37 |
| | 1 " " 17 | 1 " " 52 |
| | 4 " " 22 | 1 " " 54 |
| | | 2 " " 60 |

Model No. 88 Lawn Mower

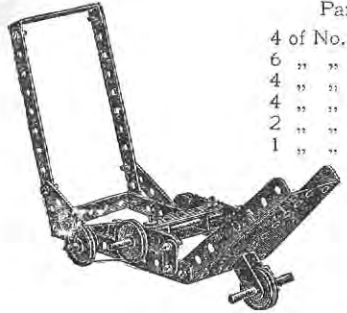

Parts Required:

4 of No. 2	4 of No. 22
6 " " 5	21 " " 37
4 " " 10	1 " " 44
4 " " 12	1 " " 54
2 " " 15A	2 " " 60
1 " " 17	

Model No. 89 Foot Cycle

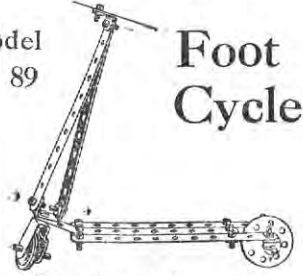

Parts Required:

5 of No. 2	1 of No. 22
1 " " 5	1 " " 24
4 " " 10	4 " " 35
1 " " 11	15 " " 37
3 " " 12	1 " " 44
2 " " 17	

Model No. 90 Cart

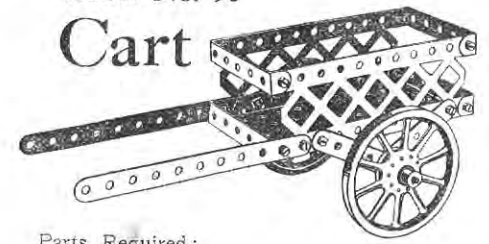

Parts Required:

4 of No. 2	2 of No. 22	2 of No. 59
4 " " 5	15 " " 37	4 " " 60
1 " " 15	1 " " 44	2 " " 100
2 " " 19A	1 " " 52	

Model No. 91 Deck Chair



Parts Required:

4 of No. 1	1 of No. 15A
4 " " 2	30 " " 37
1 " " 3	1 " " 52
6 " " 5	2 " " 60
6 " " 12	

Model No. 92 Invalid Chair

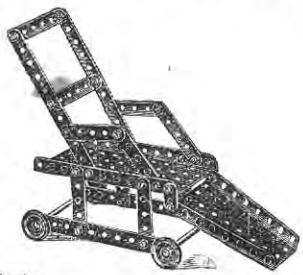

Parts Required:

4 of No. 2	22 of No. 37
8 " " 5	1 " " 52
2 " " 10	1 " " 54
2 " " 15A	2 " " 60
4 " " 22	

Forge Bellows Model No. 93

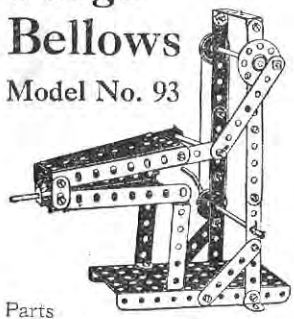

Parts Required:

4 of No. 2	1 of No. 19
1 " " 3	2 " " 22
2 " " 5	1 " " 24
2 " " 10	5 " " 35
1 " " 11	25 " " 37
2 " " 12	1 " " 52
2 " " 15A	2 " " 54
1 " " 17	3 " " 60

Model No. 94 Coster's Barrow

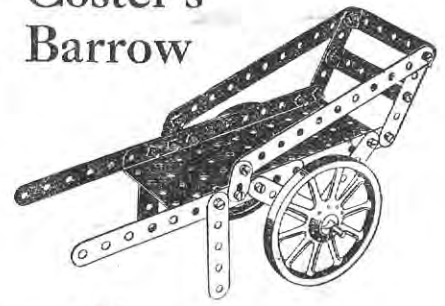

Parts Required:

4 of No. 2	4 of No. 35
8 " " 5	16 " " 37
2 " " 10	1 " " 52
1 " " 15A	2 " " 60
2 " " 19A	

Sighting Rule

Model No. 95

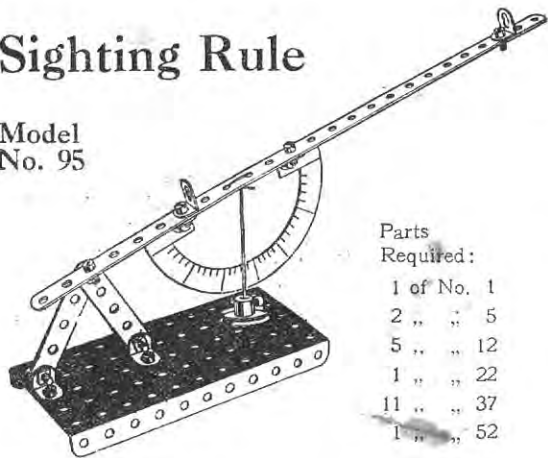

- Parts Required:
- 1 of No. 1
 - 2 " " 5
 - 5 " " 12
 - 1 " " 22
 - 11 " " 37
 - 1 " " 52

Devil Wall

Model No. 96

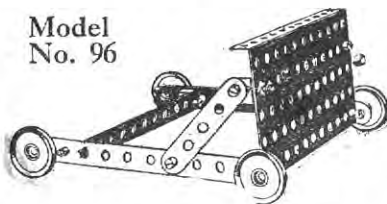

- Parts Required:
- | | |
|------------|-------------|
| 3 of No. 2 | 4 of No. 22 |
| 2 " " 5 | 18 " " 37 |
| 6 " " 12 | 1 " " 52 |

Model No. 97

Hatchet

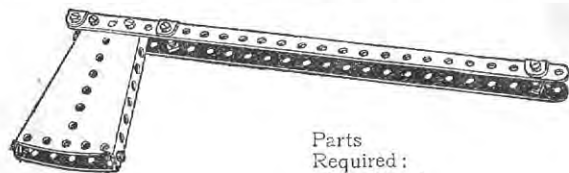

- Parts Required:
- 3 of No. 1
 - 6 " " 12
 - 15 " " 37
 - 2 " " 54

Model No. 98

Mail Bag Hanger

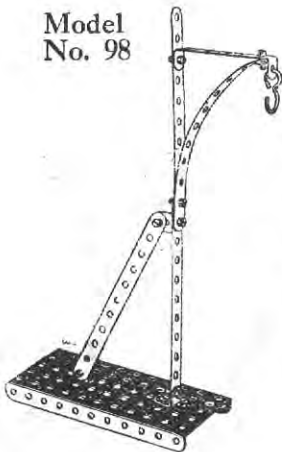

- Parts Required:
- 4 of No. 2
 - 4 " " 12
 - 10 " " 37
 - 1 " " 52
 - 1 " " 57
 - 1 " " 60

Model No. 99

Music Stand

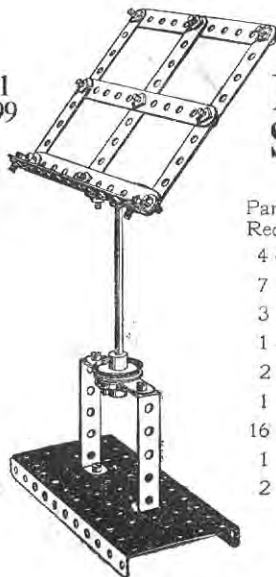

- Parts Required:
- 4 of No. 2
 - 7 " " 5
 - 3 " " 12
 - 1 " " 15A
 - 2 " " 22
 - 1 " " 24
 - 16 " " 37
 - 1 " " 52
 - 2 " " 60

Punching Machine

Model No. 100

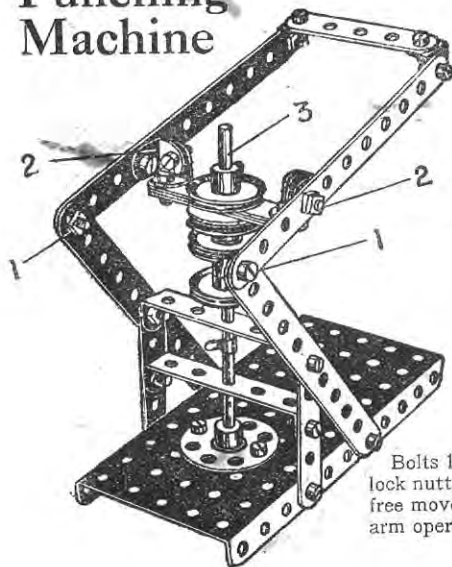

- Parts Required:
- 4 of No. 2
 - 7 " " 5
 - 6 " " 12
 - 1 " " 15A
 - 4 " " 22
 - 1 " " 24
 - 1 " " 35
 - 22 " " 37
 - 1 " " 52
 - 2 " " 60

Bolts 1—1 and 2—2 are lock nutted so as to permit free movement of the lever arm operating the punch 3.

Anchor

Model No. 101

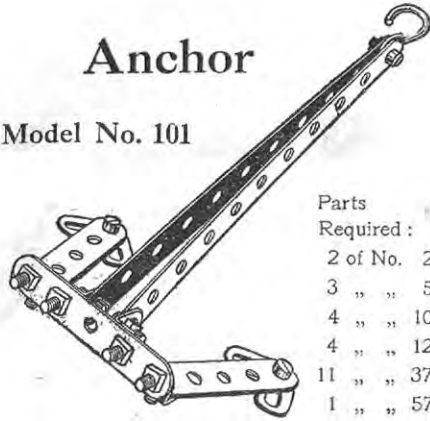

Parts Required :

2 of No. 2
3 " " 5
4 " " 10
4 " " 12
11 " " 37
1 " " 57

Model No. 102

Invalid Chair

Parts Required :

4 of No. 2	1 of No. 44
2 " " 5	2 " " 60
2 " " 15A	
1 " " 18	
3 " " 22	
1 " " 24	
2 " " 35	
13 " " 37	

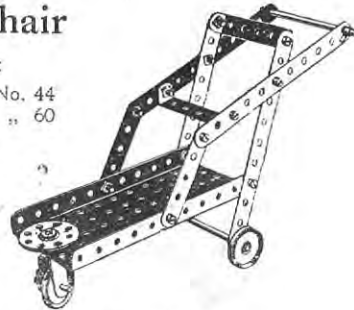

Model No. 105 Jib Crane

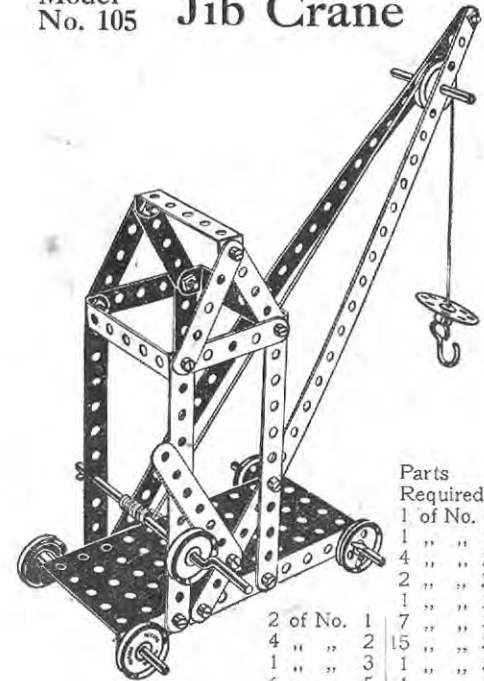

Parts Required :

1 of No. 17
1 " " 19
4 " " 22
2 " " 22A
1 " " 24
1 " " 35
7 " " 37
15 " " 37
1 " " 3
1 " " 52
6 " " 5
1 " " 57
2 " " 15A
3 " " 60

Model No. 103 Grill

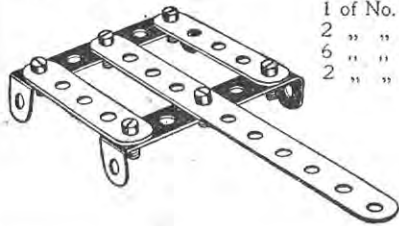

Parts Required :

1 of No. 2
2 " " 5
6 " " 37
2 " " 60

Model No. 104

Mountain Transport

Parts Required :

2 of No. 1	3 of No. 5	4 of No. 22
2 " " 2	4 " " 12	18 " " 37
	2 " " 15A	1 " " 52
		1 " " 54
		2 " " 60

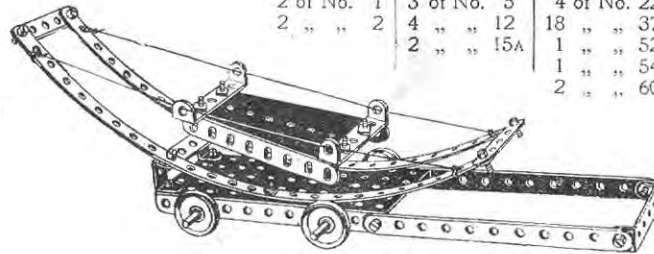

HOW TO CONTINUE

This completes the Models which may be made with Meccano Outfit No. 1. The next Models are a little more advanced, requiring a number of extra parts to construct them. The necessary parts are all contained in a No. 1A Accessory Outfit, the cost of which will be found in the Price List at the end of the Manual.

Model No. 106
**Motor
Van**

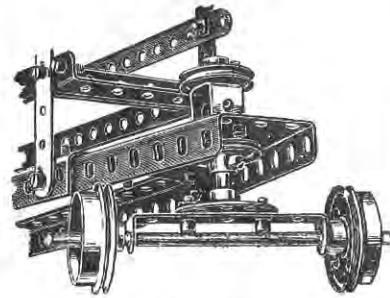
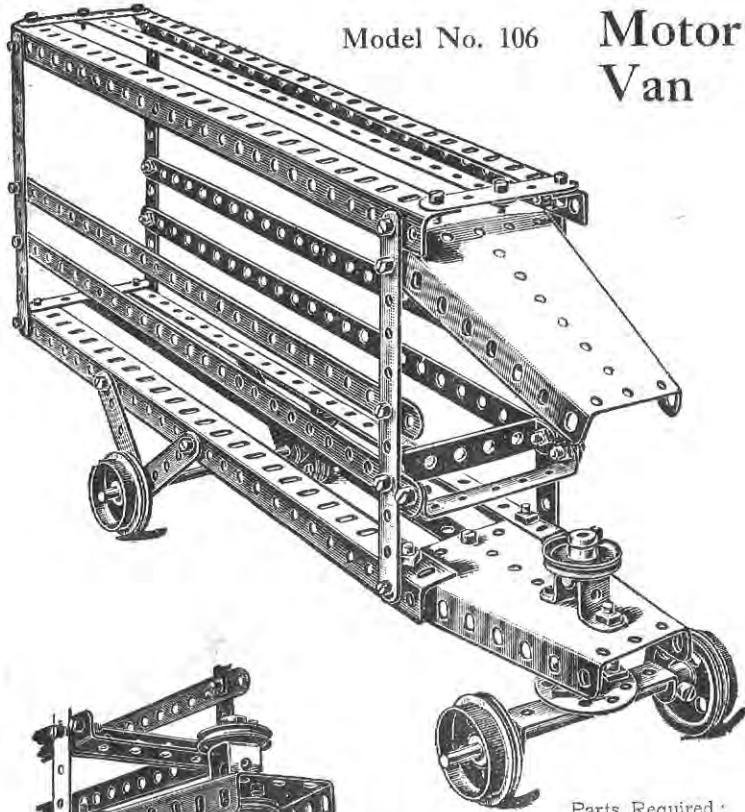

Fig. 106A

Parts Required :

6 of No.	1	2 of No.	22
4 "	" 2	1 "	" 24
7 "	" 5	40 "	" 37
4 "	" 8	1 "	" 45
1 "	" 17	2 "	" 54
4 "	" 20	3 "	" 60
2 "	" 15		

Tipping Motor Wagon

Model
No. 107

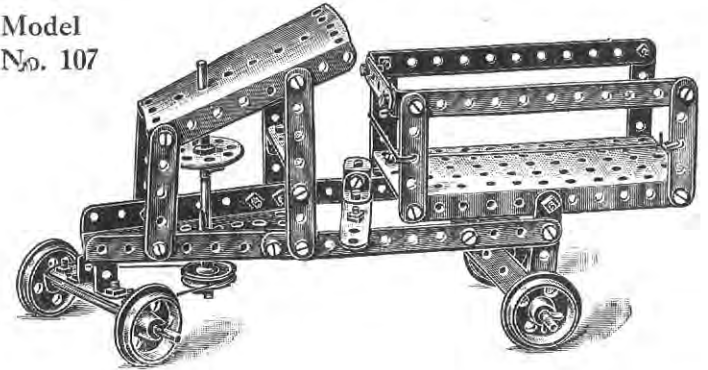

Parts
Required :

4 of No.	2
2 "	" 3
12 "	" 5
5 "	" 12
3 "	" 15
4 "	" 20
1 "	" 22
1 "	" 24
38 "	" 37
1 "	" 45
1 "	" 52
2 "	" 54
3 "	" 60

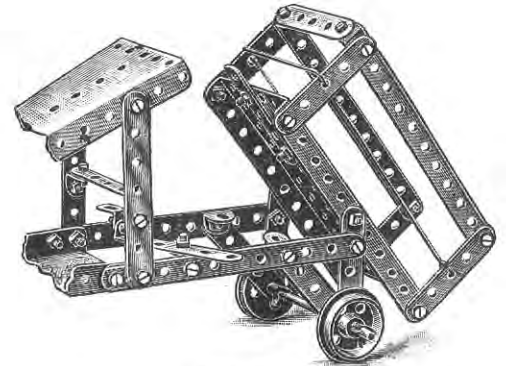

Fig. 107A

Model No. 108 Swing Bridge

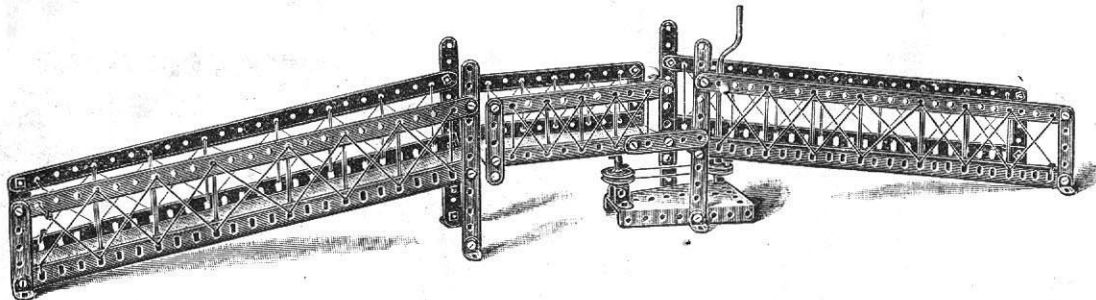
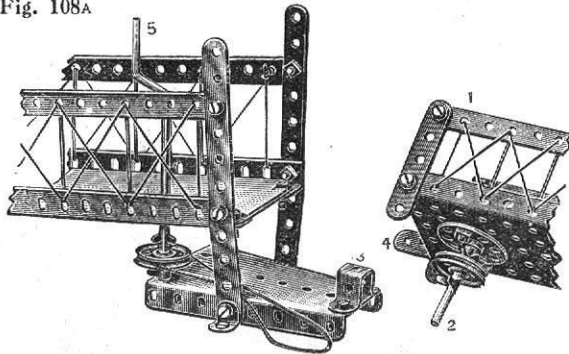

Fig. 108A



Parts Required :

4 of No. 1	1 of No. 24
6 " " 2	1 " " 35
9 " " 5	31 " " 37
4 " " 8	1 " " 45
8 " " 12	1 " " 52
1 " " 17	1 " " 54
1 " " 19	4 " " 60
2 " " 22	

The action for swinging the middle section of the Bridge will be made clearer by the detail Fig. 108A, the middle section 1 being fitted with a spindle 2 journalled in the double bent strip 3; the upper end of the spindle being secured to a bush wheel.

A short strip 4 acts as a stop against the middle section of the Bridge swinging past the central position.

The operating cord passes round pulleys on the spindles 2 and crank handle 5.

Ladder on Wheels

Model No. 109

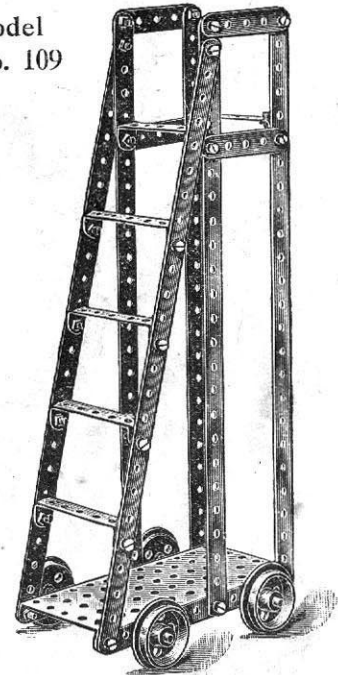

Parts Required :

6 of No. 1	24 of No. 37
4 " " 5	1 " " 52
2 " " 15	6 " " 60
4 " " 20	

Model No. 110 Travelling Jib Crane

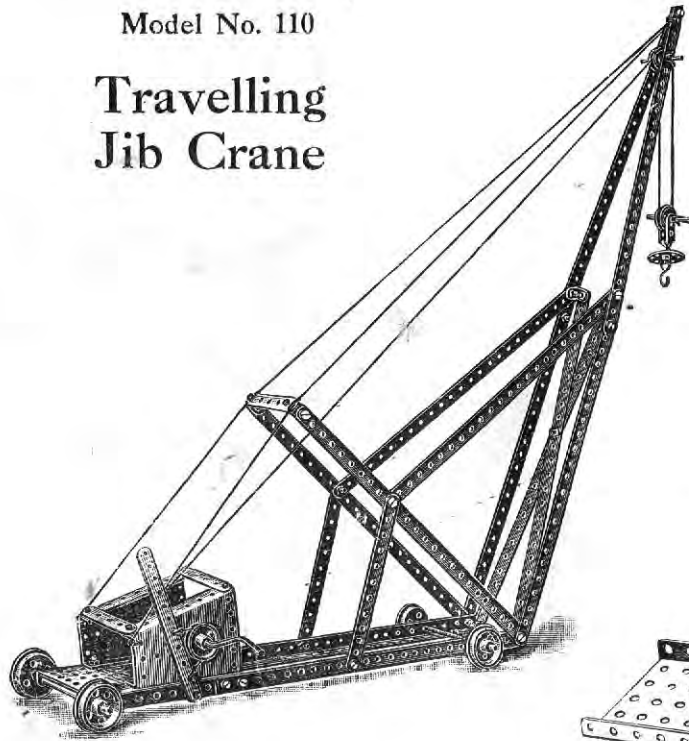

Parts Required :

10 of No. 1	2 of No. 15A	1 of No. 24	35 " " 37
3 " " 2	2 " " 17	1 " " 57	
3 " " 5	1 " " 19	5 " " 35	
1 " " 60	4 " " 20	1 " " 44	
2 " " 8	2 " " 22	1 " " 52	
4 " " 12	1 " " 22A	2 " " 54	

Model No. 111 Roundabout Seesaw

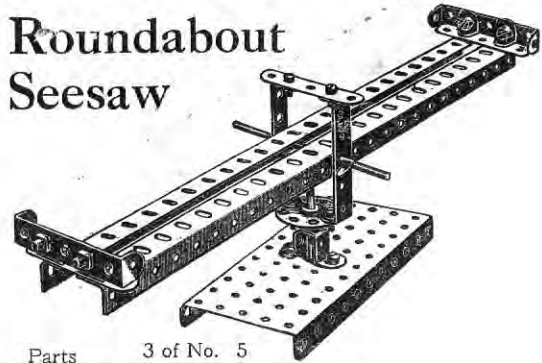

Parts Required :

3 of No. 5	14 of No. 37
2 " " 8	1 " " 45
4 " " 12	1 " " 52
1 " " 15	4 " " 60
1 " " 24	
2 " " 35	

Model No. 112 Carrier Tricycle

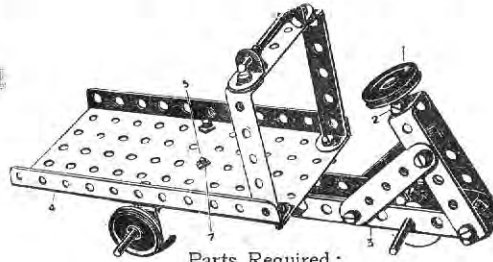

Parts Required :

2 of No. 2	3 of No. 22
3 " " 5	1 " " 24
1 " " 11	2 " " 35
2 " " 12	16 " " 37
1 " " 15	1 " " 52
2 " " 17	5 " " 60

Fig. 112A

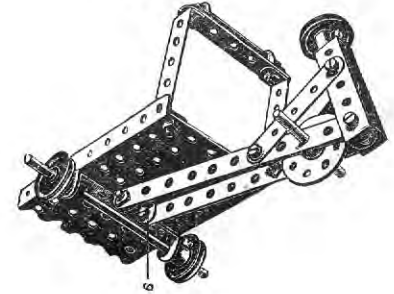

Model No. 113

Three-arm Signal

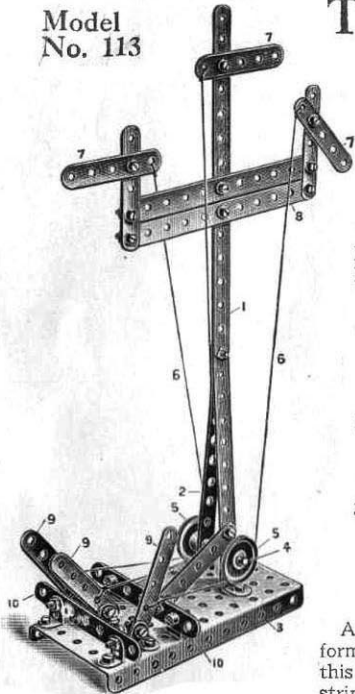

Parts Required:

1	of No. 1
3	" " 2
2	" " 3
9	" " 5
10	" " 12
1	" " 17
2	" " 22
37	" " 37
1	" " 52

A flanged plate forms the base of this model, a 12½" strip 1 being bolt-

ed to a 5½" strip 2, the feet of both these strips being connected to the flanged plate 3 by angle brackets. A rod 4 is passed through the lower holes of the strips 1 and 2 and is fitted with guide pulley 5 leading the actuating cords 6 to the signal arms 7. The cord operating the central arm is run under the rod 4. The signal arms 7 are carried from transverse strips 8. The operating cords 6 are led to three strips 9, pivoted to angle brackets bolted to the flanged plate, and transverse strips 10 are bolted to the perforated plate in the front and rear of the pivoted strips 9 to limit their movement.

Types of Windmills

Model No. 114

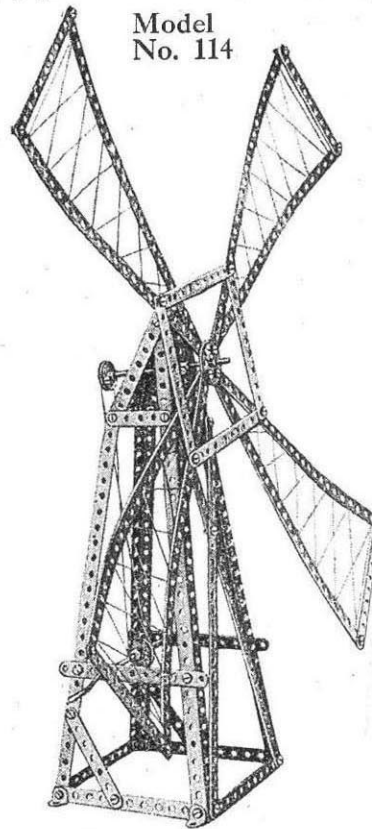

Parts Required:

10	of No. 1	1	of No. 19
13	" " 2	2	" " 22
2	" " 3	1	" " 24
2	" " 5	4	" " 35
4	" " 8	45	" " 37
4	" " 12	2	" " 54
1	" " 15		

Model No. 115

Parts Required:

4	of No. 2
2	" " 60
1	" " 15
1	" " 19
2	" " 22
1	" " 24
12	" " 37
3	" " 35
1	" " 52
4	" " 61

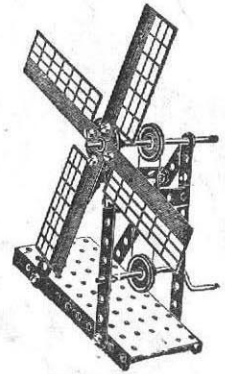

Model No. 116

Parts Required:

4	of No. 1
7	" " 5
2	" " 60
2	" " 12
1	" " 15
1	" " 19
2	" " 22
1	" " 24
20	" " 37
4	" " 35
1	" " 52
4	" " 61

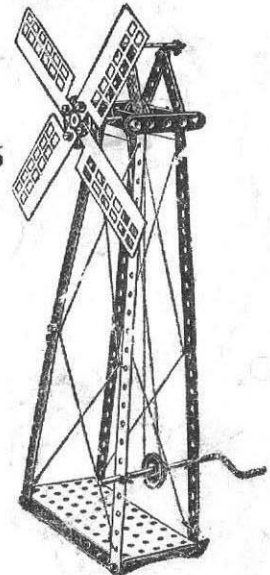

These Models can be made with MECCANO Outfit No. 2, or No. 1 and No. 1A

Model No. 117 Monoplane

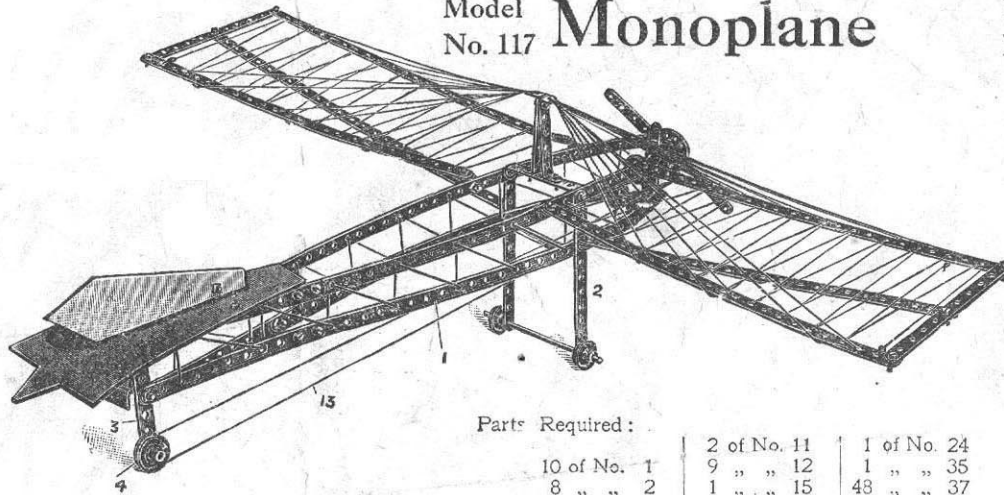
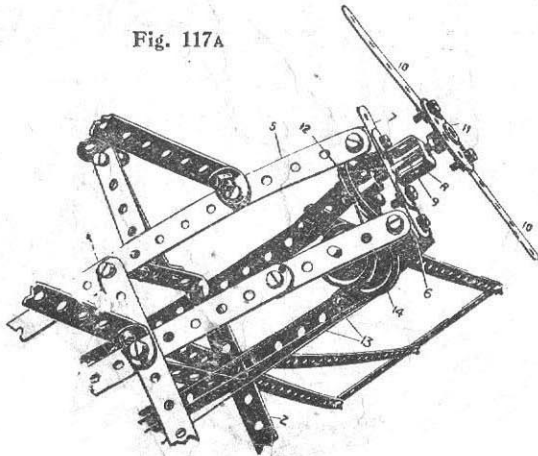

Fig. 117A

Parts Required:

10 of No. 1	2 of No. 11	1 of No. 24
8 " " 2	9 " " 12	1 " " 35
1 " " 3	1 " " 15	48 " " 37
7 " " 5	1 " " 17	1 " " 45
	4 " " 22	4 " " 60
	2 " " 22	

Model No. 119 Wheel



Parts Required:

5 of No. 1
12 " " 2
2 " " 5
4 " " 8
4 " " 11
2 " " 15
3 " " 20
2 " " 22
44 " " 37

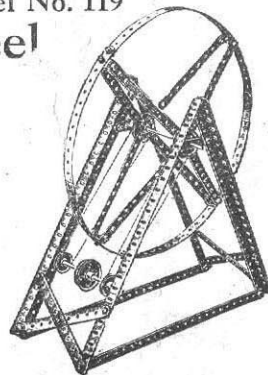

Model No. 118 Ferry Gangway

The vertical standard is built up from two angle girders, the slotted holes overlapped to form channel section girder.

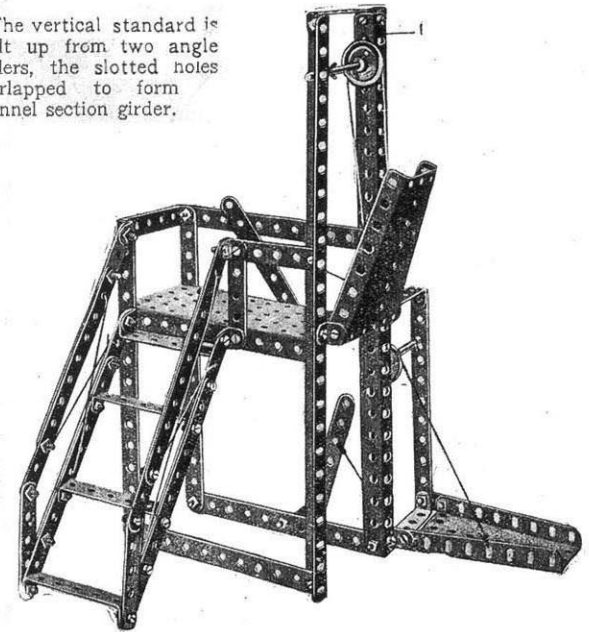

Parts Required:

14 of No. 2	2 of " 15	50 of No. 37
2 " " 3	2 " " 17	1 " " 45
6 " " 5	2 " " 22	1 " " 52
3 " " 8	2 " " 22A	2 " " 54
2 " " 10	6 " " 35	6 " " 60
7 " " 12		

Model No. 120 **Roundabout**

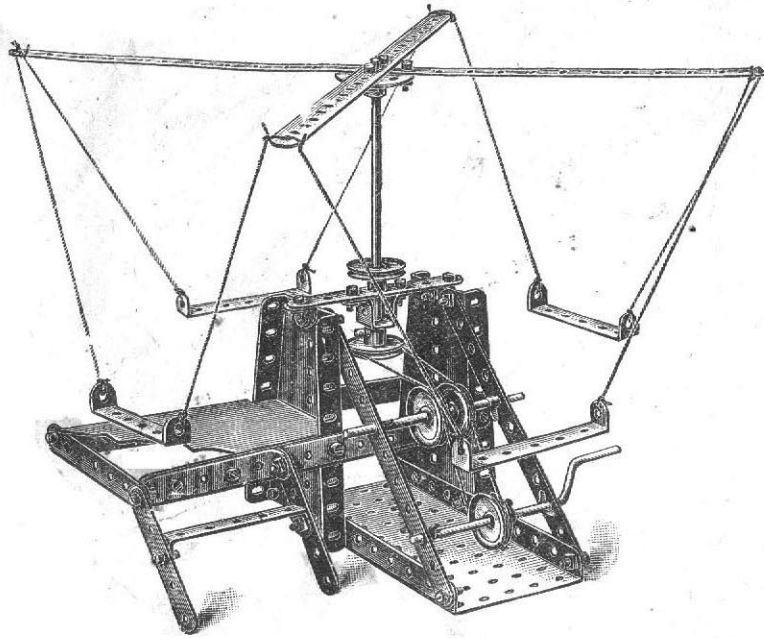

Parts Required :	2 of No. 1	2 of No. 22A
	4 " " 2	1 " " 24
	2 " " 3	4 " " 35
	4 " " 5	33 " " 37
	3 " " 12	1 " " 45
	1 " " 15	1 " " 52
	1 " " 16	2 " " 54
	1 " " 19	6 " " 60
	3 " " 22	

Railway Foot Bridge and Signals

Model No. 121

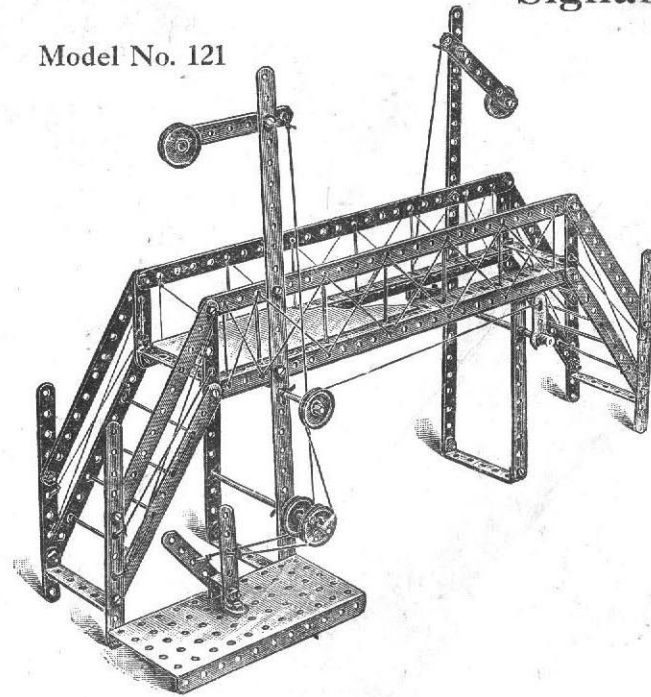

Parts Required :	4 of No. 1	2 of No. 8	6 of No. 35
	14 " " 2	2 " " 22A	1 " " 45
	2 " " 3	3 " " 22	4 " " 60
	8 " " 5	43 " " 37	2 " " 62
	3 " " 15	1 " " 52	

Model No. 122 Extending Ladder on Running Carriage

The bed of the lower carriage framework 1 is formed by bolting two 12½" strips to the sides of a large flanged plate 2, and two sector plates 3 bolted to the flanged plate by their flanges to form the sides, and a bearing for the spindle 4 carrying the operating cord 5 to raise the ladder from a horizontal position. The strips 6 form a support for the ladder when in this horizontal position. Angle brackets 7, Fig. 122A, form pivots for the lower part 8 of the ladder, and are carried from the supports 9. The upper part of the ladder 10, Fig. 122B, is slidably guided and retained on the lower ladder 8 by double brackets 11. The extension of the ladder is effected by the cranked spindle 12, round a pulley 13, on which and another 14, carried as shown in Fig. 122A, the cord 15 is passed, the ends of which are secured to the lower part of the movable ladder 10.

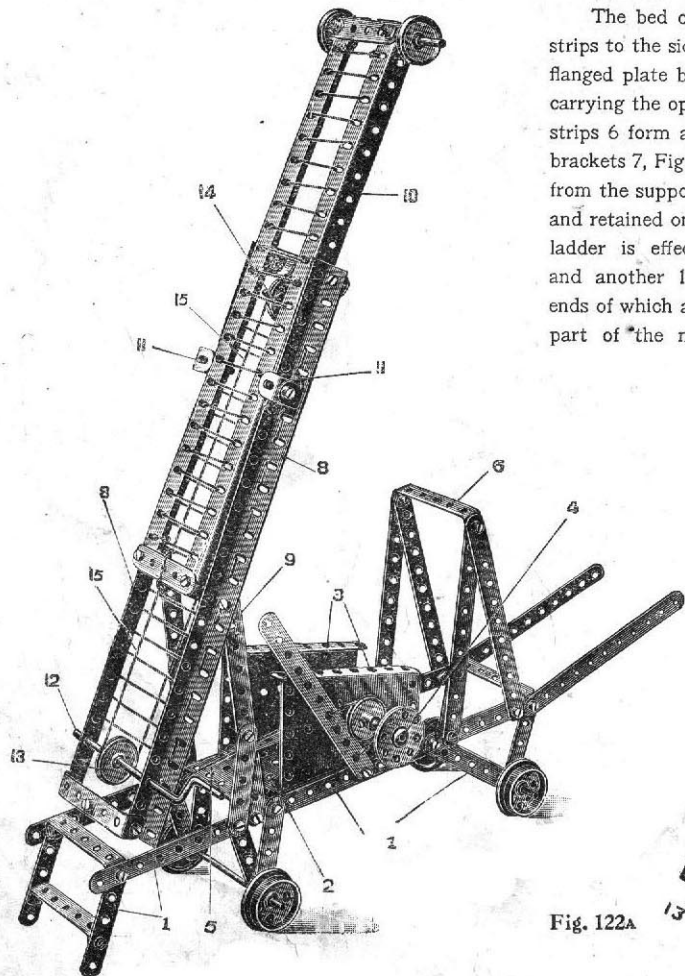

Fig. 122A

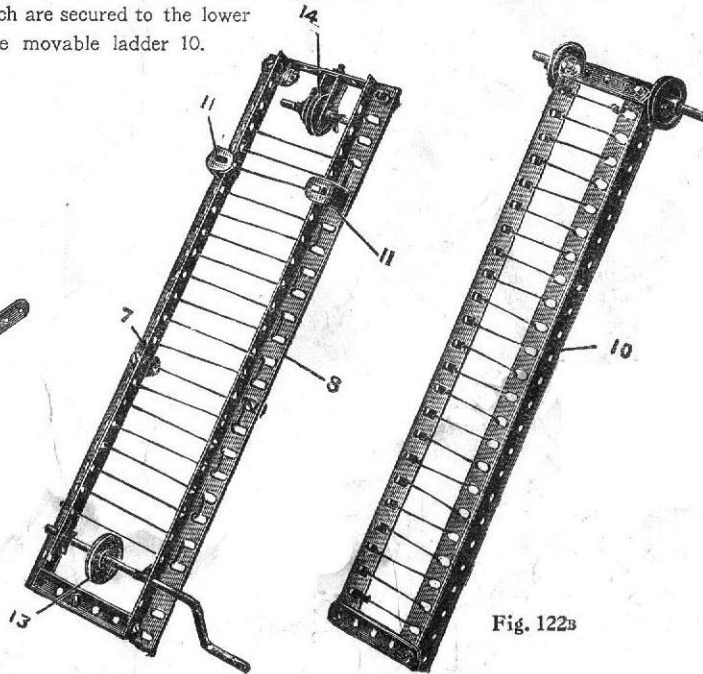
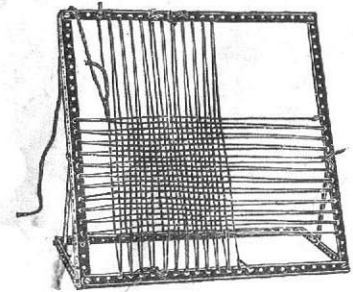

Fig. 122B

Parts Required:	
2	of No. 1
9	" " 2
2	" " 3
12	" " 5
4	" " 8
4	" " 11
2	" " 11
4	" " 12
3	" " 15
1	" " 15A
1	" " 19
4	" " 20
4	" " 22
1	" " 22A
1	" " 24
6	" " 35
47	" " 37
1	" " 44
1	" " 52
2	" " 54
5	" " 60

Model No. 123 Mat Frame



Parts Required	1 of No. 1	2
	4 " " 2	8
	2 " " 12	12
	14 " " 37	37

Model No. 124 Coaster

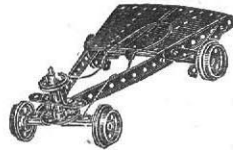

Parts Required :

2 of No. 2	1 of No. 22
5 " " 5	1 " " 37
1 " " 15	12 " " 24
1 " " 16	1 " " 45
1 " " 17	2 " " 54
4 " " 20	1 " " 60

Model No. 125 Locomotive

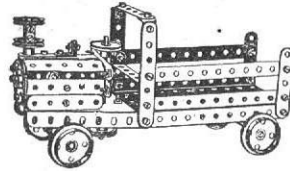

Parts Required :

4 of No. 2	1 of No. 16	46 of No. 37
2 " " 3	1 " " 17	1 " " 45
7 " " 5	4 " " 20	1 " " 52
4 " " 10	4 " " 22	1 " " 54
1 " " 11	1 " " 23	6 " " 60
8 " " 12	1 " " 24	2 " " 62
2 " " 15A	3 " " 35	

Model No. 126 Embossing Machine

Parts Required :

5 of No. 1
7 " " 2
1 " " 5
1 " " 15
2 " " 15A
1 " " 18
2 " " 20
2 " " 22
1 " " 24
4 " " 35
23 " " 37
1 " " 44
1 " " 52
2 " " 54
3 " " 60

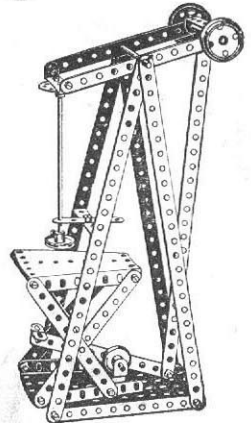

Model No. 127- Motor Van

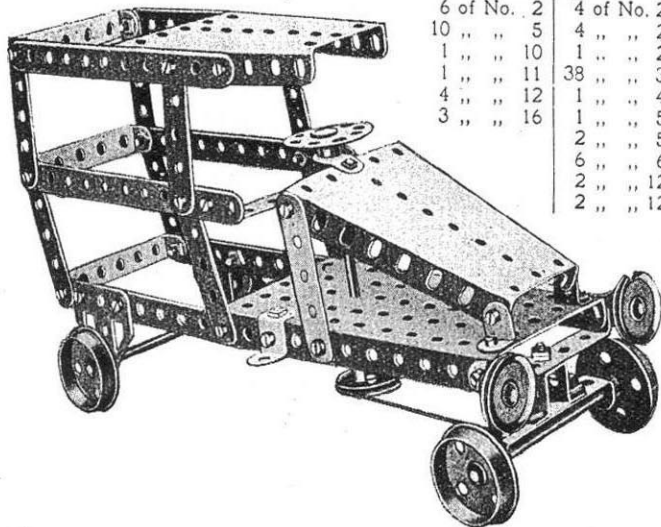

Parts required :

6 of No. 2	4 of No. 20
10 " " 5	4 " " 22
1 " " 10	1 " " 24
1 " " 11	38 " " 37
4 " " 12	1 " " 44
3 " " 16	1 " " 52
	2 " " 54
	6 " " 60
	2 " " 125
	2 " " 126A

Model No. 128 Try-your-Strength Machine

Parts Required :

2 of No. 1
3 " " 2
2 " " 5
2 " " 8
4 " " 12
1 " " 16
2 " " 17
1 " " 18
4 " " 22
1 " " 24
9 " " 37
1 " " 44
1 " " 45
1 " " 52
1 " " 54
4 " " 60
1 " " 62

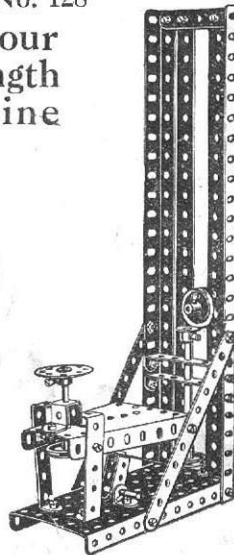

Mechanical Hammer

Model No. 129

Parts Required :

6 of No. 1
11 " " 2
1 " " 3
7 " " 5
2 " " 8
3 " " 12
2 " " 15A
4 " " 22
1 " " 24
4 " " 35
48 " " 37
1 " " 45
1 " " 52
1 " " 54
2 " " 60

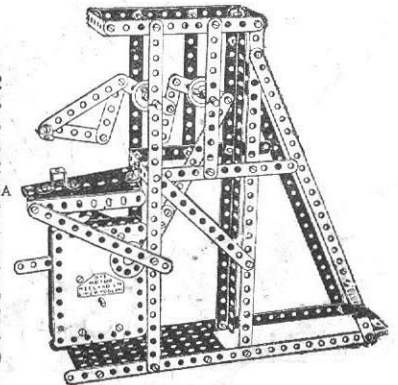

Model No. 130 Designing Machine

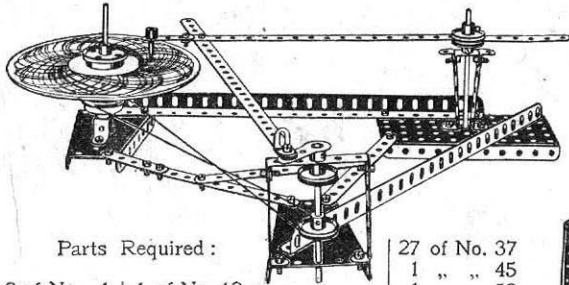

Parts Required :

2 of No. 1	1 of No. 12	27 of No. 37
3 " " 2	2 " " 15A	1 " " 45
2 " " 8	1 " " 16	1 " " 52
1 " " 11	1 " " 20	1 " " 54
		2 " " 60
		2 " " 62
	4 of No. 22	
	1 " " 24	
	1 " " 35	

Model No. 131 Crossbow

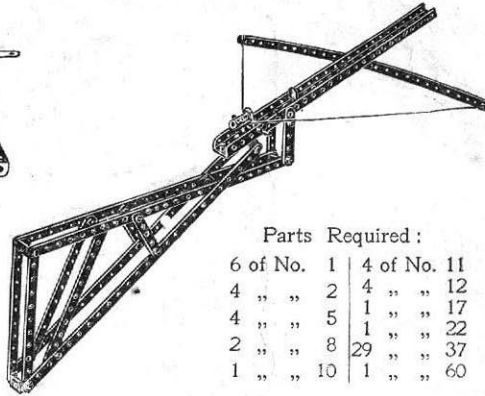

Parts Required :

6 of No. 1	4 of No. 11
4 " " 2	4 " " 12
4 " " 5	1 " " 17
2 " " 8	1 " " 22
1 " " 10	29 " " 37
	1 " " 60

Model No. 132 Lathe

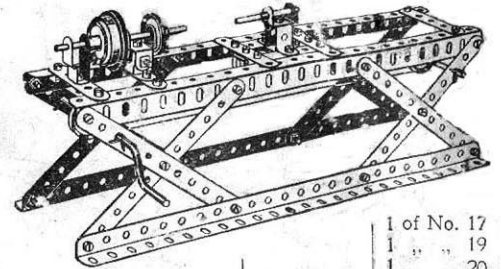

Parts Required :

4 of No. 8	1 of No. 17
3 " " 1	1 " " 19
3 " " 6	1 " " 20
4 " " 12	4 " " 22
4 " " 41	6 " " 35
1 " " 15A	1 " " 37
1 " " 16	1 " " 44
1 " " 16	1 " " 45
8 of No. 2	
7 " " 5	

Model No. 133 Dwarf Derrick

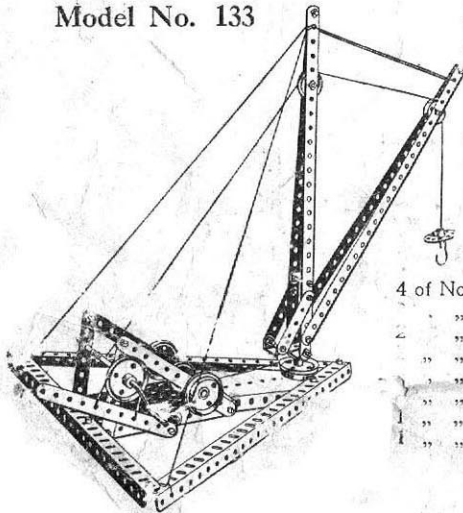

Parts Required :

1 of No. 19	
4 " " 20	
2 " " 22	
2 " " 22A	
1 " " 23	
4 of No. 1	1 " " 24
2 " " 2	4 " " 35
3 " " 3	39 " " 37
" " 5	1 " " 45
" " 8	1 " " 52
" " 11	1 " " 54
1 " " 15A	1 " " 57
1 " " 17	1 " " 62

Model No. 134 Potato Reaper

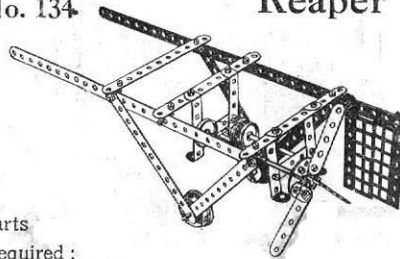

Parts Required :

2 of No. 1	1 of No. 15A	5 of No. 35
8 " " 2	2 " " 20	31 " " 37
4 " " 5	2 " " 22	4 " " 60
10 " " 12	2 " " 22A	2 " " 61
2 " " 15	1 " " 24	

Model No. 135 Elevator

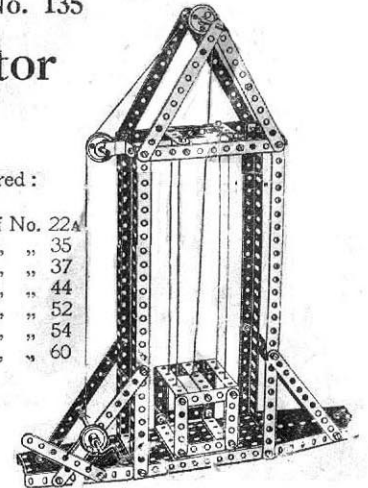

Parts Required :

1 of No. 1	2 of No. 22A
10 " " 2	5 " " 35
3 " " 3	44 " " 37
10 " " 5	1 " " 44
4 " " 8	1 " " 52
4 " " 12	2 " " 54
1 " " 15A	5 " " 60
1 " " 17	
1 " " 19	
1 " " 19	

Model No. 136 Maize Sheller

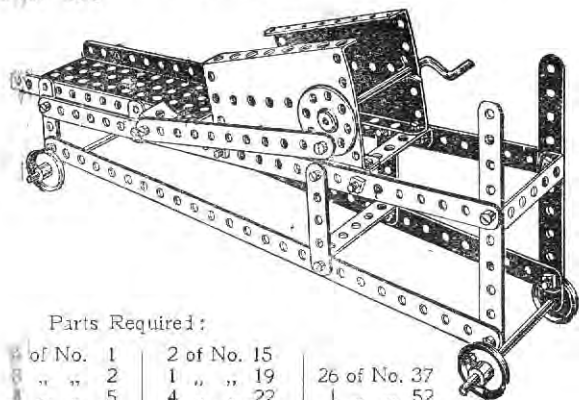

Parts Required:

of No. 1	2 of No. 15	26 of No. 37
" " 2	1 " " 19	1 " " 52
" " 5	4 " " 22	2 " " 54
" " 10	1 " " 24	4 " " 60
" " 11	2 " " 35	

Model No. 137

Hay Stacker

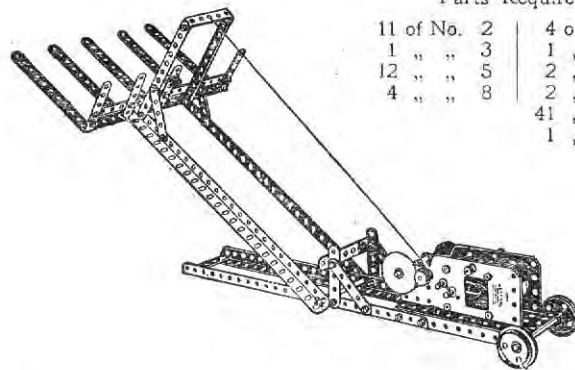

Parts Required:

11 of No. 2	4 of No. 12
1 " " 3	1 " " 16
12 " " 5	2 " " 20
4 " " 8	2 " " 35
	41 " " 37
	1 " " 52

Model No. 139

Beam Scales

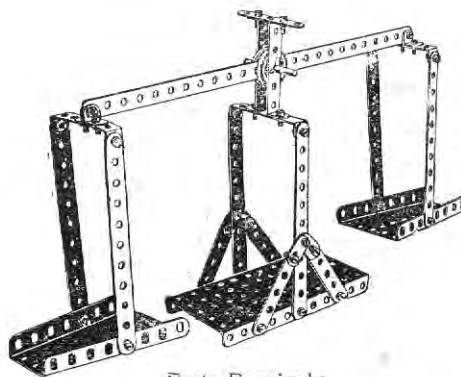

Parts Required:

1 of No. 1	4 of No. 12	32 of No. 37
6 " " 2	1 " " 17	1 " " 52
5 " " 5	2 " " 22A	2 " " 54
4 " " 10	2 " " 35	5 " " 60

Model No. 138

Candy Puller

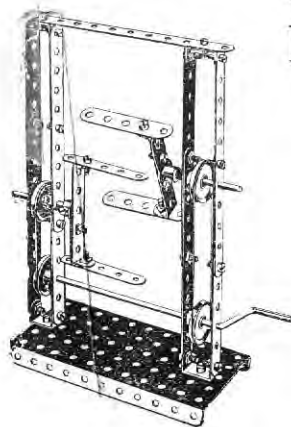

Parts Required:

9 of No. 2
4 " " 5
4 " " 11
2 " " 17
1 " " 19
4 " " 22
2 " " 35
26 " " 37
1 " " 52
2 " " 60
2 " " 62

Model No. 140

Baby Chair

Parts Required:

8 of No. 2
2 " " 3
10 " " 5
6 " " 12
2 " " 17
4 " " 22
32 " " 37
6 " " 60

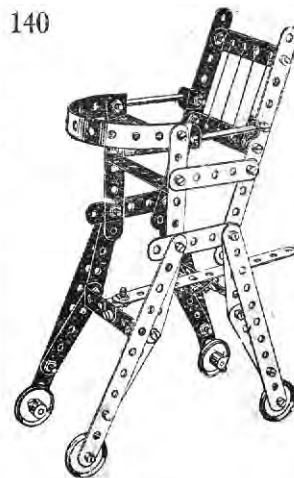

Hay Tedder

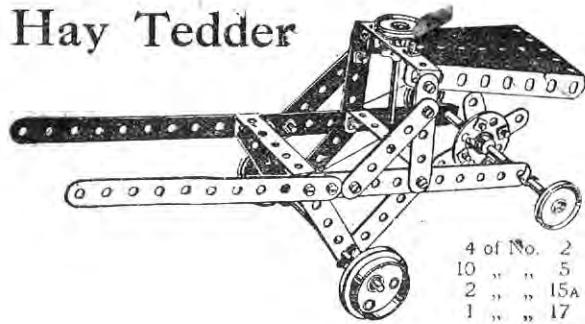

4 of No. 2
10 " " 5
2 " " 15A
1 " " 17

Model No. 141

Parts Required:

2 of No. 20
3 " " 22
1 " " 24
5 " " 35
18 " " 37
1 " " 54
3 " " 60

Model No. 142 Ducking Chair

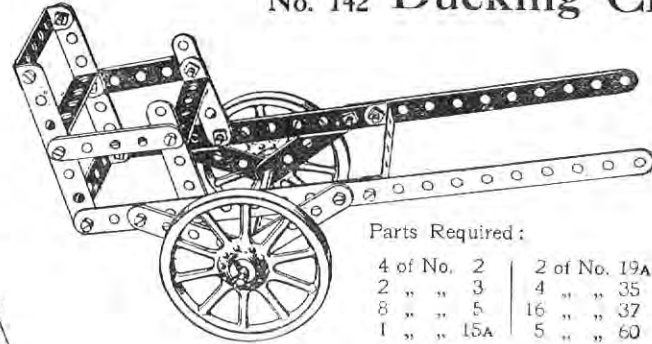

Parts Required:

4 of No. 2	2 of No. 19A
2 " " 3	4 " " 35
8 " " 5	16 " " 37
1 " " 15A	5 " " 60

Model No. 143 Needlework Basket

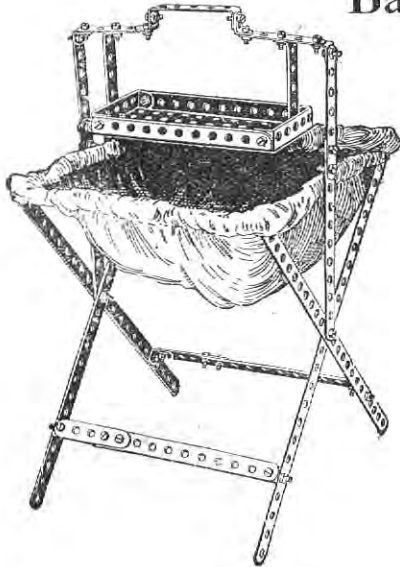

Parts Required:

4 of No. 1
6 " " 2
2 " " 3
6 " " 5
12 " " 12
46 " " 37
1 " " 52
3 " " 60

Model No. 144

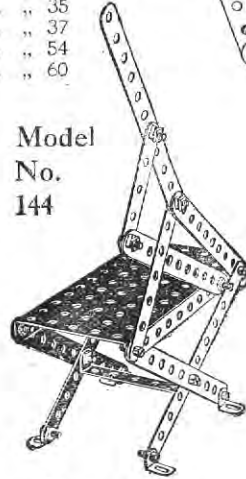

Cutting Machine

Parts Required:

8 of No. 2
1 " " 3
1 " " 5
4 " " 12
20 " " 37
1 " " 52

Model No. 145 Dinner Gong

Parts Required:

6 of No. 1
4 " " 2
2 " " 5
2 " " 8
2 " " 11
1 " " 15
1 " " 22
27 " " 37
1 " " 54

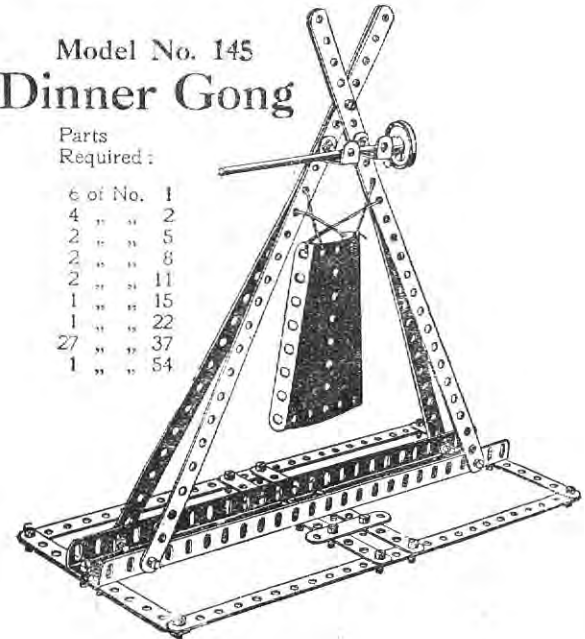

Model No. 146 Seashore Aeroplage

Farts
Required :

3 of No.	1
1 " "	2
3 " "	5
4 " "	12
2 " "	15
1 " "	16
4 " "	22
2 " "	22A
1 " "	24
6 " "	35
15 " "	37
1 " "	44
1 " "	52
1 " "	54
2 " "	60

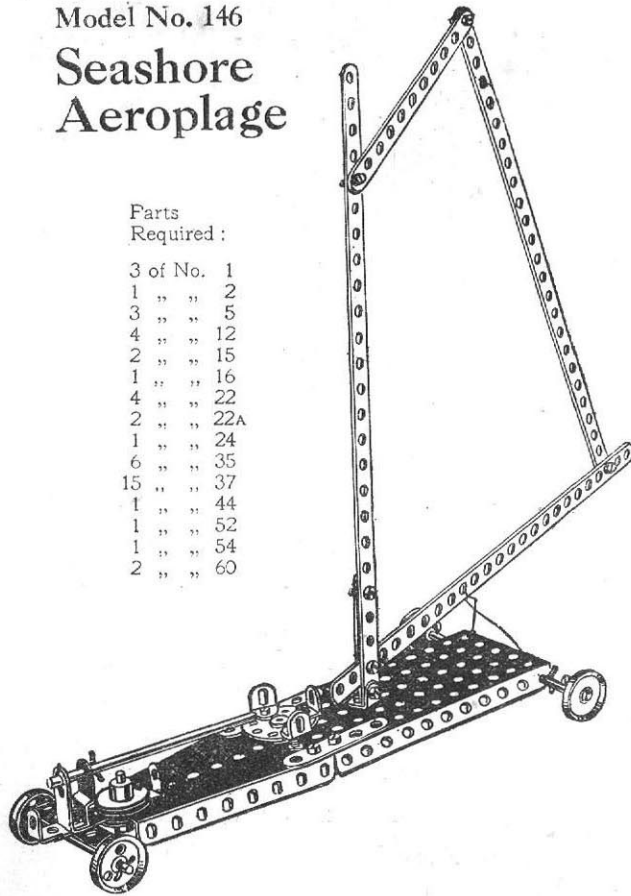

Model No. 147 Mechanical Hammer

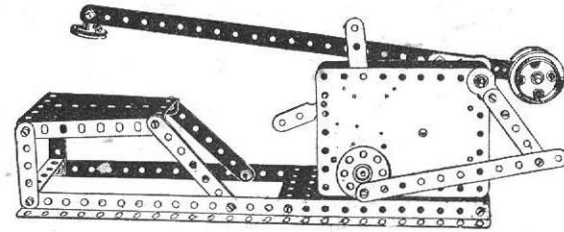

1 of No.	1	4 of No.	12	26 of No.	37
1 " "	2	1 " "	17	1 " "	52
2 " "	3	2 " "	20	1 " "	54
2 " "	5	1 " "	22	1 " "	60
2 " "	8	1 " "	24	2 " "	62

Model No. 148

Coal Shaker

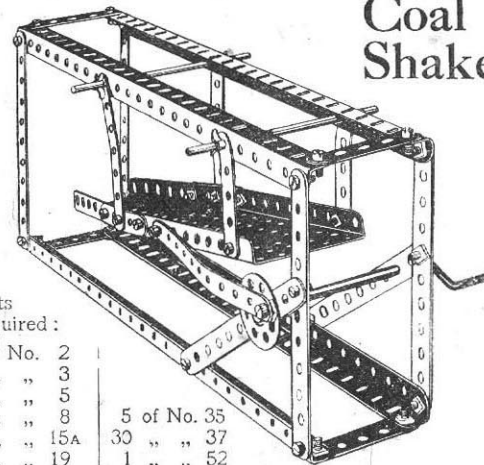

Farts
Required :

7 of No.	2	5 of No.	35
2 " "	3	30 " "	37
8 " "	5	1 " "	52
4 " "	8	1 " "	54
2 " "	15A		
1 " "	19		
1 " "	24		

Model No. 149 Sifter

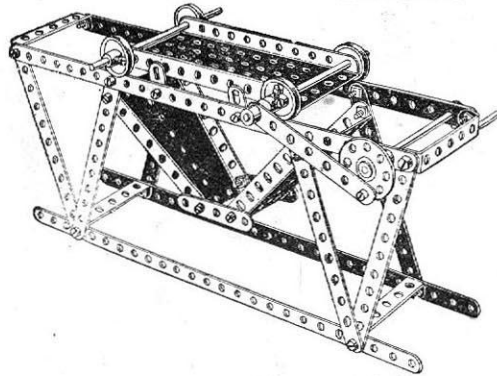
Parts
Required:

4 of No.	1
6 " "	2
1 " "	3
2 " "	5
4 " "	10
2 " "	15A
1 " "	19
4 " "	22
1 " "	24
4 " "	35
26 " "	37
1 " "	52
2 " "	54
4 " "	60

Model No. 150 Spinning Top

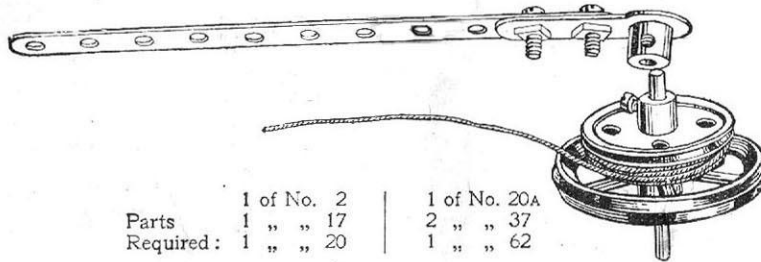

Parts	1 of No. 2	1 of No. 20A
Required:	1 " " 17	2 " " 37
	1 " " 20	1 " " 62

Model No. 151 Easel

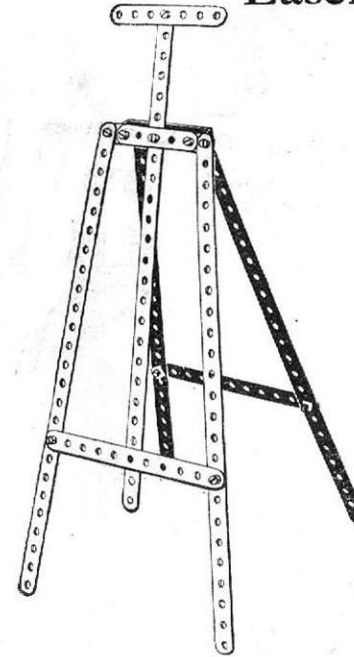
Parts
Required:

5 of No.	1
2 " "	2
2 " "	3
1 " "	5
2 " "	12
14 " "	37
1 " "	60

HOW TO CONTINUE

This completes the Models which may be made with MECCANO Outfit No. 2. The next Models are a little more advanced, requiring a number of extra parts to construct them. The necessary parts are all contained in a No. 2A Accessory Outfit, the cost of which will be found in the Price List at the end of the Manual.

Model No. 152, Swing Bridge

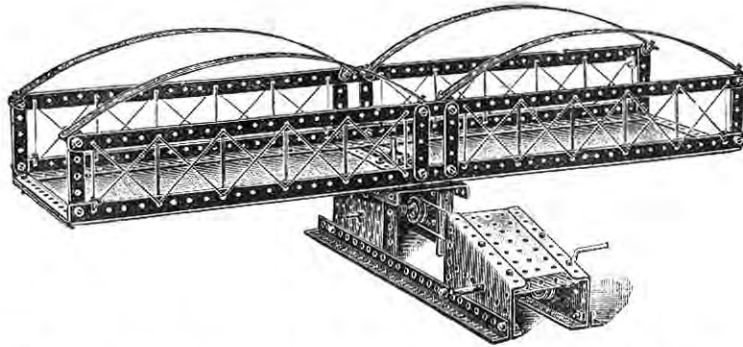

Parts Required:

8 of No. 1	1 of No. 19	60 of No. 37
4 " " 2	2 " " 22	1 " " 52
8 " " 5	1 " " 24	3 " " 53
6 " " 8	1 " " 26	2 " " 54
10 " " 12	1 " " 32	2 " " 59
2 " " 15	3 " " 35	1 " " 60

This is a fine engineering model of the highest value to the young student, and any thought and care expended on its construction will be well repaid.

The base portion containing the perpendicular axle actuated by the worm and pinion should be constructed first. This, as will be seen by the illustration, Fig. 152A, is formed by connecting a small flanged plate to an angle girder three holes from one end and a sector plate at the other end to form one side of the base. The other side is constructed in a similar manner. These two sides are then connected together at one end by a large flanged plate containing the spindle, upon which the bridge swings, and at the other by a small flanged plate. A $2\frac{1}{2}$ " bent strip is connected to the angle girders to carry the lower portion of the perpendicular axle upon which the bridge swings. A $\frac{1}{2}$ " pinion is secured to this axle, which is operated by the horizontal spindle upon which is secured a worm wheel. A pulley wheel is also secured to this spindle around which a driving rope passes from the pulley at the other end of the base secured to a crank handle, as shown in the illustration.

The platform is constructed by connecting two angle girders in the third holes. Two $2\frac{1}{2}$ " strips are attached to these in the centre and one at each end, with two $12\frac{1}{2}$ " strips along the top. Two $12\frac{1}{2}$ " strips are curved and connected by four angle brackets to form one side of the bridge. The other side is formed in a similar manner, and both are connected together by $5\frac{1}{2}$ " strips at the end and in the centre. Attached to the two $5\frac{1}{2}$ " strips in the centre is a bush wheel upon which the platform rotates.

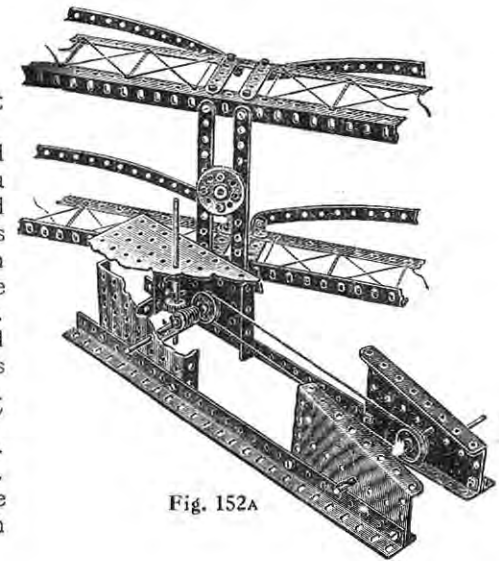

Fig. 152A

Model No. 153 Cake Walk

Parts Required:

8 of No. 1	1 of No. 32
12 " " 2	8 " " 35
9 " " 5	62 " " 37
6 " " 8	2 " " 52
8 " " 12	2 " " 53
4 " " 15	3 " " 59
2 " " 15A	6 " " 60
1 " " 22	2 " " 62
1 " " 25	

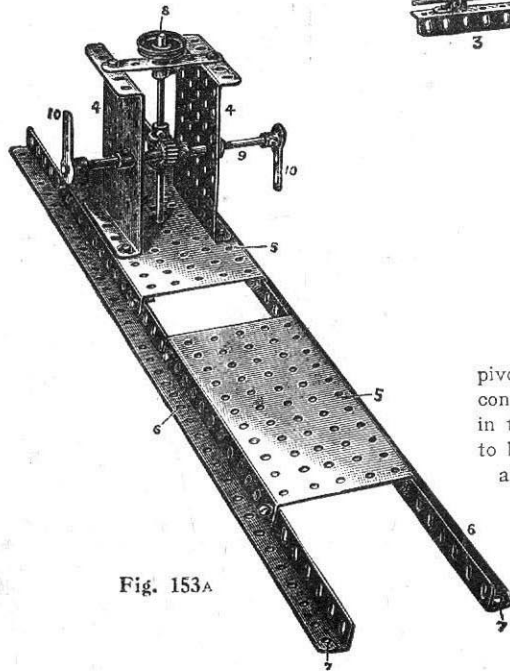
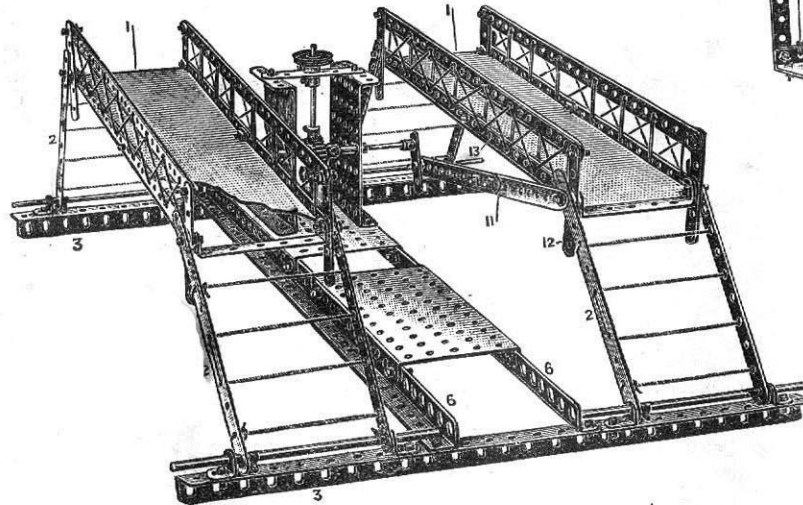

Fig. 153A



This model comprises two side platforms 1 carried upon 5½" strips 2 pivoted to angle brackets bolted to angle girders 3. The gear box, Fig. 153A, consists of small flanged plates 4 bolted to a large flanged plate 5, which in turn is bolted to angle girders 6 overlapped 14 holes. It is necessary to bolt the flanges to the flanged plate 5 outside the vertical parts of the angle girders 6 so that the end holes 7 shall register with the holes in the angle girders 3. The platforms 1 are rocked from a vertical shaft 8 gearing with a shaft 9 by a worm and pinion, the ends of the shaft 9 being fitted with cranks 10 pivotally bolted to connecting rods 11 formed of two 5½" strips overlapped two holes. The strips 11 are also pivotally bolted to the end strips 2, a vertical 2½" strip 12, and the lower end hole of the lower strip 13 of each side platform, so as to give free rocking movement.

Tower Wagon

Model No. 154

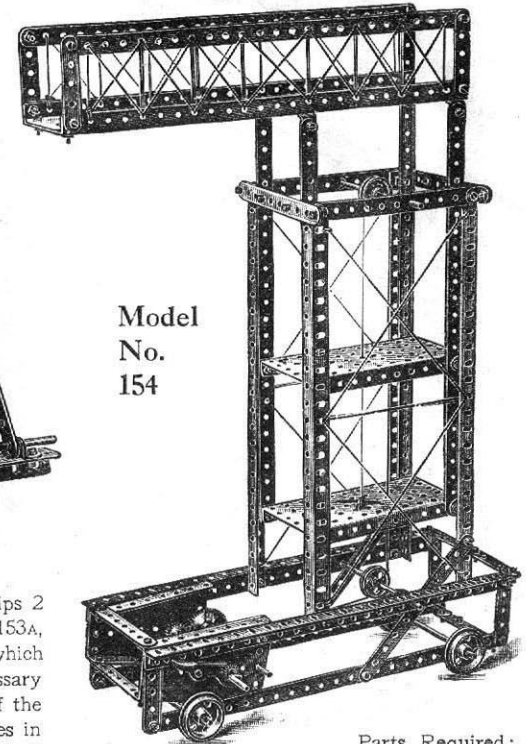

Parts Required:

8 of No. 1	4 of No. 15	1 of No. 33
4 " " 2	1 " " 15A	6 " " 35
6 " " 3	1 " " 19	69 " " 37
2 " " 4	4 " " 20	2 " " 52
11 " " 5	2 " " 22	2 " " 54
8 " " 8	2 " " 26	2 " " 60
14 " " 12	1 " " 27A	

Model No. 155 Level Crossing Gate

		Parts Required :	
9 of No. 2	6 of No. 8	4 of No. 22	
4 " " 3	16 " " 12	54 " " 37	
2 " " 4	4 " " 15	2 " " 52	
6 " " 5		4 " " 60	

This Model, if constructed with care, is a most admirable one, as the gates are opened simultaneously by the operation of one lever.

To construct it, commence by taking two angle girders and connecting them together in the second hole from each end with a $3\frac{1}{2}$ " strip placed perpendicularly between them to form the supports of one pair of gates as shown in Fig. 155. The supports for the other pair of gates are arranged in a similar manner. These two structures are connected by two other angle girders and two flanged plates, as shown in the illustration.

The gates are formed by connecting two $5\frac{1}{2}$ " strips with a $2\frac{1}{2}$ " strip at the outer end of the gate and a $2\frac{1}{2}$ " bent strip at the inner end, to permit the axle rods to pass through upon which the gates swing.

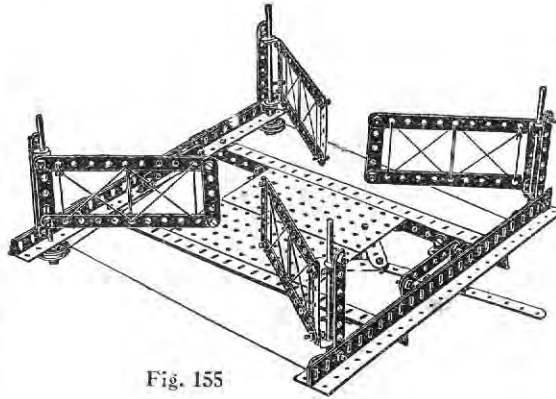

Fig. 155

Fig. 155A is an inverted view showing the arrangement of operating cord 1 which is passed from the operating lever 2, around the corner pulleys 3, and back to the lever 2. In order to obtain a better grip on the pulleys it is desirable to wind the operating cord twice around them. It is to be noted that the cord 1 is wound in opposite directions around the diagonal pairs of pulleys 3.

Pinching screws 4 are fitted in the inner sides of the gates to grip them to the spindles 5 so that all rotate together.

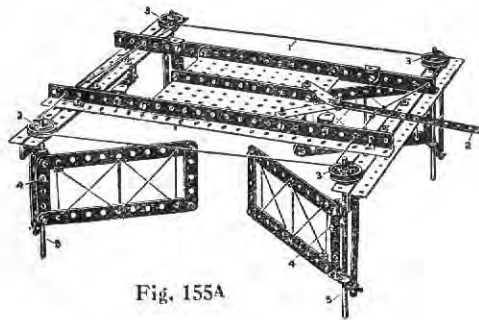

Fig. 155A

Pile Driver

Model No. 156

Parts Required :

2 of No. 1	1
1 " " 3	3
2 " " 4	4
8 " " 5	5
2 " " 8	8
4 " " 12	12
4 " " 15	15
1 " " 19	19
4 " " 20	20
1 " " 21	21
1 " " 22	22
1 " " 26	26
1 " " 27A	27A
4 " " 35	35
40 " " 37	37
1 " " 45	45
1 " " 52	52
1 " " 53	53
2 " " 60	60

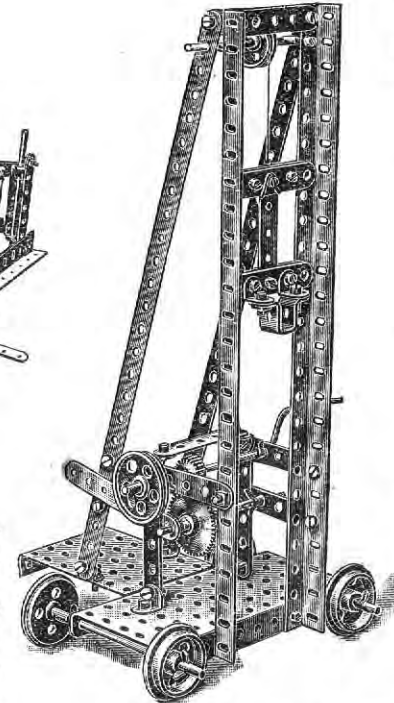

This illustration shows a model pile driver in which the pile head is guided on the two vertical angle girders. The raising of the pile head is controlled from the main driving shaft through the pinion and gear wheel. This latter is mounted on the end of the pivoted lever, and in order to drop the pile head the lever is raised to free the gear wheel. A grooved pulley is fitted on the pinion shaft to enable the model to be driven from an engine.

Model No. 157 Rotating Crane

Parts Required:		
10 of No. 1	2 of No. 20	1 of No. 44
13 " " 2	1 " " 21	1 " " 45
3 " " 3	1 " " 22	2 " " 52
1 " " 4	1 " " 24	1 " " 57
5 " " 5	2 " " 26	4 " " 59
8 " " 8	1 " " 27A	
1 " " 11	1 " " 33	
12 " " 12	4 " " 35	
3 " " 15	61 " " 37	
2 " " 17		
1 " " 19		

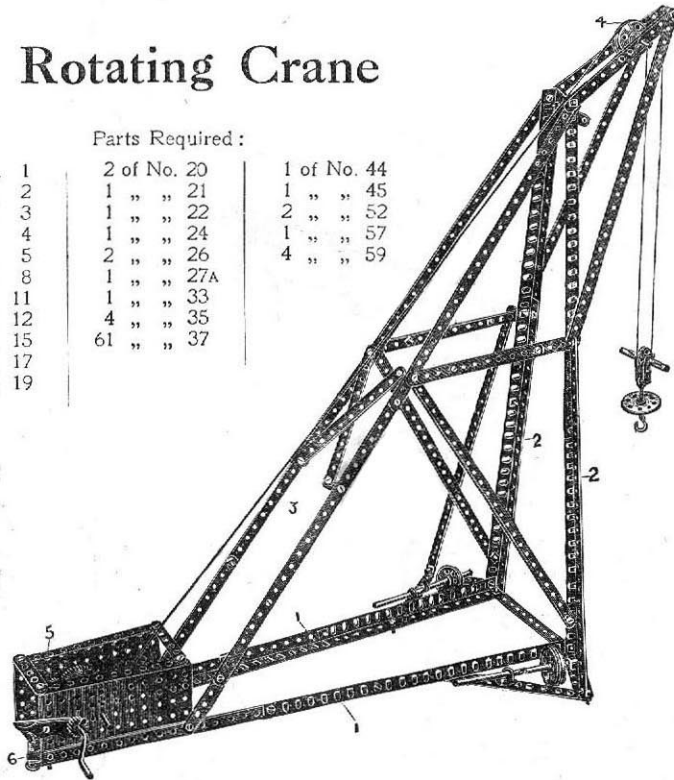

The lower horizontal ribs 1 and main vertical members 2 are made of angle girders overlapping nine holes; and the diagonal ties 3 of two $12\frac{1}{2}$ " strips and one $5\frac{1}{2}$ " strip, the $12\frac{1}{2}$ " strips being overlapped three holes, and the lower $5\frac{1}{2}$ " strip seven holes.

The pulley 4 is carried in a nosing made of two $5\frac{1}{2}$ " strips and two $12\frac{1}{2}$ " strips connected at their apex by angle brackets. The rear swivel point of the crane is made by bolting the gear box 5 to a double bent strip 6 secured to the floor. The crane runs on the flanged wheels 7, the spindles of which are secured in their position by collars and set-screws.

Inclined Delivery Chute

Model No. 158

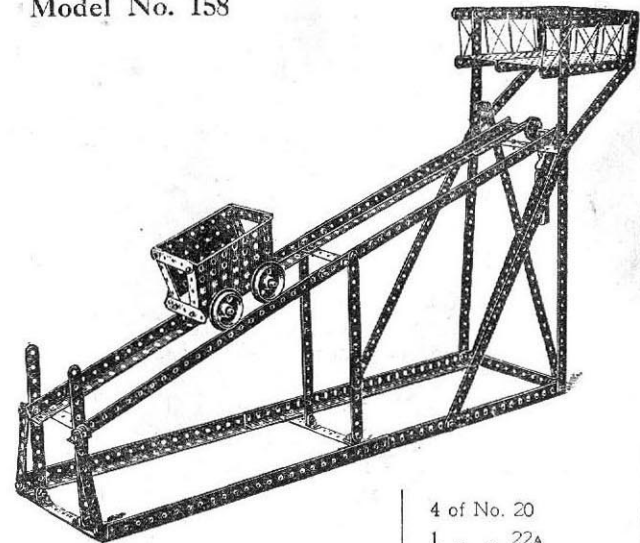

Parts Required:	
4 of No. 20	1 " " 22A
1 " " 21	2 " " 35
2 " " 22	70 " " 37
2 " " 24	2 " " 52
2 " " 26	2 " " 53
1 " " 27A	1 " " 57
2 of No. 4	
8 " " 5	
6 of No. 1	8 " " 8
16 " " 2	16 " " 12
4 " " 3	3 " " 15

This model furnishes an illustration of the inclined plane. The loading platform at the extreme right delivers a load into the truck, which being now heavier than the balance weight, runs down the incline, and when at the bottom discharges its load by tipping. The weight immediately overcoming the empty truck returns it quickly to the loading platform.

Model No. 159 Fire Escape

Parts Required:

2 of No. 1	1 of No. 15A
4 " " 2	2 " " 19
3 " " 3	4 " " 20
2 " " 4	3 " " 22
4 " " 5	1 " " 23
4 " " 8	2 " " 26
2 " " 11	2 " " 33
18 " " 12	8 " " 35
4 " " 15	48 " " 37
	1 " " 60

In constructing this model, take two angle girders 1 and tie these together with $3\frac{1}{2}$ " strip 2 at top and bottom. $5\frac{1}{2}$ " strips 3 are then attached at right angles to one end of the frame, diagonal stays 4 tying these short strips to the angle brackets attached to the frame. The sliding ladder, Fig. 159B, is constructed from two angle girders reversed to those of the main frame, the angle girders of the sliding ladder being tied together by two $2\frac{1}{2}$ " strips, and being retained and guided in the main carriage by the short angle brackets 5 which act as clips. The framework of the running truck, Fig. 159A, is very simply constructed, and is pivotally attached by angle brackets 6 to the main frame.

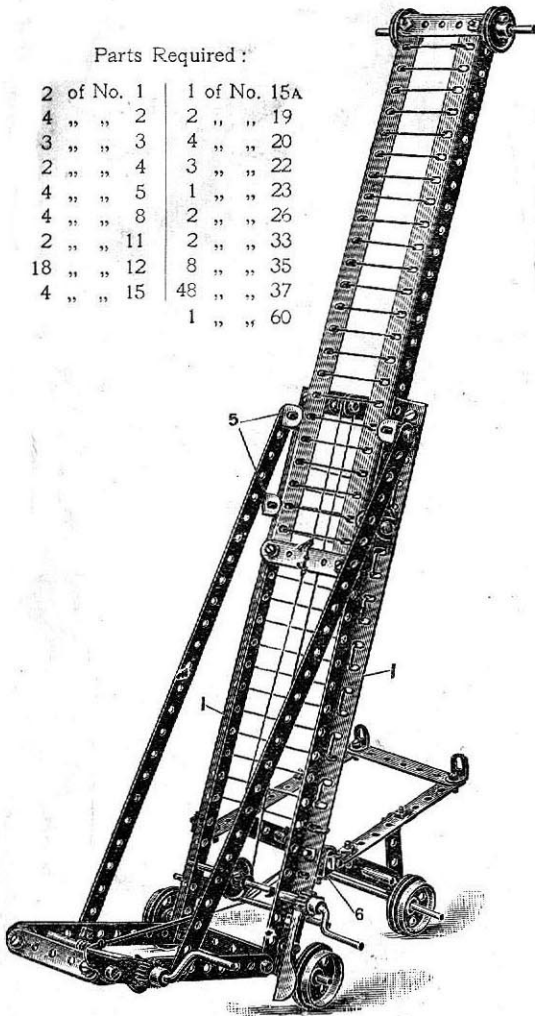

Fig. No. 159A

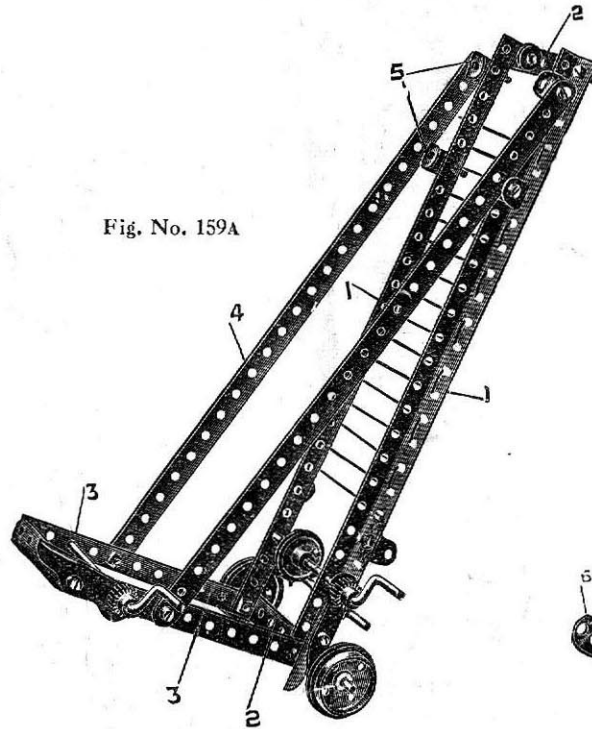
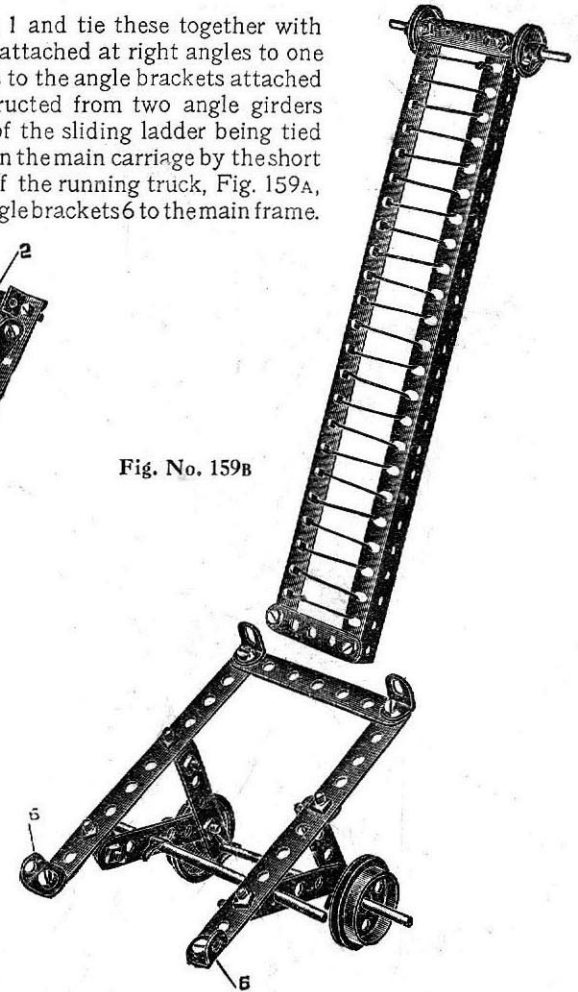

Fig. No. 159B



Model No. 160

Railway Wagon Swivel Crane

The swivelling action of this model is obtained as follows: The spindle 1 is fixed against rotation in a bush wheel 2 bolted to a cross $2\frac{1}{2}$ " bent strip 3 beneath the wagon. The pinion 4 on the spindle 1 is therefore fixed, and when the worm 5 is rotated by the cranked handle the whole crane rotates about the pinion.

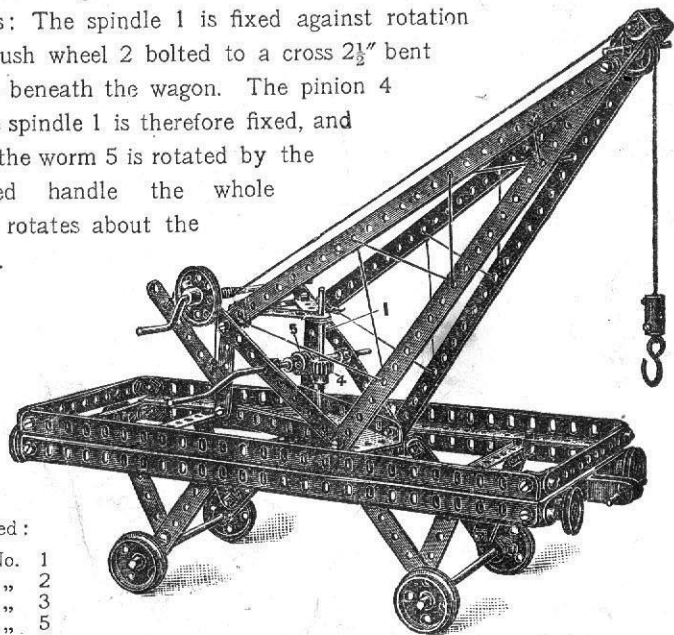

Parts
Required:

4	of No.	1
8	" "	2
5	" "	3
9	" "	5
4	" "	8
1	" "	11
16	" "	12
3	" "	15
2	" "	17
2	" "	19
4	" "	20
1	" "	21
4	" "	22
1	" "	22A
1	" "	24
1	" "	26
1	" "	32

Parts
Required:

5	of No.	35
69	" "	37
1	" "	44
1	" "	45
1	" "	52
1	" "	54
1	" "	57
2	" "	59
2	" "	60

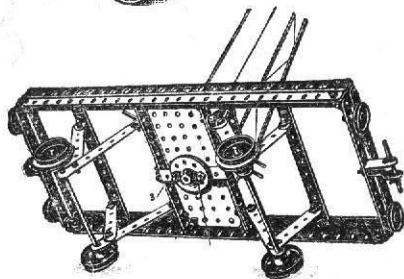
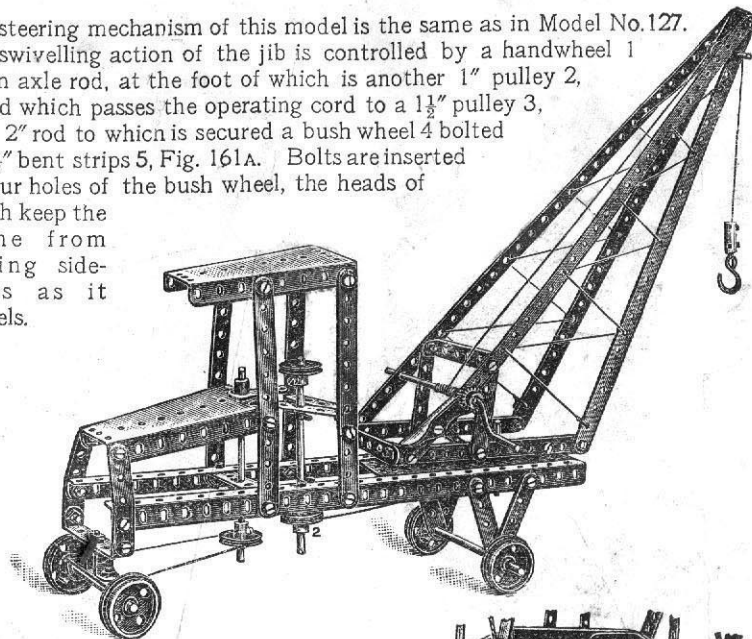

Fig. 160A

Model No. 161

Travelling Swivel Crane

The steering mechanism of this model is the same as in Model No. 127. The swivelling action of the jib is controlled by a handwheel 1 on an axle rod, at the foot of which is another 1" pulley 2, round which passes the operating cord to a $1\frac{1}{2}$ " pulley 3, on a 2" rod to which is secured a bush wheel 4 bolted to $2\frac{1}{2}$ " bent strips 5, Fig. 161A. Bolts are inserted in four holes of the bush wheel, the heads of which keep the crane from tilting sideways as it swivels.



Parts Required:

4	of No.	1	2	of No.	17	6	of No.	35
6	" "	2	1	" "	19	51	" "	37
2	" "	3	4	" "	20	1	" "	45
11	" "	5	1	" "	21	1	" "	52
2	" "	8	3	" "	22	2	" "	54
1	" "	11	1	" "	22A	1	" "	57
2	" "	12	1	" "	24	6	" "	60
3	" "	15	1	" "	26	1	" "	62
1	" "	16	1	" "	33	1	" "	63

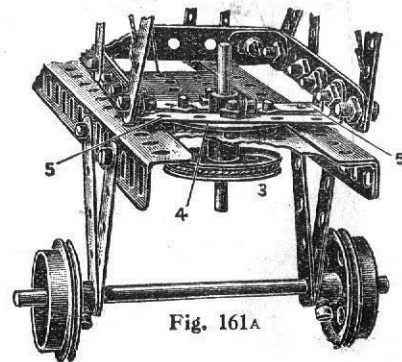

Fig. 161A

Model No. 162 Pile Driver

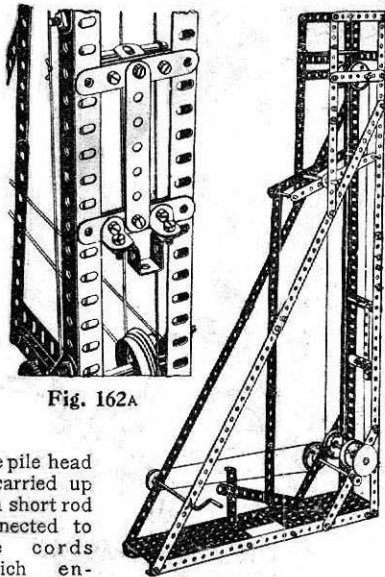

Fig. 162A

The pile head is carried up by a short rod connected to the cords which engages a catch on the head formed by an angle bracket. The short rod is disengaged from the angle bracket, being drawn away by a fixed cross rod as the short rod travels upward, and the pile head is thus released.

Parts Required:

5 of No. 1	3 of No. 15A	6 of No. 35
10 " " 2	2 " " 17	69 " " 37
6 " " 3	1 " " 19	1 " " 45
2 " " 4	4 " " 20	2 " " 52
4 " " 5	1 " " 21	1 " " 53
6 " " 8	1 " " 22	1 " " 60
6 " " 12	1 " " 26	2 " " 62
2 " " 15	1 " " 27A	

Model No. 163 Bob Sleigh

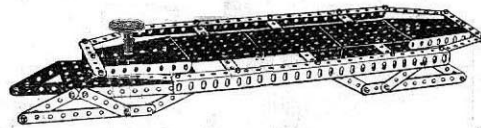

Parts Required:

7 of No. 2	1 of No. 24
6 " " 3	59 " " 37
12 " " 5	1 " " 45
2 " " 8	2 " " 52
2 " " 11	3 " " 53
1 " " 17	2 " " 54
1 " " 21	1 " " 63

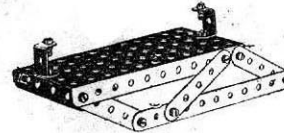
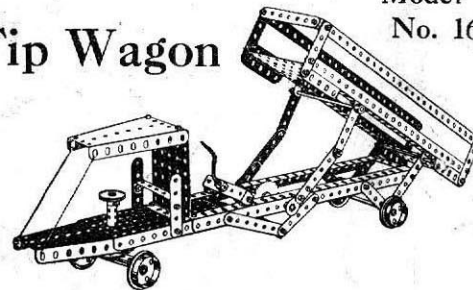

Fig. 163A

Tip Wagon



Model No. 165

Parts Required:

2 of No. 1	2 of No. 16	1 of No. 32	4 of No. 59
6 " " 3	1 " " 17	2 " " 35	4 " " 60
2 " " 4	1 " " 19	54 " " 37	2 " " 62
12 " " 5	4 " " 20	1 " " 45	1 " " 63
4 " " 8	1 " " 22	1 " " 52	
6 " " 12	1 " " 24	3 " " 53	
3 " " 15A	1 " " 27	2 " " 54	

Model No. 164 Tower Wagon

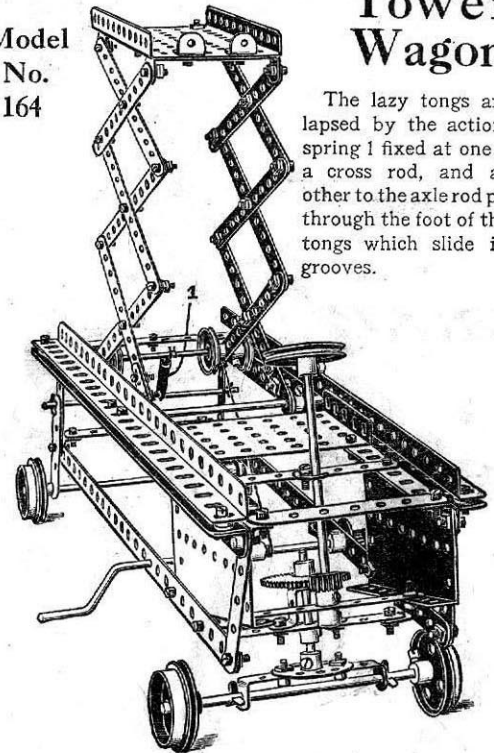

The lazy tongs are collapsed by the action of a spring 1 fixed at one end to a cross rod, and at the other to the axle rod passing through the foot of the lazy tongs which slide in the grooves.

Parts Required:

2 of No. 1	3 of No. 15	4 of No. 22	1 of No. 45
12 " " 2	2 " " 15A	1 " " 24	1 " " 52
6 " " 3	1 " " 17	2 " " 26	1 " " 53
2 " " 4	1 " " 19	1 " " 27	2 " " 54
4 " " 8	4 " " 20	1 " " 33	4 " " 55
1 " " 10	1 " " 21	65 " " 37	2 " " 62
4 " " 12			

Model No. 166

Actuated See-saw

Parts Required:

- 1 of No. 2
- 2 " " 3
- 8 " " 8
- 3 " " 15
- 3 " " 15A
- 4 " " 20
- 1 " " 21
- 1 " " 22
- 1 " " 24
- 1 " " 26
- 1 " " 27

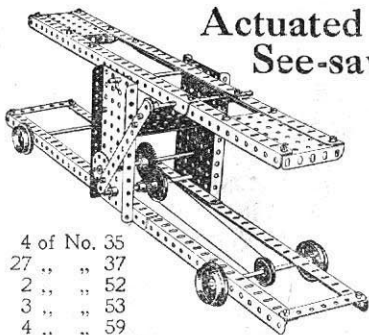

- 4 of No. 35
- 27 " " 37
 - 2 " " 52
 - 3 " " 53
 - 4 " " 59
 - 1 " " 62

Model No. 167 Coffee Grinder

Parts Required:

- 1 of No. 1
- 2 " " 2
- 6 " " 3
- 2 " " 4
- 4 " " 5
- 4 " " 12
- 1 " " 15
- 1 " " 16
- 2 of No. 17
- 1 " " 24
- 2 " " 26
- 28 " " 37
- 2 " " 54
- 4 " " 59
- 2 " " 62

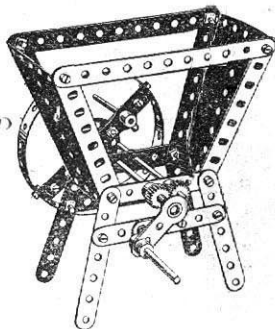

Demonstration Scales

Model No. 168

Parts Required:

- 5 of No. 1
- 10 " " 2
- 6 " " 3
- 12 " " 5
- 4 " " 8
- 2 " " 11
- 5 " " 12
- 1 " " 16
- 2 " " 20
- 1 " " 24
- 49 " " 37
- 2 " " 52
- 3 " " 53
- 2 " " 54

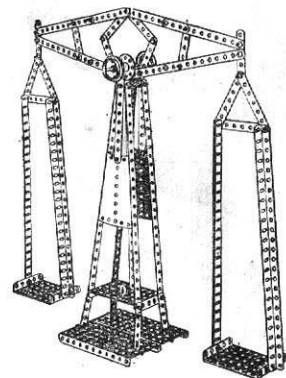

Model No. 169

Ice Boat

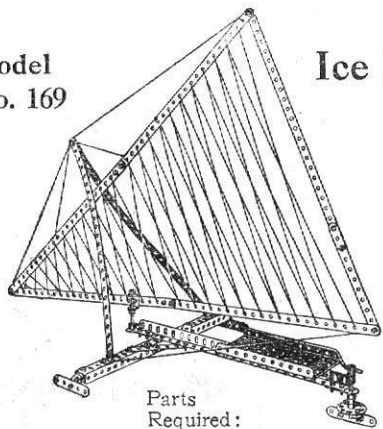

Parts Required:

- 7 of No. 1
- 1 " " 2
- 2 " " 3
- 3 " " 5
- 2 " " 8
- 2 " " 10
- 3 of No. 11
- 6 " " 12
- 2 " " 17
- 1 " " 19
- 1 " " 24
- 39 of No. 37
- 1 " " 52
- 3 " " 59
- 2 " " 62
- 1 " " 63

Model No. 170

Motor Dump Truck

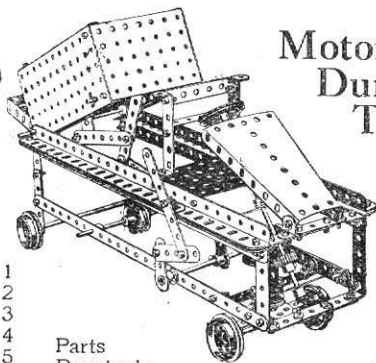

- 2 of No. 1
- 1 " " 2
- 6 " " 3
- 2 " " 4
- 11 " " 5
- 4 " " 8
- 9 " " 12
- 4 " " 15
- 2 " " 15A
- 1 " " 16
- 1 " " 17
- 4 " " 20
- 1 " " 21

Parts Required:

- 3 of No. 22
- 1 " " 23
- 1 " " 24
- 1 " " 26
- 1 " " 27
- 4 " " 35
- 65 " " 37
- 1 of No. 45
- 2 " " 52
- 3 " " 53
- 1 " " 54
- 4 " " 59
- 6 " " 60
- 2 " " 62

Model No. 171

Lawn Swing

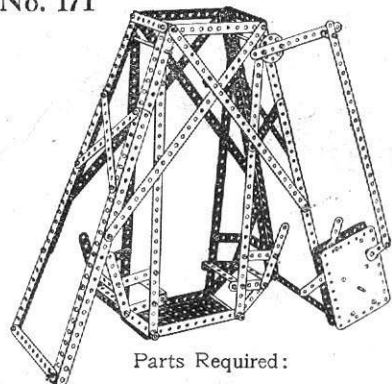

Parts Required:

- 9 of No. 1
- 9 " " 2
- 6 " " 3
- 12 " " 5
- 8 " " 8
- 2 of No. 15A
- 2 " " 16
- 1 " " 24
- 6 " " 35
- 65 " " 37
- 1 of No. 52
- 4 " " 59
- 6 " " 60
- 2 " " 62
- 1 " " 63

Model No. 172
Letter Balance

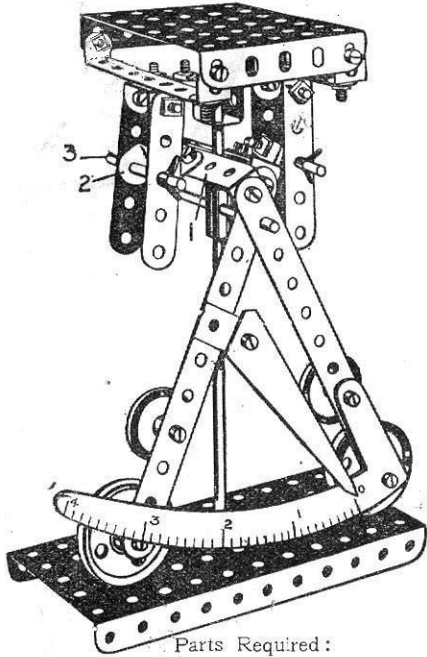

Parts Required:

2 of No. 2	2 of No. 20
2 " " 3	2 " " 22
5 " " 5	8 " " 35
2 " " 10	40 " " 37
4 " " 11	1 " " 45
4 " " 12	1 " " 52
1 " " 15	1 " " 53
1 " " 16	4 " " 60
2 " " 17	1 " " 63

Strip 1 is bolted by an angle bracket to a double bent strip 2, which forms the pivot round the rod 3.

Model No. 173
Flax Cleaner

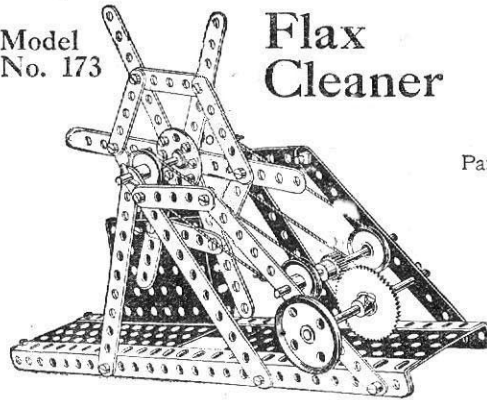

Parts Required:

6 of No. 2	2
6 " " 3	3
8 " " 5	5
2 " " 8	8
1 " " 15A	15A
2 " " 16	16
1 " " 21	21
4 " " 22	22
1 " " 24	24
1 " " 26	26
1 " " 27A	27A
3 " " 35	35
28 " " 37	37
2 " " 52	52

Model No. 175
Lace Jennier

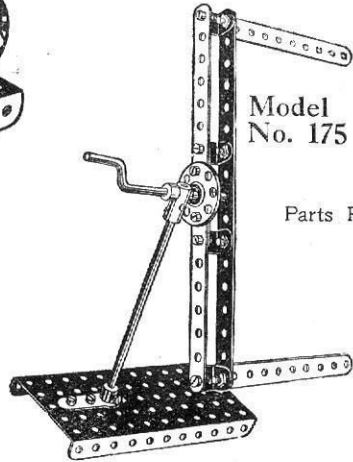

Parts Required:

8 of No. 2	2
4 " " 11	11
1 " " 15	15
1 " " 19	19
1 " " 24	24
14 " " 37	37
1 " " 52	52
1 " " 59	59
1 " " 62	62
1 " " 63	63

Model No. 174
Oscillating Steam Engine

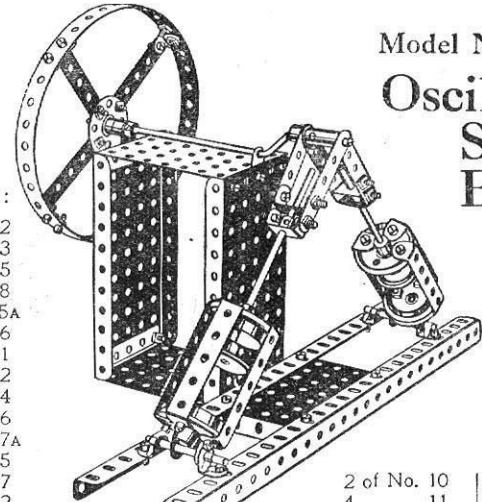

Parts Required:

4 of No. 2	2	2 of No. 10	10	4 of No. 20	20
8 " " 5	5	4 " " 11	11	2 " " 22	22
2 " " 8	8	8 " " 12	12	1 " " 24	24
		2 " " 15	15	54 " " 37	37
		2 " " 17	17	2 " " 52	52
		1 " " 19	19	3 " " 53	53
				4 " " 59	59
				6 " " 60	60
				1 " " 63	63

Perambulator

Model No. 176

Parts Required:

3 of No. 1	1	1 of No. 16	16
10 " " 2	2	4 " " 19A	19A
12 " " 5	5	2 " " 22	22
2 " " 10	10	10 " " 35	35
12 " " 12	12	45 " " 37	37
3 " " 15A	15A	1 " " 52	52
		3 " " 60	60

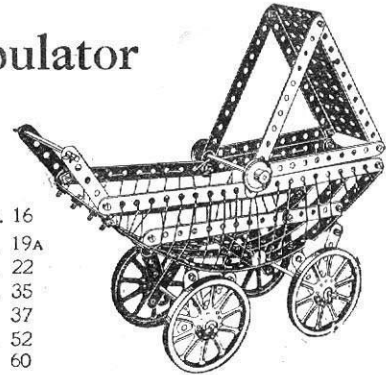

Model No. 177 "Drop the Nigger"

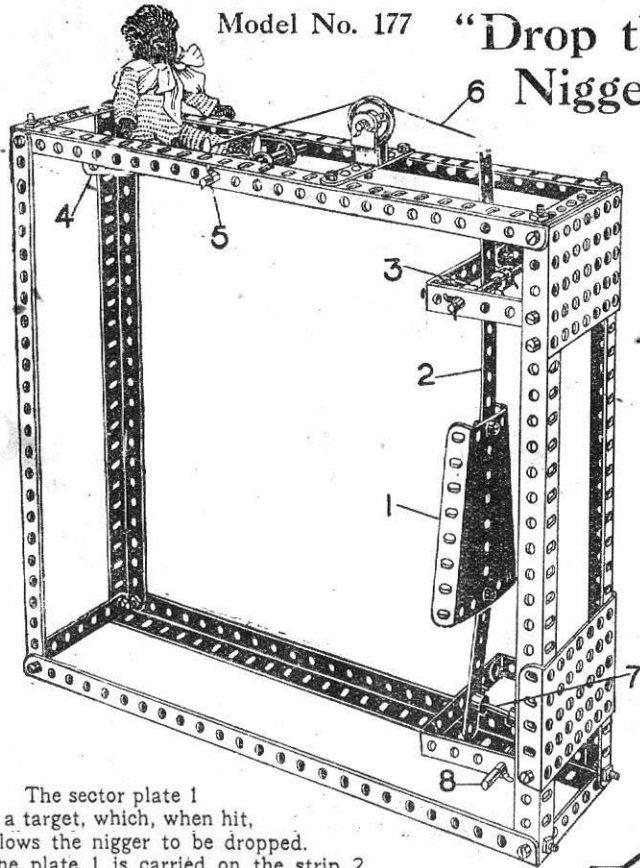

The sector plate 1 is a target, which, when hit, allows the nigger to be dropped. The plate 1 is carried on the strip 2

The sector plate 1 is a target, which, when hit, pivoted at 3, and the weight of the nigger supported on another sector plate 4 pivoted at 5 by means of the cord 6 keeps the lower end of the strip 2 hard against a short rod 7 pivoted at 8. When the target is hit and knocked back the rod 7 is released and falls about its pivot, allowing the sector plate 4, with the nigger to drop.

Parts Required:

1 of No.	1
6 "	3
8 "	8
1 "	12
3 "	15A
4 "	17
1 "	22
6 "	35
33 "	37
1 "	44
2 "	53
2 "	54
3 "	59
4 "	60
1 "	63

Model No. 178 Newton's Disc

This is a model to show that white light is made up of the three primary colours—red, yellow, blue. Sectors of these three colours are mounted or painted on the disc, which, if then quickly rotated, shows as white.

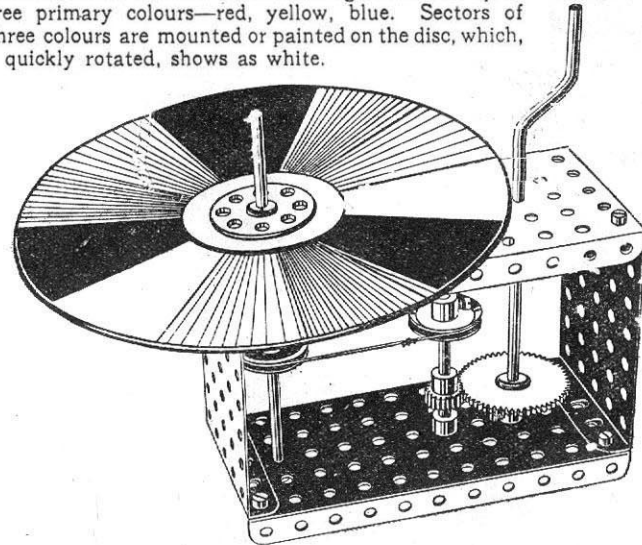

Parts Required:

1 of No.	15
1 "	15A
1 "	19
2 "	22
1 "	24
1 "	26
1 "	27
2 "	35
8 "	37
2 "	52
2 "	53
4 "	59

Model No. 179

Parts Required:

2 of No.	2
1 "	3
10 "	5
3 "	11
10 "	12

Wire Rope Maker

3 of No.	15	2 of No.	26	2 of No.	52
2 "	15A	1 "	27A	3 "	53
2 "	19	2 "	35	4 "	59
4 "	20	38 "	37	2 "	60
1 "	24	1 "	45	2 "	62

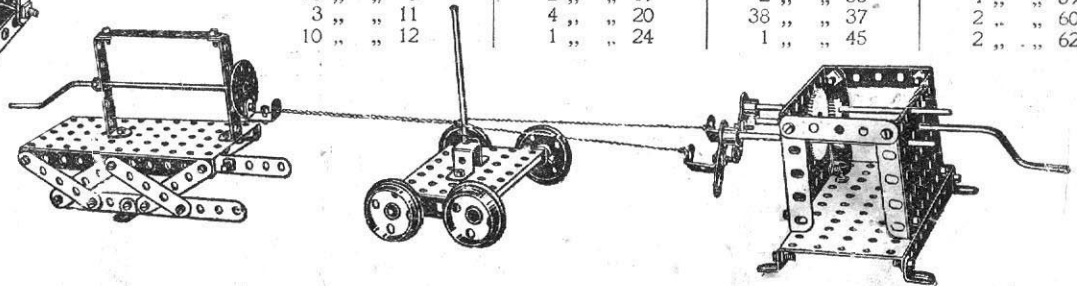

Model No. 180 Roundabout

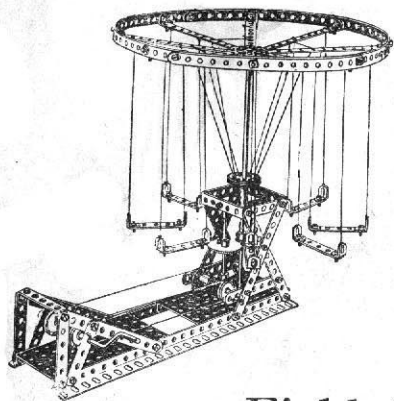

Parts Required:

3 of No. 1	4 of No. 22
14 " " 2	2 " " 26
2 " " 3	1 " " 27
2 " " 4	1 " " 32
12 " " 5	68 " " 37
2 " " 8	2 " " 52
24 " " 12	4 " " 59
3 " " 15	4 " " 60
1 " " 16	1 " " 63
1 " " 19	12 " " 38
1 " " 21	

Model No. 181

Trunk Hesister

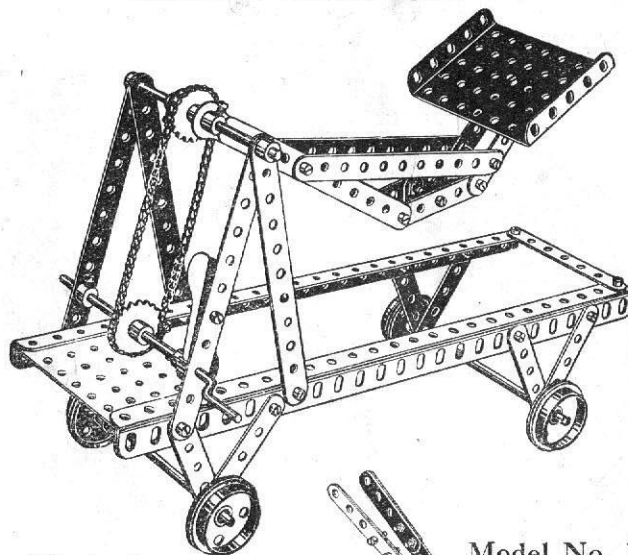

Parts Required:

8 of No. 2
1 " " 3
12 " " 5
2 " " 8
2 " " 11
2 " " 15
1 " " 15
1 " " 19
4 " " 20
1 " " 26
1 " " 33
13 " " 37
2 " " 53
3 " " 59
2 " " 62
2 " " 96

Model No. 182

Field Gun and Carriage

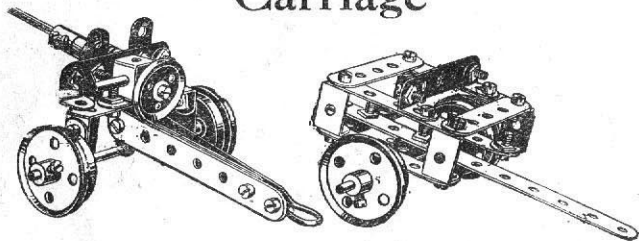

Parts Required

1 of No. 2	2 of No. 15A	27 of No. 37
5 " " 3	" " " 16	1 " " 45
12 " " 5	1 " " 17	1 " " 57
2 " " 10	4 " " 20	2 " " 59
4 " " 11	1 " " 22	2 " " 60
5 " " 12	1 " " 32	1 " " 63

Model No. 183 Rattle

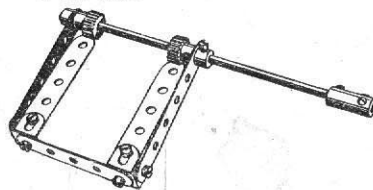

Parts Required:

2 of No. 4	2 of No. 26
3 " " 5	6 " " 37
4 " " 12	2 " " 59
1 " " 15	1 " " 63

Model No. 184

Scarifier

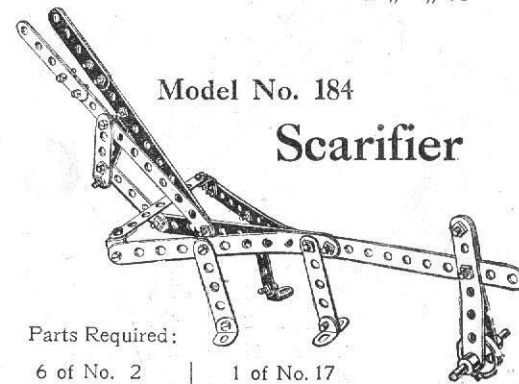

Parts Required:

6 of No. 2	1 of No. 17
3 " " 3	1 " " 22
10 " " 5	22 " " 37
6 " " 12	2 " " 59

Model
No. 185 **Swing**

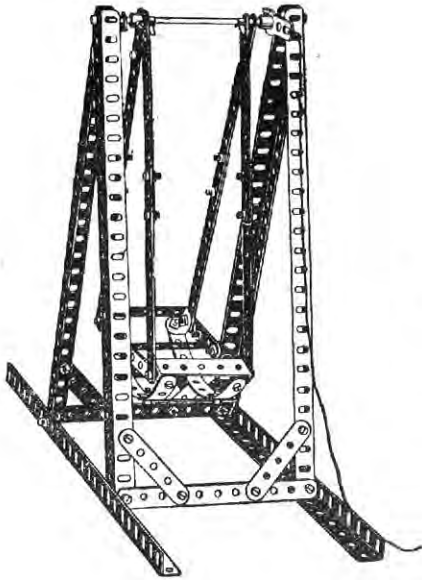

Parts Required:

12 of No. 2	1 of No. 15
10 " " 5	45 " " 37
6 " " 8	4 " " 60
2 " " 11	2 " " 62
4 " " 12	

Model
No. 186 **Automatic
Swing Boat**

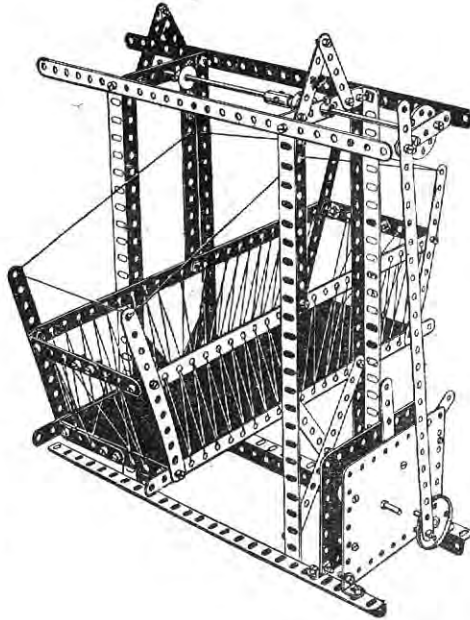

Parts Required:

7 of No. 1	1 of No. 21
10 " " 2	1 " " 24
3 " " 3	66 " " 37
12 " " 5	2 " " 59
4 " " 8	2 " " 62
12 " " 12	1 " " 63
2 " " 15	

Model
No. 187 **Swing**

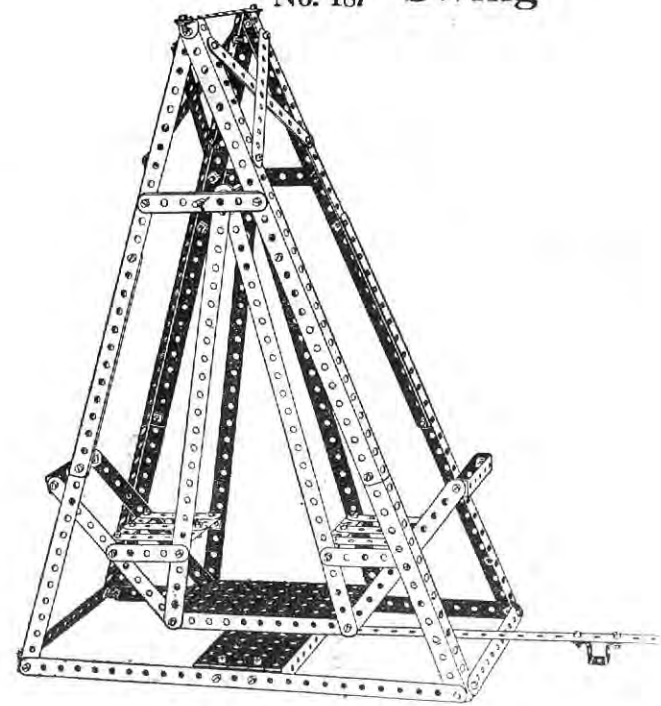

Parts Required:

7 of No. 1	1 of No. 15
11 " " 2	6 " " 35
2 " " 3	67 " " 37
10 " " 5	1 " " 45
8 " " 8	2 " " 52
6 " " 12	6 " " 60

Model No. 188 Pit Head Gear

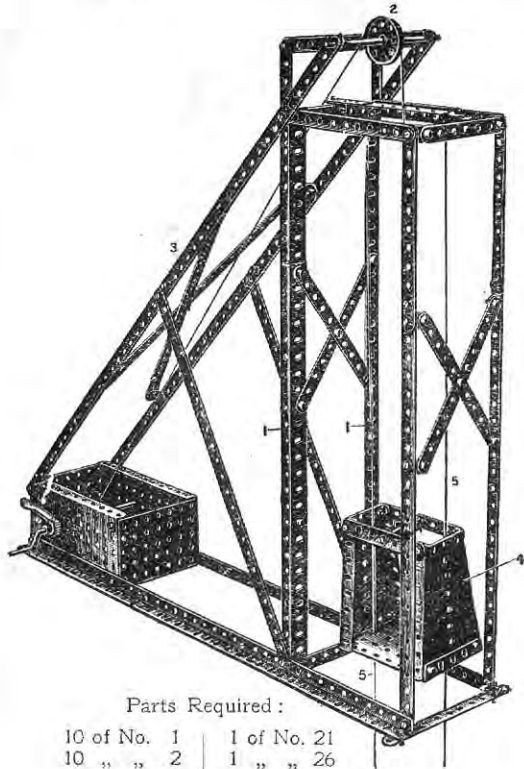

Parts Required :

10 of No. 1	1 of No. 21
10 " " 2	1 " " 26
6 " " 3	1 " " 33
4 " " 5	6 " " 35
8 " " 8	76 " " 37
1 " " 11	2 " " 52
14 " " 12	3 " " 53
1 " " 15	2 " " 54
1 " " 17	1 " " 59
1 " " 19	

Model No. 189
Locomotive Crane

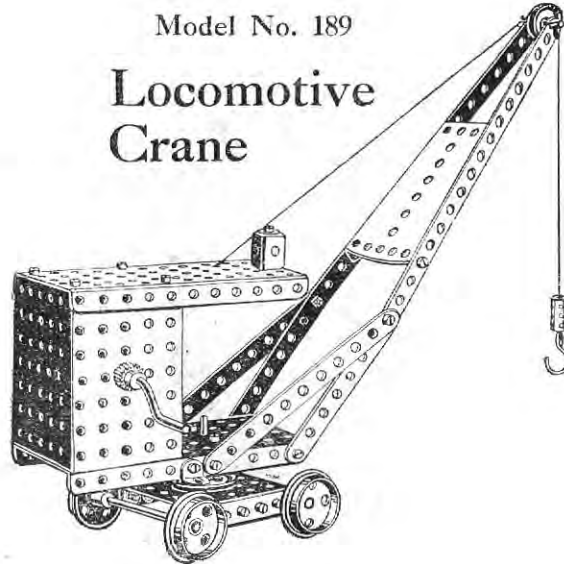

Parts Required :

2 of No. 1	1 of No. 24
2 " " 2	1 " " 26
2 " " 3	1 " " 33
3 " " 11	2 " " 35
2 " " 12	38 " " 37
2 " " 15A	2 " " 52
1 " " 17	3 " " 53
1 " " 18	1 " " 54
1 " " 19	1 " " 57
4 " " 20	2 " " 59
1 " " 21	5 " " 60
1 " " 22	1 " " 63

Model No. 190 Crane

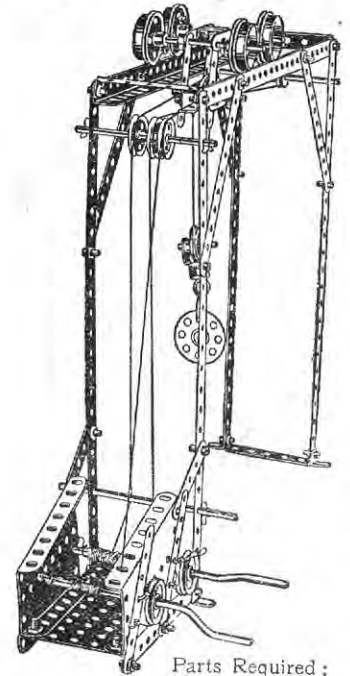

Parts Required :

4 of No. 1	4 of No. 20
6 " " 2	1 " " 21
2 " " 3	4 " " 22
10 " " 5	2 " " 22A
2 " " 8	1 " " 23
3 " " 11	1 " " 24
4 " " 12	12 " " 35
1 " " 15	32 " " 37
3 " " 15A	1 " " 44
1 " " 16	1 " " 52
1 " " 17	2 " " 54
1 " " 18	1 " " 57
2 " " 19	3 " " 60

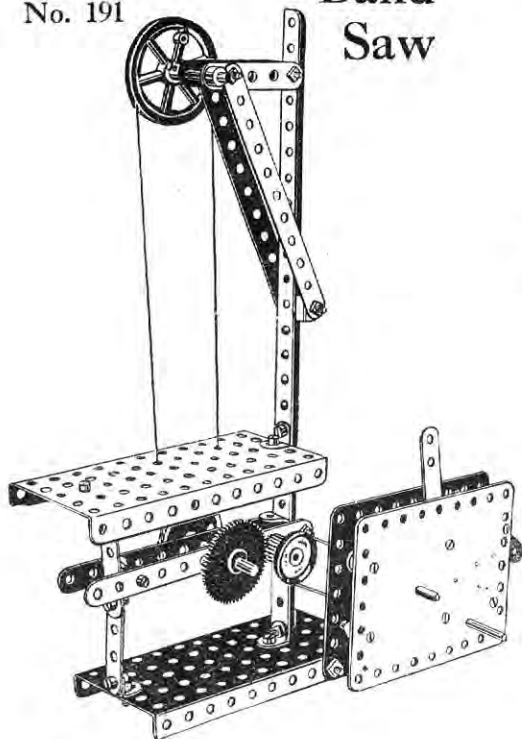
Model
No. 191**Band
Saw**

Parts Required :

4 of No. 2	2 of No. 17	1 of No. 27A
4 " " 5	1 " " 20A	21 " " 37
1 " " 8	1 " " 21	2 " " 52
3 " " 11	1 " " 22	2 " " 59
3 " " 12	1 " " 26	1 " " 60
1 " " 16		

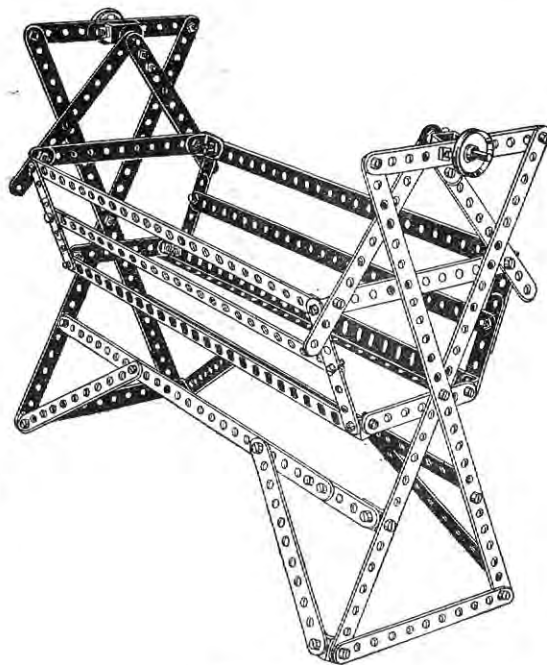
Model No. 192 **Swing Cot**

Parts Required :

10 of No. 1	20 of No. 12
14 " " 2	2 " " 17
2 " " 3	2 " " 22
8 " " 5	62 " " 37
2 " " 8	2 " " 62
2 " " 11	

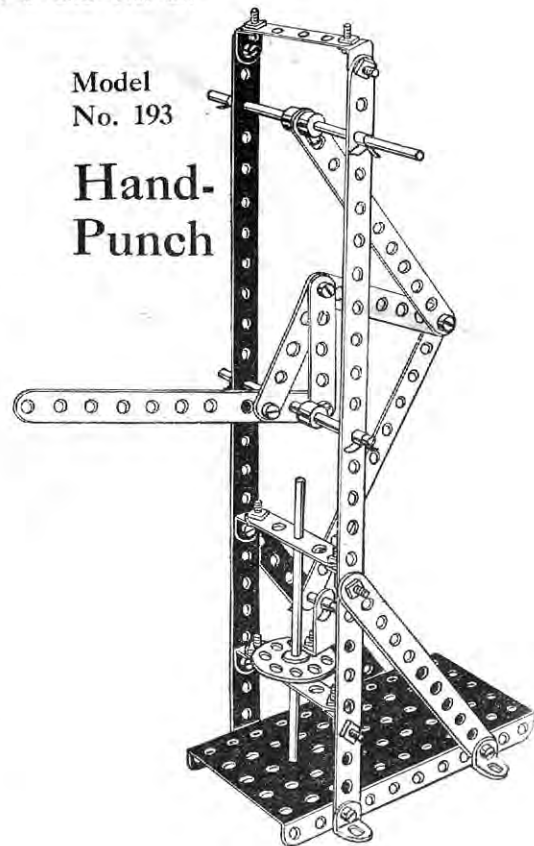
Model
No. 193**Hand-
Punch**

Parts Required :

2 of No. 1	1 of No. 15	23 of No. 37
5 " " 2	2 " " 16	1 " " 44
1 " " 3	1 " " 18	1 " " 52
2 " " 5	1 " " 24	4 " " 59
8 " " 12	6 " " 35	3 " " 60

Model
No. 194 **Hand Car**

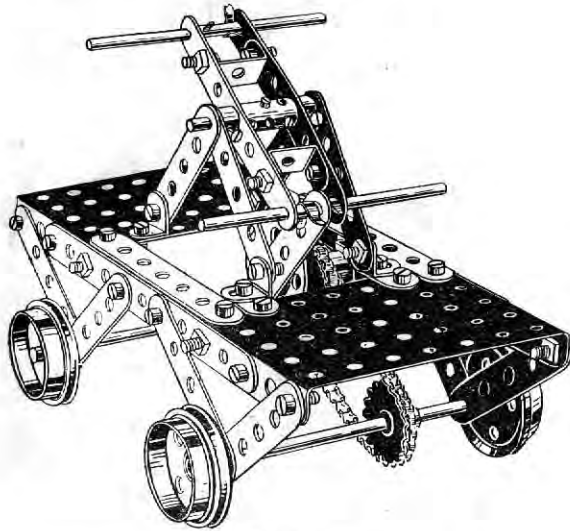

Parts Required :

2 of No. 2	2 of No. 15A	34 of No. 37
5 " " 3	2 " " 16	1 " " 45
12 " " 5	2 " " 17	2 " " 53
2 " " 10	4 " " 20	4 " " 59
2 " " 11	1 " " 24	1 " " 63
4 " " 12	4 " " 35	2 " " 96

Model
No. 195 **Oil Cake
Chopper**

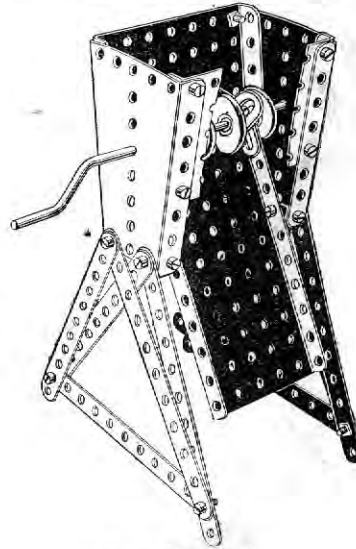

Parts Required :

10 of No. 2	20 of No. 37
4 " " 10	1 " " 52
4 " " 12	2 " " 53
1 " " 19	2 " " 54
4 " " 22	

Model
No. 196 **Rocking
Chair**

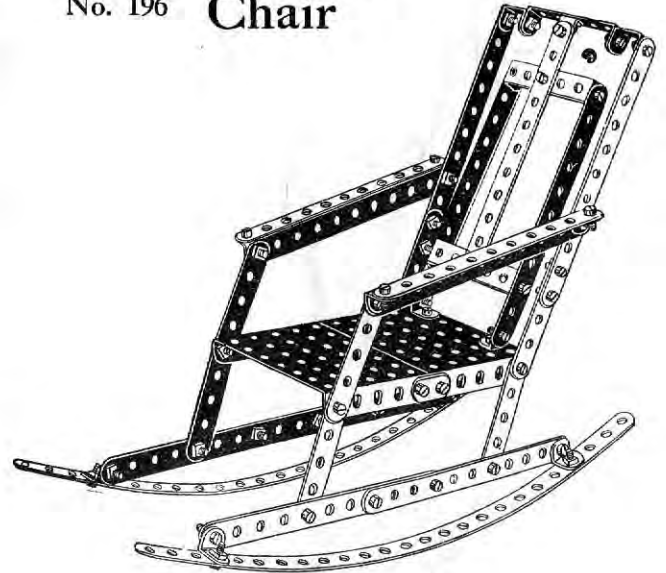

Parts Required :

2 of No. 1	2 of No. 10	48 of No. 37
13 " " 2	2 " " 11	2 " " 53
8 " " 5	11 " " 12	3 " " 60

HOW TO CONTINUE

This completes the Models which may be made with MECCANO Outfit No. 3. The next Models are a little more advanced, requiring a number of extra parts to construct them. The necessary parts are all contained in a No. 3A Accessory Outfit, the cost of which will be found in the Price List at the end of the Manual.

Model No. 197 Dutch Windmill

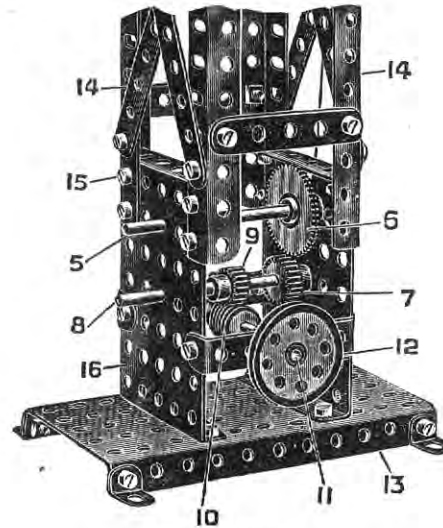
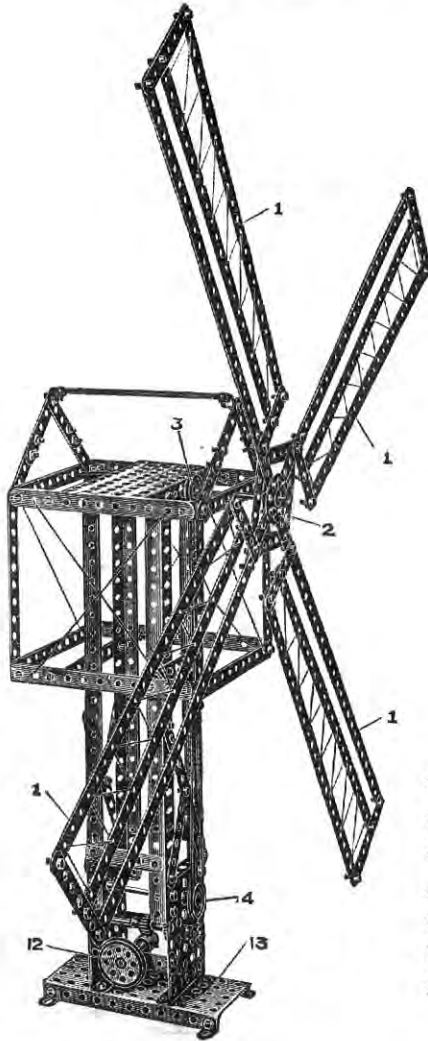

Fig. 197A

Parts Required :

12 of	1
19 "	2
4 "	3
4 "	4
14 "	5
4 "	8
22 "	12
1 "	14
3 "	16
1 "	21
2 "	22
1 "	24
2 "	26
1 "	27A
1 "	32
120 "	37
2 "	52
2 "	53
3 "	59
2 "	60

The construction of the sails 1 of the mill will be readily followed from the illustration. They are bolted to an inner strip frame 2 and to a bush wheel fixed on a spindle, on which is also mounted a pulley wheel 3, the driving cord passing round this pulley wheel to a lower pulley wheel 4, the driving of which will be followed from the detail. The pulley wheel 4 is on the outer end of the shaft 5, on which is fitted a gear wheel 6 driven by a pinion $\frac{3}{4}$ " 7 on the axle 8, this axle also carrying a pinion $\frac{1}{2}$ " 9 engaged by a worm 10 on the driving shaft 11, which carries the driving pulley 12. This driving gear is enclosed in two small side flanged plates 16 bolted to a base plate 13, the vertical stroke of the mill being made from corner angle girders 14 bolted at 15 to the side plates 16.

Model No. 198

Flying Machine

Most boys will have seen the Maxim Flying Machine at work, and will hardly fail to be interested in constructing a working model of it.

The main frame is composed of four angle girders connected at the bottom by two large flanged plates separated one hole apart and connected together by two small flanged plates carrying the crank handle, and at the top by a small flanged plate. Across the centre on opposite sides in the ninth hole down is attached a $3\frac{1}{2}$ " strip connected together by a $5\frac{1}{2}$ " strip. These transverse $3\frac{1}{2}$ " and $5\frac{1}{2}$ " strips and the small flanged plate at the top carry the perpendicular spindle upon which the upper structure revolves. A bush wheel is secured to this spindle to support the four arms, which are attached by four angle brackets. A pulley wheel is placed between this bush wheel and the perforated plate. The arms are supported by means of $5\frac{1}{2}$ " strips connected to a bush wheel secured on to the spindle, and the boats are connected to these by cord arranged as shown in the illustration. The platform is supported by four $12\frac{1}{2}$ " strips attached to the sides of the main framework. The manner of constructing the mechanism for operating the model is clearly shown in the illustration.

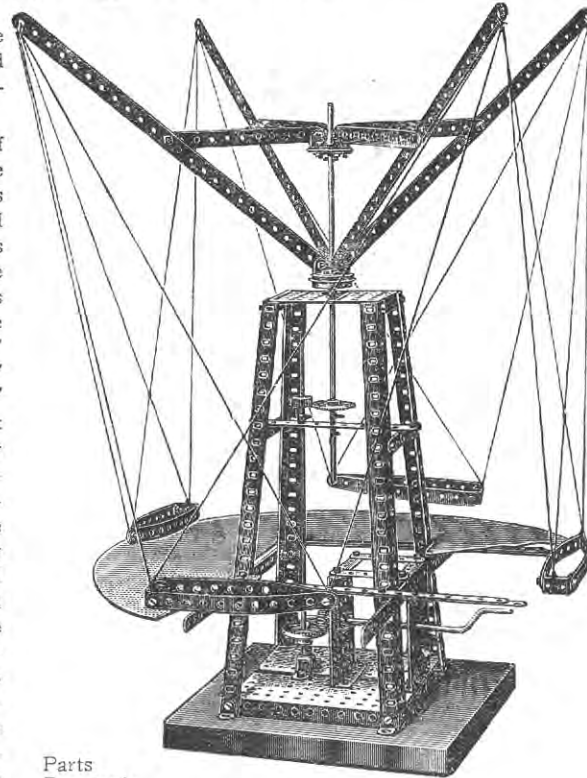

Parts Required:

8 of No. 1	18 of No. 12	1 of No. 28
13 " " 2	2 " " 13	74 " " 37
2 " " 3	1 " " 19	1 " " 45
2 " " 5	2 " " 24	2 " " 52
4 " " 8	2 " " 26	3 " " 53
4 " " 11	1 " " 27	4 " " 59

Model No. 199

Automobile

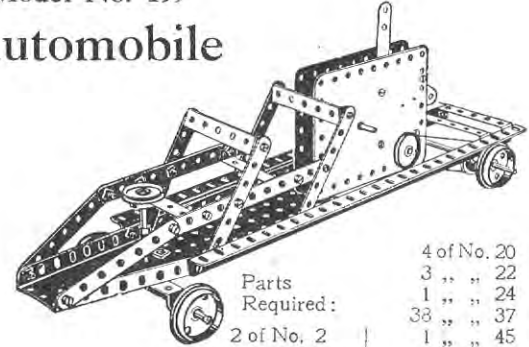

Parts Required:

2 of No. 2	4 of No. 20
6 " " 3	3 " " 22
2 " " 8	1 " " 24
4 " " 12	38 " " 37
2 " " 15	1 " " 45
2 " " 17	1 " " 46
	1 " " 52
	1 " " 54
	3 " " 59
	7 " " 60

Model No. 200

Drilling Machine

Parts Required:

4 of No. 5
1 " " 15
1 " " 15A
1 " " 17
1 " " 21
2 " " 22
1 " " 26
1 " " 28
13 " " 37
1 " " 45
1 " " 46

2 of No. 53
2 " " 59
1 " " 62
1 " " 63

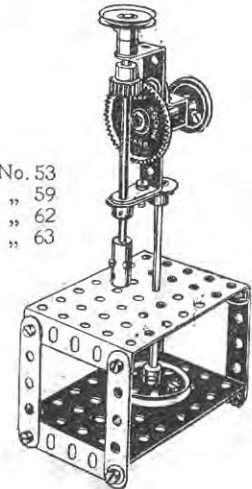

Model No. 201 Travelling Crane

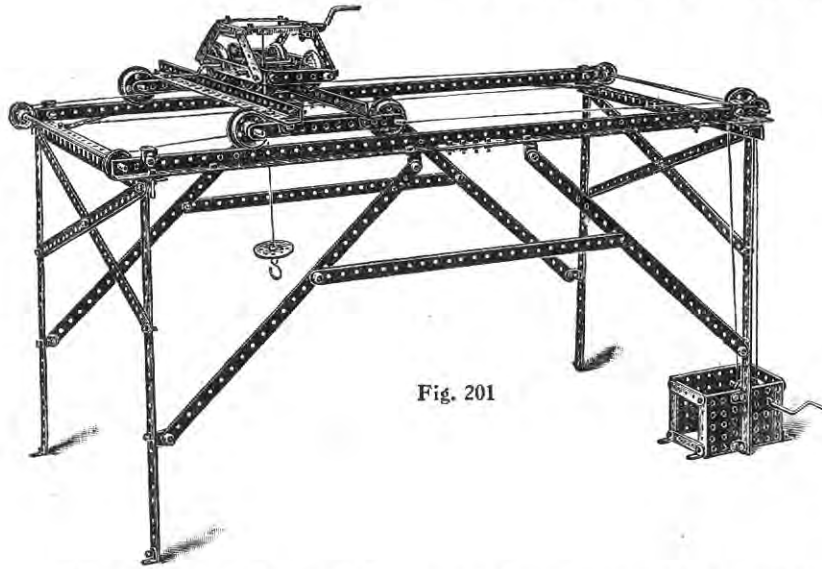

Fig. 201

Parts Required :

14 of No. 1	4 of No. 22
6 " " 2	1 " " 22A
4 " " 4	1 " " 24
10 " " 5	2 " " 26
8 " " 8	1 " " 27A
26 " " 12	1 " " 33
2 " " 13	4 " " 35
2 " " 15	98 " " 37
4 " " 17	2 " " 53
3 " " 19	1 " " 57
8 " " 20	5 " " 59
1 " " 21	4 " " 60

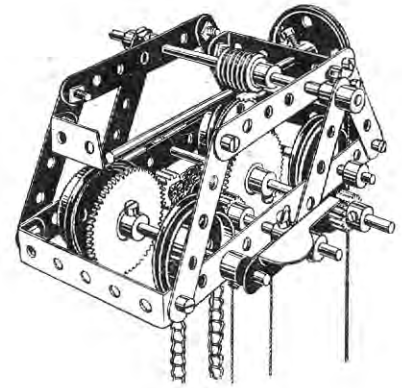

Fig. 201c

Separate views are given of two distinct parts composing the travelling crane. Fig. 201 is a complete view of the structure showing the braced gantry carrying a rail at each side. The rails are formed by angle girders butt-jointed. Fig. 201A shows the construction of the travelling gantry with two pairs of wheels so arranged as to fit the gauge of the rails. The gantry is caused to travel to and fro on the rails by a cord which is connected to the gantry by a nut and bolt 1 and passes over a pulley at each end of the rail, secured to the rod. On one of these rods is secured a $1\frac{1}{2}$ " pulley carrying the driving cord, which passes over a pulley wheel secured to the crank handle. The winch Fig. 201B again is arranged to run on the gantry rails of 201A, and is provided with a cranked hoisting axle 2 and another axle 3 for traversing the winch.

Fig. 201c is an alternative winch.

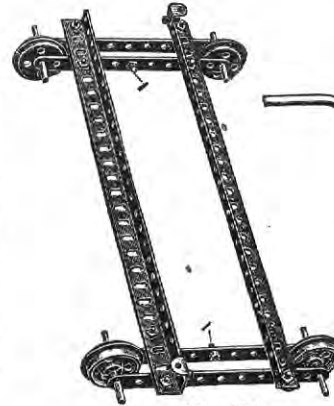

Fig. 201A

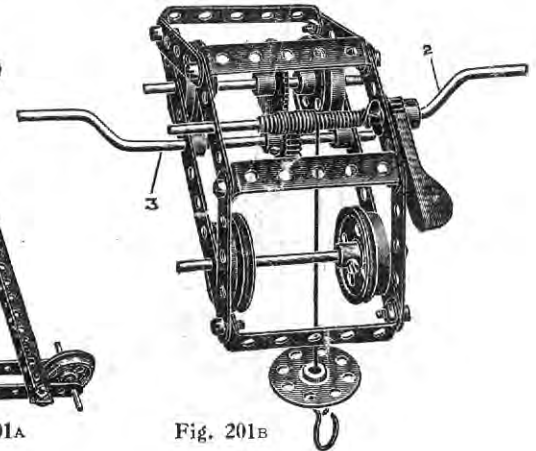

Fig. 201B

Model No. 202 Elevated Jib Crane

Fig. 202A

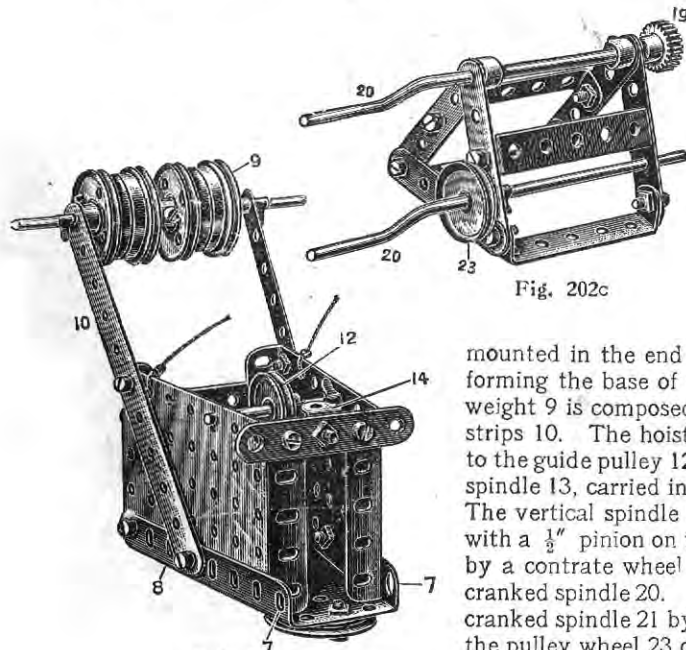
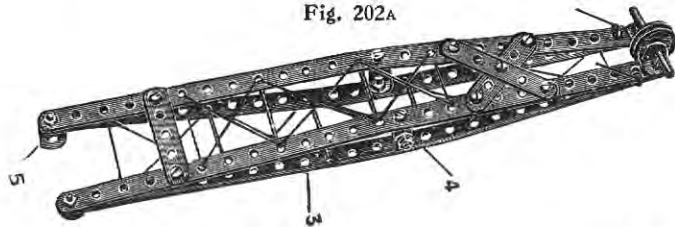

Fig. 202B

Fig. 202c

Parts Required :

4 of No. 1	1 of No. 24
7 " " 2	2 " " 26
2 " " 3	1 " " 27A
11 " " 5	1 " " 28
4 " " 8	9 " " 35
2 " " 11	64 " " 37
11 " " 12	1 " " 45
2 " " 13	1 " " 46
2 " " 15	2 " " 52
3 " " 17	3 " " 53
4 " " 20	1 " " 54
1 " " 21	1 " " 57
4 " " 22	5 " " 59
1 " " 22A	4 " " 60

The base of the main frame is composed of two large flanged plates 1, to the outer corners of which are bolted the vertical angle girders 2. The jib, Fig. 202A, is made from $12\frac{1}{2}$ " strips 3 distended centrally by double brackets 4 and bolted together at the ends. Angle brackets 5 form the pivots for the jib about a spindle 6

mounted in the end holes 7 of the flanges of the sector plate 8 forming the base of the upper gear box, Fig. 202B. The balance weight 9 is composed of several flanged wheels carried from $5\frac{1}{2}$ " strips 10. The hoisting cord 11 passes over the jib end pulley to the guide pulley 12, and winds on the upper end of the vertical spindle 13, carried in the angle bracket 14, and the top plate 15. The vertical spindle 13 is operated by a gear wheel 16 meshing with a $\frac{1}{2}$ " pinion on the other vertical spindle 17, which is driven by a contrate wheel 18 from a $\frac{1}{2}$ " pinion 19, Fig. 202c, on the cranked spindle 20. The swivelling of the jib is effected from the cranked spindle 21 by the continuous cord 22 which passes round the pulley wheel 23 over the pulley wheel 24, and round the $1\frac{1}{2}$ " pulley wheel 25, bolted to the under surface of the base sector plate 8 of the upper gear box.

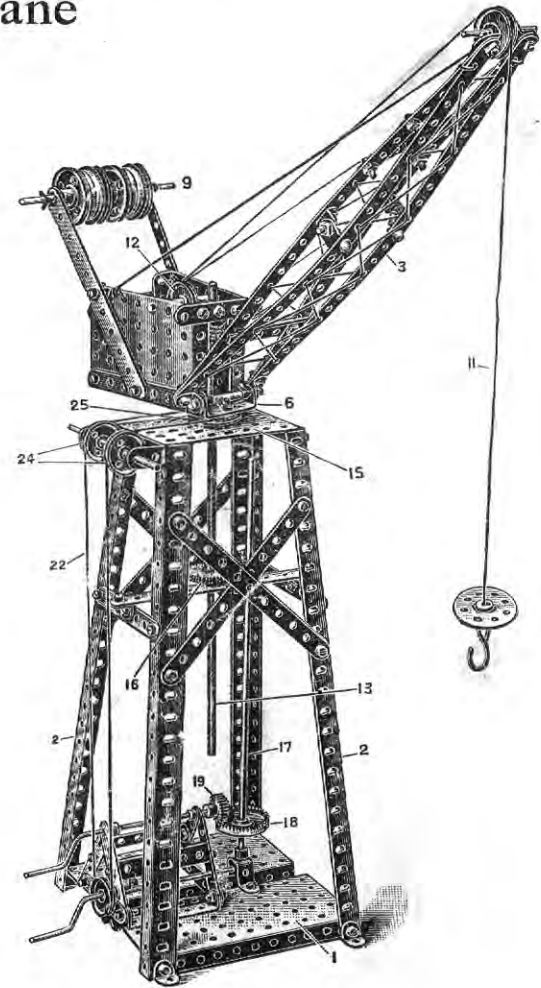

Model No. 204 Motor Plough

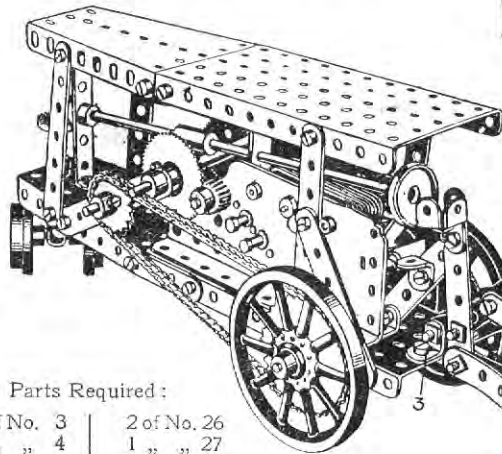

Parts Required:

8 of No. 3	2 of No. 26
2 " " 4	1 " " 27
12 " " 5	1 " " 29
2 " " 10	4 " " 35
1 " " 11	65 " " 37
15 " " 12	2 " " 52
2 " " 15	3 " " 54
4 " " 16	8 " " 59
1 " " 17	2 " " 60
1 " " 18	2 " " 62
2 " " 19	4 " " 63
2 " " 19A	2 " " 95
4 " " 20	2 " " 96
1 " " 22	Motor.

Model No. 203 Suspension Bridge

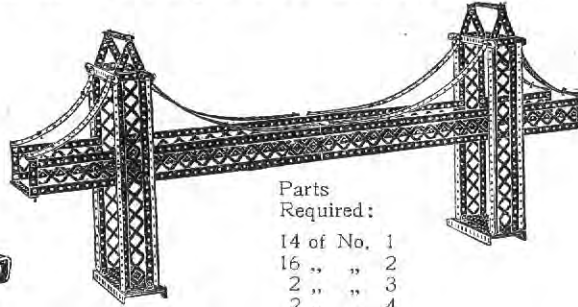

Parts Required:

14 of No. 1	1
16 " " 2	2
2 " " 3	3
2 " " 4	4
12 " " 5	5
8 " " 8	8
4 " " 11	11
22 " " 12	12
98 " " 37	37
2 " " 52	52
3 " " 53	53

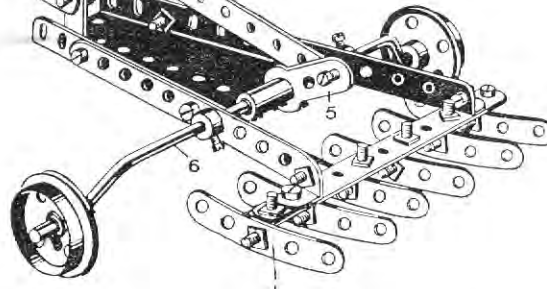

Model No. 205 Elevator

Parts Required:

4 of No. 1	3 of No. 22
20 " " 2	1 " " 26
4 " " 3	1 " " 27A
2 " " 4	1 " " 33
2 " " 5	74 " " 37
8 " " 8	1 " " 44
9 " " 12	2 " " 52
2 " " 14	2 " " 53
1 " " 15	5 " " 59
2 " " 17	1 " " 63
1 " " 19	

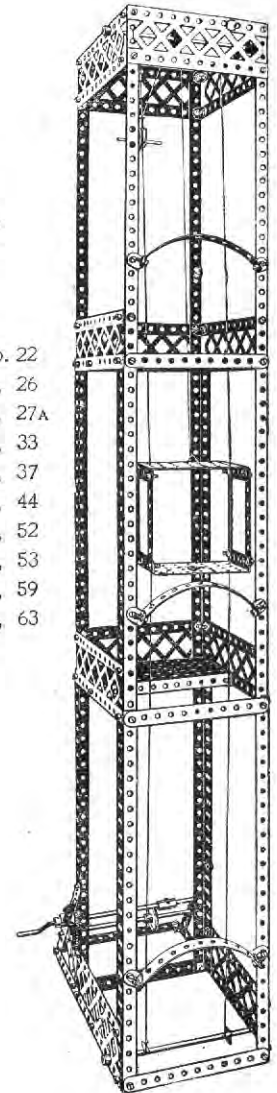

The ploughshares 1 are raised or lowered by the handle 2 pivoted to an angle bracket on the far side of the seat pillar, and connected by strips 4 to a crank 5 secured on the bent axle 6 of the wheels formed by crank handles.

Model
No. 206

Swinging Hot Saw

Parts Required :

2 of No. 1	1 of No. 27
9 " " 2	1 " " 28
2 " " 3	1 " " 32
1 " " 4	41 " " 37
4 " " 8	3 " " 53
1 " " 12	1 " " 54
2 " " 15	6 " " 59
3 " " 16	3 " " 60
1 " " 21	2 " " 62
2 " " 22	1 " " 63
2 " " 26	2 " " 96

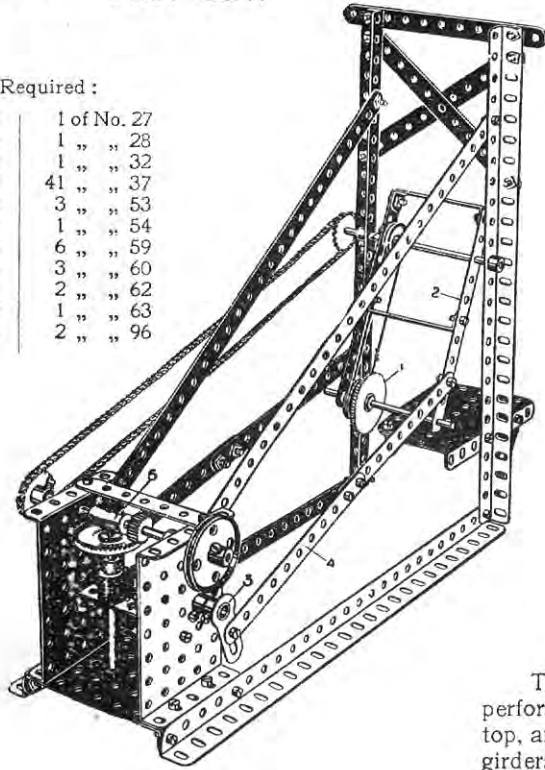

The swinging frame 2 carrying the circular saw 1 is rocked to and fro by a continuous rotary movement of the crank 3 through the connecting strips 4. The coupling 5 is loose on the sprocket wheel spindle and forms a bearing for the spindle of the worm.

Model
No. 207

Travelling Crane

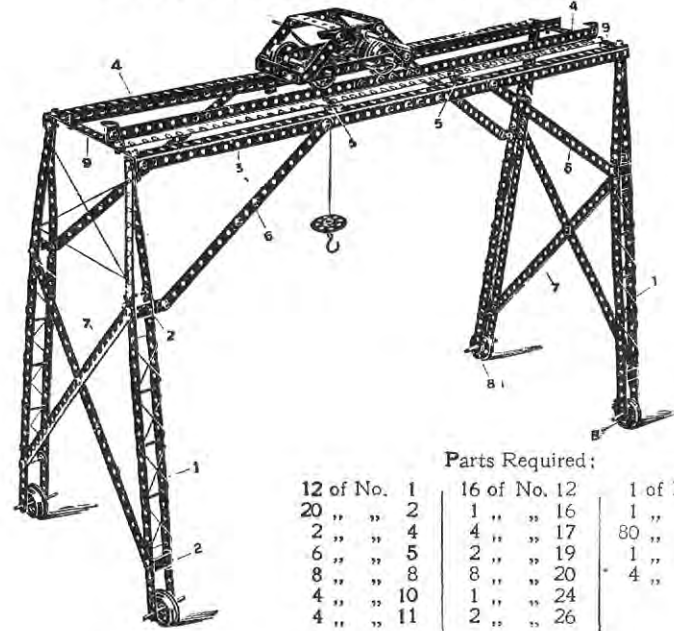

Parts Required :

12 of No. 1	16 of No. 12	1 of No. 27A
20 " " 2	1 " " 16	1 " " 33
2 " " 4	4 " " 17	80 " " 37
6 " " 5	2 " " 19	1 " " 57
8 " " 8	8 " " 20	4 " " 60
4 " " 10	1 " " 24	
4 " " 11	2 " " 26	

The side frames of this model are similarly constructed. Each leg 1 is made of $12\frac{1}{2}$ " and $5\frac{1}{2}$ " perforated strips overlapped two holes and distended by double brackets 2 and bolted together at the top, and to angle brackets bolted to the ends of the outer horizontal angle girders 3. The inner angle girders 4 are reversed with their webs up, to form rails for the crane. The central parts of the girders 4 are supported by flat brackets 5, and the outer girders 3 are braced by the diagonal $5\frac{1}{2}$ " strips 6 bolted to the legs 1 and the girders 3. Each end pair of legs is also braced by the crossed $12\frac{1}{2}$ " strips 7. The whole gantry travels on the flanged wheels 8 carried on 2" rods passed through the lowest holes of the legs 1. $5\frac{1}{2}$ " strips 9 connect the outer girders 3 and inner girders 4. The winch is constructed as shown in Fig. 201B.

Model No. 208 Lathe

This model is but one example of the great practical possibilities to which the Meccano system of construction may be applied. The illustration shows a model lathe, the framework of which is built very rigidly of overlapped angle girders 1, to which are bolted by their flanges four small flanged plates 2, the fast headstock of the lathe being provided by a rod 3, one end journalled in a bush wheel 4 bolted to the end plate, and the other journalled in the boss of a crank 5. The loose headstock is formed by an axle 6 journalled in bolted to the inner plate. The drive from the flanged wheels 8 butted together on the headstock

the end plate 2, and a crank 7 motor is carried round two spindle 3, on the other end of which is gripped a coupling 9 by one of its screws, this coupling being also secured to a centre fork driven into the article 10 to be turned. The detail view to the right shows how a knob or other article may be screwed to a bush wheel 11, the base 12 of which is gripped by its screw to the headstock spindle 3 to form a chuck or face plate. The electric motor shown in the illustration is one-thirtieth horse-power.

Parts Required:

4 of No. 4	
8 " " 8	
1 " " 13	
1 " " 14	
2 " " 20	4 of No. 53
1 " " 24	1 " " 59
30 " " 37	2 " " 62

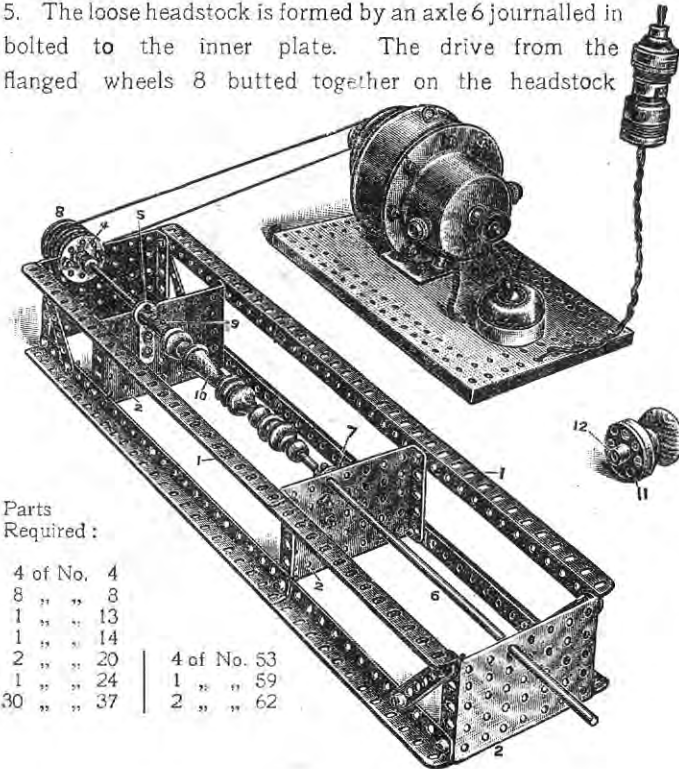

Model No. 209

Armoured Motor Car

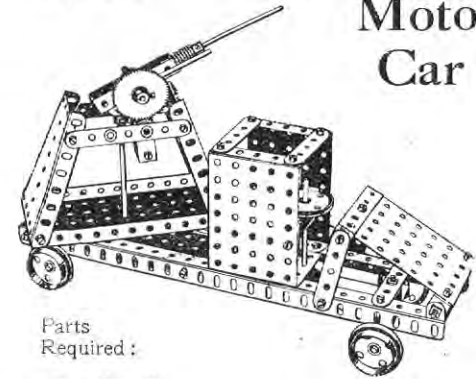

Parts Required:

2 of No. 3	
9 " " 5	
2 " " 8	
2 " " 11	
2 " " 12	
2 " " 15	
2 " " 15A	
1 " " 16	
3 " " 17	
4 " " 20	
1 " " 21	
4 " " 22	
1 " " 24	
1 " " 26	
1 " " 27	
1 " " 32	
43 " " 37	
1 " " 45	
2 " " 52	
3 " " 53	
2 " " 54	
1 " " 59	
7 " " 60	
1 " " 62	
1 " " 63	

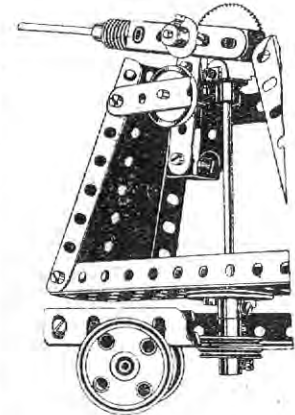

Fig. No. 209A

Model
No. 210

Cable Railway

Parts Required :

3 of No. 2	1 of No. 27A
2 " " 4	2 " " 29
1 " " 5	2 " " 35
2 " " 8	28 " " 37
6 " " 12	1 " " 46
4 " " 15	2 " " 52
2 " " 15A	3 " " 53
4 " " 20	2 " " 54
1 " " 21	2 " " 59
2 " " 22	
2 " " 26	

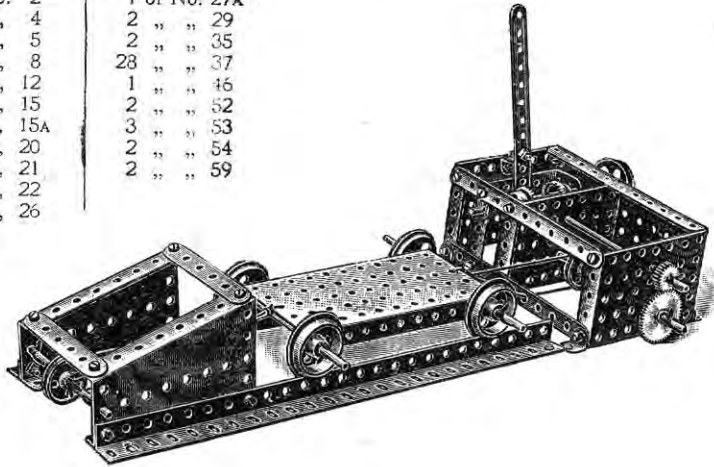

Our illustration hardly does this excellent model justice, owing to the parts having to be so crowded together. This is a very fine model, both instructive and highly interesting.

The driving power is received at the outer $1\frac{1}{2}$ " pulley, and is transmitted through the clutch mechanism and the pinion and gear wheels to the lower spindle on which the driving pulley is fixed, the driving rope passing round this pulley and the second pulley at the end of the rails, all as shown in the drawing.

In fixing the lever for operating the clutch mechanism, the nuts should be locked to prevent the screw working out. Only one section of rails is shown in the design, but they may be extended as desired.

Girder Crane

Model No. 211

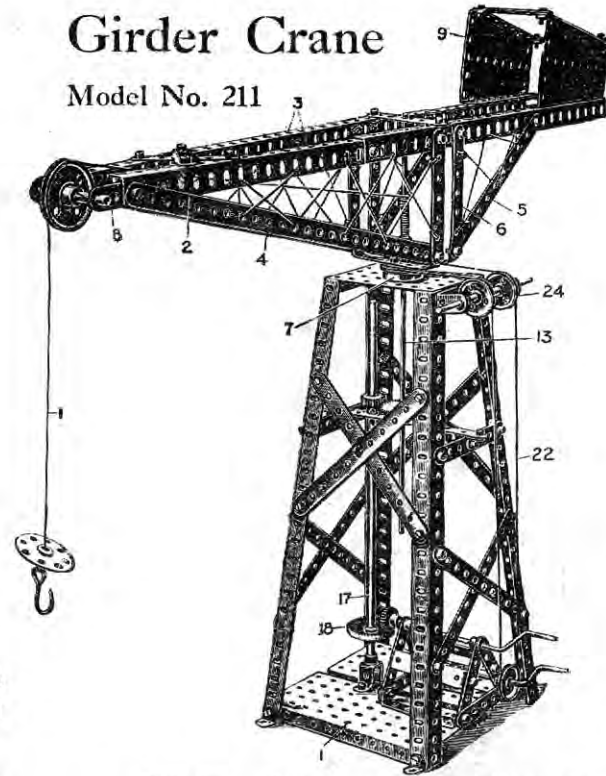

Parts
Required :

2 of No. 1
11 " " 2
6 " " 3
14 " " 5
8 " " 8
6 " " 12
2 " " 13
1 " " 16
1 " " 17
2 " " 19
1 " " 20
1 " " 21
3 " " 22
1 " " 24
2 " " 26
1 " " 27A
1 " " 28
6 " " 35
75 " " 37
1 " " 45
1 " " 46
2 " " 52
1 " " 53
2 " " 54
1 " " 57
4 " " 59
6 " " 60

The lower structure of this model is identical with that of Fig. 202. The hoisting cord 1 after passing over the end jib pulley, winds on the $1\frac{1}{2}$ " rod 13, as described in Fig. 202. The jib is built up of horizontal angle girders 3, overlapped 8 strips 5 connected to the vertical $3\frac{1}{2}$ " strips 6 bolted at the bottom to $2\frac{1}{2}$ " bent strips bolted to the flanged wheel 7. $2\frac{1}{2}$ " strips 8 extend from the angle girders 3 to carry the jib pulley. The balance weight is formed by two sector plates 9.

Swivelling and Luffing Jib Crane

Model No. 212

Parts Required :

14 of No. 1	1 of No. 24
1 " " 2	2 " " 26
4 " " 3	1 " " 27A
5 " " 5	1 " " 28
2 " " 8	1 " " 32
4 " " 10	1 " " 33
7 " " 11	5 " " 35
16 " " 12	71 " " 37
1 " " 15	1 " " 45
1 " " 15A	2 " " 52
2 " " 16	3 " " 53
4 " " 17	1 " " 54
2 " " 19	1 " " 57
4 " " 20	4 " " 59
1 " " 21	5 " " 60
1 " " 22	2 " " 63
3 " " 22A	

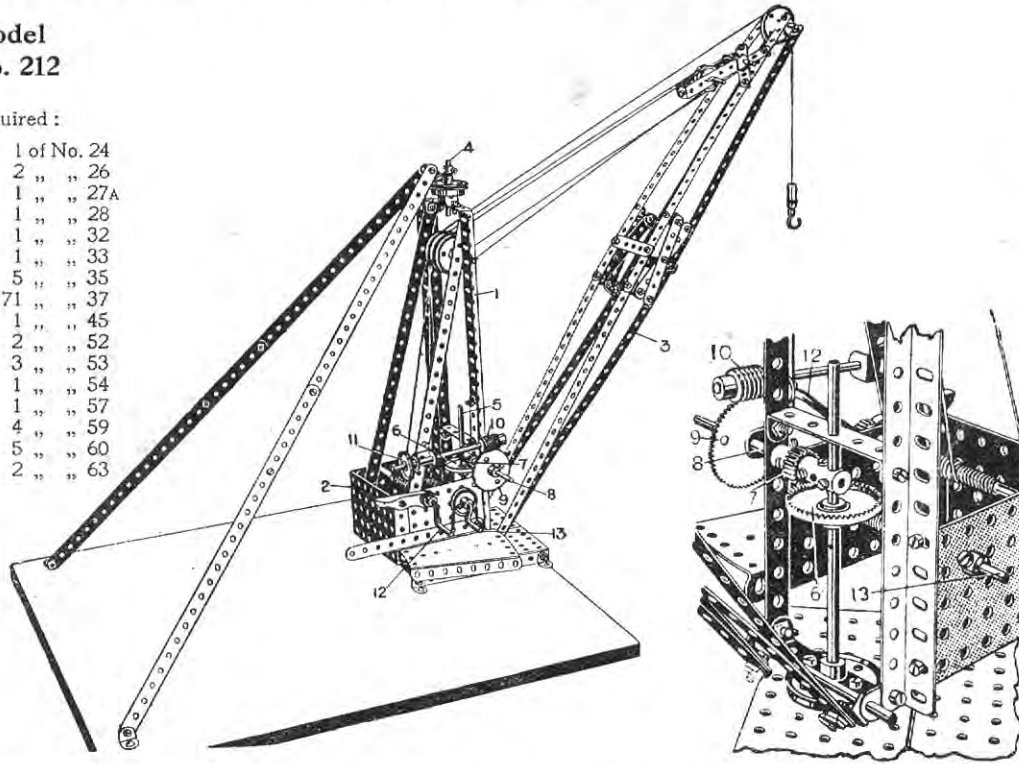

This is a model of a crane having a luffing action for the jib, that is raising or lowering, and a swivelling action for swinging the jib round. The whole frame 1, gearbox 2, and jib 3 swivel about the pivots 4 and 5, the lower rod 5 having a contrate wheel 6 fixed thereon engaged by a pinion 7 on the axle rod 8 which carries the worm wheel 9 driven by the worm 10 rotated by the pulley wheel 11, the pinion 7 riding on the fixed wheel 6 as on a rack. The jib is luffed from the crank handle 12, and the load raised or lowered from the handle 13.

Model No. 213

Automobile

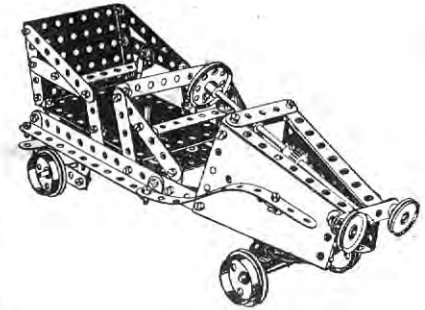

Parts Required :

8 of No. 2	1 of No. 21
5 " " 3	2 " " 22
4 " " 4	1 " " 24
9 " " 5	2 " " 26
6 " " 10	1 " " 28
28 " " 12	1 " " 29
1 " " 14	17 " " 37
1 " " 15	1 " " 45
1 " " 15A	1 " " 53
1 " " 17	2 " " 54
4 " " 20	4 " " 59
	2 " " 60

Model No. 214

Swing Bridge

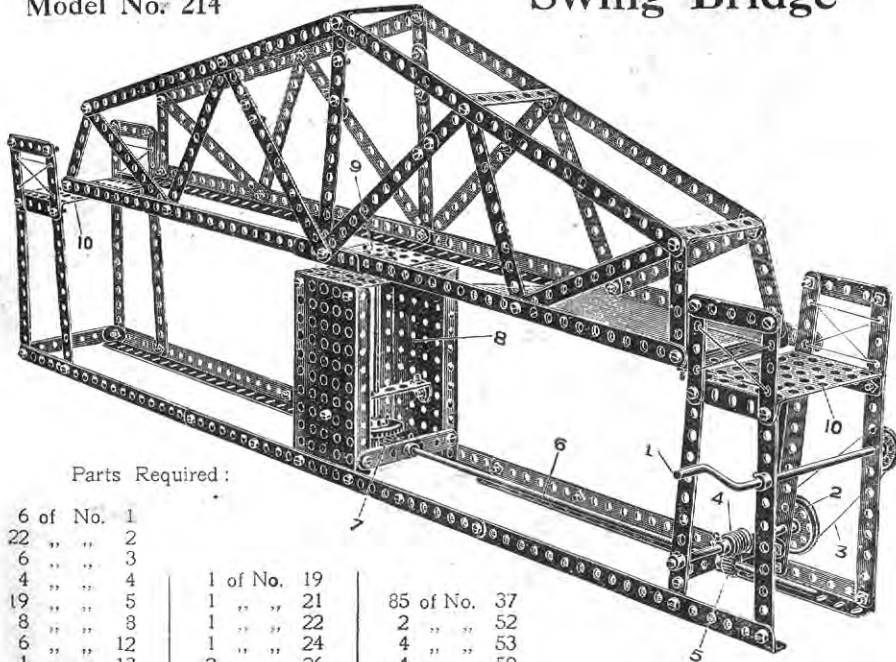

Parts Required :

6 of No. 1	1 of No. 19	85 of No. 37
22 " " 2	1 " " 21	2 " " 52
6 " " 3	1 " " 22	4 " " 53
4 " " 4	1 " " 24	4 " " 59
19 " " 5	2 " " 26	5 " " 60
8 " " 8	1 " " 28	1 " " 63
6 " " 12	1 " " 32	
1 " " 13		
2 " " 15		
1 " " 16		

The construction of this model will be quite apparent from the illustration. The crank handle 1 drives a pulley 2 by means of the cord 3. On the pulley spindle 2 is fixed a worm 4 geared with a $\frac{1}{2}$ " pinion 5 on the axle 6, another $\frac{1}{2}$ " pinion on the end of which drives a contrate wheel 7 on the vertical spindle 8 which carries the bridge, this spindle being secured to a bush wheel fastened to the underside of the small flanged plate 9 in the centre of the bridge. By operating the handle 1 the bridge may be swung round to the open position, or its ends brought opposite to the landing platforms 10.

Model No. 215
Armoured Motor Tricycle

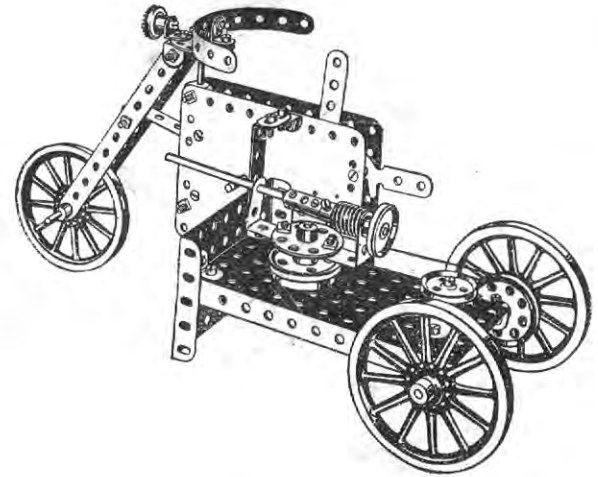

Parts Required :

4 of No. 2	1 of No. 20	2 of No. 45
1 " " 5	1 " " 21	1 " " 46
1 " " 10	4 " " 22	1 " " 52
3 " " 11	1 " " 22A	1 " " 53
6 " " 12	2 " " 24	8 " " 59
2 " " 15	1 " " 29	1 " " 60
1 " " 17	1 " " 33	1 " " 62
1 " " 18	29 " " 37	1 " " 63

Model
No. 216

Mechanical Cross Bow

The only part of this model requiring description is the release. To the inside of the angle girders is bolted a double bracket 1 through which slides the rod 2; at the other end of this rod are secured two collars between a double bracket threaded on to the rod, which slide down the channel of the girder strips when the bow is drawn back. The rod 3 of the small travelling frame 4 engages between the two set screws 5. As the frame 4 travels backwards, it is disengaged from the screws 5 by being lifted owing to the $5\frac{1}{2}$ " strips 6 being gradually inclined upwards to the rear.

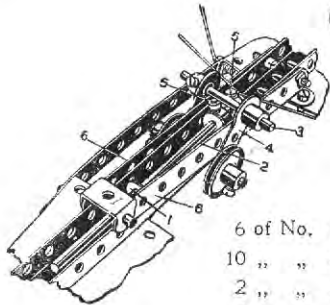

Fig. 216A

Parts Required:

6 of No. 1	1 of No. 11	59 of No. 37
10 " " 2	5 " " 12	2 " " 52
2 " " 3	1 " " 15	2 " " 54
5 " " 5	1 " " 17	4 " " 59
4 " " 8	1 " " 19	2 " " 62
	2 " " 22	

Model
No. 217

Clay Modelling Machine

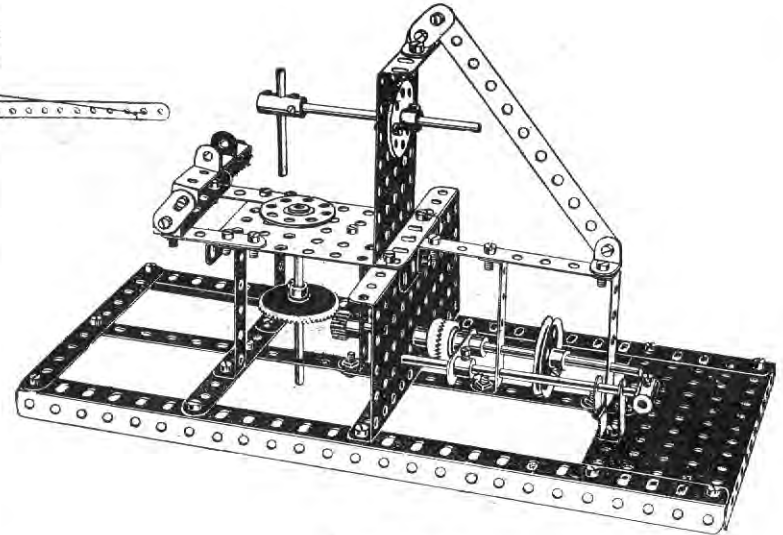

Parts Required:

4 of No. 2	1 of No. 15	2 of No. 29
1 " " 3	2 " " 16	41 " " 37
2 " " 5	1 " " 17	2 " " 52
2 " " 8	1 " " 21	2 " " 53
3 " " 10	2 " " 24	2 " " 59
1 " " 11	1 " " 26	7 " " 60
3 " " 12	1 " " 28	1 " " 62
1 " " 14		2 " " 63

Model No. 218 Fire Watertower

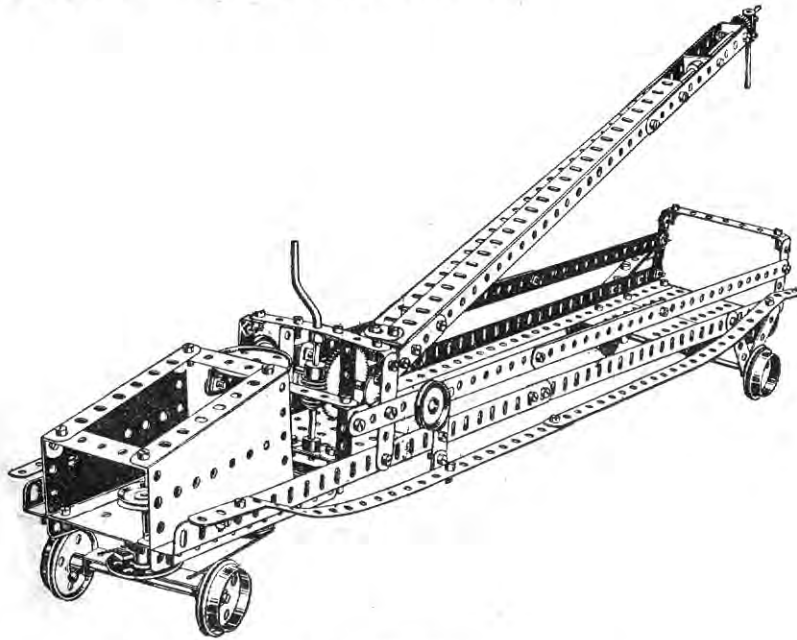

Parts Required :

4 of No. 1	2 of No. 16	98 of No. 37
2 " " 2	2 " " 17	1 " " 45
5 " " 3	1 " " 19	1 " " 52
14 " " 5	4 " " 20	3 " " 53
8 " " 8	1 " " 21	2 " " 54
2 " " 10	4 " " 22	5 " " 59
2 " " 11	2 " " 24	3 " " 60
12 " " 12	1 " " 26	2 " " 62
3 " " 15A	1 " " 27A	1 " " 63
	1 " " 32	

Model No. 219 Alternating Swing

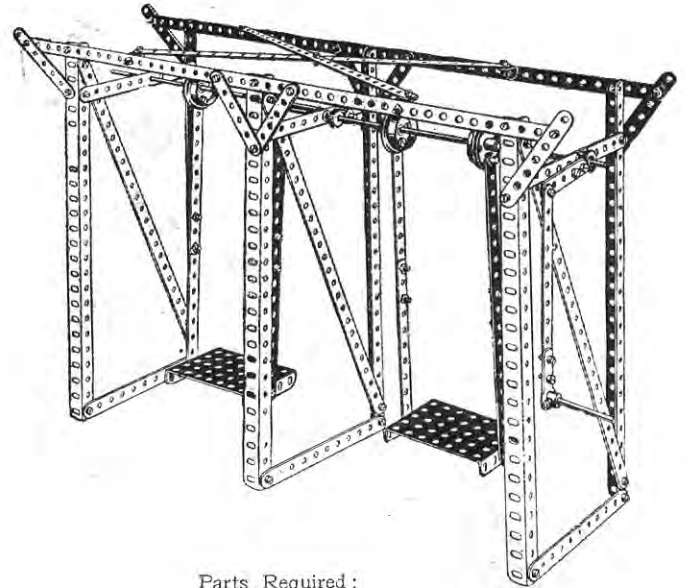

Parts Required :

9 of No. 1	4 of No. 20
15 " " 2	2 " " 26
6 " " 3	68 " " 37
2 " " 4	2 " " 53
4 " " 12	2 " " 59
2 " " 13	2 " " 62
1 " " 17	

Model
No. 220

Trip-Hammer

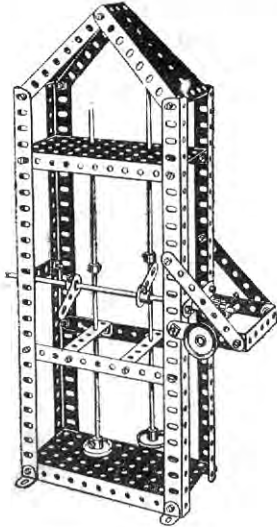

Parts Required :

2 of No. 2	3 of No. 22
2 " " 3	1 " " 26
4 " " 5	1 " " 32
4 " " 8	32 " " 37
4 " " 12	2 " " 52
2 " " 13	2 " " 54
1 " " 14	4 " " 59
1 " " 16	3 " " 60
1 " " 17	2 " " 62
	1 " " 63

Model
No. 221

Mechanical Navy

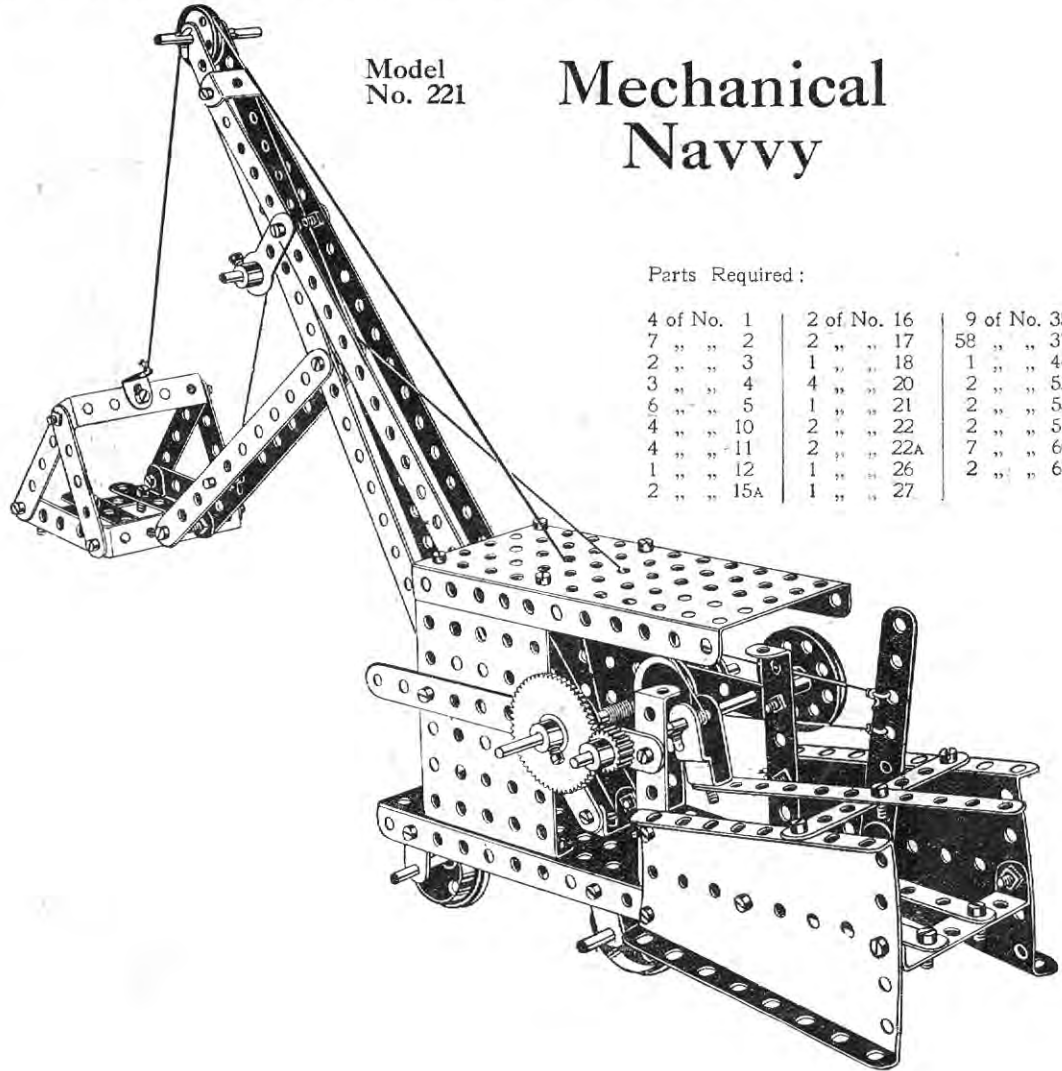

Parts Required :

4 of No. 1	2 of No. 16	9 of No. 35
7 " " 2	2 " " 17	58 " " 37
2 " " 3	1 " " 18	1 " " 44
3 " " 4	4 " " 20	2 " " 52
6 " " 5	1 " " 21	2 " " 53
4 " " 10	2 " " 22	2 " " 54
4 " " 11	2 " " 22A	7 " " 60
1 " " 12	1 " " 26	2 " " 62
2 " " 15A	1 " " 27	

Model No. 222
Catapult

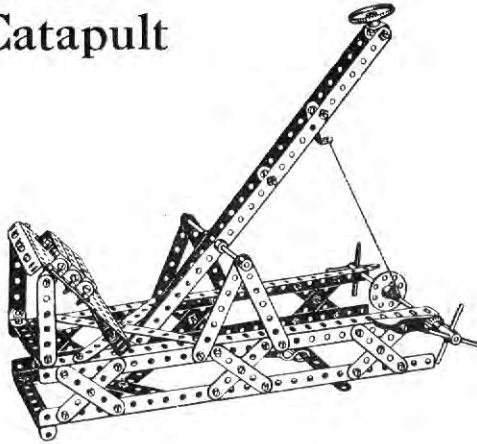

Parts
Required :

2 of No.	1
5 " "	2
6 " "	3
4 " "	4
12 " "	5
4 " "	8
2 " "	11
12 " "	12
1 " "	14
1 " "	15
4 " "	17
1 " "	24
1 " "	26
1 " "	28
1 " "	33
84 " "	37
1 " "	43
2 " "	53
4 " "	59
2 " "	63

Model No. 223

**Double-action
Windmill Pump**

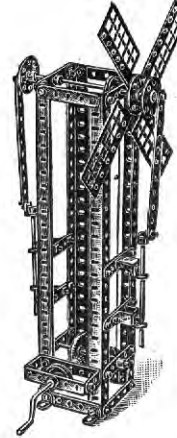

Parts Required :

2 of No.	2	1 of No.	24
14 " "	5	1 " "	26
4 " "	8	1 " "	28
2 " "	11	54 " "	37
10 " "	12	2 " "	45
3 " "	15	1 " "	46
1 " "	16	5 " "	59
1 " "	19	1 " "	60
1 " "	21	4 " "	61
2 " "	22	2 " "	62

Model No. 224 **Airship**

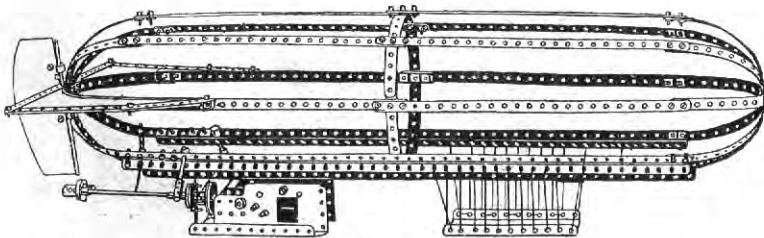

Parts Required :

12 of No.	1	3 of No.	15	1 of No.	27A	2 of No.	52
20 " "	2	3 " "	17	1 " "	29	4 " "	59
4 " "	3	1 " "	21	2 " "	35	4 " "	60
6 " "	8	4 " "	22	108 " "	37	2 " "	62
2 " "	10	2 " "	24	1 " "	45	2 " "	63
2 " "	12	1 " "	26				

Model No. 225

Lawn Mower

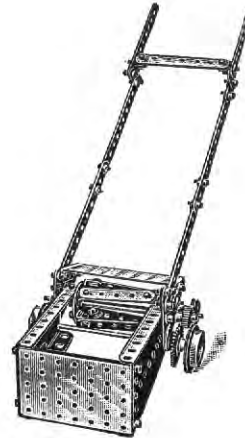

Parts Required :

4 of No.	2	1 of No.	23
2 " "	3	2 " "	24
10 " "	5	1 " "	26
4 " "	10	1 " "	27A
10 " "	12	50 " "	37
3 " "	15	3 " "	53
2 " "	20	2 " "	54
2 " "	22		

Model No. 226 Wire Rope Maker

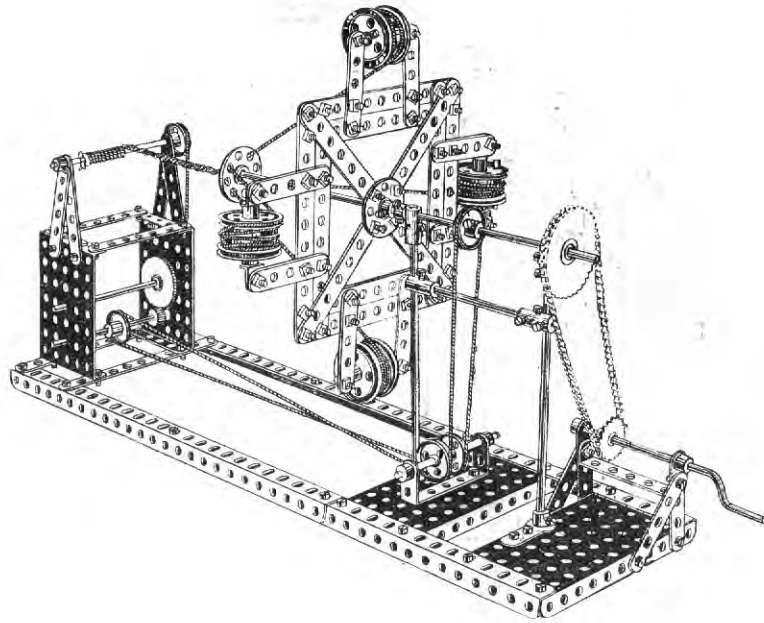

Parts Required :

10 of No. 2	2 of No. 14	2 of No. 22A
6 " " 3	4 " " 15	1 " " 24
4 " " 4	1 " " 16	1 " " 26
12 " " 5	4 " " 17	1 " " 27A
4 " " 8	1 " " 19	80 " " 37
8 " " 12	8 " " 20	2 " " 52
1 " " 13	4 " " 22	7 " " 59

Model No. 227

Delivery Van

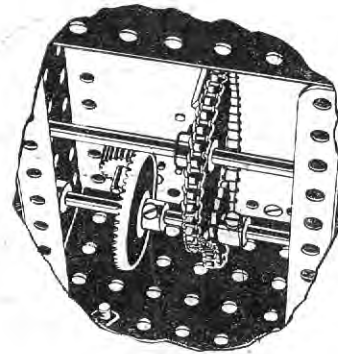
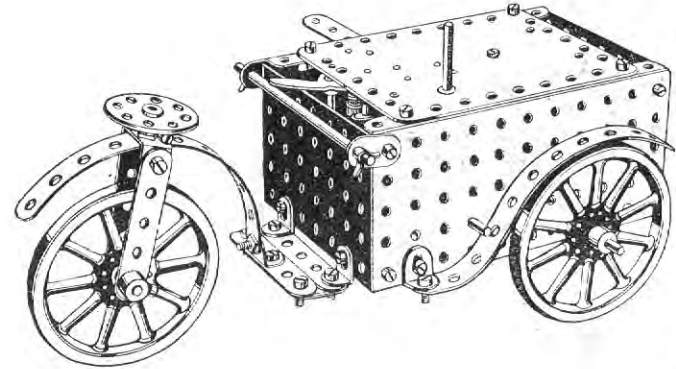
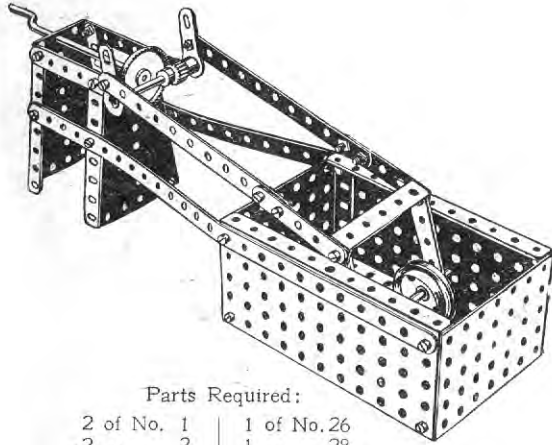

Fig. 227A

Parts Required :

3 of No. 2	1 of No. 28
4 " " 5	2 " " 35
4 " " 10	27 " " 37
1 " " 11	2 " " 52
5 " " 12	2 " " 53
1 " " 15	6 " " 59
1 " " 15A	9 " " 94
1 " " 18	1 " " 95
1 " " 24	1 " " 96
1 " " 26	

Model No. 228 Chocolate Mixer



Parts Required:

2 of No. 1	1 of No. 26
2 " " 2	1 " " 28
2 " " 3	24 " " 37
4 " " 5	2 " " 52
1 " " 16	2 " " 53
1 " " 17	2 " " 54
1 " " 19	1 " " 60
2 " " 20	2 " " 62

Model No. 229 Hay Elevator

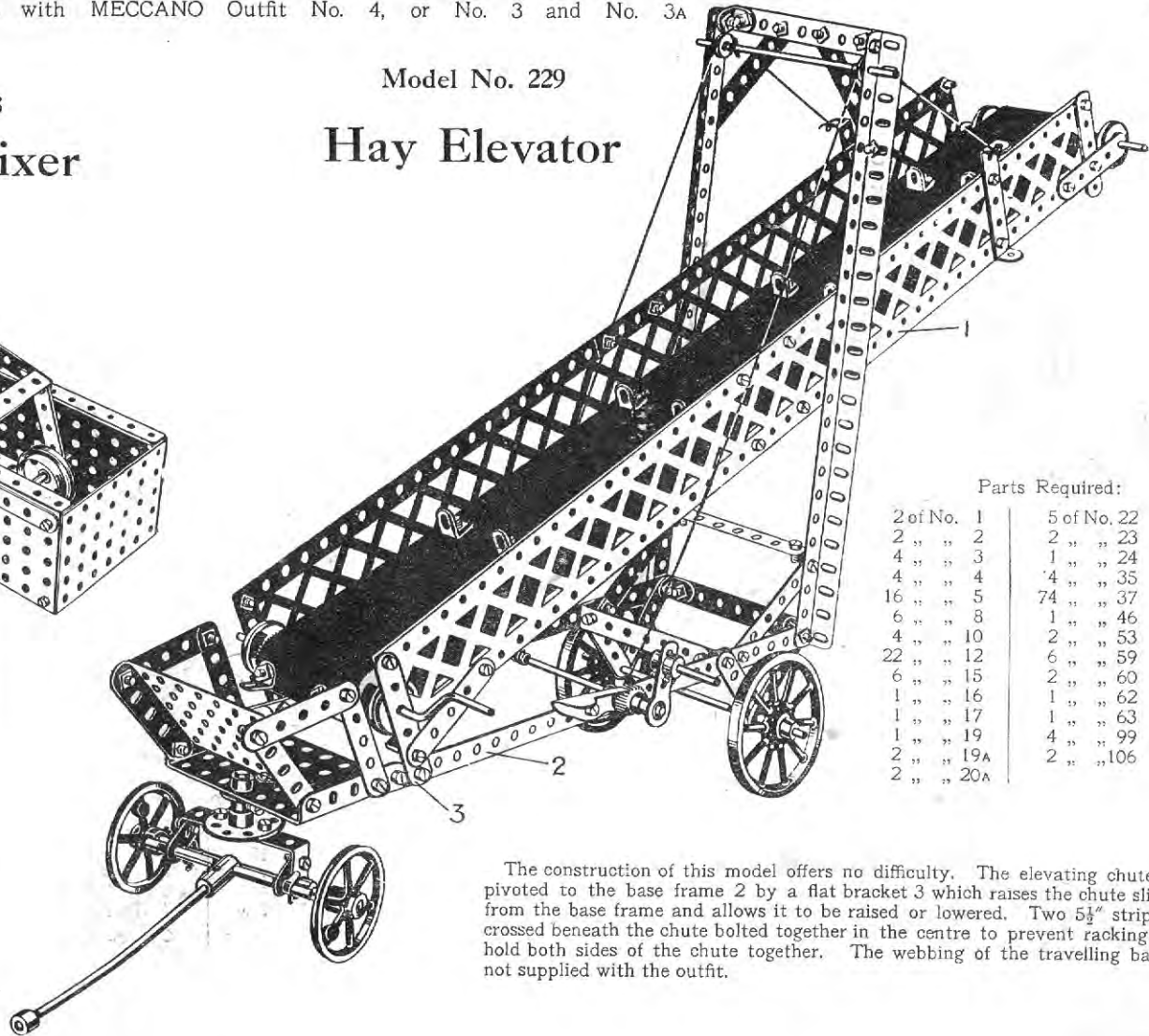

Parts Required:

2 of No. 1	5 of No. 22
2 " " 2	2 " " 23
4 " " 3	1 " " 24
4 " " 4	4 " " 35
16 " " 5	74 " " 37
6 " " 8	1 " " 46
4 " " 10	2 " " 53
22 " " 12	6 " " 59
6 " " 15	2 " " 60
1 " " 16	1 " " 62
1 " " 17	1 " " 63
1 " " 19	4 " " 99
2 " " 19A	2 " " 106
2 " " 20A	

The construction of this model offers no difficulty. The elevating chute 1 is pivoted to the base frame 2 by a flat bracket 3 which raises the chute slightly from the base frame and allows it to be raised or lowered. Two $5\frac{1}{2}$ " strips are crossed beneath the chute bolted together in the centre to prevent racking, and hold both sides of the chute together. The webbing of the travelling band is not supplied with the outfit.

Model No. 230 Mixing Machine

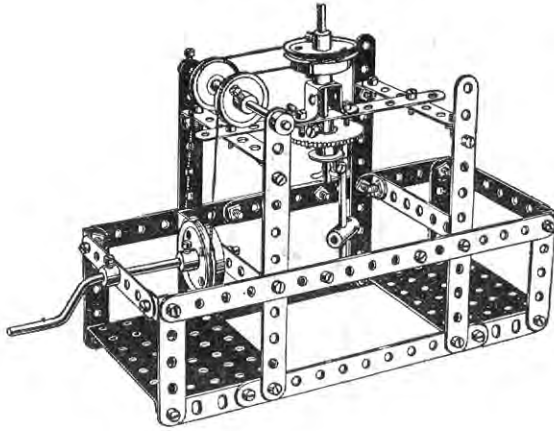

Parts
Required :

- 11 of No. 2
- 6 " " 3
- 4 " " 5
- 12 " " 12
- 1 " " 15A
- 2 " " 16
- 1 " " 19
- 2 " " 20
- 2 " " 22
- 1 " " 26
- 1 " " 27
- 43 " " 37
- 1 " " 45
- 2 " " 53
- 3 " " 59
- 2 " " 62
- 2 " " 63

Model No. 231 Distance Indicator

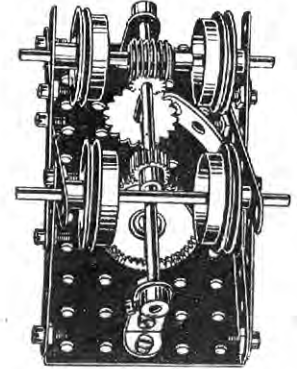
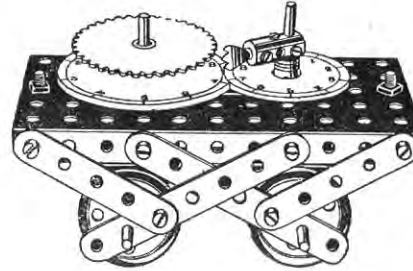
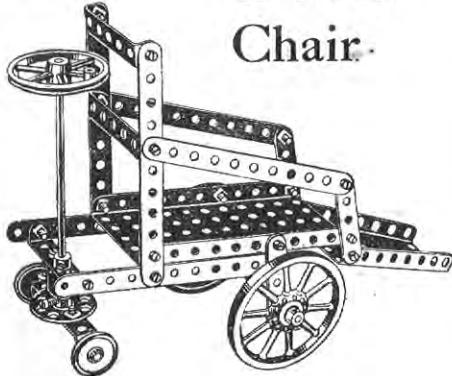

Fig. 231A

Parts Required :

- | | | | |
|------------|-------------|-------------|-------------|
| 4 of No. 3 | 1 of No. 15 | 1 of No. 32 | 1 of No. 63 |
| 1 " " 4 | 2 " " 16 | 19 " " 37' | 1 " " 65 |
| 4 " " 5 | 4 " " 20 | 1 " " 52 | 1 " " 95 |
| 2 " " 10 | 2 " " 26 | 3 " " 59 | 1 " " 96 |
| 2 " " 12 | 1 " " 28 | 2 " " 62 | |

Model No. 232 Invalid Chair



Parts
Required :

- 6 of No. 2
- 4 " " 5
- 2 " " 15A
- 1 " " 16
- 2 " " 19A
- 1 " " 20A
- 2 " " 22
- 1 " " 24
- 2 " " 37
- 24 " " 37
- 1 " " 46
- 1 " " 52
- 1 " " 54
- 1 " " 59
- 4 " " 60

Model No. 233 Bed Table

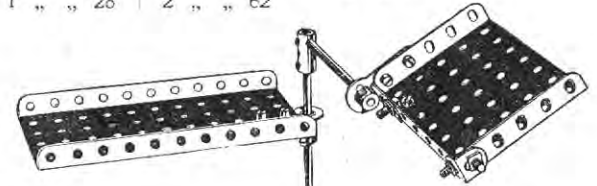

Parts Required :

- | | |
|------------|-------------|
| 1 of No. 3 | 1 of No. 52 |
| 2 " " 12 | 1 " " 53 |
| 1 " " 14 | 1 " " 59 |
| 2 " " 15A | 2 " " 62 |
| 1 " " 16 | 6 " " 63 |
| 8 " " 37 | |

Model No. 234

Treadle Hammer

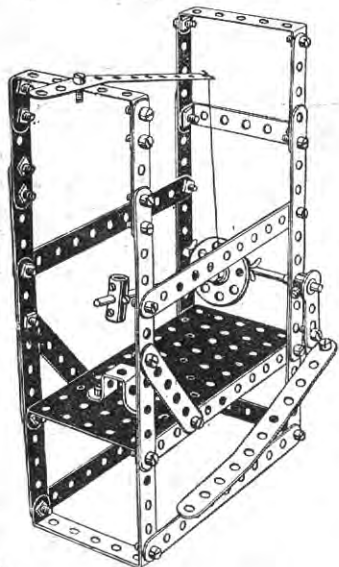

Parts Required:

14 of No.	2
2 " "	4
4 " "	5
1 " "	15
1 " "	16
1 " "	24
4 " "	35
29 " "	37
1 " "	45
1 " "	52
5 " "	60
1 " "	62
2 " "	63

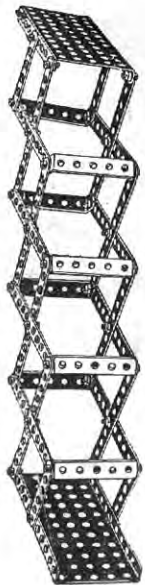

Model No. 235

Periscope

Parts Required:

16 of No.	2
4 " "	4
32 " "	37
2 " "	52
8 " "	60

Small pieces of looking glass should be inserted in the top and bottom plates.

Model No. 237

Plough

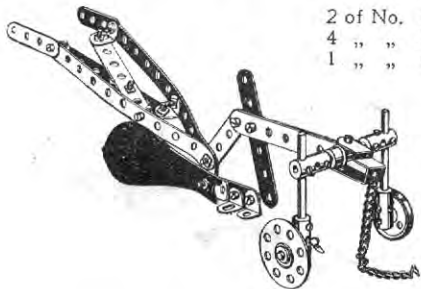

Parts Required:

2 of No.	2	1 of No.	5
4 " "	3	4 " "	6
1 " "	4	6 " "	12
		2 " "	17
		1 " "	18
		1 " "	22
		1 " "	24
		15 " "	37
		1 " "	41
		1 " "	44
		2 " "	59
		4 " "	63
		3 " "	94

Model No. 236

Automatic Gong

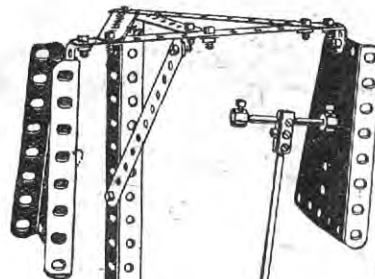

Parts Required:

5 of No.	2
1 " "	8
11 " "	12
1 " "	13
1 " "	15
1 " "	16
2 " "	17
3 " "	20
2 " "	35
29 " "	37
1 " "	45
1 " "	46
2 " "	52
2 " "	54
3 " "	59
1 " "	60
2 " "	63

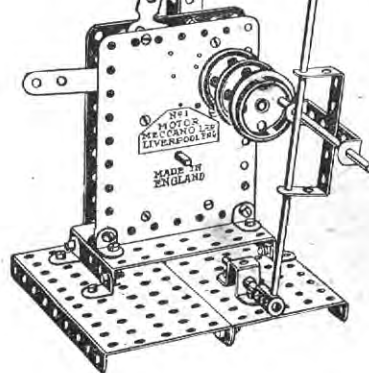

Model No. 238

Windmill Scare

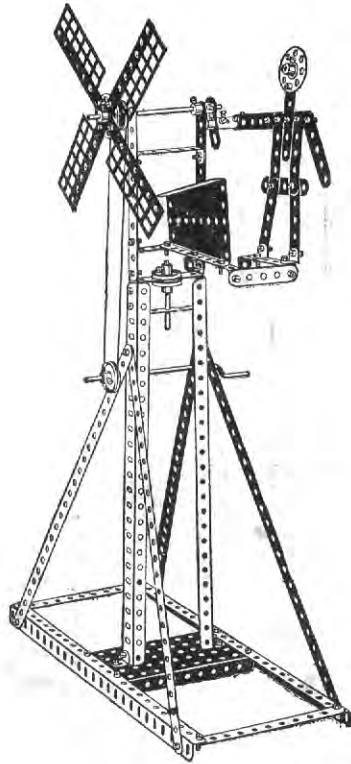

Parts
Required :

4 of No. 1
4 " " 2
10 " " 5
4 " " 8
4 " " 12
1 " " 15A
2 " " 17
1 " " 19
4 " " 22
2 " " 24
49 " " 37
1 " " 52
1 " " 54
4 " " 59
6 " " 60
4 " " 61
1 " " 62
1 " " 63

Model No. 239

Search-light Tower

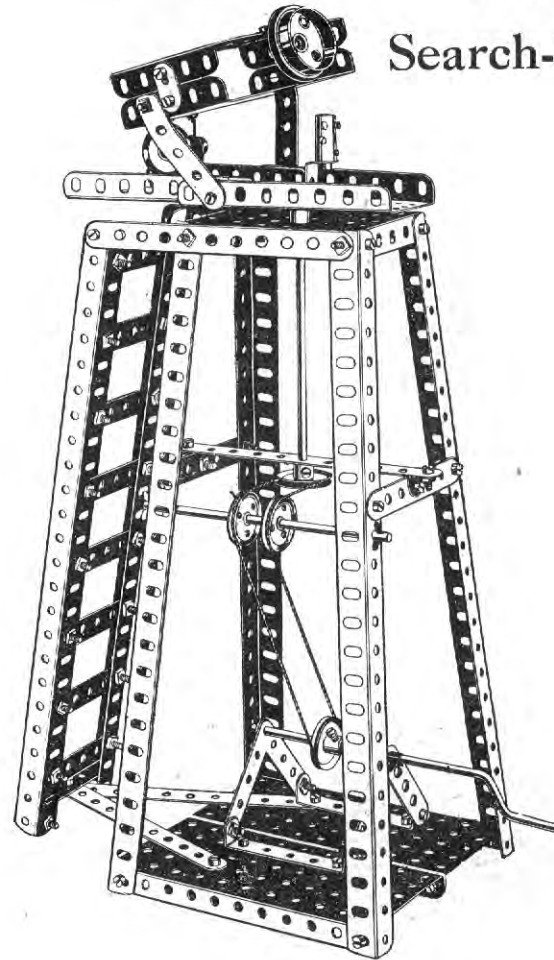

Parts
Required :

5 of No. 2
2 " " 3
15 " " 5
6 " " 8
2 " " 10
1 " " 11
4 " " 12
1 " " 14
1 " " 15
1 " " 18
1 " " 19
1 " " 20
3 " " 22
2 " " 22A
1 " " 24
4 " " 35
64 " " 37
1 " " 44
2 " " 52
2 " " 53
2 " " 54
1 " " 59
2 " " 60
1 " " 63

Model No. 240 Crane

Parts Required :

2 of No.	1
5 "	2
6 "	5
2 "	8
12 "	12
1 "	13
2 "	14
2 "	16
4 "	17
1 "	18
8 "	20
1 "	19 ^A
2 "	22
1 "	24
6 "	35
54 "	37
2 "	52
1 "	57
7 "	59
4 "	60
2 "	63
4 "	99
8 "	100

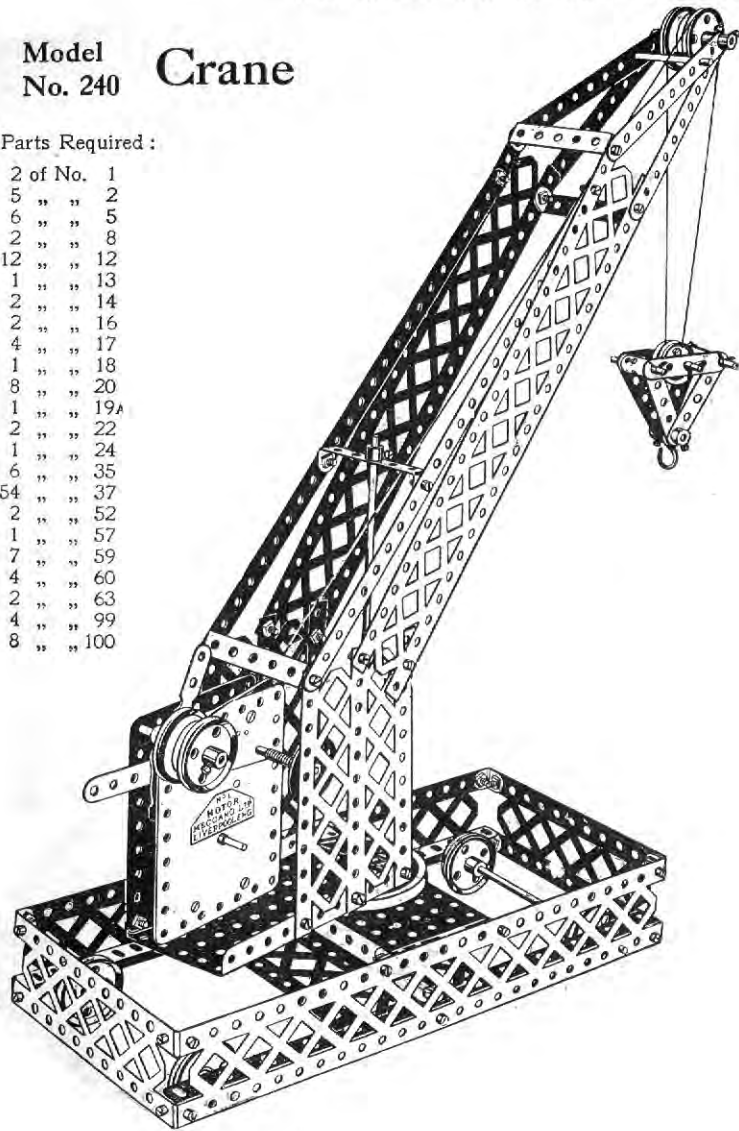

Model No. 241 Swing Saw

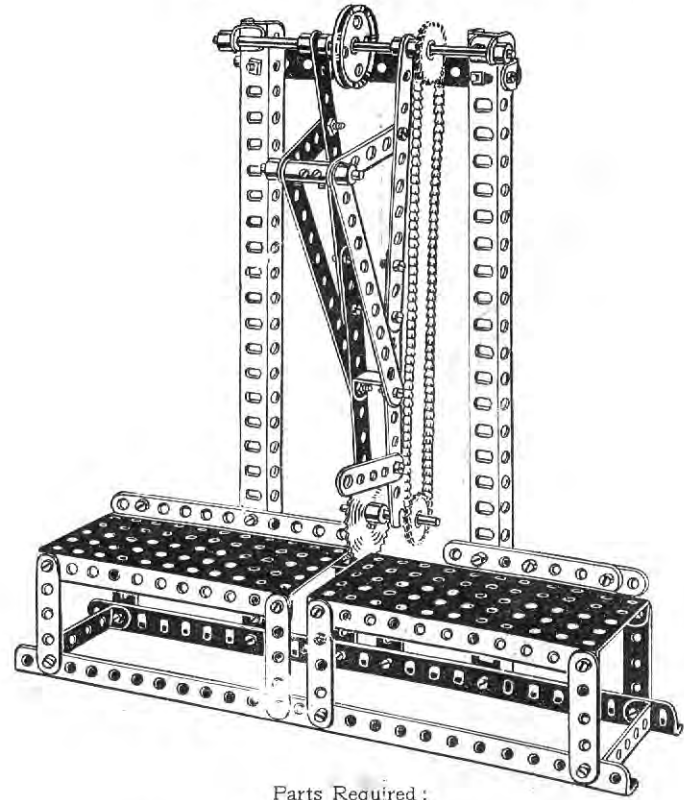

Parts Required :

8 of No.	2	4 of No.	12	8 of No.	59
1 "	3	1 "	14	2 "	60
12 "	5	2 "	17	1 "	63
6 "	8	1 "	21	1 "	94
1 "	10	45 "	37	1 "	95
1 "	11	2 "	52	2 "	96

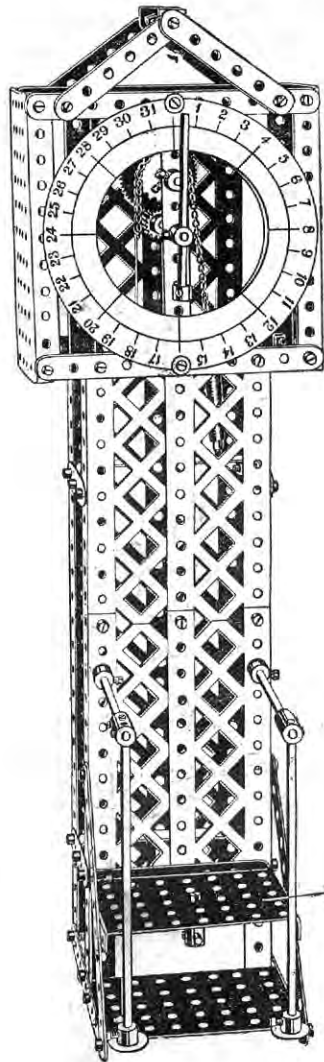

Model No. 242 Automatic Weighing Machine

Parts Required :

9 of No. 2	61 of No. 37
4 " " 3	6 " " 94
4 " " 4	1 " " 43
4 " " 5	2 " " 52
4 " " 8	2 " " 53
4 " " 12	6 " " 59
1 " " 13	1 " " 60
2 " " 15A	2 " " 62
4 " " 16	3 " " 63
1 " " 24	1 " " 96
1 " " 26	2 " " 99
1 " " 27	6 " " 100

The platform 1 is connected by cross rod and coupling 2A to a rod 2 passing up the centre of the machine and guided in $3\frac{1}{2}$ " strips 3 connected to side strips 4. At the upper end of this rod 2 is a bush wheel 5, to which is connected a cord 6 and chain 7 which passes round the sprocket wheel 8 on the spindle of which is a gear wheel 9 engaging a pinion 10 on the spindle 12 carrying the pointer 13. The other end of the chain is coupled by a spring 14 to the frame, and the pointer is thus always returned to zero.

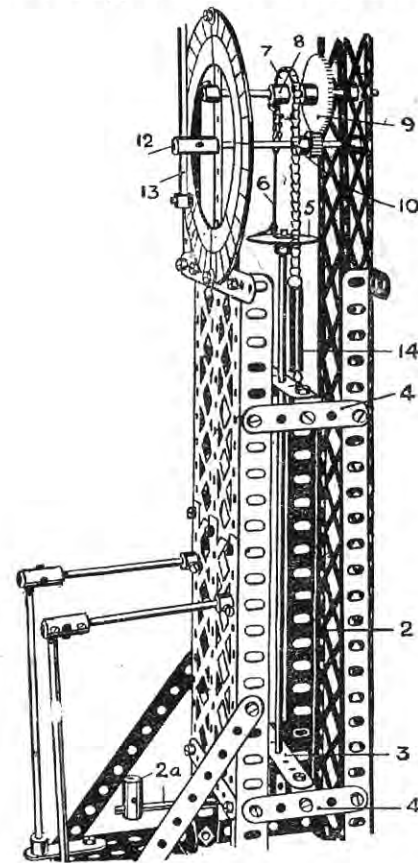
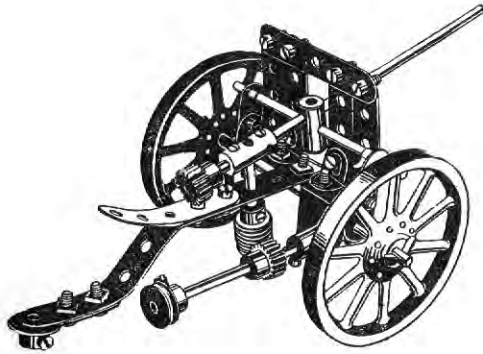

Fig. 242A.

Model No. 243
Field Gun



Parts Required :

1 of No. 2	2 of No. 16	17 of No. 37
7 " " 5	1 " " 17	1 " " 44
2 " " 10	2 " " 19A	2 " " 59
6 " " 12	1 " " 23A	1 " " 60
1 " " 14	2 " " 26	1 " " 62
1 " " 15	1 " " 32	2 " " 63.
	6 " " 35	

Model No. 244
Field Roller

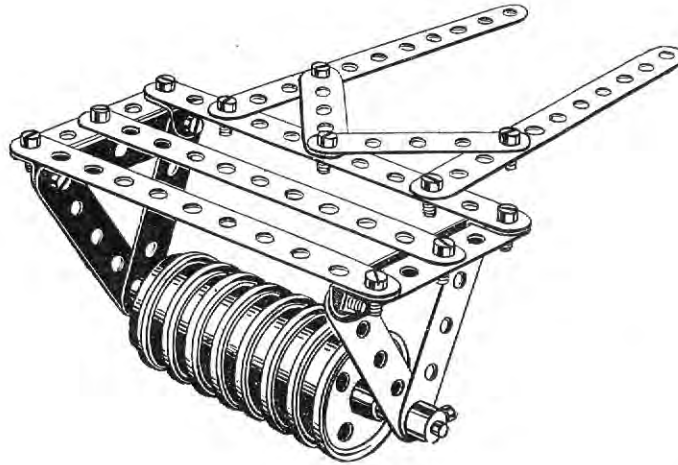

Parts Required :

5 of No. 2	8 of No. 20
10 " " 5	15 " " 37
4 " " 12	4 " " 59
1 " " 15	

Model No. 245
Potato Chopper

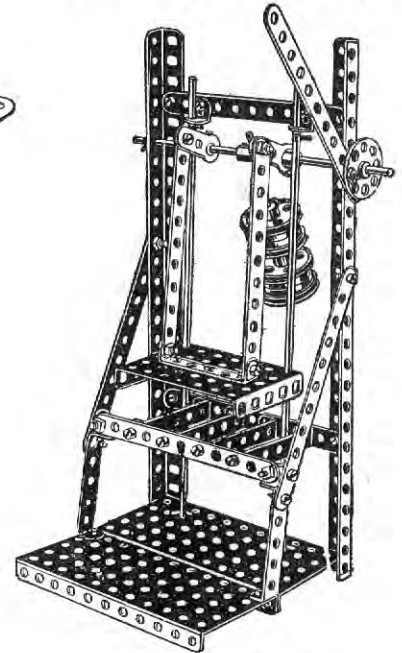

Parts Required :

8 of No. 2	2 of No. 16	2 of No. 52
2 " " 8	4 " " 20	1 " " 53
4 " " 12	1 " " 24	6 " " 60
2 " " 13	5 " " 35	1 " " 63
1 " " 15A	38 " " 37	

Model No. 246 Motor Car

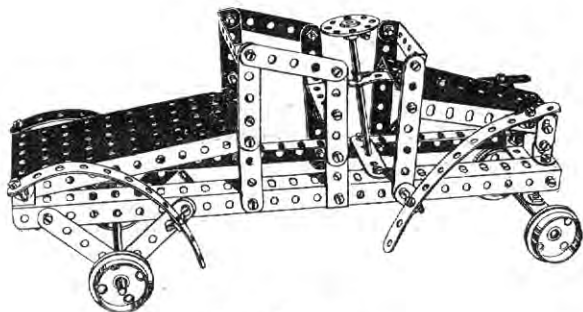

Parts Required:

5 of No. 2	1 of No. 15	55 of No. 37
2 " " 3	2 " " 15A	1 " " 45
14 " " 5	4 " " 20	1 " " 52
2 " " 8	1 " " 24	1 " " 54
2 " " 10	1 " " 35	6 " " 60
12 " " 12		1 " " 62

Model No. 247 Bridge

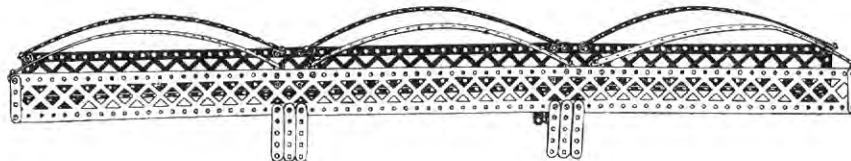

Parts Required:

6 of No. 1	12 of No. 12
16 " " 5	44 " " 37
6 " " 8	4 " " 53
	6 " " 99

HOW TO CONTINUE

This completes the Models which may be made with MECCANO Outfit No. 4. The next Models are a little more advanced, requiring a number of extra parts to construct them. The necessary parts are all contained in a No. 4a Accessory Outfit, the cost of which will be found in the Price List at the end of the Manual.

Model
No. 248 **Telpher Line**

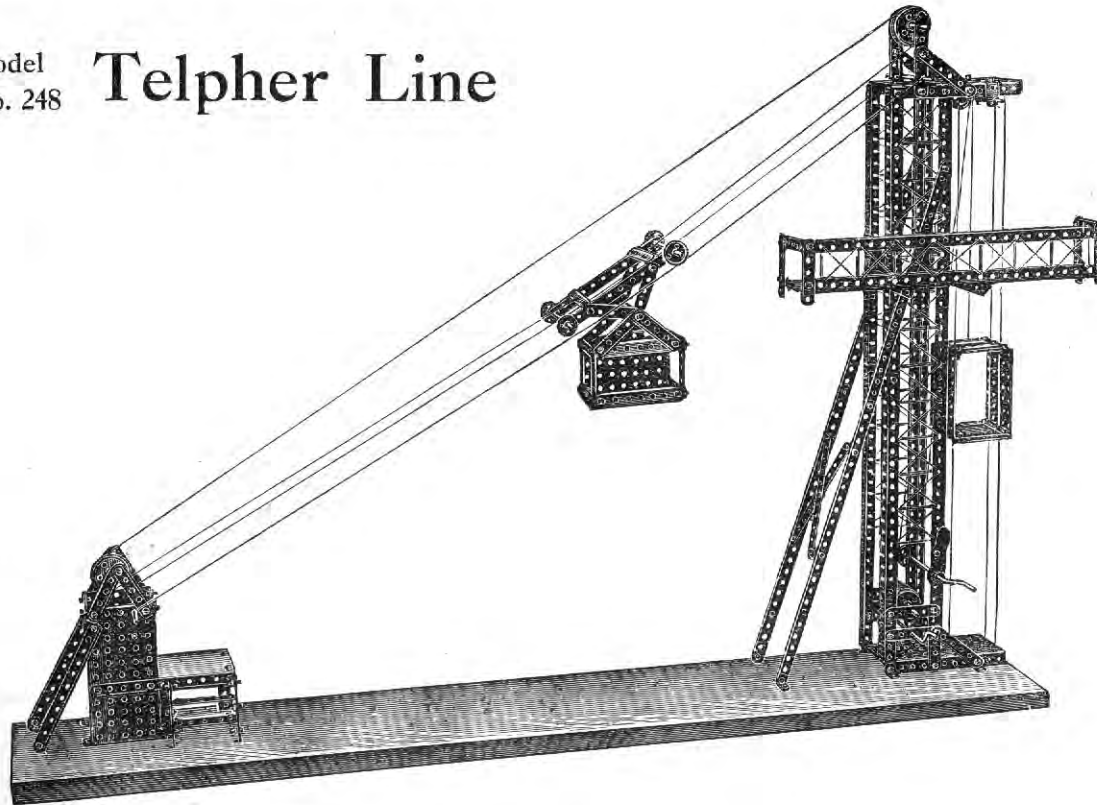

Parts
Required :

6 of No.	1
10 "	2
2 "	3
8 "	4
41 "	5
9 "	8
32 "	12
4 "	15
3 "	15A
2 "	16
2 "	19
4 "	20
2 "	21
4 "	22
2 "	22A
2 "	26
1 "	27
1 "	33
9 "	35
141 "	37
1 "	46
4 "	52
3 "	53
7 "	60

This figure represents a Telpher Line such as is used in hilly countries for transporting loads across intervening valleys. The travelling cage or bucket should be loosely pivoted from the roller cage, so that it may hang vertically when travelling down the inclined ropes. The drawing ropes should be wound once round the suspension pulleys of the bucket.

Model No. 249

Railroad Signals

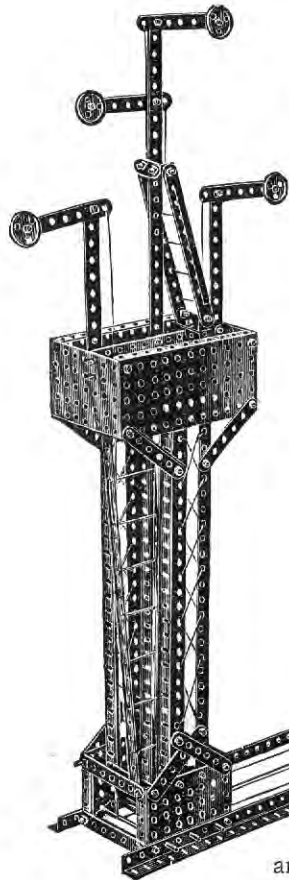

Parts
Required:

3 of No.	1
13 " "	2
16 " "	3
8 " "	4
8 " "	8
1 " "	11
31 " "	12
4 " "	15
4 " "	22
8 " "	35
137 " "	37
4 " "	52
5 " "	53

The gantry or upper signal box is made from two large and two small flanged plates carrying the signal standards. Guide pulleys are pivoted in the base box round which pass the operating cords for the signal arms to the hand levers, shown to the right.

Model No. 250

Revolving Aeroplane

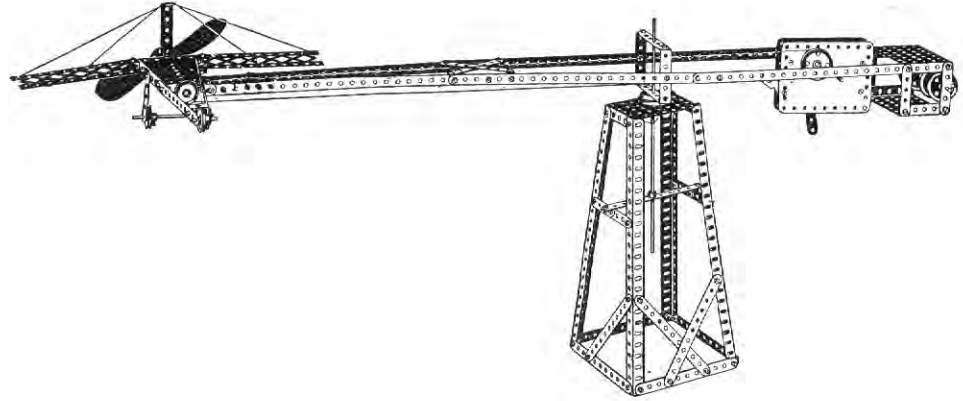

Parts Required:

6 of No.	1	1 of No.	15	1 of No.	24
11 " "	2	1 " "	15A	82 " "	37
6 " "	3	1 " "	16	2 " "	41
6 " "	5	1 " "	17	3 " "	53
4 " "	8	1 " "	18	1 " "	54
1 " "	11	5 " "	20	1 " "	59
14 " "	12	1 " "	21	3 " "	60
1 " "	13	4 " "	22		

Model No. 251 Extended Tip

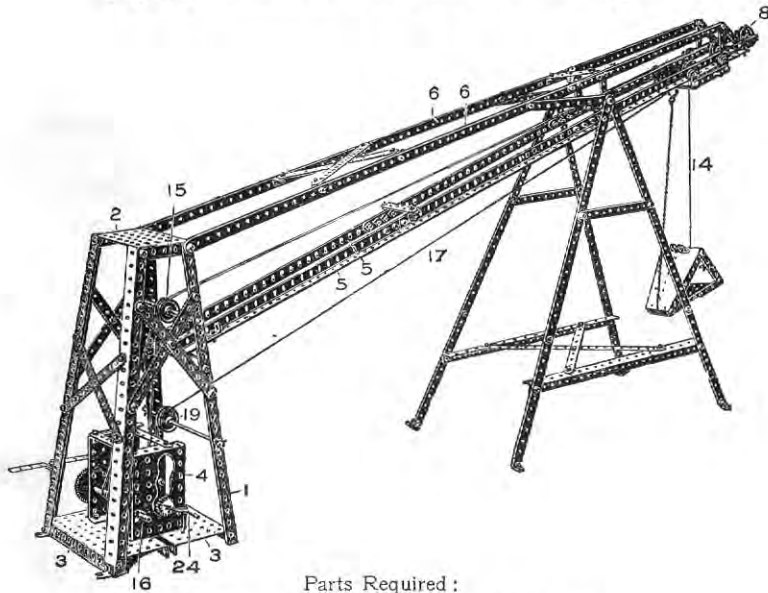

Parts Required :

14 of No. 1	2 of No. 16	15 of No. 35
17 " " 2	2 " " 17	148 " " 37
7 " " 3	1 " " 19	1 " " 94
2 " " 4	1 " " 21	1 " " 44
8 " " 5	4 " " 22	2 " " 46
6 " " 6	1 " " 22A	1 " " 50
12 " " 8	4 " " 23	2 " " 52
2 " " 11	2 " " 26	3 " " 53
26 " " 12	2 " " 27A	2 " " 54
2 " " 14	1 " " 33	3 " " 59
2 " " 15		

The main tower of the tip is made from four $12\frac{1}{2}$ " angle girders 1 bolted at the top to a small flanged plate 2 and at the bottom to two large plates 3 ; the side plates 4 of the gear box being bolted to the flanged base plates.

The jib (Fig. 251A) is made from sets of angle girders 5 butted together and coupled by strips, a pair of members being formed from $12\frac{1}{2}$ " strips strengthened by diagonal ties 7. To the ends of the angle girders 5 are bolted two $3\frac{1}{2}$ " strips to carry the $1\frac{1}{2}$ " pulley wheel 8, and the 1" pulley wheel 9 is carried on an axle passed through the third holes from the end of the angle girders.

The trolley (Fig. 251B) carrying the tip bucket is made from two large bent strips 10, in the upper ends of which are lock-nutted $\frac{1}{2}$ " pulley wheels, the bent ends of the strips being connected by 3" strips 11, in one of the central holes of which is the axle 12 carrying the pulley 13 for the operating cord 14 of the tip bucket. This cord passes round the inner end pulley 9 and back to one of the pulleys 15 and then to the winding shaft 16. The cord 17 for traversing the trolley along the rails is continuous, being given a complete turn round the spindle 18 (Fig. 251c) then round the pulley 19 to the trolley, and again from the trolley round the outer pulley 8 back over one of the pulleys 15 to the winding spindle 18.

The tip bucket, as will be seen from Fig. 251B, is made from two sector plates 20 bolted together at their lower edges, and coupled by $2\frac{1}{2}$ " strips at their upper ends ; the bucket is supported by a single bent strip 21 engaging the axle passed through the strips. A slack chain 22 connects the lower end of the tip bucket to a hook on the trolley, the chain passing between angle brackets 23.

Model No. 251

Extended Tip (continued)

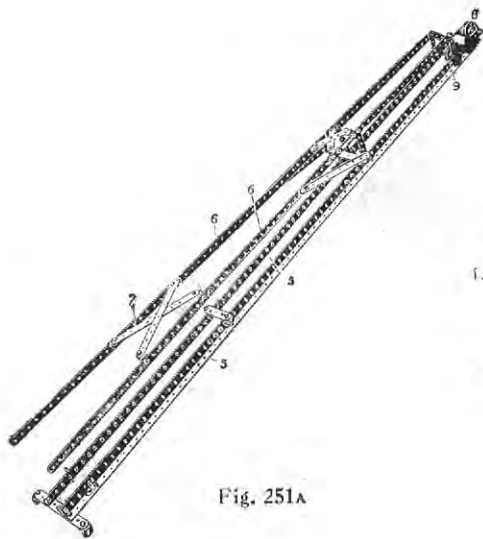

Fig. 251A

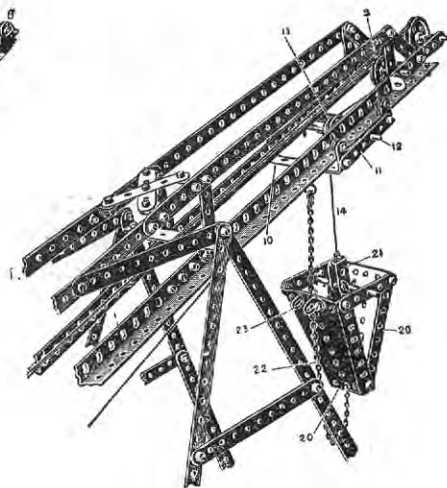

Fig. 251B

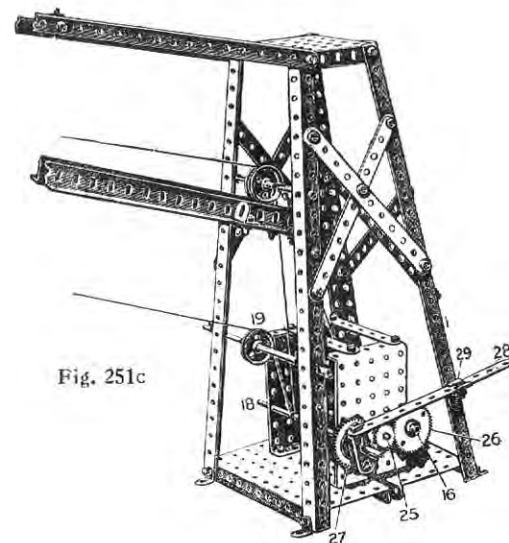

Fig. 251c

To tip the bucket, the cord 14 is lowered until the chain 22 becomes taut, further lowering of the cord 14 then allowing the bracket to swing over.

The cranked spindle 24 is provided at its opposite end with a pinion 25 which is permanently in gear with a $1\frac{1}{2}$ " gear wheel 26 on the spindle 16 controlling the hoisting cord 14. Another gear wheel 27 is mounted on the spindle 18 and is so controlled by the lever 28 that it may be thrown in or out of gear with the pinion 25. The lever 28 is supported in an eye piece 29 carried from the corner girder 1.

To cause the bucket trolley to traverse the rails without raising or lowering the bucket, the gear wheel 27 is engaged with the pinion 25, but to lift or lower the bucket, the gear wheel 27 is disengaged, the hoisting wheel 26 only being operated.

Model
No. 252 **Fret Saw**

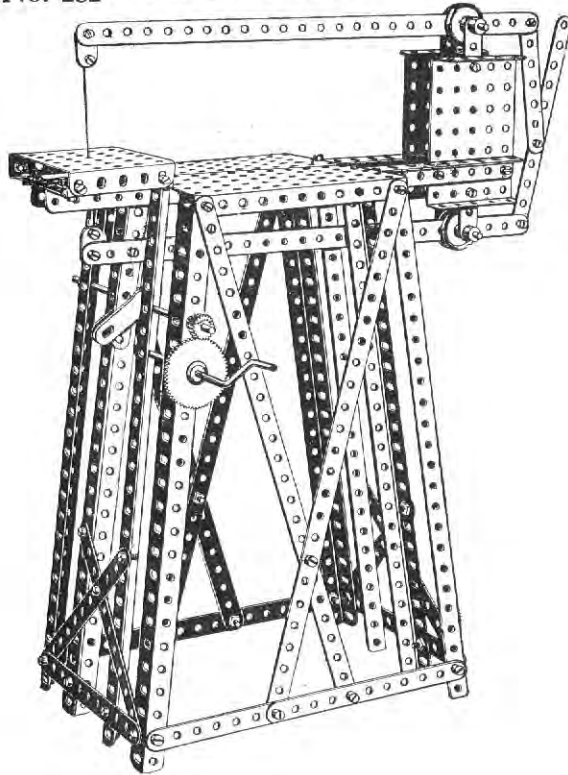

Parts Required :

8 of No. 1	10 of No. 8	1 of No. 19	2 of No. 52
13 " " 2	2 " " 10	4 " " 22	3 " " 53
1 " " 3	4 " " 12	1 " " 26	6 " " 59
2 " " 4	2 " " 16	1 " " 27A	2 " " 62
1 " " 5	2 " " 17	65 " " 37	

Model
No. 253 **Printing Machine**

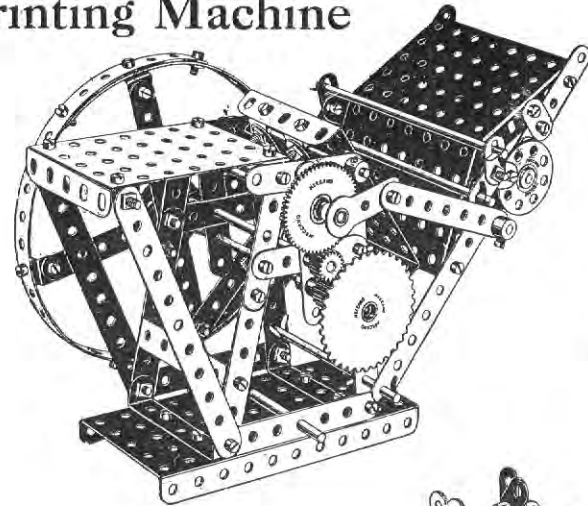

Parts Required :

2 of No. 1	
9 " " 2	
10 " " 3	
2 " " 4	
9 " " 5	
10 " " 10	
12 " " 12	
1 " " 14	
4 " " 15	
3 " " 15A	
2 " " 16	
1 " " 21	
2 " " 24	
2 " " 26	
1 " " 27A	
12 " " 35	
73 " " 37	
1 " " 52	
4 " " 53	
6 " " 59	
4 " " 60	

Model
No. 254

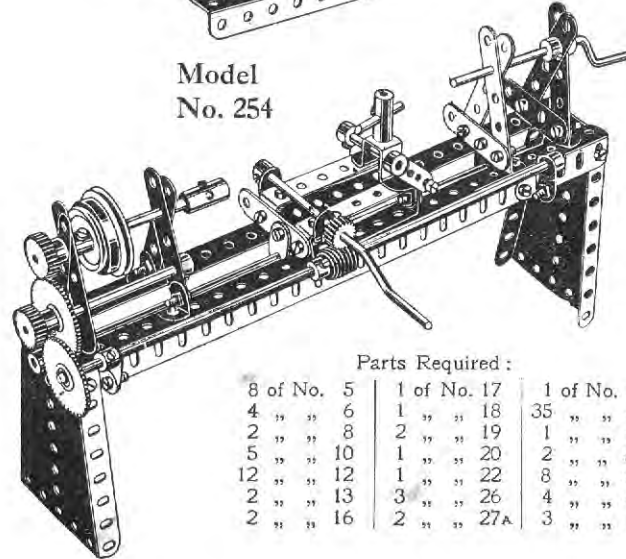

Screw-Cutting Lathe

Parts Required :

8 of No. 5	1 of No. 17	1 of No. 32
4 " " 6	1 " " 18	35 " " 37
2 " " 8	2 " " 19	1 " " 45
5 " " 10	1 " " 20	2 " " 54
12 " " 12	1 " " 22	8 " " 59
2 " " 13	3 " " 26	4 " " 60
2 " " 16	2 " " 27A	3 " " 63

Model
No. 255

Drop Hammer

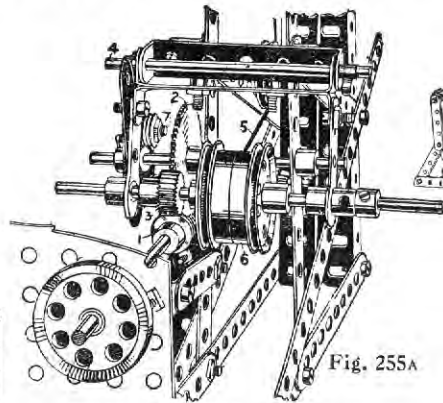
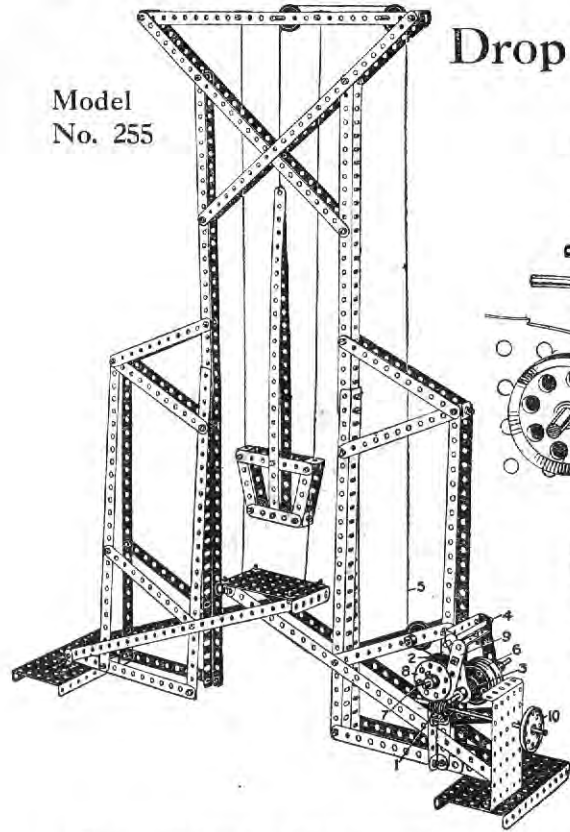

Fig. 255A

Parts Required :

14 of No.	1	1 of No.	21
16 " "	2	3 " "	22
2 " "	3	1 " "	24
1 " "	4	1 " "	26
11 " "	5	1 " "	27A
8 " "	8	1 " "	32
8 " "	11	90 " "	37
17 " "	12	2 " "	52
1 " "	15	2 " "	53
1 " "	15A	6 " "	59
2 " "	16	2 " "	60
3 " "	17	2 " "	62
2 " "	20		

The worm 1 on the driving spindle engages and rotates the gear wheel 2, which drives the pinion 3 on a spindle carried in crank bearings bolted to reversed $2\frac{1}{2}$ " bent strips, which hang from an upper rod 4. The winding rope 5 passing round the wheels 6 keeps the pinion in gear with the gear wheel 2 when raising the hammer. A $\frac{1}{2}$ " pulley 7 bolted to the bush wheel 8 eventually engages a strip 9 carried from the crank piece, and, by swinging the latter out, disengages the pinion 3 from the gear wheel 2, releasing the wheels 6 and permitting the rope to unwind and the hammer to drop. The driving pulley 10 must be driven anti-clockwise.

Model No. 256

Giant Auto Swing

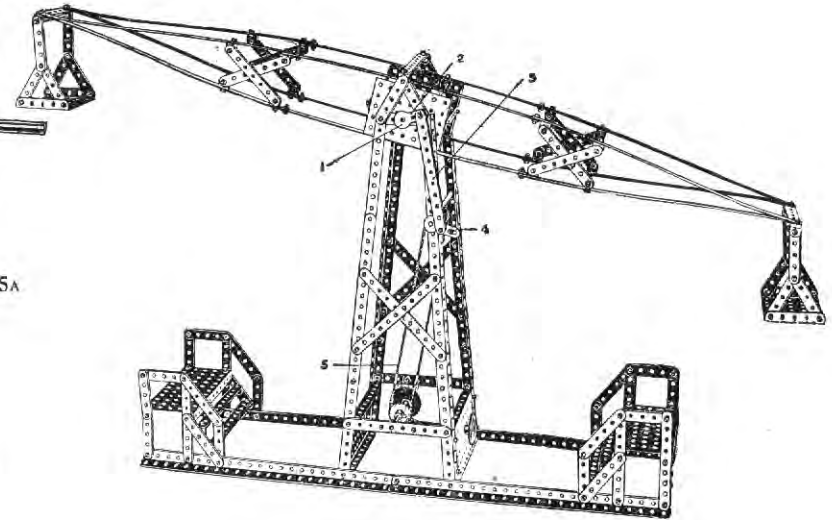

Parts Required :

The spindle 1 of the swing frame is fitted with a crank 2 connected by a strip 3 to another crank 4, the spindle of which is journaled in the vertical supports and carries a sprocket wheel driven by the chain 5.

12 of No.	1	1 of No.	21
10 " "	2	1 " "	24
12 " "	3	1 " "	27
8 " "	4	1 " "	32
42 " "	5	4 " "	35
12 " "	8	166 " "	37
46 " "	12	4 " "	52
2 " "	14	4 " "	53
2 " "	15	5 " "	59
2 " "	15A	2 " "	62

Model No. 257 Mowing and Reaping Machine

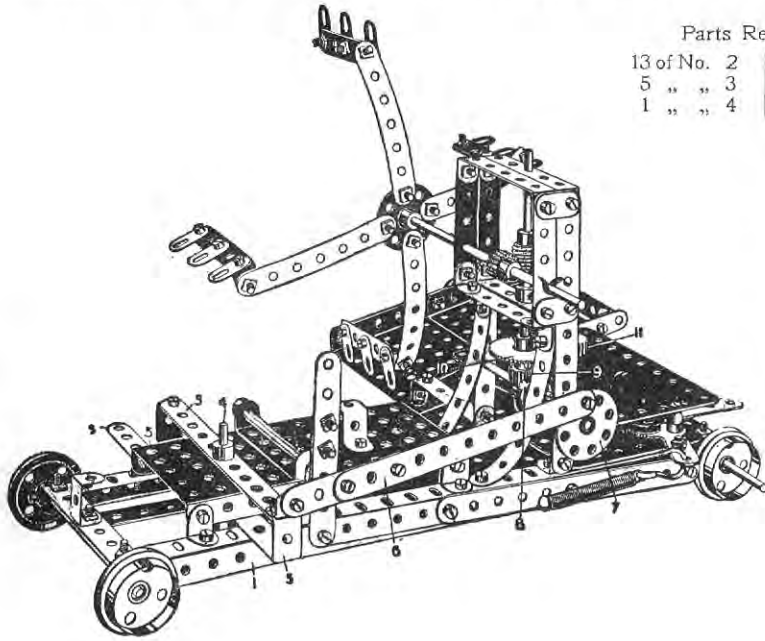

Parts Required :

13 of No. 2	8 of No. 5
5 " " 3	2 " " 8
1 " " 4	16 " " 10
	4 " " 11
	15 " " 12
	1 " " 13
	7 " " 14
	3 " " 15
	2 " " 16
	1 " " 17
	1 " " 18
	4 " " 20
	1 " " 22
	2 " " 24
	3 " " 26
	1 " " 27
	1 " " 29
	1 " " 32
100 " " 37	
1 " " 45	
2 " " 52	
3 " " 53	
7 " " 59	
5 " " 60	
1 " " 62	

Model No. 258 Spooling Machine

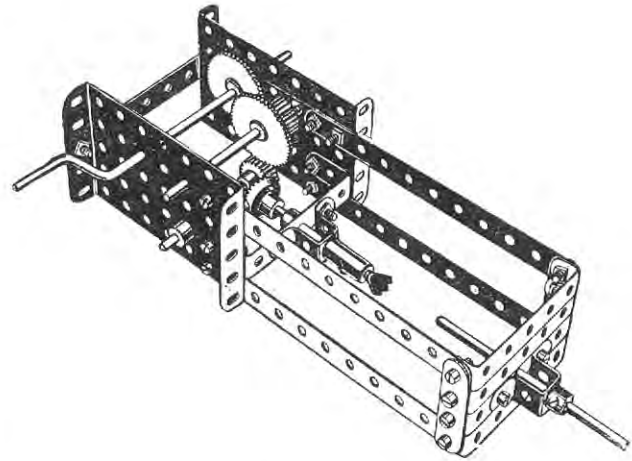

Parts Required :

4 of No. 2	2 of No. 27	1 of No. 46
1 " " 3	1 " " 29	2 " " 53
3 " " 16	26 " " 37	7 " " 59
1 " " 17	2 " " 45	4 " " 60
1 " " 19		1 " " 63
2 " " 26		1 " " 65

Begin by building the base frame 1 from angle girders bolted to flanged plates 2, a flanged perforated plate 3 being also bolted by angle brackets on the top of frame 1. This forms the bearing for a short rod 4 which is the pivot of the cutter 5, which is oscillated by the strips 6 which form a connecting rod operated by the bush wheel 7. The spindle of this wheel is driven by a contrate wheel 8 from the pinion 9, which is on the same spindle as the gear wheel 10 driven by two pinions 11 on the driving spindle of the motor.

Model No. 259

Measuring Machine

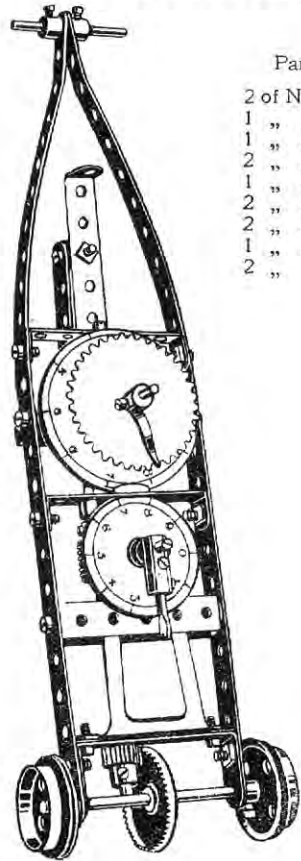

Parts Required:

2 of No. 1		1 of No. 28	
1	"	1	"
1	"	16	"
2	"	2	"
1	"	4	"
2	"	5	"
2	"	1	"
2	"	1	"
1	"	1	"
2	"	1	"

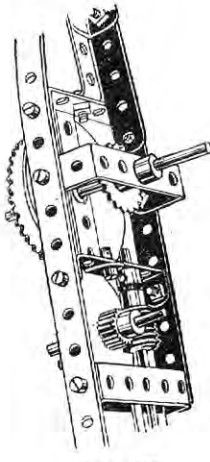
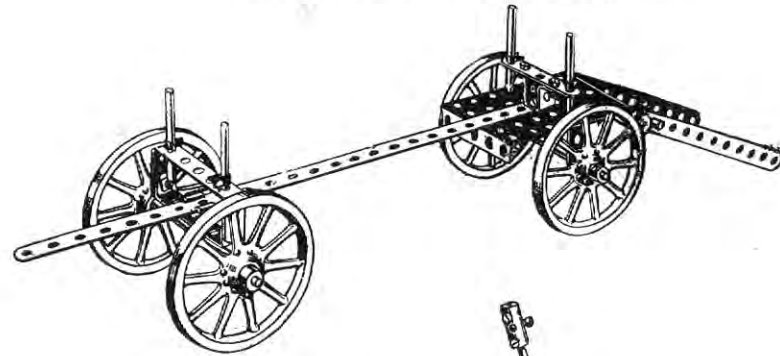

Fig. 259A

Model No. 260

Timber Carriage



Parts Required:	
1	of No. 1
2	" " 2
1	" " 5
2	" " 15A
1	" " 16
4	" " 17
1	" " 18
4	" " 19A
8	" " 35
10	" " 37
1	" " 45
2	" " 46
1	" " 50
1	" " 53
4	" " 59
3	" " 60

Carpet

Sweeper

Model No. 261

Parts Required:

6 of No. 3		1 of No. 26	
2	"	2	"
8	"	14	"
1	"	2	"
2	"	3	"
2	"	2	"
4	"	2	"
2	"		

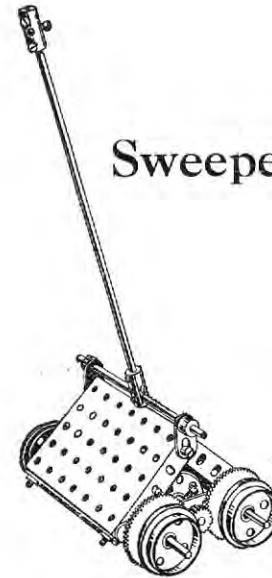

Model No. 262 Bob Sleigh

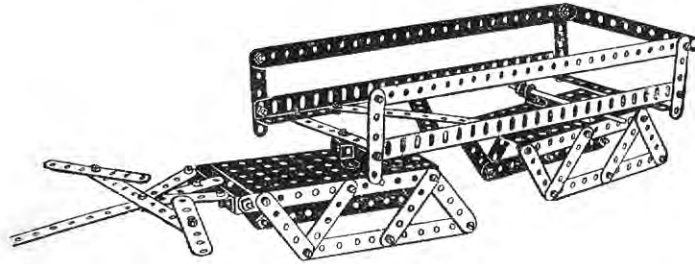

Parts
Required:

3 of No.	1
10 "	2
4 "	3
22 "	5
2 "	8
7 "	12
1 "	15A
60 "	37
2 "	45
2 "	52
2 "	59
2 "	60

Model No. 263 Hand Car

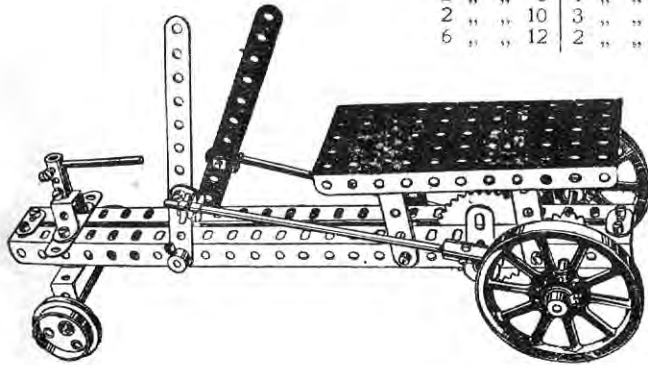

Parts Required:

2 of No. 2	2 of No. 14	2 of No. 20
5 " " 5	1 " " 15	1 " " 24
2 " " 8	1 " " 15A	4 " " 35
2 " " 10	3 " " 17	26 " " 37
6 " " 12	2 " " 19A	1 " " 45
		1 " " 46
		1 " " 52
		6 " " 59
		2 " " 62
		3 " " 63
		1 " " 95
		1 " " 96

Model No. 264 Ladder

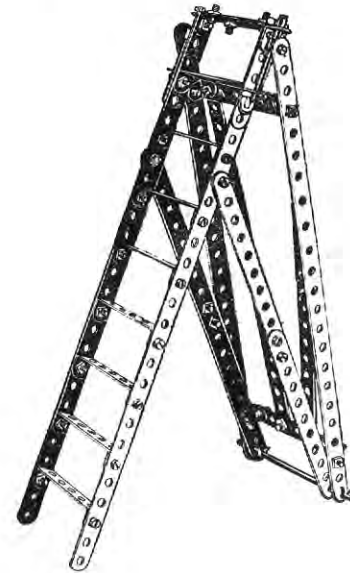

Parts Required:

4 of No. 1	1 of No. 16
8 " " 2	2 " " 17
2 " " 3	10 " " 35
3 " " 5	44 " " 37
2 " " 10	2 " " 59
8 " " 12	9 " " 60

Model No. 265 Distance Indicator

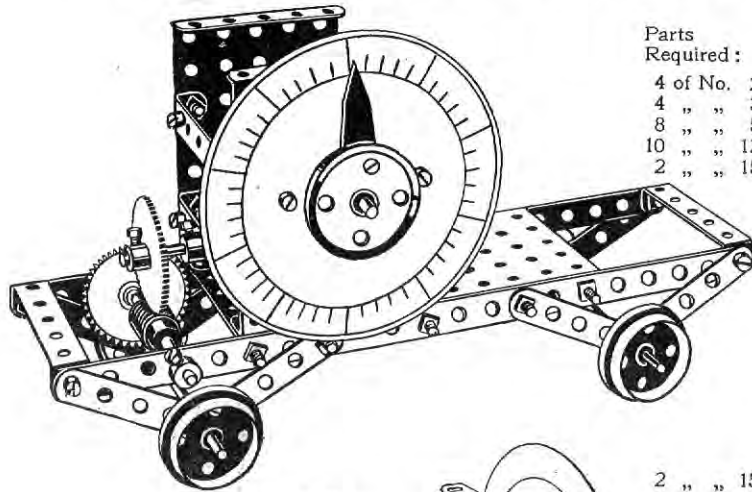

Parts
Required:

- 4 of No. 2
- 4 " " 3
- 8 " " 5
- 10 " " 12
- 2 " " 15

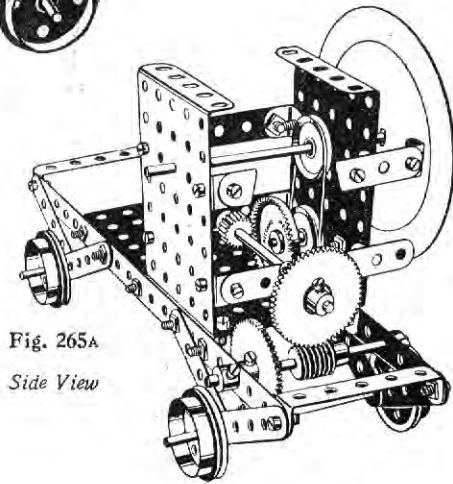

Fig. 265A

Side View

- 2 " " 15A
- 1 " " 16
- 1 " " 17
- 4 " " 20
- 1 " " 21
- 2 " " 22
- 1 " " 24
- 2 " " 26
- 2 " " 27A
- 1 " " 28
- 1 " " 32
- 38 " " 37
- 1 " " 52
- 2 " " 53
- 6 " " 59
- 2 " " 60

Model No. 266 Belgian Water Wheel

- Parts Required:
- | | |
|-------------|-------------|
| 10 of No. 1 | 1 of No. 24 |
| 12 " " 2 | 3 " " 26 |
| 12 " " 5 | 1 " " 27A |
| 4 " " 8 | 82 " " 37 |
| 28 " " 12 | 2 " " 52 |
| 2 " " 15 | 2 " " 53 |
| 1 " " 15A | 4 " " 59 |
| 1 " " 16 | 5 " " 60 |
| 1 " " 21 | 1 " " 63 |

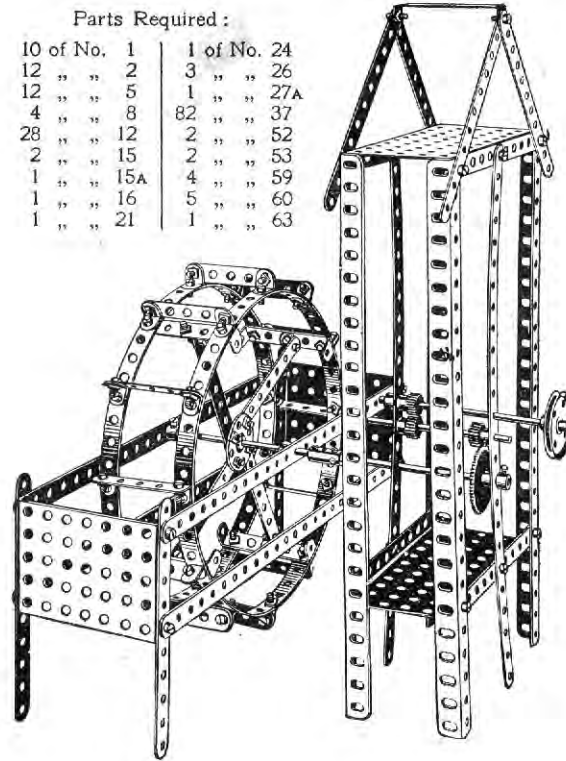

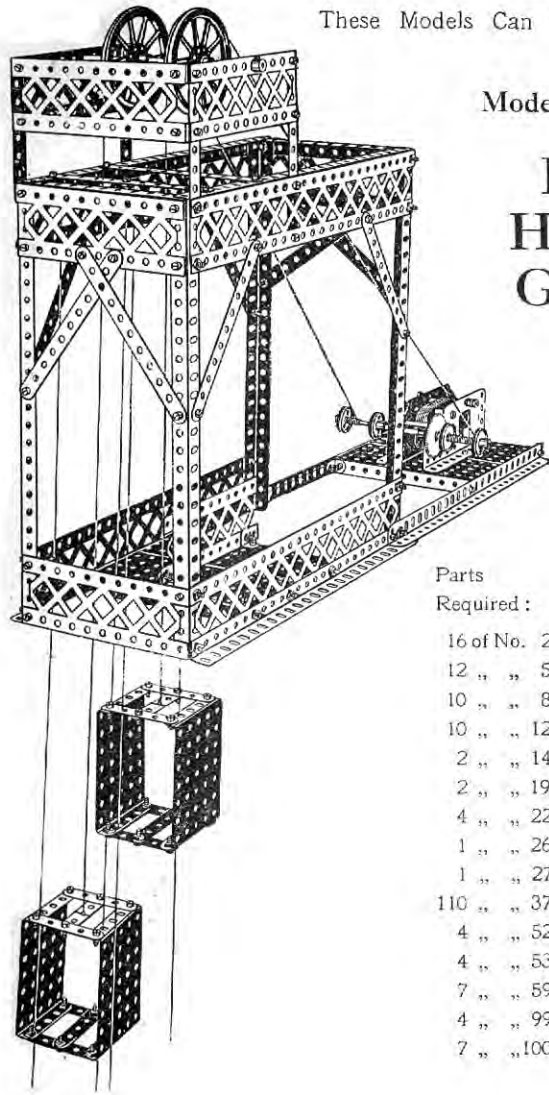

Model No. 267

Pit Head Gear

Parts
Required:

16 of No. 2
12 " " 5
10 " " 8
10 " " 12
2 " " 14
2 " " 19A
4 " " 22
1 " " 26
1 " " 27
110 " " 37
4 " " 52
4 " " 53
7 " " 59
4 " " 99
7 " " 100

Model No. 268

Spring Scales

Parts
Required:

6 of No. 2
2 " " 4
2 " " 8
2 " " 10
3 " " 11
2 " " 15
1 " " 15A
2 " " 16
3 " " 17
1 " " 18
2 " " 26
2 " " 27
23 " " 37
1 " " 43
1 " " 52
1 " " 54
1 " " 57
2 " " 59
2 " " 60
2 " " 62
2 " " 63

The Scale beam 1 is made of two $5\frac{1}{2}$ " strips distanced by double bent strips. The vertical rod 2 is connected to the beam which is pivoted on the rod 3. The cranks 4 are gripped on an axle 5 on which is secured the gear wheel 6 actuating through a gear train the pointer 7. A spring 8 connected to a rod 5 and another rod in the end hole of the beam acts as the spring balance.

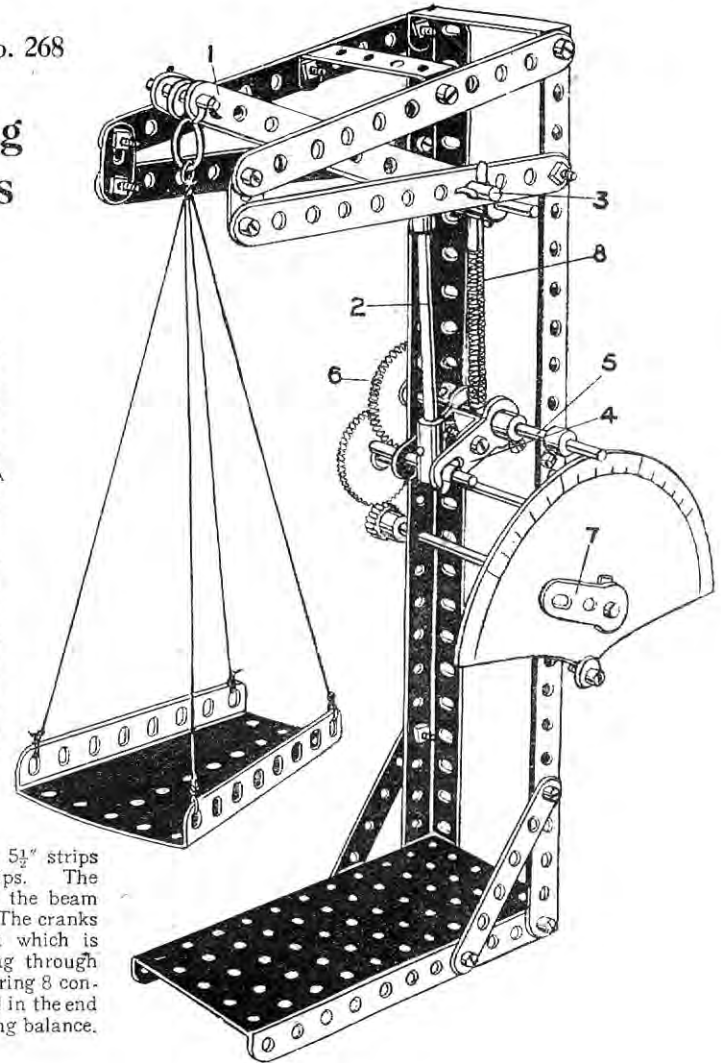

Model No. 269 Farm Tractor

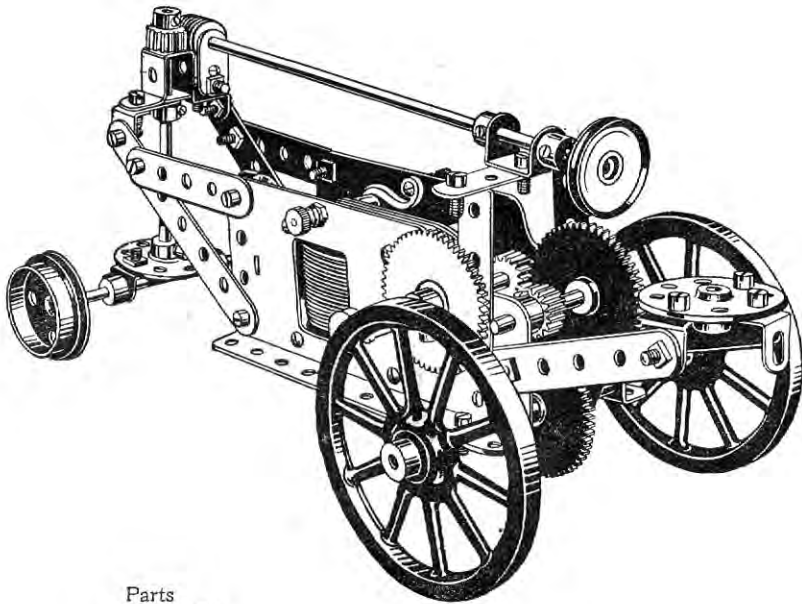

Parts
Required :

2 of No. 3		
5 " " 5		
3 " " 10		
1 " " 11		
7 " " 12	2 of No. 20	1 of No. 32
1 " " 13	1 " " 22	24 " " 37
1 " " 15	2 " " 24	1 " " 45
2 " " 15A	2 " " 26	8 " " 59
2 " " 19A	2 " " 27	2 " " 60

Model No. 270 Manure Distributing Cart

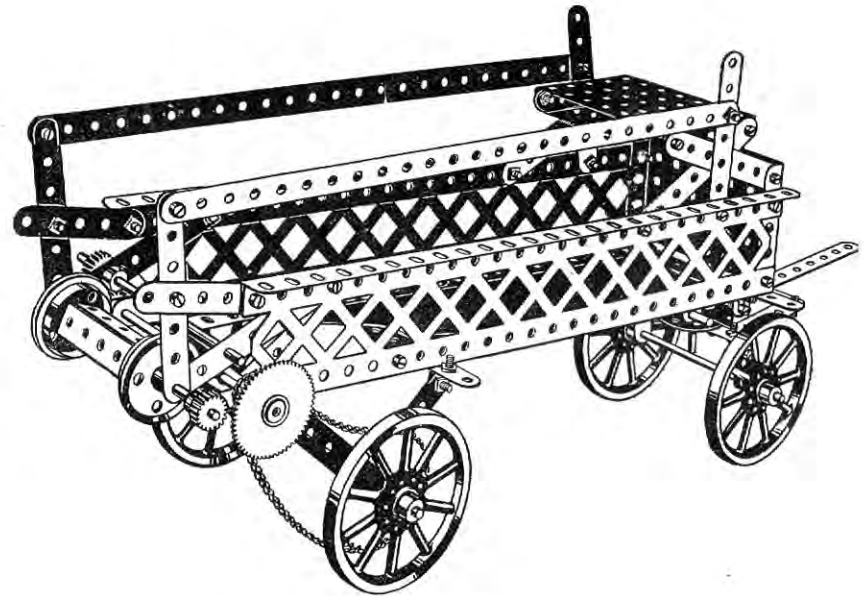

Parts Required :

2 of No. 1	2 of No. 15A	1 of No. 46
3 " " 2	2 " " 17	2 " " 53
10 " " 3	4 " " 19A	8 " " 59
9 " " 5	2 " " 20	4 " " 60
4 " " 8	1 " " 24	1 " " 94
6 " " 12	3 " " 26	1 " " 95
1 " " 14	1 " " 27A	1 " " 96
3 " " 15	4 " " 35	2 " " 99
	57 " " 37	

Model No. 271

Skein Winder

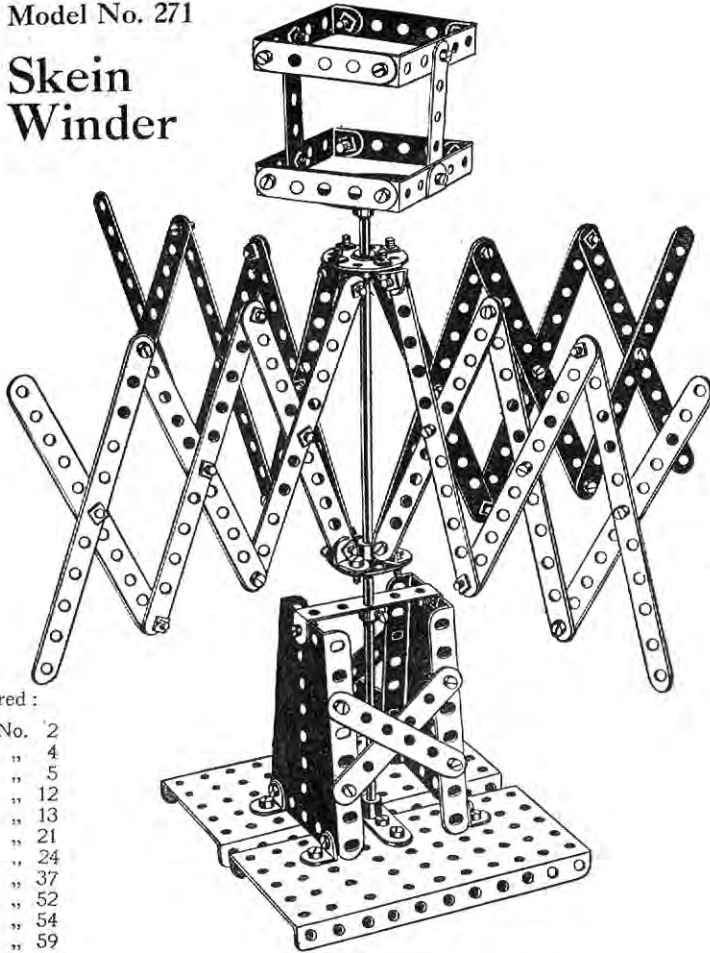

Parts
Required :

24 of No.	2
4 "	4
7 "	5
8 "	12
1 "	13
1 "	21
2 "	24
86 "	37
2 "	52
2 "	54
2 "	59
6 "	60

Model
No. 272 **Delivery Cart**

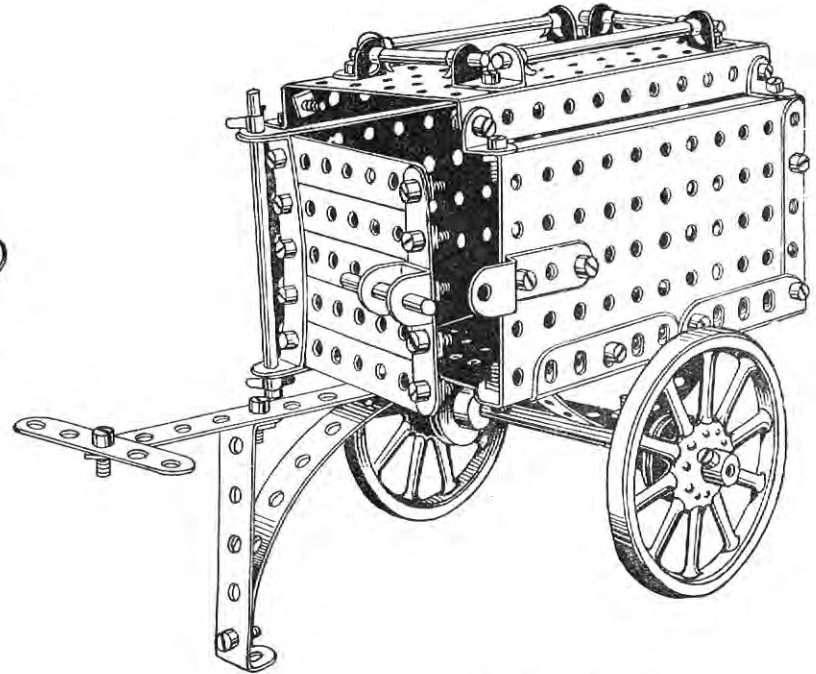

Parts Required :

4 of No. 2	1 of No. 11	3 of No. 17	3 of No. 52
5 " " 3	12 " " 12	2 " " 19A	3 " " 53
3 " " 5	1 " " 15	2 " " 22	2 " " 59
2 " " 10	3 " " 16	41 " " 37	2 " " 60

This Model Can be Made with MECCANO Outfit No. 5, or No. 4 and No. 4A

Model No. 273 Travelling Repair Tower

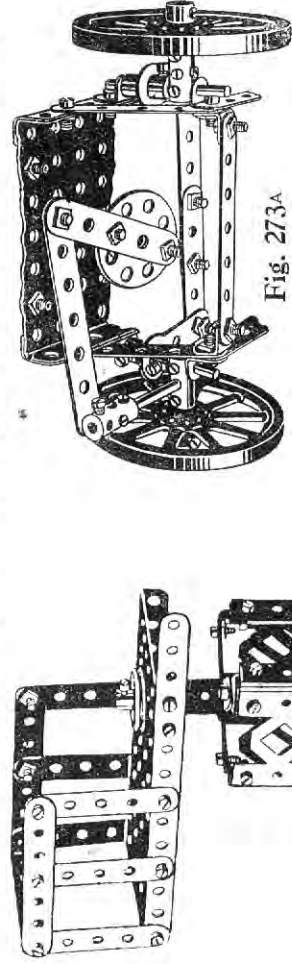
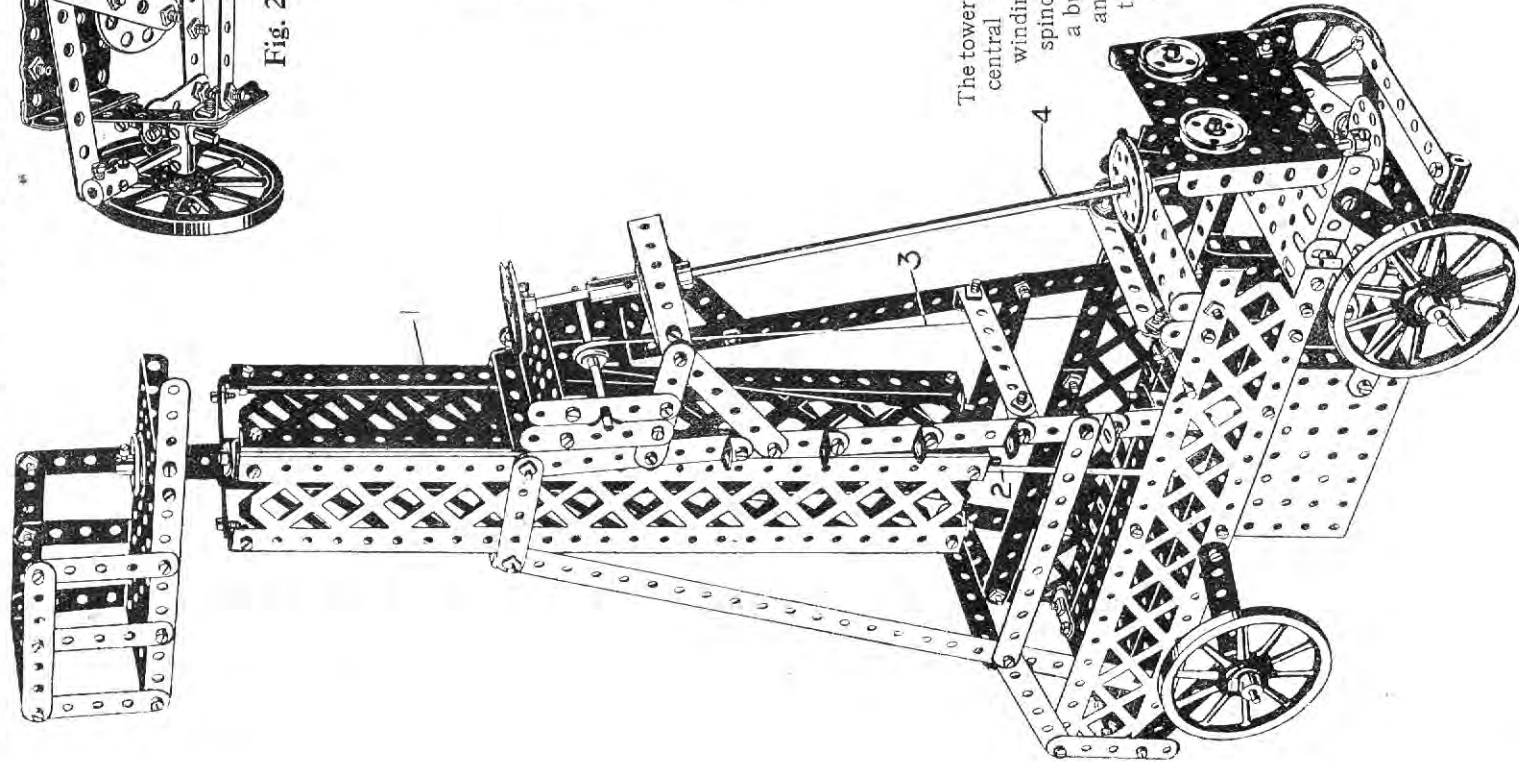

Fig. 273A

Parts Required:

4 of No.	1	2	3	4	5	8	10	12	13	15	16	17	18	19	19A	20	21	22
2 of No. 22A	1	1	23	2	2	2	2	2	2	2	4	8	7	2	5	4	4	100
	1	1	24	2	1	1	1	1	1	1	2	2	2	2	5	4	4	
	1	1	26	1	1	1	1	1	1	1	4	4	4	2	5	4	4	
	1	1	33	1	1	1	1	1	1	1	2	2	2	2	5	4	4	
	2	2	35	2	2	2	2	2	2	2	4	4	4	2	5	4	4	
	120	2	37	120	2	2	2	2	2	2	4	4	4	2	5	4	4	
	2	2	45	2	2	2	2	2	2	2	4	4	4	2	5	4	4	
	1	1	46	1	1	1	1	1	1	1	2	2	2	2	5	4	4	
	2	2	52	2	2	2	2	2	2	2	4	4	4	2	5	4	4	
	4	4	53	4	4	4	4	4	4	4	8	8	8	2	5	4	4	
	8	8	59	8	8	8	8	8	8	8	16	16	16	2	5	4	4	
	7	7	60	7	7	7	7	7	7	7	14	14	14	2	5	4	4	
	2	2	62	2	2	2	2	2	2	2	4	4	4	2	5	4	4	
	1	1	63	1	1	1	1	1	1	1	2	2	2	2	5	4	4	
	4	4	63	4	4	4	4	4	4	4	8	8	8	2	5	4	4	
	1	1	99	1	1	1	1	1	1	1	2	2	2	2	5	4	4	
	2	2	100	2	2	2	2	2	2	2	4	4	4	2	5	4	4	

The tower 1 is raised or lowered on the central axle rod 2 by the cord 3 winding on and off the cranked spindle 4. The rod 2 is secured in a bush wheel bolted to the rectangular base plate, and slides through a double bent strip secured at the bottom of the tower inside. The steering gear is shown in the detail view.



Model No. 274

Automatic Coin-Freed Machine

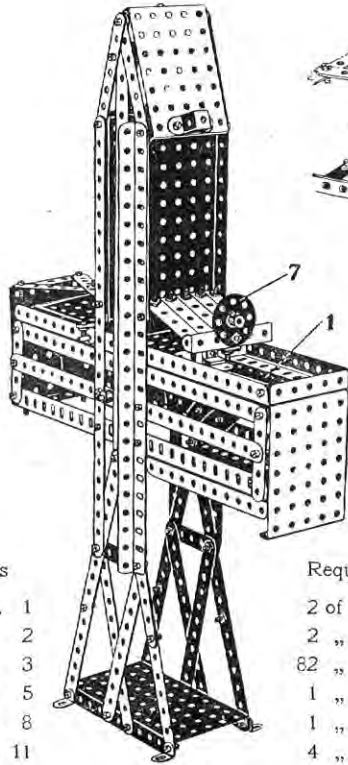

Parts	
6 of No.	1
17 " "	2
5 " "	3
21 " "	5
8 " "	8
3 " "	11
6 " "	12
2 " "	16
1 " "	20

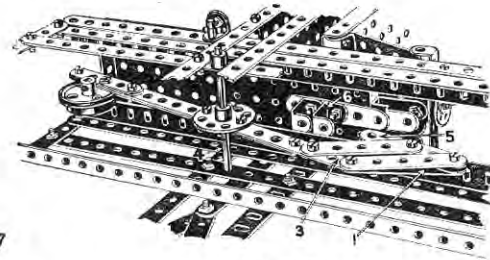
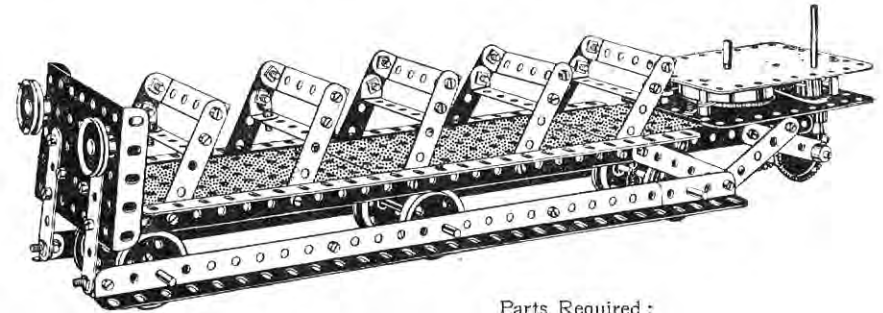

Fig. 274A

Required :	
2 of No.	24
2 " "	35
82 " "	37
1 " "	44
1 " "	45
4 " "	52
5 " "	53
2 " "	59
5 " "	60

The release mechanism of this model is very clearly shown in the sectional underneath view. The coin on being placed in the slot pivots by its weight the lever 3 about the rod 4, moving the end of the strip 5 clear of the double brackets 6, beneath the sliding drawer, so that the drawer may then be pulled out by the bush wheel 7.

Model No. 275 Touring Tram Car



Parts Required :		
20 of No. 5	2 of No. 22	3 of No. 52
6 " " 8	1 " " 26	1 " " 53
8 " " 12	1 " " 28	2 " " 59
4 " " 16	64 " " 37	8 " " 60
6 " " 20		

Model
No. 276

Beam Scales

Parts
Required :

- 7 of No. 1
- 8 " " 2
- 8 " " 3
- 2 " " 4
- 10 " " 5
- 8 " " 8
- 3 " " 10
- 9 " " 12
- 2 " " 15
- 4 " " 15A
- 2 " " 16
- 7 " " 20
- 2 " " 22
- 88 " " 37
- 2 " " 44
- 1 " " 46
- 1 " " 50
- 2 " " 52
- 2 " " 53
- 2 " " 54
- 2 " " 57
- 8 " " 59
- 5 " " 60

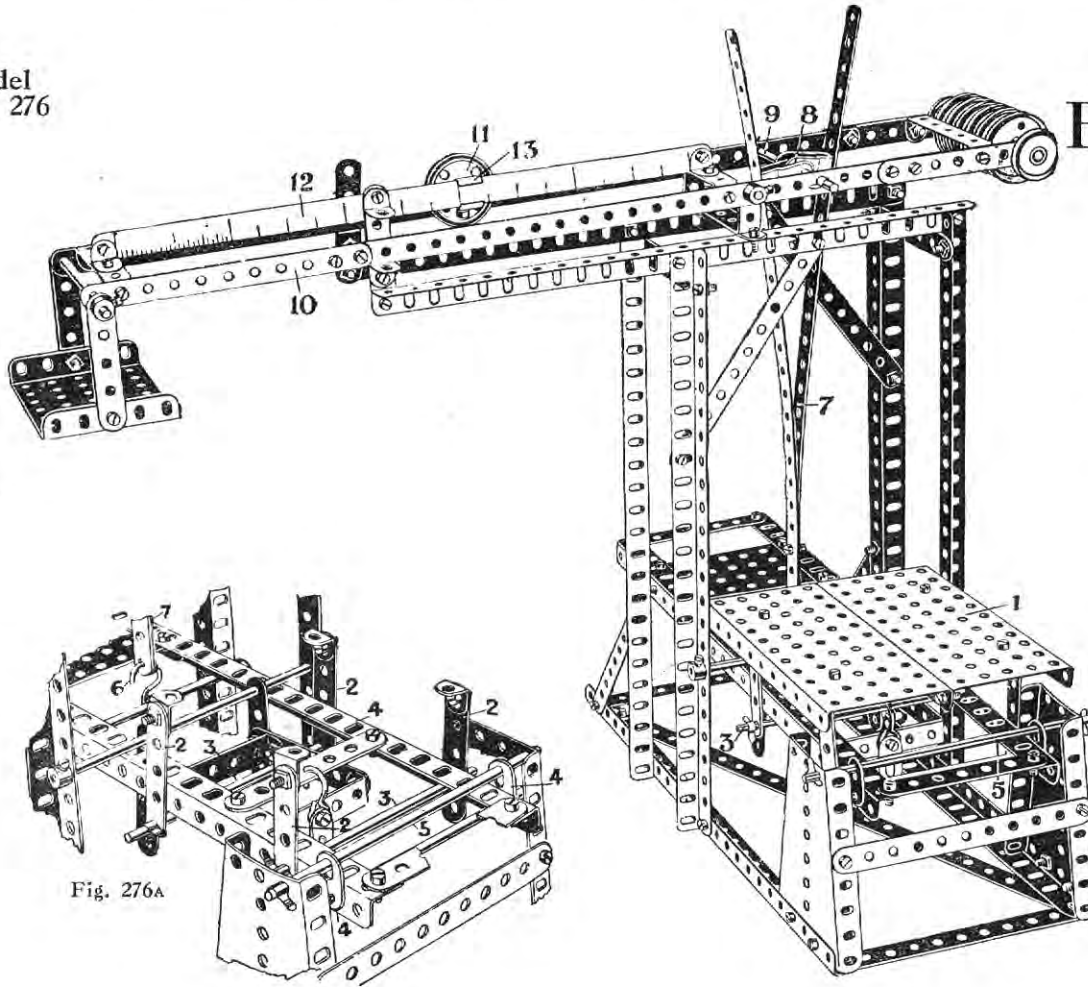
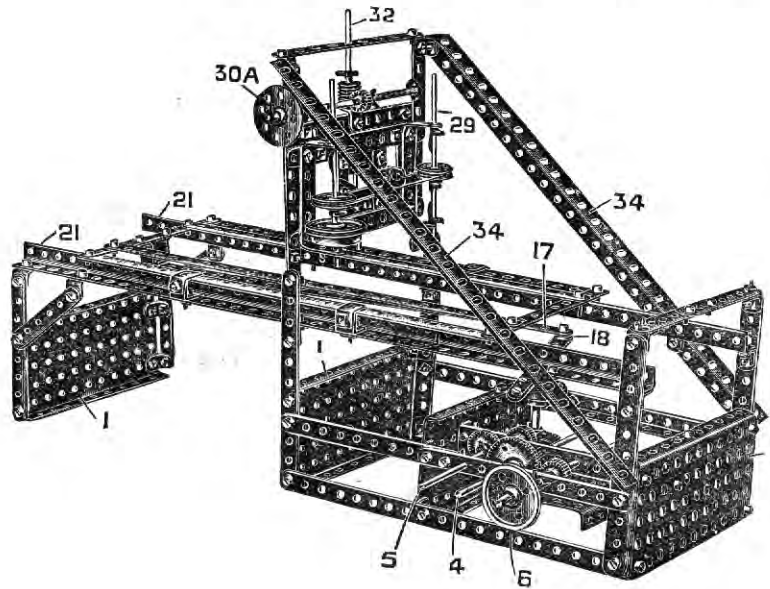

Fig. 276A

The weighing platform 1 is bolted to the four uprights 2, which engage over transverse rods 3, to permit of a parallel movement. The frame 4 of the platform is pivotally slung by flat brackets from the rod 5, and is coupled by hook 6, pull rods 7, which are connected by a pair of cranked bent strips 8 to a rod 9, passing through the side strips 10 to the main weight beam. The sliding weight 11 is adjustable on the graduated arm by an eye piece 13.

Model No. 277 Planing Machine



Parts Required:

3 of No. 1	2 of No. 22
25 " " 2	1 " " 23
1 " " 3	1 " " 24
4 " " 4	4 " " 26
6 " " 5	2 " " 27A
3 " " 6	1 " " 28
8 " " 8	1 " " 32
4 " " 11	4 " " 35
36 " " 12	127 " " 37
1 " " 14	1 " " 45
4 " " 15	2 " " 46
1 " " 15A	4 " " 52
2 " " 16	1 " " 53
1 " " 17	5 " " 59
1 " " 20	1 " " 62
2 " " 21	

Begin by constructing the gear box, Fig. 277A, consisting of three large flanged plates 1 joined by pairs of $5\frac{1}{2}$ " strips 2 overlapped three holes. The strips 2 form bearings for the spindles 3, 4, and 5. The spindle 3, on which is the driving pulley 6, carries a pinion 7 meshing with the gear wheel 8 secured with the pinion 9 on the spindle 4. This pinion 9 meshes with the gear wheel 10 on the spindle 5, which also carries a pinion 11 engaging the contrate wheel 12 on the vertical spindle 13. A crank piece 14 is secured to the spindle 13, and is pivotally connected to the link 16, Fig. 277B, the other extremity of which is pivotally connected to the connecting rod 17 by a lock-nutted attachment 18. The rod 17 is coupled to the table 19 by the double bent strip 20. The table 19 runs upon the angle girders 21. The double brackets 22 forming guides for the table are first

Model No. 277 Planing Machine (continued)

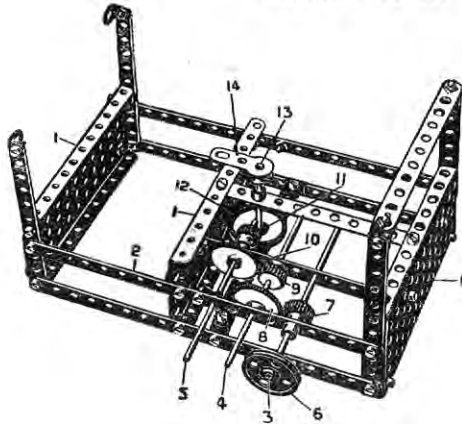

Fig. 277A

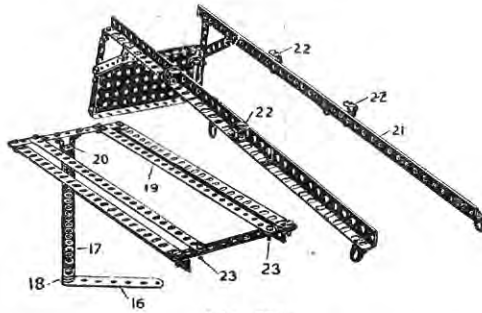

Fig. 277B

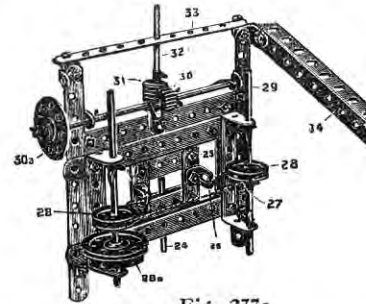

Fig. 277c

bolted in position, and the end nuts and bolts 23 of the table removed to enable the table to pass under the angle brackets initially.

Fig. 277c illustrates the mechanism for controlling the traversing and vertical movement of the tool 24. The tool is carried in the plate 25, to which are secured angle brackets 26 from which the operating cord 27 controlled by the flanged wheel 28a passes round the pulleys 28 on the spindles 29. The vertical movement of the plate is regulated through the bush wheel 30a by means of the pinion 30 engaging the worm 31 here acting as a rack, and secured to the vertically moving spindle 32 guided in the strip 33. The tool head is stayed to the rear plate 1 by the diagonal girders 34.

HOW TO CONTINUE

This completes the Models which may be made with MECCANO Outfit No. 5. The next Models are a little more advanced, requiring a number of extra parts to construct them. The necessary parts are all contained in a No. 5a Accessory Outfit, the cost of which will be found in the Price List at the end of the Manual.

Model
No. 278

Vertical Saw

Parts Required :

12 of No. 1	1 of No. 32
12 " " 2	2 " " 35
4 " " 3	99 " " 37
2 " " 4	1 " " 45
5 " " 5	2 " " 52
8 " " 8	3 " " 53
20 " " 12	1 " " 54
1 " " 14	6 " " 59
1 " " 15	2 " " 62
1 " " 15A	1 " " 63
1 " " 16	
3 " " 17	
8 " " 20	
1 " " 21	
3 " " 22	
2 " " 25	
2 " " 26	
1 " " 27	
1 " " 28	

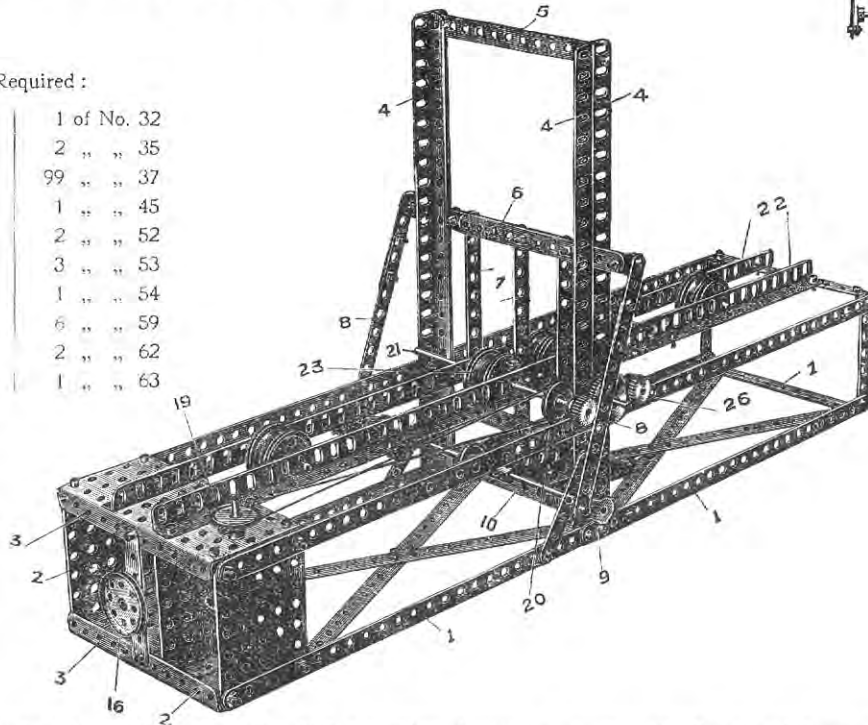

Fig. 278A

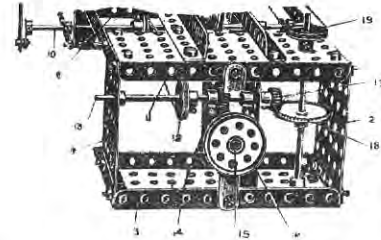
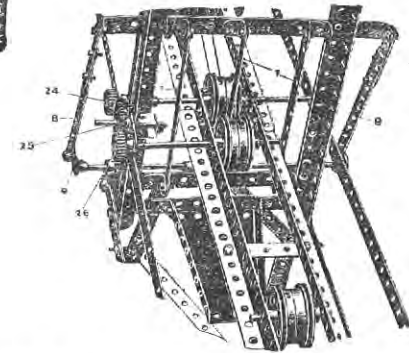
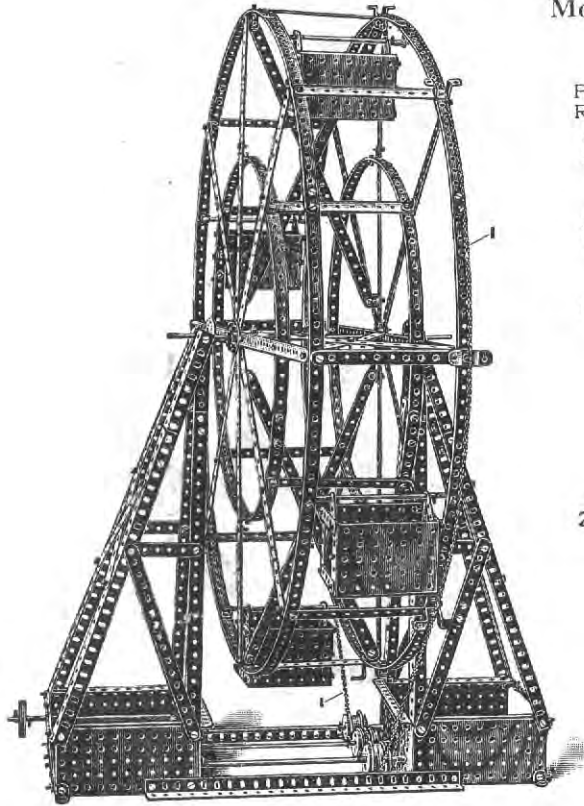

Fig. 278B



This model represents a log-sawing machine in which a number of saws are moved vertically up and down while the log is fed forward to the saws and cut into planks. The base framework of the model is formed of strips 1 connected to small flanged plates 2, forming the sides, and large flanged plates 3 forming the top and bottom of the gear box. Angle girders 4 are bolted to the strips 1 to form vertical guides for the saw frame, a strip 5 being bolted between the flanges and the angle girders to give clearance for the frame strips 6 carrying saws 7 which slide between the angle girders 4. The frame 6 is moved vertically up and down by the connecting rods 8 lock-nutted to the ends of the upper strips 6, and cranks 9 secured on the end of an axle rod 10. This rod 10 is driven by a cord 11 passing over a pulley wheel 12 on a rod 13, which is driven by a pinion 14 engaging with a worm on the driving shaft 15, this driving shaft being fitted with a driving pulley 16. To provide for the travel of the logs, the other end of the rod 13 is fitted with a pinion 17 engaging a contrate wheel 18 on a vertical spindle, the upper end of which is fitted with a pulley wheel 19, the driving cord passing round this pulley 19 to a similar pulley 20 on an axle 21 journaled in the vertical webs of the angle girder rails 22. This rod 21 carries the flanged wheels 23, and is geared by a pinion 24 engaging a gear wheel 25 to another pinion 26 carrying another pair of flanged wheels. The log is carried along on these flanged wheels through the saws 7.

Model No. 279 Big Wheel



Parts
Required :

46 of No.	1
24 " "	2
4 " "	3
4 " "	4
4 " "	5
10 " "	8
4 " "	9
8 " "	11
68 " "	12
5 " "	13
1 " "	14
4 " "	15
6 " "	20
1 " "	21
4 " "	24
2 " "	25
2 " "	27A
12 " "	35
292 " "	37
6 " "	52
8 " "	53
2 " "	54
4 " "	59
1 " "	94

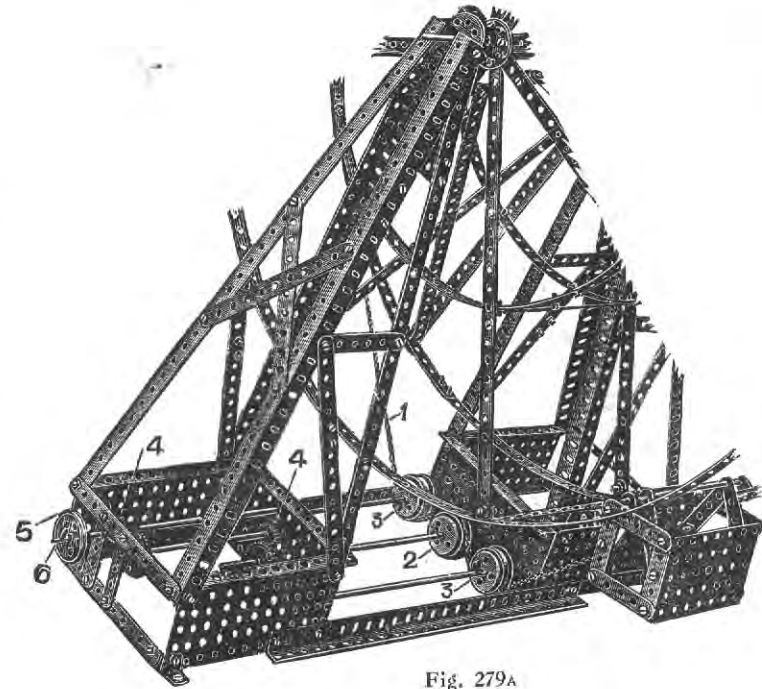

Fig. 279A

In constructing this model flanged plates are used to form the sides and inner part of the base of the side pedestals and also to form the suspended cages on the wheel.

The driving chain is conveniently kept in position round the periphery of one of the side elements of the wheel by a series of double angle brackets bolted on the ends of the spokes.

In Fig. 279A is shown how the driving chain 1, passing round the driving wheel 2, is held around the circumference thereof by the guide wheels 3. The driving wheel 2 is driven through the gear wheel 4 from a $1\frac{1}{2}$ " pulley wheel 5 carried on the spindle 6.

Model No. 280

Steam Shovel

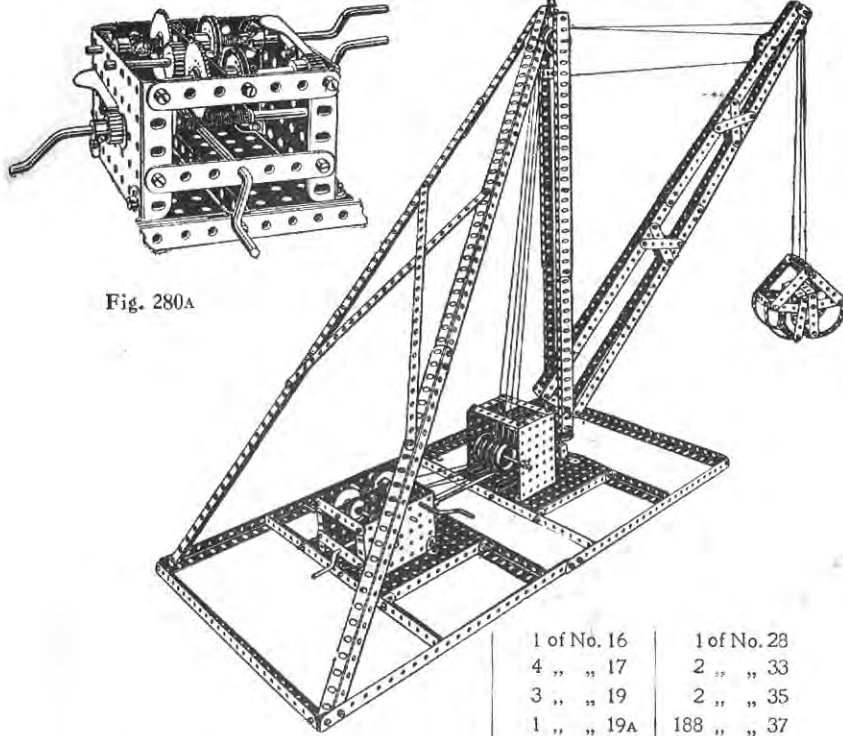
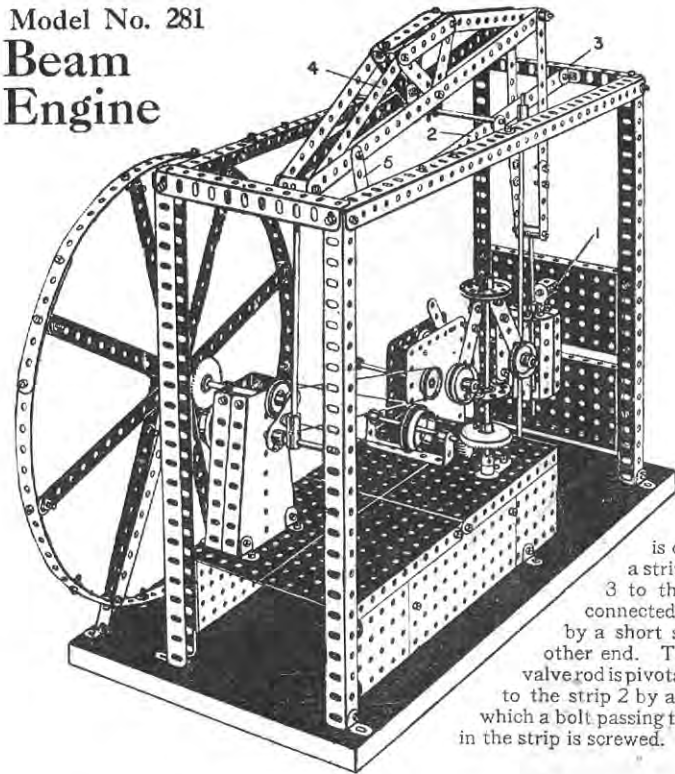

Fig. 280A

Parts
Required:

10 of No. 1	18 of No. 8	1 of No. 16	1 of No. 28
12 " " 3	2 " " 9	4 " " 17	2 " " 33
4 " " 4	3 " " 10	3 " " 19	2 " " 35
16 " " 5	2 " " 11	1 " " 19A	188 " " 37
4 " " 6	28 " " 12	8 " " 20	2 " " 45
	1 " " 13	1 " " 21	3 " " 46
		2 " " 22	4 " " 52
		3 " " 22A	4 " " 53
		2 " " 24	11 " " 59
		4 " " 26	6 " " 60
		2 " " 27	1 " " 63

Model No. 281
**Beam
Engine**



The valve 1 is operated from a strip 2 pivoted at 3 to the frame and connected to the beam 4 by a short strip 5 at the other end. The top of the valve rod is pivotally connected to the strip 2 by a coupling into which a bolt passing through a hole in the strip is screwed.

Parts Required:

7 of No. 1	27 of No. 12	2 of No. 21	1 of No. 50
18 " " 2	1 " " 13	5 " " 22	7 " " 52
3 " " 4	1 " " 13A	2 " " 23	4 " " 53
10 " " 5	1 " " 14	4 " " 24	2 " " 54
1 " " 6	3 " " 15	2 " " 26	7 " " 59
8 " " 8	1 " " 16	1 " " 27	6 " " 60
4 " " 9	2 " " 17	1 " " 28	3 " " 62
6 " " 10	2 " " 18	149 " " 37	3 " " 63
4 " " 11	2 " " 20	1 " " 46	5 " " 63

Model No. 282 Equatorial Mounting

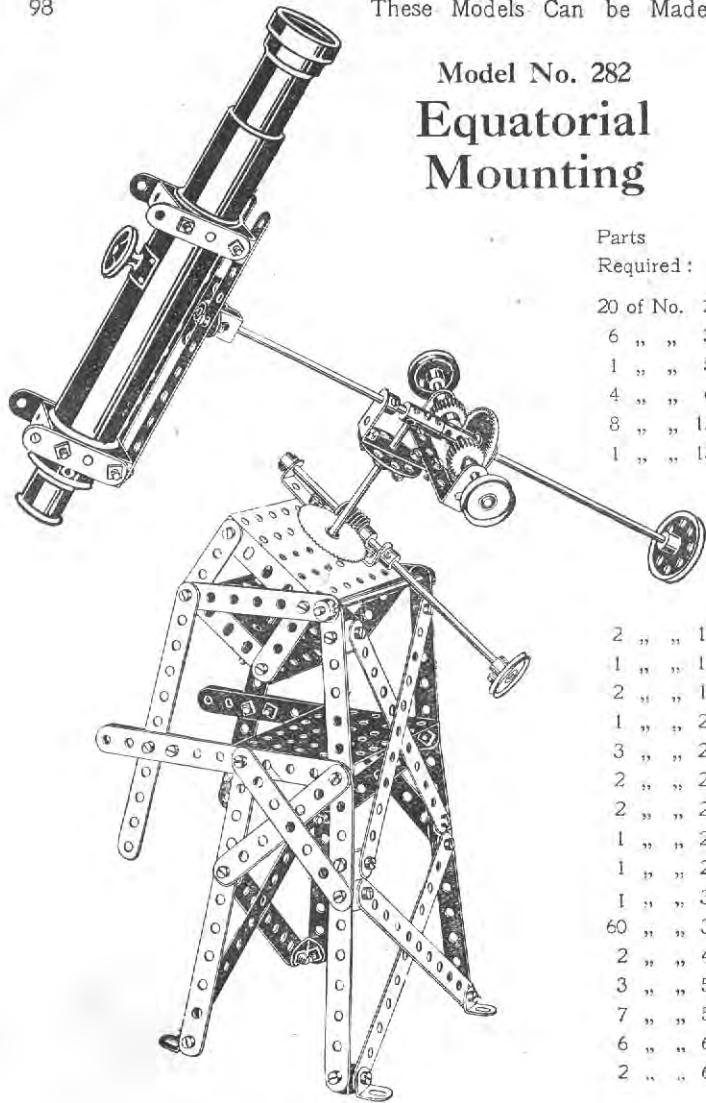

Parts
Required:

20 of No. 2
6 " " 3
1 " " 5
4 " " 6
8 " " 12
1 " " 13

2 " " 14
1 " " 15A
2 " " 17
1 " " 21
3 " " 22
2 " " 24
2 " " 25
1 " " 27
1 " " 28
1 " " 32
60 " " 37
2 " " 46
3 " " 53
7 " " 59
6 " " 60
2 " " 63

Model No. 283 Dental Chair

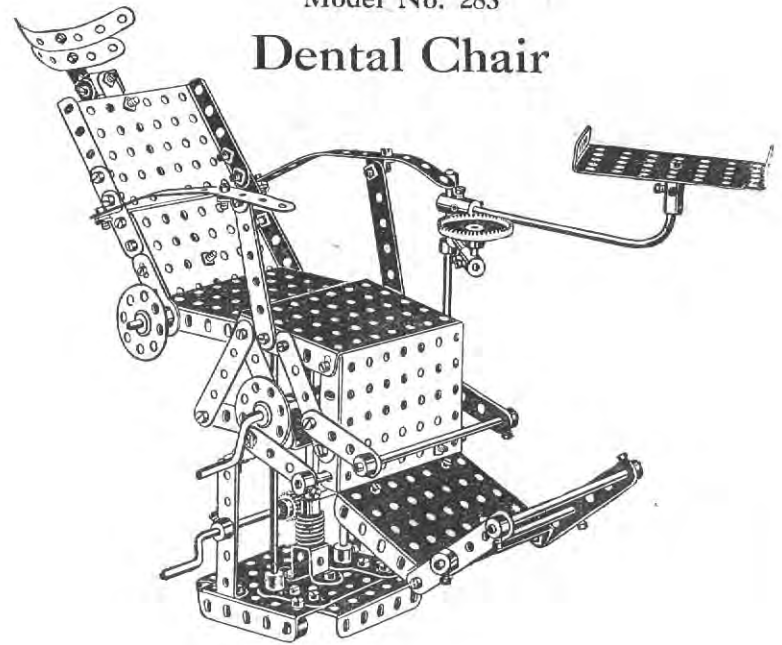

Parts Required:

3 of No. 2	1 of No. 14	63 of No. 37
2 " " 3	3 " " 15	1 " " 45
4 " " 4	5 " " 15A	2 " " 50
7 " " 5	1 " " 16	10 " " 53
6 " " 6	2 " " 19	17 " " 59
2 " " 11	2 " " 24	2 " " 60
6 " " 12	1 " " 26	3 " " 62
1 " " 13A	1 " " 28	4 " " 63
	1 " " 32	

Model
No. 284

Fret Saw

Parts
Required :

- 8 of No. 1
- 6 " " 2
- 3 " " 3
- 1 " " 4
- 1 " " 5
- 20 " " 8
- 4 " " 9
- 2 " " 10
- 3 " " 12
- 1 " " 13A
- 2 " " 15A
- 1 " " 16
- 1 " " 22
- 2 " " 22A
- 98 " " 37
- 2 " " 43
- 2 " " 52
- 4 " " 53
- 2 " " 54
- 2 " " 57
- 4 " " 59
- 1 " " 63
- 6 " " 100

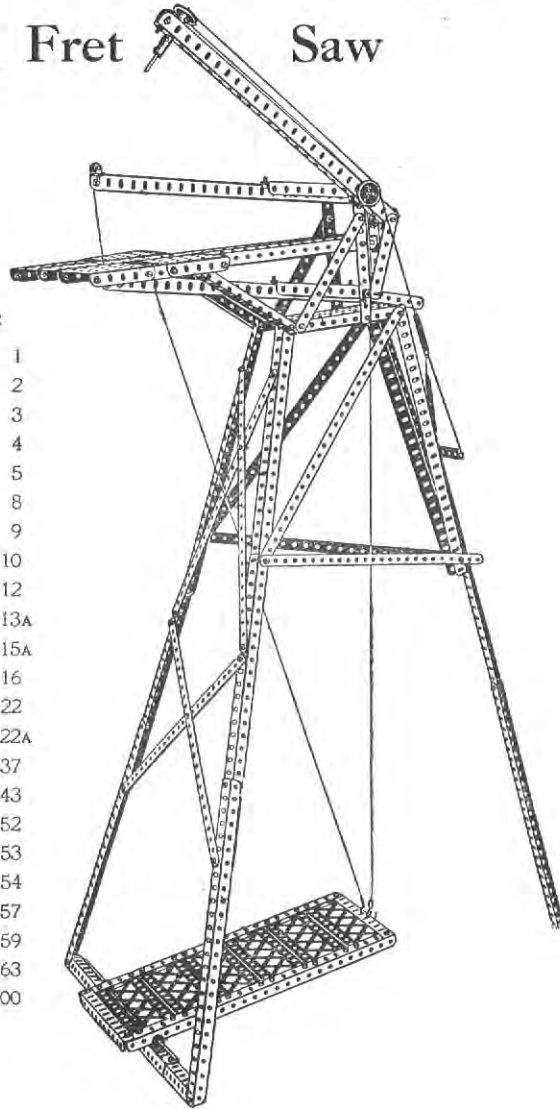

Model No. 285

Maxim Gun

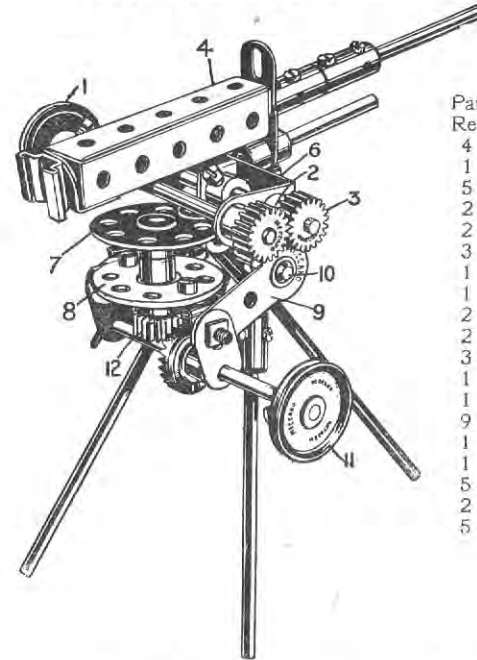

- Parts
Required :
- 4 of No. 10
 - 1 " " 11
 - 5 " " 12
 - 2 " " 15
 - 2 " " 15A
 - 3 " " 16
 - 1 " " 17
 - 1 " " 18
 - 2 " " 22
 - 2 " " 24
 - 3 " " 26
 - 1 " " 29
 - 1 " " 35
 - 9 " " 37
 - 1 " " 46
 - 1 " " 50
 - 5 " " 59
 - 2 " " 62
 - 5 " " 63

The handwheel 1 operates the pinions 2 and 3 ; on the spindle of the latter the gun frame 4 is mounted, movement of the wheel 1 elevating the gun. The double bent strip 6 is bolted by an angle bracket to the upper bush wheel 7, the spindle of which passes loosely through the lower bush wheel 8, which is bolted by angle brackets to the cranks 9, a rod 10 joining the cranks to which the front leg of the tripod is secured, the other legs being bolted to a pair of angle brackets secured to a coupling at the top of the front leg. The gun is swivelled horizontally by means of the handwheel 11, on the spindle of which is the contrate wheel engaging the pinion 12 on the spindle of the bush wheel 7.

Model
No. 286 Joy Wheel

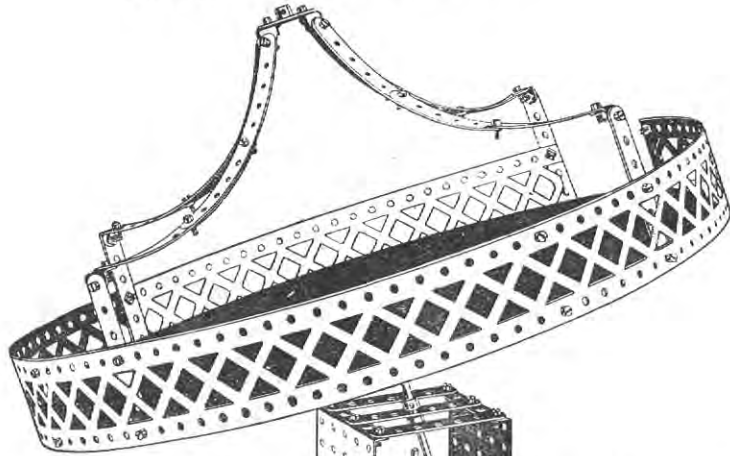

Parts Required:

4 of No.	1
23 "	2
15 "	3
4 "	4
3 "	5
1 "	6
4 "	8
10 "	12
1 "	14
1 "	15
1 "	15A
1 "	19
3 "	24
1 "	26
2 "	27
1 "	32
121 "	37
2 "	52
6 "	53
8 "	59
7 "	60
4 "	99

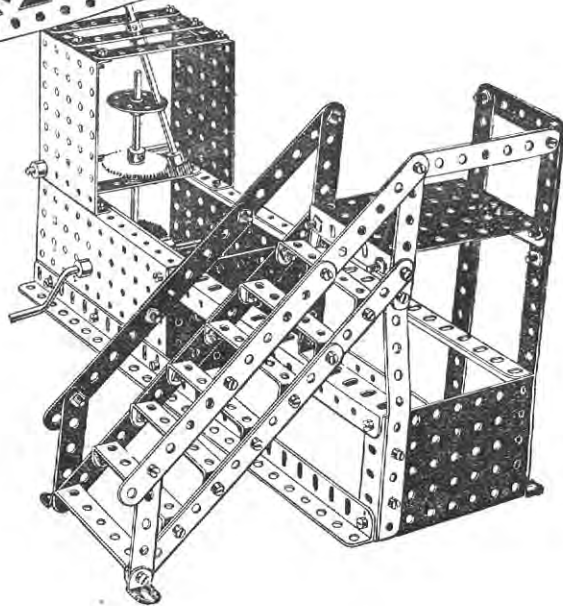

Model
No. 287 Linen Winder

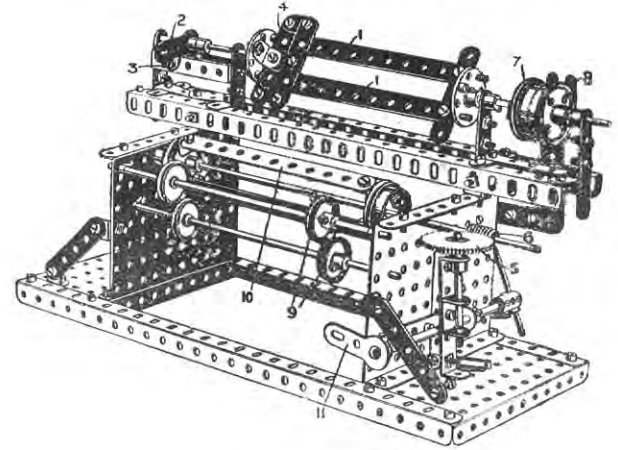

Parts Required:

6 of No.	2	1 of No.	15	94 of No.	37
2 "	3	3 "	16	1 "	43
12 "	5	1 "	17	1 "	44
4 "	8	4 "	20	2 "	46
11 "	10	4 "	22	2 "	52
2 "	11	2 "	24	7 "	59
16 "	12	1 "	27	3 "	60
1 "	13	1 "	32	2 "	62
2 "	13A	5 "	35	1 "	63

In order to disengage the winding frame bars 1 the crank 2 is lifted clear of the stop 3 and drawn back, this action disengaging the end cross strips 4 from the tips of the frame bars 1 and permitting the wound linen to be removed. The gear wheel 5 engaging the worm 6 forms a counter. 7 are the bell pulleys, and 8 the bell striker operated by crank 11; 9 are the guide pulleys for the main linen drums 10.

Model No. 288 Profiling Machine

Parts Required :

19 of No. 2	1 of No. 21	73 of No. 37
1 " " 3	3 " " 22A	1 " " 45
3 " " 5	1 " " 23	2 " " 50
4 " " 8	2 " " 24	2 " " 52
3 " " 11	3 " " 26	2 " " 53
1 " " 13	2 " " 27	6 " " 59
3 " " 15	2 " " 28	16 " " 60
4 " " 15A	1 " " 32	6 " " 63
4 " " 16	8 " " 35	9 " " 94
1 " " 19		2 " " 96

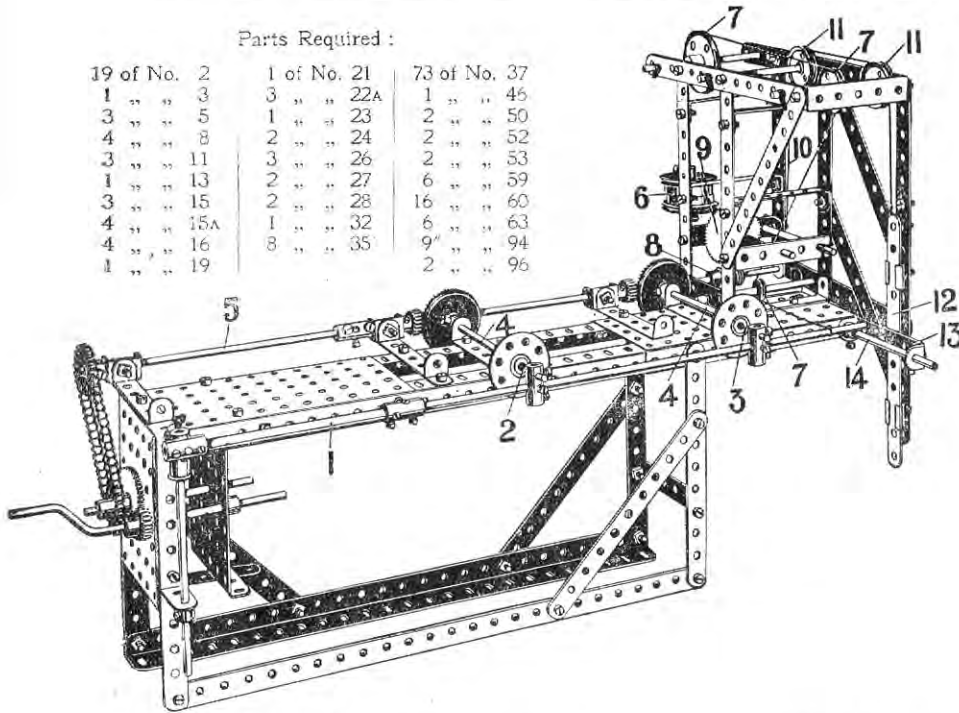

The side shaft 1 carries the follower tool 2 of the medal to be copied, and the cutting tool 3 for the work. The copy and work are rotated by the shafts 4 from the driving shaft 5, and resilient pressure is imparted to the cutting tool 3 by means of a weight 6, the cord of which passes over pulley 7 and is connected to shaft 1. The vertical traverse of the tool is effected by the worm 8 engaging the spur wheel 9, a cord winding on its spindle and passing over pulleys 11 and being connected to the girder strip 12 bolted to the double bent strip 13, which forms a bearing for a rod 14 on which the end of the shaft 1 rests.

Model No. 289 Catapult

Parts Required :

2 of No. 1
21 " " 2
12 " " 3
2 " " 4
4 " " 5
1 " " 6
4 " " 8
8 " " 11
19 " " 12
3 " " 14
1 " " 16
4 " " 35
98 " " 37
1 " " 43
8 " " 59
4 " " 60

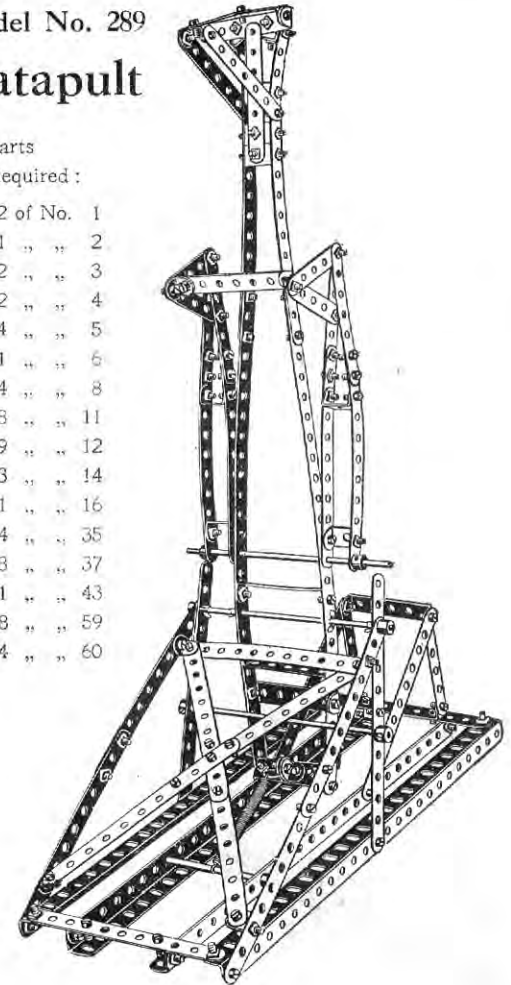

Stone Sawing Machine

Model
No. 290

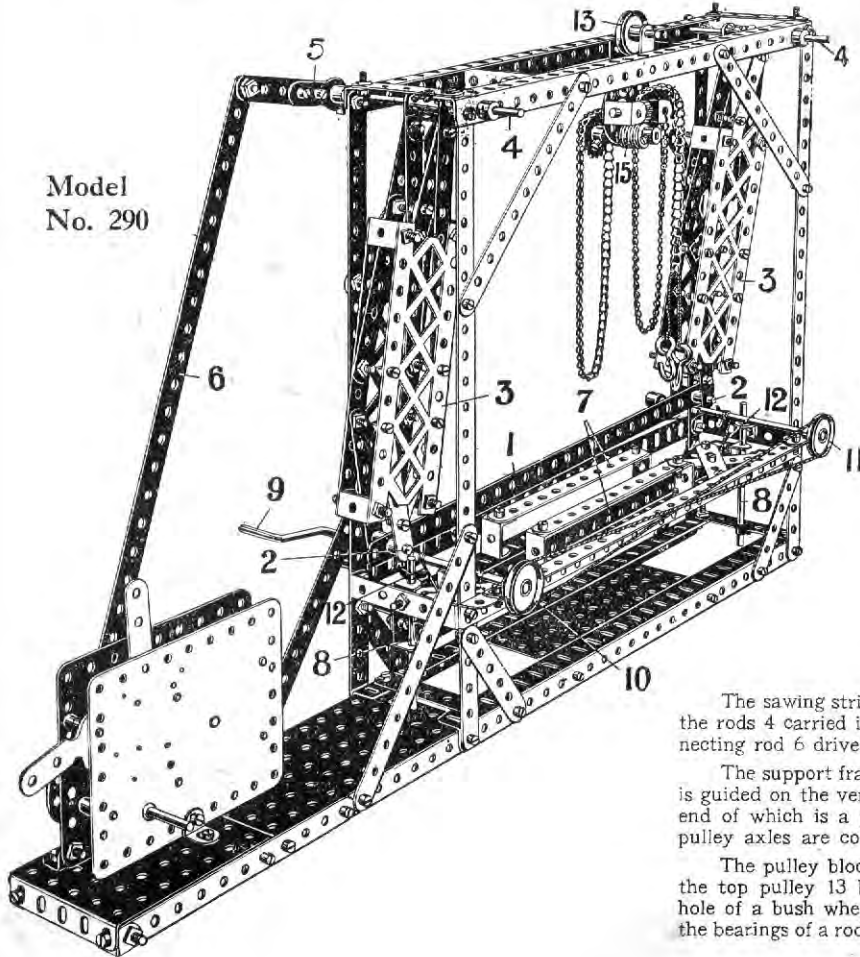

Parts
Required :

6 of No.	1
14 "	2
4 "	3
12 "	4
13 "	5
8 "	8
16 "	11
9 "	12
1 "	14
3 "	15A
2 "	16
2 "	17
1 "	19
3 "	22
2 "	24
1 "	26
1 "	32
6 "	35
126 "	37
1 "	44
2 "	52
1 "	53
2 "	57
10 "	59
4 "	60
2 "	62
2 "	63
2 "	94
2 "	96
4 "	100

Model No. 291 Velocipede

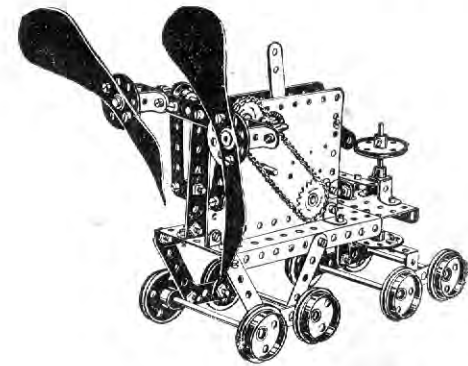

Parts Required :

1 of No.	2	8 of No.	20	3 of No.	45
1 "	4	3 "	24	1 "	46
10 "	5	2 "	26	1 "	52
10 "	12	2 "	29	1 "	53
2 "	15A	47 "	37	2 "	59
4 "	16	2 "	41	2 "	96
2 "	17				

The sawing strip 1 is carried from the short rods 2 in the ends of the swinging frames 3 pivoted on the rods 4 carried in the frame. These swinging frames 3 are oscillated from the crank 5 and connecting rod 6 driven by the motor.

The support frame 7 for the stone blocks to be sawn is raised and lowered as follows: The frame 7 is guided on the vertical rods 8 and raised and lowered by the operation of the crank handle 9 on the end of which is a pulley 10 connected by a cord to another pulley 11. End cords 12 wound on the pulley axles are connected to the support frame 7 and raise or lower it as required.

The pulley block runs upon a rod supported by two 2½" bent strips across the upper framework, the top pulley 13 being carried in a cranked bent strip bolted by an angle bracket to the upper hole of a bush wheel, which forms the framework of the pulley block, two double brackets forming the bearings of a rod on which is the pinion engaged by the worm 15.

Model No. 292 Bagatelle

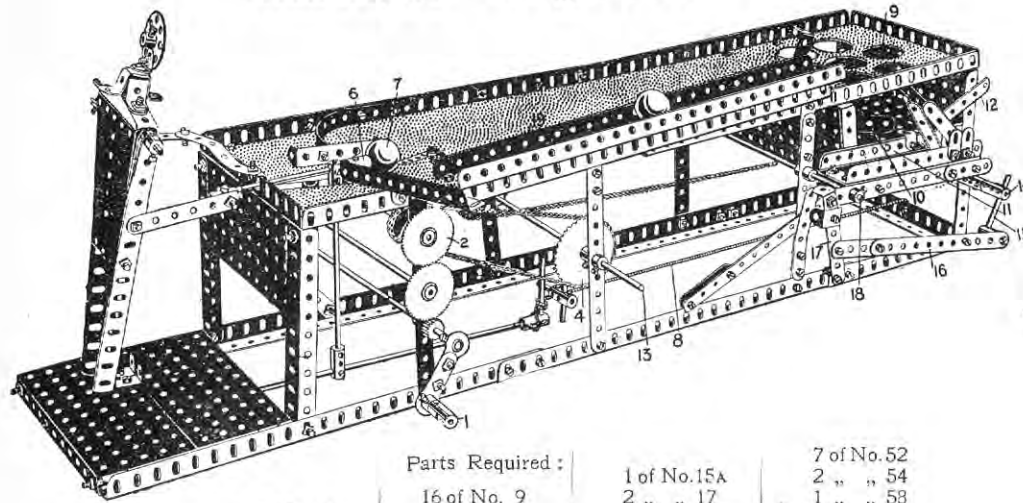

Parts Required :			
1 of No. 1	16 of No. 9	1 of No. 15A	7 of No. 52
12 " " 2	9 " " 10	2 " " 17	2 " " 54
4 " " 4	3 " " 11	1 " " 18	1 " " 58
3 " " 5	12 " " 12	1 " " 24	11 " " 59
10 " " 6	1 " " 13	1 " " 26	2 " " 62
12 " " 8	4 " " 13A	2 " " 27A	9 " " 63
	3 " " 14	137 " " 37	3 " " 95
		2 " " 45	1 " " 96

The operating handle 1 drives the gear wheel 2, a sprocket wheel on the spindle being coupled to a sprocket wheel 4. The spindle 13 of this carries a crank made by short rods and coupling, which crank engages at each revolution and pushes back a pusher-bar 6 by means of which the ball is driven forward. A spring cord 8 returns the pusher-rod. After the ball is driven forward, it drops down one of the holes 9 and is led by the guides into the lifting pocket. The ball is held back by a pivoted strip 12 which is caught and pulled down as the pocket 11 descends, permitting the ball to fall out. The pocket is raised by a chain passing over a 2" sprocket at the opposite end of rod 13, which is coupled to another 2" sprocket on spindle 14, which latter carries a rod 15 arranged as a crank coupled by strips 16 to an arm 17 on the pivot 18 of the lifting pocket 11. The ball is lifted by the pocket and deposited into the chute 19, by which it is returned to the pusher-arm 6.

Model No. 293 Jaunting Car

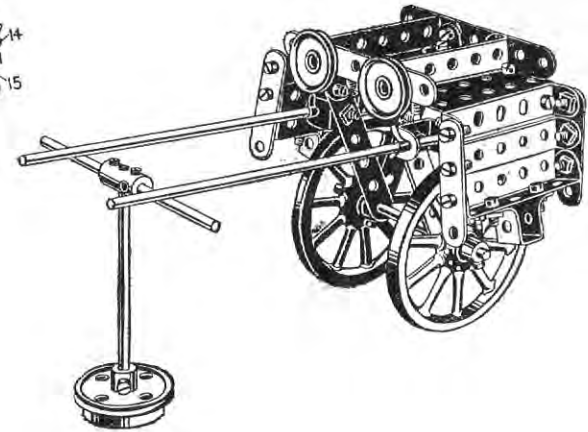

Parts Required :		
2 of No. 3	1 of No. 16	40 of No. 37
4 " " 4	2 " " 17	2 " " 45
4 " " 6	2 " " 19A	1 " " 53
14 " " 12	1 " " 20	4 " " 59
2 " " 13A	2 " " 22	8 " " 60
1 " " 15	4 " " 35	1 " " 63

Model No. 294 Roller Skate

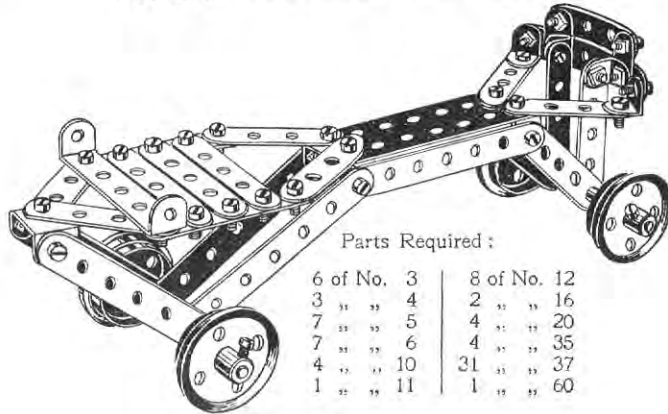

Parts Required :

6 of No. 3	8 of No. 12
3 " " 4	2 " " 16
7 " " 5	4 " " 20
7 " " 6	4 " " 35
4 " " 10	31 " " 37
1 " " 11	1 " " 60

Model No. 295 Scales

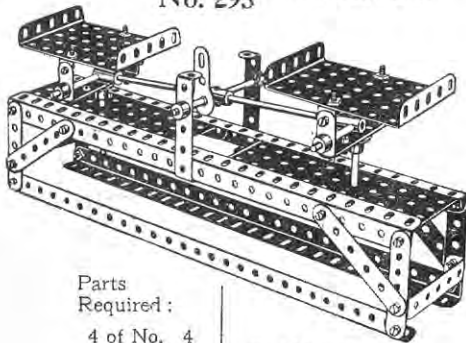

Parts Required :

4 of No. 4	
4 " " 5	2 of No. 52
4 " " 8	2 " " 53
5 " " 16	6 " " 59
2 " " 17	6 " " 60
30 " " 37	3 " " 62
2 " " 46	3 " " 63

Model No. 296 Armed Motor Cycle

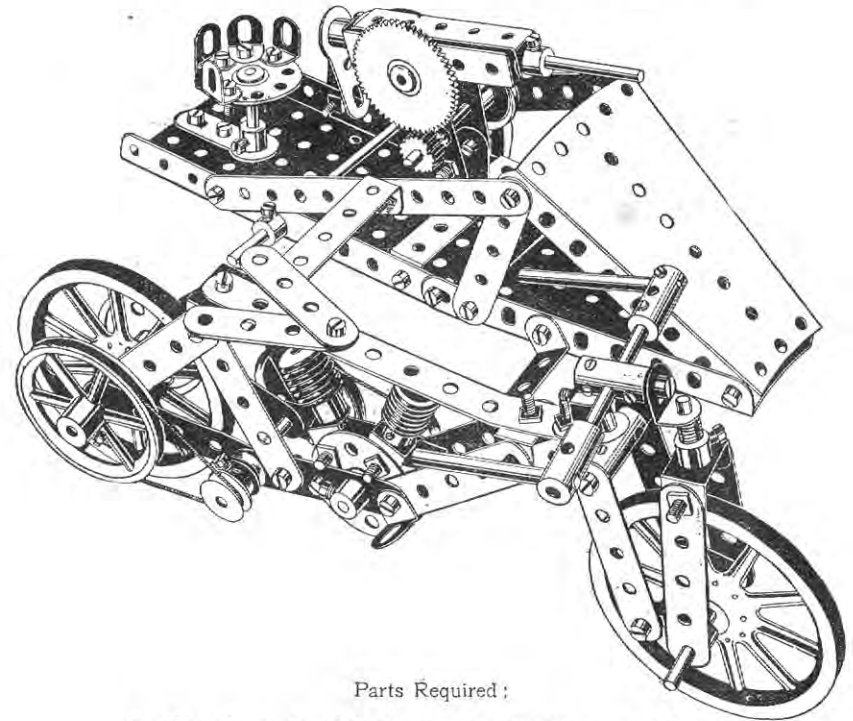

Parts Required :

3 of No. 2	7 of No. 17	2 of No. 23A	1 of No. 52
16 " " 5	3 " " 18	2 " " 24	2 " " 54
4 " " 6	3 " " 19A	1 " " 26	10 " " 59
4 " " 10	1 " " 20A	1 " " 27A	2 " " 60
3 " " 11	2 " " 21	2 " " 32	2 " " 62
11 " " 12	1 " " 22	50 " " 37	4 " " 63
2 " " 15A	1 " " 23	1 " " 44	

Model No. 297 Jack Knife Bridge

Parts Required :	Quantity	Part No.
4 of No. 1	4	1
25 " " 2	25	2
2 " " 3	2	3
2 " " 4	2	4
4 " " 5	4	5
31 " " 6	31	6
8 " " 8	8	8
16 " " 9	16	9
4 " " 12	4	12
26 " " 13	26	13
1 " " 14	1	14
4 " " 15A	4	15A
1 " " 16	1	16
8 of No. 20	8	20
1 " " 21	1	21
2 " " 22	2	22
2 " " 22A	2	22A
2 " " 24	2	24
2 " " 26	2	26
2 " " 28	2	28
1 " " 29	1	29
1 " " 32	1	32
184 " " 37	184	37
1 " " 46	1	46
1 " " 52	1	52
3 " " 53	3	53
4 " " 59	4	59
7 " " 59	7	59
1 " " 63	1	63
4 " " 99	4	99
2 " " 100	2	100

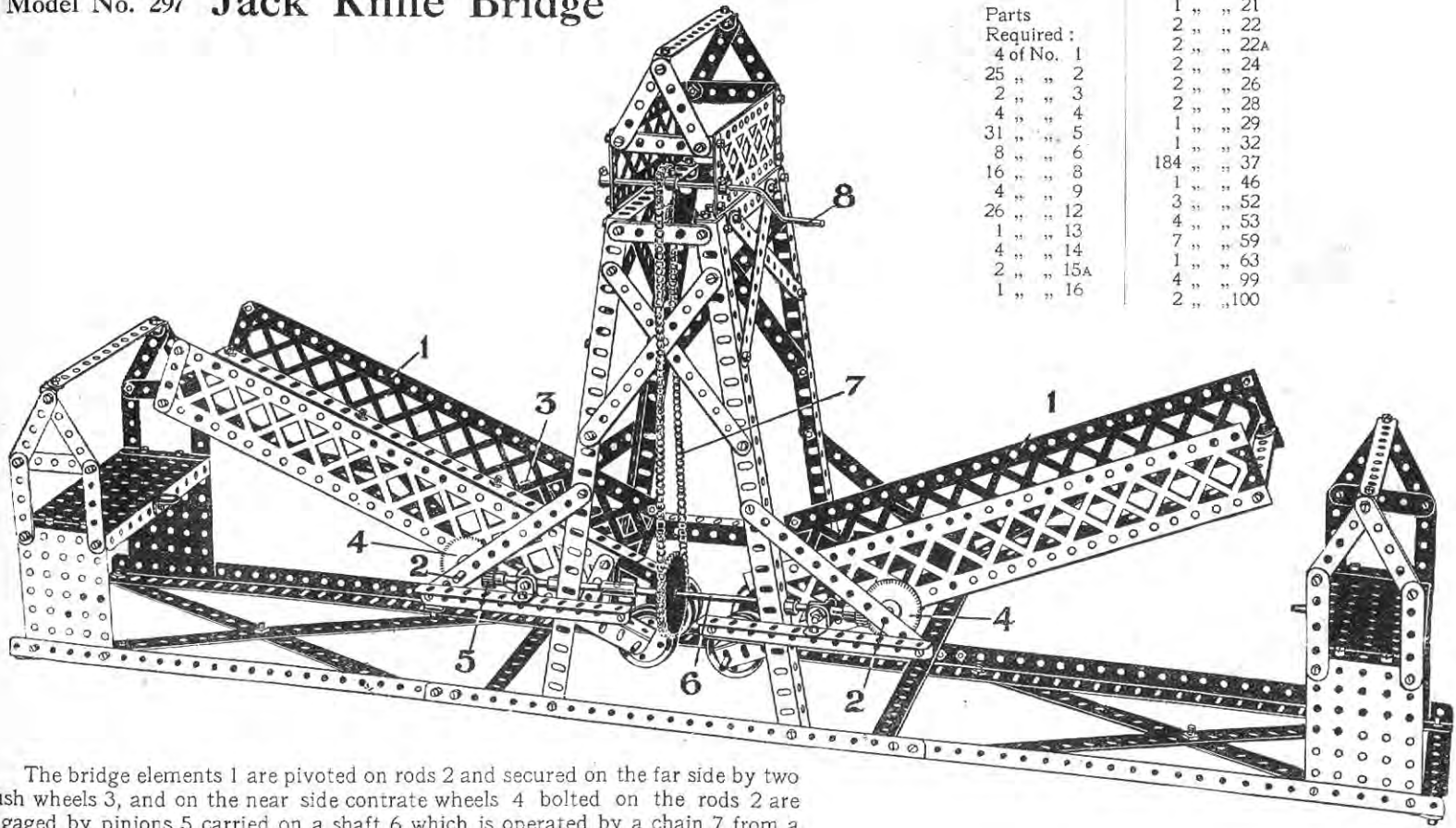

The bridge elements 1 are pivoted on rods 2 and secured on the far side by two bush wheels 3, and on the near side contra wheels 4 bolted on the rods 2 are engaged by pinions 5 carried on a shaft 6 which is operated by a chain 7 from a sprocket wheel on the crank handle 8. In this way as the crank is rotated the shaft 6 swings the bridge elements 1 simultaneously.

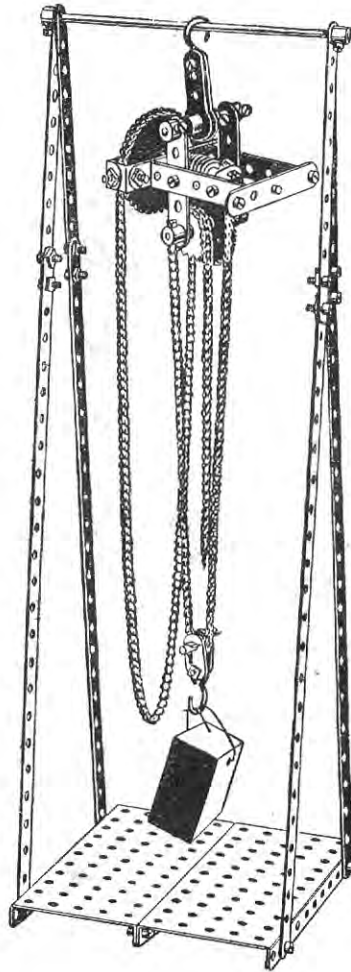

Model No. 298
Purchase
Block

Parts
Required :

4 of No. 1
4 " " 2
3 " " 5
2 " " 10
1 " " 12
1 " " 15
1 " " 16
2 " " 17
1 " " 18
1 " " 27A
1 " " 32
2 " " 35
23 " " 37
2 " " 52
2 " " 57
7 " " 59
4 " " 60
2 " " 62
4 " " 94
1 " " 95
1 " " 96

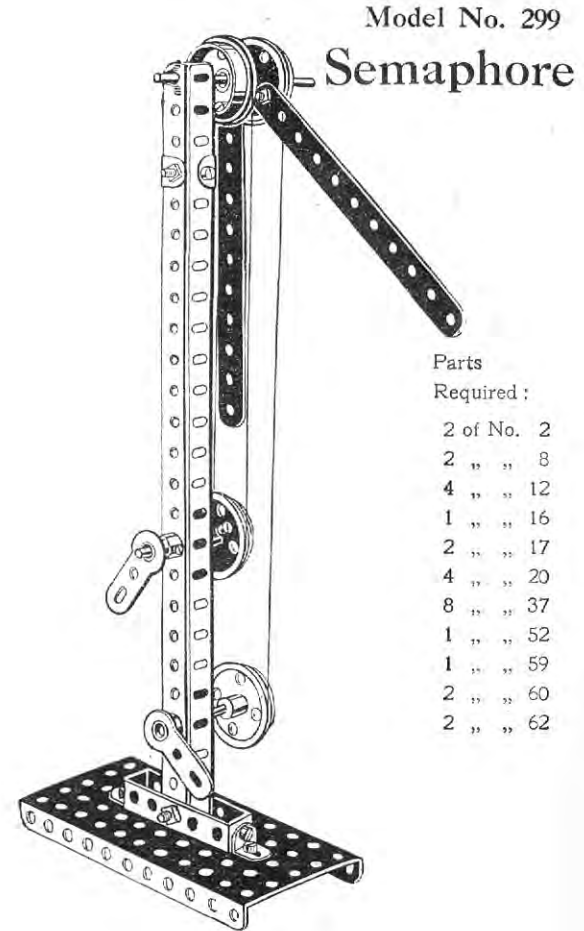

Parts
Required :

2 of No. 2
2 " " 8
4 " " 12
1 " " 16
2 " " 17
4 " " 20
8 " " 37
1 " " 52
1 " " 59
2 " " 60
2 " " 62

Model No. 300 Platform Scales

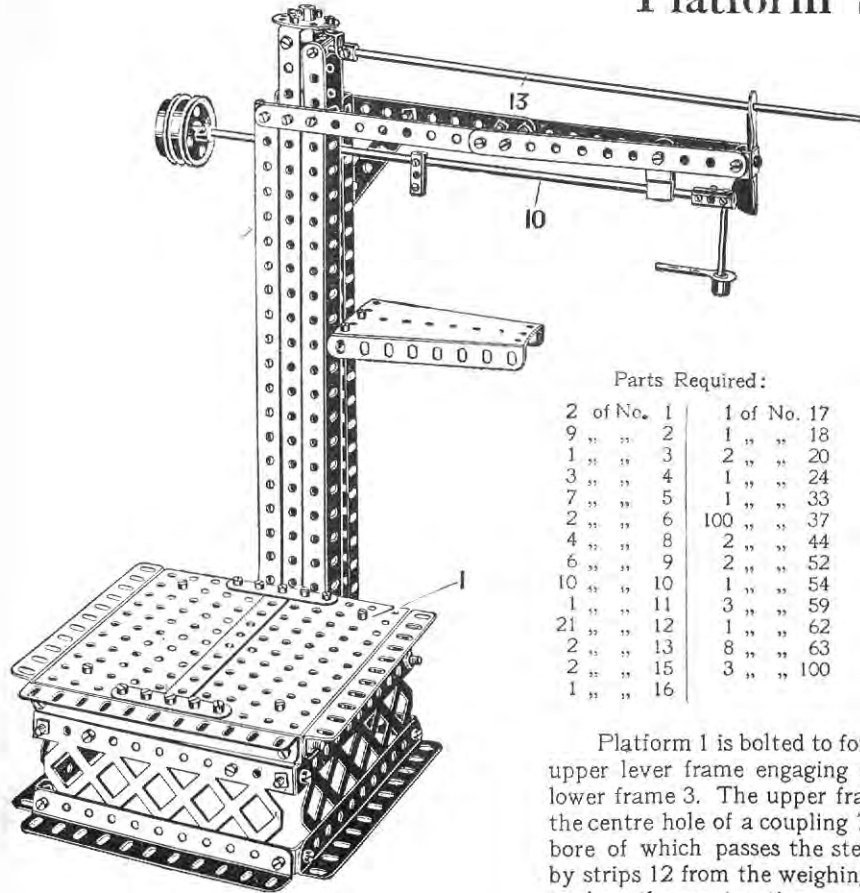

Parts Required:

2 of No. 1	1 of No. 17
9 " " 2	1 " " 18
1 " " 3	2 " " 20
3 " " 4	1 " " 24
7 " " 5	1 " " 33
2 " " 6	100 " " 37
4 " " 8	2 " " 44
6 " " 9	2 " " 52
10 " " 10	1 " " 54
1 " " 11	3 " " 59
21 " " 12	1 " " 62
2 " " 13	8 " " 63
2 " " 15	3 " " 100
1 " " 16	

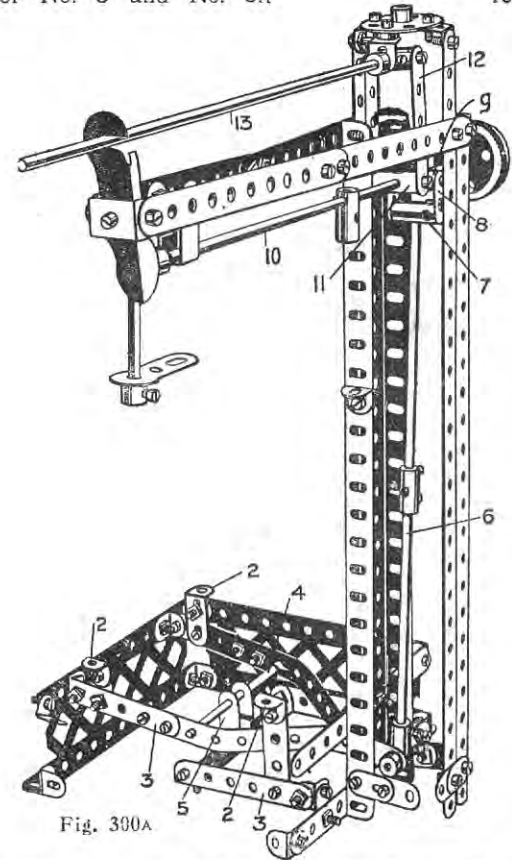
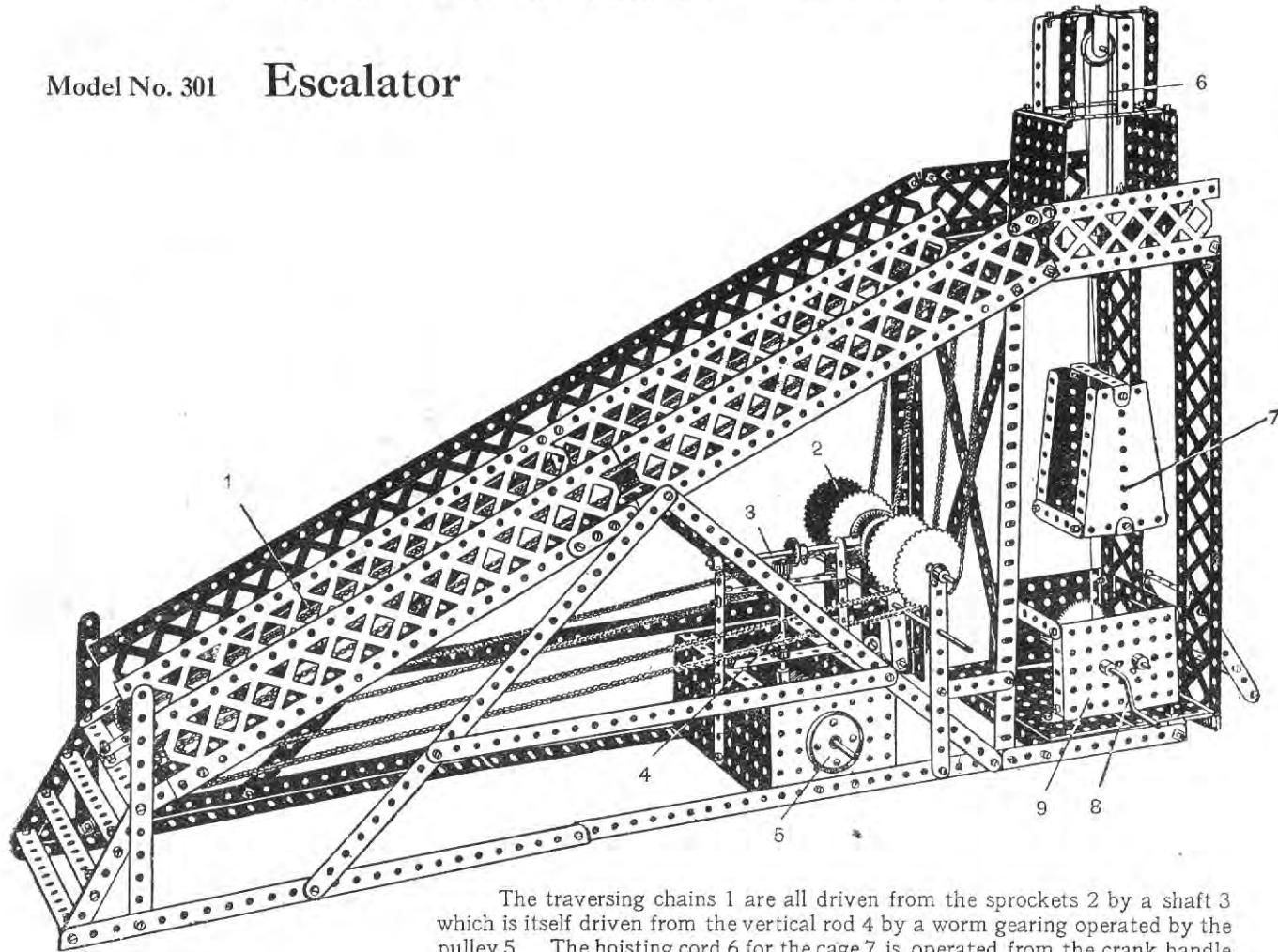

Fig. 390A

Platform 1 is bolted to four angle brackets 2, which are bolted to a pair of lever frames 3, the upper lever frame engaging a rod 4, which is also connected by a cranked bent strip 5 to the lower frame 3. The upper frame 3 is connected to the foot of a pull rod 6, the top of which engages the centre hole of a coupling 7, linked by flat brackets 8 to another coupling 9, through the centre bore of which passes the steelyard rod 10, which is pivotally suspended from another coupling 11 by strips 12 from the weighing lever 13. Sectional view shows the model slightly dismantled, better to show the construction.

Model No. 301 Escalator



Parts Required:

8	of No. 1
10	" " 2
11	" " 3
6	" " 5
2	" " 6
12	" " 8
2	" " 9
4	" " 10
32	" " 12
2	" " 13A
4	" " 14
2	" " 15A
1	" " 16
1	" " 18
1	" " 19
1	" " 21
1	" " 22
2	" " 22A
1	" " 25
5	" " 26
2	" " 27A
2	" " 28
1	" " 29
1	" " 32
150	" " 37
1	" " 44
5	" " 52
6	" " 53
2	" " 54
10	" " 59
10	" " 60
20	" " 94
4	" " 95
8	" " 96
8	" " 99
2	" " 100

The traversing chains 1 are all driven from the sprockets 2 by a shaft 3 which is itself driven from the vertical rod 4 by a worm gearing operated by the pulley 5. The hoisting cord 6 for the cage 7 is operated from the crank handle 8 by gearing in the box 9. The cage traverses guide cords secured at top and bottom and which pass through the holes in the strips of the cage.

Model No. 302

Planing Machine

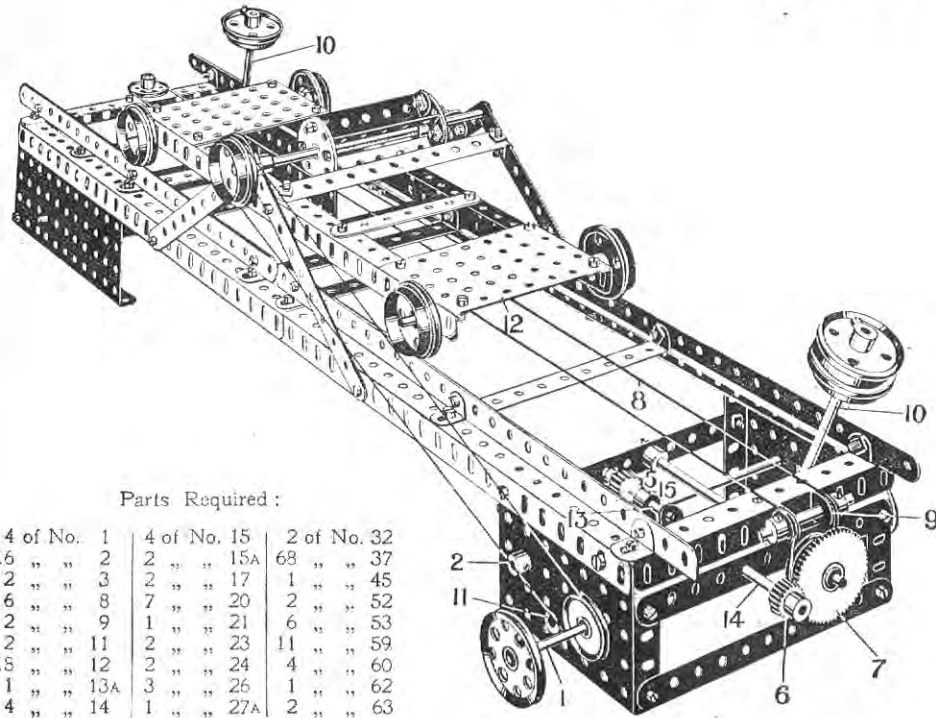

Parts Required :

4 of No. 1	4 of No. 15	2 of No. 32
16 " " 2	2 " " 15A	68 " " 37
2 " " 3	2 " " 17	1 " " 45
6 " " 8	7 " " 20	2 " " 52
2 " " 9	1 " " 21	6 " " 53
2 " " 11	2 " " 23	11 " " 59
18 " " 12	2 " " 24	4 " " 60
1 " " 13A	3 " " 26	1 " " 62
4 " " 14	1 " " 27A	2 " " 63

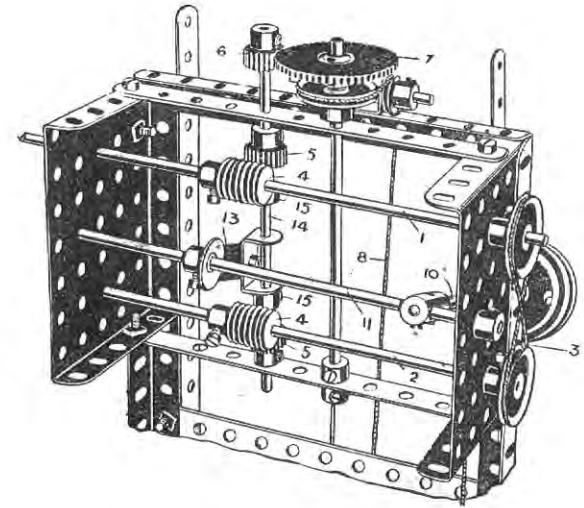
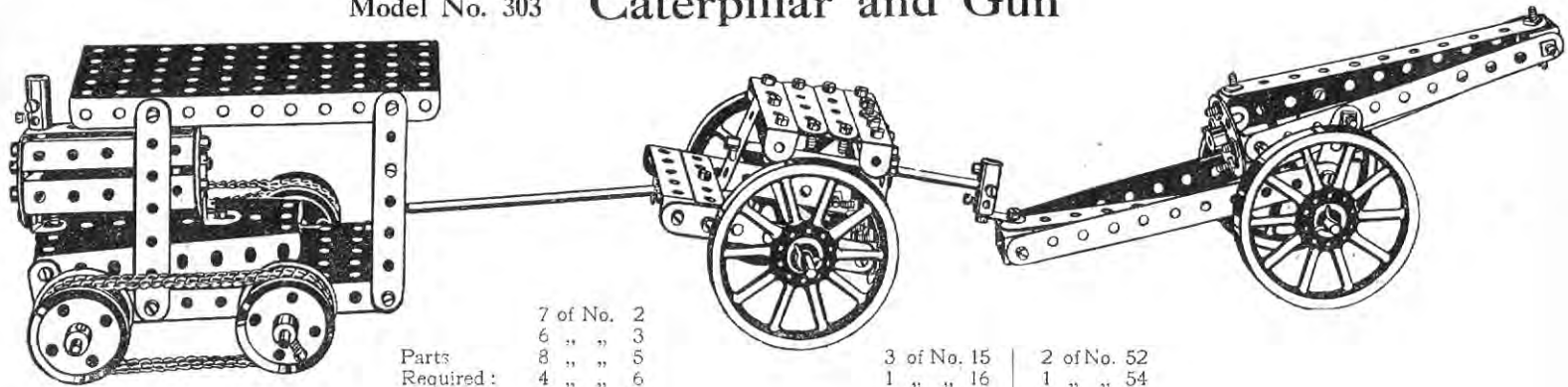

Fig. 302A

The driving spindle 1 and the spindle 2 are connected by a crossed rope 3, so that they rotate in opposite directions. These spindles carry worms 4, one or other of which engages with one of two pinions 5 on a spindle which also carries a pinion 6 engaging a gear wheel 7, which carries a 1" fast pulley round which the traversing cord 8 passes on to the $\frac{1}{2}$ " loose pulleys 9. The weighted spindles 10 at opposite ends of the apparatus are pivotally carried on spindles 11, and are engaged by the carriage 12 at the end of its travel. The spindle 11 carries a crank piece 13 to the end of which is bolted a double bracket sliding on the spindle 14, and engages collars 15 thereon, so that as the weighted spindle 10 is pushed over by the carriage the crank 13 disengages one pinion from its worm and engages the other worms and pinion, thus reversing the direction of rotation of the pinion 6, and consequently of the traversing rope 8.

Model No. 303 Caterpillar and Gun



	7 of No.	2
Parts	6 "	3
Required :	8 "	5
	4 "	6
	1 "	10
	4 "	11
	8 "	12
	2 "	14

	3 of No.	15	2 of No.	52
	1 "	16	1 "	54
	8 "	20	3 "	59
	3 "	24	11 "	60
	4 "	35	2 "	63
	78 "	37	4 "	94

Model No. 304 Rolling Lift Bridge

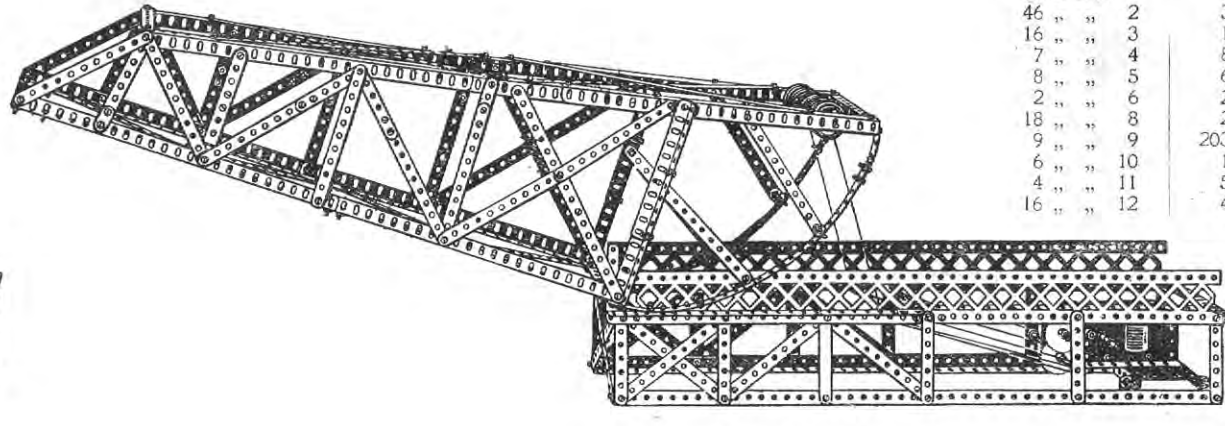

Parts Required:

10 of No.	1	2 of No.	13
46 "	2	3 "	14
16 "	3	1 "	17
7 "	4	8 "	20
8 "	5	6 "	23
2 "	6	2 "	26
18 "	8	2 "	27
9 "	9	203 "	37
6 "	10	1 "	52
4 "	11	5 "	59
16 "	12	4 "	99

Model No. 305 Box Ball Alley

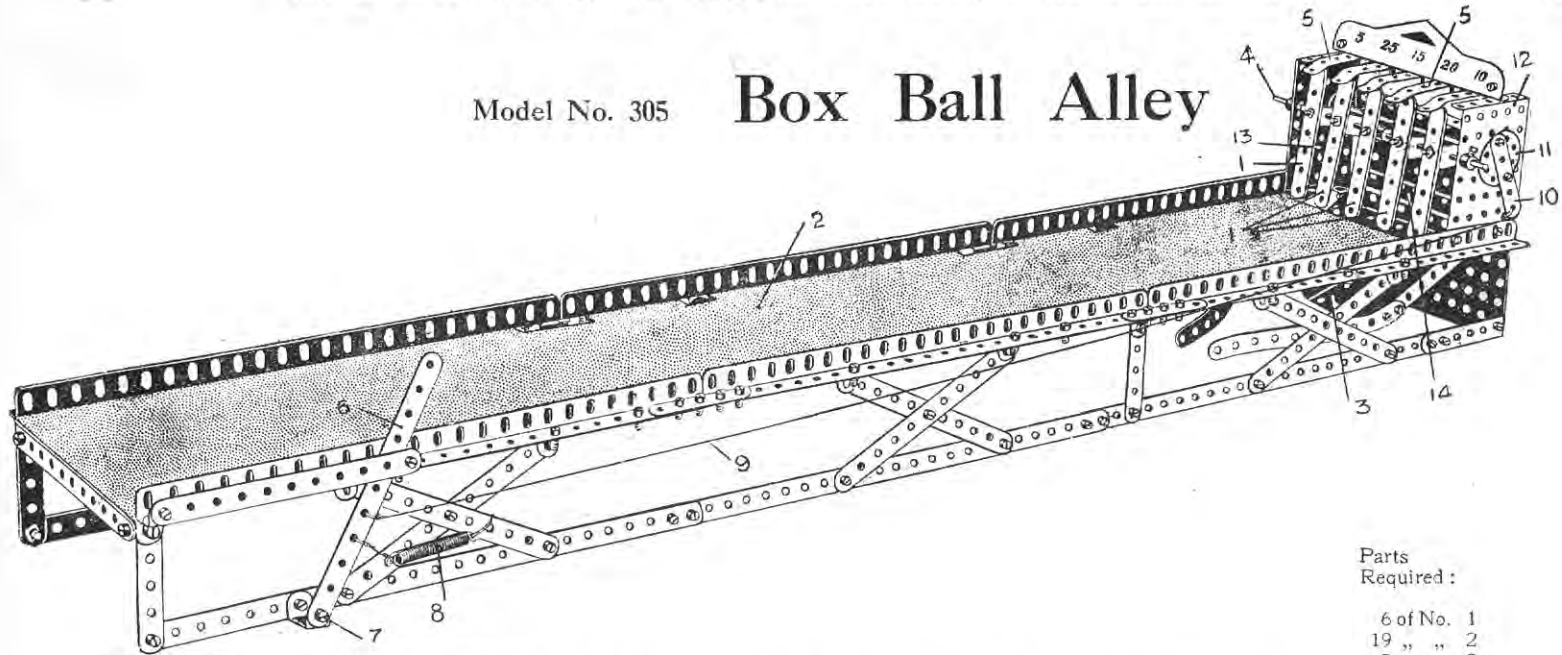

This model gives endless amusement.

The object is to hit one of the strips 1, which have various number values, by means of a ball rolled along the platform 2, the ball after striking and tipping one of the strips being returned by the tray 3 to the player. The strips 1 are pivoted by double bent strips on to a rod 4, so that each strip may swing independently. The upper end of each strip is engaged by strips 5, the ends of which are bent slightly down, as shown, so that while the strips 1 are normally held in the position shown, when one of the strips is struck by the ball it is deflected backward and its upper end snaps outward past the bent end of its strip 5, which thus acts as a spring, the deflected strip being then retained in that position until it is reset. To reset any or all of the strips 1 a handle is formed by a strip 6 pivoted at 7 and controlled by a tension spring 8. A cord 9 connects the strip 6 to a short strip 10 forming a crank and bolted to a bush wheel 11 on an axle journalled in the side plates 12. This axle on its interior carries two further bush wheels to which are secured two short strips 13 forming cranks, a long double bent strip 14 being in turn bolted to the strips 13. When therefore the handle 6 is pulled out against the spring 8 the cord 9 rotates the bush wheel 11 and forces out the long double bent strip 14 which pushes out the strips 1 and resets them in their normal positions. During this resetting operation the upper ends of the strips 1 snap back beneath the bent ends of the spring strips 5.

Parts
Required :

6 of No.	1
19 "	2
5 "	3
2 "	4
15 "	5
6 "	8
5 "	11
27 "	12
1 "	14
1 "	15
2 "	16
1 "	24
8 "	35
132 "	37
1 "	43
2 "	52
2 "	53
2 "	54
2 "	59
2 "	62
1 "	63

Model No. 306

Tunnelling Machine

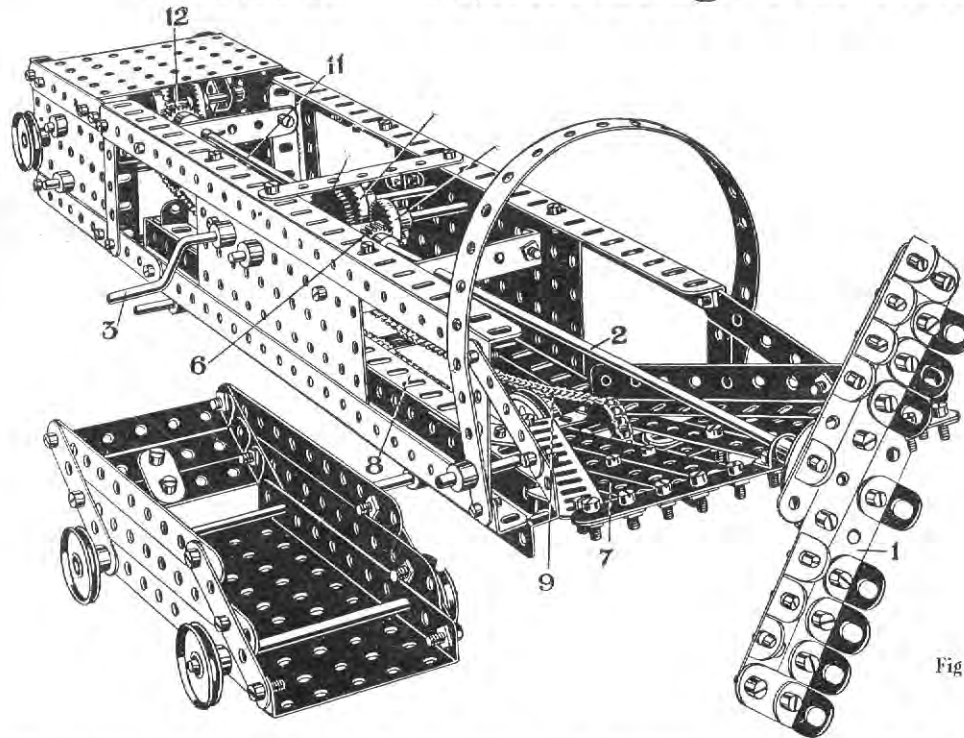
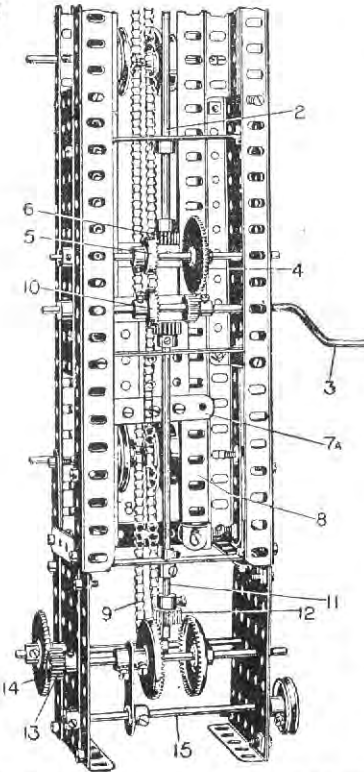

Fig. 306



Parts Required:

1	No.	1
12	"	2
10	"	3
2	"	4
17	"	5
8	"	8
2	"	9
5	"	10
23	"	12
1	"	13
4	"	14
1	"	15
3	"	15A
2	"	16
1	"	19
4	"	20
1	"	21
5	"	22
1	"	25
4	"	26
2	"	27A
2	"	28
2	"	29
4	"	35
103	"	37
1	"	46
1	"	52
3	"	53
12	"	59
3	"	60
1	"	62
2' 6"	"	94
2	"	96

The main boring head 1 is driven by the shaft 2 from the crank 3, on the spindle of which a 20 tooth pinion engages a 56 tooth gear wheel 4 which is fixed on the same spindle as the 25 tooth contrate wheel 5, which is geared with the pinion 6 on the shaft 2. The earth removed by the boring head falls down the slope 7 and is removed by a traversing carriage 7A running on the rails 8 and operated by the chain 9. As the carriage reaches the inner part of its travel it tips by meeting a stop. The carriage is traversed by a large contrate wheel 10 engaging a 20 tooth pinion on the shaft 11, another pinion 12 on this shaft engaging one or other of the contrate wheels which form a clutch for reversing the carriage, the contrate wheels spindle carrying a 25 tooth pinion 13 which engages a 56 tooth gear wheel 14 on the spindle of the rear sprocket wheel carrying the chain. The reversing mechanism is operated by sliding the rod 15.

This Model Can be Made with MECANO
 Outfit No. 6, or No. 5 and No. 5A

Model No. 307 Crane

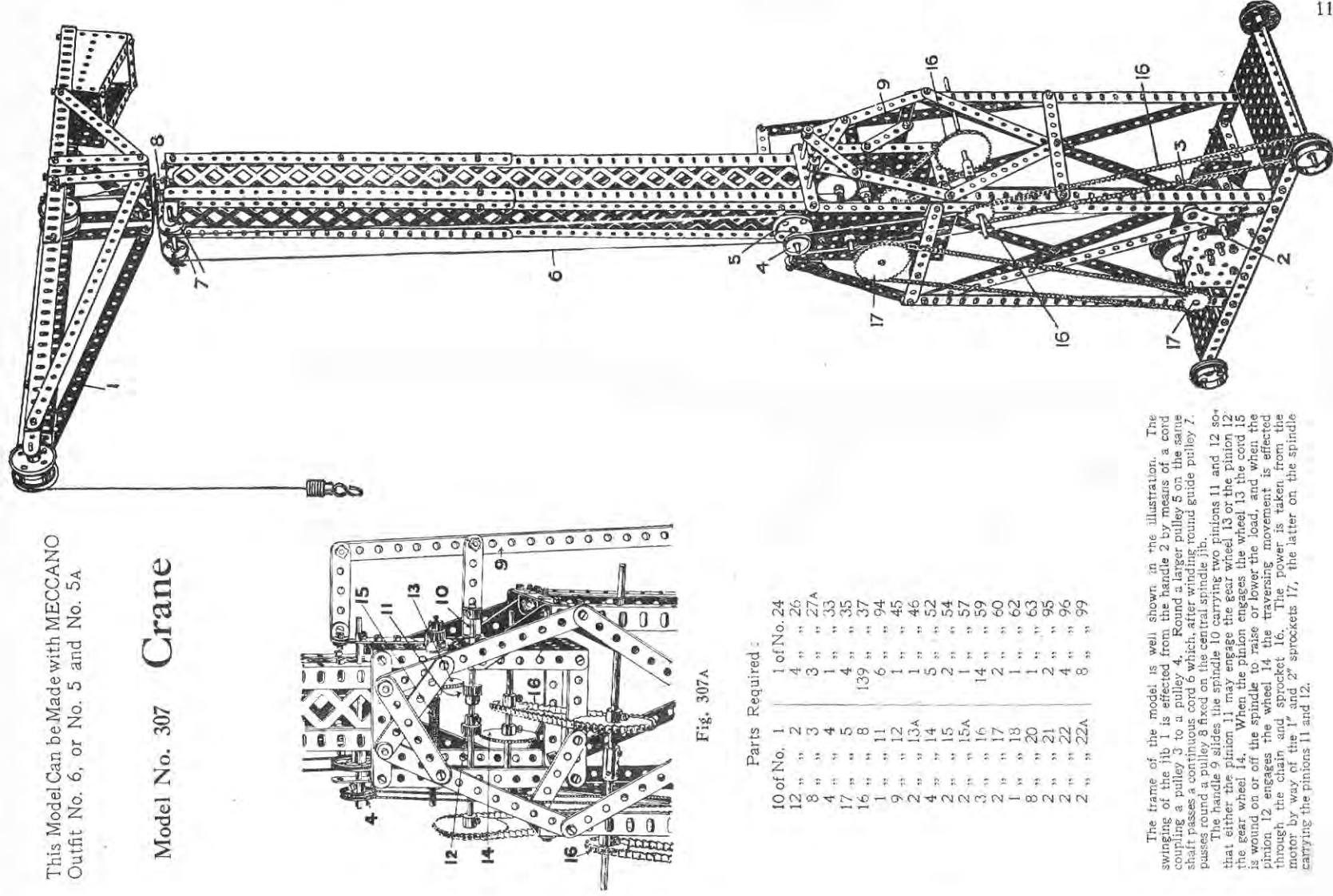

Fig. 307A

Parts Required:

10 of No.	1	1 of No.	24
12 "	2	4 "	26
8 "	3	3 "	27A
4 "	4	4 "	33
17 "	5	4 "	35
16 "	8	139 "	37
1 "	11	6 "	94
9 "	12	1 "	45
2 "	13A	1 "	46
4 "	14	5 "	52
2 "	15	2 "	54
2 "	16	1 "	57
3 "	17	14 "	59
2 "	18	2 "	60
1 "	20	1 "	62
8 "	21	1 "	95
2 "	22	2 "	96
2 "	22A	4 "	99
2 "	22A	8 "	99

The frame of the model is well shown in the illustration. The swinging of the rib 1 is effected from the handle 2 by means of a cord coupling a pulley 3 to a pulley 4. Round a larger pulley 5 on the same shaft passes a continuous cord 6 which, after winding round guide pulley 7, passes round a pulley 8 fixed on the central spindle 10. The handle 9 slides, the spindle 10 carrying two pinions 11 and 12 so that either the pinion 11 may engage the gear wheel 13 on the pinion 12 or the gear wheel 14. When the pinion engages the wheel 13 the cord 15 is wound on or off the spindle to raise or lower the load, and when the pinion 12 engages the wheel 14 the traversing movement is effected through the chain and sprocket 16. The power is taken from the motor by way of the 1' and 2' sprockets 17, the latter on the spindle carrying the pinions 11 and 12.

This Model Can be Made with
MECCANO Outfit No. 6, or
No. 5 and No. 5A

Model No. 308

Helter Skelter

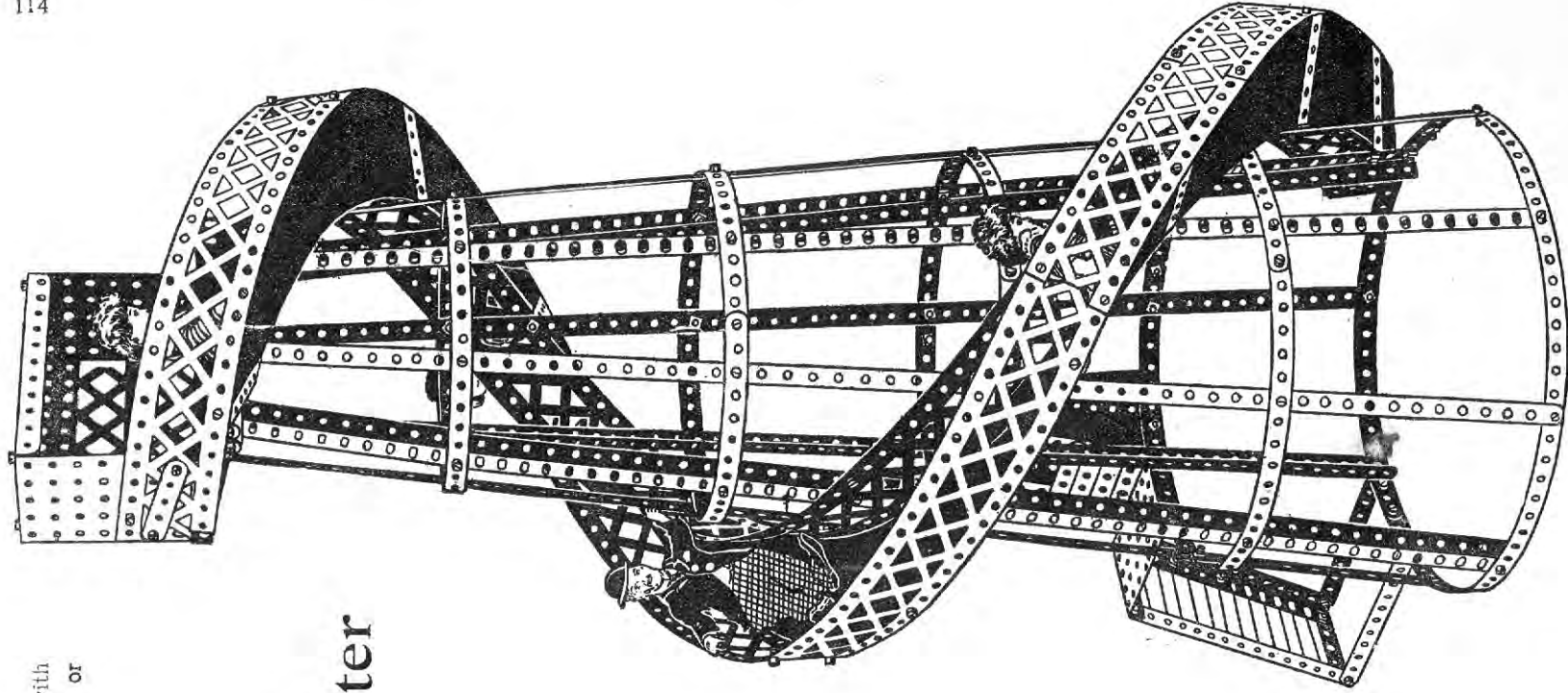

Parts Required :	
21 of No.	1
7 "	2
15 "	5
8 "	8
6 "	9
2 "	10
4 "	12
157 "	37
2 "	52
4 "	53
2 "	54
9 "	60
10 "	99
2 "	100

This Model Can be Made with MECCANO Outfit No. 6, or No. 5 and No. 5A.

Loom

Special Meccano
Model No. 309

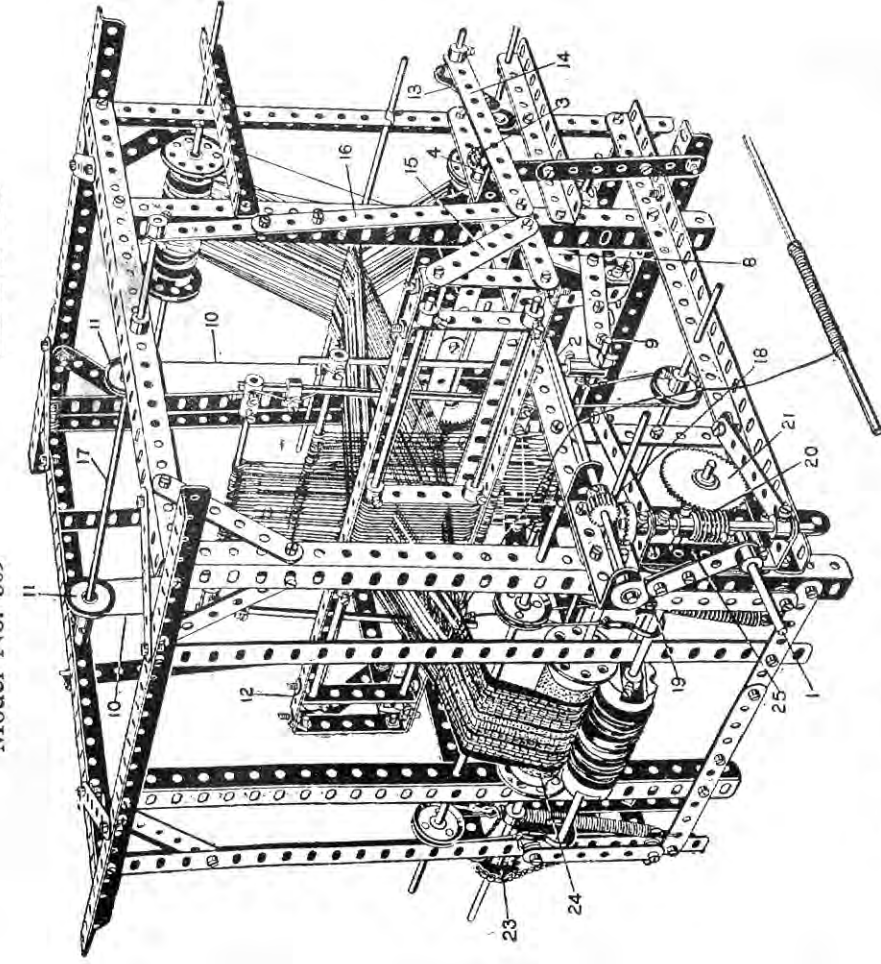

Parts Required:	
4 of No.	1
16 "	2
7 "	3
14 "	4
37 "	5
4 "	6
17 "	8
4 "	9
2 "	11
4 "	12
12 "	13
3 "	13A
8 "	14
2 "	17
2 "	18
4 "	21
4 "	22
2 "	22A
4 "	24
2 "	25
1 "	26
1 "	27
1 "	27A
1 "	28
1 "	29
1 "	32
6 "	35
6 "	37
131	38
60 "	38
3 "	43
3 "	46
2 "	54
2 "	57
25 "	59
4 "	60
6 "	62
9 "	63
1 "	95
1 "	96
72 "	101
4 "	106

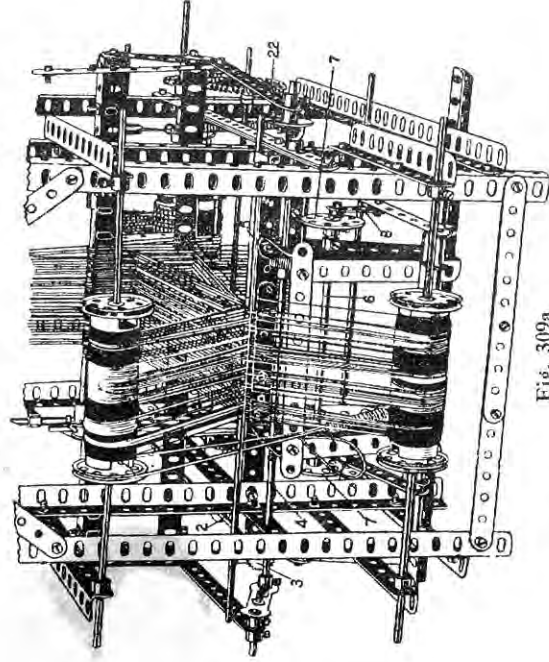

Fig. 309a

TAKE-UP MORTON.—A pinion 18 engages a contrate wheel 19 on the same axle rod as the worm 20 which drives the gear wheel 21, on the other end of the spindle of which is a sprocket wheel 22 driving another sprocket 23 on the spindle of the sand roller 24. The warp threads may be threaded through the reed spaces in pairs. In order to bring the spindle of the worm 20 into alignment with the shaft 2 the large double bent strip 25 is packed up by four $\frac{3}{8}$ " strips. For preparing the beam rollers see Model No. 317.

First build up the framework as shown. The loom is operated from the main crank handle 1, rotating the shaft 2.

HEALD FRAMES.—On the end of shaft 2 is a pinion 3 gearing with a $\frac{3}{8}$ " contrate wheel on shaft 4, a 26-tooth pinion 5 on which engages a 50-tooth gear wheel on shaft 6. This shaft carries at both ends bush wheels 7 to which are pivoted 2" strips 8 connected to two strips $5\frac{1}{2}$ " by 2" overlapped, which are in turn pivoted to the lower rod 9 of the rear heald frame. Both heald frames are connected by cords 10 passing over pulley wheels 11.

REED FRAME.—The reed frame 12 which beats up each thread of the weft is actuated from the shaft 4 by cranks 13 formed of two cranks bolted together and pivoted by a 1" rod to two $5\frac{3}{8}$ " strips 14 one at each side of the loom, which are pivoted to the bracketed end 15 of the reed frame and to swinging strips 16 hanging from the rod 17.

Model No. 310

Derrick

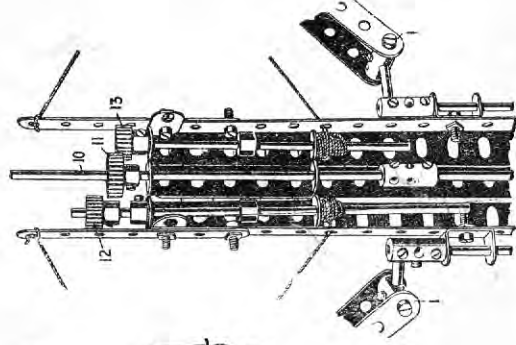
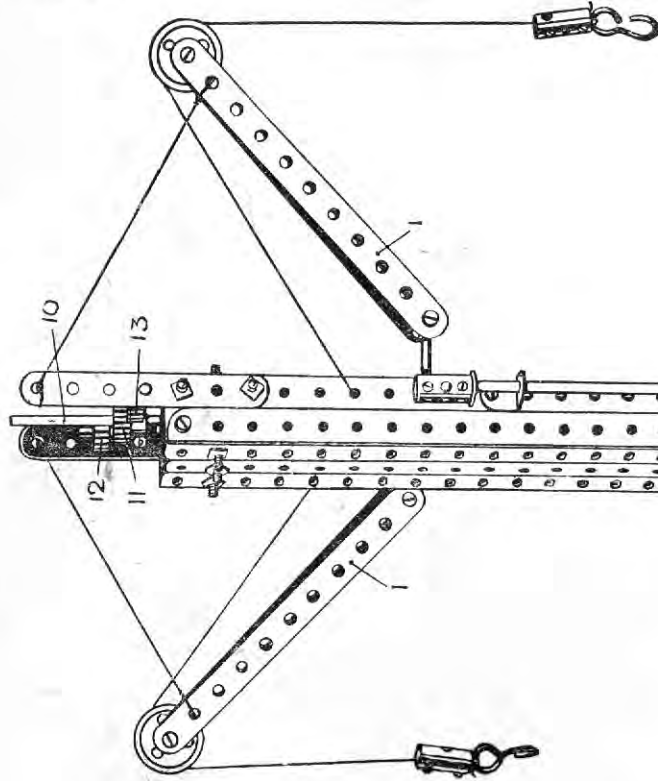

Fig. 310A

Parts Required :

2 of No. 1	3 of No. 14	3 of No. 35
6 " " 2	2 " " 15	63 " " 37
6 " " 3	2 " " 18	1 " " 45
2 " " 4	2 " " 19	3 " " 52
4 " " 8	4 " " 20	2 " " 57
12 " " 10	2 " " 22A	12 " " 59
3 " " 11	5 " " 26	3 " " 60
14 " " 12	2 " " 28	7 " " 63
3 " " 13	2 " " 29	
2 " " 13A		

The swinging of the jibs 1 is effected from the handle 2 by sliding the pinion 3 until it engages with one or other of the contrate wheels 4 on the vertical spindles 5. The hoisting and lowering of the load from either of the jibs is effected from the handle 6a, the pinion 7 on which is engaged with one or other of the contrate wheels 8 by the clutch operating strip 9; movement of the strip 9 raises the centre spindle 10 and causes its pinion 11 to engage one or other of the pinions 12, 13, in the spindles of which the hoisting cords are wound.

Model No. 311

Electric Loco

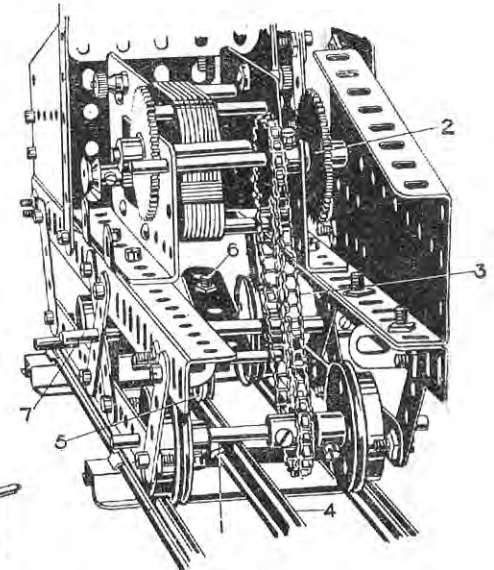
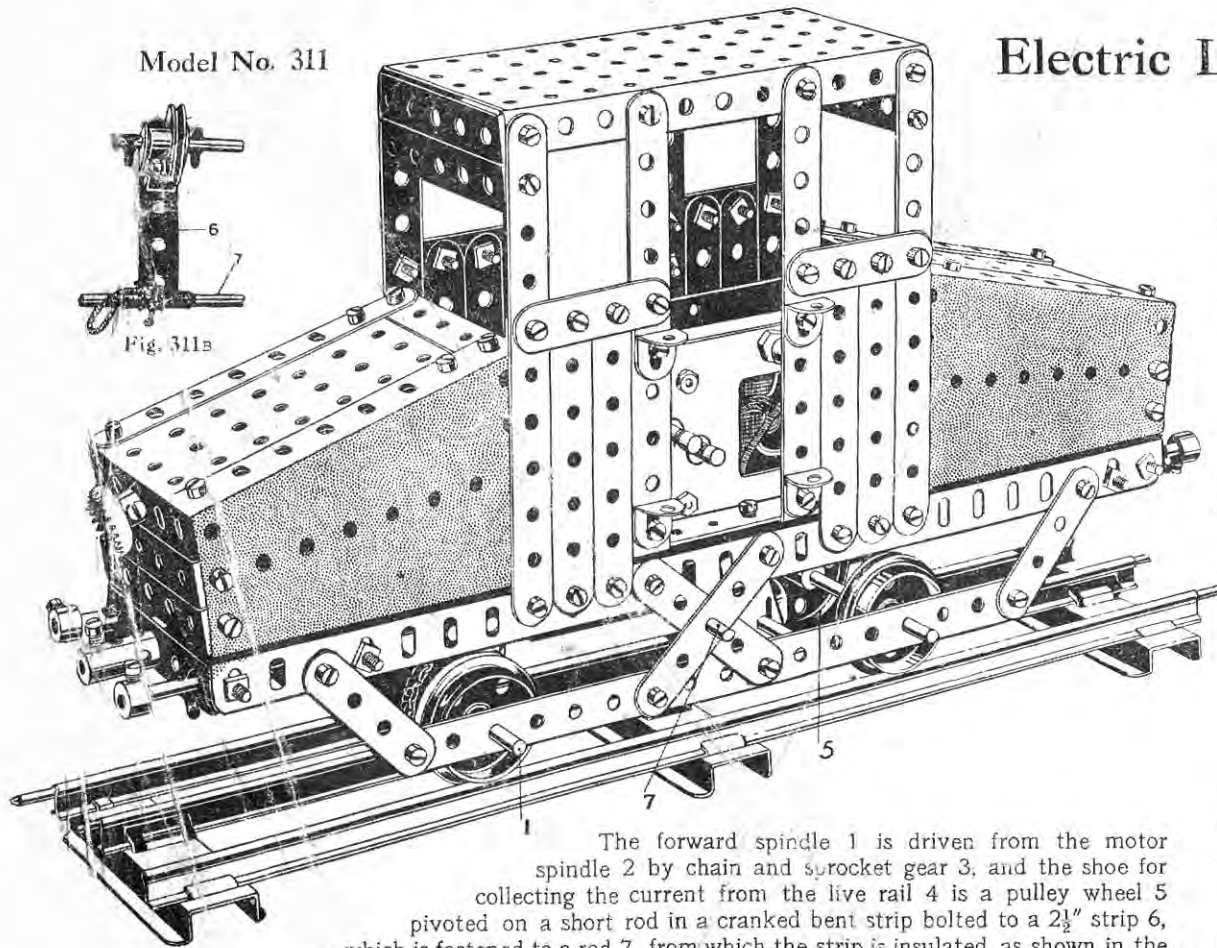

Fig. 311A

The forward spindle 1 is driven from the motor spindle 2 by chain and sprocket gear 3, and the shoe for collecting the current from the live rail 4 is a pulley wheel 5 pivoted on a short rod in a cranked bent strip bolted to a 2½" strip 6, which is fastened to a rod 7, from which the strip is insulated, as shown in the detail (Fig. 311b). The positive electric wire is led from the strip 6 to the motor terminal, the running wheels forming the negative return of the circuit.

Parts Required :

12 of No. 2	3 of No. 17	1 of No. 52
8 " " 3	1 " " 18	2 " " 53
11 " " 5	4 " " 20	4 " " 54
8 " " 6	1 " " 22	5 " " 59
2 " " 8	1 " " 29	10 " " 60
12 " " 12	2 " " 35	1 " " 63
2 " " 15A	97 " " 37	9 " " 94
4 " " 16	1 " " 44	2 " " 96

Model No. 312 Radial Travelling Crane

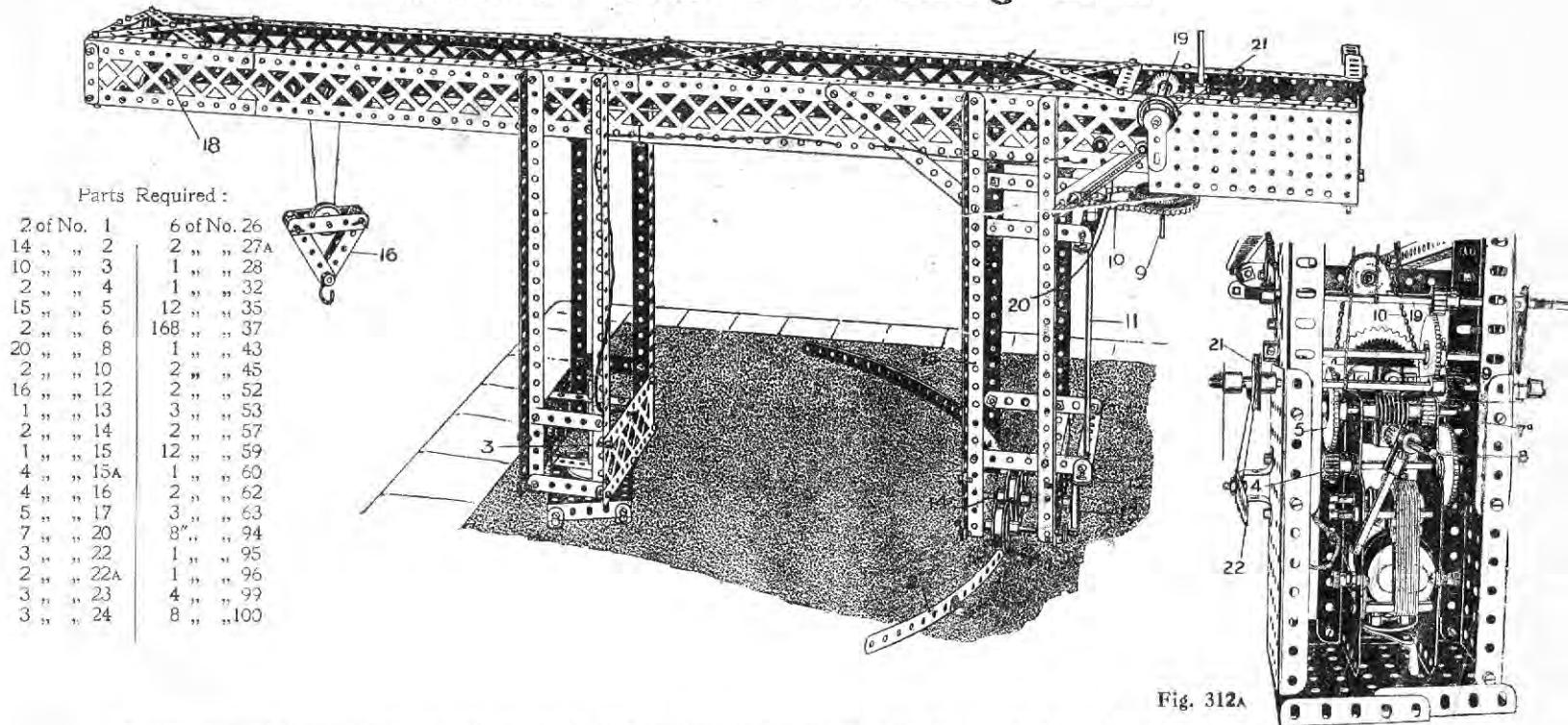
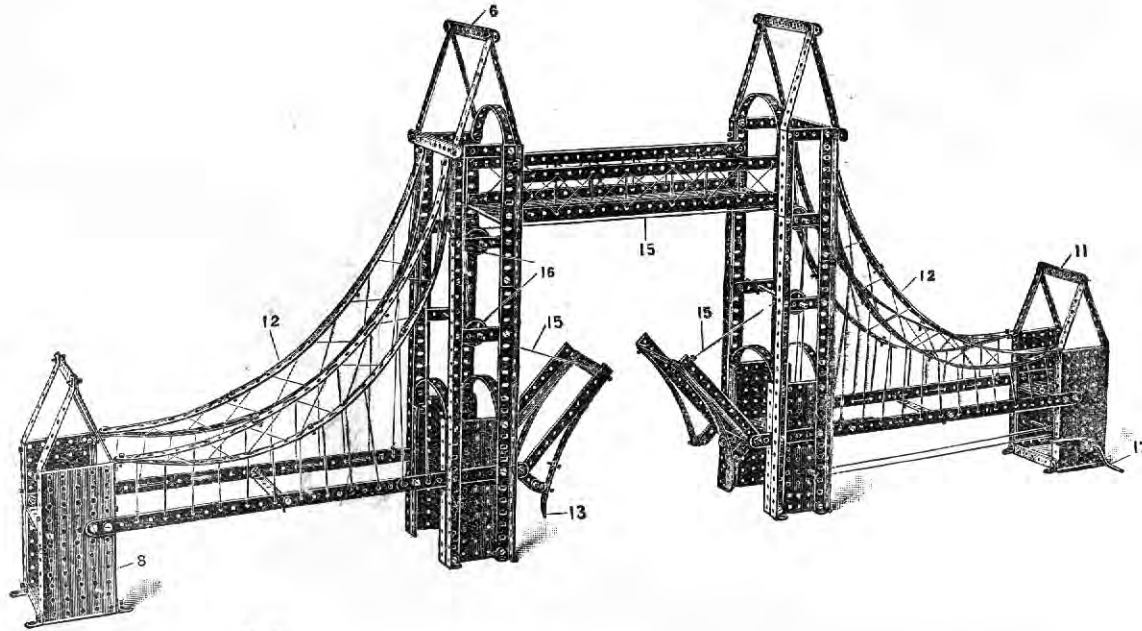

Fig. 312A

The structure of the crane runs on the rear wheels 1 on the circular rail 2 about the central pivot 3. The radial travelling movement is effected from the motor spindle, the pinion 4 of which gears from the secondary wheels 5 with a gear wheel driving a worm 7 which engages a pinion on a vertical spindle 8, at the foot of which is a pinion engaging with a gear wheel on the spindle 9, geared by chain and sprocket wheels 10 to a spindle 11, a pinion 12 on which drives a contrate wheel 13 keyed to the rod 14, on which is the central rolling spindle of the crane leg 15. If a few turns of cord are wound round this central pulley a better bite is obtained on the rail edge 2. The bearings of spindles 8 and 9 are carried in double bent strips secured to transverse strips bolted to the side flanged plates. The traversing mechanism of the carriage which supports the pulley block 16 is effected from the worm shaft 7, a $\frac{1}{8}$ " pinion 7a on which drives a $\frac{3}{4}$ " pinion 17, on the spindle of which is a continuous cord which traverses the frame. This cord passes round the pulley 18 at the extreme outer end of the crane jib. The hoisting rope is driven similarly from the pinion 7a, the hoisting cord winding on and off the rod 19. A brake for the spindle of the winding rod 19 is provided by a cord passing round a 1" pulley 21 and connected to a lever 22.

Model No. 313 Tower Bridge



Parts
Required :

22 of No. 1	12 of No. 9	2 of No. 26	2 of No. 43
34 " " 2	23 " " 12	1 " " 27	2 " " 46
12 " " 3	6 " " 15	1 " " 33	8 " " 52
12 " " 5	1 " " 19	9 " " 35	4 " " 53
10 " " 8	6 " " 22	163 " " 37	1 " " 59

Model No 313 Tower Bridge *(continued)*

Begin by making the two main towers, the construction of one of which is shown in Fig. 313A. The four uprights 1 are made of angle girders, connected at their lower extremities by large flanged plates 2 and transverse strips 3. The sides of the tower are connected together by a small flanged plate 4 across the top of which and at the top of the tower are bolted bent $5\frac{1}{2}$ " strips.

The top gable 6, constructed as shown, is then bolted at its lower edges 7 to the top of the uprights.

The short end towers, one of which is shown to the right of the figure, are built up from two large flanged plates 8 connected together by a small flanged plate 9 and two $3\frac{1}{2}$ " strips 10, the gable 11 being then bolted on top.

The catenary member 12 is built up from four curved $12\frac{1}{2}$ " strips overlapped, the lower member by 12 holes and the upper member by 15 holes, so as to produce a longer sweep in the lower member, and are bolted to the vertical angle girders of the higher towers, and by angle brackets to the shorter towers.

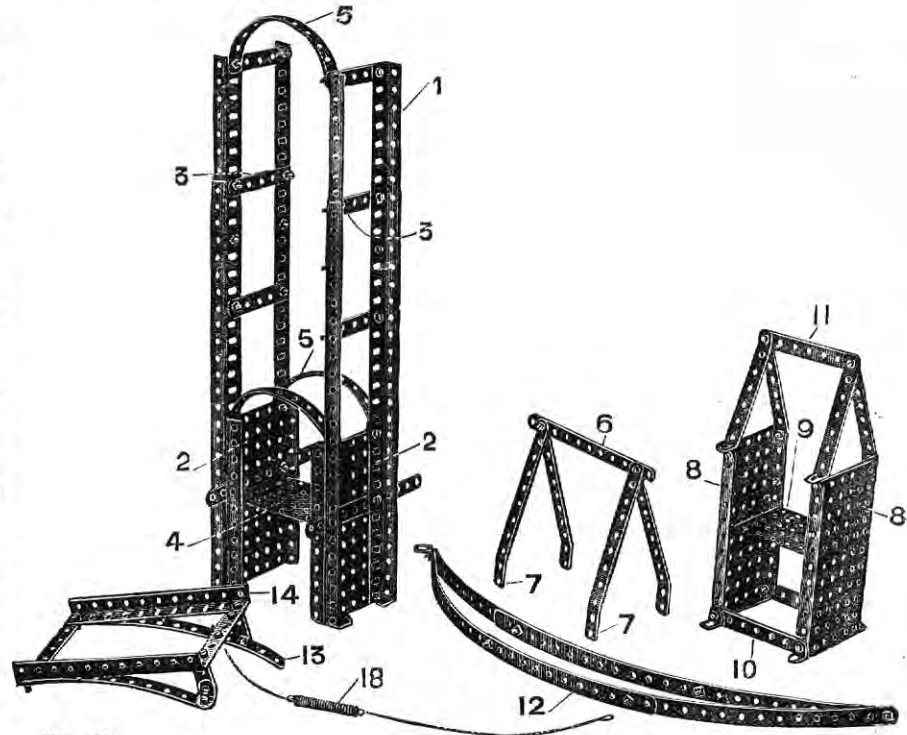

Fig. 313A

The bascules as illustrated in the left-hand corner of the picture are built up of two $5\frac{1}{2}$ " angle girders braced with transverse $3\frac{1}{2}$ " strips, and reinforced with bent $5\frac{1}{2}$ " strips, one of which is provided with a projecting $2\frac{1}{2}$ " strip 13, which bears against the main tower and acts as a stop when the bascules are horizontal. The bascules are hinged by fixing bolts in the end holes 14, and are opened by the cords 15 passing over the guide pulleys 16, and are controlled by the extension spring 18, which normally acts to return them to their closed position. In the right smaller tower is the operating handle 17, on which is secured a $\frac{3}{4}$ " pinion meshed with a gear wheel on the spindle, on which the operating cords 15 are wound.

Model No. 314

Parts Required :

38 of No. 1	4 of No. 23
49 " " 2	3 " " 24
17 " " 3	4 " " 26
23 " " 4	2 " " 27A
14 " " 5	2 " " 29
23 " " 8	1 " " 32
12 " " 9	14 " " 35
2 " " 11	411 " " 37
80 " " 12	1 " " 45
2 " " 13	1 " " 46
4 " " 14	5 " " 52
6 " " 15	8 " " 53
8 " " 20	4 " " 59
1 " " 21	2 " " 60
6 " " 22	

Funicular Railway

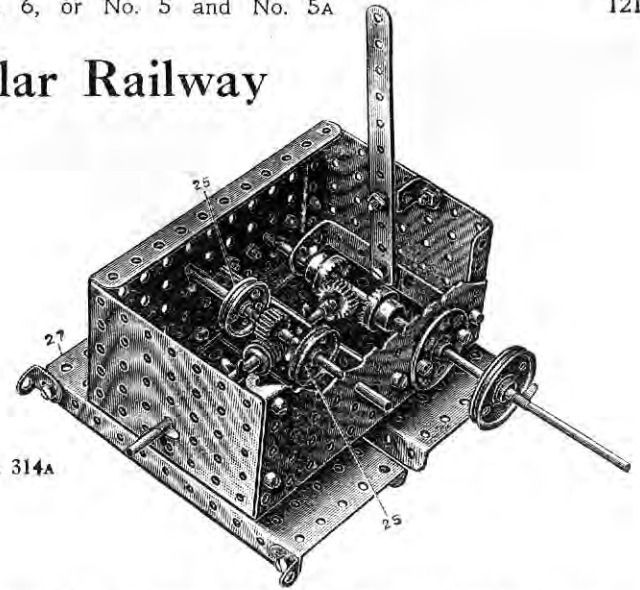
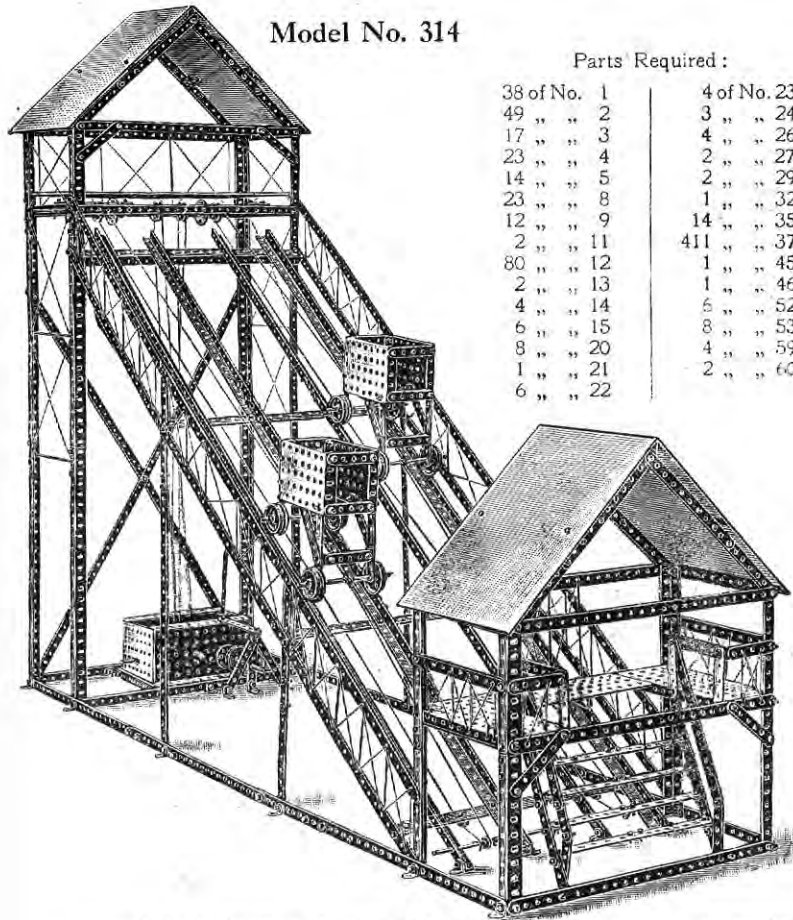

Fig. 314A

Begin by constructing the main tower, the corner pillars of which are made from two $12\frac{1}{2}$ " angle girders and a $5\frac{1}{2}$ " angle girder ; the $12\frac{1}{2}$ " girders overlapped three holes and the $5\frac{1}{2}$ " girders two holes. The rear diagonal ties are made from $12\frac{1}{2}$ " strips overlapped. The roof rafters consist of $5\frac{1}{2}$ " strips overlapped five holes.

The inclined rails are made from 4 sets of $12\frac{1}{2}$ " angle girders, butted together and connected by 3" strips. The rails rest on three upper crossing $12\frac{1}{2}$ " angle girders, and a lower $12\frac{1}{2}$ " strip to the ends of which are bolted the latticed side rails supported by the vertical members. The loading platform is built up from $5\frac{1}{2}$ " girder strips to which are bolted side flanged plates which are again connected by two small flanged plates. The other constructional details of this loading tower should present no trouble.

The main tower, inclined rails, and loading platform are now coupled together by a series of horizontal $12\frac{1}{2}$ " strips overlapped as shown.

The wagons are made as follows : Two small flanged plates are connected top and bottom by $2\frac{1}{2}$ " strips. The journals for the front axle are made by two $3\frac{1}{2}$ " strips bolted inside the flanged plates, the axle being threaded through their lower projecting holes. The rear axle journals are made by carrying down two $3\frac{1}{2}$ " strips bolted in their

upper holes to the flanged plates, and braced with the diagonal strips to the sides of the wagon. The axle is again threaded through the lowest holes. One end of the operating cord as shown in this view is secured to this rear axle ; the other end, after passing round the pulleys is secured to the front axle. The gear box or operating the main hauling shaft is very fully shown in Fig. 314A. the operating cords from the pulleys 25 passing round the pulleys in the upper gear platform.

The Gear Box is mounted on two perforated plates 27, the angle brackets on which are bolted to the transverse strips at the base of the tower.

Model No. 315

Meccanograph

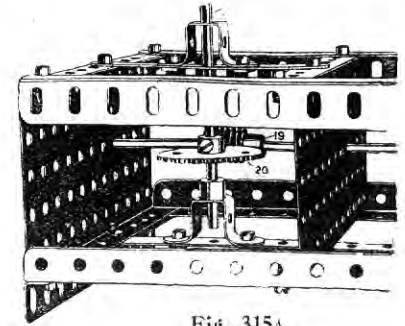
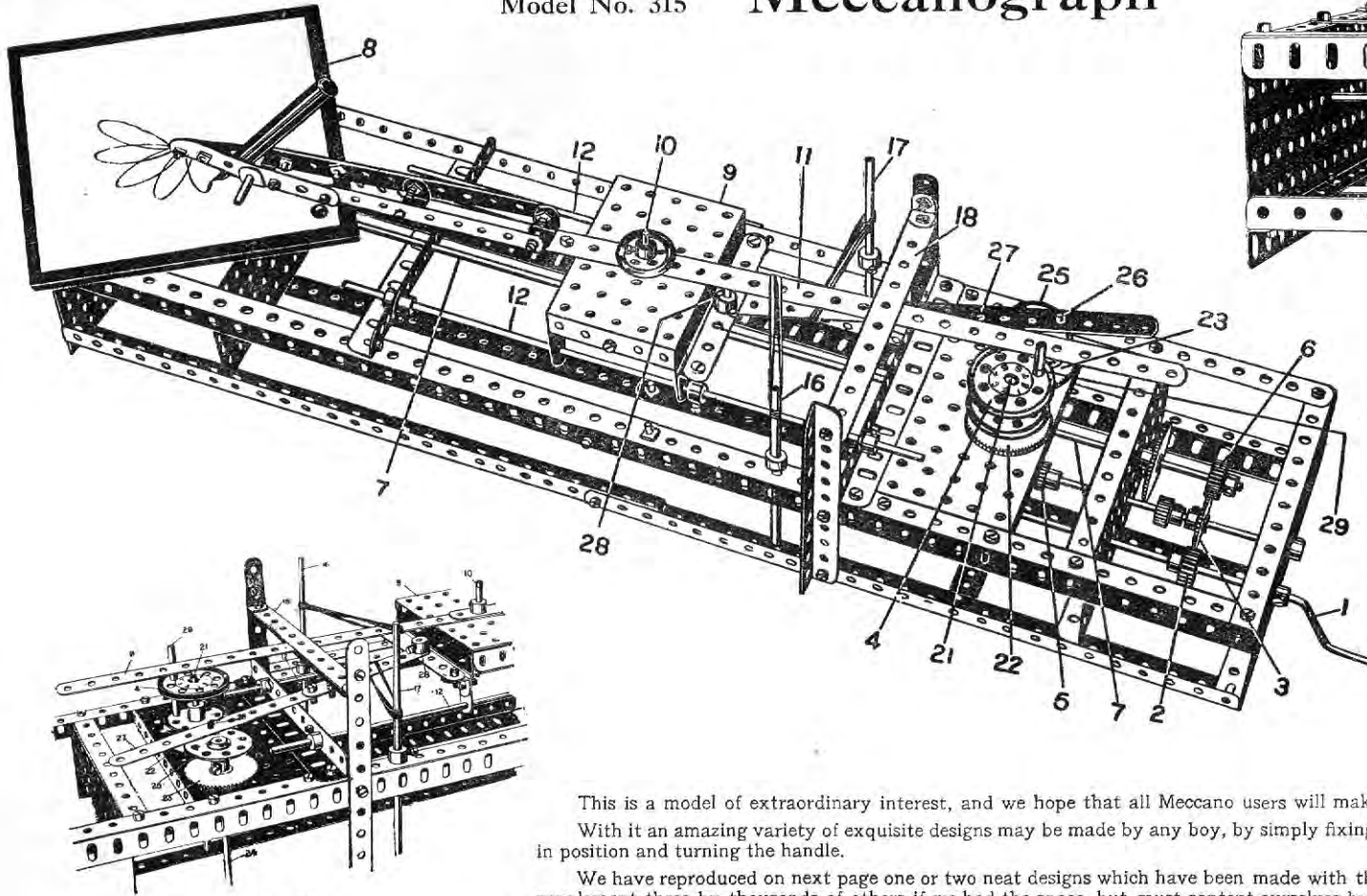

Fig. 315a

Parts Required:

3 of No.	1	1 of No.	24
8 "	2	2 "	25
5 "	3	2 "	26
8 "	8	1 "	27
5 "	9	4 "	27A
3 "	11	1 "	28
4 "	12	1 "	32
4 "	13	87 "	37
2 "	14	2 "	38
1 "	15	2 "	45
1 "	15A	2 "	46
2 "	16	5 "	52
5 "	17	2 "	53
1 "	19	15 "	59
2 "	21	1 "	63
1 "	22	1 "	107

Fig. 315b

This is a model of extraordinary interest, and we hope that all Meccano users will make it up for themselves. With it an amazing variety of exquisite designs may be made by any boy, by simply fixing a sheet of paper and pencil in position and turning the handle.

We have reproduced on next page one or two neat designs which have been made with this instrument, and we could supplement these by thousands of others if we had the space, but must content ourselves by saying that there is no limit whatever to the variety and beauty of the designs which can be made by simply varying the adjustments.

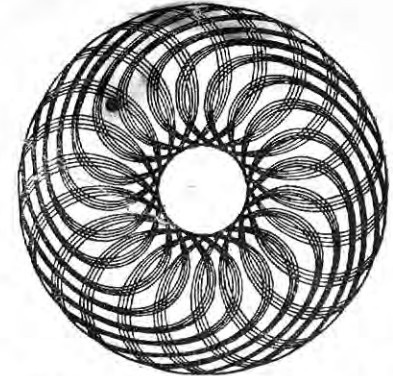
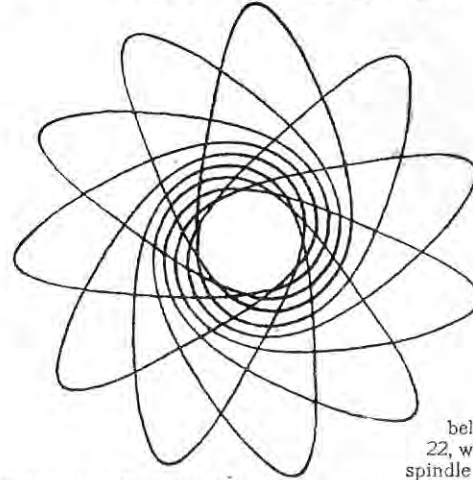
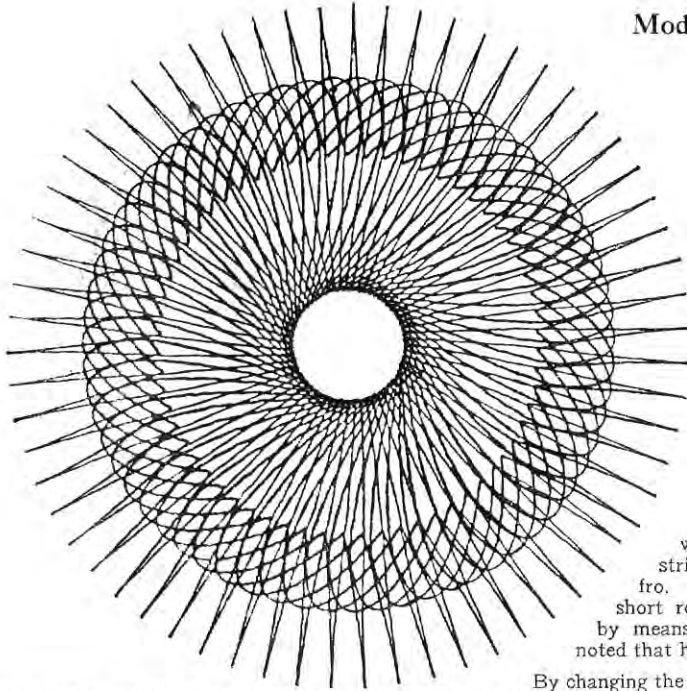

The upright spindle 21 is driven by gearing, but below the crown head is fitted a 56-toothed gear wheel 22, which meshes with a similar gear wheel 23. On the spindle 24 of this latter gear wheel is secured a bush strip 27 pivotally connected at 28 to the carriage. As the bush wheel 25 rotates it slides the carriage to and fro. The arm 11 pivotally mounted on the rod 10 of the carriage is transversely moved by the action of a short rod 29, fitted in one of the holes of the crown head 4. These holes in the crown head are numbered by means of a paper disc, which may be gummed on to the wheel. In fitting up the instrument it should be noted that hole No. 1 comes directly opposite to bolt 26.

By changing the position of the rod 29 while the bolt 26 engages the same perforation in the strip 27, a different design will be obtained. Similarly by altering the position of the pivot 10 on the carriage the designs may be further varied. The strip 27 may also be caused to engage by any of its perforations with the bolt 26.

TABLE.—The table has a bush wheel screwed on the underside, and is secured on the upright spindle 21 by the set-screw of the bush wheel.

CARRIAGE.—The carriage 9 slides along the rods 12, or is secured to them by collars and set-screws, its position being decided by the adjustment of the arm 11 according to the designs to be produced.

ARM.—The arm 11 is formed of two $1\frac{1}{2}$ in. strips bolted together, on which a $5\frac{1}{2}$ in. strip overlapped 7 holes is fastened. The holder is connected to this $5\frac{1}{2}$ in. strip by means of double brackets. The near end of the arm 11 slides between two $5\frac{1}{2}$ in. strips 18, which are spaced with washers to permit a free movement.

To overcome any slack movement of the arm when working, thin rubber bands are passed around it and connected with upright rods 16 and 17.

Care should be taken to see that all parts of the model work smoothly, and that no jolting takes place, otherwise the lines of the design will be uneven.

The Meccanograph is driven from the handle 1 on which is a 25-toothed pinion 2 engaging a 50-toothed gear wheel 3 on the axle of which is a 20-toothed pinion 5 engaging an inverted crown wheel on the spindle 21. The gear wheel 3 drives a 25-toothed pinion 6 on an axle rod 7 extending along to the table, and by means of a worm 19 (see Fig. 315A) drives a 56-toothed gear wheel 20 on the upright spindle to which the rotating table is fixed.

Meccano users who are interested in this model should purchase the full Meccanograph manual (post free 8d.), which contains full detailed instructions and a full range of illustrations with formulae.

Model No. 316 Theatre

This Model Can be Made with MECCANO
 Outfit No. 6, or No 5 and No. 5A

Parts

Required :

17 of No.	1
7 " "	2
10 " "	8
1 " "	13
1 " "	16
1 " "	18
1 " "	22
2 " "	35
91 " "	37
1 " "	44
2 " "	46
2 " "	54
2 " "	59
1 " "	60
1 " "	95
1 " "	96
6 " "	99
6 " "	100

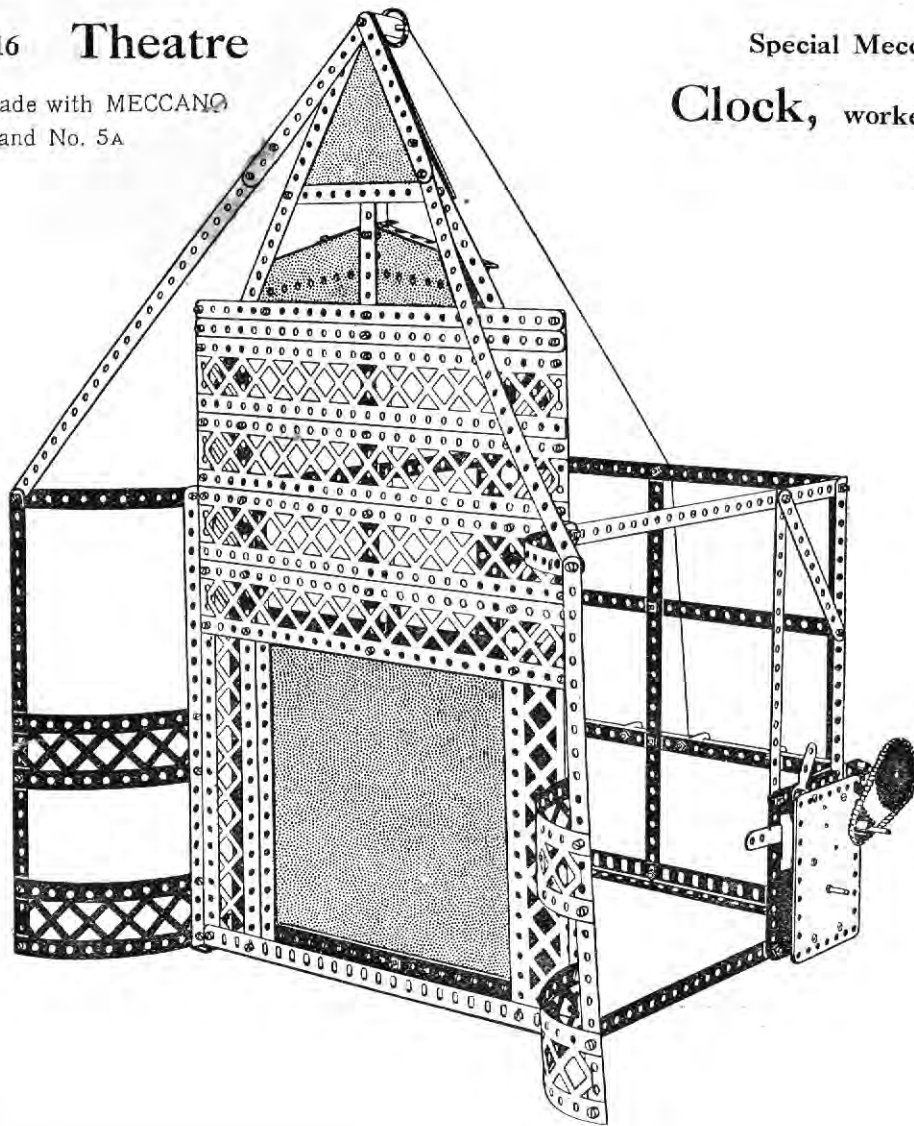

Special Meccano Model No. 317

Clock, worked by weights

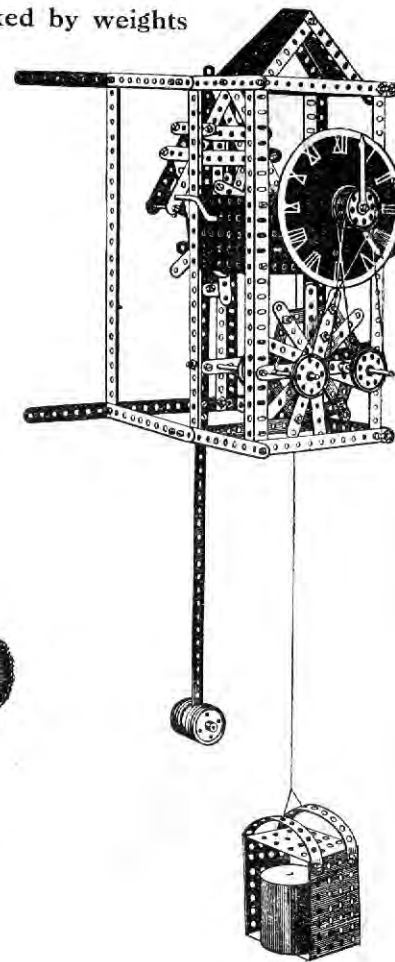

Loom

Special Meccano Model No. 318

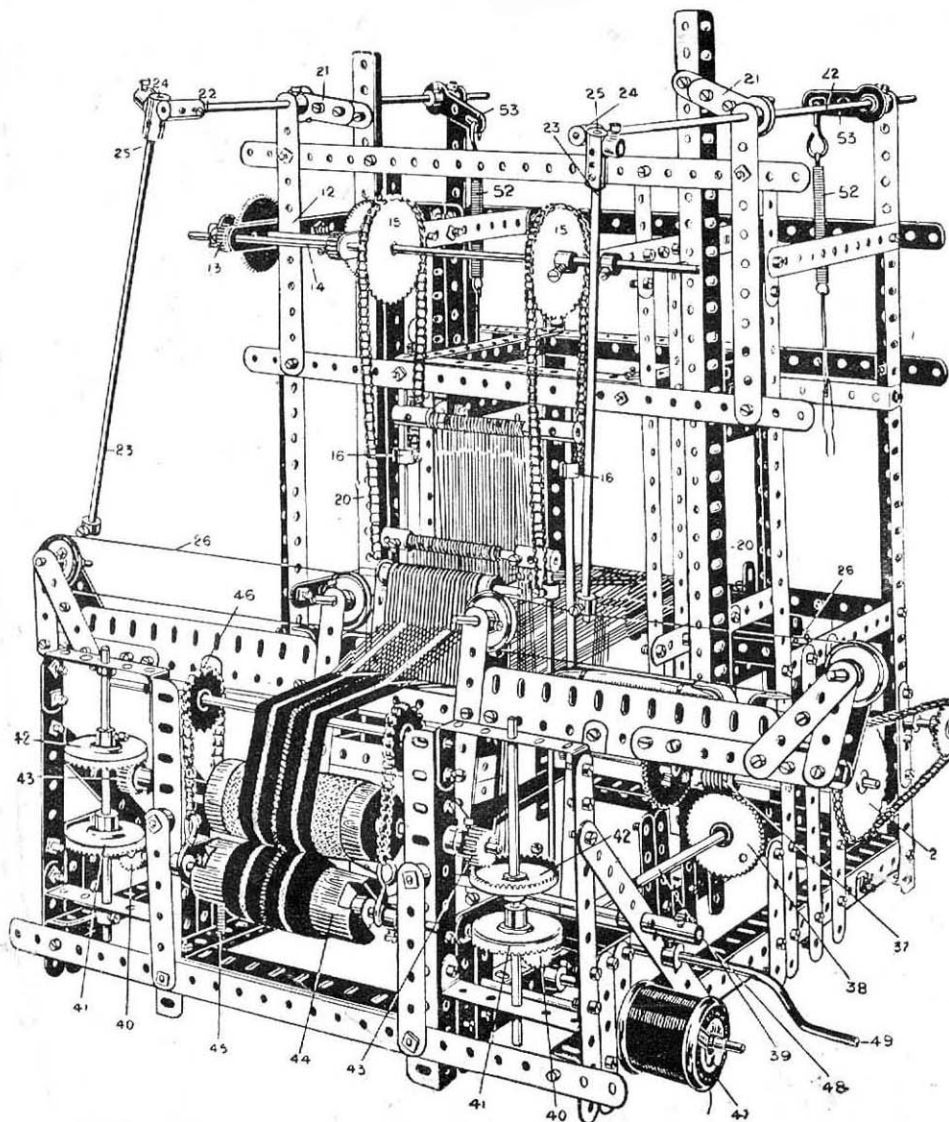

Parts Required:	13 of No. 1	9 of No. 14	5 of No. 26	8 of No. 60
	32	3	4	13
	12	1	5	13
	8	6	4	3
	38	4	2	3
	16	3	270	60
	12	2	50	4
	10	8	8	1
	14	4	2	4
	10	2	6	
	7	4	8	
	9	6	36	
	2	15	27	62
	3	15A	27A	63
	4	16	28	95
	5	17	32	96
	6	18	37	101
	8	19	38	103
	9	21	43	104
	11	22	44	106
	12	23A	46	
	13	24	57	
	13A	25	59	

The main framework of the loom is made up as shown in Fig. 318A, both sides being similar in construction. When the framework is built the driving mechanism is inserted as illustrated in Fig. 318B, both sides being again similar in the arrangement of the gears. The loom is operated from the crank handle 1 gearing by sprocket chains to a 2" sprocket wheel 2 on a rod 3, two 25-toothed pinions 4 which gear with 50-toothed wheels 5 on an 11½" rod 6 which carries the cams 7 (Fig. 318c) for operating the heald frames and the picking sticks.

HEALD FRAMES.—On the end of rod 6 which is extended by a coupling and 1" rod 8 which is coupled by two 5½" strips 9 bolted together to a 2½" strip 10 clamped between two cranks 11 secured on a rod 12, 56-toothed gear wheels on which drive 20-toothed pinions 13 on another rod 14 which carries sprocket wheels 15, the ends of the chains round which are connected to collars 16 on the heald frames (Fig. 318b); the lower ends of the frames are connected by cords which pass round ½" pulleys 17.

PICKING MOTION.—The cams (Fig. 318c) on the rod 6 are oppositely arranged and lift alternately the doubled 5½" strips 18 at each side pivoted at 19 and pivotally coupled at their outer ends to 12½" angle girders 20, which are in turn pivotally bolted at the top to a 2" strip clamped between two cranks 21 secured on rods 22. These rods are connected to the picking sticks 23 by two couplings, one 24 fixed on the rod 22 and another 25 fixed on the picking sticks, 1" rod passing loosely through the couplings 25 and being fixed in the couplings 24. The picking sticks are connected to the cords 26, which carry the double bent strips engaging the shuttle, and pass round the pulleys 27.

THE SLAY.—This is built up of two angle girders overlapped, and the sides are made of two 5½" flat unbent girder strips. The floor of slay channel is covered by a narrow strip of metal to allow the shuttle to slide smoothly across. A rod 28 driven from pinions 4 carries 50-toothed gear wheels 5 which mesh with 25-toothed pinions 29 on a rod 30, cranks 31 on which are connected by 3½" strips 32 to other

Loom—Continued



Fig. 318c

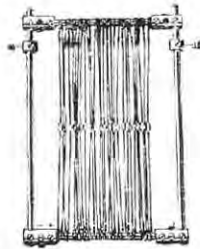

Fig. 318d

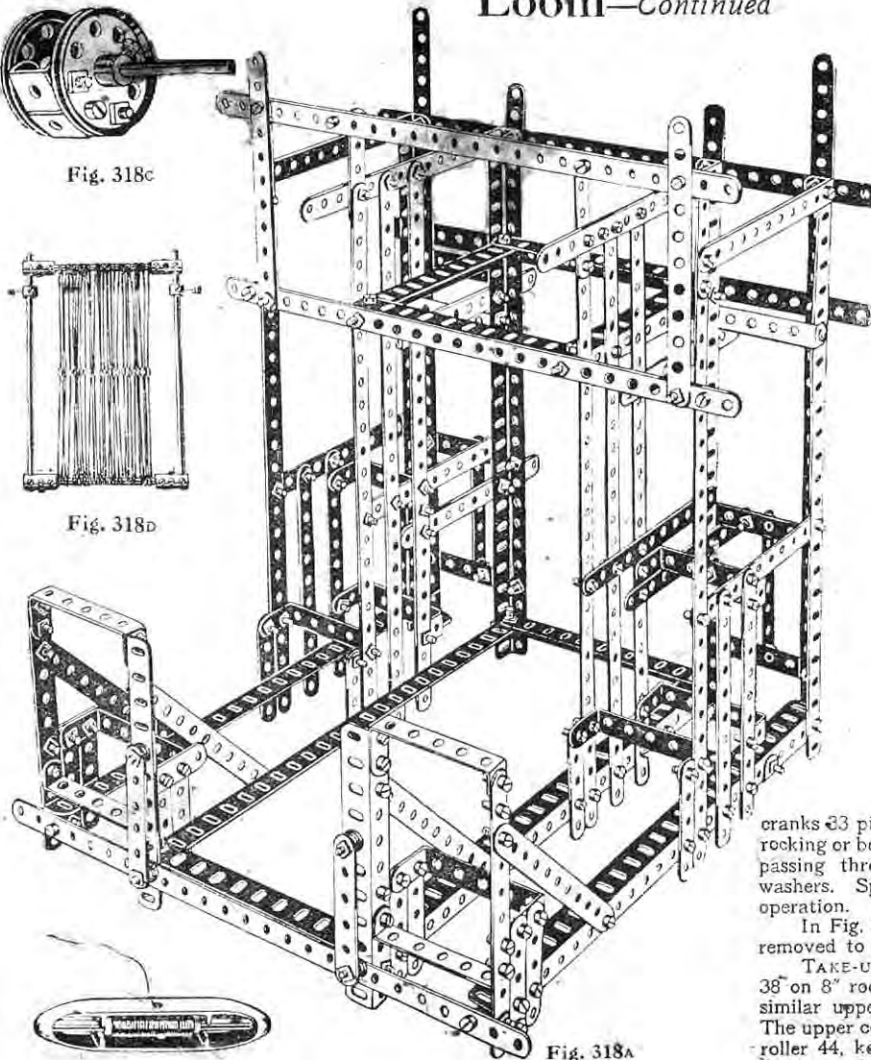

Fig. 318a

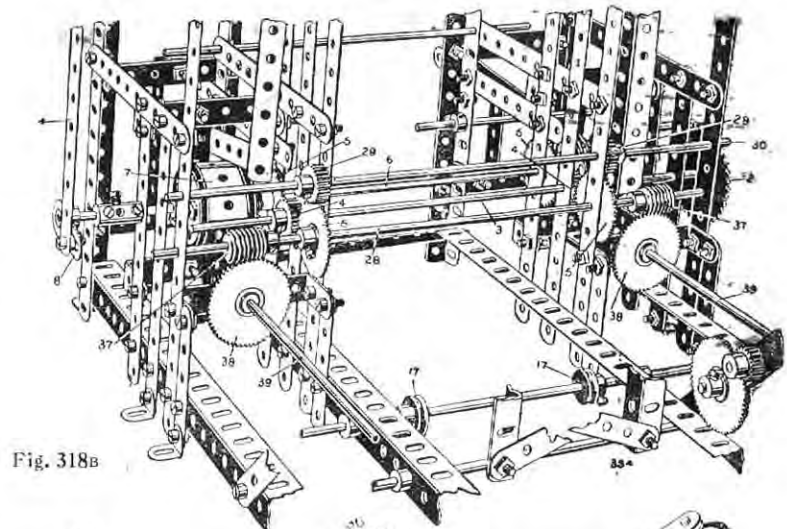

Fig. 318b

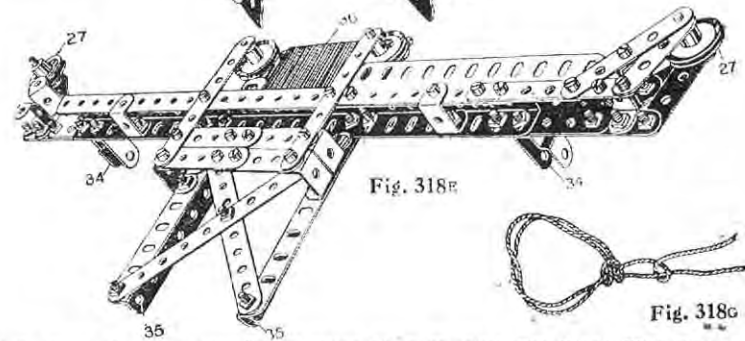

Fig. 318e



Fig. 318g

cranks 33 pivotally connected to cranked bent strips 34 on the slay (Fig. 318e). This gives a rocking or beat-up motion to the slay frame which is pivoted at 35 on a rod 35a (Fig. 318a) passing through the frame. The reed 36 is formed of a number of 2½" strips spaced with washers. Springs 52 connected to cranks 53 on the rods 22 return the picking sticks after operation.

In Fig. 318e the left hand side of the slay is shown with the front flat unibent girder strip removed to show the construction.

TAKE-UP MOTION.—The rod 28 carries two worms 37 engaging 56-toothed gear wheels 38 on 8" rods 39, 25-toothed pinions 40 on the ends of which engage contrate wheels 41, similar upper contrate wheels 42 engaging 20-toothed pinions 43 on the sand-roller spindle. The upper contrate wheels 42 are reversed relatively on each side of the loom. The lower roller 44, kept tight against the sand roller by springs 45 acting through the sprocket chains 46, is revolved by the sand roller. The woven material passing off the sand roller is carried by a rod at the rear before passing on to the lower roller.

Special Meccano Model No. 319 — Beaming Frame

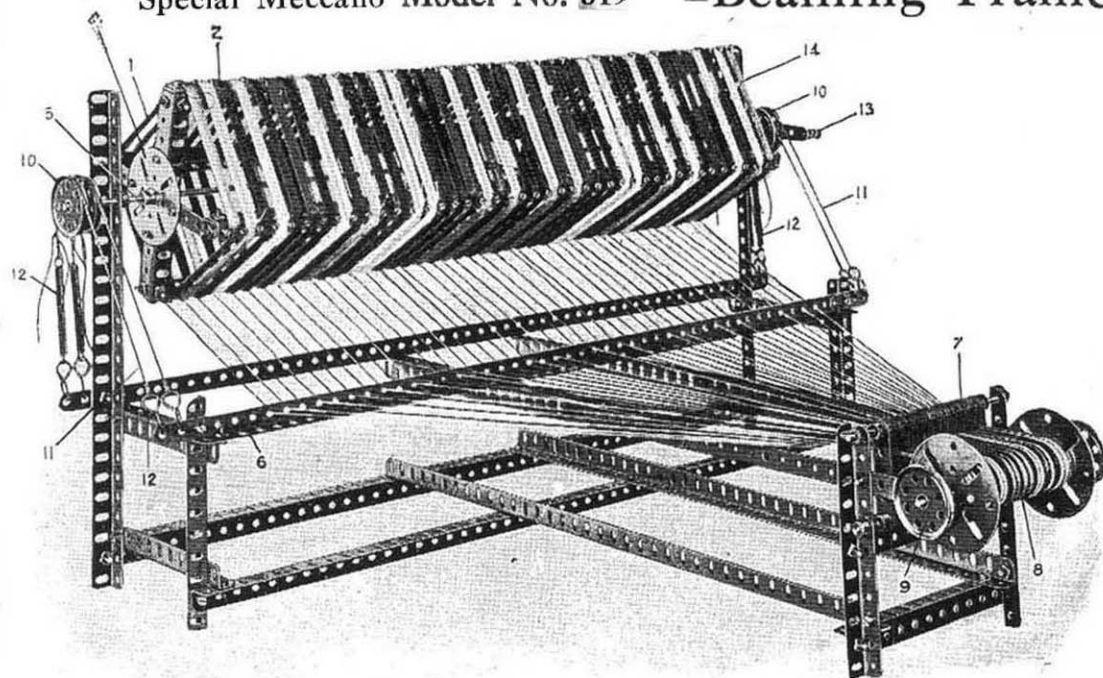

Parts required :

2 of No. 1	4 of No. 7	8 of No. 12	1 of No. 26	4 of No. 43	1 of No. 103
4 " " 2	2 " " 7A	2 " " 13	1 " " 33	8 " " 57	4 " " 109
44 " " 5	12 " " 8	3 " " 14	253 " " 37	10 " " 59	
4 " " 6	10 " " 9	6 " " 21	88 " " 38	1 " " 63	

The frame upon which the warp threads are wound is built up of 12½" angle girders, 2, overlapped seven holes and bolted to a 5½" girder 1 and 5½" strip crossed and connected to face plates 4 on the 11½" rod 5.

Inside the frame, two 5½" angle girders are bolted nine holes from each end to form the inner bearings for the rods 5. Another 5½" girder is bolted crosswise to these in the centre to form a stay.

The warp threads are first wound upon the warp-frame, and pass through the holes in a 24½" angle girder 6, and, converging together, pass between the 2½" strips 7 forming the reed, and so on to the beam 8. On the far side of the beam rod is a ½" pinion engaged by a pawl (not shown on the photograph) which prevents backward rotation of the beam as the warp threads are wound thereon by turning the 1½" pulley wheels 9.

A brake mechanism for tensioning the frame 2 is provided by securing two 1" pulley wheels 10 at each end of the frame rod 5, cords 11, secured by hooks passing over the pulleys 10 and being kept taut by the springs 12.

A handle 13 is provided on the rod 5 by means of which the warp threads 14 are originally wound on the frame.

A Page of Special Meccano Models

No. 319.
Beaming Frame.

Parts Required:

8 of No. 1
10 " " 2
2 " " 3
35 " " 5
4 " " 8
2 " " 9
6 " " 13
7 " " 13A
3 " " 14
2 " " 21

2 of No. 24
1 " " 26
1 " " 33
26 " " 35
56 " " 37
60 " " 38
4 " " 52
12 " " 59
1 " " 106

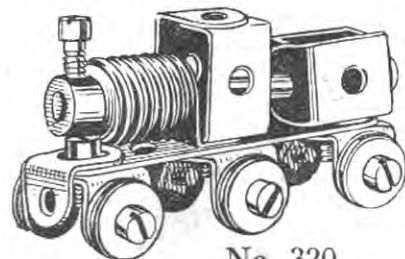
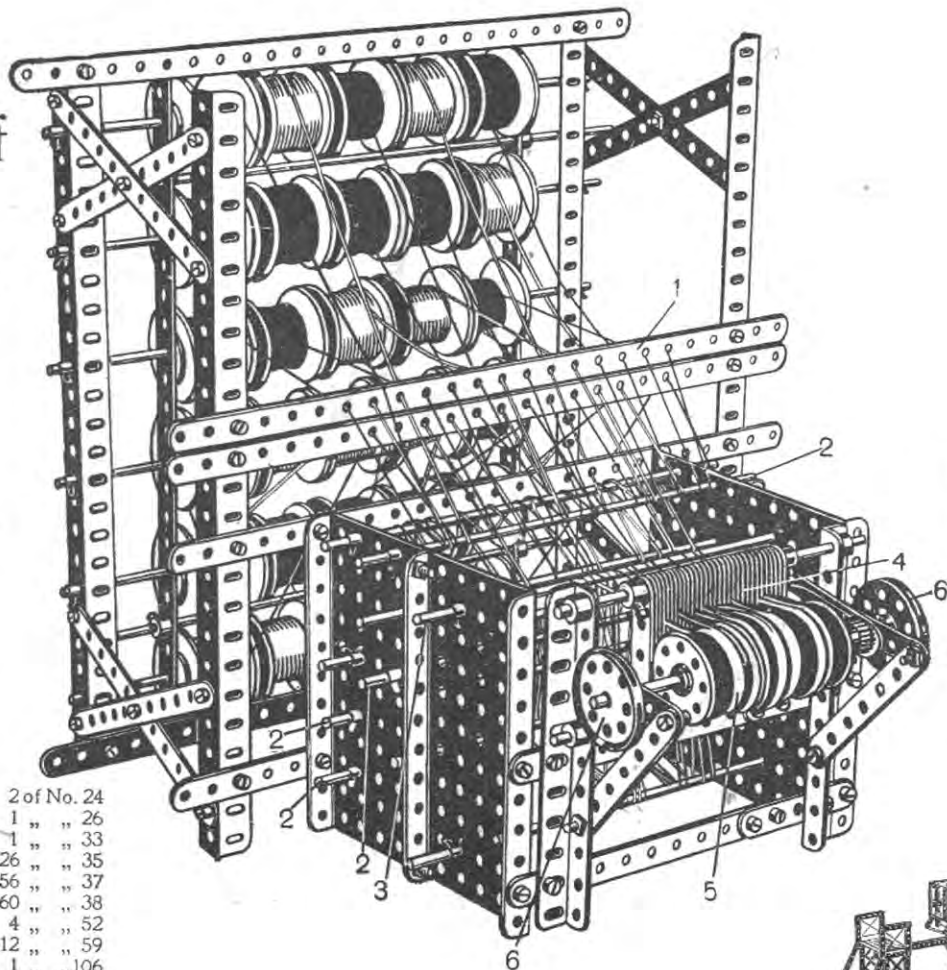

No. 320.
The Meccano Express.



No. 321.
Roundabout.

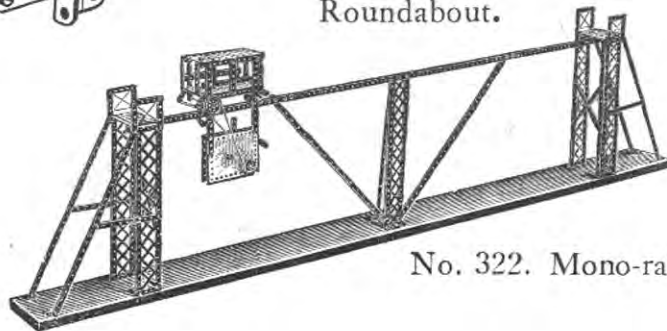

No. 322. Mono-rail.

Before cloth can be woven in a loom the warp threads must be wound evenly and in order upon a beam roller. This operation is done in a beaming frame. The threads from the bobbins are passed through the perforations in the strips 1, and then in order to put a slight tension on the threads they are zig-zagged round a series of rods 2, and eventually pass over the rod 3 and then through the reed 4 on to the beam roller 5. As soon as sufficient warp threads are wound on the roller by turning the end pulley wheels 6, the beam roller is placed in the loom.

Special Meccano Model No. 323 –Stiff Leg Derrick

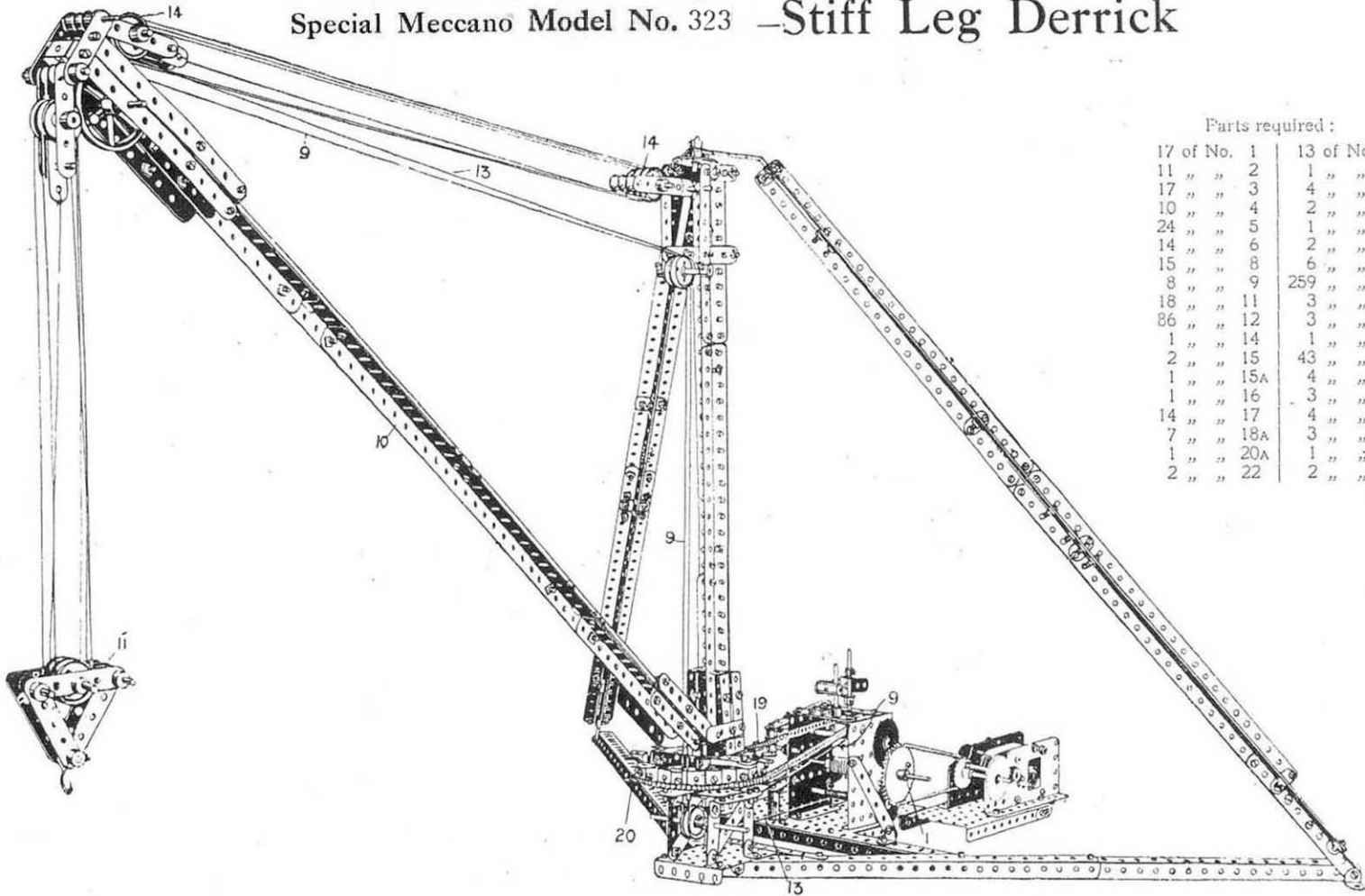

Parts required :

17 of No.	1	13 of No.	22A
11 "	2	1 "	24
17 "	3	4 "	26
10 "	4	2 "	27A
24 "	5	1 "	32
14 "	6	2 "	33
15 "	8	6 "	35
8 "	8	259 "	37
18 "	11	3 "	52
86 "	12	3 "	53
1 "	14	1 "	57
2 "	15	43 "	59
1 "	15A	4 "	60
1 "	16	3 "	62
14 "	17	4 "	63
7 "	18A	3 "	94
1 "	20A	1 "	95
2 "	22	2 "	96

The Meccano Electric Motor

This is the Meccano Electric Motor—the most powerful and reliable toy electric motor made. It runs Elevators, Sawmills, Lathes, or any other Meccano models. It has been tested to lift 30lbs. dead weight when properly geared. Two or three dry batteries will run it but accumulators are more satisfactory. Direct shaft drive; positive and powerful. Interchangeable gearing. It puts action into Meccano models; makes them operate like real machinery.

The Meccano Spring Motor

THE MECCANO SPRING MOTOR contains its own motive power in a simple and convenient form. It can be built into, and becomes part of, the model it drives.

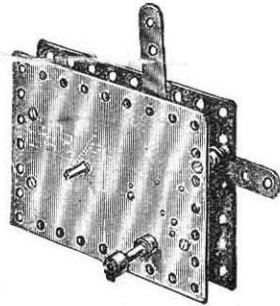

The No. 1 Meccano Spring Motor may be used in connection with a very large number of Meccano models. It has a stopping and starting motion, and the movement can be reversed. Price 12/6

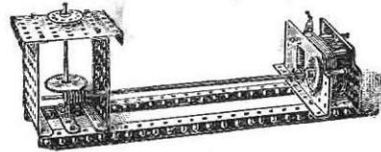

Showing the application of the Electric motor to such models as the Roundabout, Maxim Flying Machine, &c.

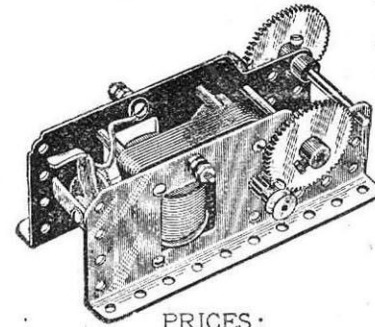

PRICES:



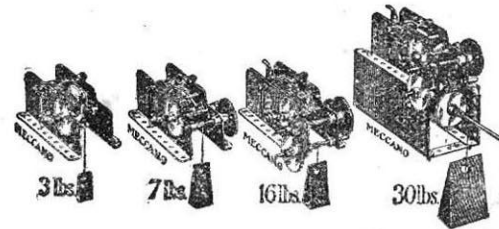



Without reversing mechanism .. 10/-
With reversing mechanism .. 15/-



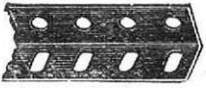







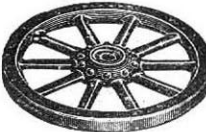



This illustration shows a combination of gears built from Meccano parts on to the Electric Motor itself, the drive being direct from the Armature Spindle. Note how a slow drive and substantial lifting power are secured. In this case three dry batteries (approximately four volts) were used.

Just a hint on the use of the non-reversing electric motor. When it is fitted to a crane or an elevator it is a good plan to secure a collar to the shaft, on the inside of the plate nearest the large gear wheel, allowing about $\frac{1}{4}$ in. play. When the load has reached the top the rod may be slid along sufficiently to throw the big gear wheel out of gear with the pinion, thus allowing the load to be released.

Particulars and Prices of Meccano Parts

			
No.		s.	d.
1.	Perforated Strips, 12 $\frac{1}{2}$ " long ..	$\frac{1}{2}$ doz.	1 3
2.	" " 5 $\frac{1}{2}$ " " ..	"	0 9
3.	" " 3 $\frac{1}{2}$ " " ..	"	0 5
4.	" " 3" " ..	"	0 4
5.	" " 2 $\frac{1}{2}$ " " ..	"	0 4
6.	" " 2" " ..	"	0 4
6A.	" " 1 $\frac{1}{2}$ " " ..	"	0 3
			
8.	Angle Girders, 12 $\frac{1}{2}$ " long ..	$\frac{1}{2}$ doz.	2 3
9.	" " 5 $\frac{1}{2}$ " " ..	"	1 3
			
10.	Flat Brackets	$\frac{1}{2}$ doz.	0 3
			
11.	Double Brackets	each	0 1
			
12.	Angle Brackets	doz.	0 6
			
13.	Silver Steel Axle Rods, 11 $\frac{1}{2}$ " long, each		0 5
13A.	Axle Rods 8" long	"	0 3
14.	" " 6" "	"	0 2
15.	" " 5" "	"	0 2
15A.	" " 4 $\frac{1}{2}$ " "	"	0 1
16.	" " 3 $\frac{1}{2}$ " "	"	0 1
17.	" " 2" "	"	0 1
18.	" " 1" "	"	0 1
			
19.	Crank Handles	each	0 3

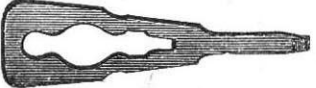
			
No.		s.	d.
19A.	Wheels, 3" diam.	each	0 8
19B.	Pulley Wheels, 3in. diam. with set screw	each	1 3
			
20.	Anged Wheels	each	0 9
			
20A.	2" Pulley Wheels, with set screw ..	each	1 0
21.	" " " "	"	0 9
22.	" " " "	"	0 6
22A.	" " without " "	"	0 3
23.	" " " "	"	0 2
23A.	" " with " "	"	0 6
			
24.	Bush	each	0 8
			
25.	Pinion wheels, $\frac{3}{8}$ " diam. ..	each	1 3
26.	" " " "	"	0 9
			
Gear Wheels.			
27.	50 teeth to gear with pinion ..	each	0 10
27A.	55 " " " " " "	"	1 0

			
No.		s.	d.
28.	Contrate Wheels, 1 $\frac{1}{2}$ " diam. ..	each	1 3
29.	" " " "	"	1 0
			
32.	Worm Wheels	each	0 10
			
33.	Pawls	each	0 3
			
34.	Spanners	each	0 3
			
35.	Spring Clips	per box (332)	0 3
			
36.	Screw Drivers	each	0 3
36A.	" " special	"	1 3
			
37.	Nuts and Bolts	per box (doz.)	0 6
37A.	Nuts	"	0 3
38.	Washers	doz.	0 2
40.	Hanks of Cord	two for	0 3

Particulars and Prices of Meccano Parts (continued)

No.		s. d.
41. Propeller Blades per pair		0 6

43. Springs		each 0 2
---------------------	---	----------

44. Cranked Bent Strips each		0 2
------------------------------------	---	-----

45. Double Bent Strips each		0 2
-----------------------------------	---	-----

46. Large Bent Strips each		0 3
----------------------------------	---	-----

47A. Dynameters (tension) each		2 6
--------------------------------------	---	-----

50. Eye Pieces		each 0 2
------------------------	---	----------

No.	s. d.
52. Perforated Flanged Plates, 5½" x 2½"	
each	0 6

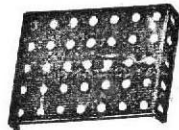
53. Perforated Flanged Plates, 3½" x 2½"		each 0 5
--	---	----------

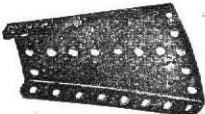
54. Perforated Sector Plates each		0 5
56. Instruction Manuals		2 6
56A. " " Kb. 2		1 3

57. Hooks		each 0 1
57A. " (scientific)		0 1

58. Spring Cord per length		1 0
----------------------------------	---	-----

59. Collars with Set Screws each		0 3
--	---	-----

60. Bent Strips, 4½" long per ½ doz.		0 9
--	---	-----

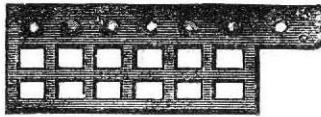
No.	s. d.	
61. Windmill Sails each		0 3

62. Cranks		each 0 6
--------------------	---	----------

63. Couplings		each 0 9
65. Centre Forks		0 3
66. Weights, 50 gramme		0 6
67. " 25 "		0 4
68. Wood Screws, ½" doz.		0 3
69. Set Screws		0 4
69A. Grub Screws		0 4
94. Sprocket Chain per yard		1 0

95. Sprocket Wheels, 2" diam. each		0 6
96. " " 1"		0 4

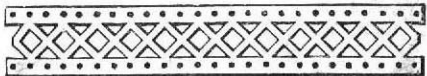
97. Braced Girders, 3½" long ½ doz.		0 9
98. " " 2½"		0 6
99. " " 12½"		1 9
100. " " 5½"		1 0
101. Healds, for Looms doz.		0 9
102. Single Bent Strips each		0 2
103. 5½" Flat Girders		0 2
104. Shuttles		1 0
105. Reed Hooks		0 3
106. Rollers		0 6
107. Tables, for Designing Machines		1 0

Contents of Outfits

No.	DESCRIPTION OF PARTS.	0	0A	1	1A	2	2A	3	3A	4	4A	5	5A	6
1	Perforated Strips, 12 $\frac{1}{2}$ "
2	" " 5 $\frac{1}{2}$ " ..	4	2	6	10	16	2	18	4	14	4	14	34	48
3	" " 3 $\frac{1}{2}$ "	1	1	2	4	6	..	22	4	26	34	60
4	" " 3"	1	1	2	2	2	2	6	11	17	19	36
5	" " 2 $\frac{1}{2}$ " ..	9	..	3	3	12	..	12	8	20	24	10	14	24
6	" " 2"	6	44	4	48
8	Perforated Angle Girders, 12 $\frac{1}{2}$ " 5 $\frac{1}{2}$ "	4	4	4	4	8	..	8	4	12	12	24
9	" " ..	4	16	16
10	Flat Brackets ..	4	..	4	4	4	..	4	4	8	..	8	8	16
11	Double Brackets ..	1	1	3	3	4	..	4	..	4	..	4	12	16
12	Angle Brackets ..	8	4	12	12	12	24	24	12	36	17	53	67	120
13	Rods, 11 $\frac{1}{2}$ "
14	" " 8"
15	" " 6"
16	" " 5"
17	" " 4 $\frac{1}{2}$ " ..	2	1	3	3	3	1	4	..	4	..	4	4	8
18	" " 3 $\frac{1}{2}$ "	1	1	2	2	2	2	3	..	3	1	4
19	" " 2" ..	2	..	2	2	2	2	2	2	4	..	4	4	4
20	" " 1" ..	1	1	1	1	1	1	1	1	2	..	2	2	2
21	Crank Handles
22	Flanged Wheels
23	Pulley Wheels, 1 $\frac{1}{2}$ " ..	4	..	4	4	4	..	4	4	8	..	8
24	" " 1" (fast)
25	" " 1" (loose)
26	Bush Wheels ..	1	..	1	1	1
27	Pinion Wheels, $\frac{3}{4}$ "
28	" " $\frac{1}{2}$ "
29	Gear Wheels, 50 teeth
30	" " 56 teeth
31	Contrate Wheels, 1 $\frac{1}{2}$ "
32	" " 3"
33	Worm Wheels
34	Pawls
35	Spanners
36	Spring Clips ..	4	2	6	..	6	6	12	6	18	6	24
37	Nuts and Bolts ..	1	1	1	1	1
38	Hanks of Cord ..	25	5	30	25	55	25	80	50	130	45	175	290	465
39	Propeller Blades ..	1	..	1	1	2	1	3	1	4	2	6	..	6
40	" "
41	Springs
42	Cranked Bent Strip
43	Double Bent Strips ..	1	..	1	1	1
44	Large Bent Strips
45	Eye Pieces ..	1	..	1	1	1	1	2	1	2	1	1	1	2
46	Perforated Flanged Plates, 5 $\frac{1}{2}$ " x 2 $\frac{1}{2}$ " ..	1	..	1	1	2	3	3	1	4	1	4	5	8
47	" " 3 $\frac{1}{2}$ " x 2 $\frac{1}{2}$ " ..	1	..	1	1	2
48	Sector Plates ..	1	1	2
49	Manual of Instructions ..	1	1	1
50	Hooks ..	1	..	1
51	Spring Cord
52	Collars with Set Screws
53	Bent Strips, 2 $\frac{1}{2}$ " ..	2	4	2	6	4	4	6	2	8	1	9	7	16
54	Windmill Sails
55	Cranks
56	Couplings
57	Centre Fork
58	Sprocket Chain (length)

Price List

No. 0.	Meccano Outfit	6/-
No. 1.	”	”	10/-
No. 2.	”	”	20/-
No. 3.	”	”	30/-
No. 4.	”	”	50/-
No. 5.	”	”	Packed in neat and well-made cardboard box			70/-
Do.	”	Presentation Outfit			Packed in superior oak cabinet with lock and key			100/-	
No. 6.	”	”	”	...	Ditto	ditto	ditto	...	180/-
<hr/>									
No. 0A.	Meccano Accessory Outfit	(containing sufficient parts to convert a Meccano No. 0 Outfit into a No. 1)						5/-	
No. 1A.	”	”	”	(containing sufficient parts to convert a No. 1 Outfit into a No. 2)				11/-	
No. 2A.	”	”	”	(containing sufficient parts to convert a No. 2 Outfit into a No. 3)				12/-	
No. 3A.	”	”	”	(containing sufficient parts to convert a No. 3 Outfit into a No. 4)				22/-	
No. 4A.	”	”	”	(containing sufficient parts to convert a No. 4 Outfit into a No. 5)				17/6	
No. 5A.	”	”	”	(containing sufficient parts to convert a No. 5 Outfit into a No. 6)				65/-	
Do.	”	”	”	Packed in neat and well-made cardboard box				95/-	
Meccano Inventors' Accessory Outfit		10/-

MECCANO IS MORE THAN A TOY

IT is important to remember that when a boy is playing with Meccano he is using engineering parts in miniature, and that these parts act in precisely the same way as the corresponding engineering elements would do in actual practice. No other system of model construction could, therefore, be correct. Other toys which attempt the same object by other methods must avail themselves of other constructive elements which are not correct engineering elements. Consequently, though a boy may succeed in building playthings with them, they are merely toys, and nothing else, and his mind, as regards proper mechanical construction and methods, is distorted instead of instructed. He then learns wrong principles, and when his ambition tempts him to invent or construct more elaborate models he will be stopped by the deficiencies of his non-mechanical system.

No Outfit is genuine unless it bears the
trade mark MECCANO