

# MECCANO



(TRADE MARK 296321)

## INSTRUCTIONS

BOOK No. 1

# 3/6

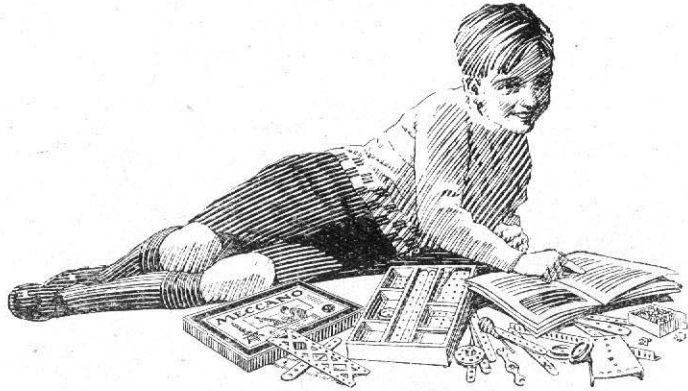
Copyright by MECCANO LIMITED, LIVERPOOL, throughout the World.

No. 22.

ENGLISH EDITION.



# A TALK WITH NEW MECCANO BOYS



**M**ECCANO OUTFITS contain accurately-made and highly-finished engineering parts and enable every movement known to mechanism to be reproduced in model form. With Meccano you can accomplish more than with any other constructional toy, for no other system has its possibilities. No study is needed to enable anyone to build models with Meccano—the genius is in the Meccano parts.

You never come to the end of Meccano fun. There is always more ahead—always some new, ingenious and interesting model to build. Each one, as it is completed, "tuned up," and set going, brings a joy and satisfaction beyond anything that boys have ever previously experienced.

As you progress in Meccano you obtain a greater variety of parts, gear wheels, pulley wheels, worm wheels, couplings, cranks, and all manner of perfectly-made real engineering parts. These enable you to construct

complicated mechanical movements without any difficulty. The most wonderful feature of Meccano is that it is *real engineering*; it is fascinating and delightful and yet so simple that even an inexperienced boy may join in the fun without first having to study or learn anything.

## THE LIFE OF A MECCANO BOY

**A** MECCANO boy is the happiest boy in the world. He builds models from the Meccano Instruction books; invents new models; has a shot at the Competitions which are always being held in connection with the hobby; joins the Meccano Guild and a Meccano Club and by wearing the Guild badge proclaims himself to be the friend of millions of other Meccano boys all over the world. He reads the *Meccano Magazine* regularly and corresponds with his friend the Editor when he feels like it. Time never hangs heavily on his hands and he is too busy and happy to grumble.

The *Meccano Magazine* is the Meccano boy's newspaper. It tells him of the latest Meccano models; what Meccano Clubs are doing; how to correspond with other Meccano boys; the Competitions that are running, etc. It contains interesting articles on engineering and electrical subjects, and deals with many other topics of interest to boys, including suggestions from Meccano boys for new Meccano parts and correspondence columns in which the Editor replies to his readers' enquiries. Write to the Editor, *Meccano Magazine*, Binns Road, Liverpool, and he will send you a copy FREE. It is sent regularly to subscribers at the rate of 6d. for six issues, or it may be purchased from any Meccano dealer, price 1d. per copy.

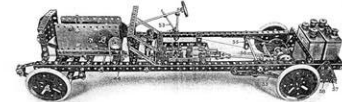
SEPTEMBER-OCTOBER, 1918

### MECCANO

#### MAGAZINE

TO HELP MECCANO BOYS TO HAVE MORE FUN THAN OTHER BOYS

PRICE 1d



A New Meccano Motor Chassis.

We have pleasure in illustrating this model by a complete chassis to Meccano model-builders. The new Meccano chassis was first shown at the Meccano Exhibition that was held at the Royal Albert Hall, London, in 1917. It is a most interesting and useful model, and one that will be found to be very useful in many ways. It is a most interesting and useful model, and one that will be found to be very useful in many ways.

The chassis is made of 1/2" and 1/4" rods, and is mounted on 1/2" wheels. It is a most interesting and useful model, and one that will be found to be very useful in many ways.

The chassis is made of 1/2" and 1/4" rods, and is mounted on 1/2" wheels. It is a most interesting and useful model, and one that will be found to be very useful in many ways.

The chassis is made of 1/2" and 1/4" rods, and is mounted on 1/2" wheels. It is a most interesting and useful model, and one that will be found to be very useful in many ways.

**Editorial.**

It is a pleasure to receive your letters, and we are glad to hear that you are enjoying the magazine. We are glad to hear that you are enjoying the magazine. We are glad to hear that you are enjoying the magazine.

We are glad to hear that you are enjoying the magazine. We are glad to hear that you are enjoying the magazine. We are glad to hear that you are enjoying the magazine.

We are glad to hear that you are enjoying the magazine. We are glad to hear that you are enjoying the magazine. We are glad to hear that you are enjoying the magazine.

# THE MECCANO GUILD



MECCANO GUILD:  
CLUB CERTIFICATE.

**T**HE MECCANO GUILD is an organisation for boys, started at the request of boys and conducted as far as possible by boys. The Guild is one great fraternal organisation of which all Meccano boys should become members, for its primary object is to bring them together. The Guild makes these boys feel that they are all members of a great brotherhood, each trying to help the others to get the very best out of life and it cannot fail to have a profound effect for good on the lives of its members.

## MECCANO CLUBS

**M**ECCANO CLUBS are founded and established under the guidance of the Guild Secretary at Headquarters and at the present time there are active Clubs in over one hundred towns and villages. Some of the larger towns and cities have several Clubs, one in each district. Each Club has its Leader, Secretary, Treasurer, and other officials all of whom, with the exception of the Leader, are boys. Write for information as to the nearest Club to you.

Special awards are given to Club members for good work in connection with their Club and medallions are awarded in connection with the Recruiting Campaign, full particulars of which will be sent on request.

## MECCANO PRIZE COMPETITIONS. MONEY AND FAME FOR MECCANO BOYS

**E**ACH year there is a big Meccano Prize Competition, cash prizes and Meccano Outfits to the value of at least £250 being awarded to clever boys who are able to design new models. Particulars and entry forms may be obtained from all Meccano dealers, or direct from us on receipt of a post card.

## HOW TO BUILD WITH MECCANO

**F**OLLOW the instructions closely at first, and build the models just as you see them. Then take each model and try to improve our design. Every model can be made in a dozen different ways. Screw up all the nuts and bolts firmly and you will find that you can play with the trucks, cranes, signals, etc., and obtain many hours of fun.

Meccano is sold in eight different Outfits, numbered 0 to 7. All parts are of the same high quality and finish, the larger Outfits containing a greater quantity and variety of parts.

Each Outfit may be converted into the one next higher, by the purchase of an Accessory Outfit. Thus, a No. 2 may be converted into a No 3 by adding to it a No. 2A. A No. 3A would then convert it into a No. 4, and so on. In this way, no matter with which Outfit you commence, you may by degrees build up your Outfit to a No. 7.



SPECIAL MERIT  
MEDALLIONS.



RECRUITING MEDALLION.

# Particulars and Prices of Meccano Parts

No.	Perforated Strips, 12½" long ...	s. d.
1.	9½" " " " " " "	0 9
1A.	7½" " " " " " "	0 8
2.	5½" " " " " " "	0 6
2A.	4½" " " " " " "	0 5
3.	3½" " " " " " "	0 4
4.	3" " " " " " "	0 3
5.	2½" " " " " " "	0 3
6.	2" " " " " " "	0 3
6A.	1½" " " " " " "	0 3



7.	Angle Girders, 24½" long ...	each 0 8
7A.	18½" " " " " " "	0 6
8.	12½" " " " " " "	½ doz. 1 9
8A.	9½" " " " " " "	1 3
8B.	7½" " " " " " "	1 2
9.	5½" " " " " " "	1 0
9A.	4½" " " " " " "	0 10
9B.	3½" " " " " " "	0 8
9C.	3" " " " " " "	0 8
9D.	2½" " " " " " "	0 7
9E.	2" " " " " " "	0 6
9F.	1½" " " " " " "	0 6



10.	Flat Brackets ...	½ doz. 0 2
11.	Double Brackets ...	each 0 1



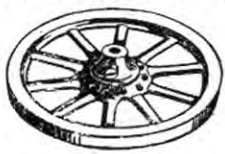
12.	Angle Brackets, 1" x 1" ...	dox. 0 6
12A.	1" x 1" " " " "	each 0 1
12B.	1" x 1" " " " "	0 1



13.	Axle Rods, 11½" long ...	each 0 3
13A.	8" " " " " "	0 3
14.	6" " " " " "	0 2
15.	5" " " " " "	0 2
15A.	4" " " " " "	0 1
16.	3" " " " " "	0 1
16A.	2½" " " " " "	0 1
17.	2" " " " " "	0 1
18.	1½" " " " " "	0 1
18B.	1" " " " " "	0 1



19.	Crank Handle ...	each 0 3
-----	------------------	----------



No.	19A. Wheels, 3" diam., with set screws ...	s. d.
		each 0 8



20.	Flanged Wheels ...	each 0 6
-----	--------------------	----------



19B.	3" dia., with centre boss and set screw, each	0 8
20A.	2" " " " " " " "	0 6



21.	1½" dia. with centre boss and set screw, each	0 6
22.	1" " " " " " " "	0 4
23A.	1" " " " without " " " "	0 4
22A.	1" " " " " " " "	0 2
23.	1" " " " " " " "	0 2



24.	Bush Wheels ...	each 0 6
25.	Pinion Wheels, 1" diam. ...	0 6
26.	" " " " " "	0 4



27.	50 teeth to gear with 1" pinion ...	each 0 9
27A.	57 " " " " " "	0 9
28.	Contrate Wheels, 1½" diam. ...	0 9
29.	" " " " " "	0 6



No.	(30) Bevel Gears ...	s. d.
30.	each 0 10	
31.	(31) Gear Wheels, 1", 38 teeth ...	1 0



32.	Worm Wheels ...	each 0 6
33.	Pawls (complete) ...	0 4
33A.	Pivot Bolts with Nuts ...	0 2



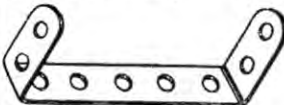
34.	Spanners ...	each 0 2
-----	--------------	----------



35.	Spring Clips ...	per box (doz.) 0 3
36.	Screw Drivers ...	each 0 3
36A.	Extra long ...	0 6
37.	Nuts and Bolts ...	per box (doz.) 0 6
37A.	Nuts ...	0 3
37B.	Bolts ...	0 3
38.	Washers ...	0 1
40.	Hanks of Cord ...	0 1½
41.	Propeller Blades ...	per pair 0 4
43.	Springs ...	each 0 2



44.	Cranked Bent Strips ...	each 0 1
45.	Double Bent Strips ...	0 1



46.	Double Angle Strips, 2½" x 1" ...	½ doz. 0 6
50.	Eye Pieces ...	each 0 2



No.	52. Perforated Flanged Plates, 5½" x 2½", each	0 5
	52A. Flat Plates, 5½" x 3½" ...	0 5



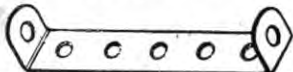
53.	Perforated Flanged Plates, 3½" x 2½", each	0 3
53A.	Flat Plates, 4½" x 2½" ...	0 3
54.	Perforated Flanged Sector Plates ...	0 3



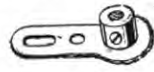
55.	Perforated Strips, slotted, 5½" long ...	each 0 2
55A.	" " " " " "	0 1
56.	Instruction Manuals, No. 1 ...	2 6
56A.	" " " " No. 2 ...	1 3
56B.	" " " " No. 3 ...	1 3



57.	Hooks (57) ...	each 0 1
57A.	" (scientific) ...	0 1
57B.	" Loaded ...	0 5
58.	Spring Cord ...	per length 0 9
59.	Collars with Set Screws ...	each 0 2



60.	Double Angle Strips, 2½" x 1" ...	½ doz. 0 5
60A.	" " " " " " " "	0 4
60B.	" " " " " " " "	0 6
60C.	" " " " " " " "	0 9
60D.	" " " " " " " "	0 9
61.	Windmill Sails ...	each 0 2



62.	Cranks ...	each 0 3
62A.	Threaded Cranks ...	0 4
63.	Couplings ...	0 6

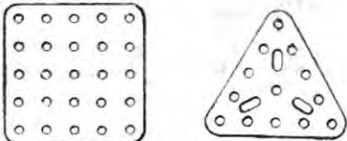
Particulars and Prices of Meccano Parts (continued)



No. (63A) (63B) s. d.  
 63A. Octagonal Couplings ... each 0 8  
 63B. Strip Couplings ... .. " 0 8



(63C) (64)  
 63C. Threaded Couplings ... each 0 6  
 64. Threaded Bosses ... .. " 0 2  
 65. Centre Forks ... .. " 0 2  
 66. Weights, 50 grammes ... .. " 1 0  
 67. " 25 " ... .. " 1 0  
 68. Woodscrews, 1" ... .. doz. 0 3  
 69. Set Screws ... .. " 0 4  
 69A. Grub Screws 1/2" ... .. " 0 4  
 69B. " 3/2" ... .. doz. 0 6



70. Flat Plates, 5 1/2" x 2 1/2" ... each 0 3  
 72. " 2 1/2" x 2 1/2" ... .. " 0 2  
 76. Triangular Plates, 2 1/2" ... .. " 0 2  
 77. " 1" ... .. " 0 1



78. Screwed Rods, 1 1/4" ... each 0 6  
 79. " 8" ... .. " 0 5  
 79A. " 6" ... .. " 0 4  
 80. " 3 1/2" ... .. " 0 3  
 80A. " 3 1/4" ... .. " 0 3  
 80B. " 4 1/2" ... .. " 0 3  
 81. " 2" ... .. " 0 2  
 82. " 1" ... .. " 0 1



89. Curved Strips, 5 1/2" ... each 0 2  
 90. " 2 1/2" ... .. " 0 1



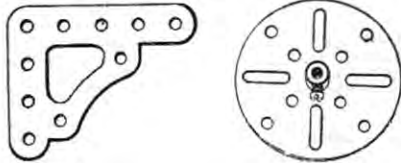
94. Sprocket Chain ... .. per yard 0 6



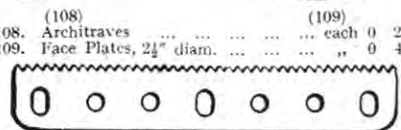
No. s. d.  
 95. Sprocket Wheels, 2" diam. ... each 0 5  
 95A. " 1 1/2" ... .. " 0 4  
 95B. " 3" ... .. " 0 6  
 96. " 1" ... .. " 0 3  
 96A. " 1/2" ... .. " 0 3



97. Braced Girders, 3 1/4" long ... 1/2 doz. 0 9  
 98. " 2 1/2" ... .. " 0 6  
 99. " 12 1/2" ... .. " 1 9  
 99A. " 9 1/2" ... .. " 1 6  
 100. " 5 1/2" ... .. " 1 0  
 101. Heads, for looms ... .. doz. 0 9  
 102. Single Bent Strips ... .. each 0 1  
 103. Flat Girders, 5 1/4" long ... .. 1/2 doz. 1 0  
 103A. " 9 1/2" ... .. " 1 6  
 103B. " 12 1/2" ... .. " 2 0  
 103C. " 4 1/2" ... .. " 0 9  
 103D. " 3 1/2" ... .. " 0 7  
 103E. " 3" ... .. " 0 6  
 103F. " 2 1/2" ... .. " 0 5  
 103G. " 2" ... .. " 0 4  
 103H. " 1 1/2" ... .. " 0 3  
 104. Shuttles, for looms ... .. each 4 0  
 105. Reed Hooks, for looms ... .. " 0 4



106. Wood Rollers ... .. 1 3  
 106A. Sand ... .. 1 6  
 107. Tables for Designing Machines ... 1 0



108. Architraves ... .. each 0 2  
 109. Face Plates, 2 1/4" diam. ... .. " 0 4

110. Rack Strips, 3 1/4" ... .. each 0 2



111. Bolts, 3/8" ... .. each 0 1  
 111A. " 1/2" ... .. 2 for 0 1  
 111B. " 7/8" ... .. doz. 0 4



No. s. d.  
 112. Double Angle Strips, 2 1/4" x 1 1/4" ... 1/2 doz. 0 9  
 112A. " 3" x 1 1/4" ... .. " 1 0



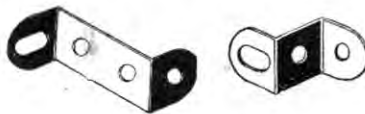
113. Girder Frames ... .. each 0 2



(114) (115) (120)  
 114. Hinges ... .. per pair 0 4  
 115. Threaded Pins ... .. each 0 2  
 120. Buffers ... .. " 0 2  
 120A. Spring Buffers ... .. " 0 4



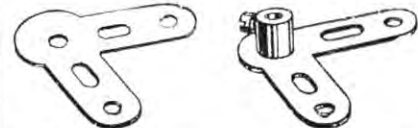
121. Train Couplings ... .. each 0 4  
 122. Miniature Loaded Sacks ... .. " 0 2  
 123. Cone Pulleys ... .. " 1 3



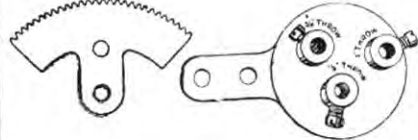
124. Reversed Angle Brackets, 1" ... 1/2 doz. 0 10  
 125. " 1/2" ... .. " 0 6



(126) (126A)  
 126. Flat Trunnions ... .. each 0 3  
 126A. Flat Trunnions ... .. " 0 2



No. (127) (128) s. d.  
 127. Simple Bell Cranks ... .. each 0 3  
 128. Boss Bell Cranks ... .. " 0 4



(129) (130)  
 129. Rack Segments, 3" diam. ... each 0 6  
 130. Triple Throw Eccentrics ... .. " 1 3



131. Dredger Buckets ... .. each 0 2



132. Flywheels, 2 1/2" diam. ... each 2 3  
 133. Corner Brackets ... .. each 0 3



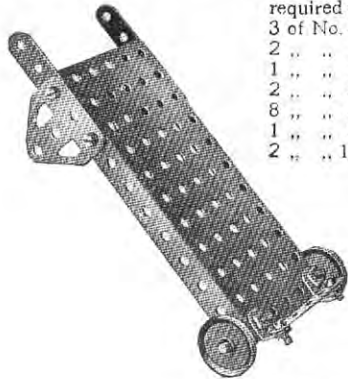
134. Crank Shafts, 1" stroke ... .. each 0 3  
 135. Theodolite Protractors ... .. " 0 3



136. Handrail Supports ... .. each 0 3  
 137. Wheel Planges ... .. " 0 4  
 138. Ship's Funnel ... .. " 0 4

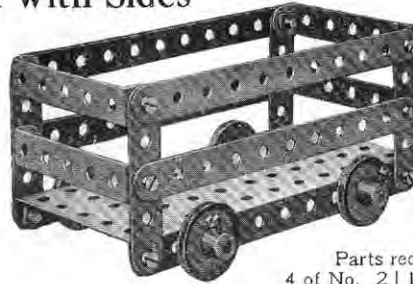
# Trucks and Luggage Carts

**Model No. 1  
Flat Truck**



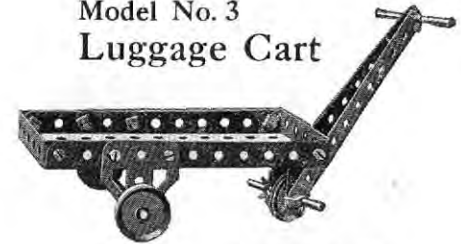
Parts  
required:  
3 of No. 5  
2 " " 12  
1 " " 16  
2 " " 22  
8 " " 37  
1 " " 52  
2 " " 126A

**Model No. 2  
Truck with Sides**



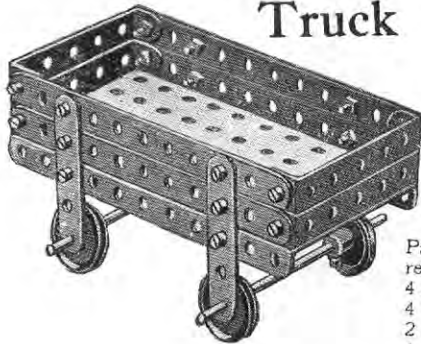
Parts required:  
4 of No. 2 | 12 of No. 37  
4 " " 5 | 1 " " 52  
2 " " 16 | 4 " " 60  
4 " " 22

**Model No. 3  
Luggage Cart**



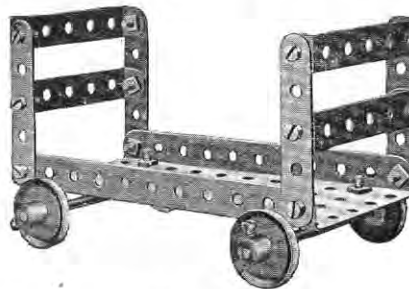
Parts required:  
2 of No. 2 | 9 of No. 37  
1 " " 16 | 1 " " 44  
2 " " 17 | 1 " " 52  
3 " " 22 | 2 " " 60  
4 " " 35 | 2 " " 126A

**Model No. 4  
Truck**



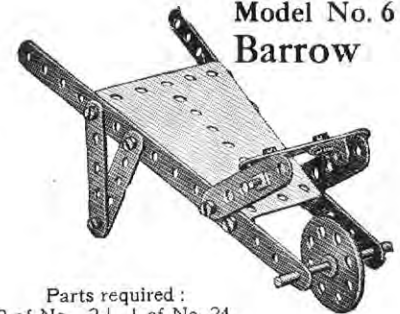
Parts  
required:  
4 of No. 2  
4 " " 5  
2 " " 16  
4 " " 22  
16 " " 37  
1 " " 52  
4 " " 60

**Model No. 5  
Luggage Truck**



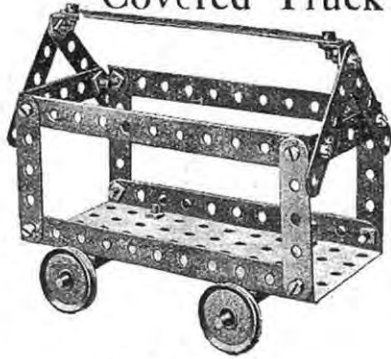
Parts required:  
4 of No. 5 | 16 of No. 37  
2 " " 16 | 1 " " 52  
4 " " 22 | 4 " " 60

**Model No. 6  
Barrow**



Parts required:  
2 of No. 2 | 1 of No. 24  
9 " " 5 | 2 " " 35  
2 " " 12 | 14 " " 37  
1 " " 17 | 1 " " 54

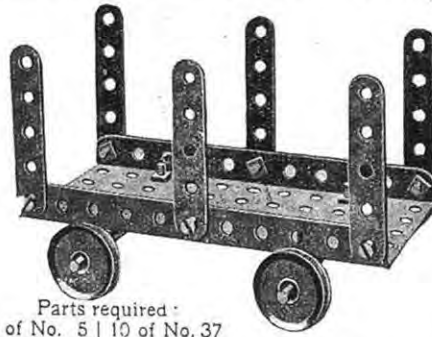
Model No. 7  
Covered Truck



Parts required		4 of No. 22
3 of No. 2	2 of No. 12	20 " " 37
8 " " 5	2 " " 16	1 " " 52
		4 " " 60

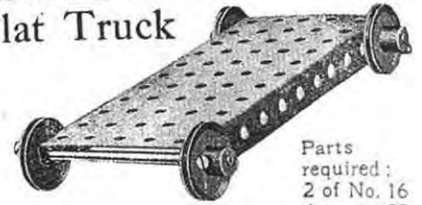
# Trucks and Luggage Carts *(continued)*

Model No. 8—Timber Truck



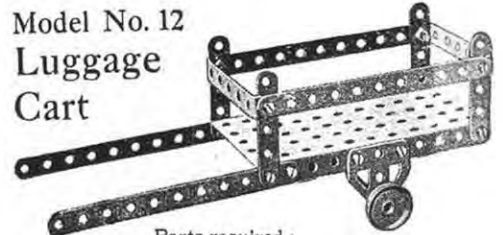
Parts required :	
6 of No. 5	10 of No. 37
2 " " 16	1 " " 52
4 " " 22	2 " " 60

Model No. 9  
Flat Truck



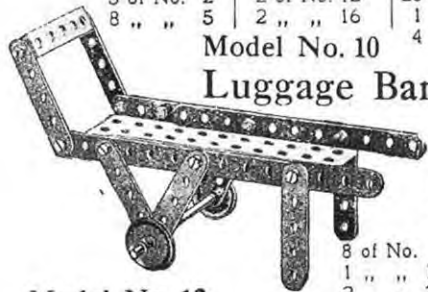
Parts required :  
2 of No. 16  
4 " " 22  
1 " " 52

Model No. 12  
Luggage Cart



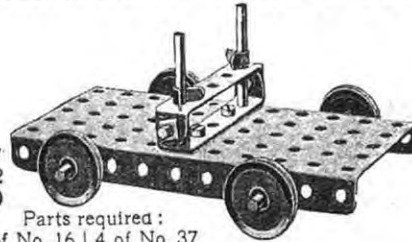
Parts required :	
4 of No. 2	14 of No. 37
4 " " 5	1 " " 52
1 " " 16	2 " " 60
2 " " 22	2 " " 126A

Model No. 10  
Luggage Barrow



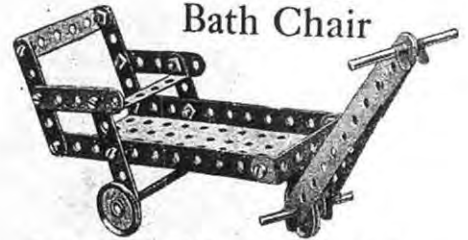
Parts required :	
8 of No. 5	10 of No. 37
1 " " 16	1 " " 52
2 " " 22	1 " " 60

Model No. 11—Timber Truck



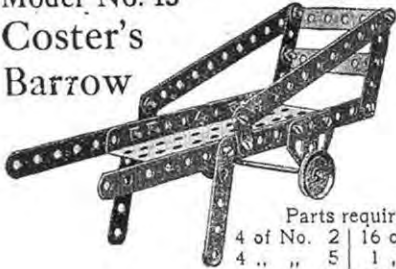
Parts required :	
2 of No. 16	4 of No. 37
2 " " 17	1 " " 52
4 " " 22	2 " " 60
4 " " 35	

Model No. 15  
Bath Chair



Parts required :		
1 of No. 16	13 of No. 3	
2 " " 17	1 " " 4	
3 " " 22	1 " " 5	
4 " " 35	3 " " 6	

Model No. 13  
Coster's Barrow



Parts required :	
4 of No. 2	16 of No. 37
4 " " 5	1 " " 52
1 " " 16	2 " " 60
2 " " 22	2 " " 126A

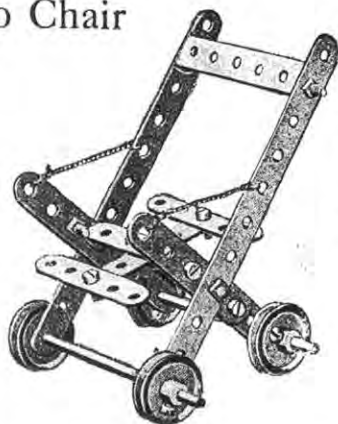
Model No. 14—Timber Drag



Parts required :		
2 of No. 11	8 of No. 37	
2 " " 16	4 " " 60	
4 of No. 2	4 " " 22	

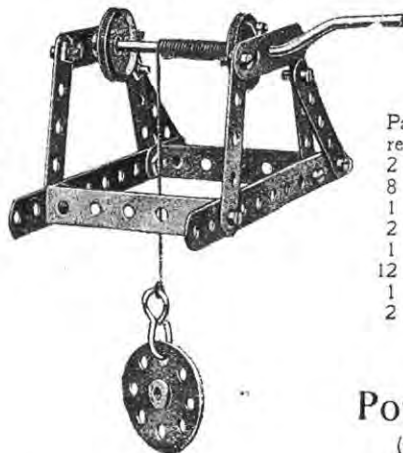


Model No. 16  
Go Chair



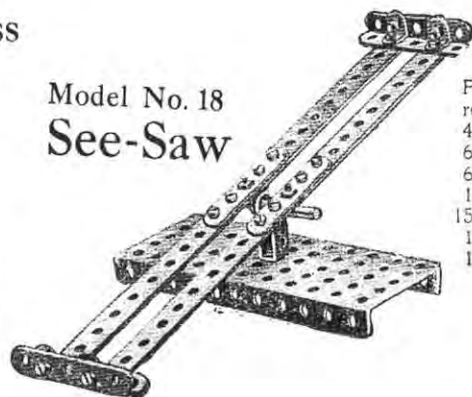
Parts  
required:  
2 of No. 2  
7 " " 5  
2 " " 16  
4 " " 22  
11 " " 37  
2 " " 60

Model No. 17--Well Windlass



Parts  
required:  
2 of No. 2  
8 " " 5  
1 " " 19  
2 " " 22  
1 " " 24  
12 " " 37  
1 " " 57  
2 " " 60

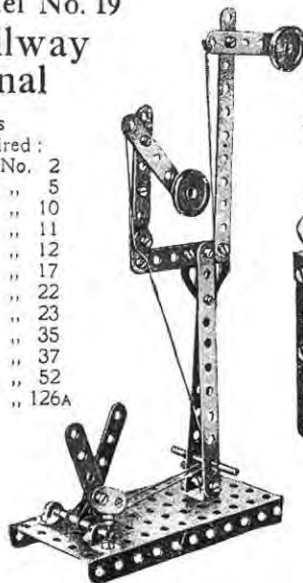
Model No. 18  
See-Saw



Parts  
required:  
4 of No. 2  
6 " " 5  
6 " " 12  
1 " " 17  
15 " " 37  
1 " " 44  
1 " " 52

Model No. 19  
Railway  
Signal

Parts  
required:  
3 of No. 2  
7 " " 5  
2 " " 10  
2 " " 11  
2 " " 12  
2 " " 17  
2 " " 22  
1 " " 23  
4 " " 35  
21 " " 37  
1 " " 52  
1 " " 126A



Model No. 20  
Potter's  
Wheel



Potter's Wheel  
(underneath view)

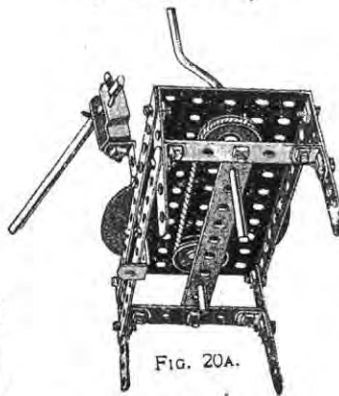
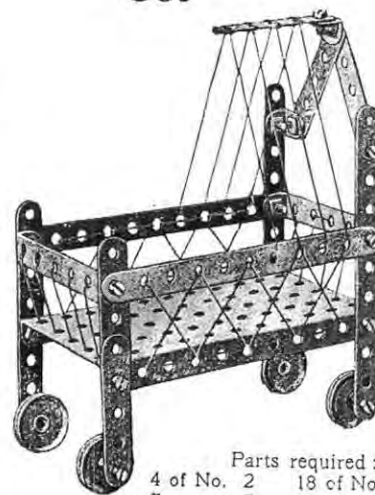


FIG. 20A.

Parts required:  
3 of No. 2  
4 " " 5  
1 " " 16  
1 " " 19  
2 " " 22  
1 " " 24  
2 of No. 35  
17 " " 37  
1 " " 44  
1 " " 52  
3 " " 60

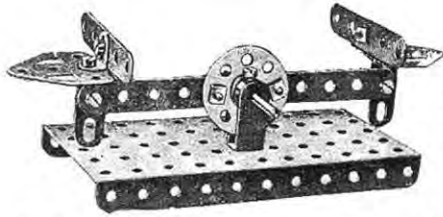
Model No. 21  
Cot



Parts required:  
4 of No. 2  
7 " " 5  
3 " " 12  
4 " " 22  
18 of No. 37  
1 " " 44  
2 " " 60

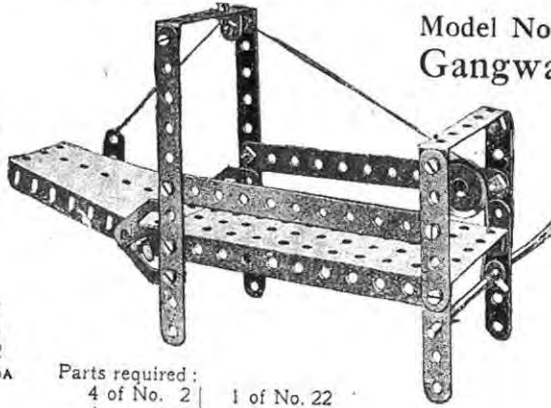
These-Models can be made with MECCANO Outfit No. 0

Model No. 22—Scales



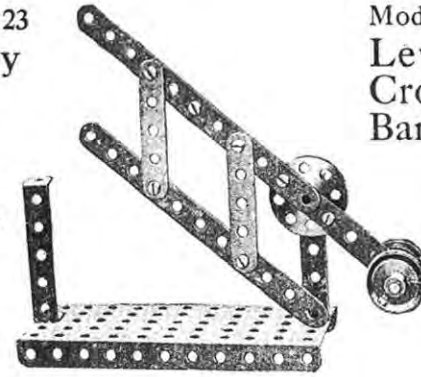
Parts required:		
1 of No. 2	2 of No. 12	1 " " 37
2 " " 5	1 " " 17	1 " " 44
2 " " 10	1 " " 24	1 " " 52
		2 " " 126A

Model No. 23  
Gangway



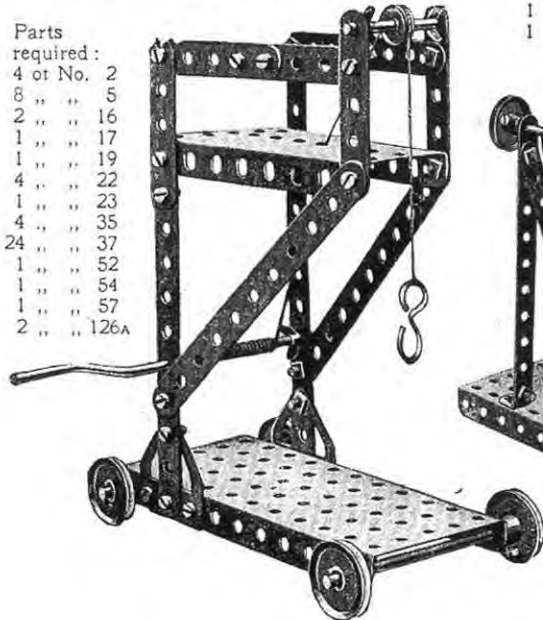
Parts required:		
4 of No. 2	1 of No. 22	
4 " " 5	1 " " 23	
1 " " 10	4 " " 35	
1 " " 12	18 " " 37	
1 " " 16	1 " " 52	2 of No. 60
1 " " 19	1 " " 54	2 " " 126A

Model No. 24  
Level  
Crossing  
Barrier



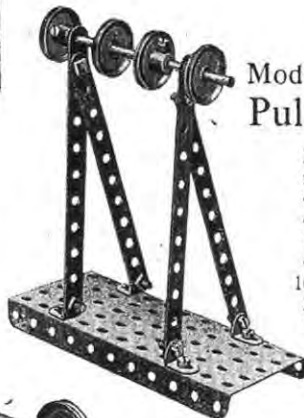
Parts required:	
3 of No. 2	2
2 " " 5	5
1 " " 17	17
4 " " 22	22
1 " " 24	24
10 " " 37	37
1 " " 52	52
2 " " 60	60

Model No. 25—Tower Wagon



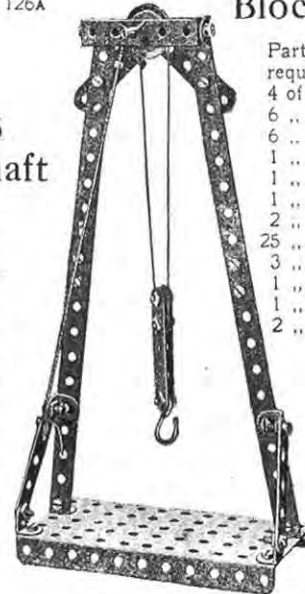
Parts required:	
4 of No. 2	2
8 " " 5	5
2 " " 16	16
1 " " 17	17
1 " " 19	19
4 " " 22	22
1 " " 23	23
4 " " 35	35
24 " " 37	37
1 " " 52	52
1 " " 54	54
1 " " 57	57
2 " " 126A	126A

Model No. 26  
Pulley Shaft



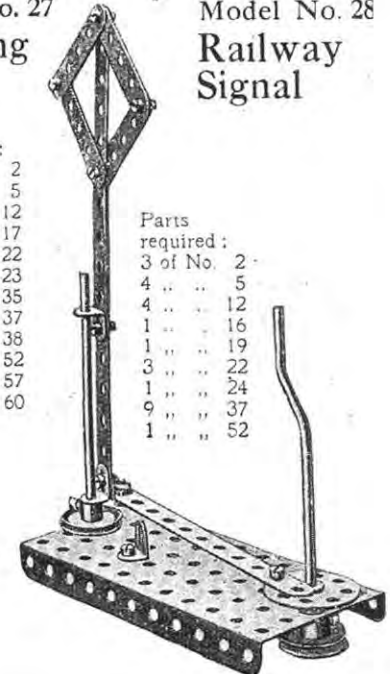
Parts required:	
4 of No. 2	2
4 " " 12	12
1 " " 16	16
4 " " 22	22
10 " " 37	37
2 " " 38	38
1 " " 52	52

Model No. 27  
Hoisting  
Block



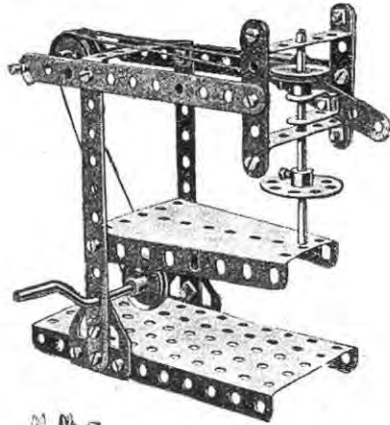
Parts required:	
4 of No. 2	2
6 " " 5	5
6 " " 12	12
1 " " 17	17
1 " " 22	22
1 " " 23	23
2 " " 35	35
25 " " 37	37
3 " " 38	38
1 " " 52	52
1 " " 57	57
2 " " 60	60

Model No. 28  
Railway  
Signal



Parts required:	
3 of No. 2	2
4 " " 5	5
4 " " 12	12
1 " " 16	16
1 " " 19	19
3 " " 22	22
1 " " 24	24
9 " " 37	37
1 " " 52	52

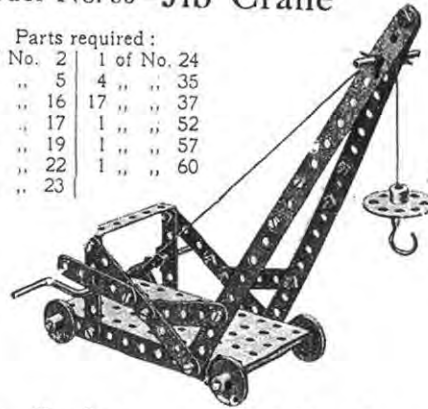
### Model No. 29—Drilling Machine



Parts required:

4 of No. 2	2
3 " " 5	5
1 " " 11	11
2 " " 16	16
1 " " 19	19
4 " " 22	22
1 " " 24	24
4 " " 35	35
19 " " 37	37
1 " " 44	44
1 " " 52	52
1 " " 54	54
3 " " 60	60
2 " " 126A	126A

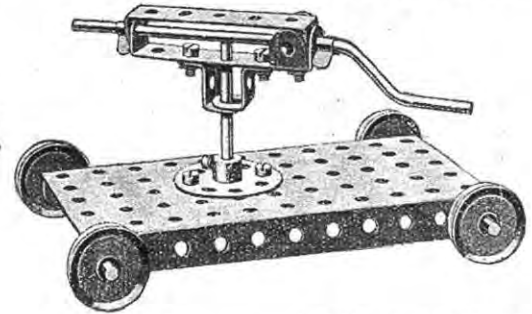
### Model No. 30—Jib Crane



Parts required:

4 of No. 2	1 of No. 24
9 " " 5	4 " " 35
2 " " 16	17 " " 37
1 " " 17	1 " " 52
1 " " 19	1 " " 57
4 " " 22	1 " " 60
1 " " 23	

### Model No. 31—Rock Drill



Parts required:

1 of No. 19	4 of No. 37
4 " " 22	1 " " 52
2 of No. 16	2 " " 60
1 " " 17	2 " " 125

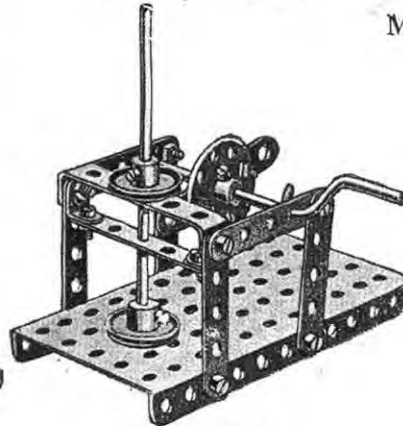
### Model No. 33—Swing



Parts required.

4 of No. 2	20 of No. 37
4 " " 5	1 " " 52
6 " " 12	1 " " 60

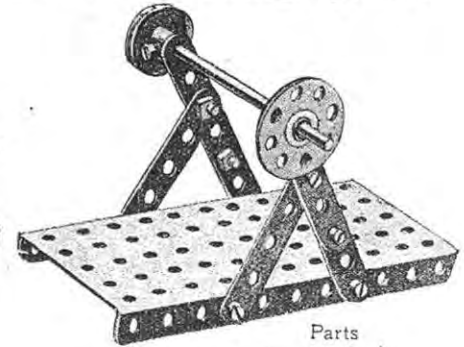
### Model No. 34 Ore Crusher



Parts required:

6 of No. 5	1 of No. 24
2 " " 10	2 " " 35
1 " " 16	10 " " 37
1 " " 19	1 " " 52
2 " " 22	2 " " 60

### Model No. 35—Buffing Spindle

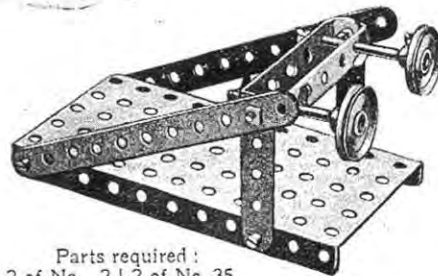
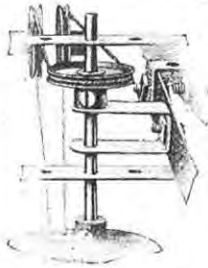


Parts required:

6 of No. 5	
1 " " 16	
1 " " 22	
1 " " 24	
8 " " 37	
1 " " 52	

FIG. 29A  
Detail of  
Drilling  
Machine.

### Model No. 32 Buffers



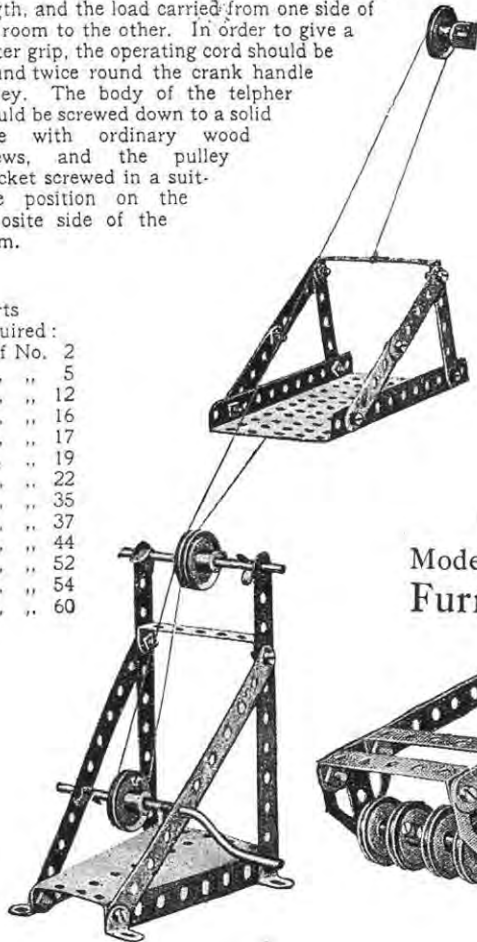
Parts required:

2 of No. 2	2 of No. 35
2 " " 5	6 " " 37
2 " " 17	1 " " 52
2 " " 22	2 " " 60

### Model No. 36—Telpher Span

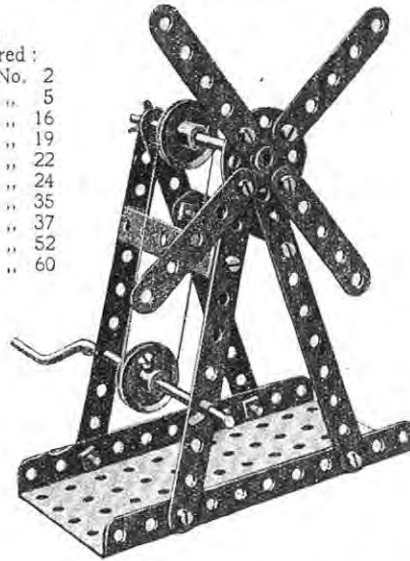
Many hours of enjoyment may be obtained from this model. The illustration shows exactly how it is worked. The cords may be made to any length, and the load carried from one side of the room to the other. In order to give a better grip, the operating cord should be wound twice round the crank handle pulley. The body of the telpher should be screwed down to a solid base with ordinary wood screws, and the pulley bracket screwed in a suitable position on the opposite side of the room.

- Parts required:
- 4 of No. 2
  - 6 " " 5
  - 4 " " 12
  - 1 " " 16
  - 1 " " 17
  - 1 " " 19
  - 4 " " 22
  - 6 " " 35
  - 14 " " 37
  - 1 " " 44
  - 1 " " 52
  - 1 " " 54
  - 2 " " 60



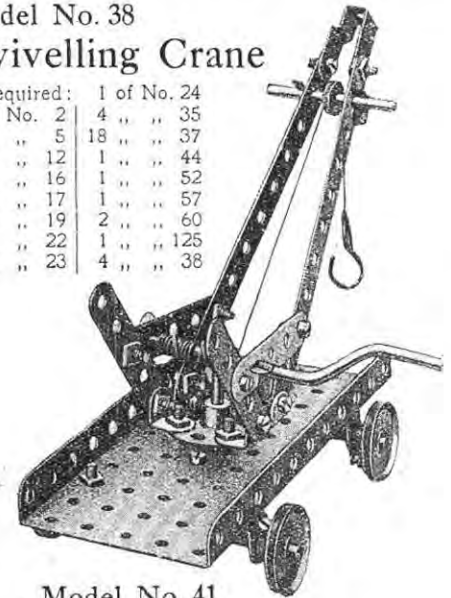
### Model No. 37—Windmill

- Parts required:
- 4 of No. 2
  - 4 " " 5
  - 1 " " 16
  - 1 " " 19
  - 2 " " 22
  - 1 " " 24
  - 4 " " 35
  - 12 " " 37
  - 1 " " 52
  - 2 " " 60

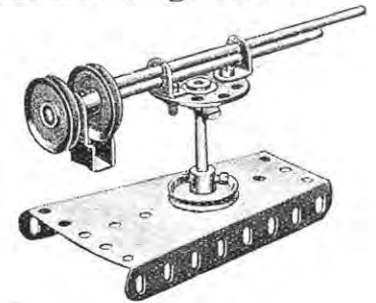


### Model No. 38 Swivelling Crane

- Parts required:
- |            |             |           |
|------------|-------------|-----------|
| 2 of No. 2 | 1 of No. 24 | 4 " " 35  |
| 4 " " 5    | 18 " " 37   | 1 " " 44  |
| 4 " " 12   | 1 " " 52    | 1 " " 57  |
| 2 " " 16   | 1 " " 60    | 2 " " 125 |
| 1 " " 19   | 1 " " 23    | 4 " " 38  |

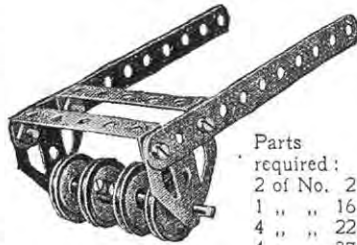


### Model No. 41 Quick-Firing Gun



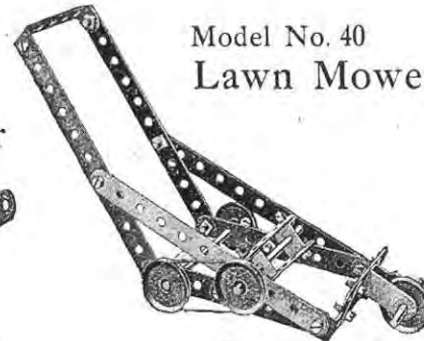
- Parts required:
- |             |             |
|-------------|-------------|
| 2 of No. 12 | 4 of No. 37 |
| 2 " " 16    | 1 " " 44    |
| 1 " " 17    | 1 " " 54    |
| 1 " " 24    |             |

### Model No. 39 Furrow Roller



- Parts required:
- 2 of No. 2
  - 1 " " 16
  - 4 " " 22
  - 4 " " 37
  - 2 " " 60
  - 2 " " 126A

### Model No. 40 Lawn Mower



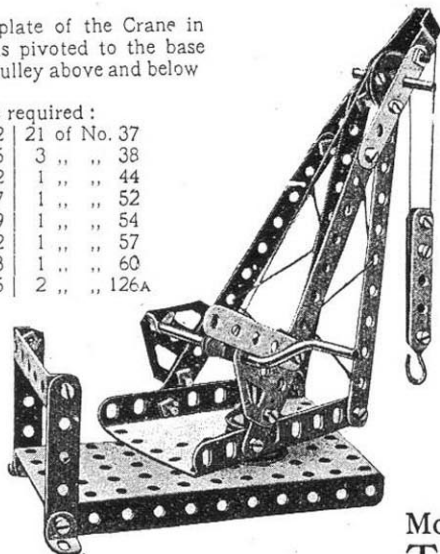
- Parts required:
- |            |             |
|------------|-------------|
| 4 of No. 2 | 4 of No. 22 |
| 7 " " 5    | 19 " " 37   |
| 2 " " 11   | 1 " " 44    |
| 2 " " 16   | 3 " " 60    |
| 1 " " 17   |             |

### Model No. 42—Swivelling Crane

The sector plate of the Crane in this model is pivoted to the base with a fast pulley above and below

Parts required:

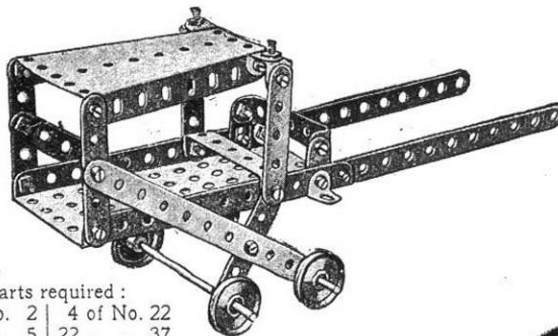
4 of No. 2	21 of No. 37
7 " " 5	3 " " 38
2 " " 12	1 " " 44
2 " " 17	1 " " 52
1 " " 19	1 " " 54
4 " " 22	1 " " 57
1 " " 23	1 " " 60
2 " " 35	2 " " 126A



### Model No. 43—Ticca Gharry

Parts required:

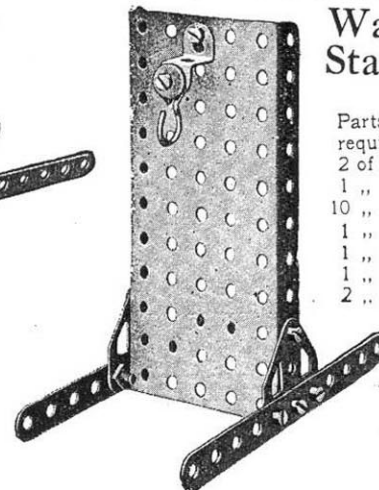
4 of No. 2	4 of No. 22
6 " " 5	22 " " 37
2 " " 10	1 " " 52
6 " " 12	1 " " 54
2 " " 16	



### Model No. 44 Watch Stand

Parts required:

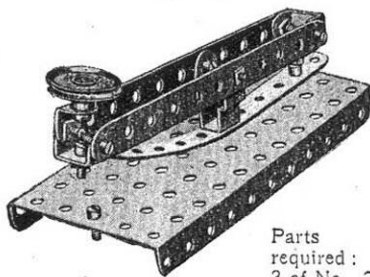
2 of No. 2
1 " " 23
10 " " 37
1 " " 52
1 " " 57
1 " " 125
2 " " 126A



### Model No. 46 Telegraph Key

Parts required:

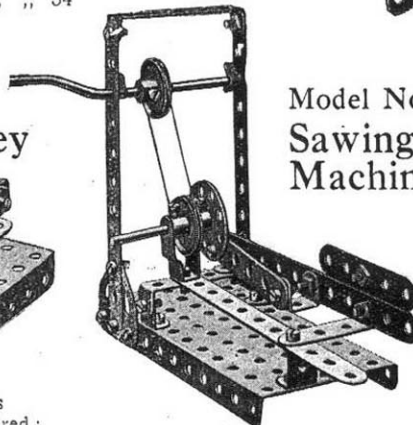
3 of No. 2
1 " " 10
2 " " 11
1 " " 12
1 " " 22
11 " " 37
1 " " 44
1 " " 52



### Model No. 47 Sawing Machine

Parts required:

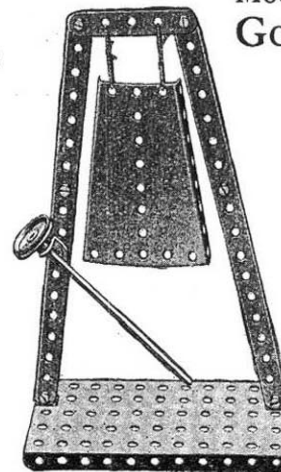
4 of No. 2	2 of No. 35
3 " " 5	23 " " 37
4 " " 12	1 " " 44
1 " " 17	1 " " 52
1 " " 19	2 " " 60
2 " " 22	2 " " 126A
1 " " 24	



### Model No. 48 Gong

Parts required:

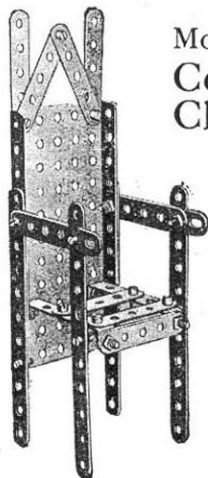
4 of No. 2
1 " " 5
3 " " 12
1 " " 16
1 " " 22
7 " " 37
1 " " 52
1 " " 54

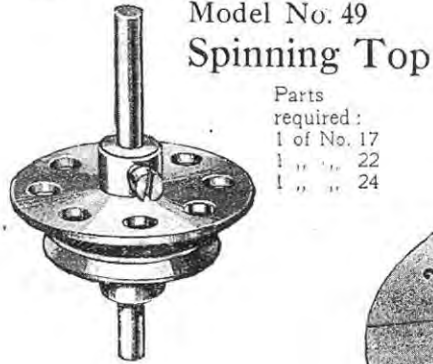


### Model No. 45 Coronation Chair

Parts required:

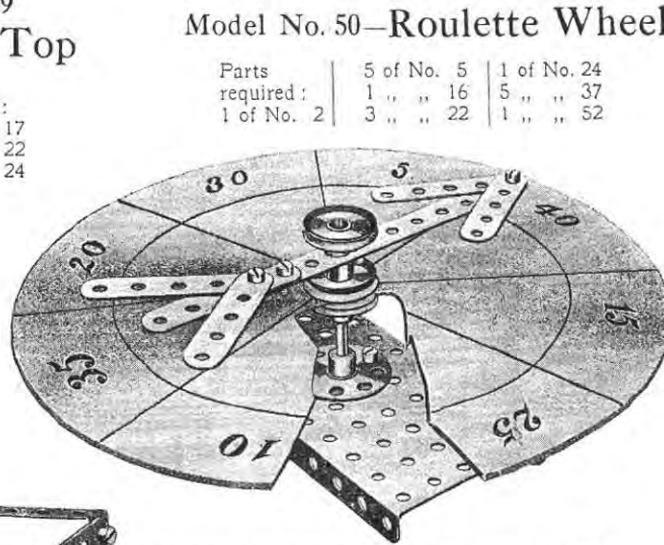
4 of No. 2
9 " " 5
2 " " 10
2 " " 12
19 " " 37
1 " " 52
2 " " 60





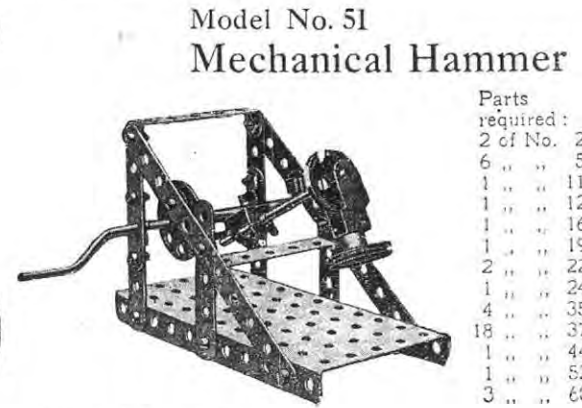
Model No. 49  
Spinning Top

Parts  
required:  
1 of No. 17  
1 " " 22  
1 " " 24



Model No. 50—Roulette Wheel

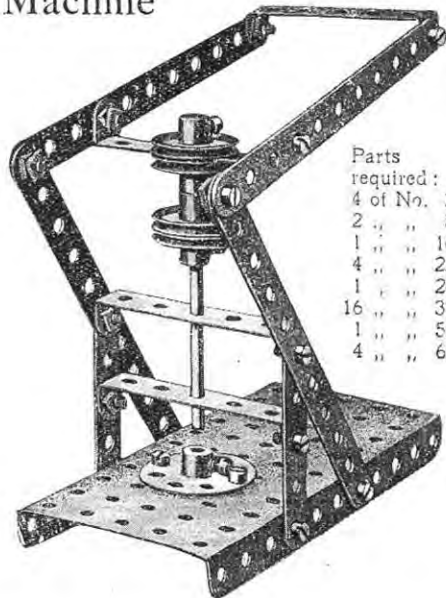
Parts required:	5 of No. 5	1 of No. 24
	1 " " 16	5 " " 37
	1 of No. 2	3 " " 22
		1 " " 52



Model No. 51  
Mechanical Hammer

Parts  
required:  
2 of No. 2  
6 " " 5  
1 " " 11  
1 " " 12  
1 " " 16  
1 " " 19  
2 " " 22  
1 " " 24  
4 " " 35  
18 " " 37  
1 " " 44  
1 " " 52  
3 " " 60

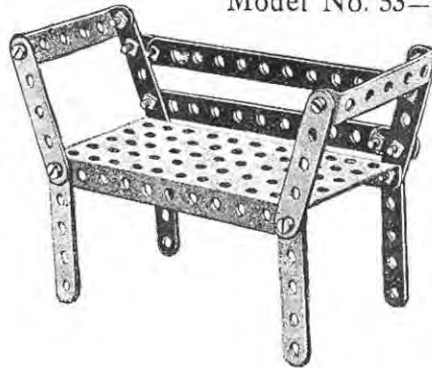
Model No. 52  
Punching  
Machine



Parts  
required:  
4 of No. 2  
2 " " 5  
1 " " 16  
4 " " 22  
1 " " 24  
16 " " 37  
1 " " 52  
4 " " 60

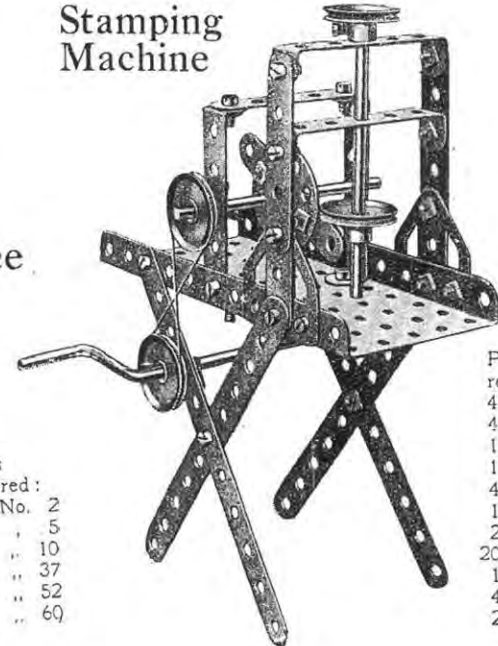
Cut out a circular piece of cardboard and mark as shown to form scoring board. This is clamped between two 1" pulley wheels. The pointer revolves freely on the upright spindle and is held in position by another 1" pulley wheel.

Model No. 53—Settee



Parts  
required:  
2 of No. 2  
8 " " 5  
3 " " 10  
15 " " 37  
1 " " 52  
2 " " 60

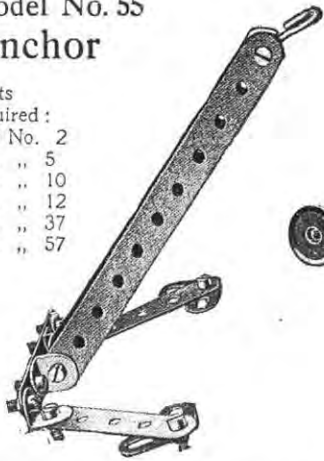
Model No. 54  
Stamping  
Machine



Parts  
required:  
4 of No. 2  
4 " " 5  
1 " " 16  
1 " " 19  
4 " " 22  
1 " " 24  
2 " " 35  
20 " " 37  
1 " " 52  
4 " " 60  
2 " " 126A

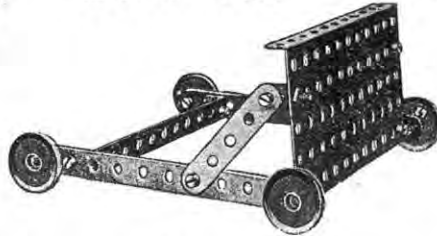
**Model No. 55  
Anchor**

Parts  
required:  
2 of No. 2  
3 " " 5  
4 " " 10  
4 " " 12  
11 " " 37  
1 " " 57



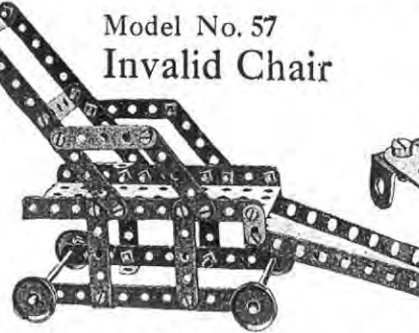
**Model No. 56  
Devil Wall**

Parts required:  
3 of No. 2 | 4 of No. 22  
2 " " 5 | 18 " " 37  
6 " " 12 | 1 " " 52



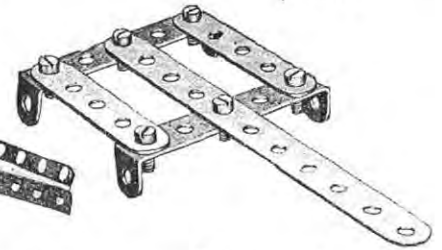
**Model No. 57  
Invalid Chair**

Parts required:  
2 of No. 10 | 1 of No. 52  
2 " " 16 | 1 " " 54  
4 of No. 2 | 4 " " 22 | 4 " " 60  
6 " " 5 | 24 " " 37



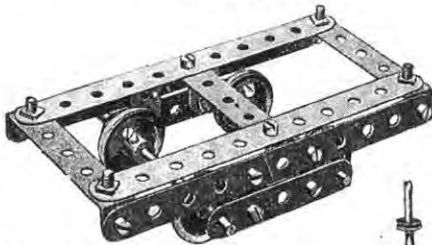
**Model No. 58  
Grill**

Parts required:  
1 of No. 2 | 6 of No. 37  
2 " " 5 | 2 " " 60



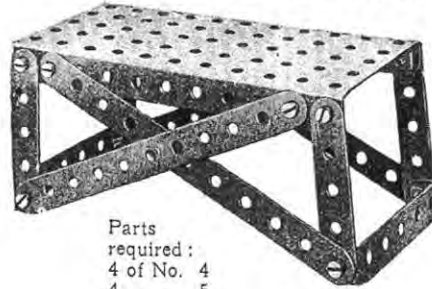
**Model No. 59—Bogie Car**

Parts  
required:  
4 of No. 2  
3 " " 5  
4 " " 10  
2 " " 16  
4 " " 22  
18 " " 37



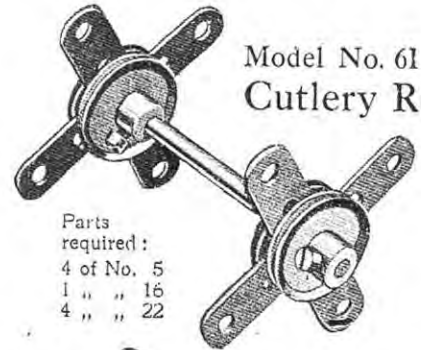
**Model No. 60—Fire Stand**

Parts  
required:  
4 of No. 4  
4 " " 5  
12 " " 37  
1 " " 52  
2 " " 60

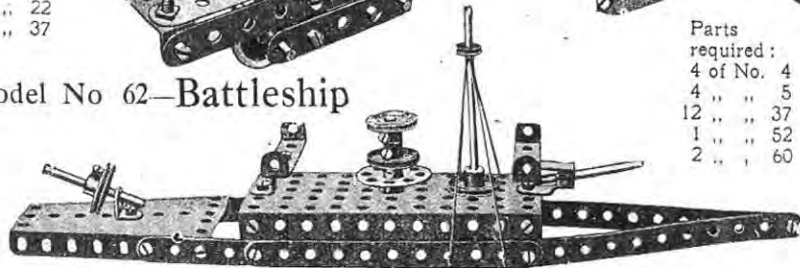


**Model No. 61  
Cutlery Rest**

Parts  
required:  
4 of No. 5  
1 " " 16  
4 " " 22



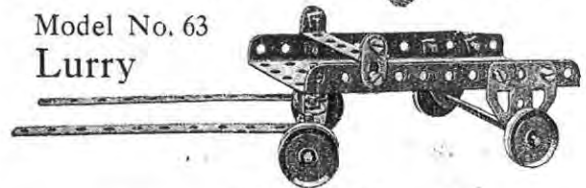
**Model No 62—Battleship**



Parts required:  
4 of No. 2 | 1 of No. 16 | 1 of No. 24 | 1 of No. 52  
3 " " 5 | 2 " " 17 | 3 " " 35 | 1 " " 54  
4 " " 10 | 4 " " 22 | 19 " " 37 | 2 " " 60  
1 " " 12 | 1 " " 23 | 1 " " 44 | 1 " " 125

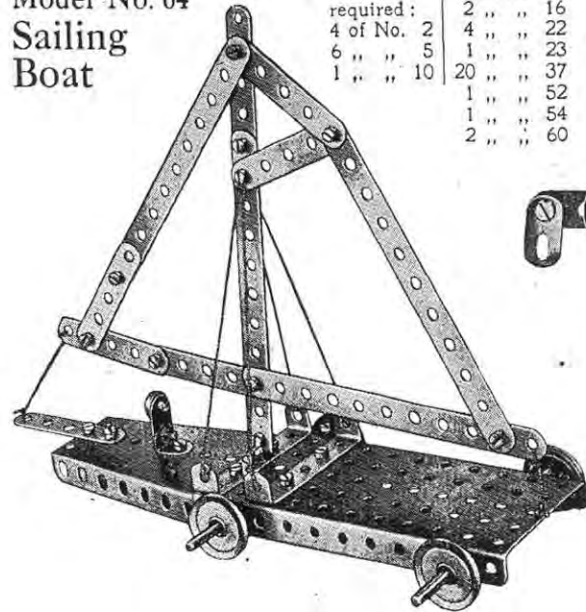
**Model No. 63  
Lurry**

Parts required:  
2 of No. 2 | 2 of No. 16 | 1 of No. 52  
2 " " 10 | 4 " " 22 | 2 " " 60  
1 " " 11 | 12 " " 37 | 2 " " 126A



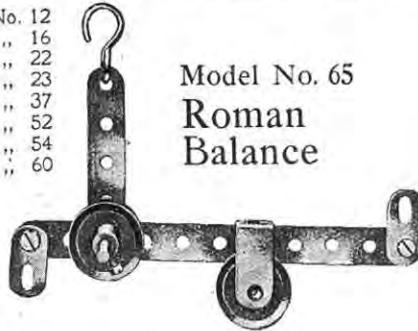
These Models can be made with MECCANO Outfit No. 0

Model No. 64  
Sailing  
Boat



Parts required:	6 of No. 12
2 " " 16	
4 of No. 2	4 " " 22
6 " " 5	1 " " 23
1 " " 10	20 " " 37
	1 " " 52
	1 " " 54
	2 " " 60

Model No. 65  
Roman  
Balance



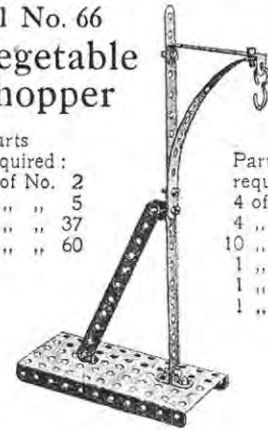
Parts required:	
1 of No. 2	3 of No. 22
1 " " 5	3 " " 37
2 " " 10	1 " " 44
1 " " 17	1 " " 57

Model No. 66  
Vegetable  
Chopper



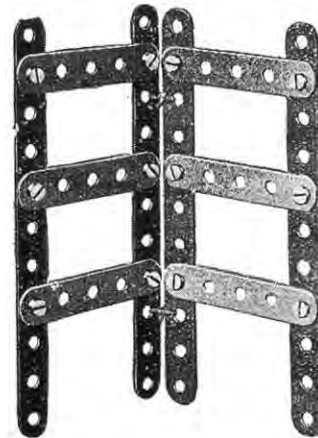
Parts required:	
4 of No. 2	
4 " " 5	
18 " " 37	
4 " " 60	

Model No. 67  
Mail-Bag  
Hanger



Parts required:	
4 of No. 2	
4 " " 12	
10 " " 37	
1 " " 52	
1 " " 57	
1 " " 60	

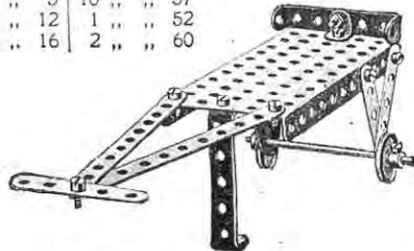
Model No. 69  
Clothes Horse



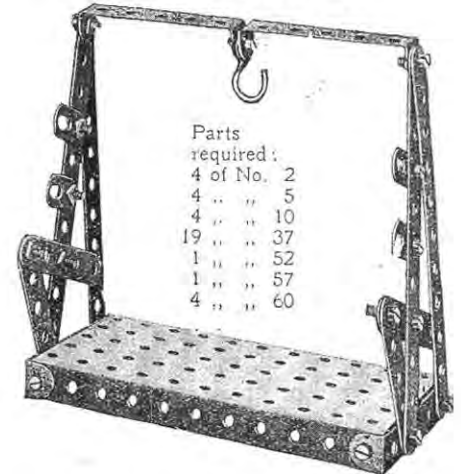
Parts required:	
4 of No. 2	
6 " " 5	
12 " " 37	

Model No. 68—Shipyard Bogie

Parts required:	
2 of No. 2	2 of No. 22
5 " " 5	10 " " 37
1 " " 12	1 " " 52
1 " " 16	2 " " 60



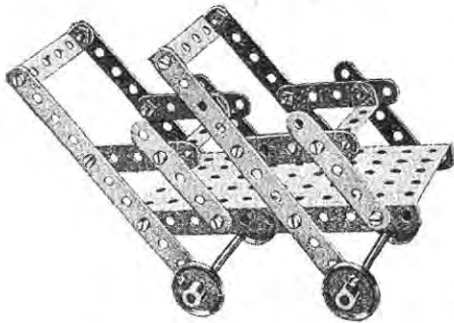
Model No. 70  
Pen Rack



Parts required:	
4 of No. 2	
4 " " 5	
4 " " 10	
19 " " 37	
1 " " 52	
1 " " 57	
4 " " 60	

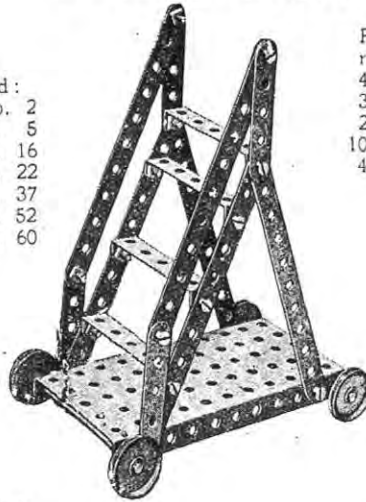


Model No. 101  
Tandem Car



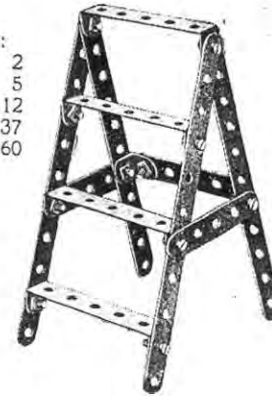
Parts  
required:  
6 of No. 2  
4 " " 5  
2 " " 16  
4 " " 22  
16 " " 37  
1 " " 52  
4 " " 60

Model No. 102  
Travelling Ladder

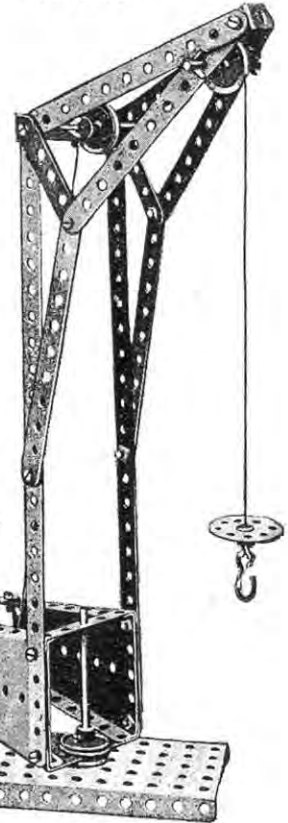


Parts  
required:  
4 of No. 2  
3 " " 5  
2 " " 12  
10 " " 37  
4 " " 60

Model No. 103  
Step Ladder

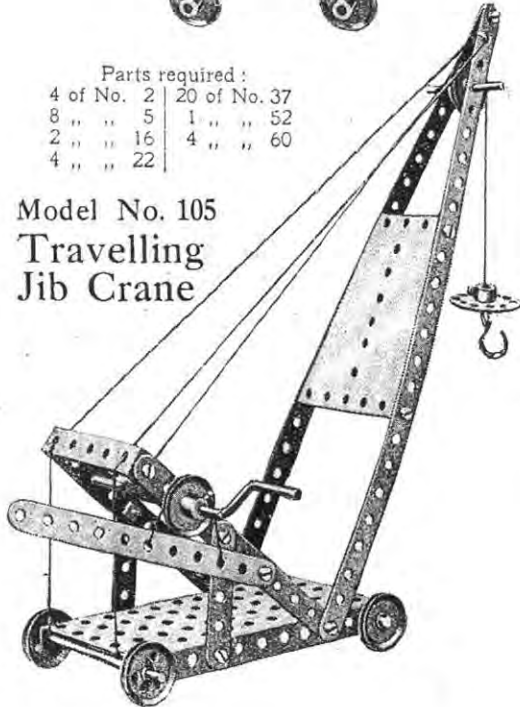


Model No. 104  
Swivelling  
Crane



Parts required:  
4 of No. 2 | 20 of No. 37  
8 " " 5 | 1 " " 52  
2 " " 16 | 4 " " 60  
4 " " 22

Model No. 105  
Travelling  
Jib Crane



Parts  
required:  
2 of No. 1  
3 " " 2  
2 " " 5  
2 " " 16  
1 " " 17  
1 " " 19  
4 " " 22  
2 of No. 22A  
1 " " 24  
5 " " 35  
15 " " 37  
1 " " 52  
1 " " 54  
1 " " 57  
1 " " 60

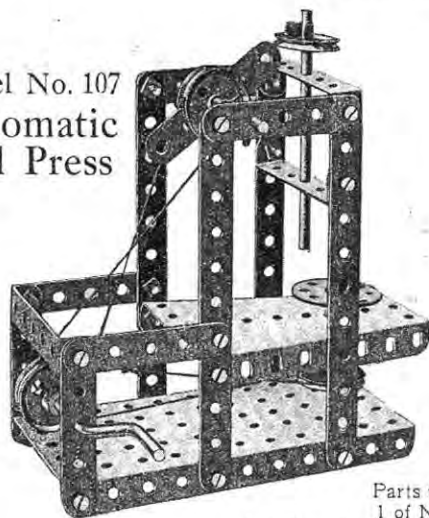
Model No. 106  
Swing



Parts required  
4 of No. 1  
1 " " 2  
6 " " 5  
4 " " 12  
12 " " 37  
1 " " 52  
3 " " 60

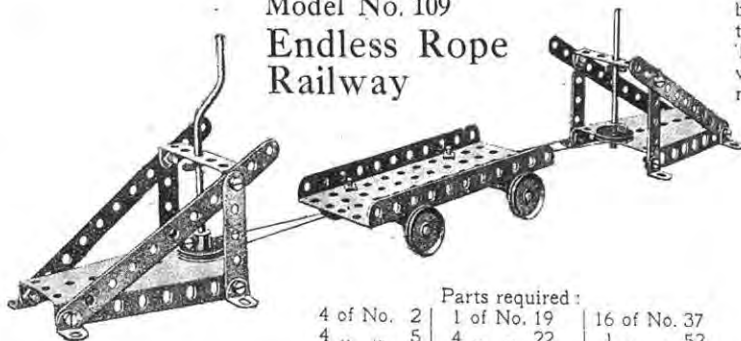
Parts required:  
2 of No. 1 | 2 of No. 17 | 18 of No. 37  
6 " " 2 | 1 " " 19 | 1 " " 44  
1 " " 3 | 4 " " 22 | 1 " " 52  
4 " " 5 | 2 " " 22A | 2 " " 54  
1 " " 11 | 1 " " 24 | 1 " " 57  
1 " " 16 | 4 " " 35 | 3 " " 60

Model No. 107  
Automatic  
Dial Press



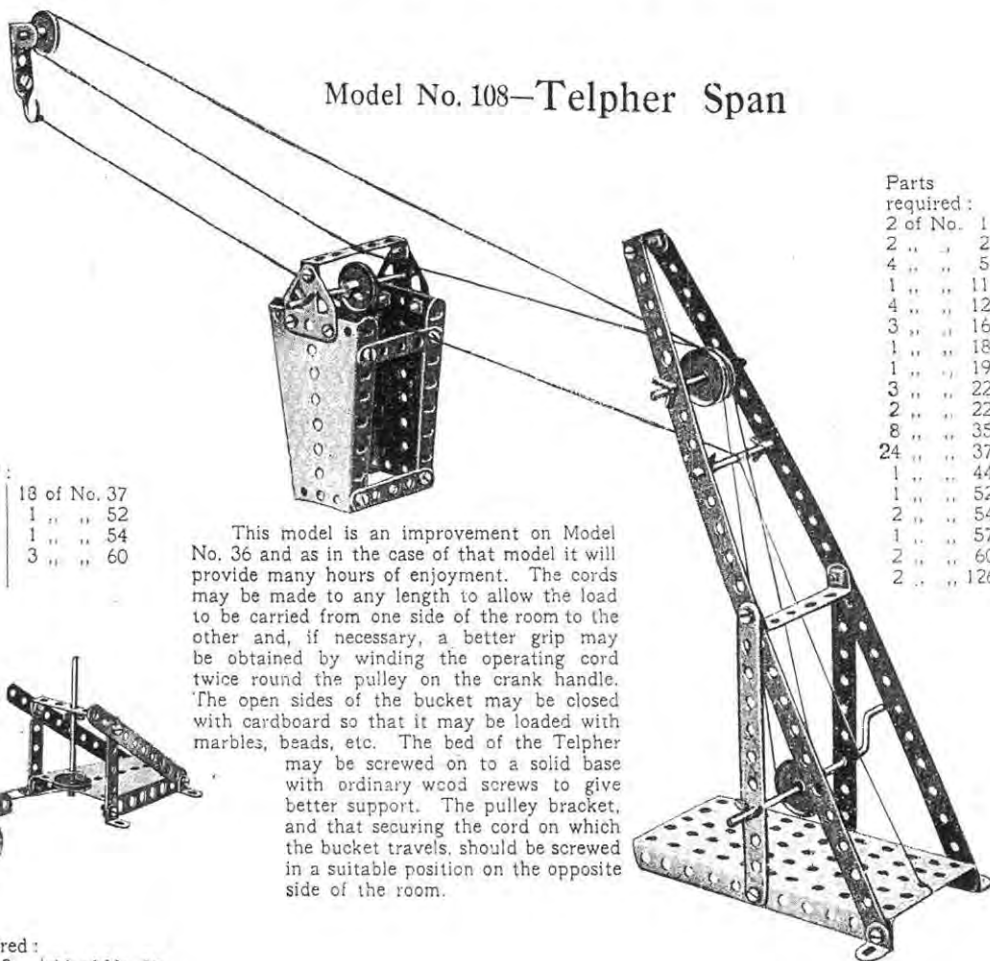
Parts required:		
4 of No. 2	1 of No. 19	18 of No. 37
7 " " 5	4 " " 22	1 " " 52
2 " " 16	2 " " 22A	1 " " 54
1 " " 17	1 " " 24	3 " " 60
	7 " " 35	

Model No. 109  
Endless Rope  
Railway



Parts required:		
4 of No. 2	1 of No. 19	16 of No. 37
4 " " 5	4 " " 22	1 " " 52
8 " " 12	2 " " 22A	2 " " 54
3 " " 16	4 " " 35	4 " " 60

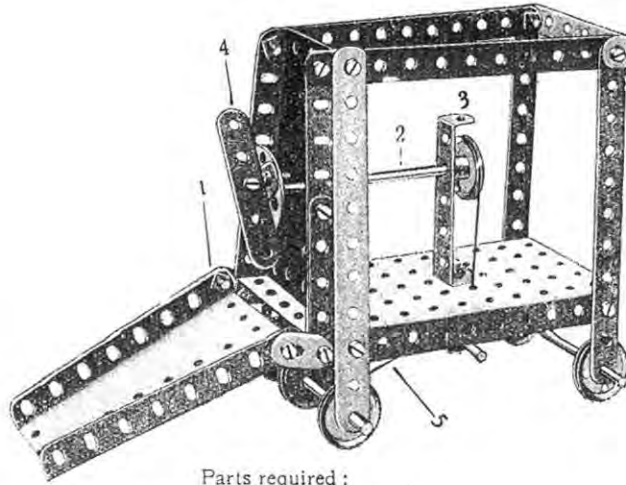
Model No. 108—Telpher Span



This model is an improvement on Model No. 36 and as in the case of that model it will provide many hours of enjoyment. The cords may be made to any length to allow the load to be carried from one side of the room to the other and, if necessary, a better grip may be obtained by winding the operating cord twice round the pulley on the crank handle. The open sides of the bucket may be closed with cardboard so that it may be loaded with marbles, beads, etc. The bed of the Telpher may be screwed on to a solid base with ordinary wood screws to give better support. The pulley bracket, and that securing the cord on which the bucket travels, should be screwed in a suitable position on the opposite side of the room.

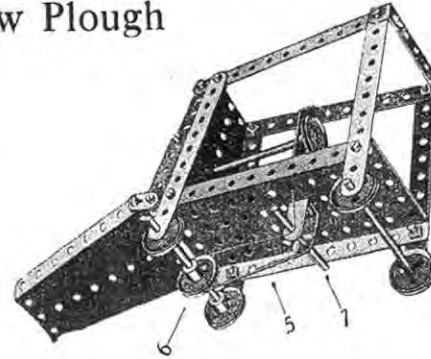
Parts required:	
2 of No. 1	1
2 " " 2	2
4 " " 5	5
1 " " 11	11
4 " " 12	12
3 " " 16	16
1 " " 18	18
1 " " 19	19
3 " " 22	22
2 " " 22A	22A
8 " " 35	35
24 " " 37	37
1 " " 44	44
1 " " 52	52
2 " " 54	54
1 " " 57	57
2 " " 60	60
2 " " 126A	126A

### Model No. 110—Snow Plough

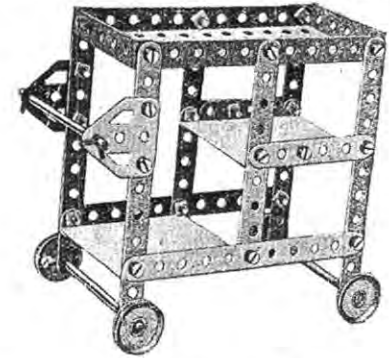


Parts required :

6 of No. 2	1 of No. 24
3 " " 5	4 " " 35
2 " " 10	19 " " 37
1 " " 12	1 " " 44
3 " " 16	1 " " 52
1 " " 17	2 " " 54
4 " " 22	2 " " 60
2 " " 22A	



### Model No. 111—Dinner Wagon

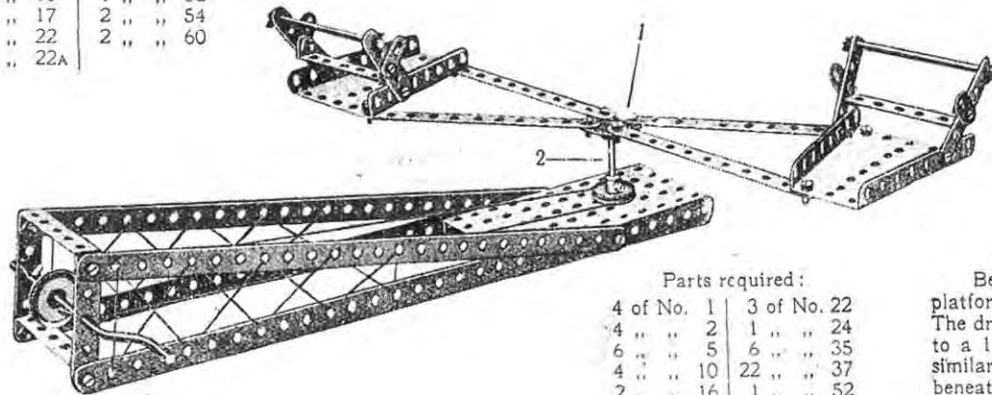


The construction of the framework of this model presents no difficulty. The sector plate forming the plough is loosely pivoted on the bolts (1). The axle (2) is mounted in the front sector plate and the  $2\frac{1}{2}$ " bent strip (3). A  $2\frac{1}{2}$ " strip (4) is bolted by angle brackets to a bush wheel on the front of the axle and forms a dispersing propeller for the snow after it has risen up the inclined sector plate. A continuous cord (5) is passed round a 1" pulley (6) and round the short axle (7) and a 1" pulley on the propeller axle. In this way, as the plough is moved along the ground, the propeller is revolved.

Parts required :

6 of No. 2	2 of No. 35
8 " " 5	22 " " 37
4 " " 12	1 " " 52
3 " " 16	4 " " 60
4 " " 22	2 " " 126A

The two lower platforms are constructed out of pieces of ordinary cardboard, their outer edges resting on  $2\frac{1}{2}$ " bent strips and their inner edges on angle brackets.



### Model No. 112—Roundabout

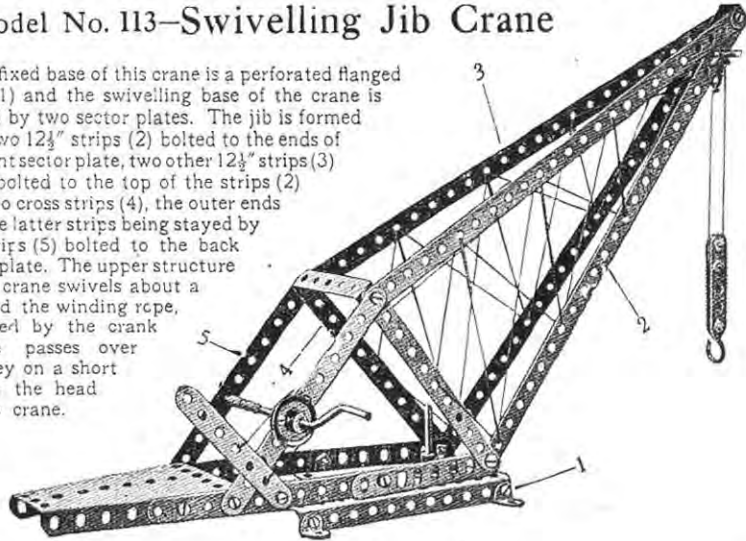
Parts required :

4 of No. 1	3 of No. 22
4 " " 2	1 " " 24
6 " " 5	6 " " 35
4 " " 10	22 " " 37
2 " " 16	1 " " 52
1 " " 17	2 " " 54
1 " " 19	4 " " 60

Begin to build this model by making the platform from a flanged plate and  $1\frac{1}{2}$ " strips. The drive from the pulley on the crank is taken to a 1" pulley fast on a spindle (2), another similar pulley being secured to the spindle beneath the plate. The arms are formed of four  $5\frac{1}{2}$ " strips and bolted to a bush wheel (1) fast on the spindle.

### Model No. 113—Swivelling Jib Crane

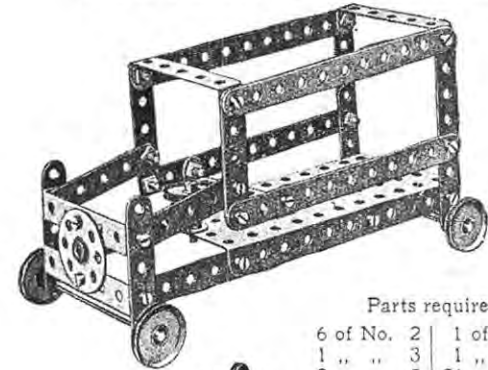
The fixed base of this crane is a perforated flanged plate (1) and the swivelling base of the crane is formed by two sector plates. The jib is formed from two 12½" strips (2) bolted to the ends of the front sector plate, two other 12½" strips (3) being bolted to the top of the strips (2) and two cross strips (4), the outer ends of these latter strips being stayed by the strips (5) bolted to the back sector plate. The upper structure of the crane swivels about a rod and the winding rope, operated by the crank handle passes over a pulley on a short rod in the head of the crane.



Parts required:

4	of No.	1
6	" "	2
1	" "	3
2	" "	5
1	" "	10
1	" "	11
4	" "	12
2	" "	17
1	" "	19
3	" "	22
1	" "	22A
1	" "	23
3	" "	35
20	" "	37
3	" "	38
1	" "	52
2	" "	54
1	" "	57
1	" "	60

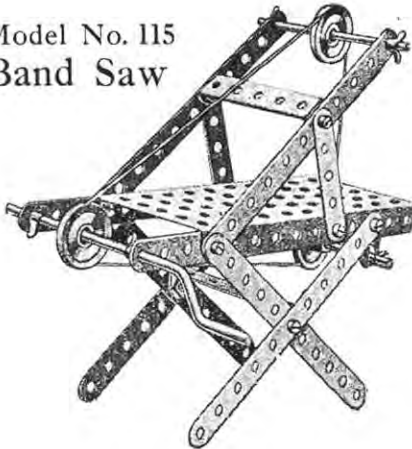
### Model No. 114—Motor Van



Parts required:

6	of No.	2	1	of No.	22A
1	" "	3	1	" "	24
9	" "	5	26	" "	37
1	" "	11	1	" "	52
2	" "	16	5	" "	60
4	" "	22			

### Model No. 115 Band Saw

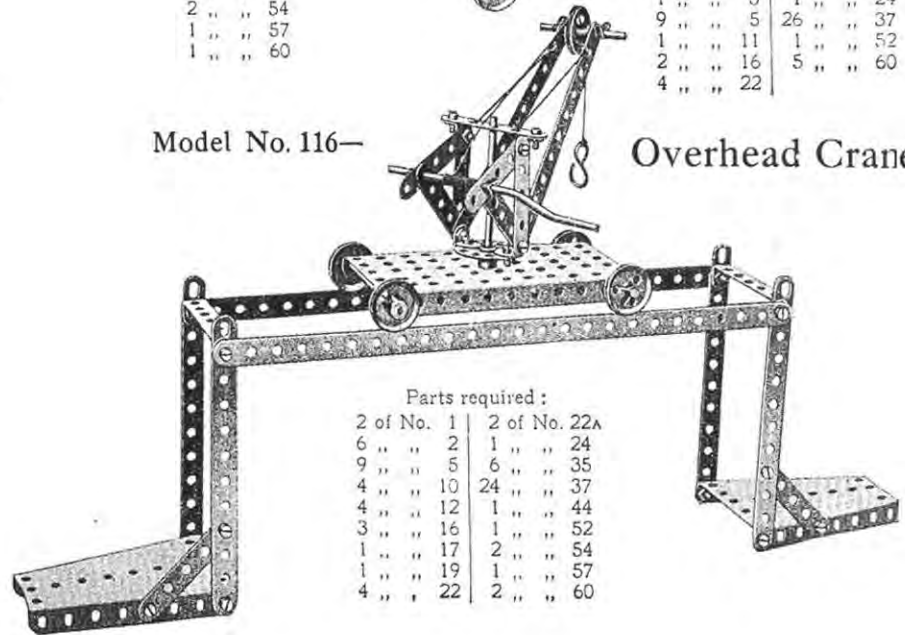


Parts required:

6	of No.	2
4	" "	5
2	" "	10
2	" "	16
1	" "	19
3	" "	22
6	" "	35
10	" "	37
1	" "	52
2	" "	60

### Model No. 116—

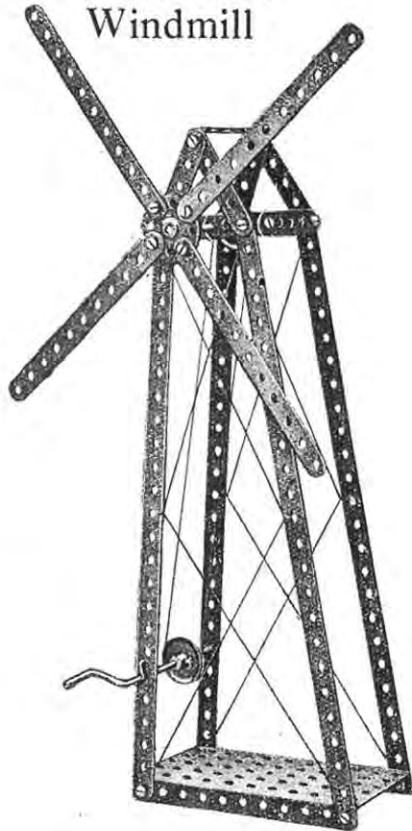
### Overhead Crane



Parts required:

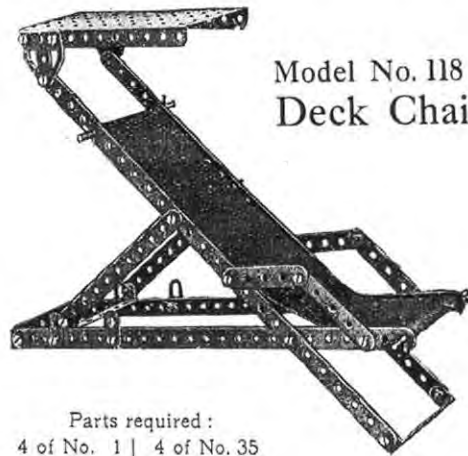
2	of No.	1	2	of No.	22A
6	" "	2	1	" "	24
9	" "	5	6	" "	35
4	" "	10	24	" "	37
4	" "	12	1	" "	44
3	" "	16	1	" "	52
1	" "	17	2	" "	54
1	" "	19	1	" "	57
4	" "	22	2	" "	60

Model No. 117  
Windmill



Parts required:

4 of No. 1	2 of No. 22
4 " " 2	1 " " 24
7 " " 5	4 " " 35
2 " " 12	20 " " 37
1 " " 16	1 " " 52
1 " " 19	3 " " 60



Model No. 118  
Deck Chair

Parts required:

4 of No. 1	4 of No. 35
2 " " 2	26 " " 37
4 " " 5	1 " " 52
4 " " 10	3 " " 60
2 " " 16	2 " " 126A

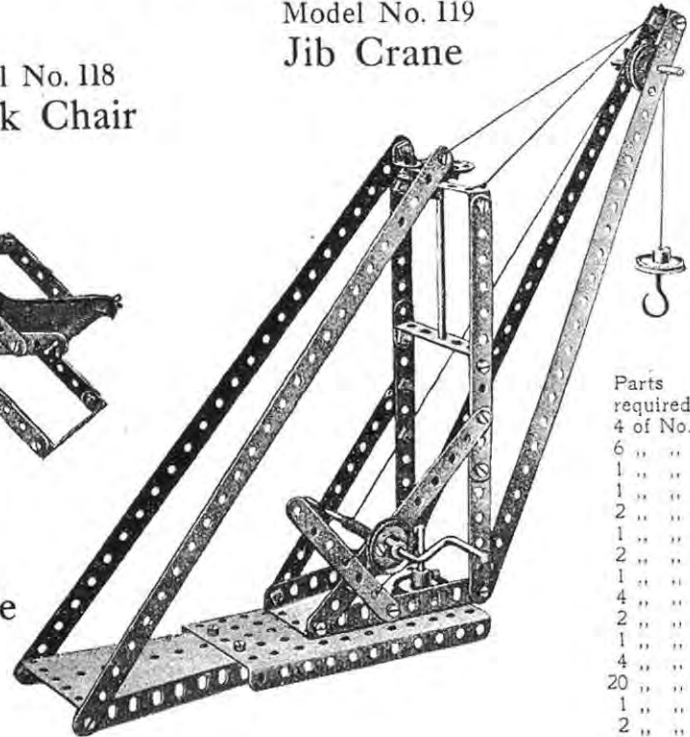
Model No. 120—Bed Table



Parts required:

3 of No. 2
1 " " 3
1 " " 5
1 " " 11
5 " " 12
2 " " 16
1 " " 17
4 " " 22
1 " " 24
21 " " 37
1 " " 52
4 " " 60
1 " " 126A

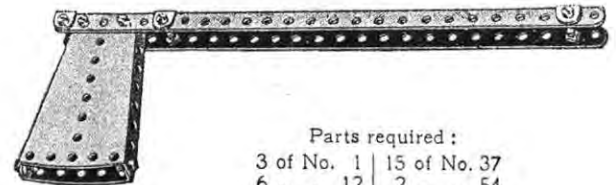
Model No. 119  
Jib Crane



Parts required:

4 of No. 1
6 " " 2
1 " " 3
1 " " 11
2 " " 12
1 " " 16
2 " " 17
1 " " 19
4 " " 22
2 " " 22A
1 " " 24
4 " " 35
20 " " 37
1 " " 52
2 " " 54
1 " " 57
2 " " 60

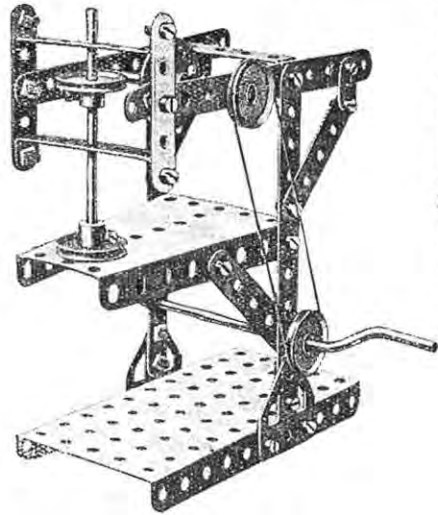
Model No. 121—Hatchet



Parts required:

3 of No. 1	15 of No. 37
6 " " 12	2 " " 54

Model No. 122  
Drop Stamp



Parts required:

4	of No. 2
6	" " 5
3	" " 10
2	" " 16
1	" " 19
4	" " 22
1	" " 24
2	" " 35
27	" " 37
1	" " 52
1	" " 54
3	" " 60
2	" " 126A

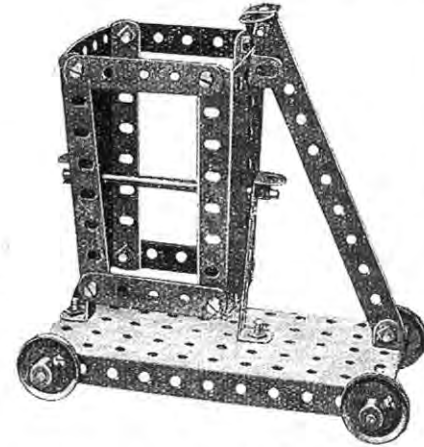
Model No. 123—Lathe



Parts required:

6	of No. 2	1	of No. 24
4	" " 12	17	" " 37
1	" " 17	1	" " 44
1	" " 19	1	" " 52
3	" " 22	2	" " 60

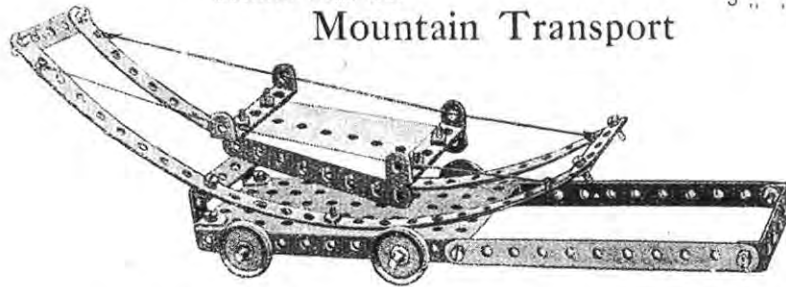
Model No. 124—Tip Wagon



Parts required:

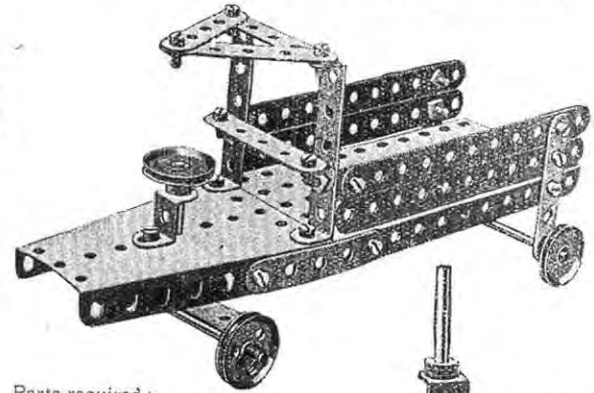
1	of No.
4	" " 1
5	" " 1
3	" " 2
4	" " 2
2	" " 3
14	" " 3
1	" " 5
2	" " 5
2	" " 6

Model No. 125  
Mountain Transport



2	of No. 1	3	of No. 5	2	of No. 16	15	of No. 37	1	of No. 54
2	" " 2	4	" " 12	4	" " 22	1	" " 52	2	" " 60

Model No. 126—Motor Lurry



Parts required:

4	of No. 2	3	of No. 22	3	of No. 38
8	" " 5	2	" " 22A	1	" " 52
4	" " 12	1	" " 24	1	" " 54
2	" " 16	2	" " 35	3	" " 60
1	" " 17	25	" " 37	2	" " 125

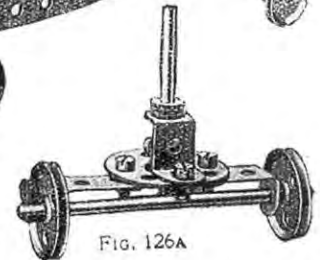
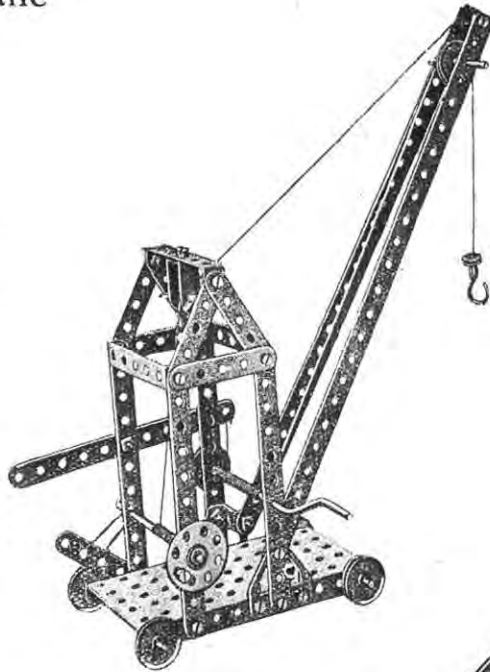


FIG. 126A

### Model No. 127 Jib Crane

Parts  
required :

2 of No.	1
5 "	2
7 "	5
1 "	11
3 "	16
1 "	17
1 "	18A
1 "	19
4 "	22
2 "	22A
1 "	23
1 "	24
6 "	35
22 "	37
2 "	38
1 "	44
1 "	52
1 "	57
3 "	60
2 "	125
2 "	126A

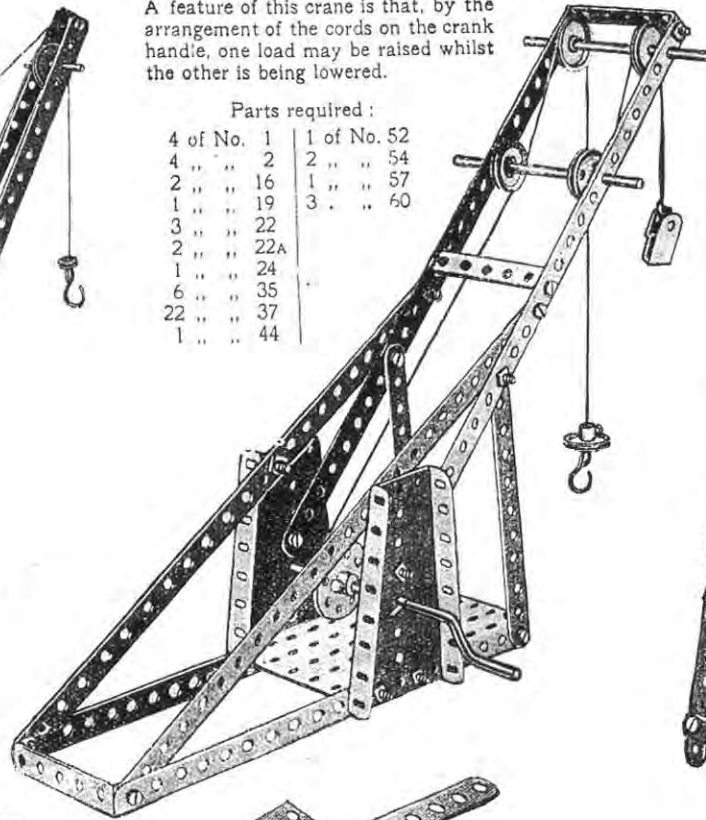


### Model No. 128—Double Action Crane

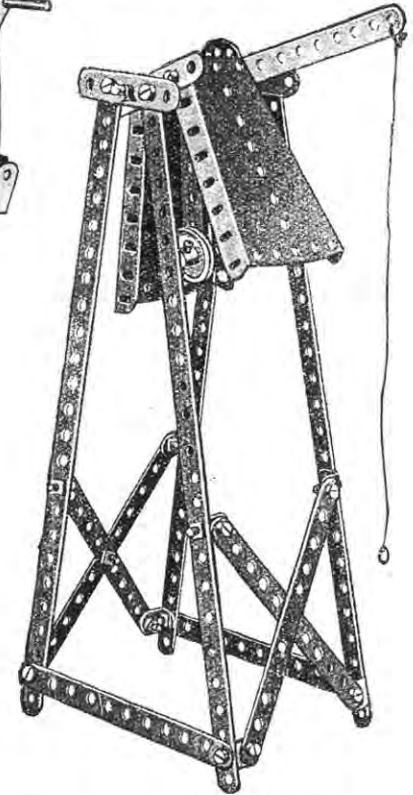
A feature of this crane is that, by the arrangement of the cords on the crank handle, one load may be raised whilst the other is being lowered.

Parts required :

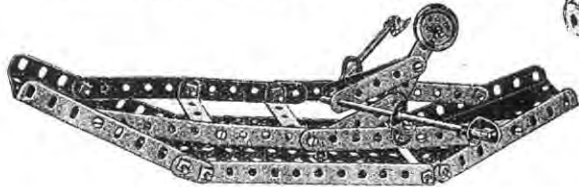
4 of No.	1	1 of No.	52
4 "	2	2 "	54
2 "	16	1 "	57
1 "	19	3 "	60
3 "	22		
2 "	22A		
1 "	24		
6 "	35		
22 "	37		
1 "	44		



### Model No. 129 Fire Alarm



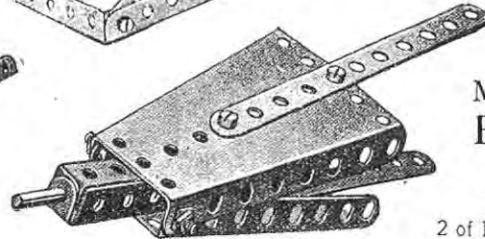
### Model No. 130—Rowing Boat



Parts required :

4 of No.	2	2 of No.	16	4 of No.	38
5 "	5	1 "	18A	1 "	52
4 "	10	2 "	22A	2 "	54
7 "	12	4 "	35	3 "	60
		24 "	37		

### Model No. 131 Bellows



Parts required :

2 of No.	2	2 of No.	54
1 "	17	4 "	60
9 "	37		

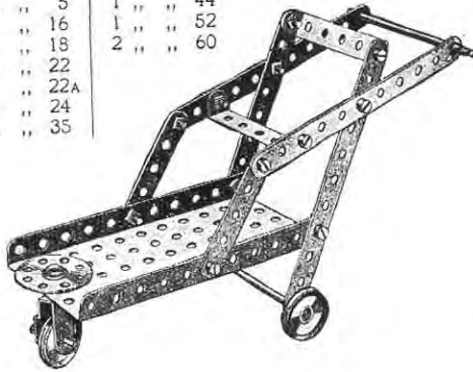
Parts required :

4 of No.	1	1 of No.	22
7 "	2	1 "	24
1 "	3	4 "	35
3 "	5	27 "	37
8 "	12	2 "	54
1 "	16		

Model No. 132—Invalid Chair

Parts required :

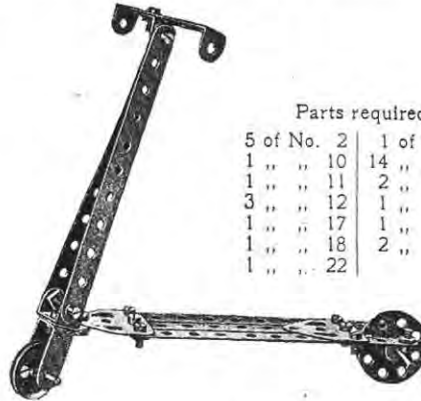
4 of No. 2	13 of No. 37
2 " " 5	1 " " 44
2 " " 16	1 " " 52
1 " " 18	2 " " 60
2 " " 22	
1 " " 22A	
1 " " 24	
4 " " 35	



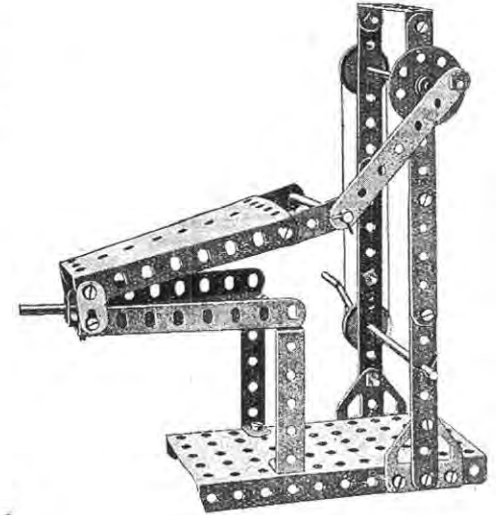
Model No. 133—Foot Cycle

Parts required :

5 of No. 2	1 of No. 24
1 " " 10	14 " " 37
1 " " 11	2 " " 38
3 " " 12	1 " " 44
1 " " 17	1 " " 60
1 " " 18	2 " " 126A
1 " " 22	



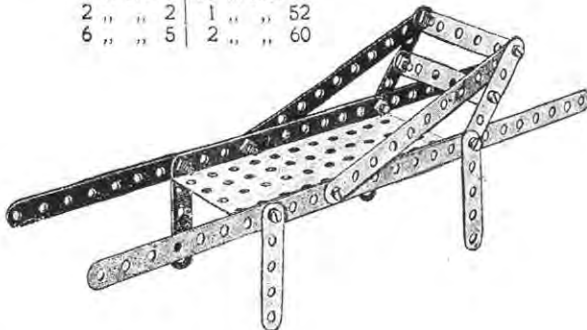
Model No. 134—Forge Bellows



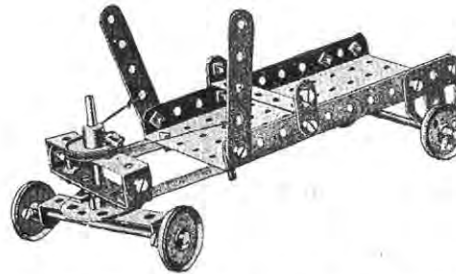
Model No. 135—Stretcher

Parts required :

2 of No. 1	10 of No. 37
2 " " 2	1 " " 52
6 " " 5	2 " " 60



Model No. 136  
Steering  
Truck



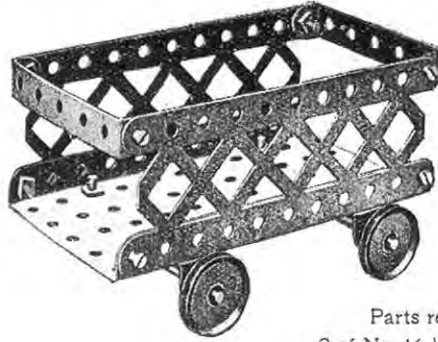
Parts required :	1 of No. 17	18 of No. 37
	3 " " 22	2 " " 38
4 of No. 5	2 " " 22A	1 " " 52
2 " " 10	1 " " 24	4 " " 60
2 " " 16	2 " " 35	2 " " 126A

Parts required :

4 of No. 2	1 of No. 19
1 " " 3	2 " " 22
2 " " 5	1 " " 24
2 " " 10	5 " " 35
1 " " 11	25 " " 37
2 " " 12	1 " " 52
2 " " 16	2 " " 54
1 " " 17	3 " " 60



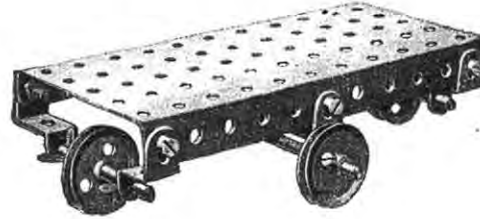
Model No. 201  
Truck



Parts required :

2 of No. 16	1 of No. 52
4 " " 22	4 " " 60
12 " " 37	2 " " 100

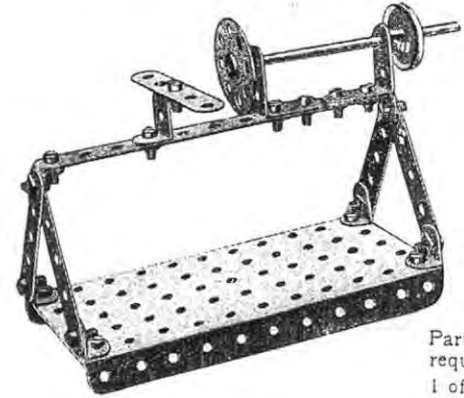
Model No. 202  
Revolving Truck



Parts required :

2 of No. 10	2 of No. 22	6 of No. 37
1 " " 16	2 " " 22A	1 " " 52
2 " " 17	4 " " 35	4 " " 125

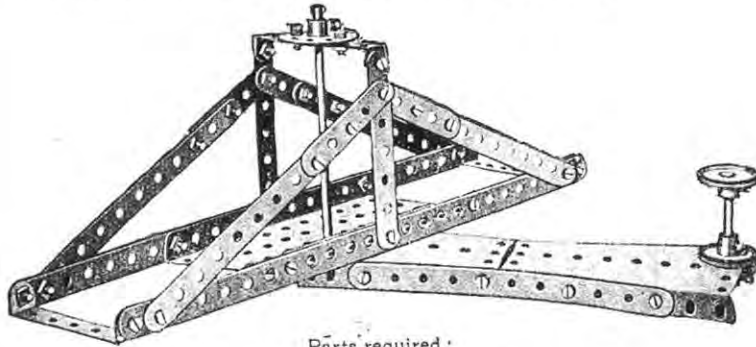
Model No. 203—Lathe



Parts required :

1 of No. 2
5 " " 5
6 " " 12
2 " " 12A
1 " " 16
1 " " 22
1 " " 24
17 " " 37
1 " " 52
1 " " 125

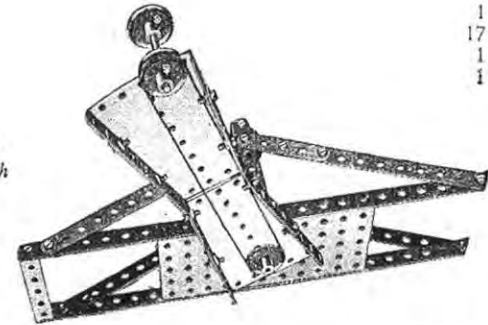
Model No. 204—Turntable Gangway



Parts required :

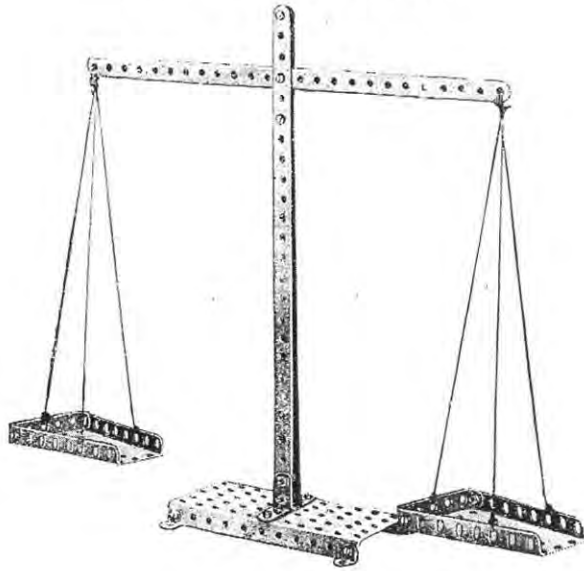
2 of No. 1	4 of No. 22
6 " " 2	1 " " 24
2 " " 3	34 " " 37
4 " " 5	1 " " 52
1 " " 15A	2 " " 54
1 " " 17	3 " " 60

FIG. 204A  
(underneath view)



The side frames of the gangway are made of  $12\frac{1}{2}$ " strips bolted by means of  $2\frac{1}{2}$ " bent strips to parallel strips below. The side frames are connected by a perforated flanged plate to the underside of which is bolted a bush wheel fitted with a rod on which is mounted a 1" pulley (See Fig. 204A.) The rod passes through one of the end holes of the sector plate which is connected by diagonal strips to another sector plate. Through the end hole of the latter a rod is threaded carrying two 1" pulleys from one of which an operating cord passes through the pulley mounted on the under side of the flange plate. In this way the Gangway may be rotated by an operating spindle.

## Model No. 205—Scales

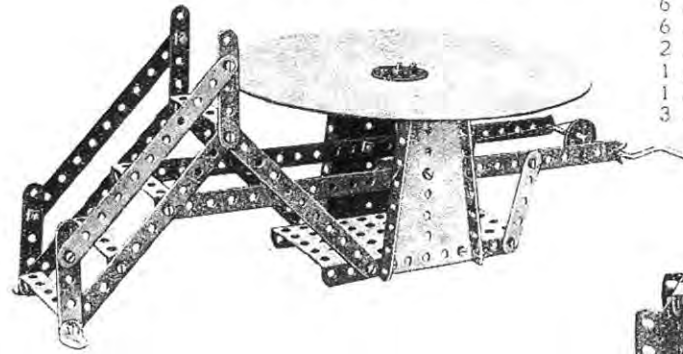


Parts required :

3 of No. 1	4 of No. 38
4 " " 12	1 " " 52
2 " " 12A	2 " " 54
19 " " 37	2 " " 60

The slot is formed by inserting 2 washers in the bolts above and below the beam. These washers hold the strips composing the standard at the required distance apart to give the beam free play.

## Model No. 206—Joy Wheel



The driving mechanism and construction of the framework of this model are clearly brought out in Fig. 206A. Cut out a circular piece of cardboard, 8" in diameter, and in the centre of the disc fix a bush wheel by nuts and bolts. The eye of the bush wheel is then threaded over the top of a vertical spindle, and secured by its set-screw.

Parts required :

2 of No. 1	1 of No. 22A
6 " " 2	1 " " 24
6 " " 5	2 " " 35
2 " " 12	23 " " 37
1 " " 15A	1 " " 52
1 " " 19	2 " " 54
3 " " 22	5 " " 60

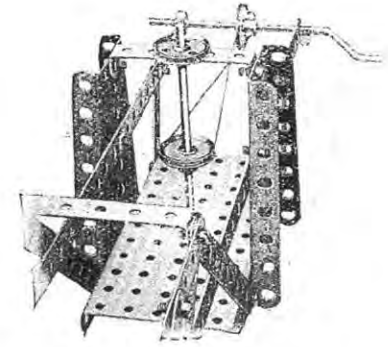
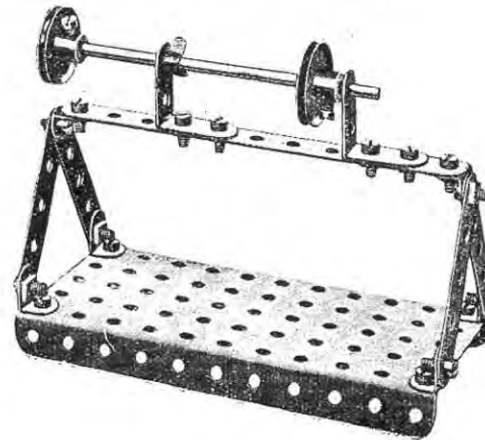


Fig. 206A.

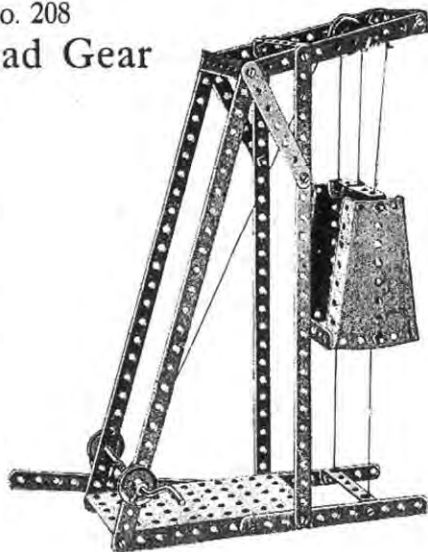
Model No. 207  
Polishing Spindle

Parts required :

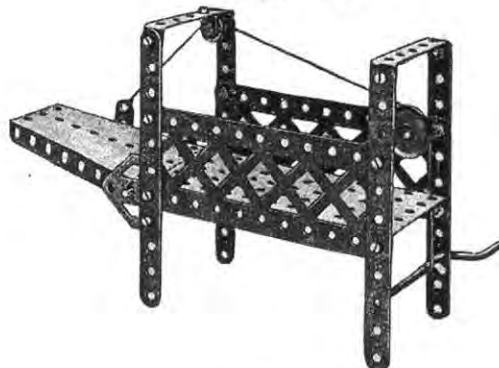
1 of No. 2	1 of No. 15A
4 " " 5	2 " " 22
6 " " 12	1 " " 35
2 " " 12A	16 " " 37
	1 " " 52

### Model No. 208 Pit Head Gear

- Parts  
required :
- |    |        |    |
|----|--------|----|
| 4  | of No. | 1  |
| 5  | " "    | 2  |
| 2  | " "    | 3  |
| 2  | " "    | 5  |
| 2  | " "    | 12 |
| 1  | " "    | 16 |
| 1  | " "    | 19 |
| 3  | " "    | 22 |
| 2  | " "    | 35 |
| 25 | " "    | 37 |
| 1  | " "    | 52 |
| 2  | " "    | 54 |
| 5  | " "    | 60 |

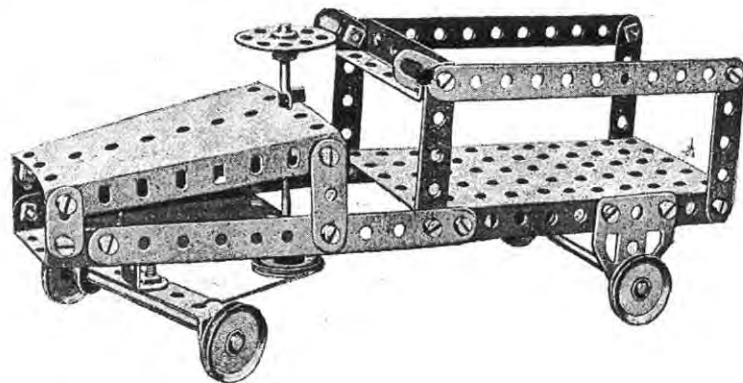


### Model No. 209 Gangway



- Parts required :
- |   |        |    |    |        |    |   |        |      |
|---|--------|----|----|--------|----|---|--------|------|
| 4 | of No. | 2  | 1  | of No. | 22 | 1 | of No. | 54   |
| 1 | " "    | 10 | 1  | " "    | 23 | 2 | " "    | 60   |
| 1 | " "    | 12 | 4  | " "    | 35 | 2 | " "    | 100  |
| 1 | " "    | 16 | 17 | " "    | 37 | 2 | " "    | 126A |
| 1 | " "    | 19 | 1  | " "    | 52 |   |        |      |

### Model No. 211—Motor Cart



- Parts  
required :
- |    |        |      |
|----|--------|------|
| 4  | of No. | 2    |
| 4  | " "    | 5    |
| 2  | " "    | 6A   |
| 4  | " "    | 10   |
| 1  | " "    | 11   |
| 3  | " "    | 16   |
| 3  | " "    | 22   |
| 2  | " "    | 22A  |
| 1  | " "    | 24   |
| 3  | " "    | 35   |
| 26 | " "    | 37   |
| 1  | " "    | 52   |
| 2  | " "    | 54   |
| 3  | " "    | 60   |
| 2  | " "    | 126A |

### Model No. 210 Ladder on Wheels

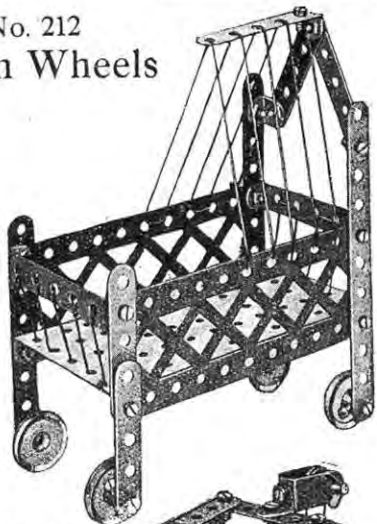


- Parts required :
- |   |        |    |    |        |    |
|---|--------|----|----|--------|----|
| 6 | of No. | 1  | 24 | of No. | 37 |
| 4 | " "    | 5  | 1  | " "    | 52 |
| 2 | " "    | 16 | 6  | " "    | 60 |
| 4 | " "    | 20 |    |        |    |

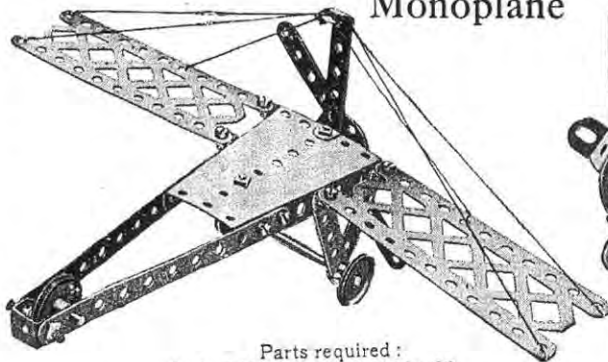
Model No. 212  
Cot on Wheels

Parts required:

2	of No.	2
7	" "	5
3	" "	12
4	" "	22
18	" "	37
2	" "	60
2	" "	100



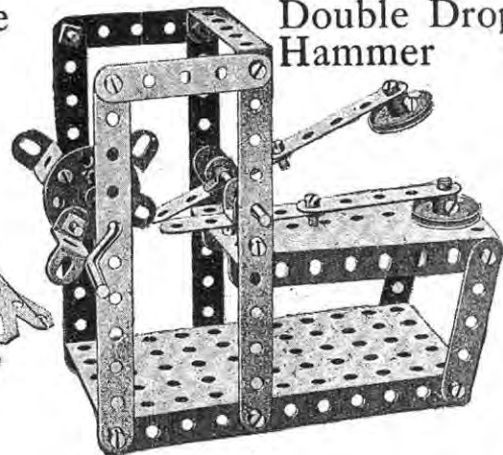
Model No 213  
Monoplane



Parts required:

6	of No.	12	1	of No.	35
2	" "	16	18	" "	37
2	of No.	2	1	" "	54
6	" "	5	3	" "	60
1	" "	11	1	" "	100

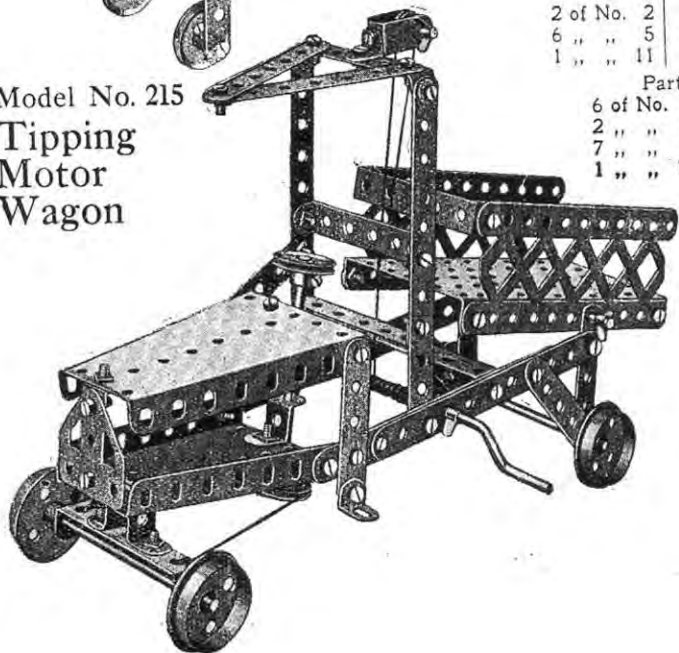
Model No. 214  
Double Drop Hammer



Parts required:

1	of No.	16	25	of No.	37
1	" "	19	1	" "	52
4	of No.	2	2	" "	54
8	" "	5	1	" "	60
2	" "	11	6	" "	125

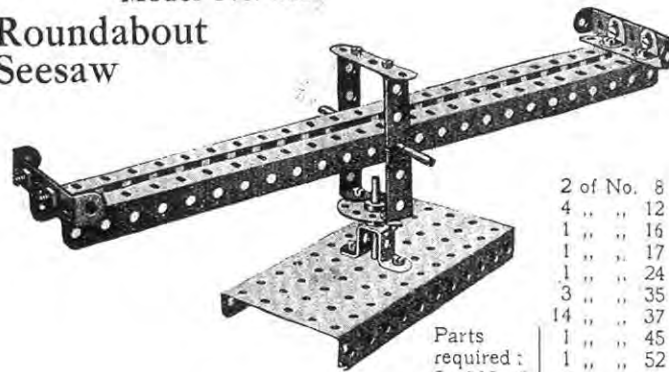
Model No. 215  
Tipping Motor Wagon



Parts required:

6	of No.	2	4	of No.	12
2	" "	3	4	" "	16
7	" "	5	1	" "	18A
1	" "	10	1	" "	19
			4	" "	20
			2	" "	22
			1	" "	23
			7	" "	35
			43	" "	37
			2	" "	38
			1	" "	44
			1	" "	45
			1	" "	52
			2	" "	54
			6	" "	60
			2	" "	100
			2	" "	125
			1	" "	126A

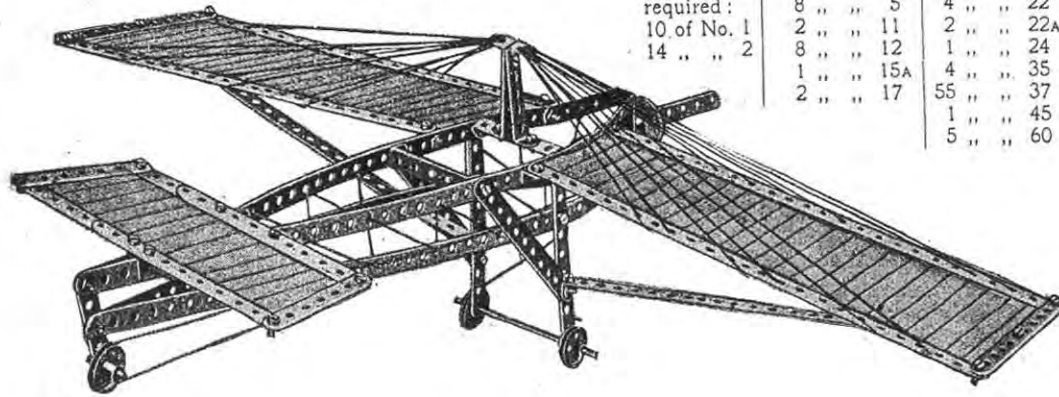
Model No. 216  
Roundabout Seesaw



Parts required:

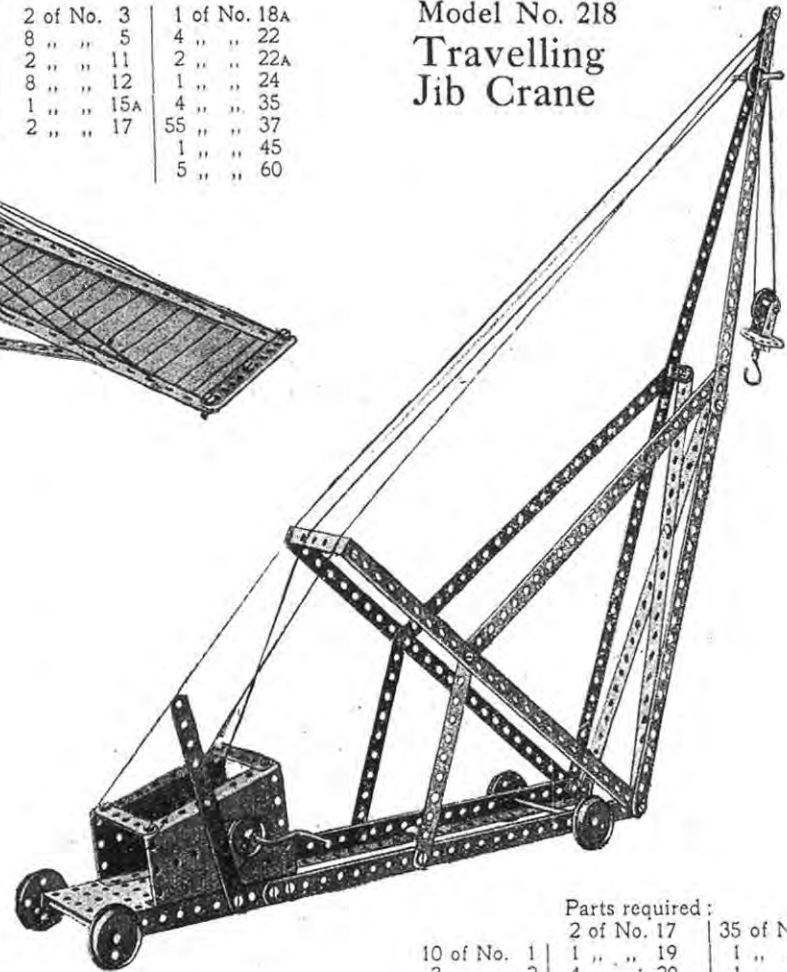
2	of No.	8
4	" "	12
1	" "	16
1	" "	17
1	" "	24
3	" "	35
14	" "	37
1	" "	45
1	" "	52
3	of No	5
4	" "	60

### Model No. 217—Monoplane



Parts required:	2 of No. 3	1 of No. 18A
10 of No. 1	8 " " 5	4 " " 22
14 " " 2	2 " " 11	2 " " 22A
	8 " " 12	1 " " 24
	1 " " 15A	4 " " 35
	2 " " 17	55 " " 37
		1 " " 45
		5 " " 60

### Model No. 218 Travelling Jib Crane



	Parts required:	
	2 of No. 17	35 of No. 37
10 of No. 1	1 " " 19	1 " " 44
3 " " 2	4 " " 20	1 " " 52
3 " " 5	2 " " 22	2 " " 54
2 " " 8	1 " " 22A	1 " " 57
4 " " 12	1 " " 24	1 " " 60
2 " " 16	5 " " 35	

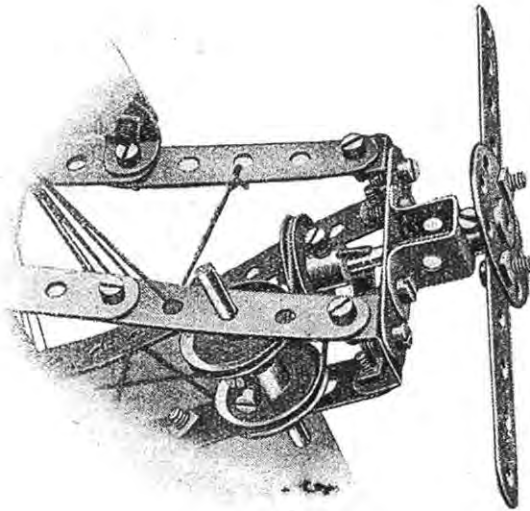
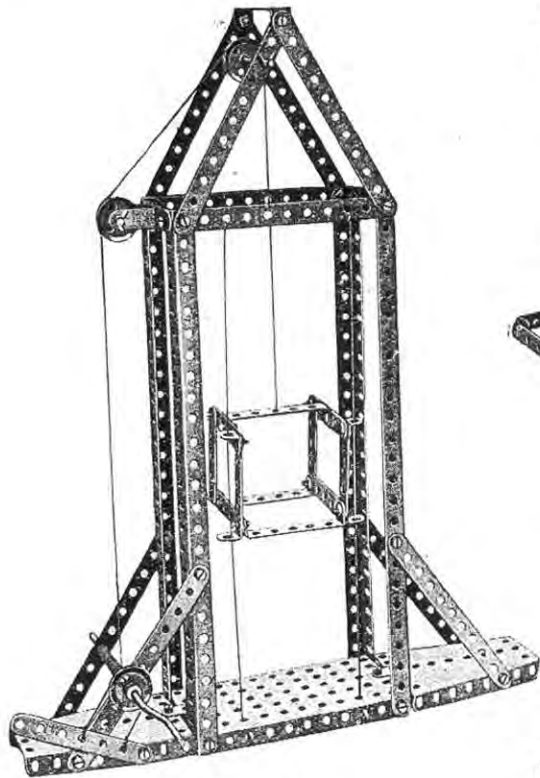


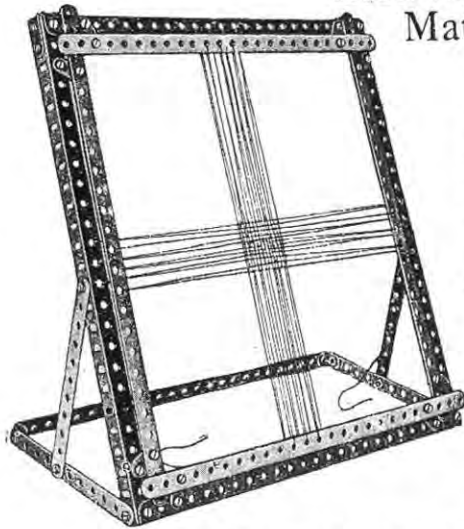
FIG. 217A

Model No. 219  
Elevator



Parts required :		
10 of No. 2	1 of No. 16	38 of No. 37
1 " " 3	1 " " 18A	1 " " 44
10 " " 5	1 " " 19	1 " " 52
4 " " 8	1 " " 22	2 " " 54
2 " " 10	2 " " 22A	4 " " 60
4 " " 12	5 " " 35	

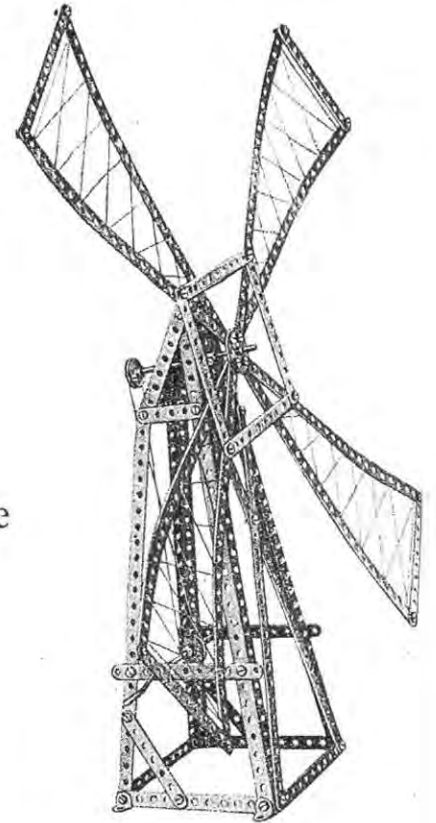
Model No. 220  
Mat Frame



Parts required :

5 of No. 1	
4 " " 2	
4 " " 8	
8 " " 10	
2 " " 12	
2 " " 12A	
36 " " 37	

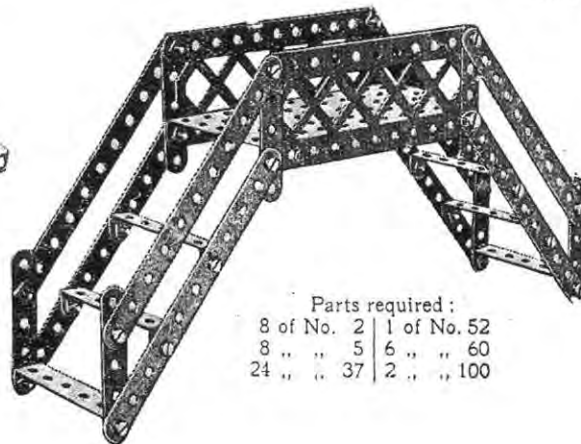
Model No. 221  
Windmill



Parts required :

10 of No. 1	4 of No. 8	1 of No. 24
14 " " 2	4 " " 12	4 " " 35
2 " " 3	1 " " 15	45 " " 37
2 " " 5	1 " " 19	2 " " 54
	2 " " 22	

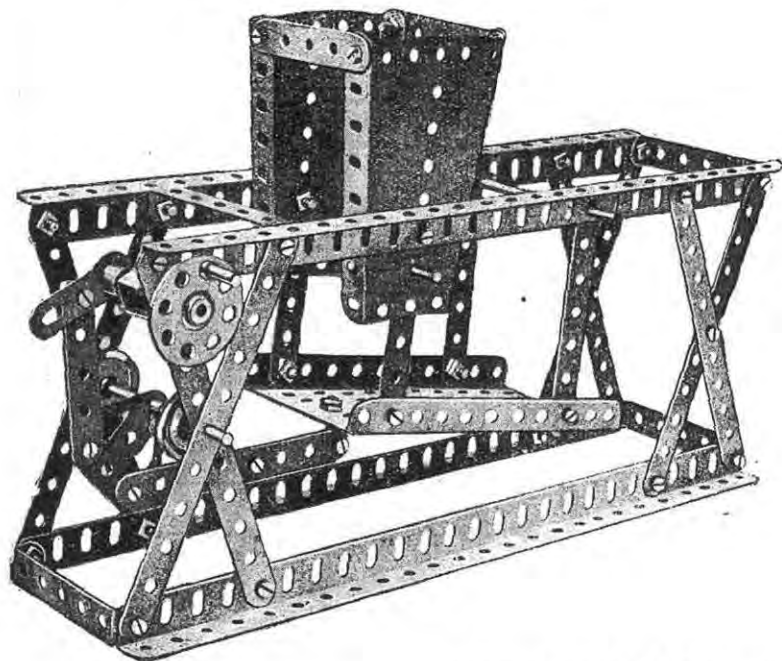
Model No. 222—High-level  
Bridge



Parts required :

8 of No. 2	1 of No. 52
8 " " 5	6 " " 60
24 " " 37	2 " " 100

### Model No. 223--Coal Sifter



Parts  
required :

8 of No.	2
2 " "	3
7 " "	5
4 " "	8
1 " "	12
3 " "	16
1 " "	17
2 " "	22
1 " "	24
6 " "	35
38 " "	37
1 " "	45
1 " "	52
2 " "	54
4 " "	60
1 " "	62
1 " "	115
1 " "	126A

### Model No. 224 Try-your-strength Machine



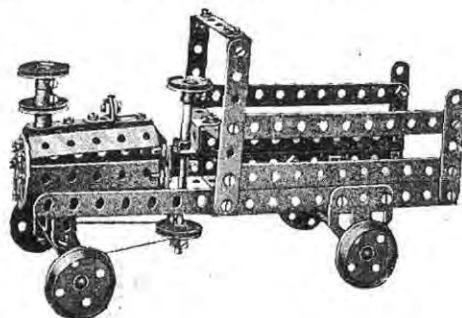
Parts required :

2 of No.	1	1 of No.	17	12 of No.	38
5 " "	2	1 " "	18A	1 " "	45
2 " "	3	4 " "	22	1 " "	52
2 " "	8	1 " "	24	1 " "	54
1 " "	11	4 " "	35	4 " "	60
2 " "	16	30 " "	37	1 " "	126A

### Model No. 225--Locomotive

Parts required :

4 of No.	2	1 of No.	24
2 " "	3	2 " "	35
6 " "	5	47 " "	37
3 " "	10	1 " "	45
7 " "	12	1 " "	52
3 " "	16	1 " "	54
1 " "	17	6 " "	60
4 " "	20	1 " "	62
4 " "	22	2 " "	125
1 " "	23	2 " "	126A



### Model No. 226 Candy Puller



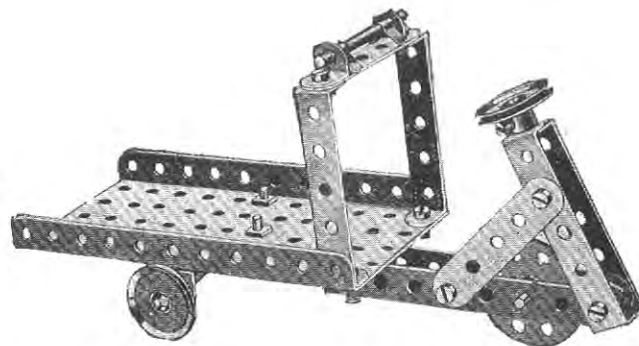
Parts required :

3 of No. 2	
2 " " 8	
2 " " 12	
2 " " 12A	
2 " " 17	
1 " " 19	
4 " " 22	
2 " " 35	
26 " " 37	
10 " " 38	
1 " " 52	
4 " " 60	
2 " " 62	
4 " " 125	
2 " " 126	

### Model No. 227—Carrier Tricycle

Parts required :

2 of No. 2	
3 " " 5	
1 " " 11	
2 " " 12	
1 " " 16	
1 " " 17	
1 " " 18A	
3 " " 22	
1 " " 24	
2 " " 35	
15 " " 37	
1 " " 52	
5 " " 60	



### Model No. 229 Baby Chair

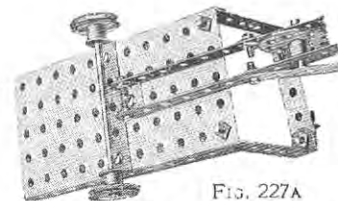
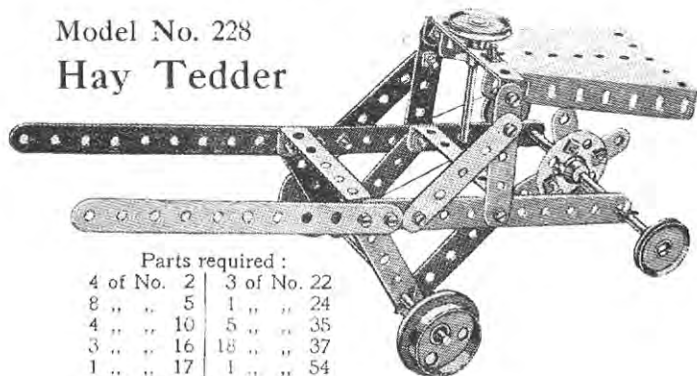


FIG. 227A  
Underneath view

### Model No. 228 Hay Tedder



Parts required :

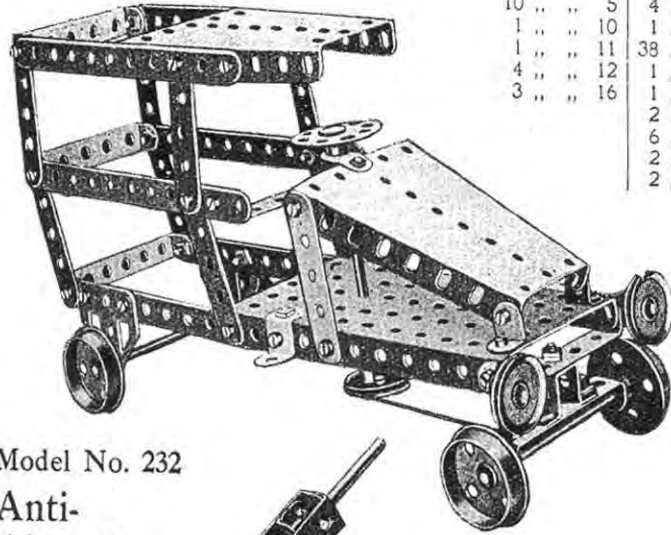
4 of No. 2	3 of No. 22
8 " " 5	1 " " 24
4 " " 10	5 " " 35
3 " " 16	18 " " 37
1 " " 17	1 " " 54
2 " " 20	3 " " 60

Parts required :

8 of No. 2	
2 " " 3	
12 " " 5	
6 " " 12	
2 " " 17	
4 " " 22	
31 " " 37	
6 " " 60	



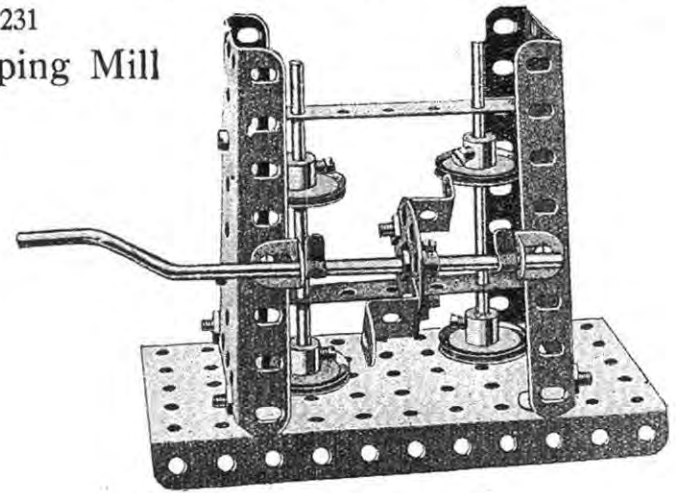
Model No. 230—Motor Van



Parts required:

6 of No. 2	4 of No. 20
10 " " 5	4 " " 22
1 " " 10	1 " " 24
1 " " 11	38 " " 37
4 " " 12	1 " " 44
3 " " 16	1 " " 52
	2 " " 54
	6 " " 60
	2 " " 125
	2 " " 126A

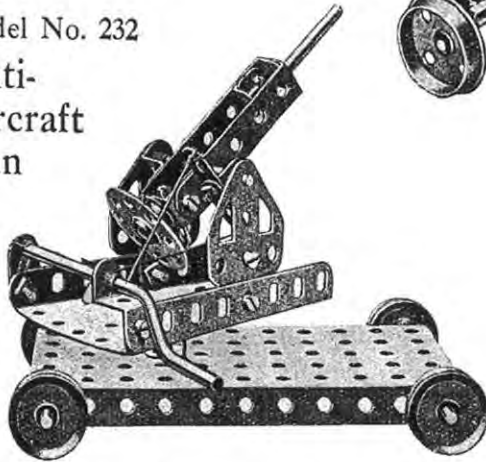
Model 231  
Stamping Mill



Parts required:

2 of No. 3	4 of No. 22	1 of No. 52
10 " " 12	1 " " 24	2 " " 54
2 " " 16	2 " " 35	2 " " 125
1 " " 19	16 " " 37	

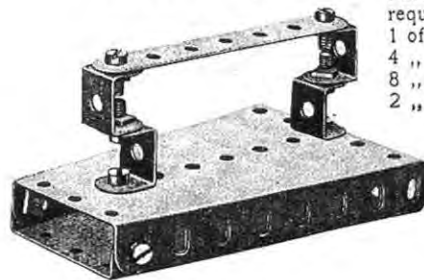
Model No. 232  
Anti-Aircraft  
Gun



Parts required:

5 of No. 10	4 of No. 22	1 of No. 54
2 " " 11	1 " " 24	2 " " 60
2 " " 16	4 " " 35	4 " " 125
2 " " 17	12 " " 37	2 " " 126A
1 " " 19	1 " " 52	

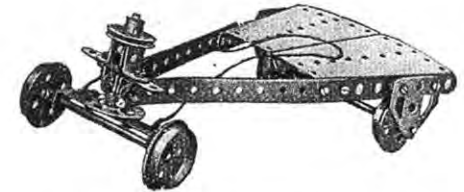
Model No. 233  
Smoothing Iron



Parts required:

1 of No. 3
4 " " 11
8 " " 37
2 " " 54

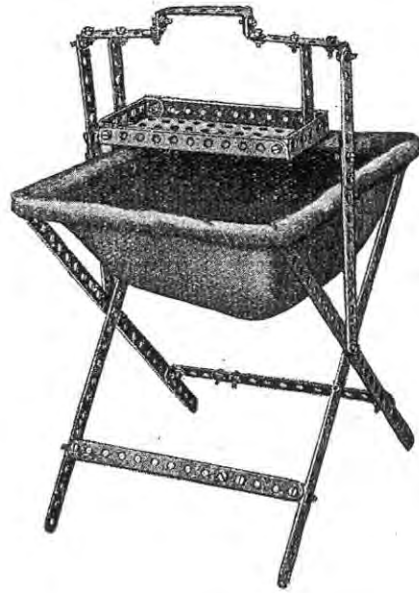
Model No. 234  
Coaster



Parts required:

2 of No. 2	1 of No. 17	6 of No. 38
1 " " 5	4 " " 20	1 " " 45
2 " " 12	1 " " 22	2 " " 54
1 " " 15	1 " " 24	1 " " 60
1 " " 16	16 " " 37	2 " " 126A

These Models can be made with MECCANO Outfit No. 2, or No. 1 and No. 1A

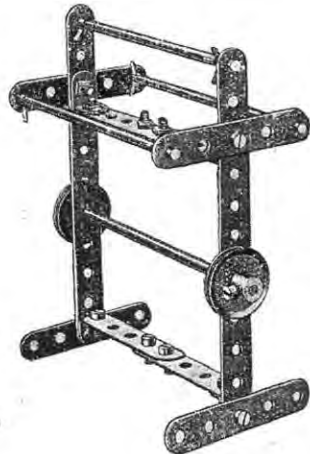


Model No. 235

Needlework  
Basket

Parts required :

- 6 of No. 1
- 6 " " 2
- 2 " " 3
- 6 " " 5
- 12 " " 12
- 46 " " 37
- 1 " " 52
- 3 " " 60



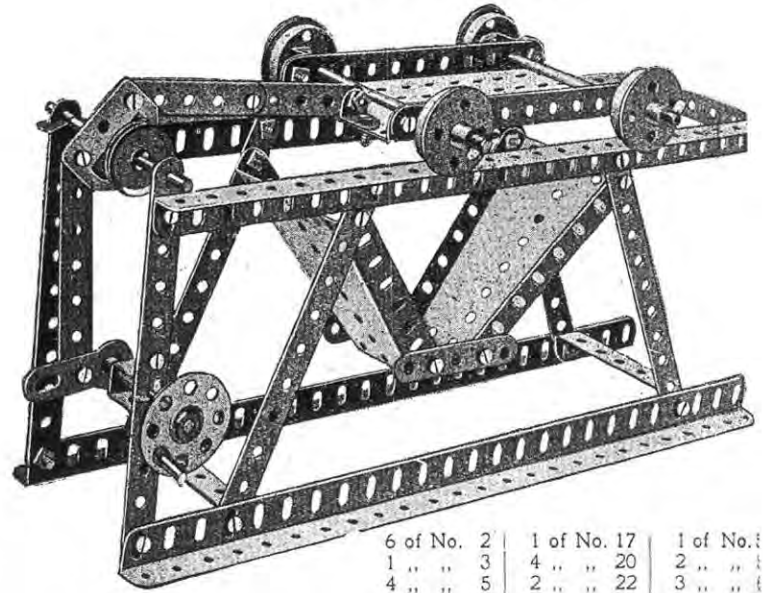
Model No. 237

Towel Rail

Parts required :

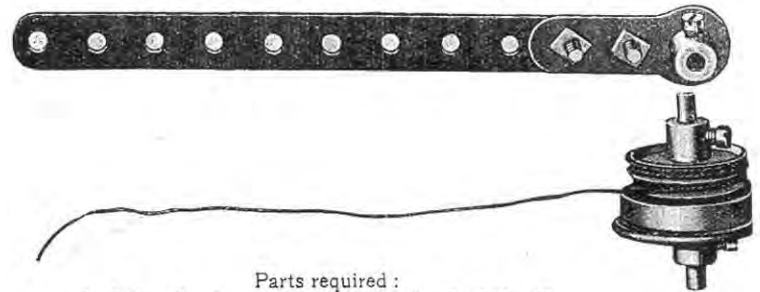
- 2 of No. 2
- 8 " " 5
- 4 " " 12
- 1 " " 15
- 4 " " 16
- 2 " " 22
- 6 " " 35
- 12 " " 37

Model No. 236—Sifter



- Parts required :
- |            |             |            |
|------------|-------------|------------|
| 6 of No. 2 | 1 of No. 17 | 1 of No. 1 |
| 1 " " 3    | 4 " " 20    | 2 " " 1    |
| 4 " " 5    | 2 " " 22    | 3 " " 1    |
| 4 " " 8    | 1 " " 24    | 1 " " 1    |
| 1 " " 12   | 7 " " 35    | 1 " " 11   |
| 2 " " 15   | 34 " " 37   | 4 " " 11   |
| 1 " " 16   | 1 " " 45    | 1 " " 12   |

Model No. 238—Spinning Top



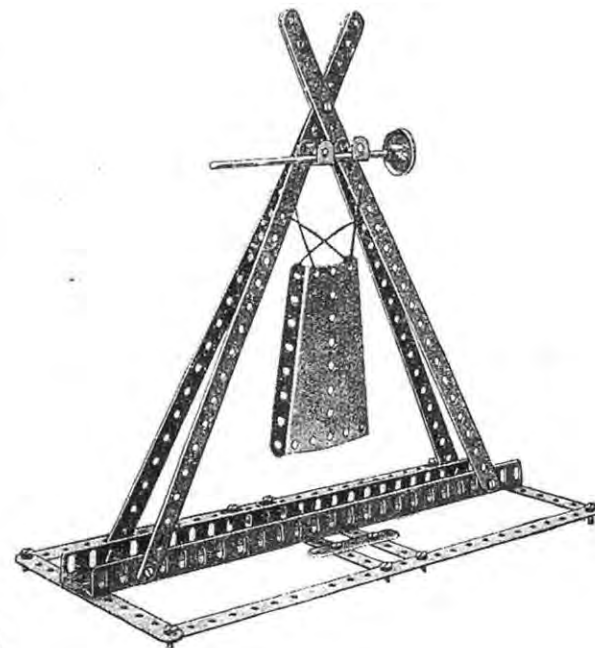
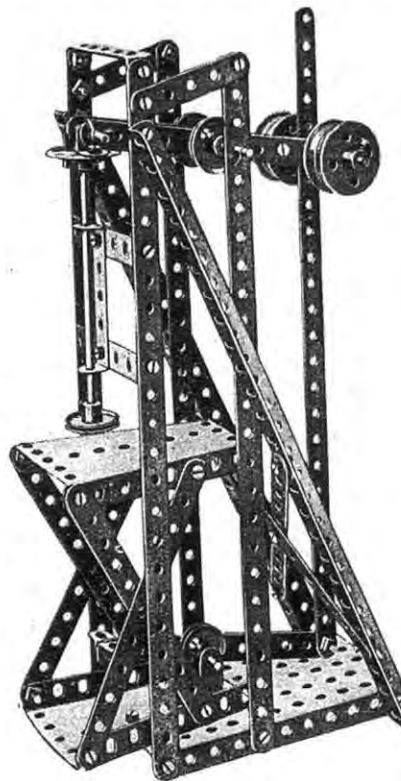
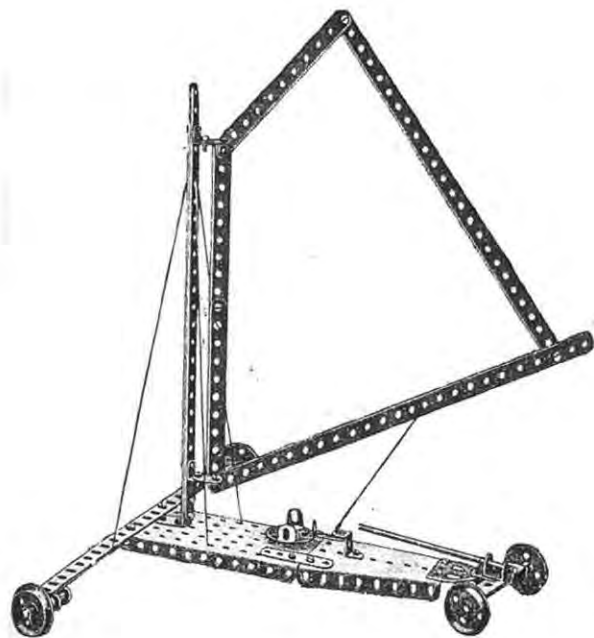
- Parts required :
- |            |             |             |
|------------|-------------|-------------|
| 1 of No. 2 | 1 of No. 20 | 2 of No. 37 |
| 1 " " 17   | 2 " " 22    | 1 " " 62    |

Model No. 239—Seashore Aeroplane

Model No. 240—

Model No. 241—Dinner Gong

Embossing Machine



Parts required :

4 of No. 1	1 of No. 12A	33 of No. 37
3 " " 2	1 " " 15	1 " " 38
2 " " 5	1 " " 16	1 " " 52
1 " " 8	2 " " 17	1 " " 54
3 " " 10	4 " " 20	1 " " 60
3 " " 11	1 " " 24	1 " " 125
7 " " 12	6 " " 35	1 " " 126A

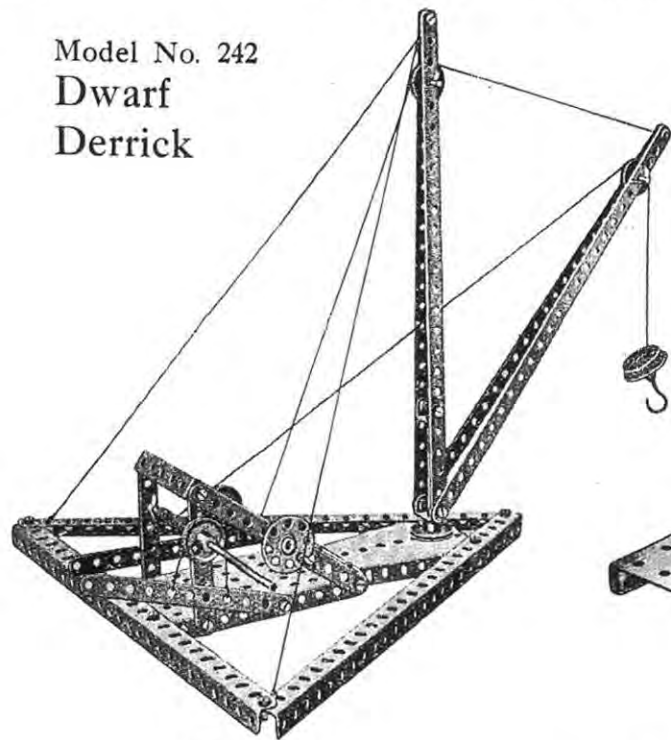
Parts required :

5 of No. 1	2 of No. 16	44 of No. 37
9 " " 2	1 " " 17	1 " " 44
2 " " 5	1 " " 18A	1 " " 52
2 " " 8	4 " " 20	2 " " 54
2 " " 11	4 " " 22	4 " " 60
4 " " 12	1 " " 24	
1 " " 15	4 " " 35	

Parts required :

6 of No. 1	1 of No. 15
4 " " 2	1 " " 22
2 " " 5	27 " " 37
2 " " 8	1 " " 54
2 " " 11	

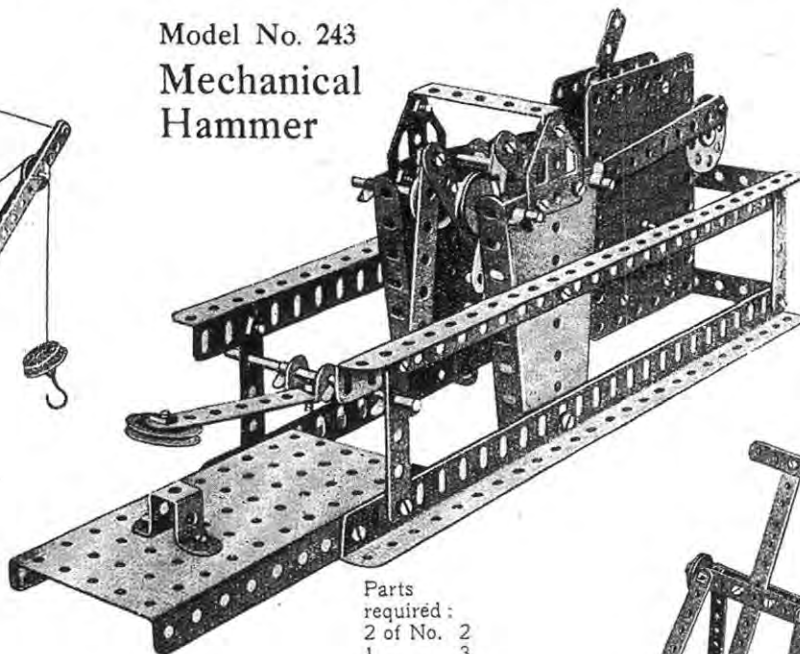
Model No. 242  
Dwarf  
Derrick



Parts required :

4 of No. 1	2 of No. 22A
4 " " 2	1 " " 24
2 " " 3	6 " " 35
3 " " 8	23 " " 37
2 " " 11	4 " " 38
2 " " 16	1 " " 52
2 " " 18A	1 " " 54
1 " " 19	1 " " 57
1 " " 20	1 " " 60
4 " " 22	1 " " 115

Model No. 243  
Mechanical  
Hammer



Parts required :

2 of No. 2	
1 " " 3	
6 " " 5	
4 " " 8	
1 " " 11	
1 " " 12	
3 " " 16	
4 " " 22	
1 " " 22A	
1 " " 24	
8 " " 35	
32 " " 37	
1 " " 45	
1 " " 52	
2 " " 54	
3 " " 60	
2 " " 126A	

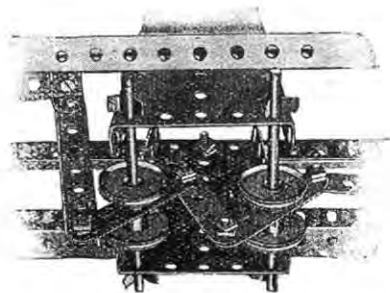
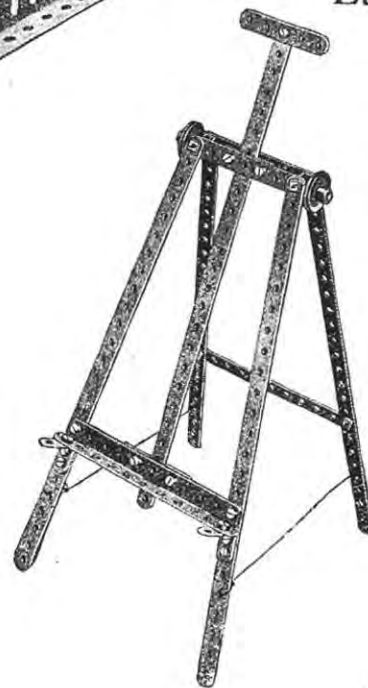


FIG. 243A.

Clockwork Motor.

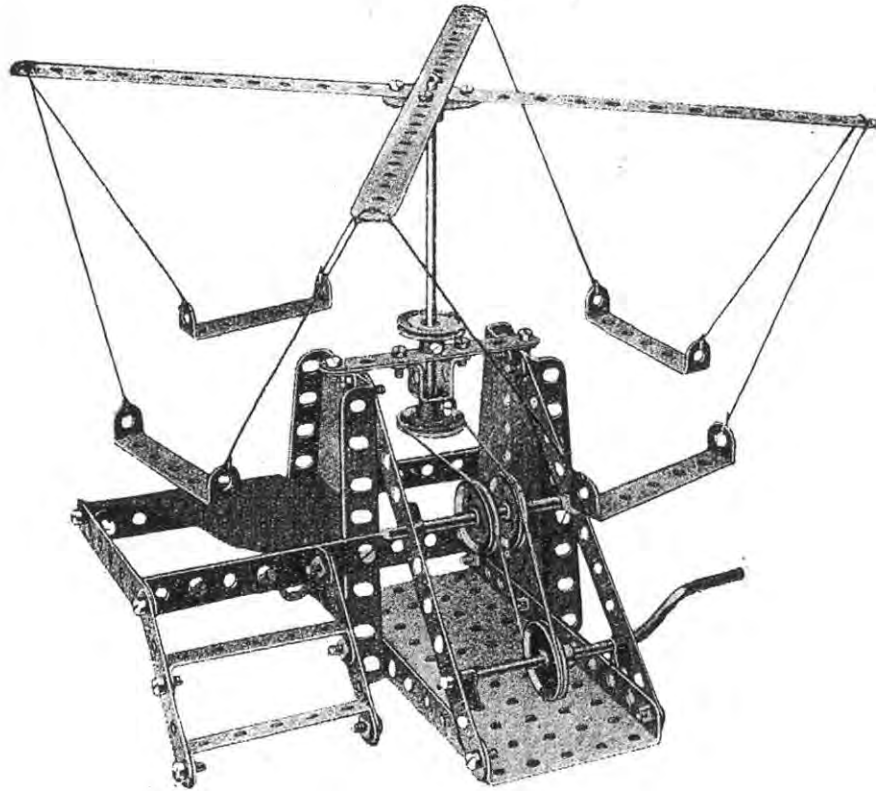
Model No.  
Easel



Parts required :

5 of No. 1	
3 " " 2	
2 " " 3	
3 " " 5	
4 " " 12	
2 " " 12	
1 " " 15	
2 " " 22	
19 " " 37	
4 " " 38	

### Model No. 245—Roundabout



Parts required :		
2 of No. 1	1 of No. 16	35 of No. 37
4 " " 2	1 " " 19	1 " " 45
2 " " 3	3 " " 22	1 " " 52
4 " " 5	2 " " 22A	2 " " 54
3 " " 12	1 " " 24	7 " " 60
1 " " 15	4 " " 35	

### Model No. 246—Beam Scales

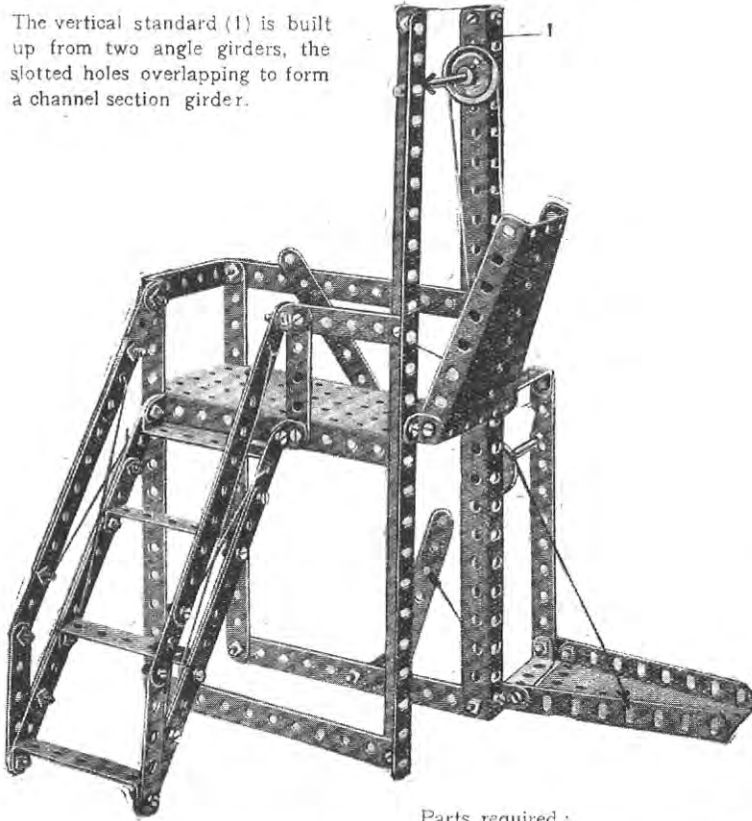


Parts required :

5 of No. 1	6 of No. 12	1 of No. 52
6 " " 2	2 " " 17	2 " " 54
7 " " 5	2 " " 22A	5 " " 60
4 " " 8	6 " " 35	2 " " 126A
	48 " " 37	

### Model No. 247 Ferry Gangway

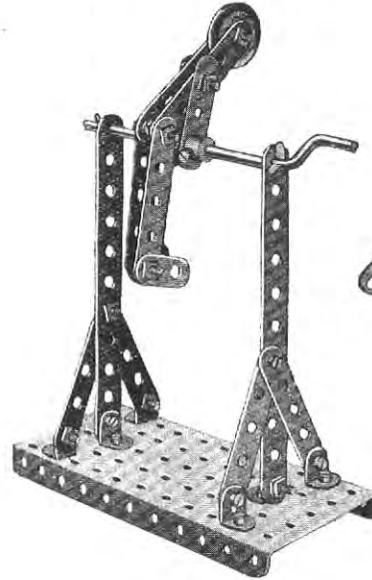
The vertical standard (1) is built up from two angle girders, the slotted holes overlapping to form a channel section girder.



Parts required :

14 of No. 2	6 of No. 12	1 of No. 45
2 " " 3	2 " " 16	1 " " 52
6 " " 5	2 " " 22	2 " " 54
3 " " 8	2 " " 35	8 " " 60
2 " " 10	54 " " 37	

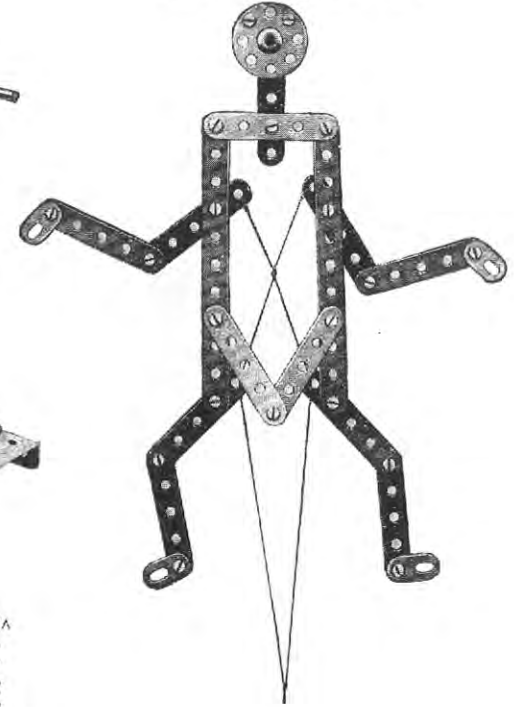
### Model No. 248 The Acrobat



Parts required

2 of No. 2	1 of No. 22A
8 " " 5	2 " " 35
2 " " 10	21 " " 37
6 " " 12	1 " " 52
1 " " 19	2 " " 62

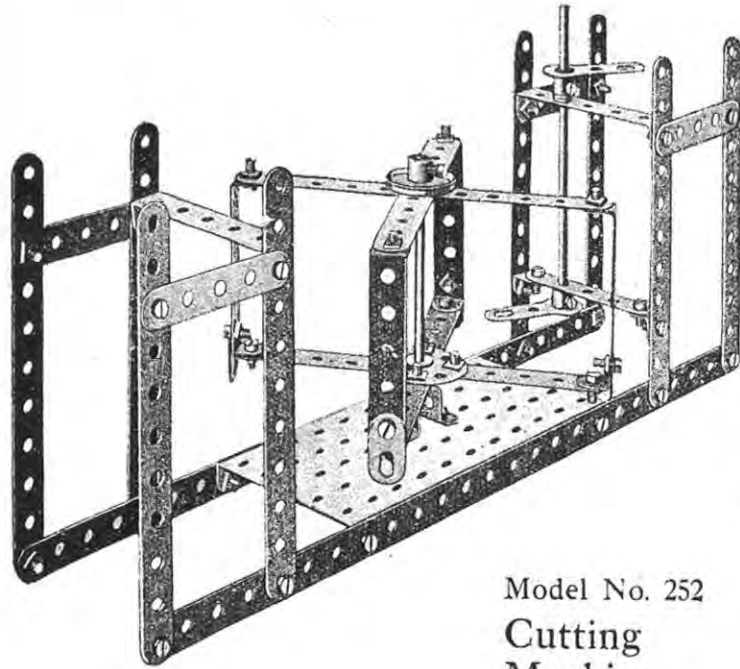
### Model No. 249 Jumping Jack



Parts  
required :

2 of No. 2
12 " " 5
4 " " 10
1 " " 24
18 " " 37

Model No. 250—Turnstile



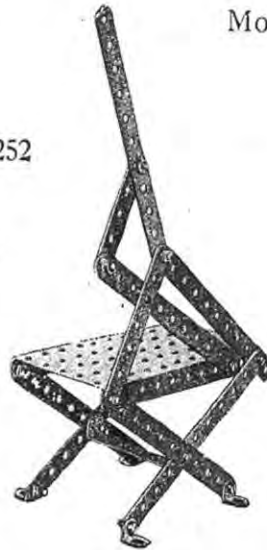
Parts required :

2 of No. 1	1 of No. 24
10 " " 2	42 " " 37
9 " " 5	2 " " 33
4 " " 10	1 " " 45
2 " " 12	1 " " 52
1 " " 15	6 " " 60
1 " " 15A	2 " " 62
2 " " 22	

Model No. 252  
Cutting  
Machine

Parts  
required :

7 of No. 2
1 " " 3
1 " " 5
4 " " 12
14 " " 37
1 " " 52
1 " " 60



Model No. 251  
Chair for  
Wounded

Parts  
required :

6 of No. 2
2 " " 3
10 " " 5
2 " " 11
2 " " 16
4 " " 22
21 " " 37
1 " " 52
2 " " 60



Model No. 253—

Magic Sector  
Plates

Parts  
required :

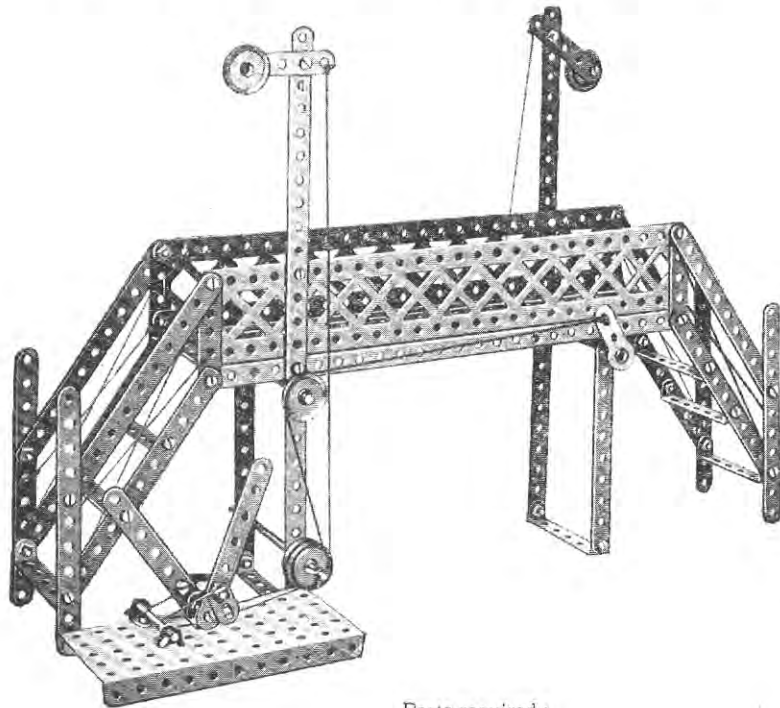
2 of No. 11
1 " " 17
2 " " 35
6 " " 37
2 " " 54



When the cord is held vertically the magic sector plates will fall or stop at the bidding of the owner. If the cord is held without tension the plates will fall, but the instant the cord is tightened they will stop dead. The cord is wrapped once around the rod which passes through the centre holes of the sector plates.

Model No. 254

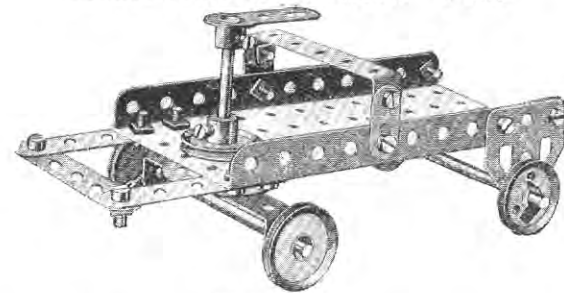
### Railway Foot Bridge and Signals



Parts required :

4 of No. 1	1 of No. 11	2 of No. 22A
14 " " 2	2 " " 12	6 " " 35
2 " " 3	1 " " 15A	50 " " 37
8 " " 5	2 " " 16	1 " " 52
2 " " 8	1 " " 17	8 " " 60
2 " " 10	3 " " 22	

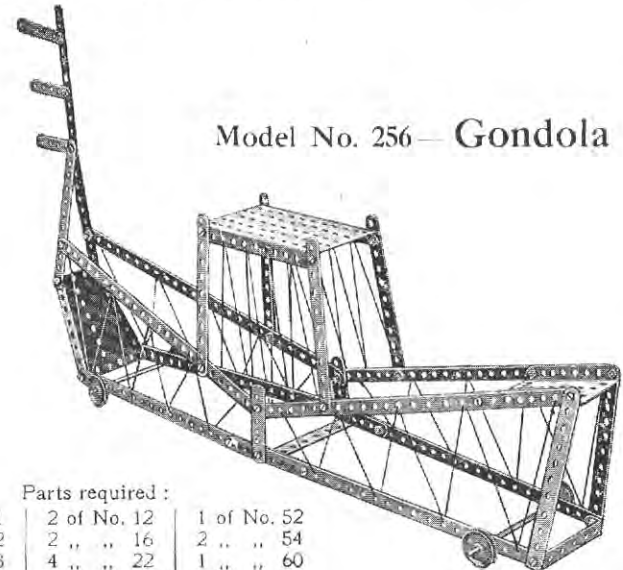
Model No. 255—Motor Van



Parts required :

3 of No. 5	2 of No. 22A	1 of No. 52
2 " " 10	1 " " 24	2 " " 60
2 " " 16	2 " " 35	1 " " 62
1 " " 17	16 " " 37	2 " " 126A
3 " " 22	2 " " 38	

Model No. 256—Gondola



Parts required :

8 of No. 1	2 of No. 12	1 of No. 52
9 " " 2	2 " " 16	2 " " 54
1 " " 3	4 " " 22	1 " " 60
5 " " 5	29 " " 37	



### Model No. 257—Extending Ladder on Running Carriage

Parts  
required :

2	of No.	1
8	" "	2
1	" "	3
7	" "	5
4	" "	8
5	" "	12
4	" "	16
1	" "	18A
1	" "	19
4	" "	20
4	" "	22
1	" "	22A
1	" "	24
6	" "	35
47	" "	37
2	" "	38
1	" "	44
1	" "	45
1	" "	52
2	" "	54
7	" "	60
1	" "	115
2	" "	125
2	" "	126A

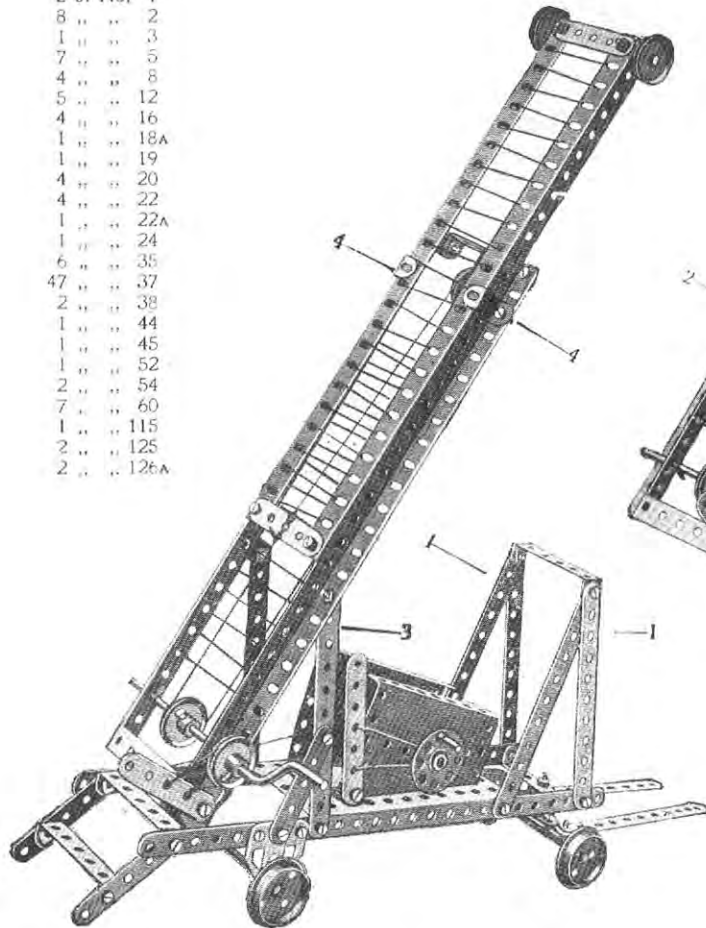


FIG. 257A

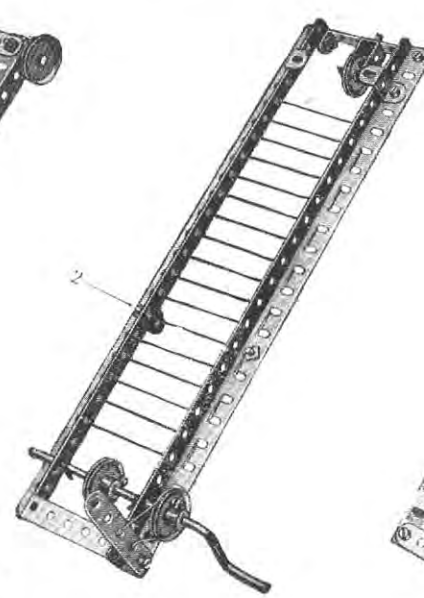


FIG. 257B

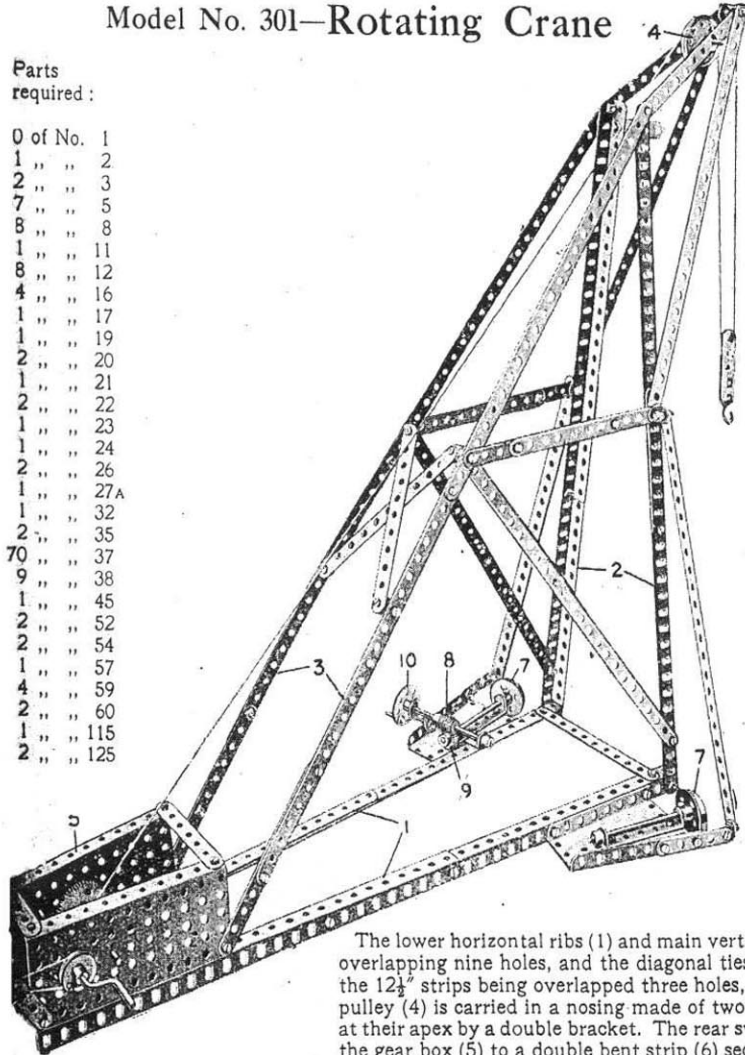
The bed of the lower carriage framework is formed by bolting two  $1\frac{1}{2}$ " strips to the sides of a large flanged plate, and two sector plates bolted to the flanged plate by their flanges to form the sides, and a bearing for the spindle carrying the operating cord attached to the bottom of the ladder to raise it from a horizontal position, and the strips (1) form a support for the ladder when in this horizontal position. Angle brackets (2), Fig. 257A, form pivots for the lower part of the ladder, and are carried from the supports (3). The upper part of the ladder, Fig. 257, is slidably guided and retained on the lower ladder by reversed brackets (4). The extension of the ladder is effected by the cranked spindle round a pulley on which (and another pulley at the top of the framework) the cord is passed, the ends being secured to the lower part of the slidable ladder.

### Model No. 301—Rotating Crane

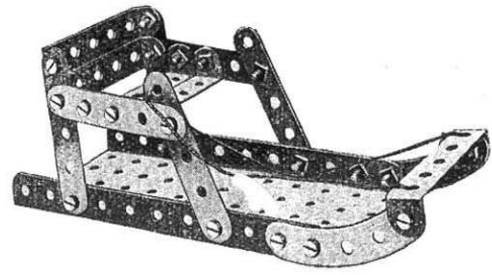
### Model No. 302—Toboggan

Parts required:

0	of No.	1
1	" "	2
2	" "	3
7	" "	5
8	" "	8
1	" "	11
8	" "	12
4	" "	16
1	" "	17
1	" "	19
2	" "	20
1	" "	21
2	" "	22
1	" "	23
1	" "	24
2	" "	26
1	" "	27A
1	" "	32
2	" "	35
70	" "	37
9	" "	38
1	" "	45
2	" "	52
2	" "	54
1	" "	57
4	" "	59
2	" "	60
1	" "	115
2	" "	125



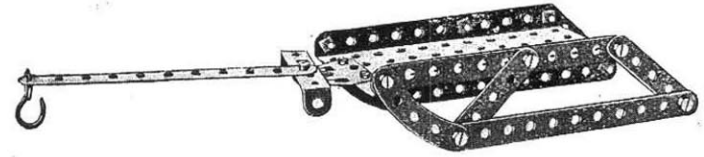
The lower horizontal ribs (1) and main vertical members (2) are made of angle girders overlapping nine holes, and the diagonal ties (3) of two 12½" strips and one 5½" strip, the 12½" strips being overlapped three holes, and the lower 5½" strip seven holes. The pulley (4) is carried in a nosing made of two 5½" strips and two 12½" strips connected at their apex by a double bracket. The rear swivel point of the crane is made by bolting the gear box (5) to a double bent strip (6) secured to the floor. The crane runs on the flanged wheel (7) and is rotated by means of the worm (8) which engages a pinion (9) on the spindle of one of the flanged wheels and is rotated by the hand wheel (10).



Parts required:

6	of No.	5
20	" "	37
1	" "	52
5	" "	60
2	" "	90

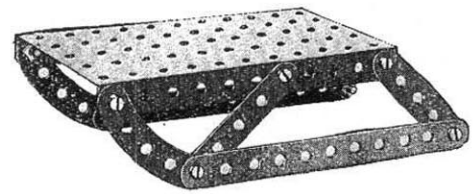
### Model No. 303—Horse Sleigh



Parts required:

3 of No. 2	13 of No. 37	1 of No. 60
4 " " 5	1 " " 52	2 " " 90
1 " " 23	1 " " 57	1 " " 126A

### Model No. 304—Sleigh



Parts required:

2	of No.	2
4	" "	5
10	" "	37
1	" "	52
2	" "	90

## Model No. 305—Tower Wagon

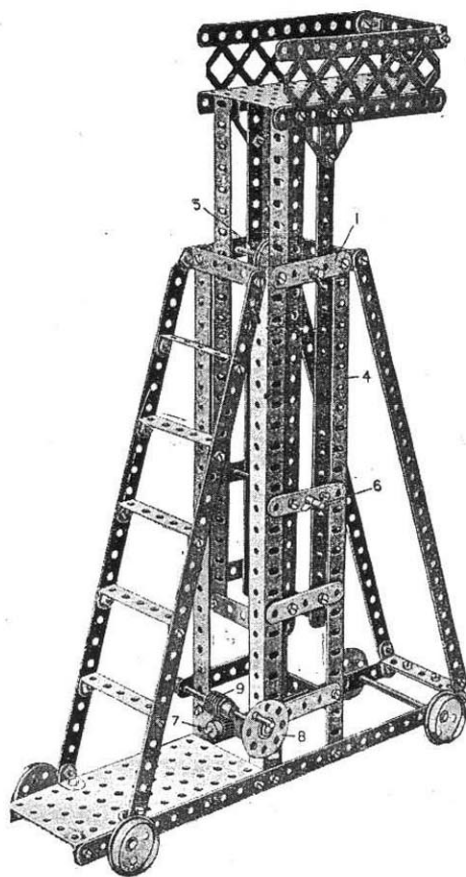


FIG. 305

Parts required:

6 of No.	1
2 "	4
10 "	5
8 "	8
2 "	12
2 "	15a
4 "	16
4 "	20
1 "	22a
1 "	24
1 "	26
1 "	32
4 "	35
72 "	37
8 "	38
2 "	52
3 "	59
10 "	60
1 "	93
2 "	100
1 "	115
2 "	126a

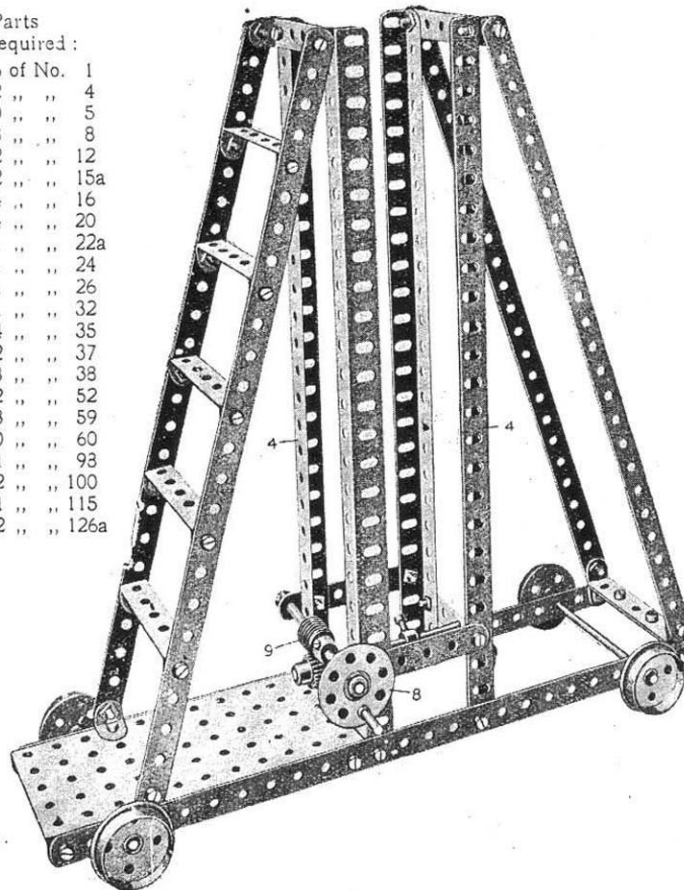


FIG. 305A

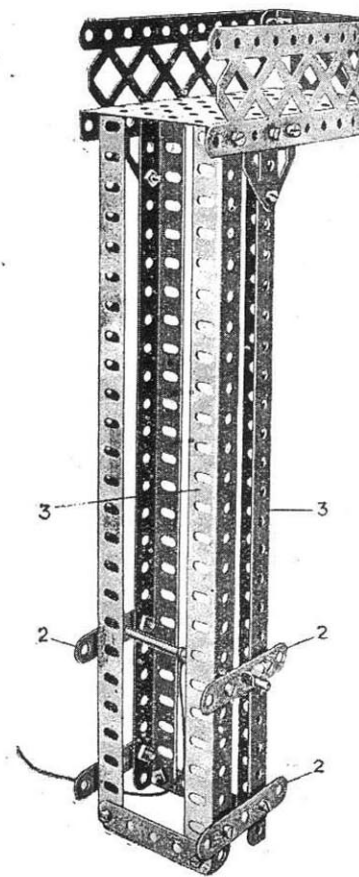
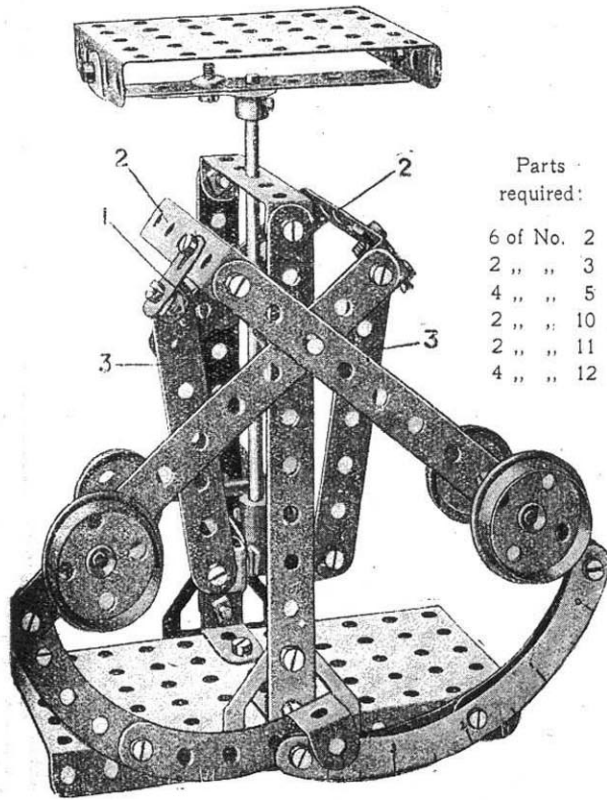


FIG. 305B

Begin the construction of this model by building up the platform, Fig. A, the tie strips (1) being left off as shown in order to be able to insert the rising and falling tower, Fig. B. The strips are then bolted on. The guide strips (2) are bolted to the girder (3) of the tower with washers beneath the strips. This gives the necessary clearance and enables the strips to rise easily up the faces of the girders (4) of the fixed lower part of the tower. The tower is raised by means of a cord which passes over a pulley (5) and is fastened to a rod (6), the other end of the cord winding on a rod (7) rotated by a hand wheel (8) on the spindle of the worm (9).

## Model No. 306 Letter Balance



The connection at (1) of the rocking arms (2) to the thrust strips (3) is locknuttred to give a free pivotal action and similarly the pivotal connections (5) of the strips (3) to the lever strips (4) are locknuttred to give free play.

Parts  
required:

6 of No. 2  
2 " " 3  
4 " " 5  
2 " " 10  
2 " " 11  
4 " " 12

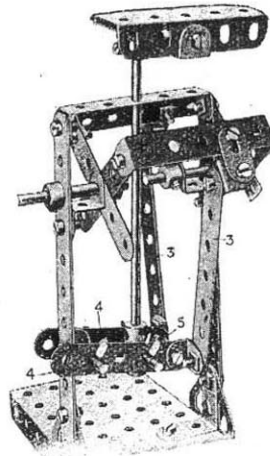
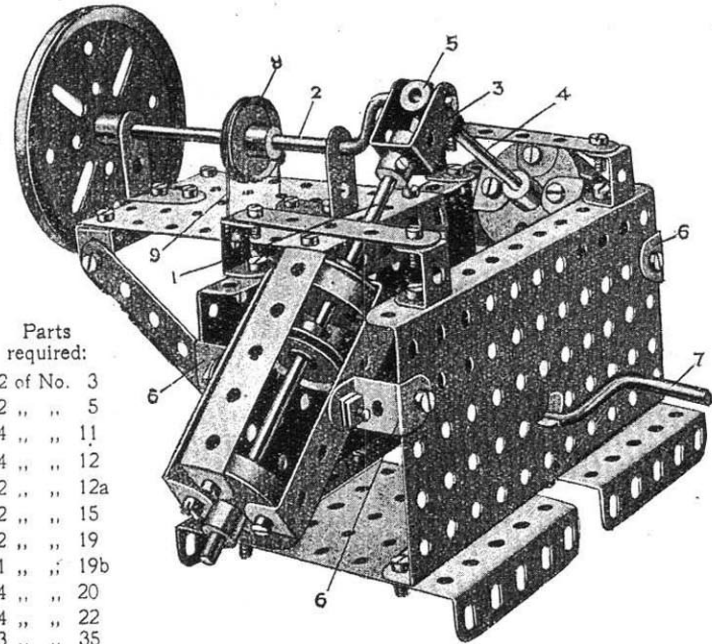


FIG. 306A

2 of No. 12a  
1 " " 15  
2 " " 17  
2 " " 18a  
2 " " 20  
2 " " 22  
4 " " 35  
40 " " 37  
6 " " 38  
1 " " 52  
1 " " 53  
4 " " 59  
3 " " 60  
1 " " 60b  
1 " " 62  
1 " " 63  
4 " " 90  
2 " " 125  
2 " " 126

Model No. 307  
Oscillating Steam Engine

Parts  
required:

2 of No. 3  
2 " " 5  
4 " " 11  
4 " " 12  
2 " " 12a  
2 " " 15  
2 " " 19  
1 " " 19b  
4 " " 20  
4 " " 22  
3 " " 35  
50 " " 37  
2 " " 52  
3 " " 53  
2 " " 59  
6 " " 60  
1 " " 63  
1 " " 102  
4 " " 125

The piston rod (1) of one cylinder is pivotally connected to the crank rod (2) by means of a small double angle strip (3), and the piston rod (4) of the other cylinder is pivoted to the crank rod by a coupling (5). The cylinders consisting of four strips (5) are enclosed by flanged wheels at the ends, and are pivoted on  $\frac{1}{2}$ " reversed brackets (6). The model is operated from the handle rod (7), a pulley on the rear end of which is coupled to the pulley (8) by a cord (9).

## Model No. 308—Railway Wagon Swivel Crane

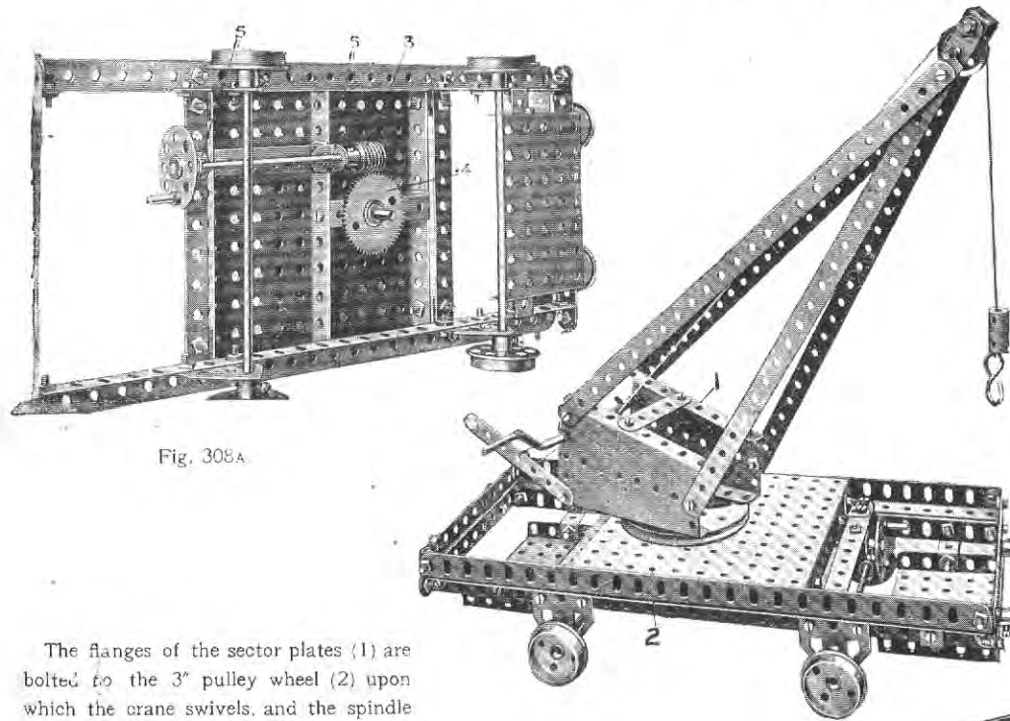


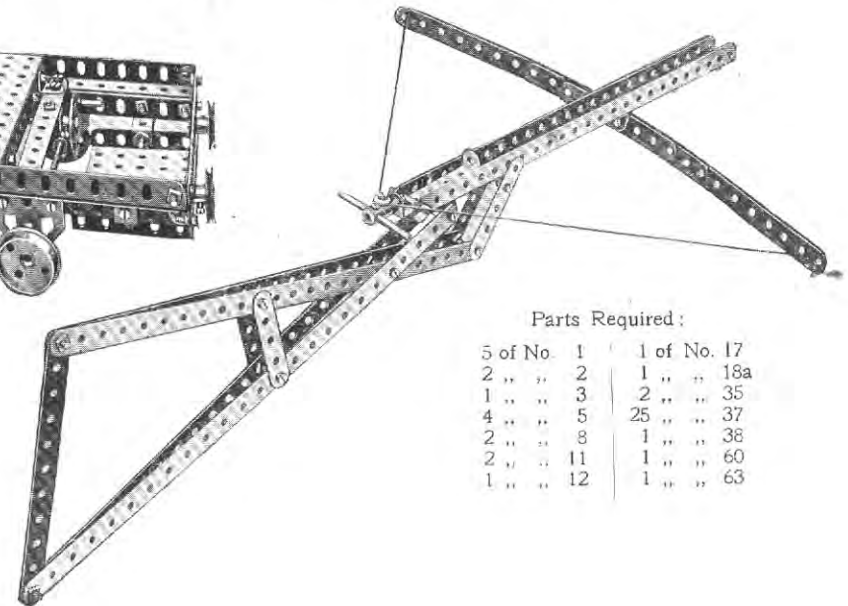
Fig. 308A.

The flanges of the sector plates (1) are bolted to the 3" pulley wheel (2) upon which the crane swivels, and the spindle of the pulley wheel is rotated by the worm (3) engaging the gear wheel (4) on the spindle. In order to bring the worm centrally over the teeth of the gear wheel (4), washers are placed between the angle brackets (5) in which the spindle of the worm is journaled.

### Parts required:

4 of No. 1	1 of No. 19	2 of No. 38
6 " " 2	1 " " 19b	2 " " 52
1 " " 3	4 " " 20	2 " " 53
2 " " 5	4 " " 22	2 " " 54
4 " " 8	1 " " 22a	1 " " 57
1 " " 11	1 " " 24	3 " " 59
14 " " 12	1 " " 27a	2 " " 60
2 " " 15	1 " " 32	1 " " 63
1 " " 15a	3 " " 35	1 " " 115
2 " " 17	70 " " 37	4 " " 125
		4 " " 126a

## Model No. 309—Crossbow

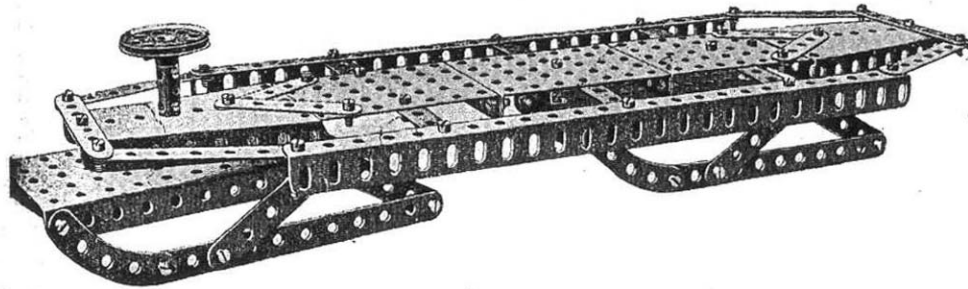


### Parts Required:

5 of No. 1	1 of No. 17
2 " " 2	1 " " 18a
1 " " 3	2 " " 35
4 " " 5	25 " " 37
2 " " 8	1 " " 38
2 " " 11	1 " " 60
1 " " 12	1 " " 63

These Models can be made with MECCANO Outfit No. 3, or No. 2 and No. 2A

### Model No. 310 Bob Sleigh



Parts required :

7 of No. 2	55 of No. 37
6 " " 3	2 " " 38
12 " " 5	1 " " 45
2 " " 8	2 " " 52
2 " " 11	3 " " 53
1 " " 17	2 " " 54
1 " " 21	1 " " 63
1 " " 24	4 " " 90

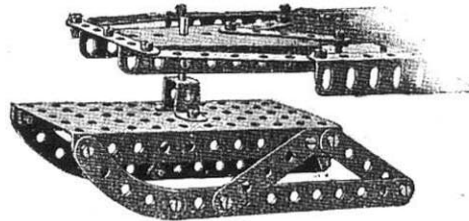
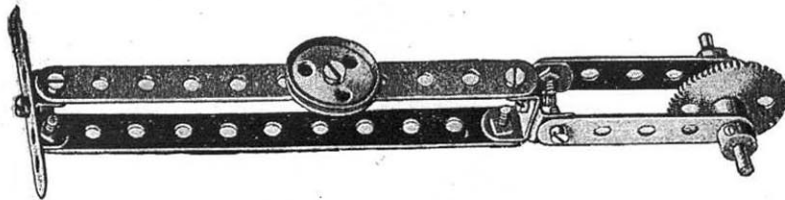


Fig. 310A.

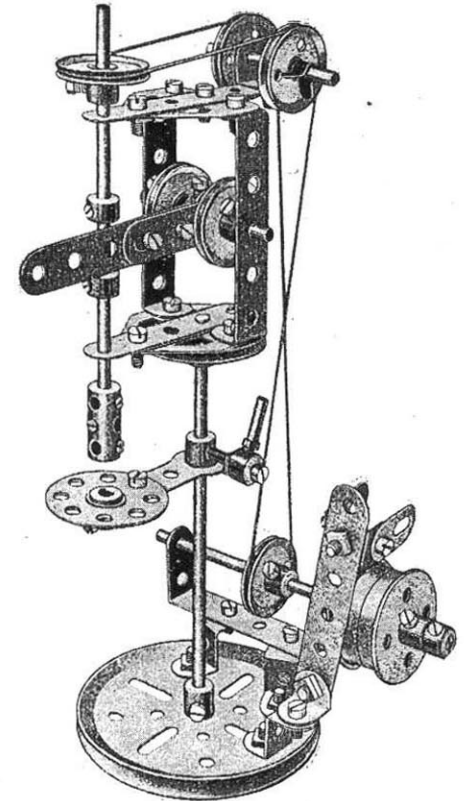
### Model No. 311 Pastry Designer



Parts  
required :

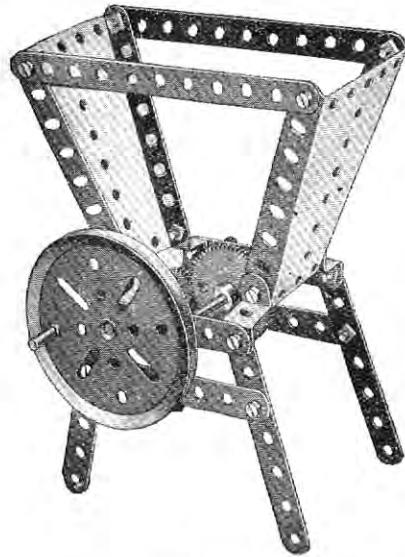
2 of No. 2
3 " " 5
3 " " 11
1 " " 17
1 " " 22A
1 " " 27A
9 " " 37
2 " " 59

### Model No. 312 Drilling Machine



Parts required :

2 of No. 4	2 of No. 20	5 of No. 59
2 " " 5	1 " " 21	2 " " 60
2 " " 10	4 " " 22	2 " " 62
2 " " 11	2 " " 22A	1 " " 63
1 " " 12	1 " " 24	1 " " 111
1 " " 15	2 " " 35	1 " " 115
2 " " 15A	21 " " 37	1 " " 125
2 " " 17	1 " " 44	3 " " 125
1 " " 19B	1 " " 46	2 " " 126A



**Model No. 313—  
Coffee  
Grinder**

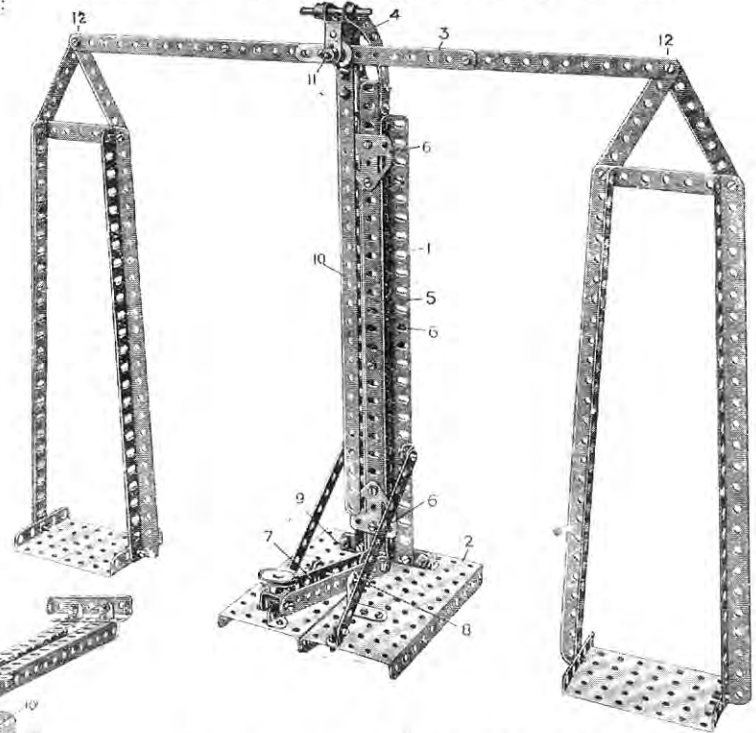
Parts required :

- 2 of No. 2
- 6 " " 3
- 2 " " 4
- 2 " " 16
- 1 " " 19n
- 1 " " 26
- 1 " " 27A
- 16 " " 37
- 2 " " 54
- 3 " " 59
- 1 " " 115
- 4 " " 125

Parts required :

- 3 of No. 1
- 4 " " 2
- 6 " " 3
- 1 " " 4
- 2 " " 5
- 8 " " 8
- 4 " " 11
- 6 " " 12
- 2 " " 12A
- 2 " " 17
- 1 " " 18A
- 1 " " 22
- 2 " " 35
- 58 " " 37
- 1 " " 44
- 2 " " 52
- 2 " " 53
- 2 " " 59
- 2 " " 62
- 4 " " 90
- 1 " " 125
- 3 " " 126A

**Model No. 314—Demonstration Scales**

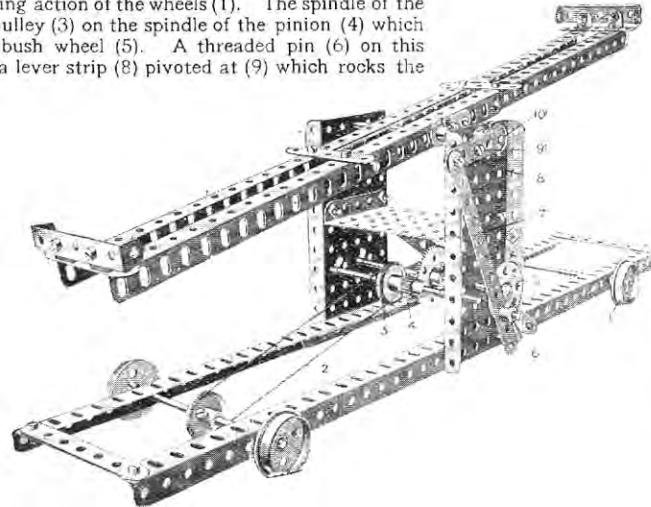


**Model No. 315—Actuated See-Saw**

The see-sawing is actuated by the travelling action of the wheels (1). The spindle of the wheels is connected by the cord (2) to the pulley (3) on the spindle of the pinion (4) which drives a gear wheel on the spindle of the bush wheel (5). A threaded pin (6) on this wheel engages the strip (7) coupled to a lever strip (8) pivoted at (9) which rocks the pivot rod (10) of the see-saw (11).

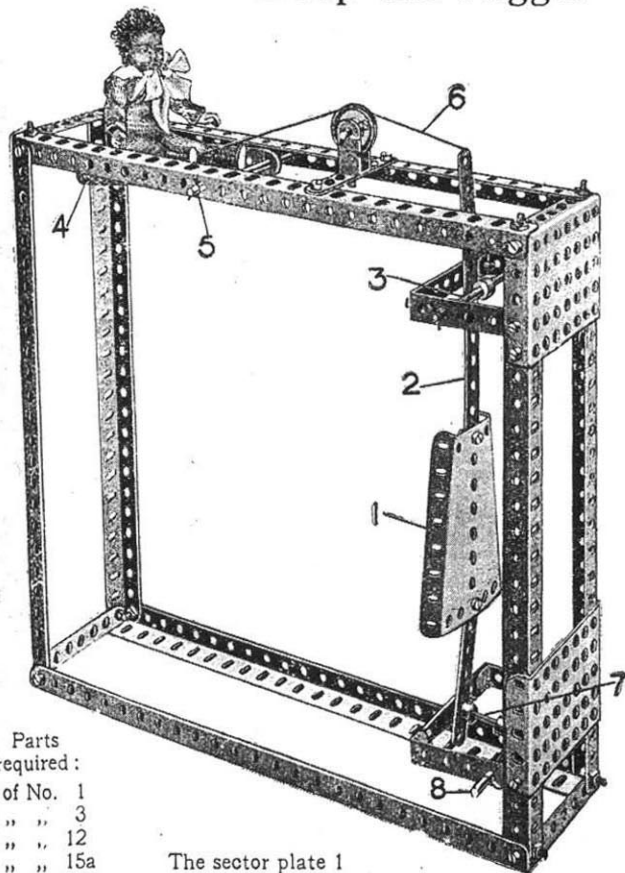
Parts required :

- |            |             |
|------------|-------------|
| 3 of No. 2 | 1 of No. 26 |
| 2 " " 3    | 1 " " 27    |
| 5 " " 5    | 4 " " 35    |
| 8 " " 8    | 36 " " 37   |
| 4 " " 12   | 2 " " 52    |
| 2 " " 15   | 1 " " 53    |
| 3 " " 15A  | 3 " " 59    |
| 4 " " 20   | 2 " " 60    |
| 2 " " 22   | 2 " " 62    |
| 1 " " 24   | 1 " " 115   |



The only feature of this model which needs description is the standard which is built up of two angle girders (1) bolted to the base (2) by angle brackets and spaced apart at the top by a 2 1/2" strip obliquely disposed. The balance lever (3) is pivotally carried in curved strips (4) bolted to the top of two angle girders (5) sliding between the girders (1). The girders (5) are themselves bolted together and in order to guide them as they slide vertically flat trunnions (6) are bolted at the front and rear. The balance is raised by depressing the lever (8) pivoted at 9 and pivotally connected at 11 to the vertically sliding girders (5). The indicator (10) is bolted to a crank at the rear, the boss of which is fitted on the pivot rod (11). The connections at 12 are lock-nutted to allow free action.

## Model No. 316—Drop the Nigger

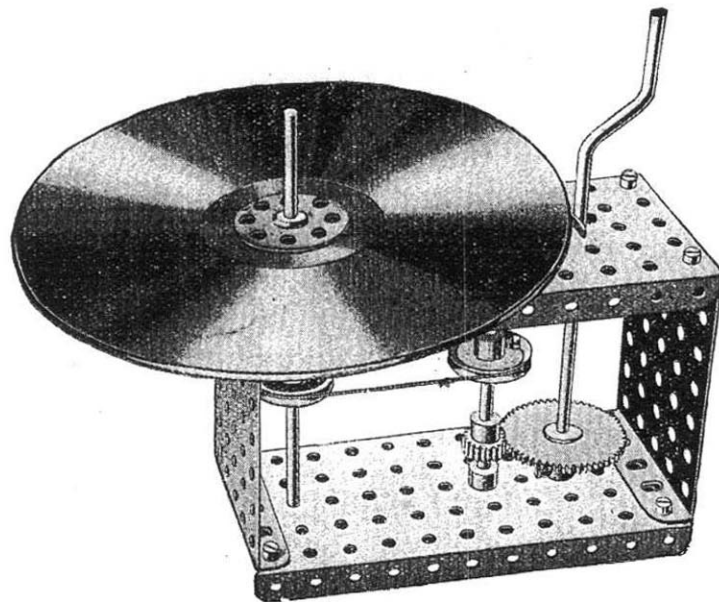


Parts  
required:

1 of No. 1
6 " " 3
1 " " 12
3 " " 15a
1 " " 17
1 " " 22
6 " " 35
33 " " 37
1 " " 44
2 " " 53
2 " " 54
3 " " 59
4 " " 60
1 " " 63

The sector plate 1 is a target, which, when hit, allows the nigger to be dropped. The plate 1 is carried on the strip 2 pivoted at 3, and the weight of the nigger supported on another sector plate 4 pivoted at 5 by means of the cord 6 keeps the lower end of the strip 2 hard against a short rod 7 pivoted at 8. When the target is hit and knocked back the rod 7 is released and falls about its pivot, allowing the sector plate 4, with the nigger to drop.

## Model No. 317—Newton's Disc



This is a model to show that white light is made up of the three primary colours—red, yellow, blue. Sectors of these three colours are mounted or painted on the disc, which, if then quickly rotated, shows as white.

Parts required:

1 of No. 15	1 of No. 24	8 of No. 37
1 " " 15A	1 " " 26	2 " " 52
1 " " 19	1 " " 27A	2 " " 53
2 " " 22	2 " " 35	4 " " 59



This Model can be made with MECCANO Outfit No. 3 or No. 2 and No. 2A  
**Model No. 318—Railway Breakdown Crane**

Parts required:

2 of No. 1	1 of No. 22a	3 of No. 53
4 " " 2	1 " " 23	1 " " 54
4 " " 11	1 " " 24	1 " " 57
1 " " 12	2 " " 26	2 " " 59
3 " " 15a	1 " " 32	2 " " 60
1 " " 16	1 " " 33	2 " " 60b
2 " " 17	4 " " 35	1 " " 63
1 " " 19	36 " " 37	1 " " 115
1 " " 19b	5 " " 38	1 " " 126a
4 " " 20	2 " " 52	

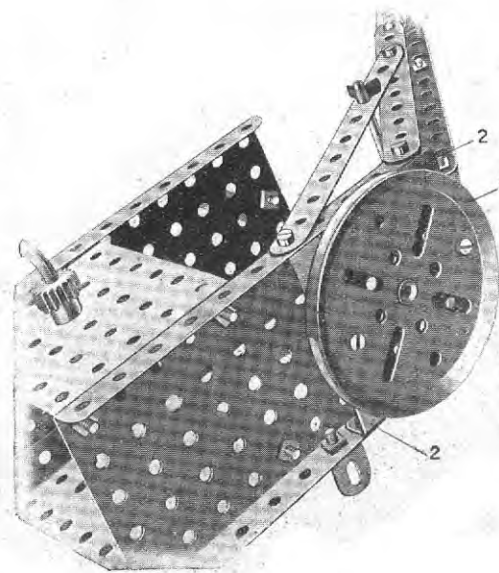
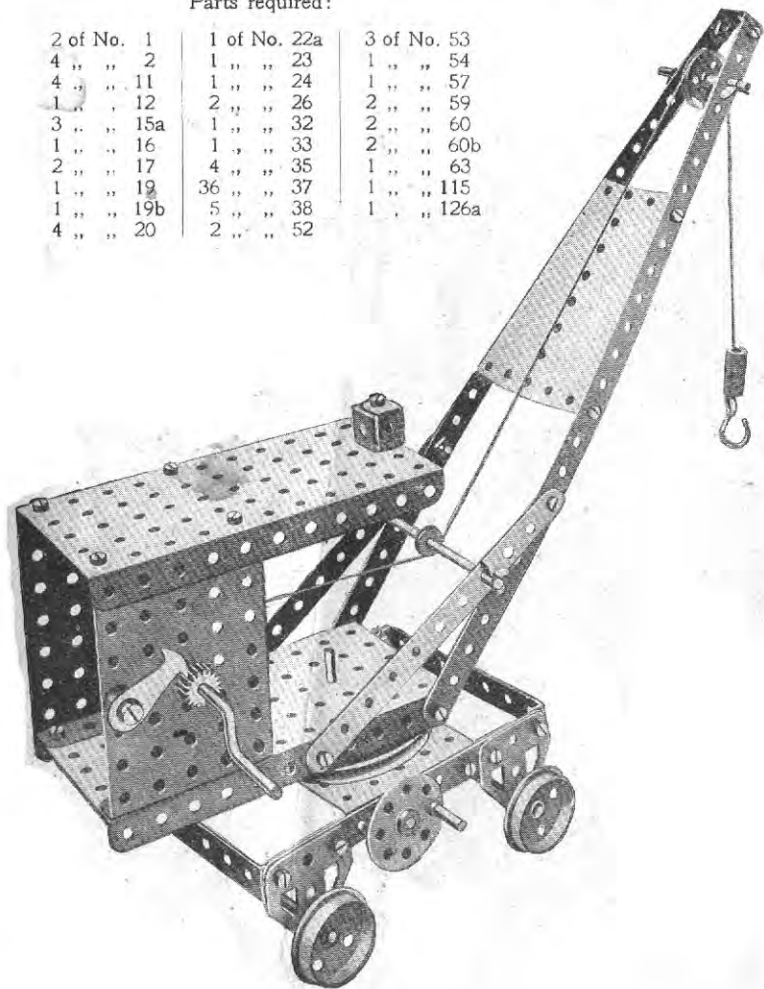


FIG. 318A.

Fig. 318B.

The swivelling action is obtained by bolting a 3" pulley (1) to double angle strips (2) on the jib frame. The boss of this wheel fits over the rod (3) and is secured to the rod. The hand wheel (4) rotates the worm (5), engaging the pinion (6) to swivel the jib.

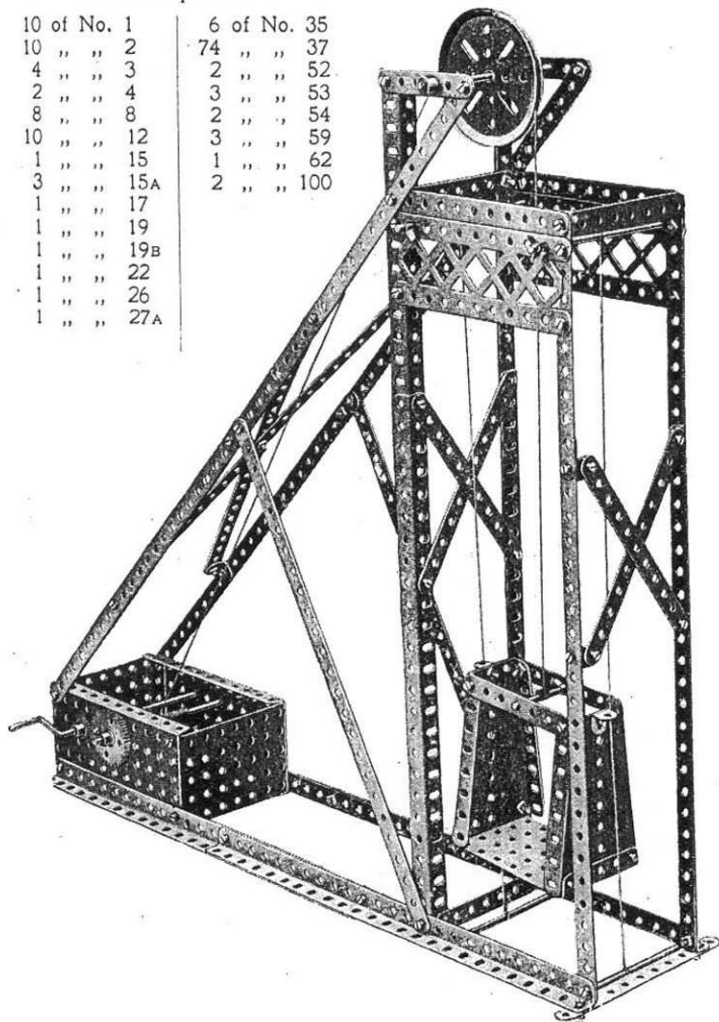
These Models can be made with MECCANO Outfit No. 3, or No. 2 and No. 2A

### Model No. 319

## Pit Head Gear

Parts required:

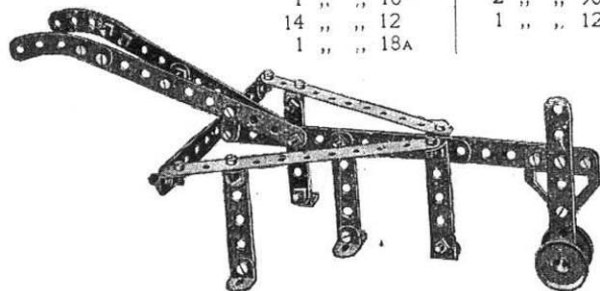
10 of No. 1	6 of No. 35
10 " " 2	74 " " 37
4 " " 3	2 " " 52
2 " " 4	3 " " 53
8 " " 8	2 " " 54
10 " " 12	3 " " 59
1 " " 15	1 " " 62
3 " " 15A	2 " " 100
1 " " 17	
1 " " 19	
1 " " 19B	
1 " " 22	
1 " " 26	
1 " " 27A	



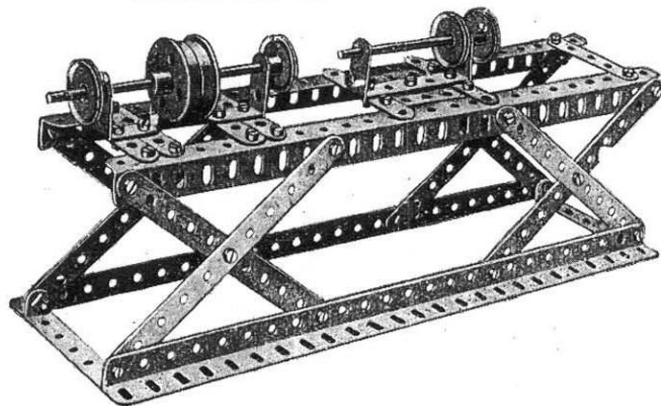
### Model No. 320 Scarifier

Parts required:

7 of No. 2	2 of No. 22
1 " " 3	31 " " 37
4 " " 5	2 " " 38
1 " " 10	2 " " 90
14 " " 12	1 " " 126A
1 " " 18A	



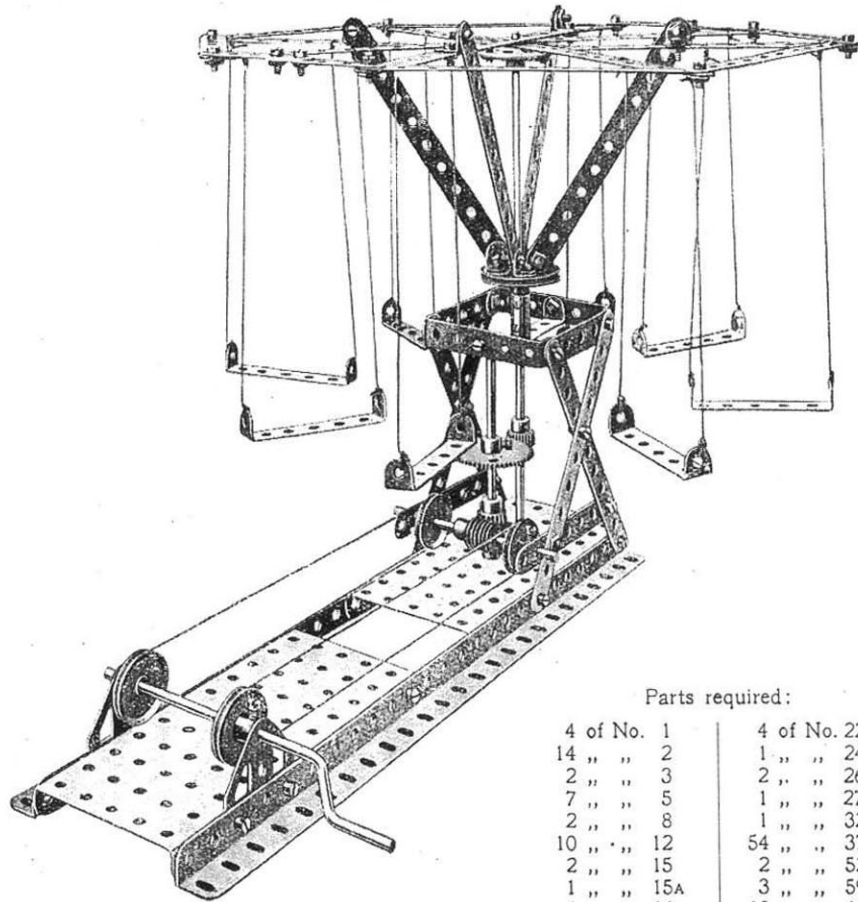
### Model No. 321 Lathe



Parts required:

8 of No. 2	2 of No. 20
10 " " 5	1 " " 22
4 " " 8	41 " " 37
2 " " 12A	1 " " 46
1 " " 15A	2 " " 60
1 " " 16	

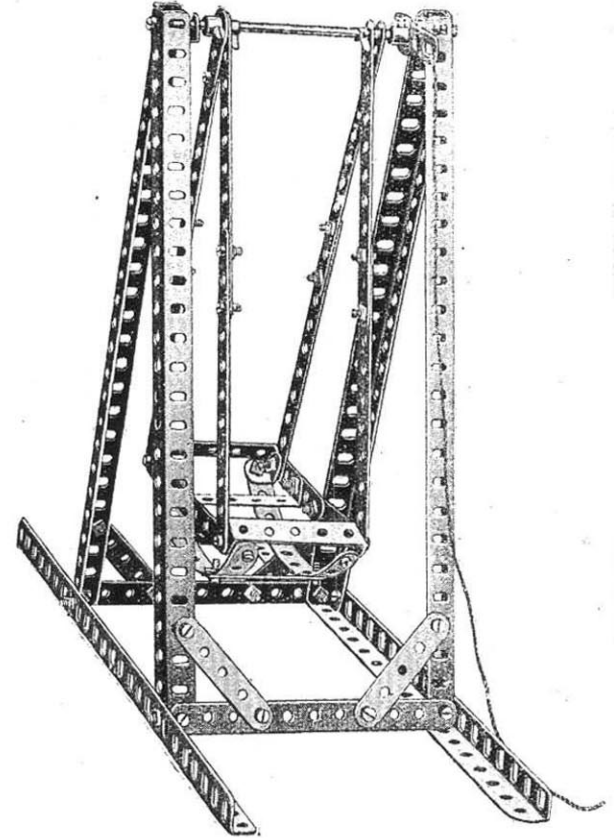
Model No. 322 Roundabout



Parts required:

4 of No. 1	4 of No. 22
14 " " 2	1 " " 24
2 " " 3	2 " " 26
7 " " 5	1 " " 27A
2 " " 8	1 " " 32
10 " " 12	54 " " 37
2 " " 15	2 " " 52
1 " " 15A	3 " " 59
1 " " 16	10 " " 60
1 " " 19	1 " " 63
1 " " 21	2 " " 126A

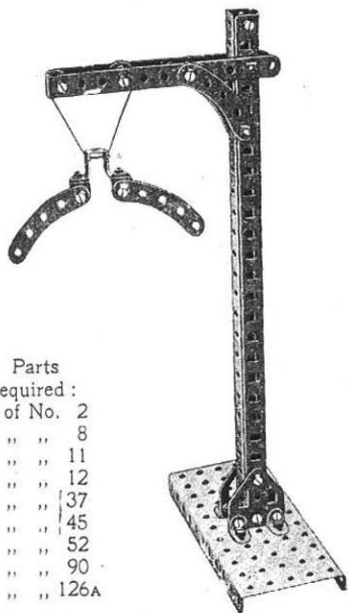
Model No. 323 Swing



Parts required:

12 of No. 2	1 of No. 15
9 " " 5	2 " " 35
6 " " 8	43 " " 37
2 " " 11	4 " " 60
4 " " 12	2 " " 62

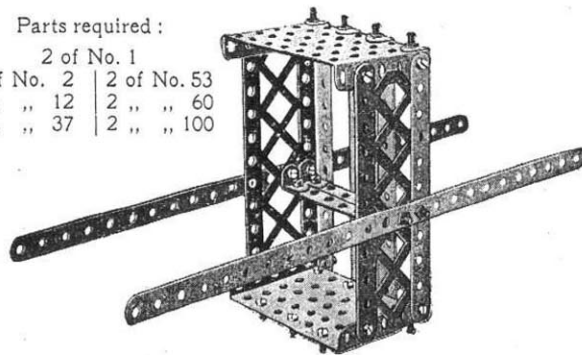
### Model No. 324 Railway Gauge



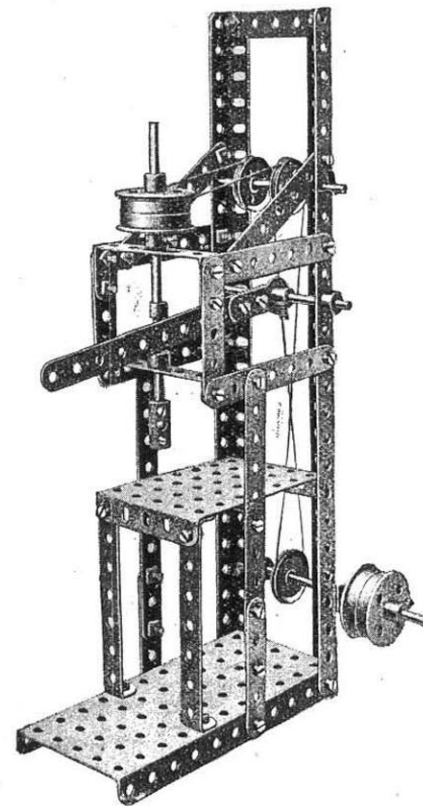
Parts required:  
 2 of No. 2  
 2 " " 8  
 3 " " 11  
 6 " " 12  
 28 " " 37  
 1 " " 45  
 1 " " 52  
 4 " " 90  
 2 " " 126A

### Model No. 325—Chinese Palanquin

Parts required:  
 2 of No. 1  
 4 of No. 2 | 2 of No. 53  
 8 " " 12 | 2 " " 60  
 30 " " 37 | 2 " " 100



### Model No. 326 Hand Punch

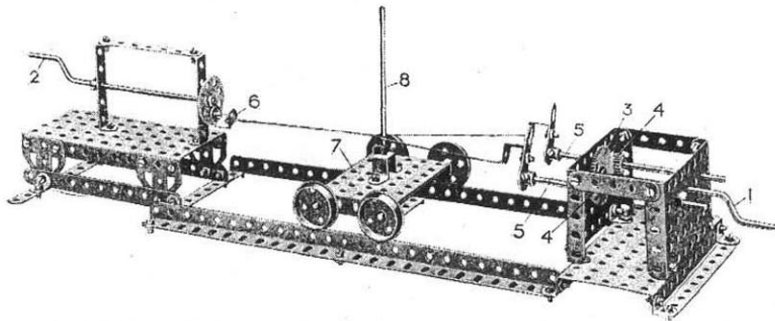


Parts required:

3 of No. 2	4 of No. 20	1 of No. 53
6 " " 3	1 " " 22	4 " " 59
5 " " 5	2 " " 22A	2 " " 60
2 " " 8	3 " " 35	2 " " 60B
2 " " 11	38 " " 37	1 " " 62
2 " " 15	1 " " 46	1 " " 63
2 " " 16	1 " " 52	

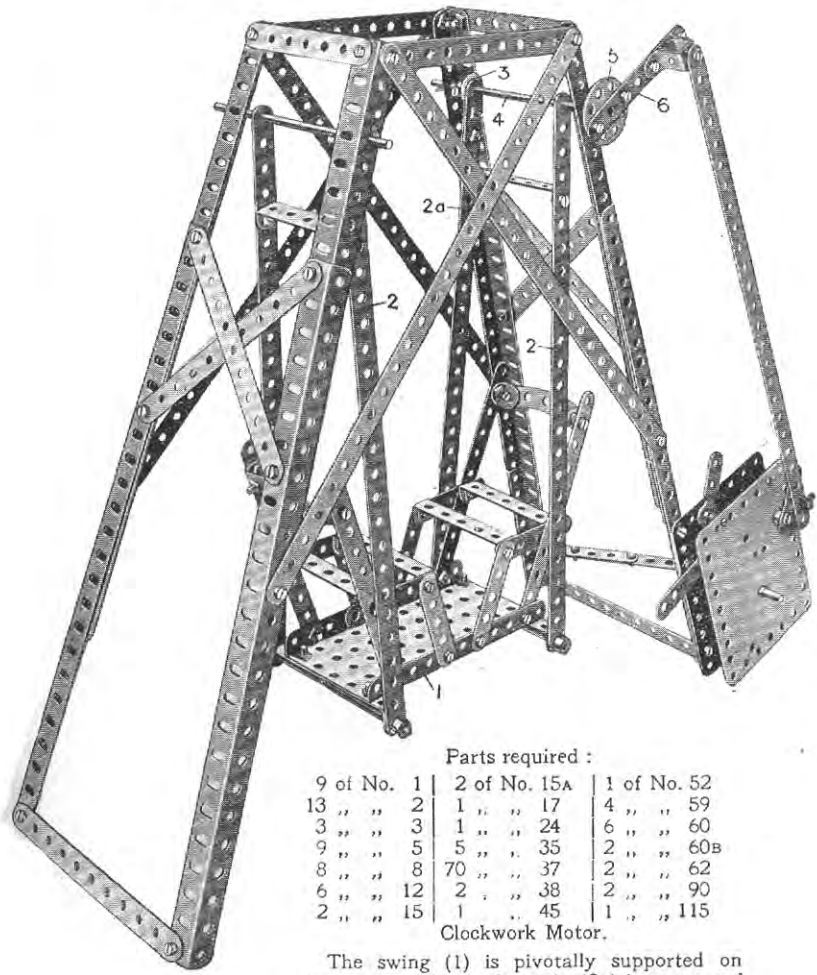
### Model No. 327—Wire Rope Maker

The strands are twisted from both ends by the handles (1) and (2) of the fixed parts. The handle (1) rotates through a large gear wheel (3) two pinions (4) on the rods (5) carrying cranks to which the strands are attached. The other ends of the strands are connected to a double bent strip (6) on a bush wheel which is rotated in the opposite direction by a crank handle (2). The carriage (7) runs on rails and the vertical rod (8) is kept just at the formation of the twisted rope and so controls the tightness of the twist.



Parts required:	2 of No. 5	2 of No. 15	1 of No. 24	50 of No. 37	4 of No. 59
	2 " " 8	3 " " 15A	2 " " 26	1 " " 45	2 " " 60
6 of No. 2	3 " " 11	2 " " 19	1 " " 27A	2 " " 52	2 " " 62
1 " " 3	12 " " 12	4 " " 20	3 " " 35	3 " " 53	4 " " 126A

These Models can be made with MECCANO Outfit No. 3, or No. 2 and No. 2A  
**Model No. 328—Lawn Swing**



Parts required :

9 of No. 1	2 of No. 15A	1 of No. 52
13 " " 2	1 " " 17	4 " " 59
3 " " 3	1 " " 24	6 " " 60
9 " " 5	5 " " 35	2 " " 60B
8 " " 8	70 " " 37	2 " " 62
6 " " 12	2 " " 38	2 " " 90
2 " " 15	1 " " 45	1 " " 115

Clockwork Motor.

The swing (1) is pivotally supported on four strips (2), the far strip (2a) is connected at the top to a crank (3) which is bolted to a rod (4) and at the front end of this rod is a wheel (5) to which is bolted a strip (6) to the motor spindle.

**Model No 329  
 Oil Cake  
 Chopper**

Parts required :

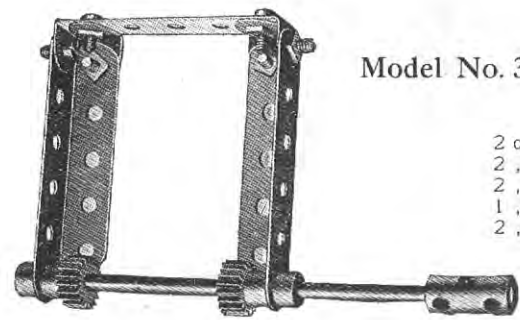
10 of No. 2
4 " " 10
2 " " 12
1 " " 19
4 " " 22
2 " " 35
20 " " 37
1 " " 52
2 " " 53
2 " " 54
2 " " 60B



**Model No. 330—Rattle**

Parts required :

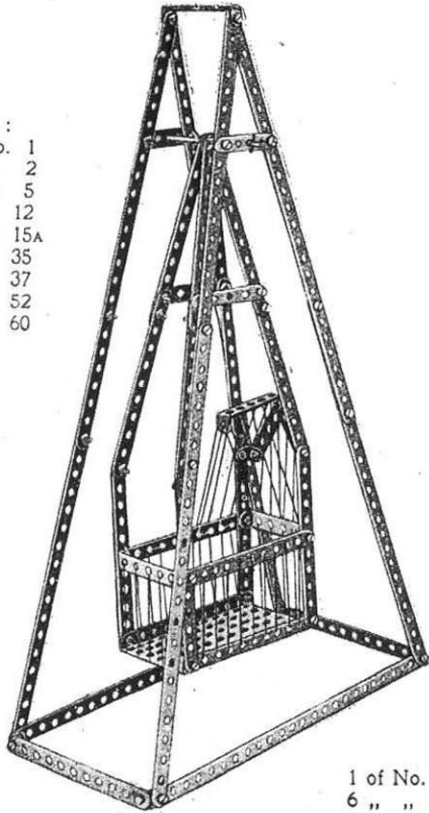
2 of No. 4	6 of No. 37
2 " " 5	2 " " 59
2 " " 12	1 " " 60
1 " " 15	1 " " 63
2 " " 26	



## Model No. 331—Swinging Cot

Parts required:

1 of No.	1
5 "	2
2 "	5
1 "	12
1 "	15A
1 "	35
1 "	37
1 "	52
1 "	60



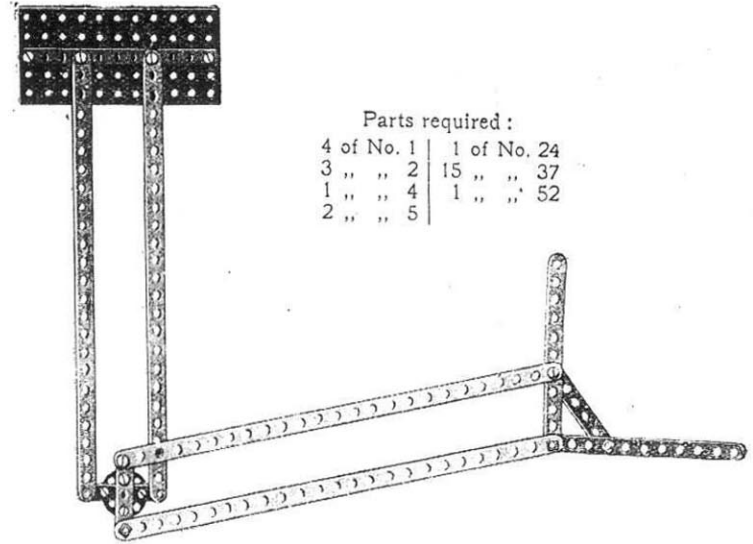
Parts required:

1 of No.	2	4 of No.	20	2 of No.	54
6 "	5	6 "	35	2 "	59
1 "	15A	21 "	37	4 "	60
4 "	16	1 "	53	1 "	126A

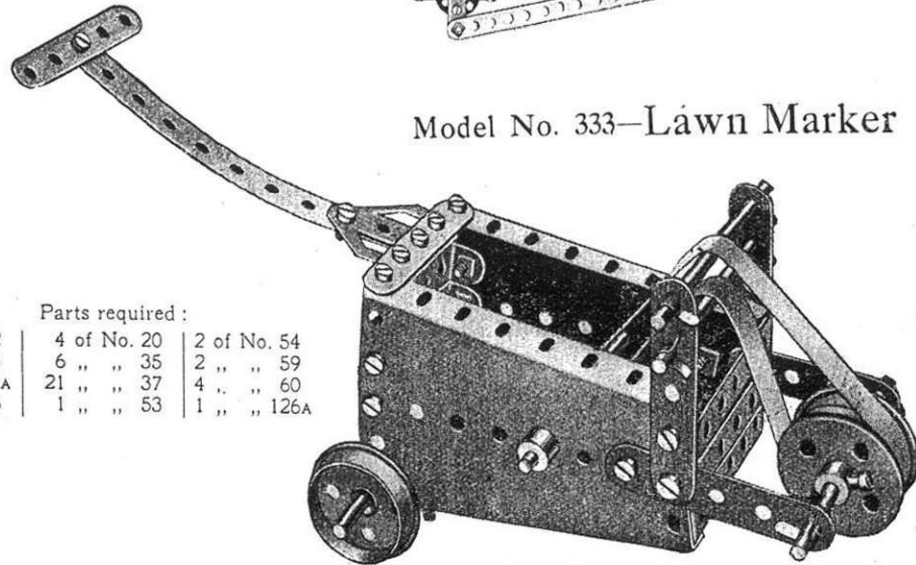
## Model No. 332—Drafting Machine

Parts required:

4 of No.	1	1 of No.	24
3 "	2	15 "	37
1 "	4	1 "	52
2 "	5		



## Model No. 333—Lawn Marker



### Model No. 334— LaceJennier

Parts  
required :

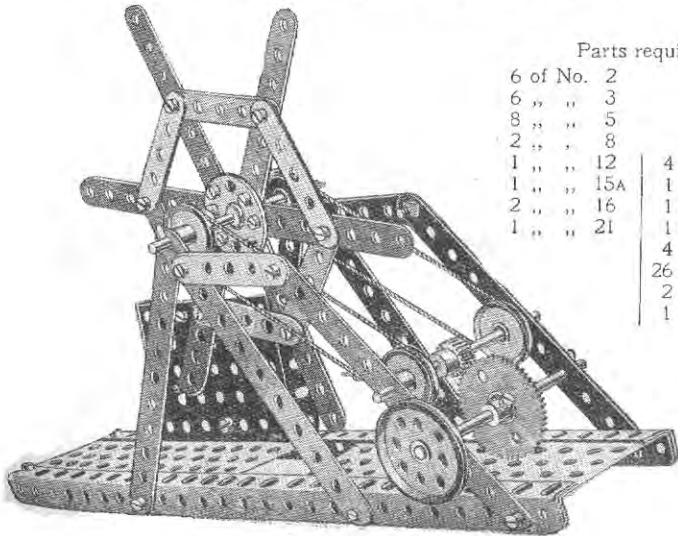
8 of No. 2
4 " " 11
1 " " 15
1 " " 19
1 " " 24
14 " " 37
1 " " 52
1 " " 59
1 " " 62
1 " " 63



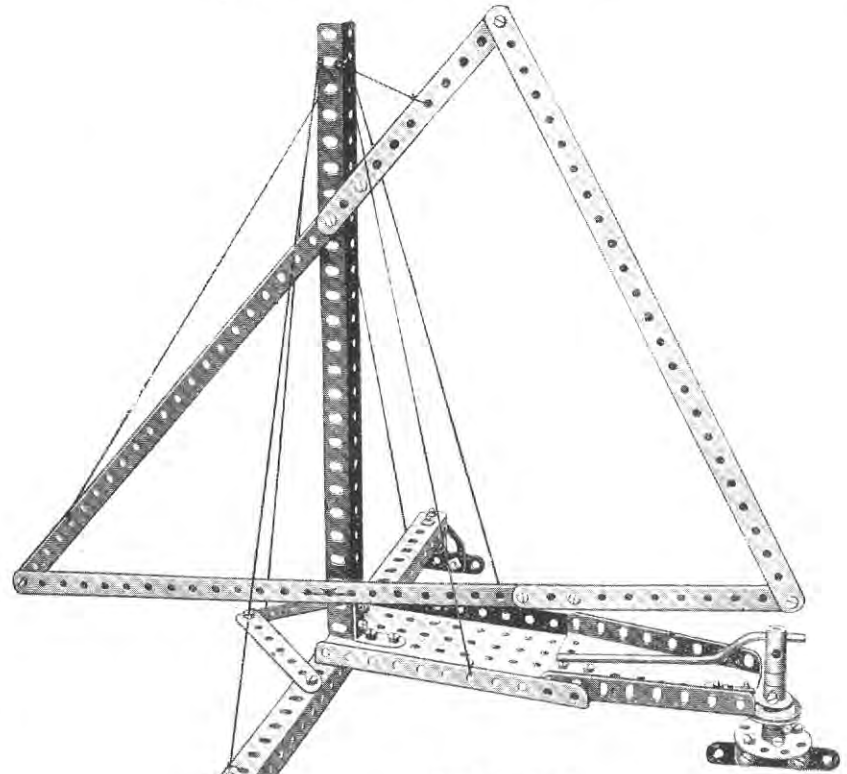
### Model No. 335—Flax Cleaner

Parts required :

6 of No. 2	4 of No. 22
6 " " 3	1 " " 24
8 " " 5	1 " " 26
2 " " 8	1 " " 27A
1 " " 12	4 " " 35
1 " " 15A	26 " " 37
2 " " 16	2 " " 52
1 " " 21	1 " " 53



### Model No. 336—Ice Boat



Parts required :

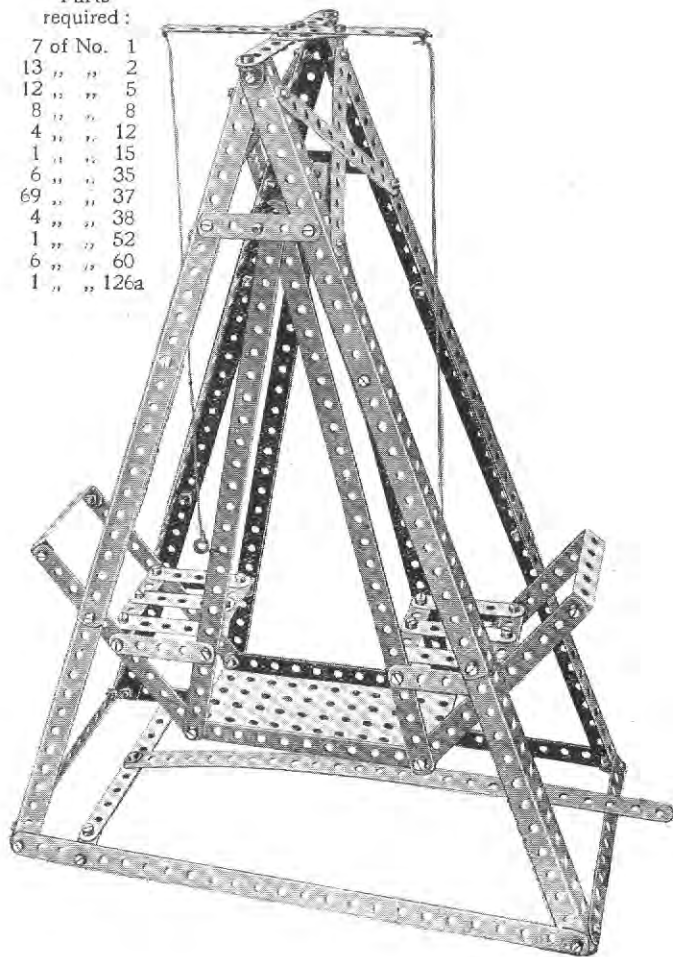
3 of No. 1	1 of No. 22
2 " " 2	1 " " 24
2 " " 3	36 " " 37
3 " " 5	1 " " 52
2 " " 8	1 " " 54
2 " " 12	1 " " 59
3 " " 12A	1 " " 62
1 " " 17	1 " " 63
1 " " 19	2 " " 126A

## Model No. 337—Swing

## Model No. 338—Automatic Swing Boat

Parts  
required:

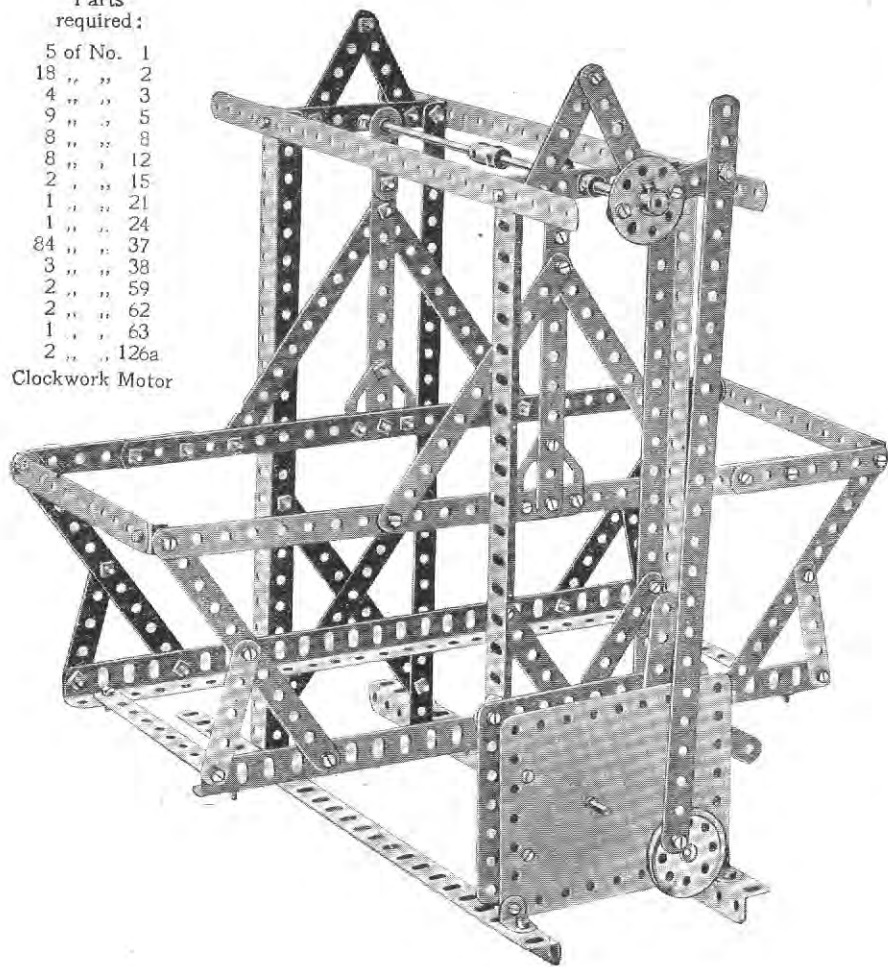
7 of No.	1
13 "	2
12 "	5
8 "	8
4 "	12
1 "	15
6 "	35
69 "	37
4 "	38
1 "	52
6 "	60
1 "	126a



Parts  
required:

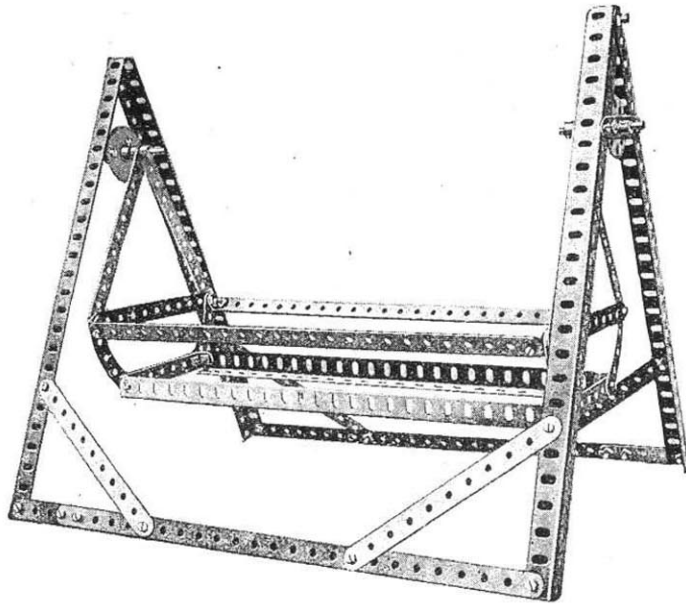
5 of No.	1
18 "	2
4 "	3
9 "	5
8 "	8
8 "	12
2 "	15
1 "	21
1 "	24
84 "	37
3 "	38
2 "	59
2 "	62
1 "	63
2 "	126a

Clockwork Motor





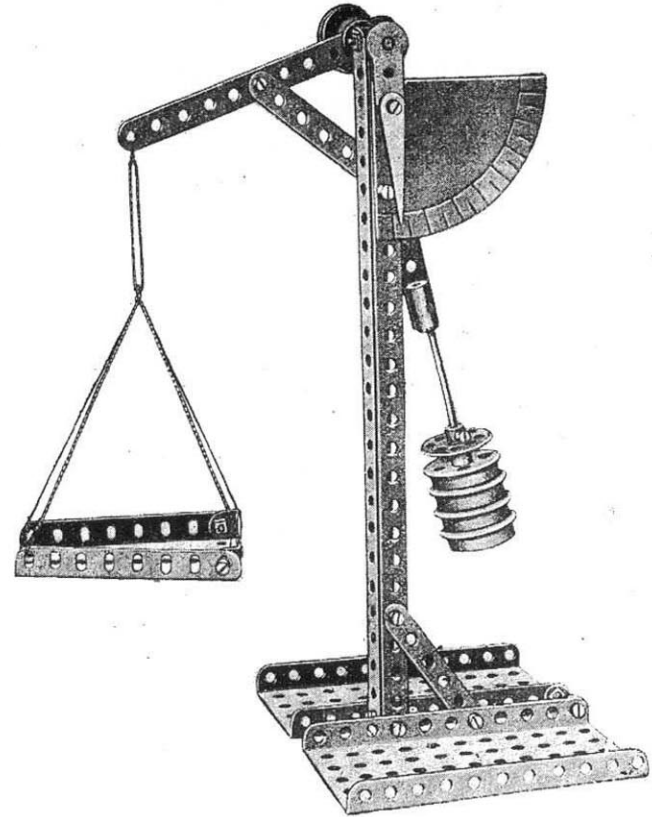
### Model No. 339—Swing Cot



Parts required:

4 of No. 1	1 of No. 27a
10 " " 2	42 " " 37
4 " " 5	4 " " 38
6 " " 8	4 " " 59
4 " " 12	2 " " 60b
2 " " 17	4 " " 90
1 " " 24	

### Model No. 340—Scales

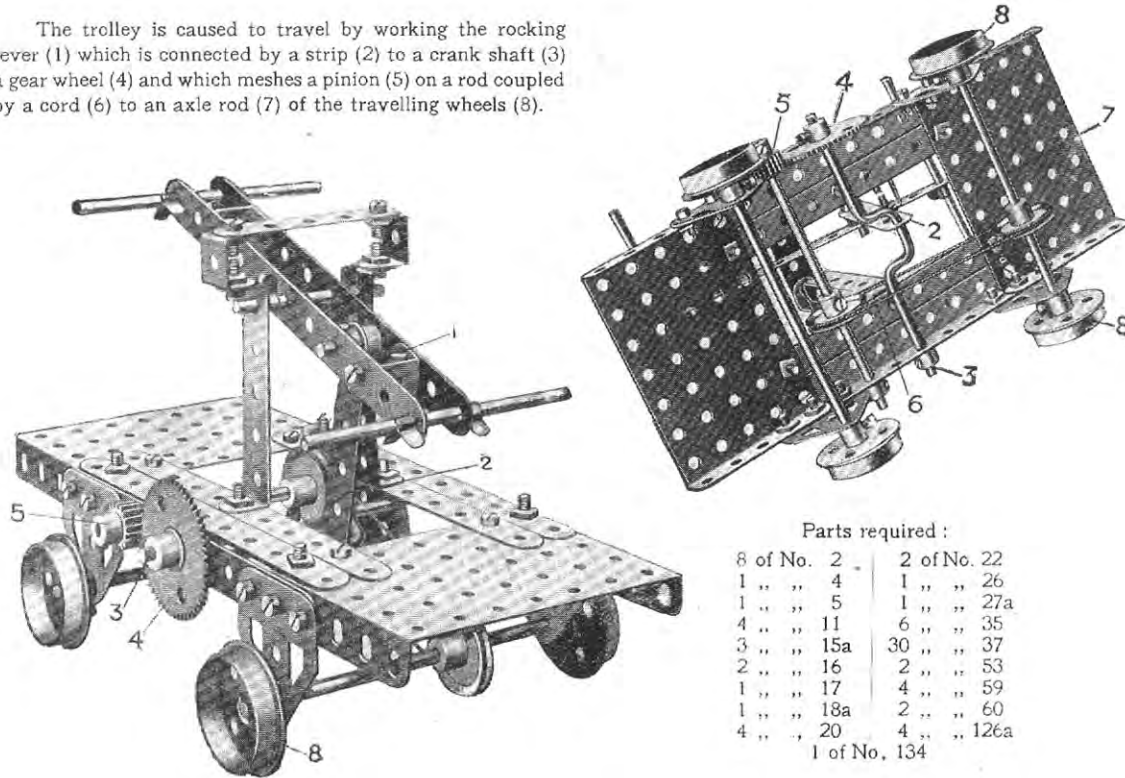


Parts required:

2 of No. 2	1 of No. 15	2 of No. 52
1 " " 3	1 " " 17	1 " " 54
2 " " 4	4 " " 20	1 " " 60
1 " " 5	1 " " 22	2 " " 62
2 " " 8	1 " " 24	1 " " 63
1 " " 11	15 " " 37	1 " " 90

## Model No. 341—Hand Trolley

The trolley is caused to travel by working the rocking lever (1) which is connected by a strip (2) to a crank shaft (3) a gear wheel (4) and which meshes a pinion (5) on a rod coupled by a cord (6) to an axle rod (7) of the travelling wheels (8).



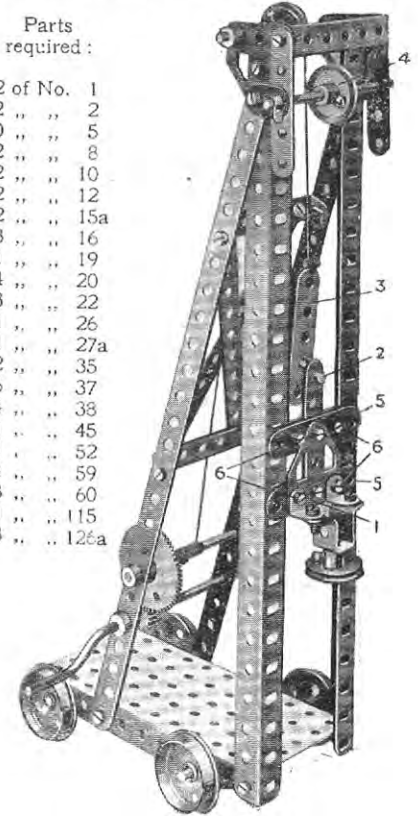
### Parts required :

8 of No. 2	2 of No. 22
1 " " 4	1 " " 26
1 " " 5	1 " " 27a
4 " " 11	6 " " 35
3 " " 15a	30 " " 37
2 " " 16	2 " " 53
1 " " 17	4 " " 59
1 " " 18a	2 " " 60
4 " " 20	4 " " 126a
	1 of No. 134

## Model No. 342—Pile Driver

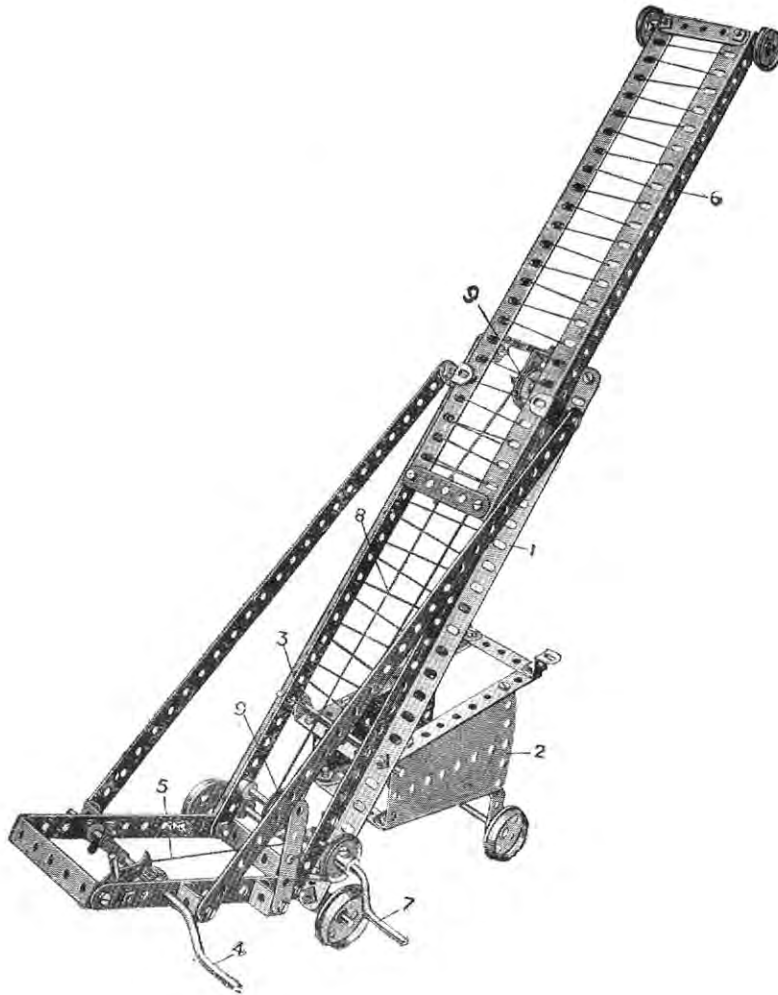
### Parts required :

2 of No. 1	
2 " " 2	
10 " " 5	
2 " " 8	
2 " " 10	
2 " " 12	
2 " " 15a	
3 " " 16	
1 " " 19	
4 " " 20	
3 " " 22	
1 " " 26	
1 " " 27a	
2 " " 35	
26 " " 37	
4 " " 38	
1 " " 45	
1 " " 52	
4 " " 59	
3 " " 60	
1 " " 115	
3 " " 126a	



The driving head (1) is raised by means of a threaded pin (2) on two  $2\frac{1}{2}$ " strips (3), the pin engaging in the first hole of the driving head. As the head is raised, the strip (3) makes contact with a pulley (4) and the latter pushes the strip rearwardly, disengaging the pin from the hole on the driving head, permitting it to fall. The cross strips (5) of the driving head are duplicated behind, spacing washers being inserted between them on the bolts (6) to allow free movement up and down the guide girders.

## Model No. 343—Fire Escape



The main frame (1) is pivotally connected to the running truck (2) about the rod (3). Ordinarily the frame (1) rests on the running truck (2) when the escape is being transported. In order to raise the main frame about the pivot rod (3) the handle (4) winds up the cord (5) the outer end of which is connected to the running truck axle in order to raise or lower the ladder (6) the handle (7) is turned in one or other direction, the cord (8) passing over the pulleys (9) and being connected to the rising ladder.

### Parts required :

2 of No. 1	4 of No. 16	7 of No. 35
4 " " 2	1 " " 18A	45 " " 37
1 " " 3	2 " " 19	1 " " 44
6 " " 5	4 " " 20	2 " " 54
4 " " 8	4 " " 22	3 " " 59
3 " " 11	1 " " 22A	3 " " 60
10 " " 12	1 " " 26	1 " " 115
2 " " 12A	1 " " 33	4 " " 125
1 " " 15A		

## Model No. 401. Elevated Jib Crane

### Parts required:

4 of No. 1	1 of No. 24
7 " " 2	2 " " 26
2 " " 3	1 " " 27A
11 " " 5	1 " " 28
4 " " 8	9 " " 35
2 " " 11	64 " " 37
11 " " 12	1 " " 45
2 " " 13	1 " " 46
2 " " 15	2 " " 52
3 " " 17	3 " " 53
4 " " 20	1 " " 54
1 " " 21	1 " " 57
4 " " 22	5 " " 59
1 " " 22A	4 " " 60

The base of the main frame is composed of two large flanged plates 1, to the outer corners of which are bolted the vertical angle girders 2. The jib, Fig. 401A, is made from  $12\frac{1}{2}$ " strips 3 distended centrally by double brackets 4 and bolted together at the ends. Angle brackets 5 form the pivots for the jib about a spindle 6 mounted in the end holes 7 of the flanges of the sector plate 8 forming the base of the upper gear box, Fig. 401B. The balance weight 9 is composed of several flanged wheels carried by  $5\frac{1}{2}$ " strips 10. The hoisting cord 11 passes over the jib end pulley to the guide pulley 12, and winds on the upper end of the vertical spindle 13, carried in the angle bracket 14, and the top plate 15. The vertical spindle 13 is operated by a gear wheel 16 meshing with a  $\frac{1}{2}$ " pinion on the other vertical spindle 17, which is driven by a contrate wheel 18 from a  $\frac{1}{2}$ " pinion 19, Fig. 401c, on the cranked spindle 20. The swivelling of the jib is effected from the cranked spindle 21 by the continuous cord 22 which passes round the pulley wheel 23 over the pulley wheel 24, and round the  $1\frac{1}{2}$ " pulley wheel 25, bolted to the under surface of the base sector plate 8 of the upper gear box.

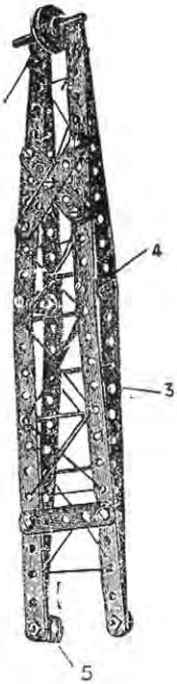
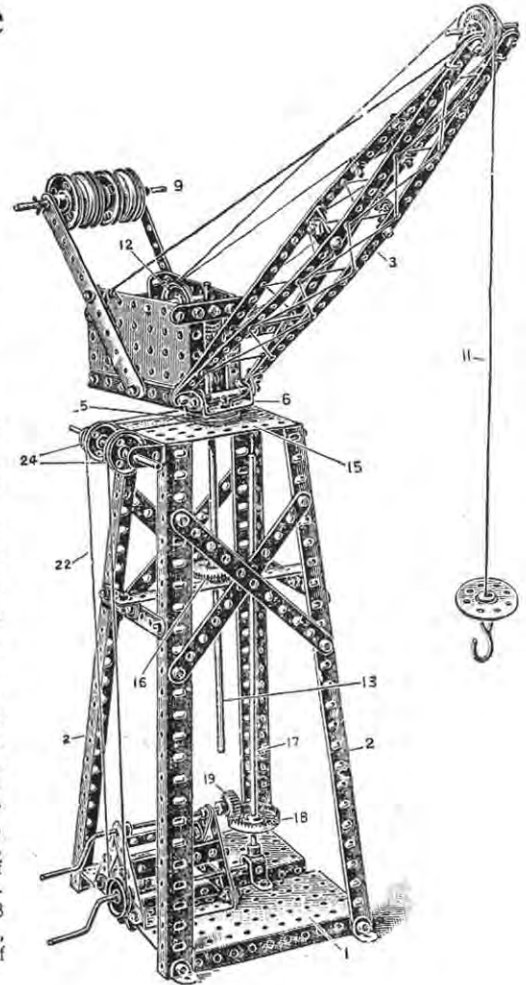


FIG. 401A

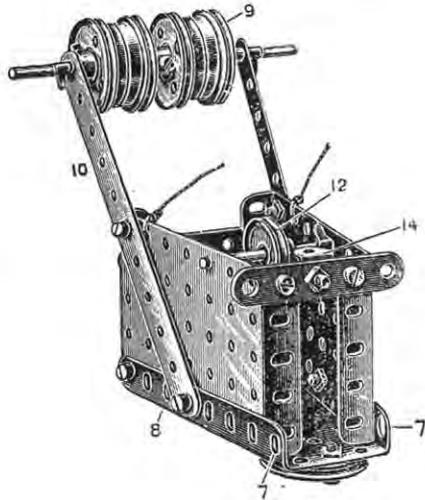


FIG. 401B

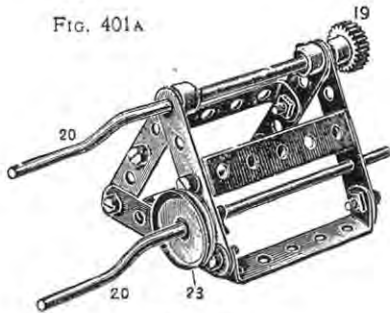
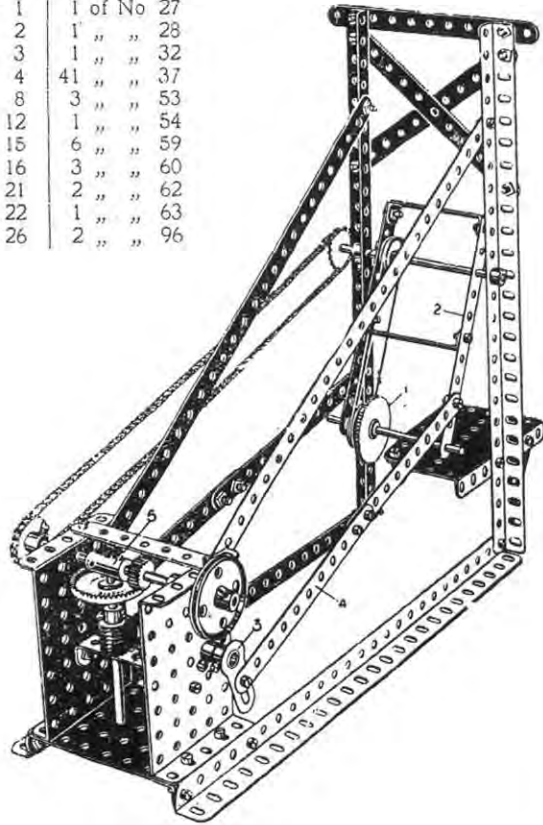


FIG. 401c

# Model No. 402 Swinging Hot Saw

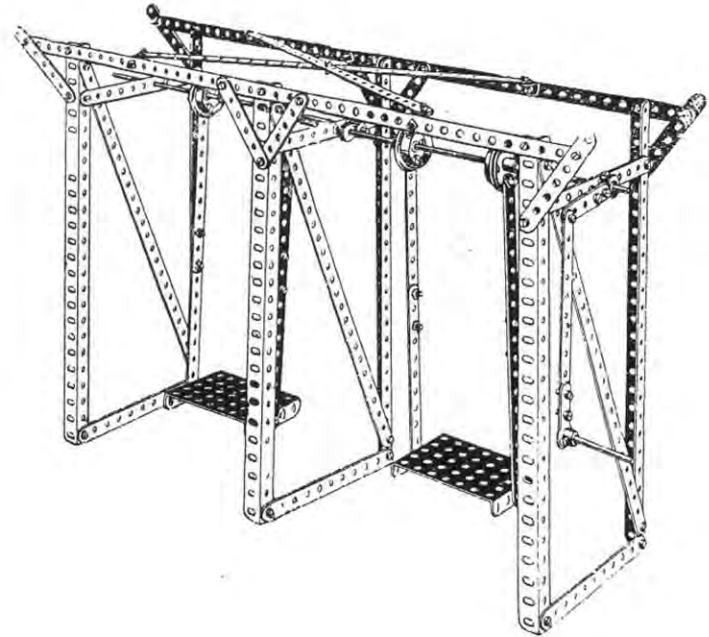
Parts required :

2 of No. 1	1 of No 27
9 " " 2	1 " " 28
2 " " 3	1 " " 32
1 " " 4	41 " " 37
4 " " 8	3 " " 53
1 " " 12	1 " " 54
2 " " 15	6 " " 59
3 " " 16	3 " " 60
1 " " 21	2 " " 62
2 " " 22	1 " " 63
2 " " 26	2 " " 96



The swinging frame 2 carrying the circular saw 1 is rocked to and fro by a continuous rotary movement of the crank 3 through the connecting strips 4. The coupling 5 is loose on the sprocket wheel spindle and forms a bearing for the spindle of the worm.

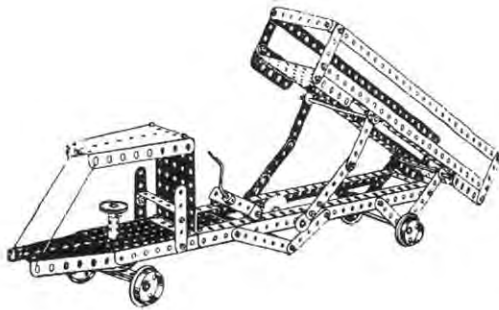
# Model No. 403 Alternating Swing



Parts required :

9 of No. 1	4 of No. 12	63 of No. 37
15 " " 2	2 " " 13	2 " " 53
6 " " 3	1 " " 17	2 " " 59
2 " " 4	4 " " 20	2 " " 62
	2 " " 26	

## Model No. 404 Tip Wagon



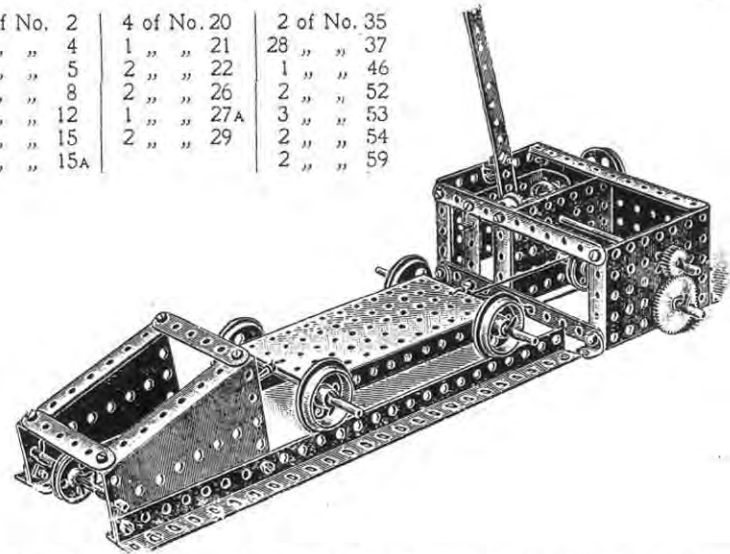
Parts required :

2 of No. 1	1 of No. 17	1 of No. 45
6 " " 3	1 " " 19	1 " " 52
2 " " 4	4 " " 20	3 " " 53
12 " " 5	1 " " 22	2 " " 54
4 " " 8	1 " " 24	4 " " 59
6 " " 12	1 " " 27	4 " " 60
3 " " 15A	1 " " 32	2 " " 62
2 " " 16	2 " " 35	1 " " 63
	54 " " 37	

## Model No. 405 Cable Railway

Parts required :

3 of No. 2	4 of No. 20	2 of No. 35
2 " " 4	1 " " 21	28 " " 37
1 " " 5	2 " " 22	1 " " 46
2 " " 8	2 " " 26	2 " " 52
6 " " 12	1 " " 27A	3 " " 53
4 " " 15	2 " " 29	2 " " 54
2 " " 15A		2 " " 59

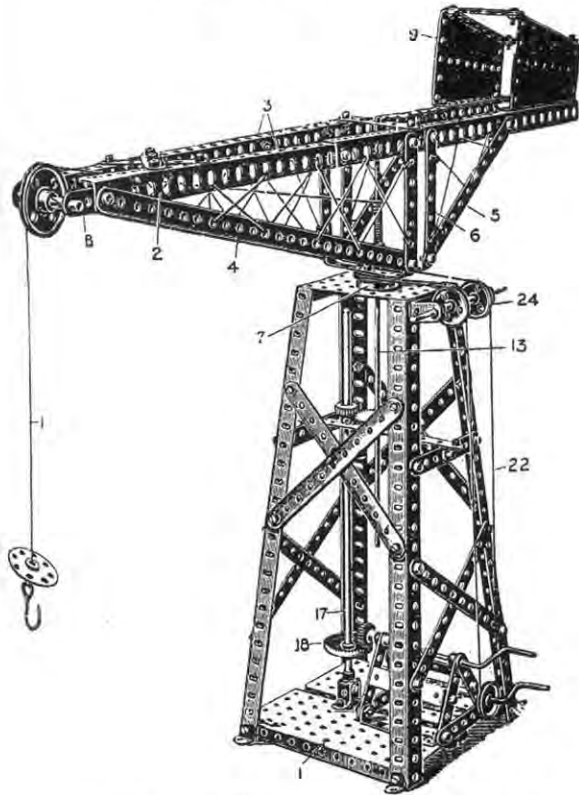


Our illustration scarcely does this excellent model justice, owing to the sections of which it is composed having to be so crowded together. This is a very fine model, both instructive and highly interesting.

The driving power is received at the outer  $1\frac{1}{2}$ " pulley, and is transmitted through the clutch mechanism and the pinion and gear wheels to the lower spindle on which the driving pulley is fixed, the driving rope passing round this pulley and the second pulley at the end of the rails, all as shown in the drawing.

In fixing the lever for operating the clutch mechanism, the nuts should be locked to prevent the screw working out. Only one section of rails is shown in the design, but they may be extended as desired.

## Model No. 406 Girder Crane

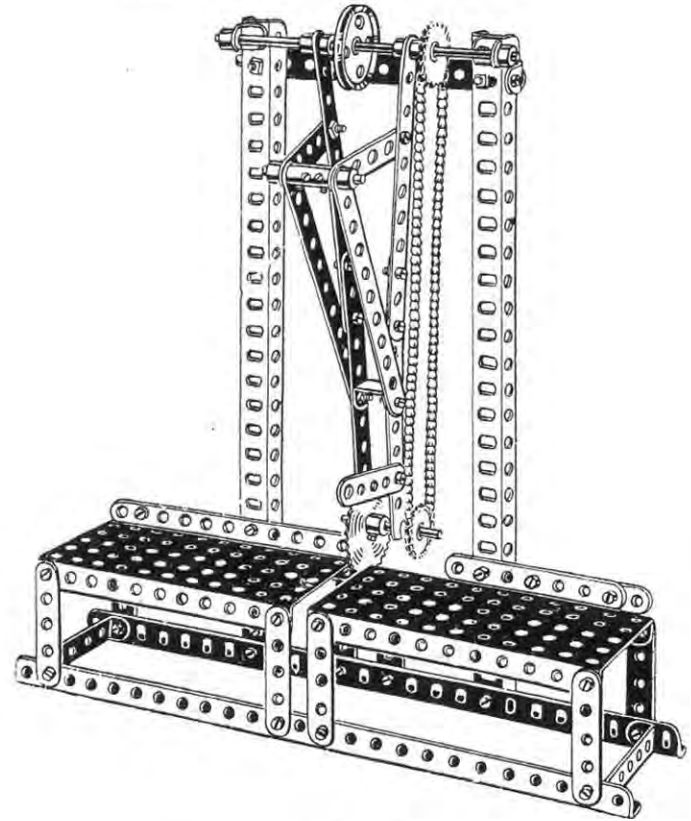


Parts  
required:

2 of No.	1
11 "	2
6 "	3
14 "	5
8 "	8
6 "	12
2 "	13
1 "	16
1 "	17
2 "	19
1 "	20
1 "	21
3 "	22
1 "	24
2 "	26
1 "	27A
1 "	28
6 "	35
75 "	37
1 "	45
1 "	46
2 "	52
1 "	53
2 "	54
1 "	57
4 "	59
6 "	60

The lower structure of this model is identical with that of Fig. 401. The hoisting cord 1 after passing over the end jib pulley, winds on the  $11\frac{1}{2}$ " rod 13, as described in Fig. 401. The jib is built up of horizontal angle girders 3, overlapped 8 holes and strengthened by the diagonal  $12\frac{1}{2}$ " strips 4 and  $5\frac{1}{2}$ " strips 5 connected to the vertical  $3\frac{1}{2}$ " strips 6 bolted at the bottom to  $2\frac{1}{2}$ " bent strips bolted to the flanged wheel 7.  $2\frac{1}{2}$ " strips 8 extend from the angle girders 3 to carry the jib pulley. The balance weight is formed by two sector plates 9.

## Model No. 407 Swing Saw



Parts required:

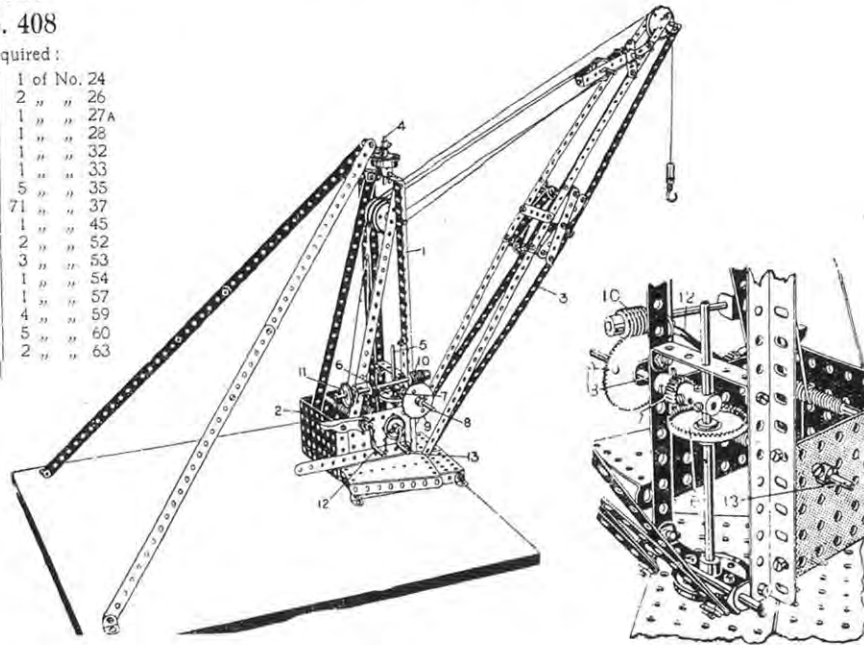
8 of No.	2	4 of No.	12	8 of No.	59
1 "	3	1 "	14	2 "	60
12 "	5	2 "	17	1 "	63
6 "	8	1 "	21	1 "	94
1 "	10	45 "	37	1 "	95
1 "	11	2 "	52	2 "	96

# Swivelling and Luffing Jib Crane

## Model No. 408

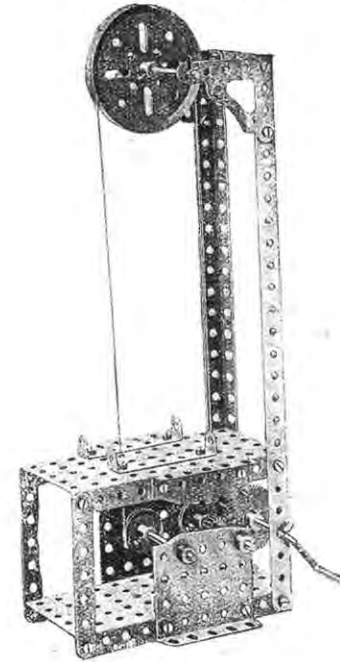
Parts required:

4 of No. 1	1 of No. 24
1 " " 2	2 " " 26
4 " " 3	1 " " 27A
5 " " 5	1 " " 28
2 " " 8	1 " " 32
4 " " 10	1 " " 33
7 " " 11	5 " " 35
16 " " 12	71 " " 37
1 " " 15	1 " " 45
1 " " 15A	2 " " 52
2 " " 16	3 " " 53
4 " " 17	1 " " 54
2 " " 19	1 " " 57
4 " " 20	4 " " 59
1 " " 21	5 " " 60
1 " " 22	2 " " 63
3 " " 22A	



This is a model of a crane having a luffing action for the jib, that is raising or lowering, and a swivelling action for swinging the jib round. The whole frame 1, gearbox 2, and jib 3 swivel about the pivots 4 and 5. The lower rod 5 having a contrate wheel 6 fixed thereon engaged by a pinion 7 on the axle rod 8 which carries the worm wheel 9 driven by the worm 10 rotated by the pulley wheel 11, the pinion 7 riding on the fixed wheel 6 as on a rack. The jib is luffed from the crank handle 12, and the load raised or lowered from the handle 13.

## Model No. 409—Band Saw



Parts required:

2 of No. 3	2 of No. 22	2 of No. 53
1 " " 5	1 " " 26	4 " " 59
2 " " 8	1 " " 27A	2 " " 60
3 " " 16	4 " " 35	2 " " 108
1 " " 19	26 " " 37	
1 " " 19B	2 " " 52	



Model No. 410

# Mechanical Cross Bow

Model No. 411

# Clay Modelling Machine

The only part of this model requiring description is the release. To the inside of the angle girders is bolted a double bracket 1 through which slides the rod 2; at the other end of this rod are secured two collars between a double bracket threaded on to the rod, which slide down the channel of the girder strips when the bow is drawn back. The rod 3 of the small travelling frame 4 engages between the two set screws 5. As the frame 4 travels backwards, it is disengaged from the screws 5 by being lifted owing to the 5½" strips 6 being gradually inclined upwards to the rear.

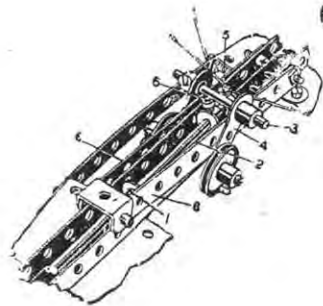
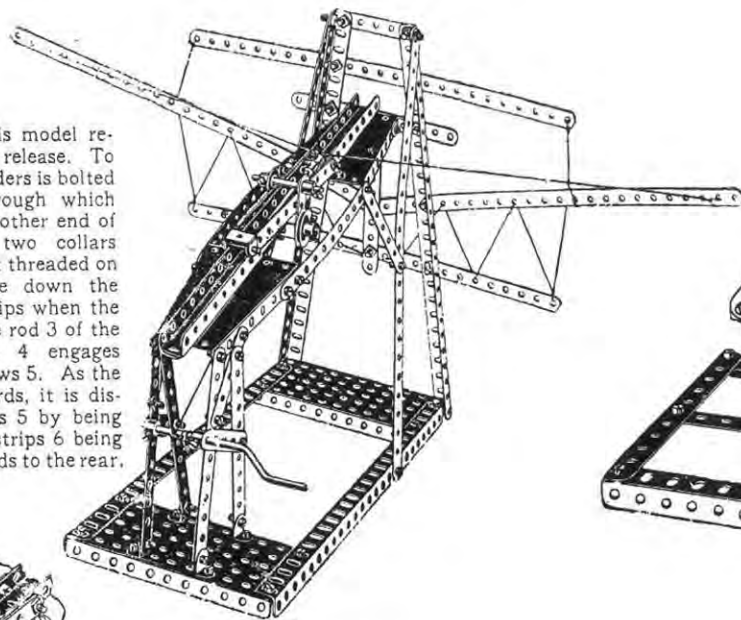
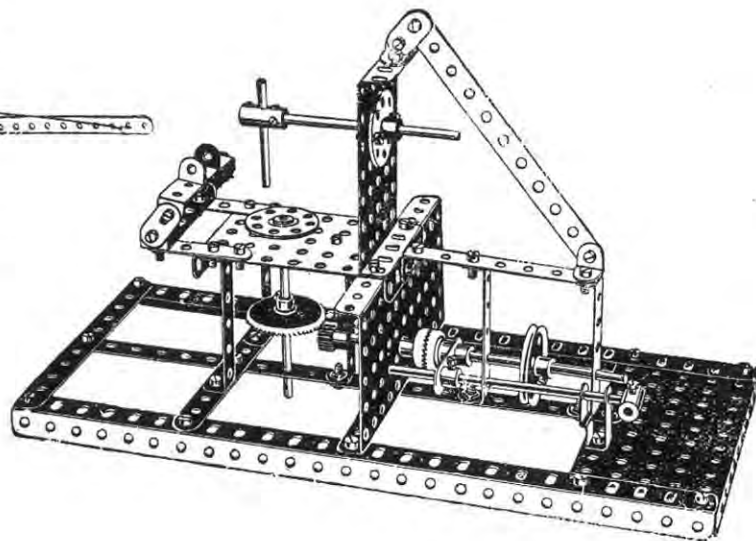


FIG. 410A

Parts required :

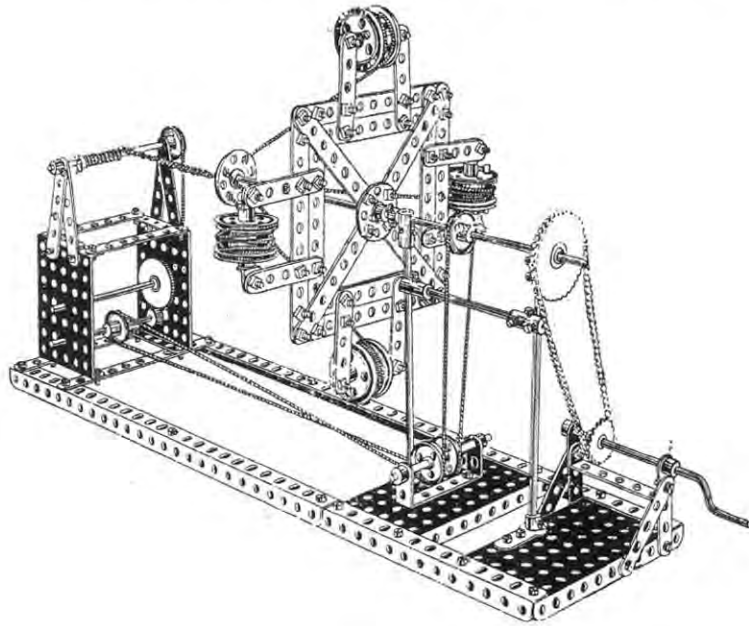
6 of No. 1	1 of No. 11	58 of No. 37
10 " " 2	5 " " 12	2 " " 52
2 " " 3	1 " " 15	2 " " 54
5 " " 5	1 " " 17	4 " " 59
4 " " 8	1 " " 19	2 " " 62
	2 " " 22	



Parts required :

4 of No. 2	1 of No. 15	2 of No. 29
1 " " 3	2 " " 16	41 " " 37
2 " " 5	1 " " 17	2 " " 52
2 " " 8	1 " " 21	2 " " 53
3 " " 10	2 " " 24	2 " " 59
1 " " 11	1 " " 26	7 " " 60
3 " " 12	1 " " 28	1 " " 62
1 " " 14		2 " " 63

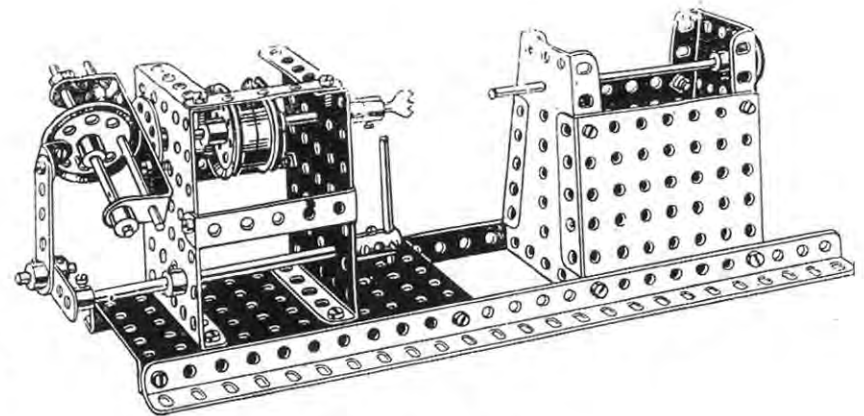
## Model No. 412—Wire Rope Maker



Parts required :

10 of No. 2	2 of No. 14	2 of No. 22A
6 " " 3	4 " " 15	1 " " 24
4 " " 4	1 " " 16	1 " " 26
12 " " 5	4 " " 17	1 " " 27A
4 " " 8	1 " " 19	80 " " 37j
8 " " 12	8 " " 20	2 " " 52
1 " " 13	4 " " 22	7 " " 59

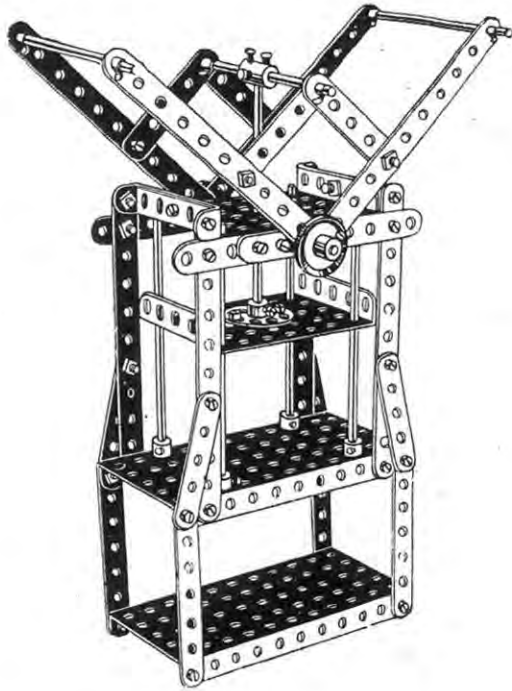
## Model No. 413—Elliptic Lathe



Parts required :

2 of No. 5	2 of No. 20	4 of No. 53
2 " " 8	1 " " 21	2 " " 54
1 " " 12	1 " " 22	8 " " 59
2 " " 15	1 " " 24	2 " " 60
1 " " 15A	2 " " 35	1 " " 62
2 " " 16	26 " " 37	2 " " 63
1 " " 17	1 " " 46	1 " " 65
1 " " 18A	1 " " 52	

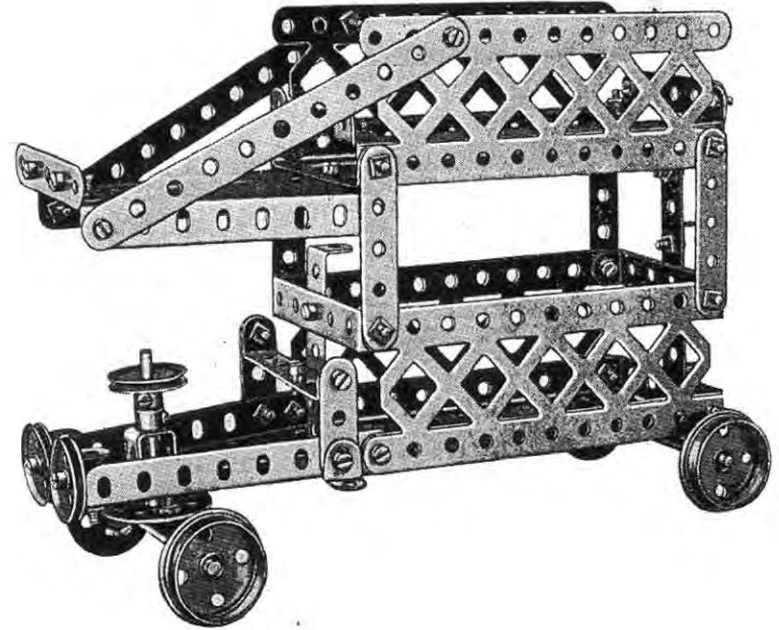
## Model No. 414—Bale Press



Parts required :

10 of No.	2
4 " "	3
8 " "	5
4 " "	15
3 " "	15A
2 " "	17
2 " "	18A
2 " "	22
1 " "	24
12 " "	35
36 " "	37
2 " "	52
2 " "	53
4 " "	59
2 " "	60
2 " "	62
1 " "	63

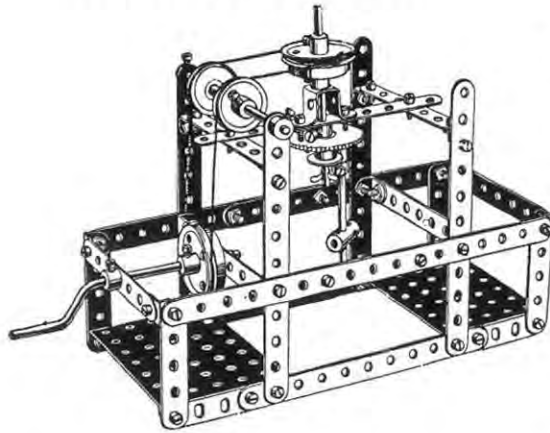
## Model No. 415—Motor Bus



Parts required :

2 of No. 2	12 of No. 12	2 of No. 22A	1 of No. 54
1 " " 3	2 " " 16	1 " " 24	1 " " 59
6 " " 5	1 " " 17	48 " " 37	7 " " 60
2 " " 6A	4 " " 20	1 " " 45	4 " " 100
3 " " 11	1 " " 22	2 " " 52	

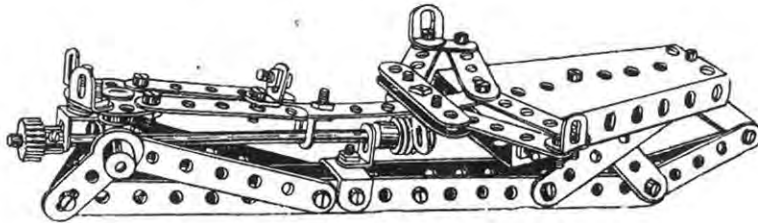
## Model No. 416 Mixing Machine



Parts  
required:

11 of No.	2
6 "	3
4 "	5
12 "	12
1 "	15A
2 "	16
1 "	19
2 "	20
2 "	22
1 "	26
1 "	27
43 "	37
1 "	45
2 "	53
3 "	59
2 "	62
2 "	63

## Model No. 418—Skate



Parts required:

5 of No.	2	1 of No.	11	1 of No.	26	1 of No.	54
4 "	3	16 "	12	1 "	32	1 "	60
12 "	5	1 "	14	42 "	37	2 "	62
5 "	10	1 "	24	5 "	38		

## Model No. 417 Distance Indicator

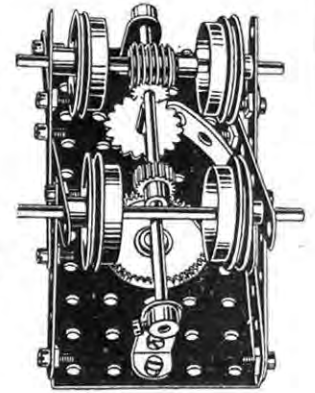
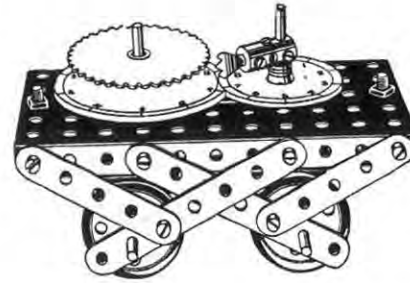


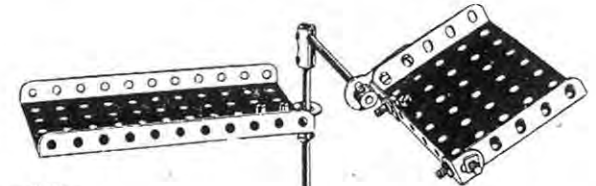
FIG. 417A

Parts required:

4 of No.	3	9 of No.	15	1 of No.	32	1 of No.	63
1 "	4	2 "	16	19 "	37	1 "	65
4 "	5	4 "	20	1 "	52	1 "	95
2 "	10	2 "	26	3 "	59	1 "	96
2 "	12	1 "	28	2 "	62		

## Model No. 419

## Bed Table



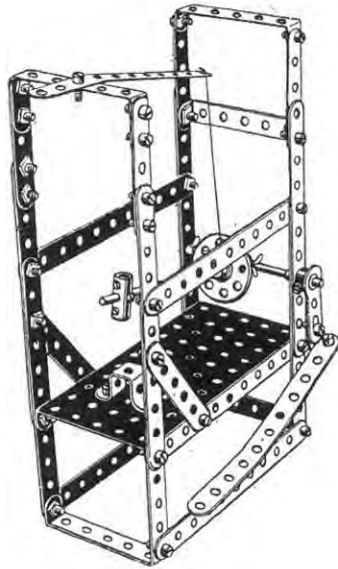
Parts required:

1 of No.	3	1 of No.	52
2 "	12	1 "	53
1 "	14	1 "	59
2 "	15A	2 "	62
1 "	16	6 "	63
8 "	37		

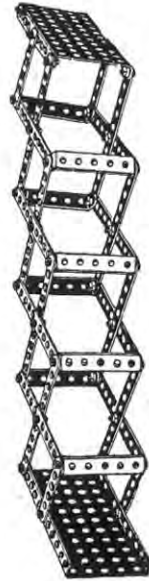


Model No. 420

# Treadle Hammer



- Parts required :
- 14 of No. 2
  - 2 " " 4
  - 4 " " 5
  - 1 " " 15
  - 1 " " 16
  - 1 " " 24
  - 4 " " 35
  - 29 " " 37
  - 1 " " 45
  - 1 " " 52
  - 5 " " 60
  - 1 " " 62
  - 2 " " 63



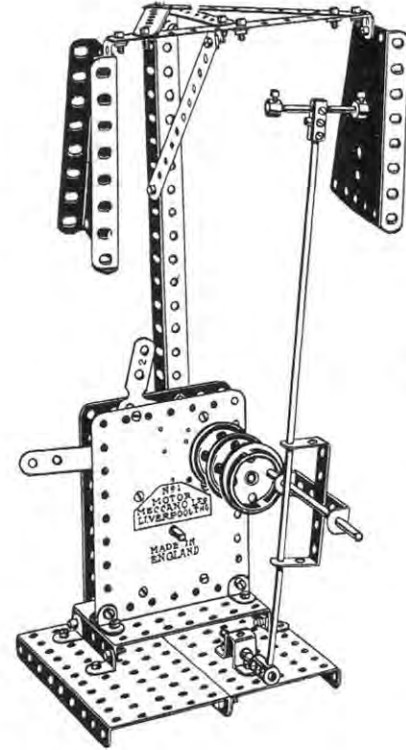
Model No. 421  
Periscope

- Parts required :
- 16 of No. 2
  - 4 " " 4
  - 32 " " 37
  - 2 " " 52
  - 8 " " 60

Small pieces of looking glass should be inserted in the top and bottom plates.

Model No. 422

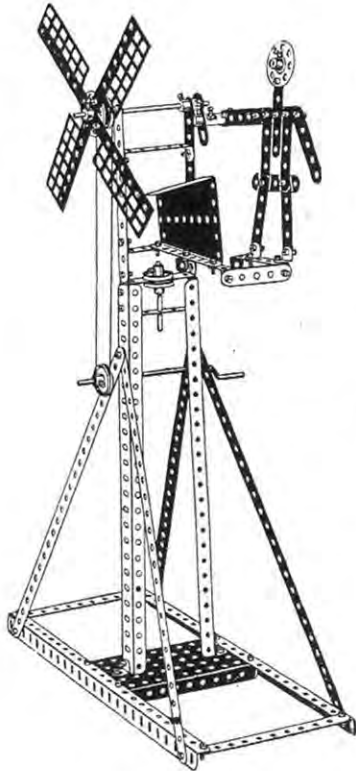
# Automatic Gong



- Parts required :
- 5 of No. 2
  - 1 " " 8
  - 11 " " 12
  - 1 " " 13
  - 1 " " 15
  - 1 " " 16
  - 2 " " 17
  - 3 " " 20
  - 2 " " 35
  - 29 " " 37
  - 1 " " 45
  - 1 " " 46
  - 2 " " 52
  - 2 " " 54
  - 3 " " 59
  - 1 " " 60
  - 2 " " 63
- Clockwork Motor

Model No. 423

## Windmill Scare

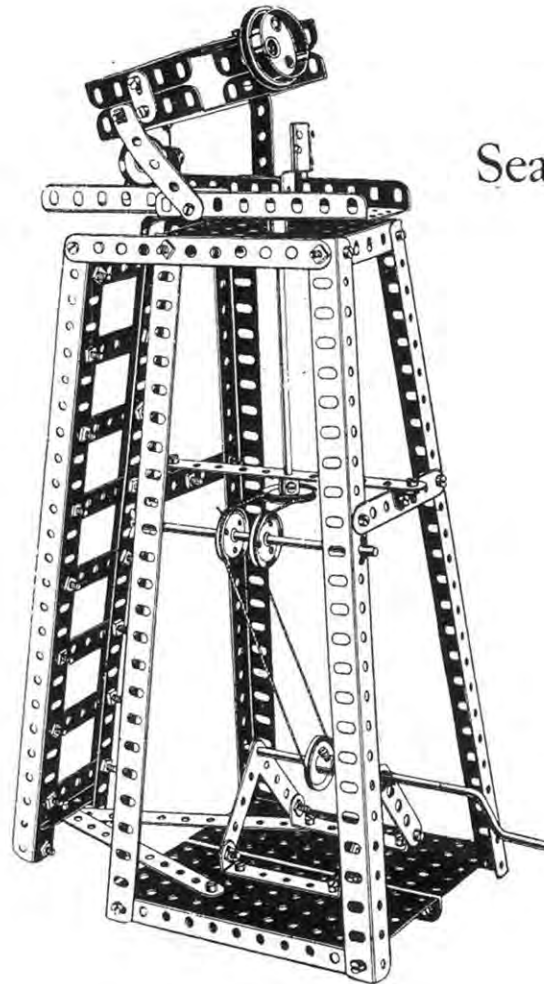


Parts  
required :

4 of No. 1
4 " " 2
10 " " 5
4 " " 8
4 " " 12
1 " " 15A
2 " " 17
1 " " 19
4 " " 22
2 " " 24
49 " " 37
1 " " 52
1 " " 54
4 " " 59
6 " " 60
4 " " 61
1 " " 62
1 " " 63

Model No. 424

## Search-light Tower



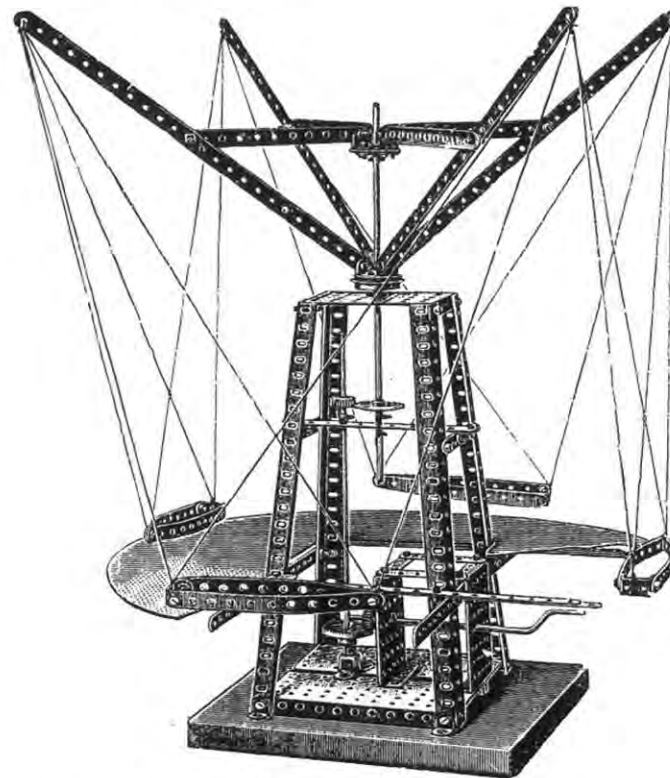
Parts  
required :

5 of No. 2
2 " " 3
5 " " 5
6 " " 8
2 " " 10
1 " " 11
4 " " 12
1 " " 14
1 " " 15
1 " " 18A
1 " " 19
1 " " 20
3 " " 22
2 " " 22A
1 " " 24
4 " " 35
64 " " 37
1 " " 44
2 " " 52
2 " " 53
2 " " 54
1 " " 59
2 " " 60
1 " " 63

## Model No. 425—Flying Machine

Most boys will have seen the Maxim Flying Machine at work, and will be interested in constructing a working model.

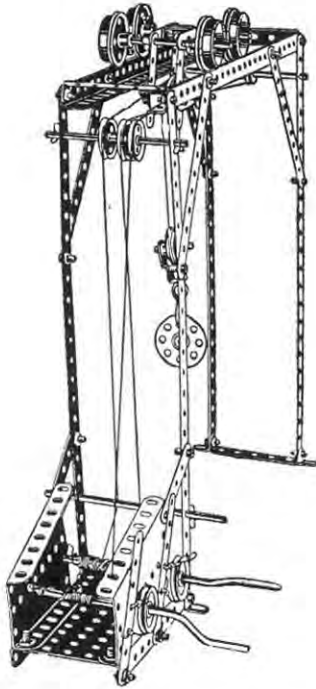
The main frame is composed of four angle girders connected at the bottom by two large flanged plates separated one hole apart and connected together by two small flanged plates carrying the crank handle, and at the top by a small flanged plate. Across the centre on opposite sides in the ninth hole down is attached a  $3\frac{1}{2}$ " strip connected together by a  $5\frac{1}{2}$ " strip. These transverse  $3\frac{1}{2}$ " and  $5\frac{1}{2}$ " strips and the small flanged plate at the top carry the perpendicular spindle upon which the upper structure revolves. A bush wheel is secured to this spindle to support the four arms, which are attached by four angle brackets. A pulley wheel is placed between this bush wheel and the perforated plate. The arms are supported by means of  $5\frac{1}{2}$ " strips connected to a bush wheel secured on to the spindle, and the boats are connected to these by cord arranged as shown in the illustration. The platform is supported by four  $12\frac{1}{2}$ " strips attached to the sides of the main framework. The manner of constructing the mechanism for operating the model is clearly shown in the illustration.



### Parts required:

8 of No. 1	18 of No. 12	1 of No. 28
13 " " 2	2 " " 13	74 " " 37
2 " " 3	1 " " 19	1 " " 45
2 " " 5	2 " " 24	2 " " 52
4 " " 8	2 " " 26	3 " " 53
4 " " 11	1 " " 27	4 " " 59

## Model No. 426 Crane

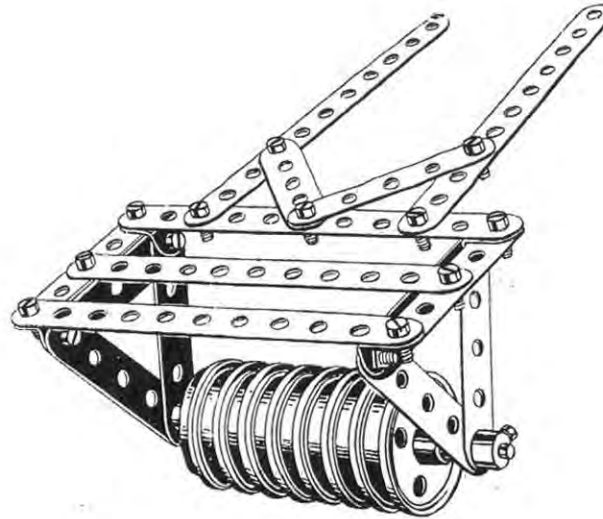


Parts required :

4 of No. 1	1 of No. 16	1 of No. 23
6 " " 2	1 " " 17	1 " " 24
2 " " 3	1 " " 18A	12 " " 35
10 " " 5	2 " " 19	32 " " 37
2 " " 8	4 " " 20	1 " " 44
3 " " 11	1 " " 21	1 " " 52
4 " " 12	4 " " 22	2 " " 54
1 " " 15	2 " " 22A	1 " " 57
3 " " 15A		3 " " 60

## Model No. 427

### Field Roller

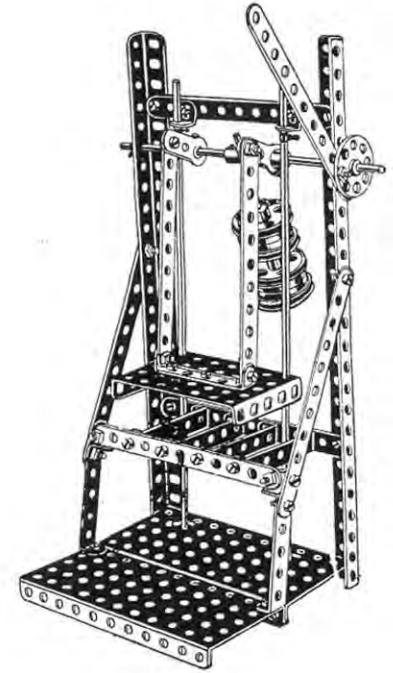


Parts required :

5 of No. 2	8 of No. 20
10 " " 5	15 " " 37
4 " " 12	4 " " 59
1 " " 15	

## Model No. 428

### Potato Chopper

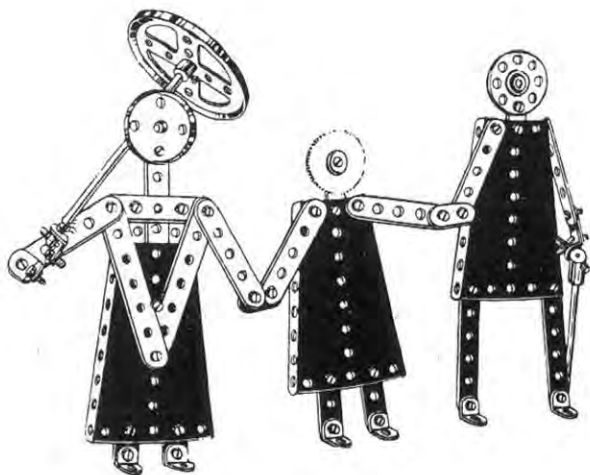


Parts required :

8 of No. 2	2 of No. 16	38 of No. 37
2 " " 8	4 " " 20	2 " " 52
4 " " 12	1 " " 24	1 " " 53
2 " " 13	5 " " 35	6 " " 60
1 " " 15A		1 " " 63



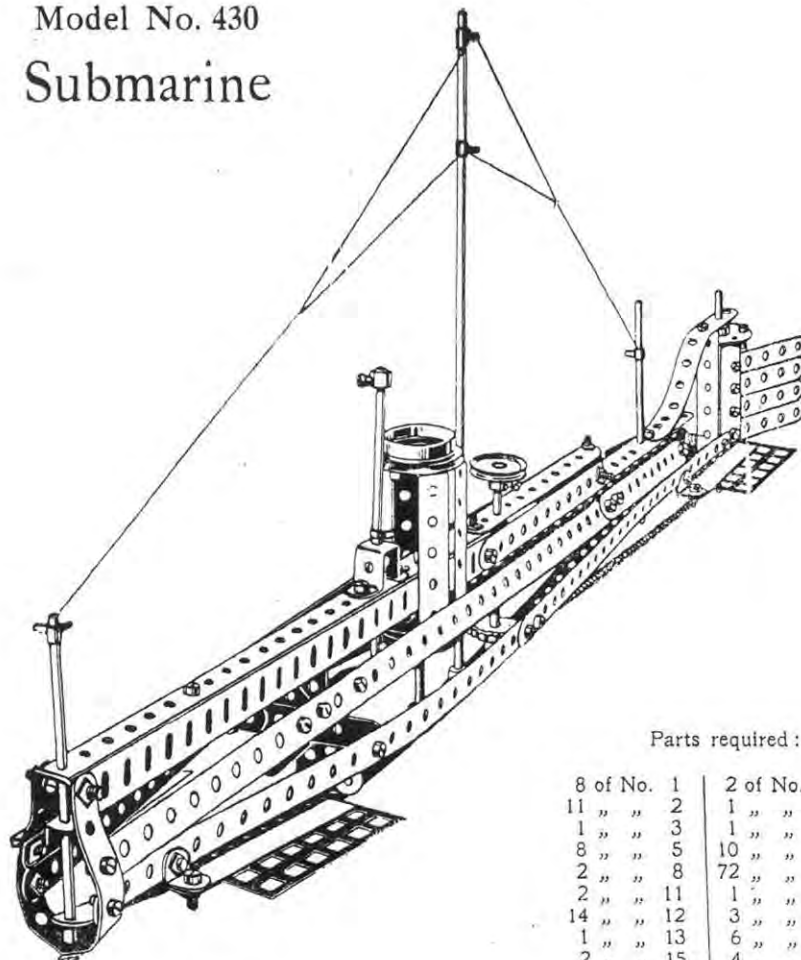
## Model No. 429 The Meccano Family



Parts required :

1 of No. 2	1 of No. 15	1 of No. 24
2 " " 3	1 " " 15A	1 " " 27A
2 " " 4	1 " " 18A	3 " " 35
12 " " 5	1 " " 19B	36 " " 37
7 " " 10	1 " " 21	3 " " 54
9 " " 12		1 " " 63

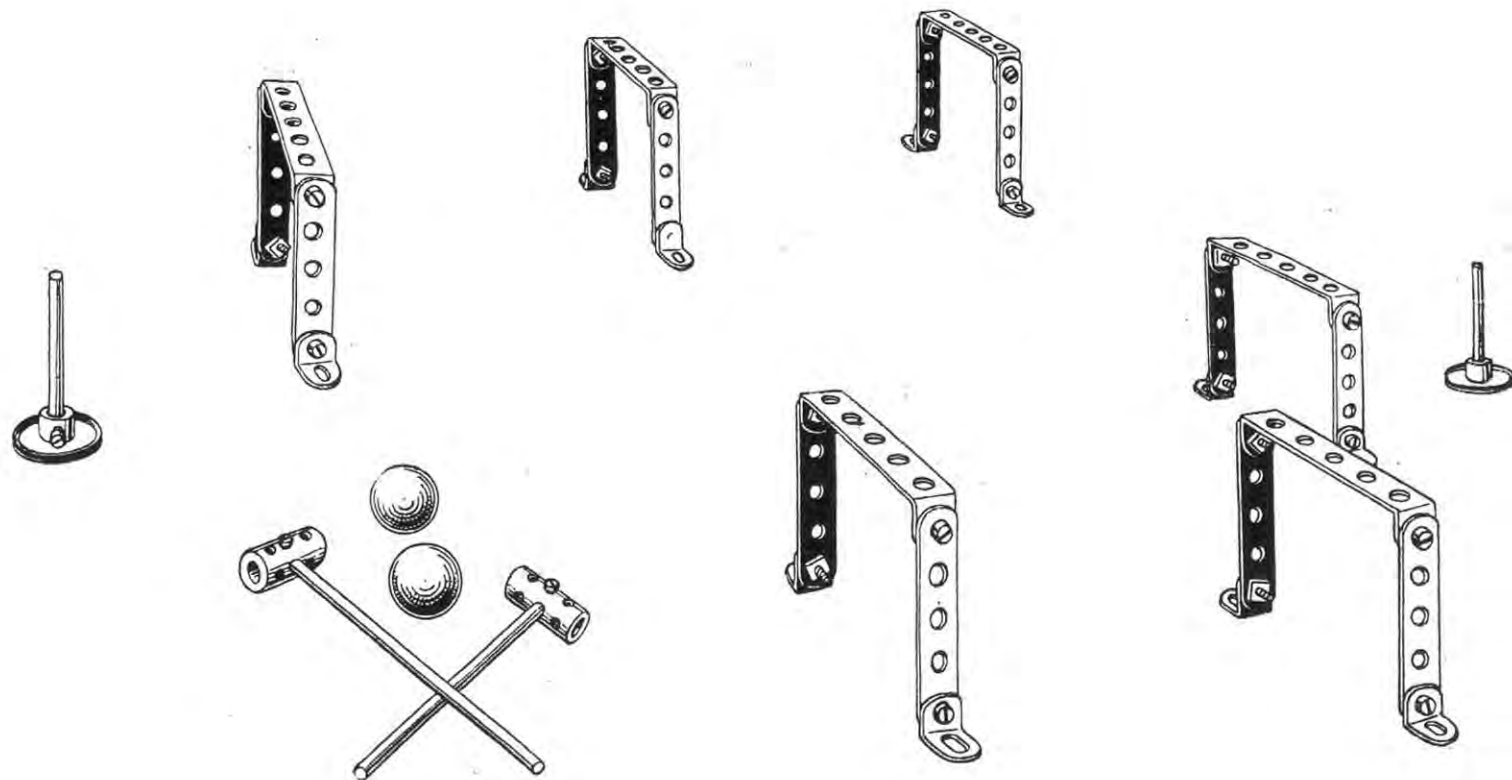
## Model No. 430 Submarine



Parts required :

8 of No. 1	2 of No. 20
11 " " 2	1 " " 22
1 " " 3	1 " " 24
8 " " 5	10 " " 35
2 " " 8	72 " " 37
2 " " 11	1 " " 45
14 " " 12	3 " " 59
1 " " 13	6 " " 60
2 " " 15	4 " " 61
3 " " 15A	2 " " 94
1 " " 16	2 " " 96

This Model can be made with MECCANO Outfit No. 4, or No. 3 and No. 3A



## Model No. 431—Table Croquet

Parts required:

12 of No. 5	2 of No. 22
12 " 12	24 " " 37
2 " 16	2 " " 63
2 " 17	

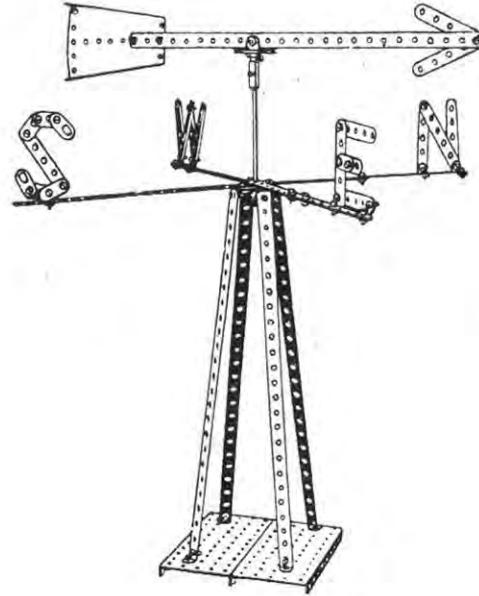
A most diverting game. Coloured marbles may be used for the balls.  
Full instructions for playing croquet may be obtained from any sports or games dealer.

### Model No. 432 Street Lamp



Parts required :

4 of No. 5	1 of No. 20
2 " " 11	1 " " 24
4 " " 12	12 " " 37
1 " " 13	1 " " 59
2 " " 16	1 " " 63

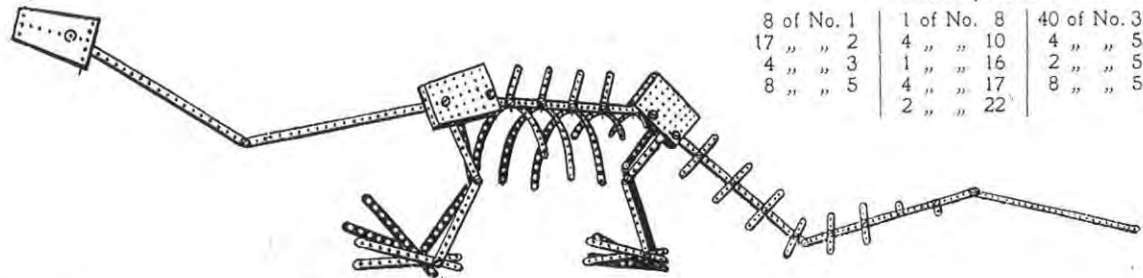


### Model No. 433 Weather Vane

Parts required :

7 of No. 1	1 of No. 14	1 of No. 54
11 " " 5	1 " " 24	2 " " 59
8 " " 10	54 " " 37	1 " " 109
4 " " 11	2 " " 38	1 " " 126
17 " " 12	2 " " 52	

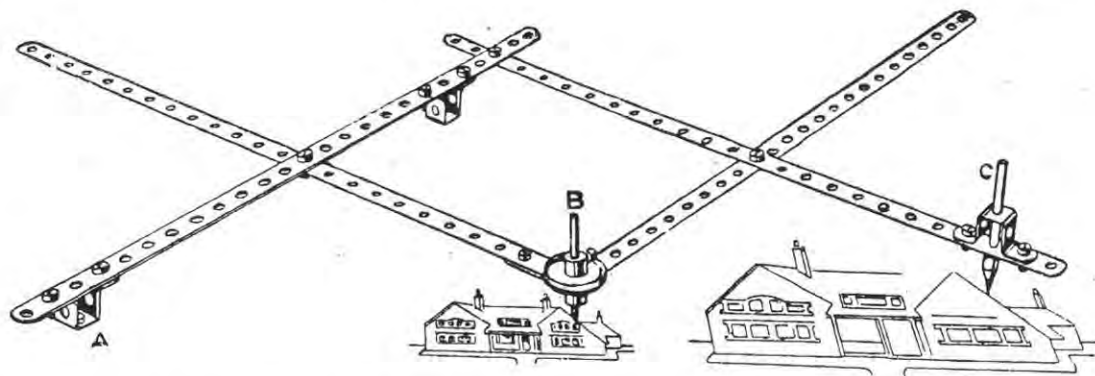
### Model No. 434 Diplodocus



Parts required :

8 of No. 1	1 of No. 8	40 of No. 37
17 " " 2	4 " " 10	4 " " 53
4 " " 3	1 " " 16	2 " " 54
8 " " 5	4 " " 17	8 " " 59
	2 " " 22	

This is a most extraordinary effort sent in by a young French boy to compete for one of the big prizes in our Meccano Contest. We could scarcely class it as an engineering model, but any boy with a brain clever enough and an imagination lively enough to conceive and construct such an animal as this from Meccano parts deserved a good prize, so we awarded him one. Screw the nuts and bolts up tightly because he looks most dejected when he droops.



## Model No. 435 Pantograph

Parts required :

4 of No. 1	10 of No. 37
1 " " 17	3 " " 45
1 " " 22	1 " " 62

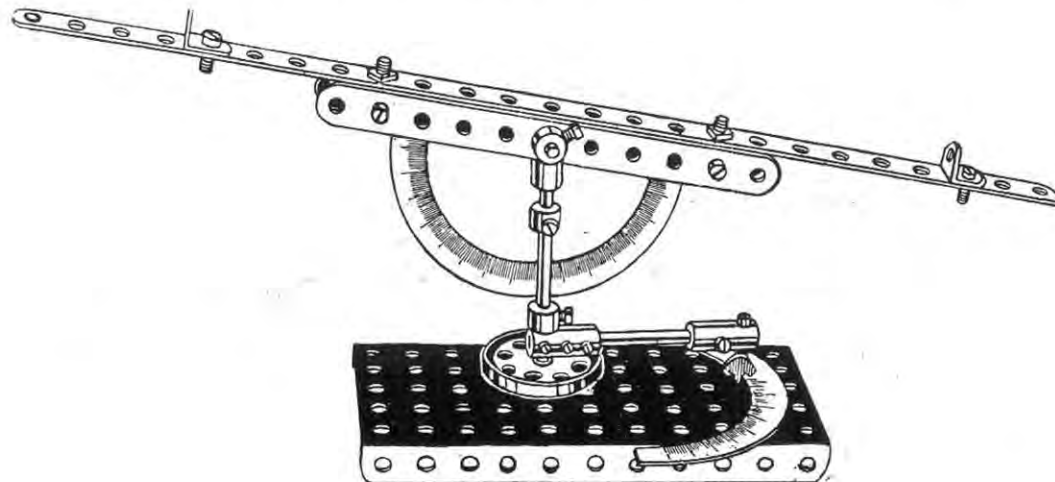
Most boys have heard of the Pantograph but not many have had an opportunity of seeing its principles demonstrated. It is an instrument for copying plans, etc., on the same or on a reduced or enlarged scale.

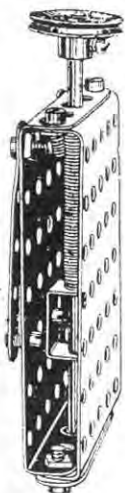
The apparatus is fixed at the point A. If an enlarged sketch is to be made, the point B is traced round the outlines, the writing point C reproducing the sketch on a larger scale. When a reduced drawing is to be made, the point C traces the outline, whilst the point B reproduces the sketch on a smaller scale. The degree of enlargement or reduction varies according to the position in which point C is fixed on the perforated arm.

## Model No. 436 Sextant and Theodolite

Parts required :

1 of No. 1	1 of No. 17	8 of No. 37
2 " " 2	2 " " 18A	1 " " 52
2 " " 11	1 " " 21	4 " " 59
2 " " 12	1 " " 22	3 " " 63
1 " " 16		1 " " 65





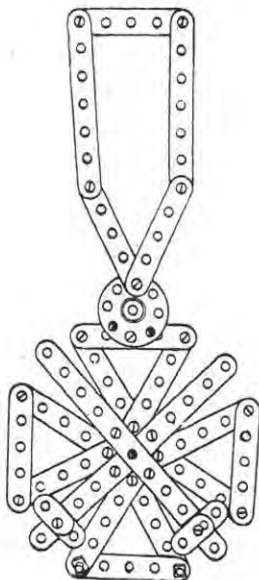
Model No. 437  
**Conductor's  
 Punch**

Parts  
 required :  
 3 of No. 5  
 1 " " 11  
 1 " " 15A  
 1 " " 22  
 9 " " 37  
 1 " " 43  
 2 " " 53

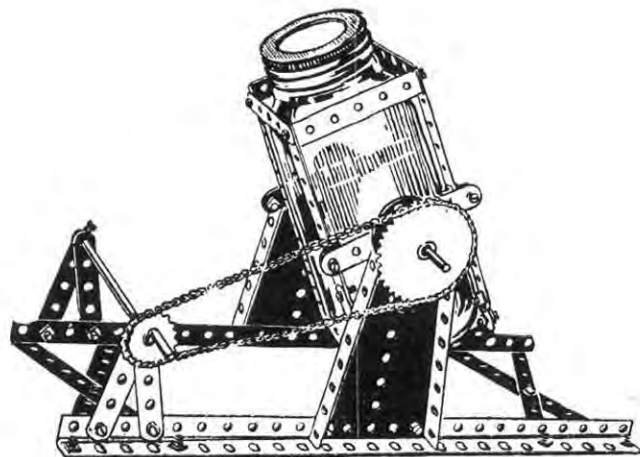
This is just the thing for your younger brother and he only needs a strap to hang it over his shoulder with to make him into a tram conductor. Note the 2½" strip at the bottom, spaced a little away from the body of the punch, to allow the ticket to pass in to be punched.

Model No. 439  
**Croix  
 de  
 Guerre**

Parts  
 required :  
 2 of No. 2  
 2 " " 3  
 15 " " 5  
 4 " " 10  
 2 " " 24  
 24 " " 37



Model No. 438—**Butter Churn**

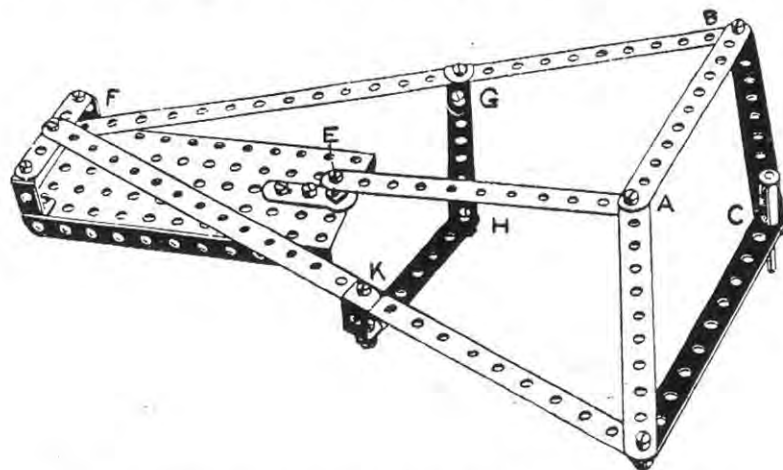


Parts required :

8 of No. 2	4 of No. 12	2 of No. 24	4 of No. 60
2 " " 3	1 " " 17	50 " " 37	2 " " 62
2 " " 4	1 " " 18A	2 " " 54	18" " " 94
10 " " 5	1 " " 19	2 " " 59	1 " " 95
2 " " 8			1 " " 96

## Model No. 440

## Apparatus for Transforming a Circular Movement into a Rectilinear Movement



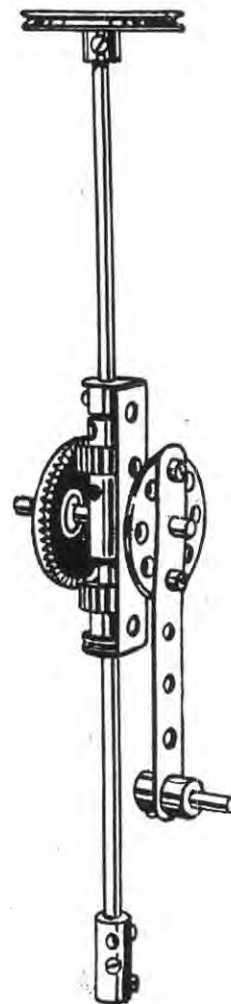
This most ingenious model was designed by M. Pierre-Th. Dufour, who used it in his Thesis (presented to the Faculty of Science in Paris) to obtain his title of Doctor of the University of Paris. He required an instrument which would transform a circular movement into a movement rigorously rectilinear and he states in his published work that he was able to do this "with the aid of Meccano parts which permit of making experiments so easily in mechanisms of the most varied types."

The point F is fixed, and is situated at a distance from the fixed point E, equal to AE, the two arms FB and FD being together equal to the four sides of the lozenge ABCD. The trajectory of the point C is then at right angles to EF. It will be found that whilst the point C is moving in a straight line at right angles to EF, the point A is describing a circle round the fixed point E.

Every Meccano boy should make up this very interesting model and experiment with it.

Parts  
required :

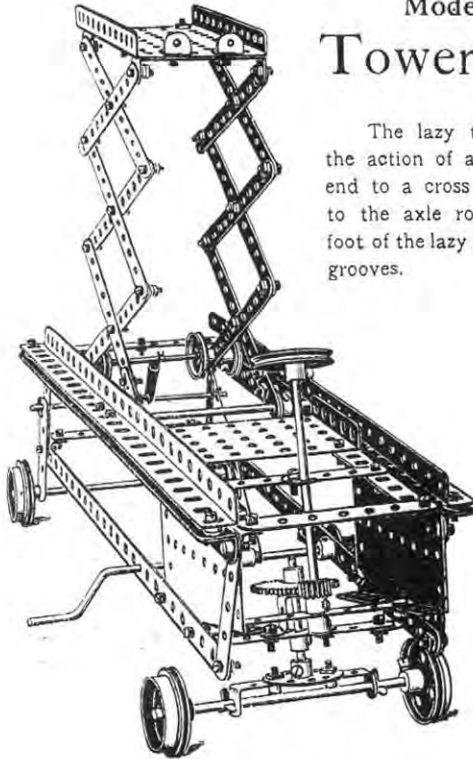
2 of No.	1
5 "	2
2 "	3
1 "	5
4 "	11
1 "	17
16 "	37
1 "	52
7 "	59
1 "	62
1 "	63

Model No. 441  
Breast  
DrillParts  
required :

1 of No.	3
2 "	15
1 "	17
1 "	18A
1 "	21
1 "	23
1 "	24
2 "	26
1 "	28
2 "	37
3 "	59
1 "	60
2 "	63

## Model No. 442 Tower Wagon

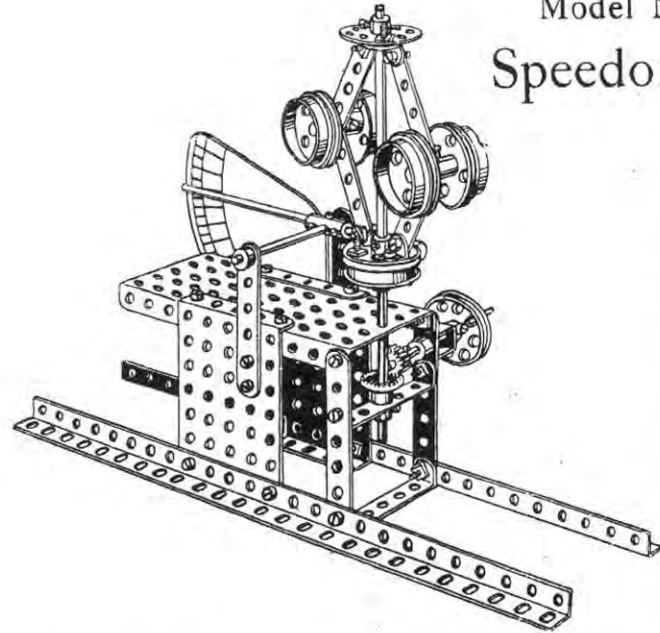
The lazy tongs are collapsed by the action of a spring 1 fixed at one end to a cross rod, and at the other to the axle rod passing through the foot of the lazy tongs which slide in the grooves.



Parts required :

16 of No. 2	1 of No. 21	78 of No. 37	6 of No. 60B
2 " " 4	3 " " 22	18 " " 38	2 " " 62
4 " " 5	1 " " 22A	1 " " 45	2 " " 77
2 " " 8	1 " " 24	1 " " 52	2 " " 99A
5 " " 15A	2 " " 26	2 " " 53	2 " " 108
1 " " 16	1 " " 27	2 " " 54	1 " " 115
2 " " 17	1 " " 32	3 " " 59	2 " " 124
4 " " 20	2 " " 35	2 " " 60	4 " " 126

## Model No. 443 Speedometer



Parts required :

2 of No. 3	4
2 " " 4	5
4 " " 5	8
2 " " 8	12
4 " " 12	13A
1 " " 13A	16
3 " " 16	18A
2 " " 18A	20
5 " " 20	21
1 " " 21	24
2 " " 24	26
1 " " 26	29
1 " " 29	37
32 " " 37	38
2 " " 38	45
1 " " 45	52
1 " " 52	53
2 " " 53	59
5 " " 59	60
3 " " 60	63
1 " " 63	

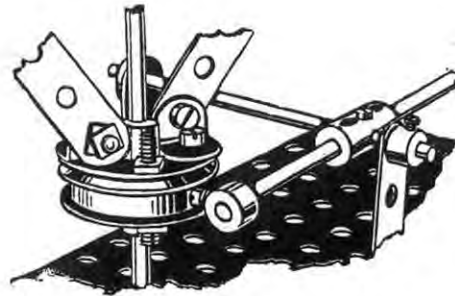
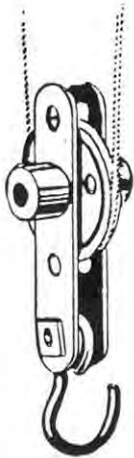


FIG. 443A

# Pulley Blocks

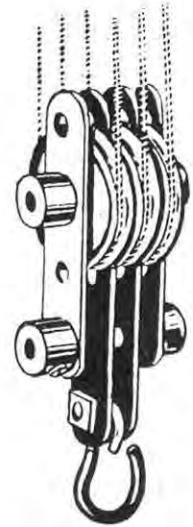
Model  
No. 444



Model  
No. 445

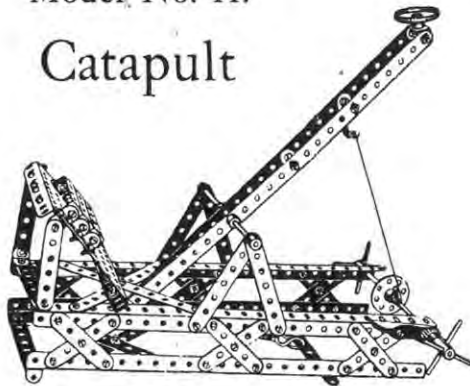


Model  
No. 446



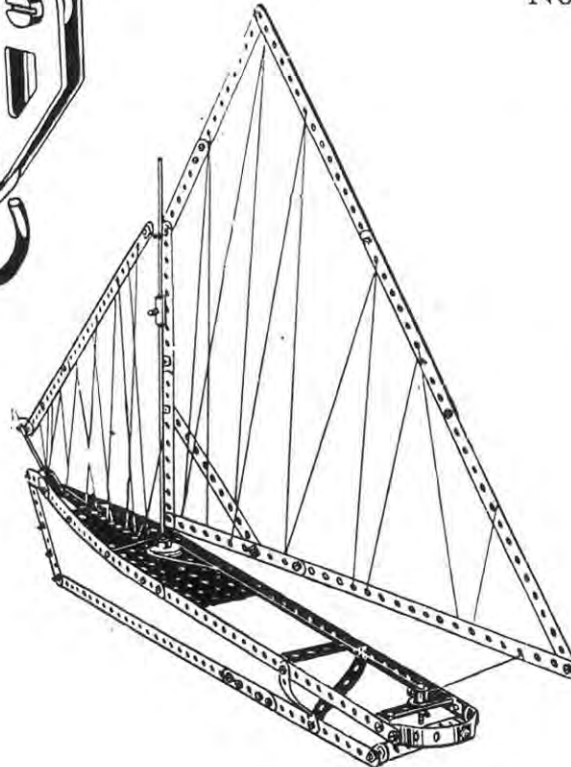
Model No. 447

## Catapult



Parts required :

2	of No.	1
5	" "	2
6	" "	3
4	" "	4
12	" "	5
4	" "	8
2	" "	11
12	" "	12
1	" "	14
1	" "	15
4	" "	17
1	" "	24
1	" "	26
1	" "	28
1	" "	33
84	" "	37
1	" "	43
2	" "	53
4	" "	59
2	" "	63



Model No. 448

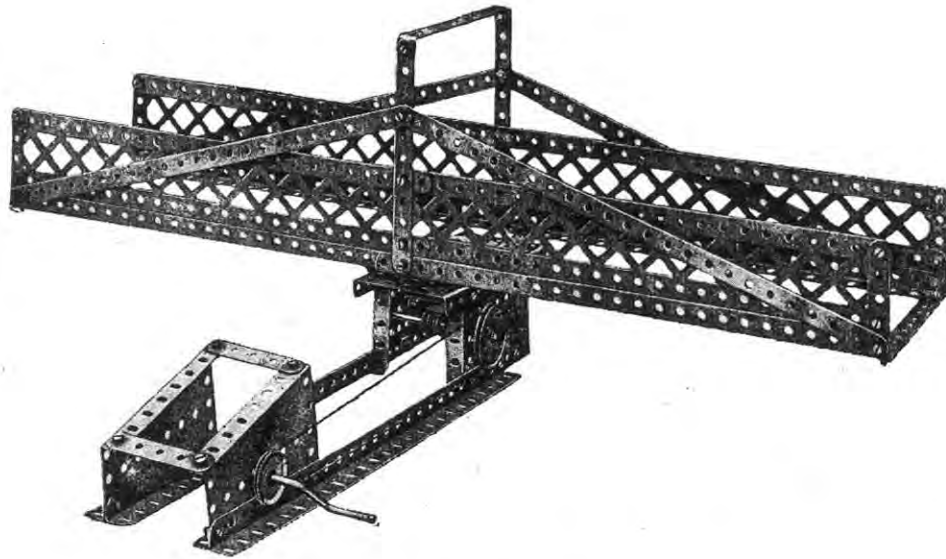
## Yacht

Parts required :

9	of No.	1	2	of No.	18A
7	" "	2	1	" "	22
4	" "	3	51	" "	37
2	" "	4	1	" "	44
2	" "	5	1	" "	52
1	" "	10	1	" "	54
5	" "	12	2	" "	60
1	" "	13A	1	" "	63
2	" "	15			



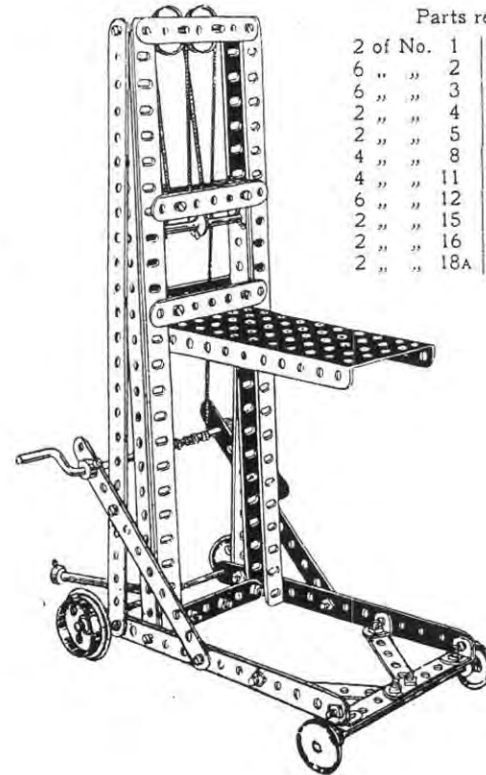
## Model No. 449 Swing Bridge



Parts required:

8 of No. 1	1 of No. 17	1 of No. 27A	2 of No. 54
6 " " 2	1 " " 19	1 " " 32	2 " " 59
6 " " 5	1 " " 19B	50 " " 37	1 " " 60
6 " " 8	1 " " 21	1 " " 52	1 " " 60c
1 " " 16	1 " " 22	2 " " 53	4 " " 99

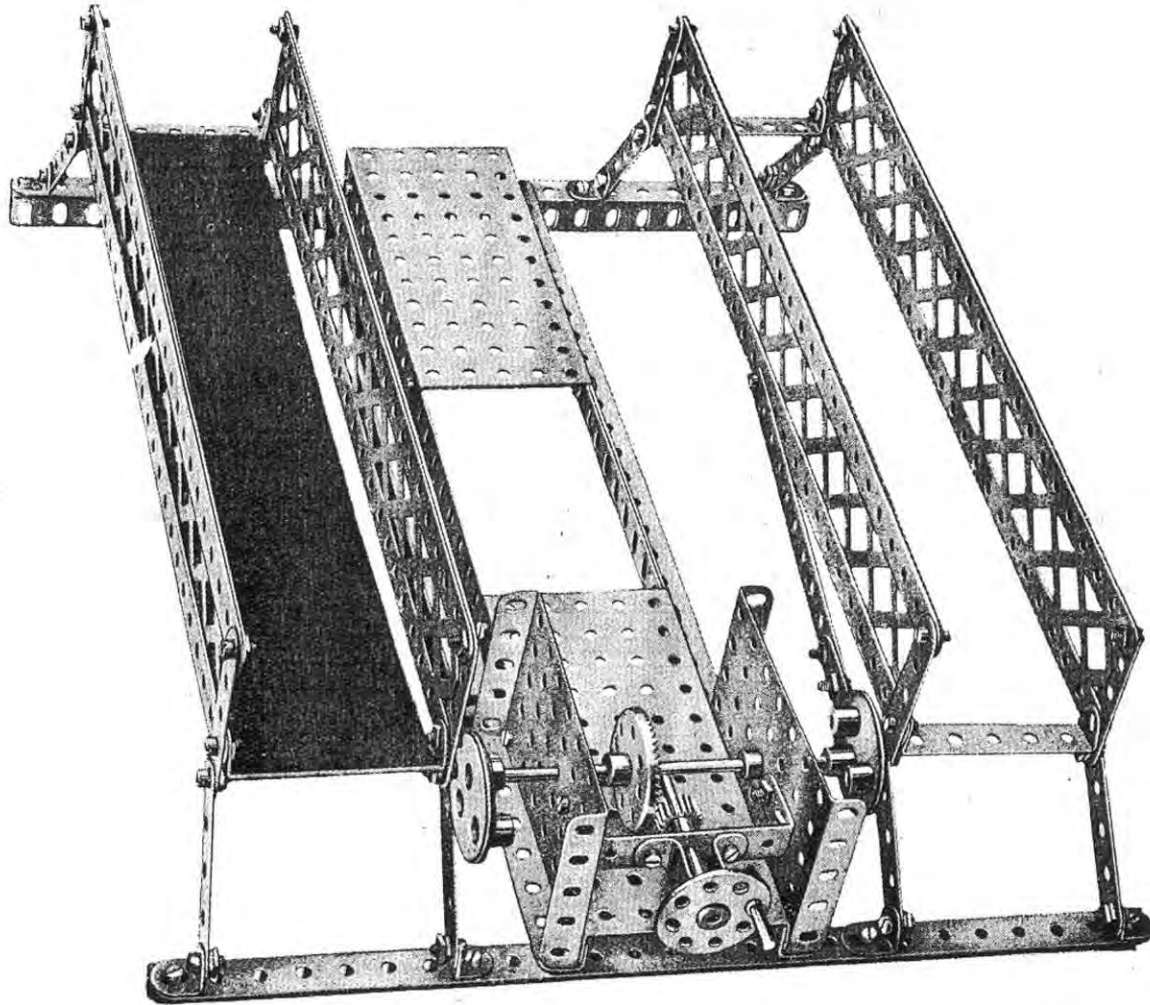
## Model No. 450 Bale Lifter



Parts required:

2 of No. 1	1 of No. 19
6 " " 2	2 " " 20
6 " " 3	4 " " 22
2 " " 4	1 " " 23
2 " " 5	1 " " 26
4 " " 8	1 " " 33
4 " " 11	6 " " 35
6 " " 12	40 " " 37
2 " " 15	1 " " 52
2 " " 16	2 " " 59
2 " " 18A	1 " " 63

## Model No. 451 Cake Walk

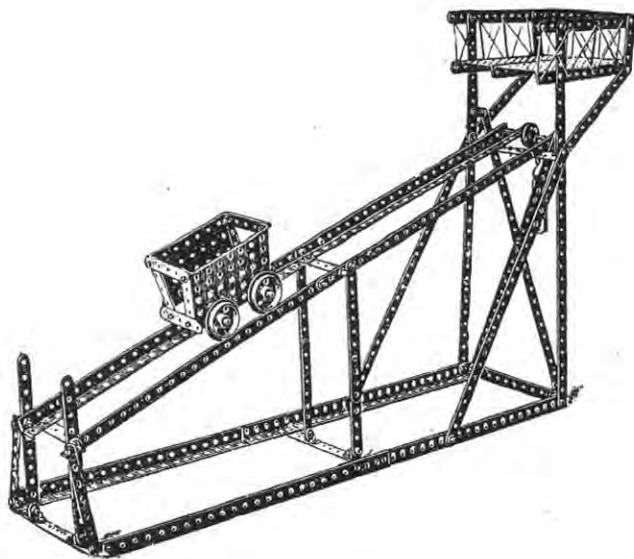


### Parts required :

8 of No.	1
2 " "	2
16 " "	5
6 " "	8
8 " "	12
1 " "	15
1 " "	10
1 " "	24
1 " "	26
1 " "	28
66 " "	37
1 " "	38
1 " "	45
1 " "	46
2 " "	52
2 " "	53
2 " "	59
4 " "	60
1 " "	77
4 " "	99
2 " "	130

Model No. 452

## Inclined Delivery Chute



Parts required :

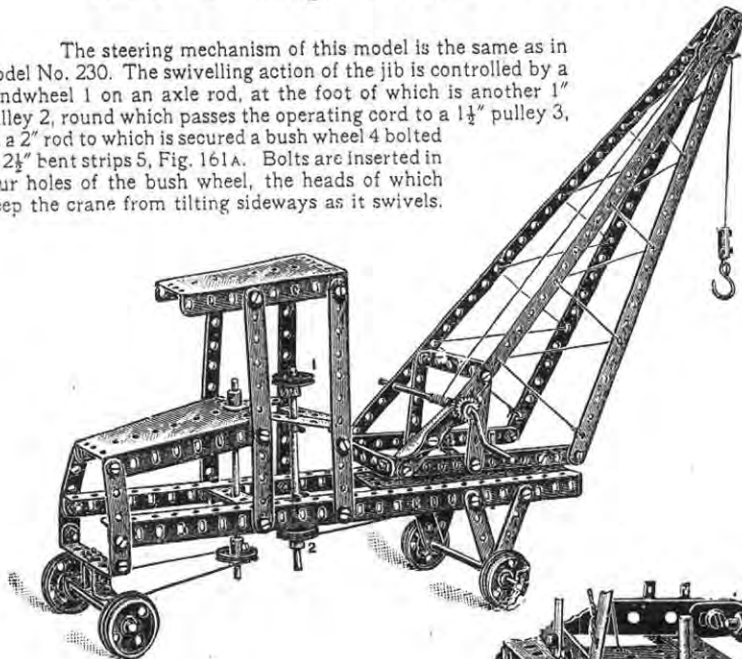
6 of No. 1	8 of No. 8	2 of No. 35
16 " " 2	16 " " 12	70 " " 37
4 " " 3	3 " " 15	2 " " 52
2 " " 4	4 " " 20	2 " " 53
8 " " 5	1 " " 22A	1 " " 57

This model furnishes an illustration of the inclined plane. The loading platform at the extreme right delivers a load into the truck, which now being heavier than the balance weight, runs down the incline, and when at the bottom discharges its load by tipping. The weight immediately re-asserting itself, the empty truck returns quickly to the loading platform.

Model No. 453

## Travelling Swivel Crane

The steering mechanism of this model is the same as in Model No. 230. The swivelling action of the jib is controlled by a handwheel 1 on an axle rod, at the foot of which is another 1" pulley 2, round which passes the operating cord to a 1½" pulley 3, on a 2" rod to which is secured a bush wheel 4 bolted to 2½" bent strips 5, Fig. 161A. Bolts are inserted in four holes of the bush wheel, the heads of which keep the crane from tilting sideways as it swivels.



Parts required :

4 of No. 1	2 of No. 17	6 of No. 35
6 " " 2	1 " " 19	51 " " 37
2 " " 3	4 " " 20	1 " " 45
11 " " 5	1 " " 21	1 " " 52
2 " " 8	3 " " 22	2 " " 54
1 " " 11	1 " " 22A	1 " " 57
2 " " 12	1 " " 24	6 " " 60
3 " " 15	1 " " 26	1 " " 62
1 " " 16	1 " " 33	1 " " 63

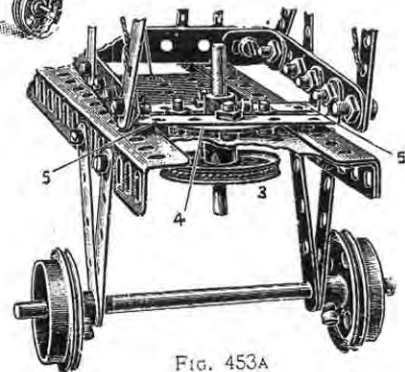
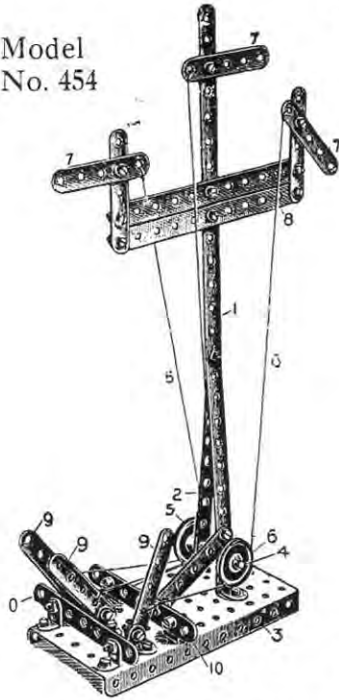


Fig. 453A

Model  
No. 454

## Three-arm Signal

Parts  
required :

1 of No.	1
3 " "	2
2 " "	3
9 " "	5
10 " "	12
1 " "	17
2 " "	22
37 " "	37
1 " "	52

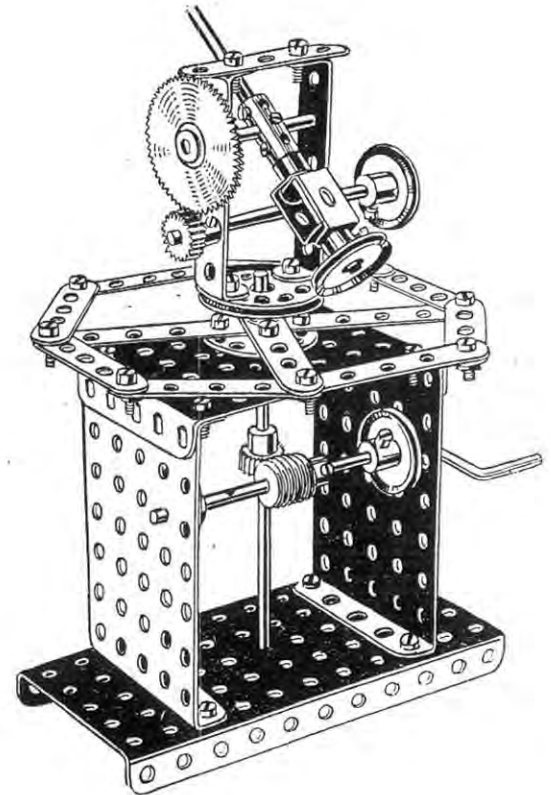
A flanged plate forms the base of this model, a 12½" strip 1 being bolted to a 5½" strip 2, the feet of

both these strips being connected to the flanged plate 3 by angle brackets. A rod 4 is passed through the lower holes of the strips 1 and 2 and is fitted with guide pulleys 5 leading the actuating cords 6 to the signal arms 7. The cord operating the central arm is run under the rod 4. The signal arms 7 are carried from transverse strips 8. The operating cords 6 are led to three strips 9, pivoted to angle brackets bolted to the flanged plate, and transverse strips 10 are bolted to the perforated plate in the front and rear of the pivoted strips 9 to limit their movement.

## Model No. 455 Anti-Aircraft Gun

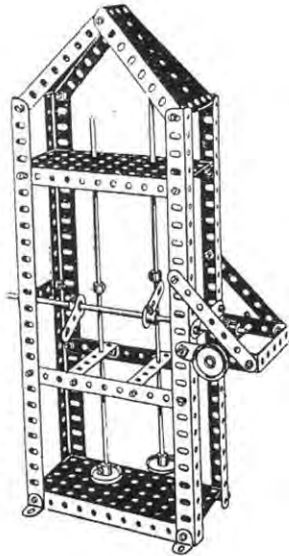
Parts  
required :

2 of No.	2
9 " "	5
2 " "	11
2 " "	15
1 " "	16
1 " "	17
1 " "	19
1 " "	21
4 " "	22
1 " "	24
2 " "	26
1 " "	27 <sup>A</sup>
1 " "	32
26 " "	37
1 " "	52
3 " "	53
4 " "	59
2 " "	60
1 " "	63



Model No. 456

# Trip-Hammer

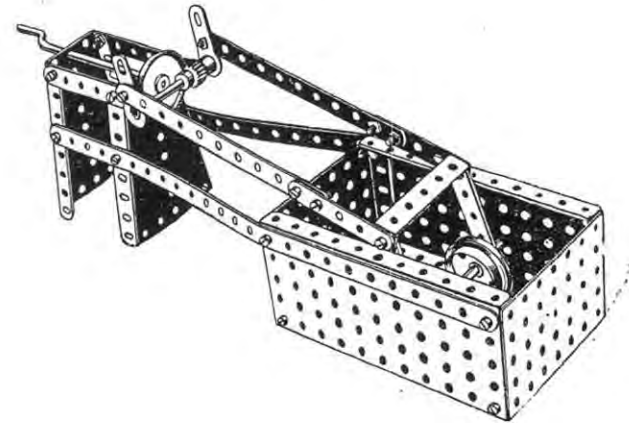


Parts required:

2 of No. 2	3 of No. 22
2 " " 3	1 " " 26
4 " " 5	1 " " 32
4 " " 8	32 " " 37
4 " " 12	2 " " 52
2 " " 13	2 " " 54
1 " " 14	4 " " 59
1 " " 16	3 " " 60
1 " " 17	2 " " 62
	1 " " 63

Model No. 457

# Chocolate Mixer



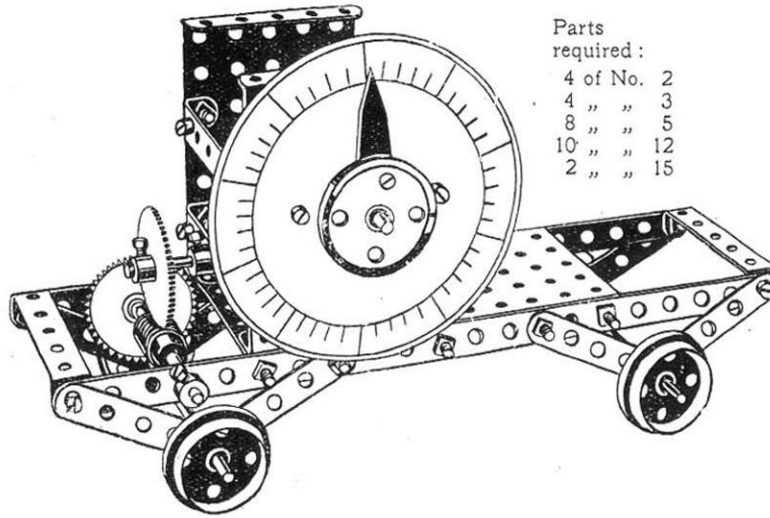
Parts required:

2 of No. 1	1 of No. 16	1 of No. 26	2 of No. 53
2 " " 2	1 " " 17	1 " " 28	2 " " 54
2 " " 3	1 " " 19	24 " " 37	1 " " 60
4 " " 5	2 " " 20	2 " " 52	2 " " 62

## HOW TO CONTINUE

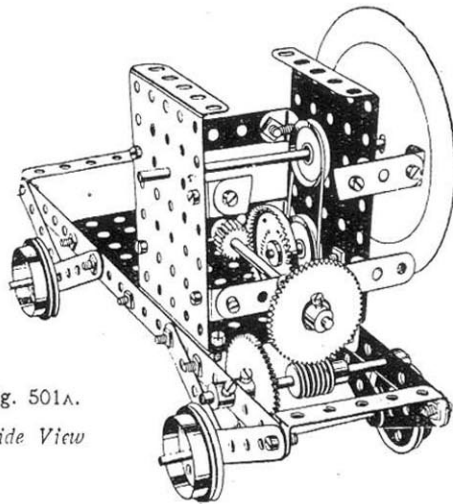
This completes the Models which may be made with MECCANO Outfit No. 4. The next Models are a little more advanced, requiring a number of extra parts to construct them. The necessary parts are all contained in a No. 4A Accessory Outfit, the price of which will be found in the List at the end of the Manual.

## Model No. 501—Distance Indicator



Parts  
required :

4 of No.	2
4 " "	3
8 " "	5
10 " "	12
2 " "	15



2 " "	15A
1 " "	16
1 " "	17
4 " "	20
1 " "	21
2 " "	22
1 " "	24
2 " "	26
2 " "	27A
1 " "	28
1 " "	32
38 " "	37
1 " "	52
2 " "	53
6 " "	59
2 " "	60

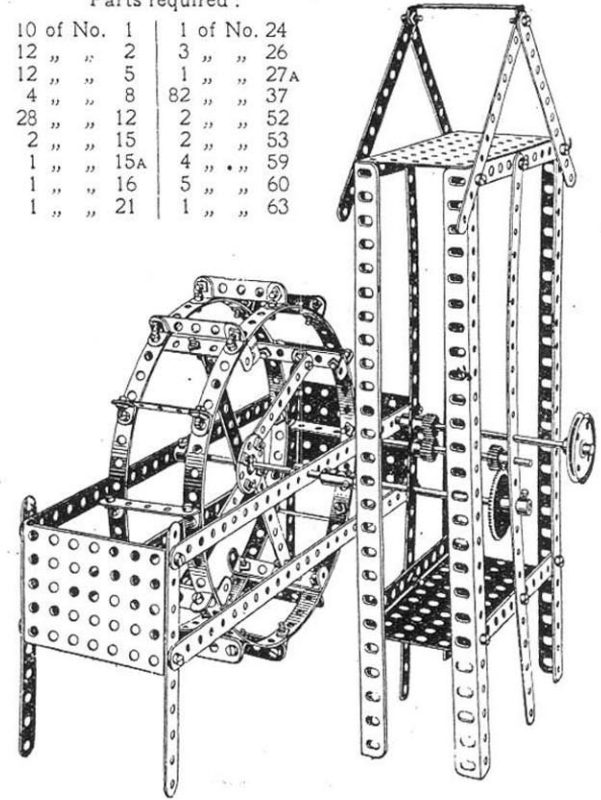
Fig. 501A.  
Side View

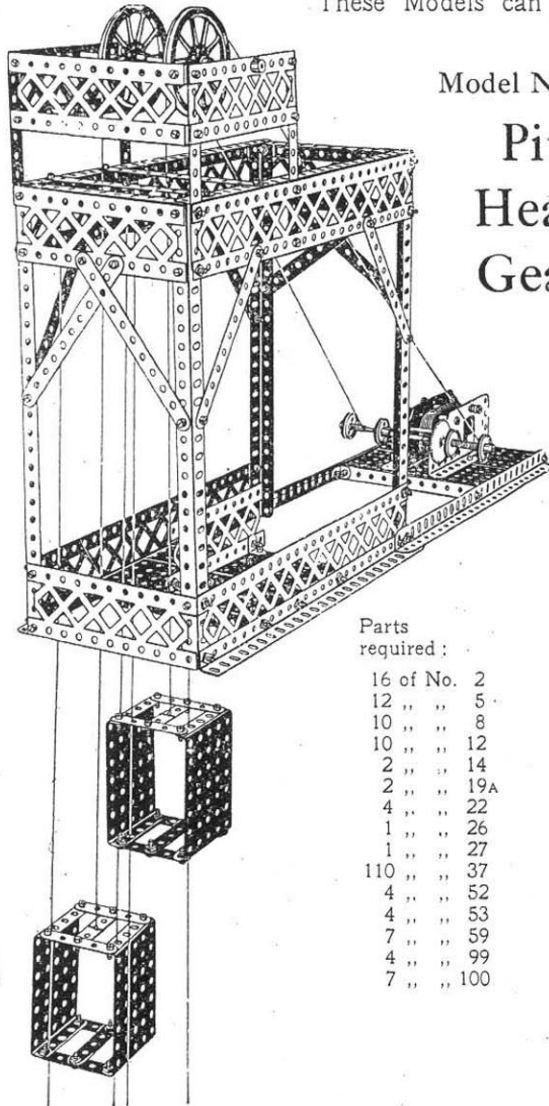
## Model No. 502

## Belgian Water Wheel

Parts required :

10 of No.	1	1 of No.	24
12 " "	2	3 " "	26
12 " "	5	1 " "	27A
4 " "	8	82 " "	37
28 " "	12	2 " "	52
2 " "	15	2 " "	53
1 " "	15A	4 " "	59
1 " "	16	5 " "	60
1 " "	21	1 " "	63





Model No. 503

# Pit Head Gear

Parts required :

- 16 of No. 2
- 12 " " 5
- 10 " " 8
- 10 " " 12
- 2 " " 14
- 2 " " 19A
- 4 " " 22
- 1 " " 26
- 1 " " 27
- 110 " " 37
- 4 " " 52
- 4 " " 53
- 7 " " 59
- 4 " " 99
- 7 " " 100

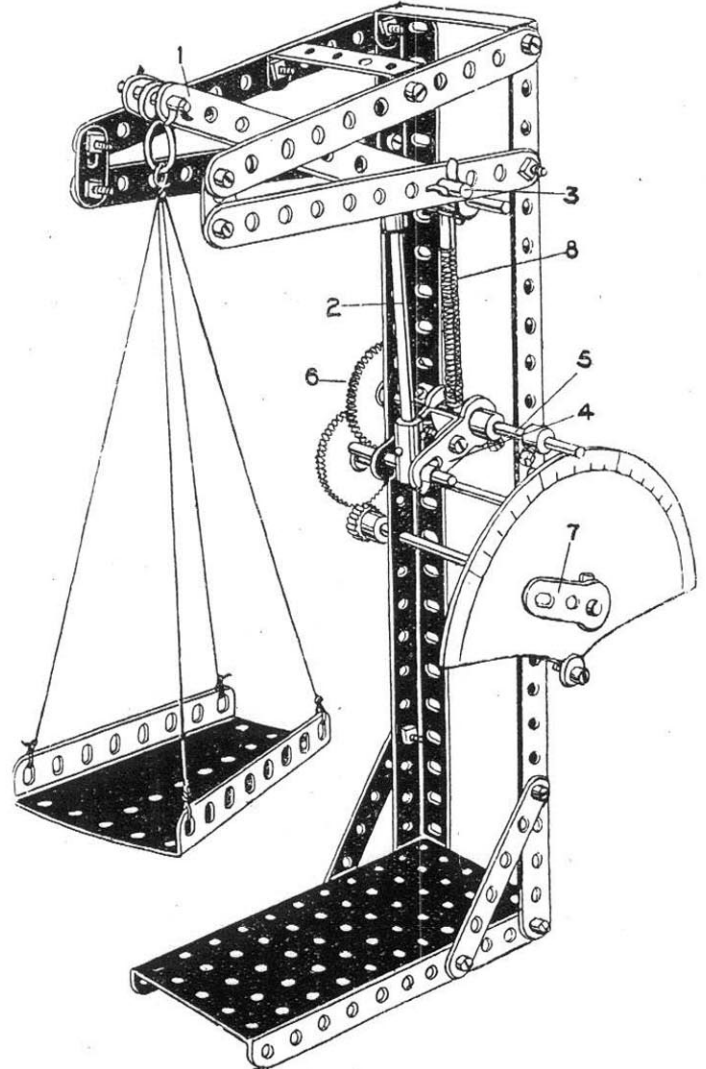
Model No. 504

# Spring Scales

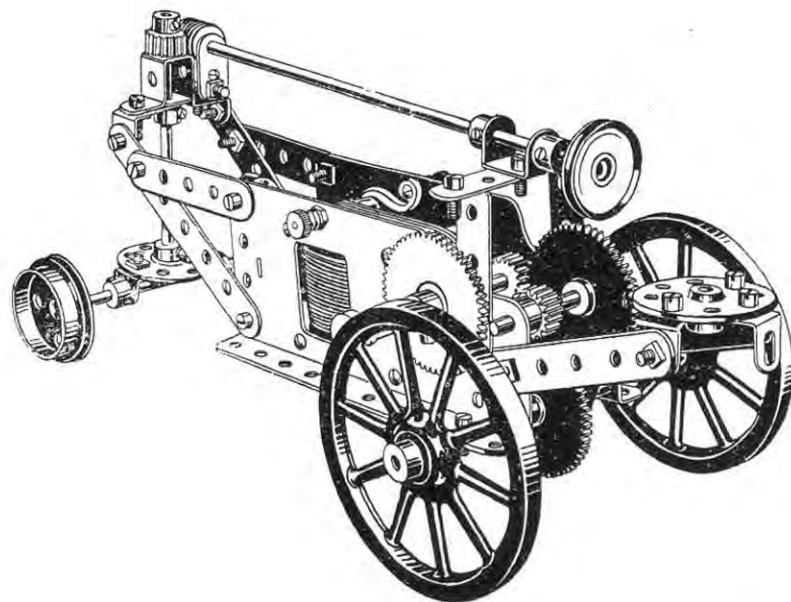
Parts required :

- |            |             |
|------------|-------------|
| 6 of No. 2 | 2 of No. 27 |
| 2 " " 4    | 23 " " 37   |
| 2 " " 8    | 1 " " 43    |
| 2 " " 10   | 1 " " 52    |
| 3 " " 11   | 1 " " 54    |
| 2 " " 15   | 1 " " 57    |
| 1 " " 15A  | 2 " " 59    |
| 2 " " 16   | 2 " " 60    |
| 3 " " 17   | 2 " " 62    |
| 1 " " 18A  | 2 " " 63    |
| 2 " " 26   |             |

The Scale beam 1 is made of two  $5\frac{1}{4}$ " strips distanced by double bent strips. The vertical rod 2 is connected to the beam which is pivoted on the rod 3. The cranks 4 are gripped on an axle 5 on which is secured the gear wheel 6 actuating through a gear train the pointer 7. A spring 8 connected to a rod 5 and another rod in the end hole of the beam acts as the spring balance.

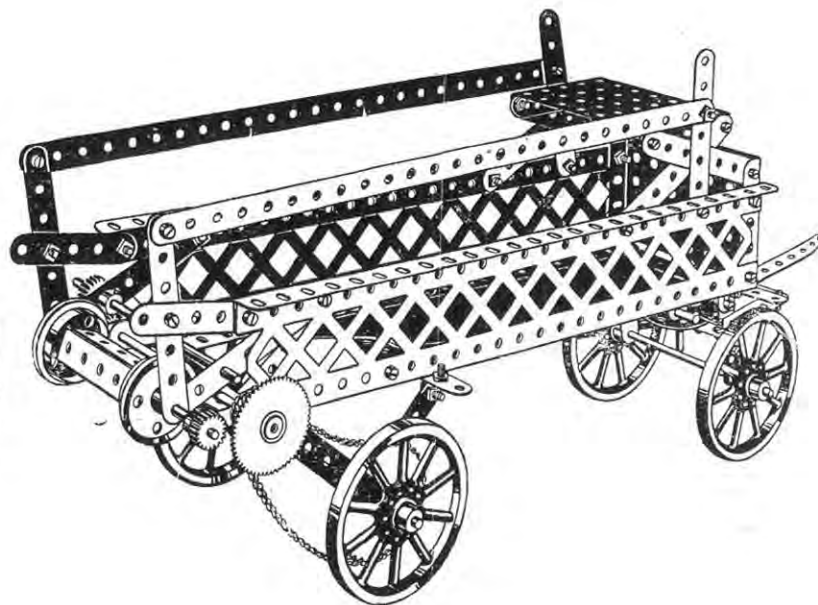


Model No. 505 Farm Tractor



Parts required :

2 of No. 3	1 of No. 15	2 of No. 27
5 " " 5	2 " " 15A	1 " " 32
3 " " 10	2 " " 19A	24 " " 37
1 " " 11	2 " " 20	1 " " 45
7 " " 12	1 " " 22	8 " " 59
1 " " 13	2 " " 24	2 " " 60
	2 " " 26	

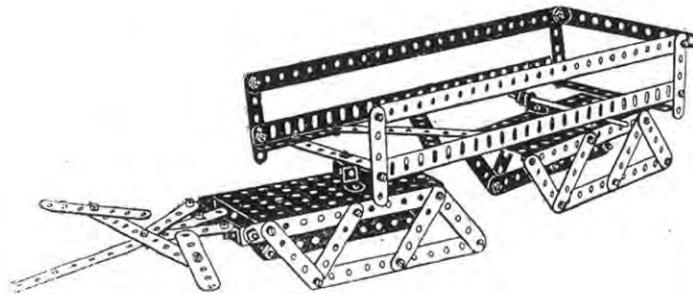
Model No. 506  
Manure Distributing Cart

Parts required :

2 of No. 1	2 of No. 15A	1 of No. 46
3 " " 2	2 " " 17	2 " " 53
10 " " 3	4 " " 19A	8 " " 59
9 " " 5	2 " " 20	4 " " 60
4 " " 8	1 " " 24	1 " " 94
6 " " 12	3 " " 26	1 " " 95
1 " " 14	1 " " 27A	1 " " 96
3 " " 15	4 " " 35	2 " " 99
	57 " " 37	



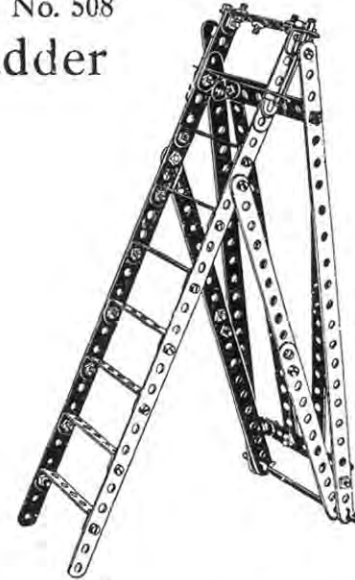
Model No. 507 **Bob Sleigh**



Parts required :

3 of No.	1
10 "	2
4 "	3
22 "	5
2 "	8
7 "	12
1 "	15A
60 "	37
1 "	45
2 "	52
2 "	59
2 "	60

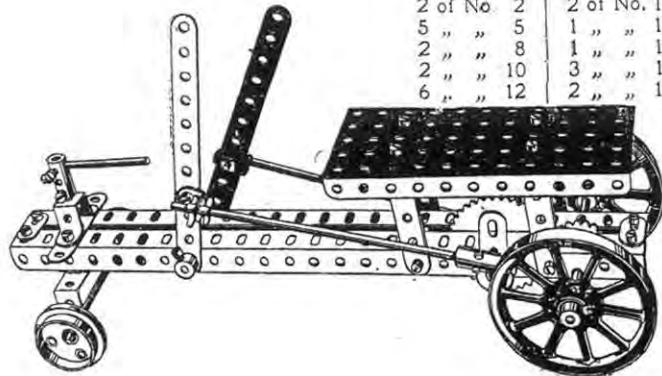
Model No. 508 **Ladder**



Parts required :

4 of No.	1
8 "	2
2 "	3
3 "	5
2 "	10
8 "	12
1 "	16
2 "	17
10 "	35
44 "	37
2 "	59
9 "	60

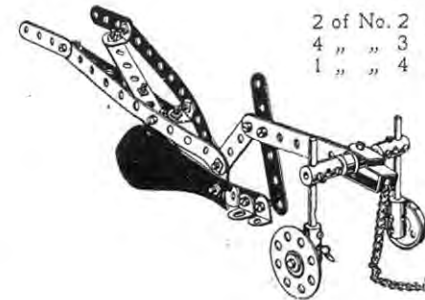
Model No. 509 **Hand Car**



Parts required :

2 of No. 2	2 of No. 14	2 of No. 20
5 " " 5	1 " " 15	1 " " 24
2 " " 8	1 " " 15A	4 " " 35
2 " " 10	3 " " 17	26 " " 37
6 " " 12	2 " " 19A	1 " " 45
		1 " " 46
		1 " " 52
		6 " " 59
		2 " " 62
		3 " " 63
		4 " " 95
		1 " " 96

Model No. 510 **Plough**

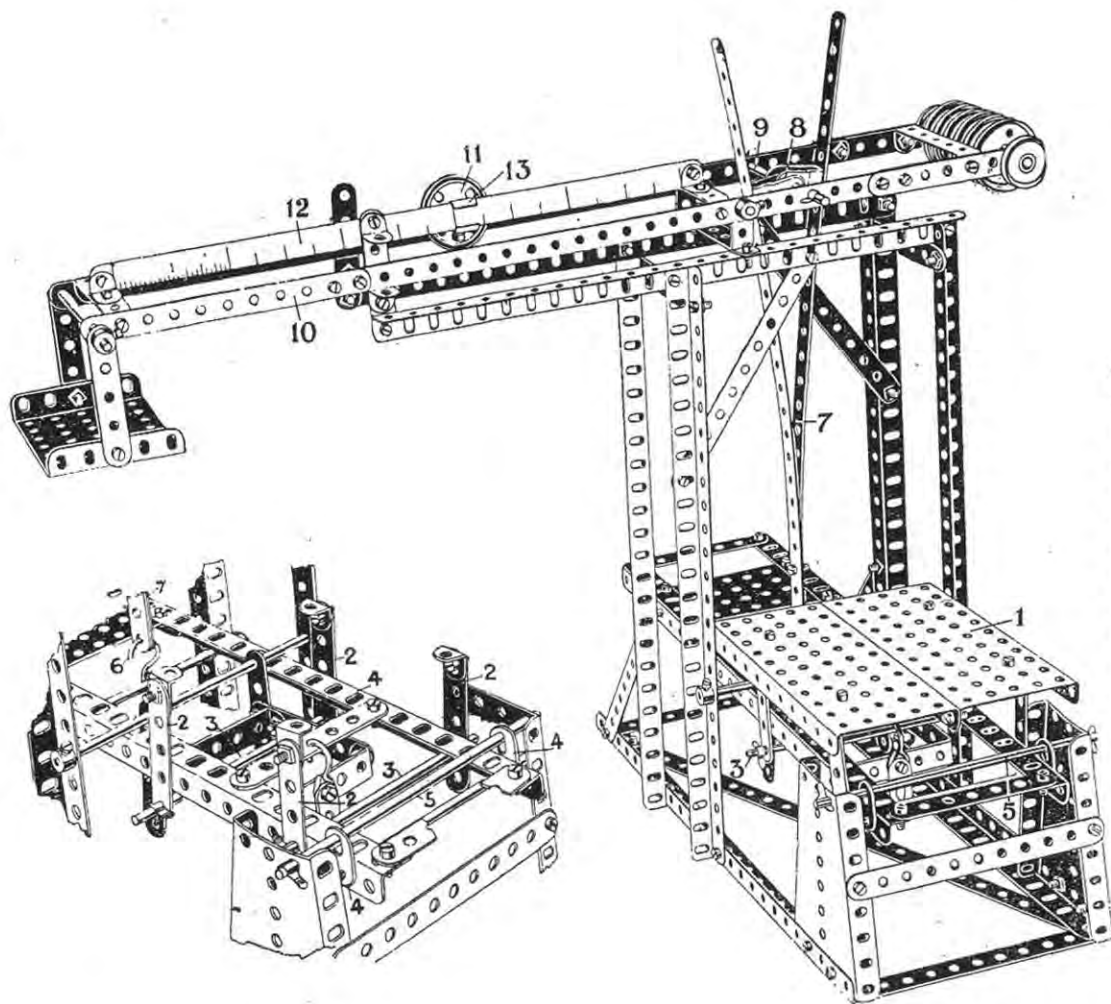


Parts required :

2 of No. 2	1 of No. 5
4 " " 3	4 " " 6
1 " " 4	6 " " 12
	2 " " 17
	1 " " 18A
	1 " " 22
	1 " " 24
	15 " " 37
	1 " " 41
	1 " " 44
	2 " " 59
	4 " " 63
	3 " " 94

## Model No. 511

Parts required:	
7 of No.	1
8 " "	2
8 " "	3
2 " "	4
10 " "	5
8 " "	8
3 " "	10
9 " "	12
2 " "	15
4 " "	15A
2 " "	16
7 " "	20
2 " "	22
88 " "	37
2 " "	44
1 " "	46
1 " "	50
2 " "	52
2 " "	53
2 " "	54
2 " "	57
8 " "	59
5 " "	60



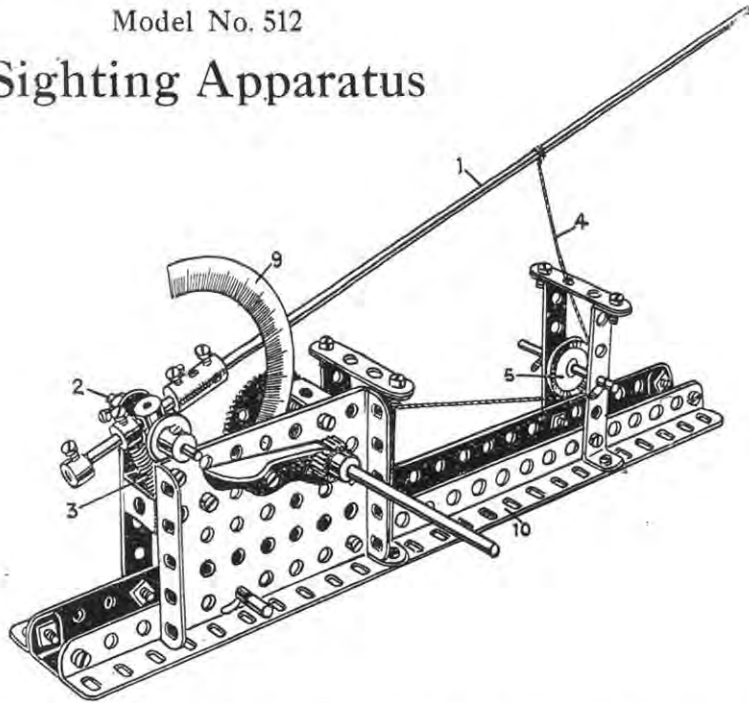
## Beam Scales

The weighing platform 1 is bolted to the four uprights 2, which engage over transverse rods 3, to permit of a parallel movement. The frame 4 of the platform is pivotally slung by flat brackets from the rod 5, and is coupled by hook 6, pull rods 7, which are connected by a pair of cranked bent strips 8 to a rod 9, passing through the side strips 10 to the main weight beam. The sliding weight 11 is adjustable on the graduated arm by an eye piece 13.

Fig. 511A

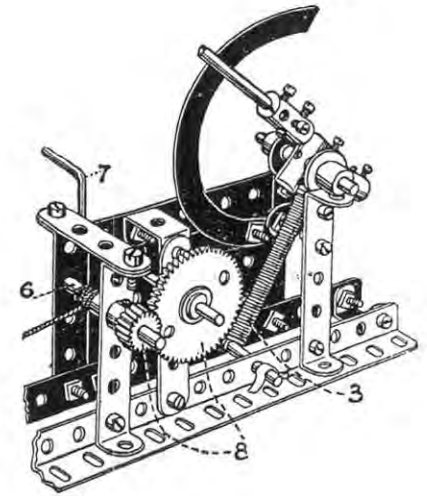
Model No. 512

# Sighting Apparatus



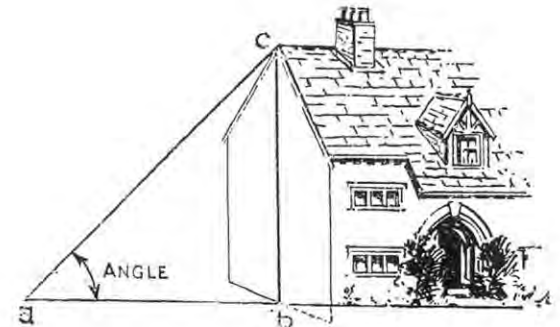
Parts required :

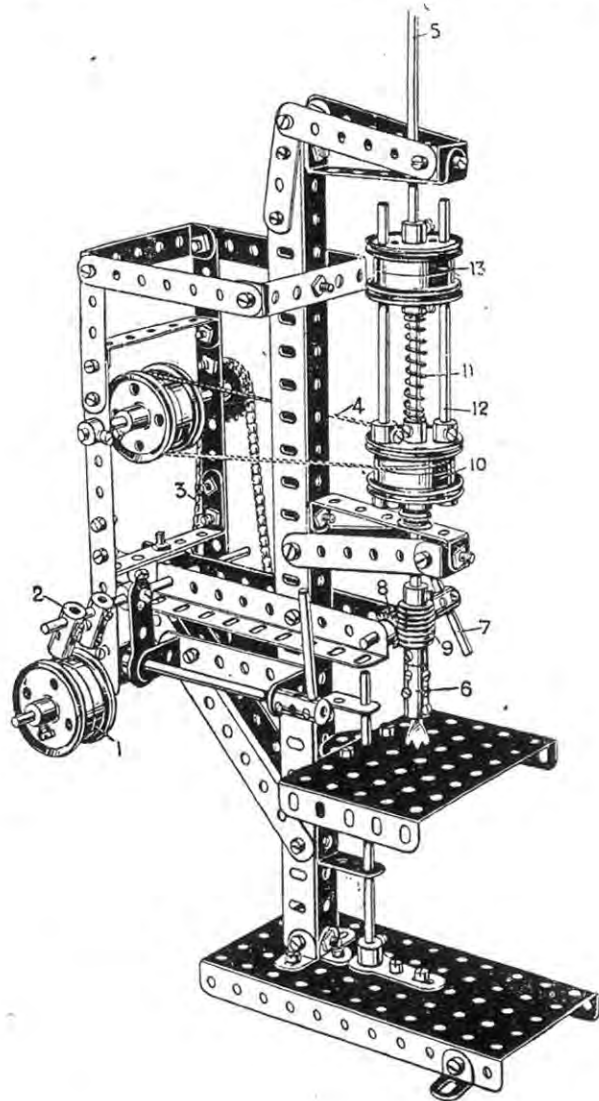
1 of No. 5	1 of No. 33
2 " " 6	2 " " 35
2 " " 8	24 " " 37
4 " " 11	1 " " 43
1 " " 13	1 " " 53
4 " " 17	3 " " 59
1 " " 19	5 " " 60
1 " " 22	2 " " 62
2 " " 26	2 " " 63
1 " " 27A	



This model is for determining the heights of buildings, towers, etc. The pointer  $11\frac{1}{2}$ " rod 1 is pivoted on the 2" rod 2 and controlled by a spring 3, the pointer 1 being adjusted by the cord 4 which passes round a guide pulley 5 and on to the axle 6 upon which it is wound by the crank handle 7 which operates the gear wheel and pinion 8. A graduated scale of degrees 9 made of cardboard, or a protractor, is mounted in order to read off the angle of inclination of the pointer.

In finding the height of a building, measure out a number of feet or yards from the foot of the building, and set this out to some scale corresponding to the line *a, b*, in the diagram, then, standing at the point *a* furthest from the building, and keeping the angle girders 10 horizontal, move the pointer 1 until it is directed towards the top of the building. Then read off the angle on the scale 9, and draw a line *a, c*, making the angle *b a c* equal to the angle read off. Then draw a vertical line *b c* from the point *b*, and with the same scale used for setting off the distance *a b* measure the height *b c*, which will be the height of the building.





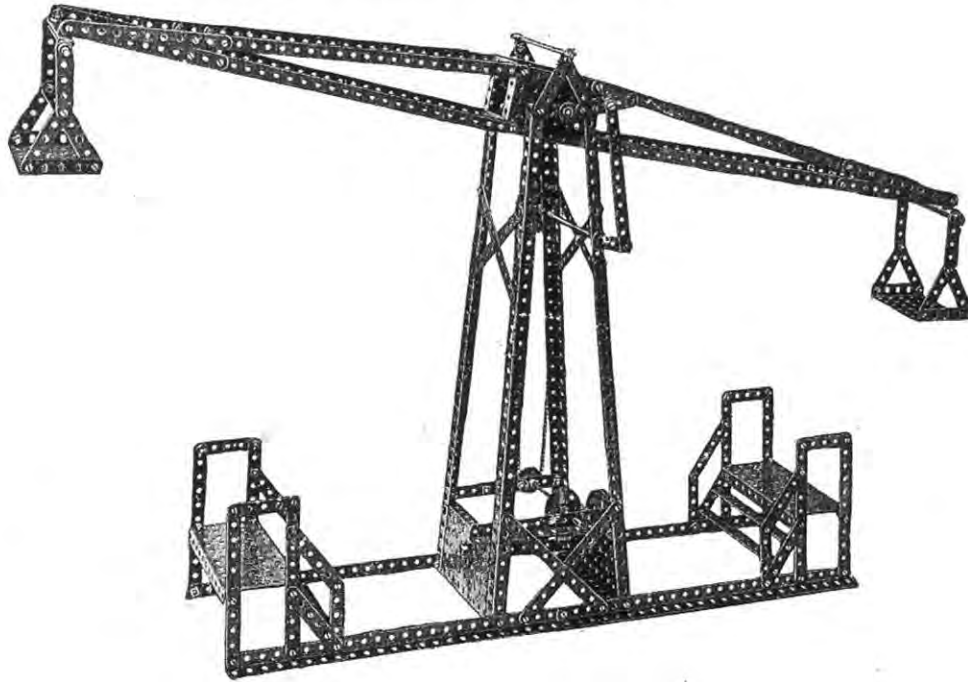
## Model No. 513 Vertical Drill

### Parts required:

4 of No. 2	1 of No. 13	1 of No. 26	7 of No. 60
2 " " 3	2 " " 15	1 " " 32	2 " " 62
5 " " 4	3 " " 15A	55 " " 37	5 " " 63
2 " " 5	2 " " 16	2 " " 46	1 " " 65
2 " " 6	3 " " 17	1 " " 52	1 " " 94
2 " " 8	8 " " 20	1 " " 53	1 " " 95
2 " " 9	2 " " 23	8 " " 59	1 " " 96
2 " " 11	1 " " 24		

The fast and loose pulleys 1 fitted with a belt-shifting gear 2 drive through the sprocket chain 3 and cord 4 the drilling spindle 5. The drill chuck 6 is brought down on the work by turning a short rod 7 which rotates a pinion 8 gearing into a worm 9 on the drill spindle, the worm acting as a rack, rods 12 on the flanged wheels 10 sliding in the holes in the upper flanged wheels 13, the latter being secured to the spindle 5, a spring 11 normally keeping the drill on to the work.

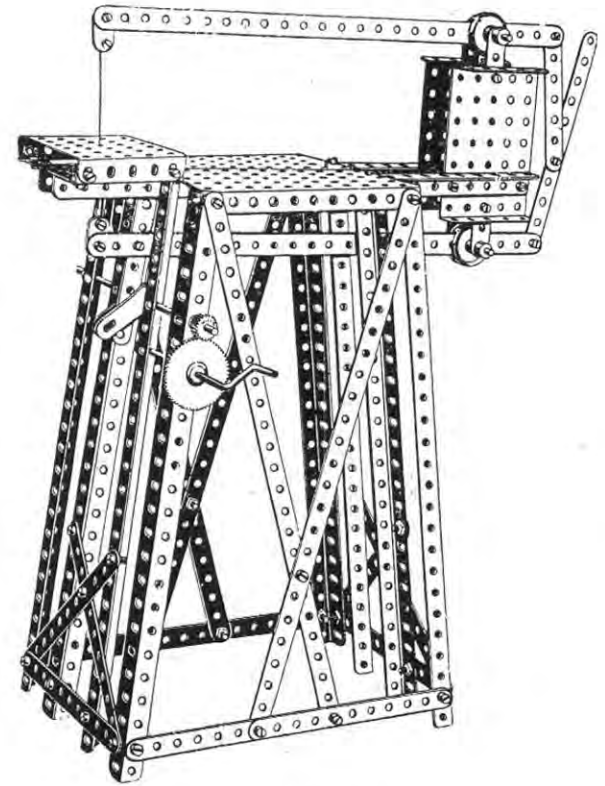
Model No. 514  
**Giant Auto Swing**



Parts required :

8 of No. 1	18 of N. 12	1 of No. 33A	2 of No. 60B
26 " " 2	2 " " 14	165 " " 37	4 " " 60c
2 " " 3	4 " " 15	2 " " 38	2 " " 62
8 " " 4	1 " " 19B	4 " " 52	28" " " 94
31 " " 5	1 " " 24	4 " " 53	1 " " 95
12 " " 8	1 " " 27A	9 " " 59	1 " " 96
1 " " 9	1 " " 32	2 " " 60	

Model  
 No. 515 **Fret Saw**



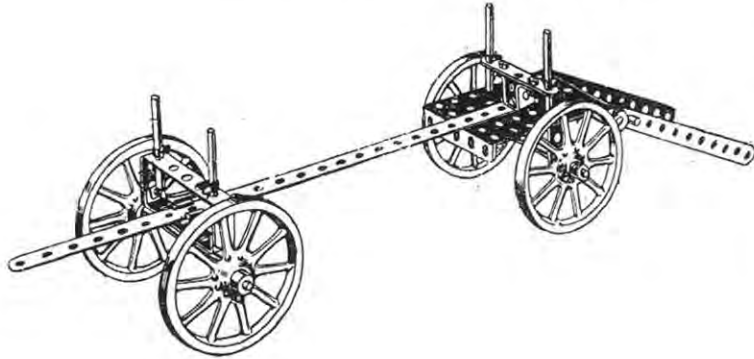
Parts required :

8 of No. 1	10 of No. 8	1 of No. 19	2 of No. 52
13 " " 2	2 " " 10	4 " " 22	3 " " 53
1 " " 3	4 " " 12	1 " " 26	6 " " 59
2 " " 4	2 " " 16	1 " " 27A	2 " " 62
1 " " 5	2 " " 17	65 " " 37	

These Models can be made with MECCANO Outfit No. 5, or No. 4 and No. 4A

Model No. 516

# Timber Carriage

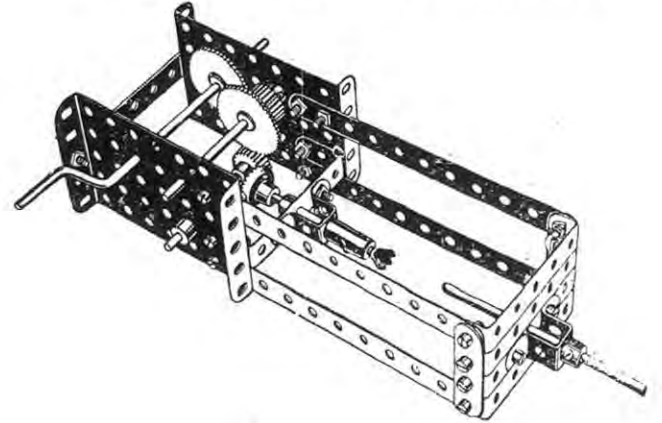


Parts required :

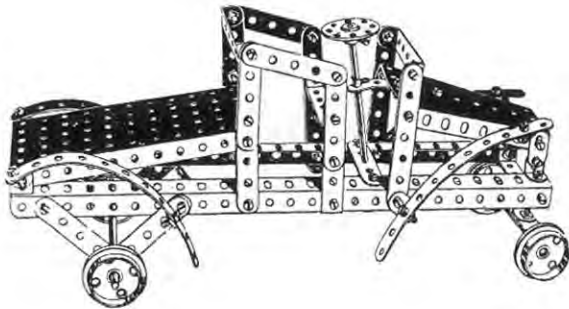
- 1 of No. 1
- 2 " " 2
- 1 " " 5
- 2 " " 15A
- 1 " " 16
- 4 " " 17
- 1 " " 18A
- 4 " " 19A
- 8 " " 35
- 10 " " 37
- 1 " " 45
- 2 " " 46
- 1 " " 50
- 1 " " 53
- 4 " " 59
- 3 " " 60

Model No. 518

# Spooling Machine



Model No. 517—Motor Car



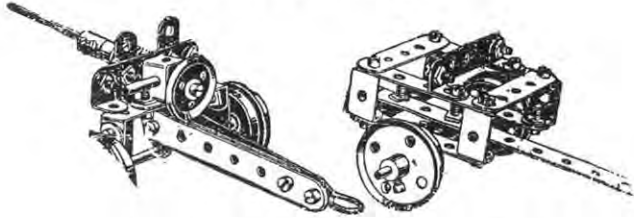
Parts required :

- |            |             |              |
|------------|-------------|--------------|
| 5 of No. 2 | 1 of No. 15 | 55 of No. 37 |
| 2 " " 3    | 2 " " 15A   | 1 " " 45     |
| 14 " " 5   | 4 " " 20    | 1 " " 52     |
| 2 " " 8    | 1 " " 24    | 1 " " 54     |
| 2 " " 10   | 1 " " 35    | 6 " " 60     |
| 12 " " 12  |             | 1 " " 62     |

Parts required :

- |            |              |
|------------|--------------|
| 4 of No. 2 | 26 of No. 37 |
| 1 " " 3    | 2 " " 45     |
| 3 " " 16   | 1 " " 46     |
| 1 " " 17   | 2 " " 53     |
| 1 " " 19   | 7 " " 59     |
| 2 " " 26   | 4 " " 60     |
| 2 " " 27   | 1 " " 63     |
| 1 " " 29   | 1 " " 65     |

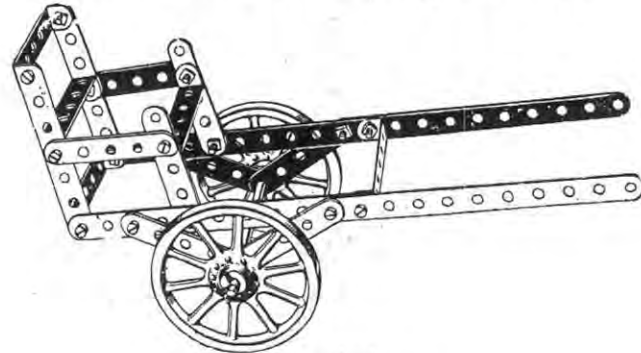
## Model No. 519—Field Gun and Carriage



Parts required :

1 of No. 2	2 of No. 15A	27 of No. 37
5 " " 3	1 " " 16	1 " " 45
12 " " 5	1 " " 17	1 " " 57
2 " " 10	4 " " 20	2 " " 59
4 " " 11	1 " " 22	2 " " 60
5 " " 12	1 " " 32	1 " " 63

## Model No. 520—Ducking Chair



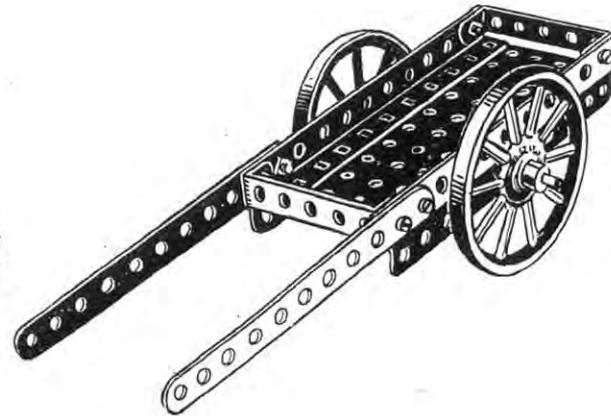
Parts required :

4 of No. 2	2 of No. 19A
2 " " 3	4 " " 35
8 " " 5	16 " " 37
1 " " 15A	5 " " 60

## Model No. 521 Perambulator

Parts required :

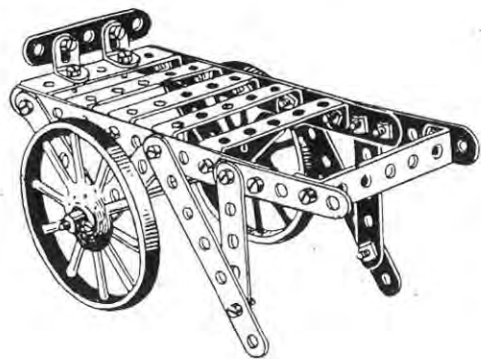
3 of No. 1	1 of No. 16
10 " " 2	4 " " 19A
12 " " 5	2 " " 22
2 " " 10	10 " " 35
12 " " 12	45 " " 37
3 " " 15A	1 " " 52
	3 " " 60



## Model No. 522 Station Cart

Parts required :

4 of No. 2	10 of No. 37
4 " " 12	1 " " 52
1 " " 15A	2 " " 60
3 " " 19B	

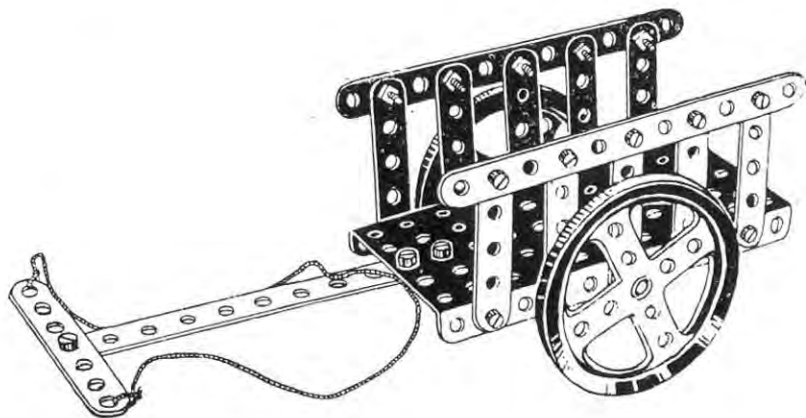


Model No. 523  
Market Gardener's  
Truck

Parts required :

2 of No. 2	2 of No. 12	2 of No. 35
2 " " 3	1 " " 15A	22 " " 37
9 " " 5	2 " " 19A	6 " " 60

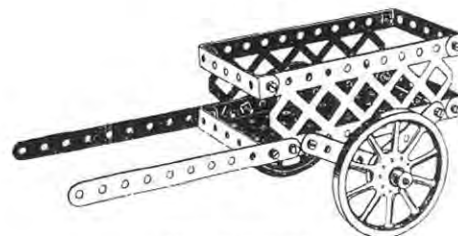
Model No. 524.  
Bullock Cart



Parts  
required :

3 of No. 2	2
1 " " 3	3
10 " " 5	5
1 " " 16	16
2 " " 19B	19B
21 " " 37	37
1 " " 52	52

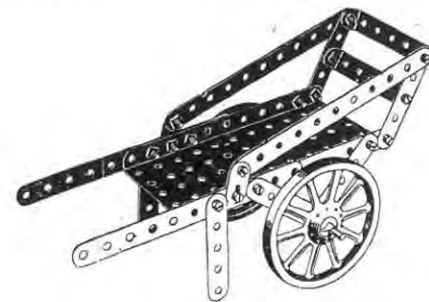
Model No. 525  
Cart



Parts required :

4 of No. 2	2 of No. 22	1 of No. 52
4 " " 5	15 " " 37	2 " " 59
1 " " 15	1 " " 44	4 " " 60
2 " " 19A		2 " " 100

Model No. 526  
Coster's Barrow

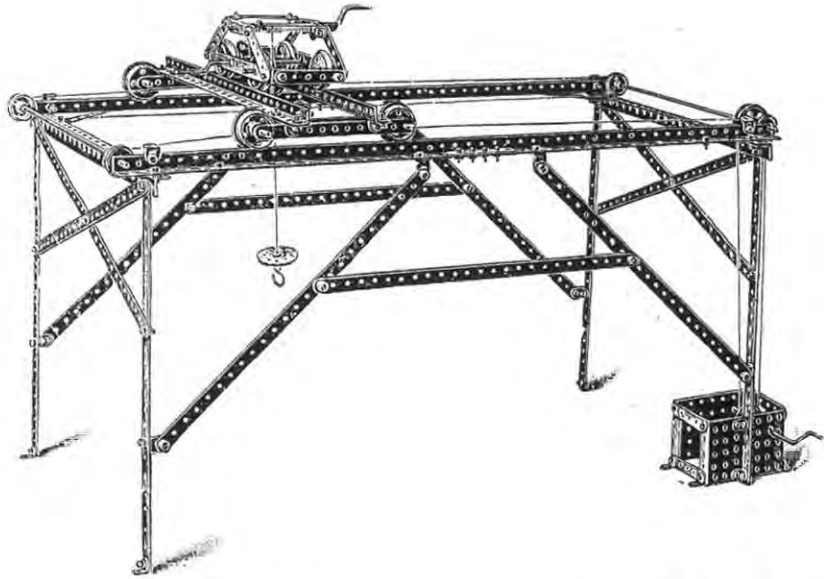


Parts required :

4 of No. 2	1 of No. 15A	16 of No. 37
8 " " 5	2 " " 19A	1 " " 52
2 " " 10	4 " " 35	2 " " 60



## Model No. 527—Travelling Crane



Above is a complete view of the structure showing the braced gantry carrying a rail at each side. The rails are formed by angle girders butt-jointed. Fig. 527A shows the construction of the travelling gantry with two pairs of wheels so arranged as to fit the gauge of the rails. The gantry is caused to travel to and fro on the rails by a cord which is connected to the gantry by a nut and bolt 1 and passes over a pulley at each end of the rail, secured to the rod. On one of these rods is secured a  $1\frac{1}{2}$ " pulley carrying the driving cord, which passes over a pulley wheel secured to the crank handle. The winch, Fig. 527B, again is arranged to run on the gantry rails of 527A, and is provided with a cranked hoisting axle 2 and another axle 3 for traversing the winch.

Fig. 527c is an alternative winch.

Parts required :			
14 of No.	1	4 of No.	22
6 "	2	1 "	22A
4 "	4	1 "	24
10 "	5	2 "	26
8 "	8	1 "	27A
26 "	12	1 "	33
2 "	13	4 "	35
2 "	15	98 "	37
4 "	17	2 "	53
3 "	19	1 "	57
8 "	20	5 "	59
1 "	21	4 "	60

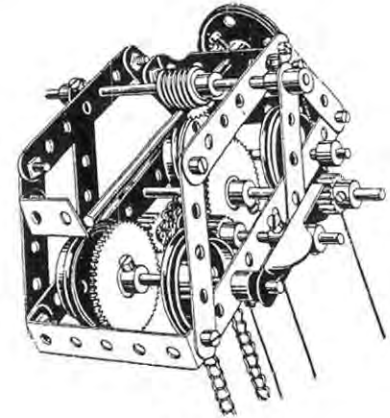


Fig. 527c

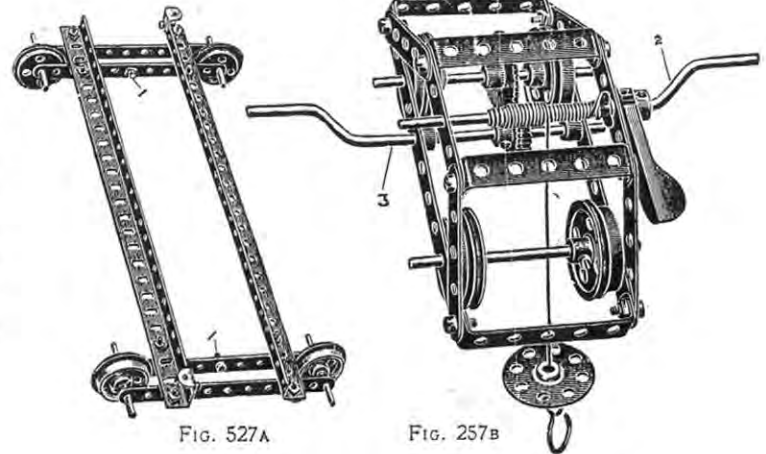
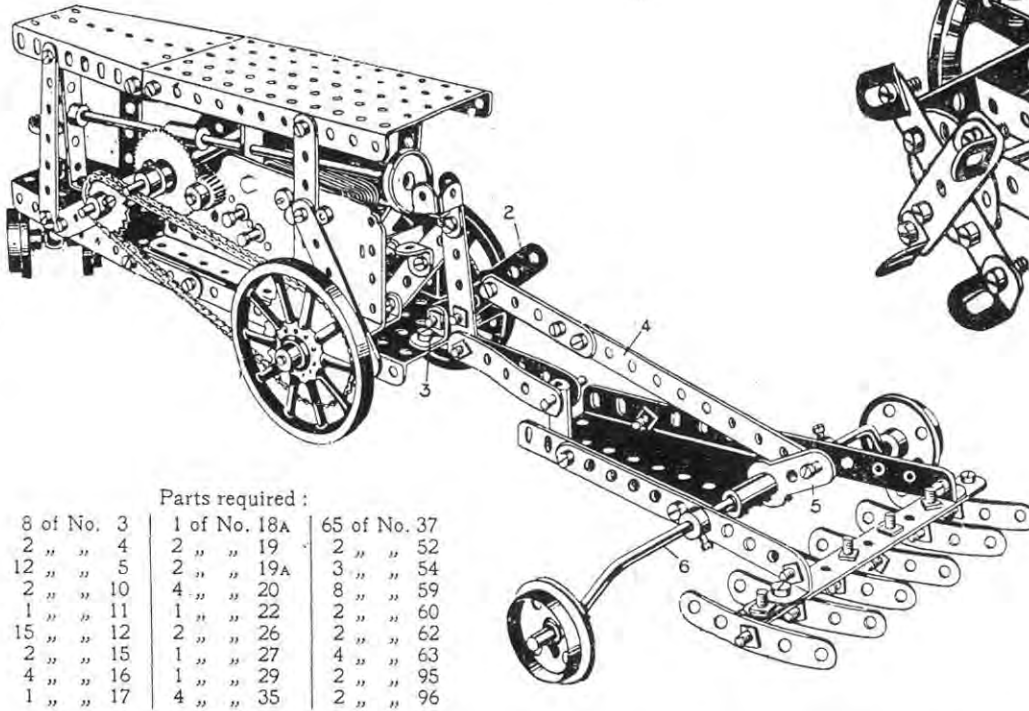


FIG. 527A

FIG. 527B

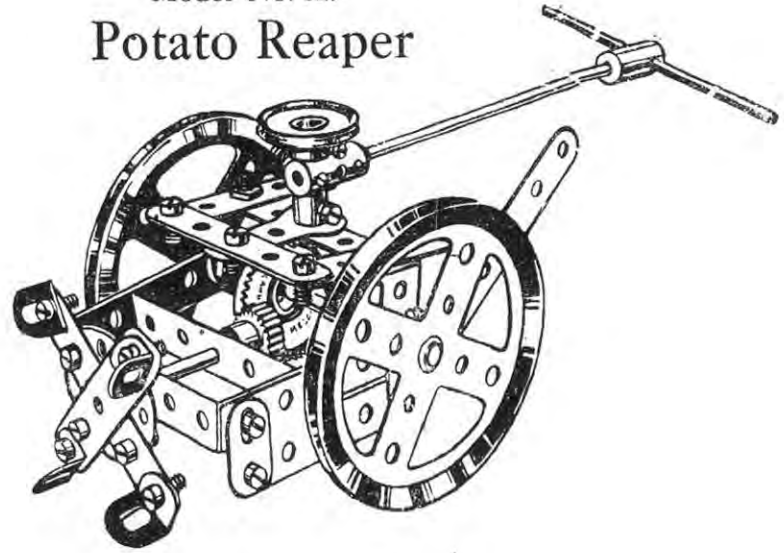
## Model No. 528 Motor Plough



### Parts required :

8 of No. 3	1 of No. 18A	65 of No. 37
2 " " 4	2 " " 19	2 " " 52
12 " " 5	2 " " 19A	3 " " 54
2 " " 10	4 " " 20	8 " " 59
1 " " 11	1 " " 22	2 " " 60
15 " " 12	2 " " 26	2 " " 62
2 " " 15	1 " " 27	4 " " 63
4 " " 16	1 " " 29	2 " " 95
1 " " 17	4 " " 35	2 " " 96

## Model No. 529 Potato Reaper

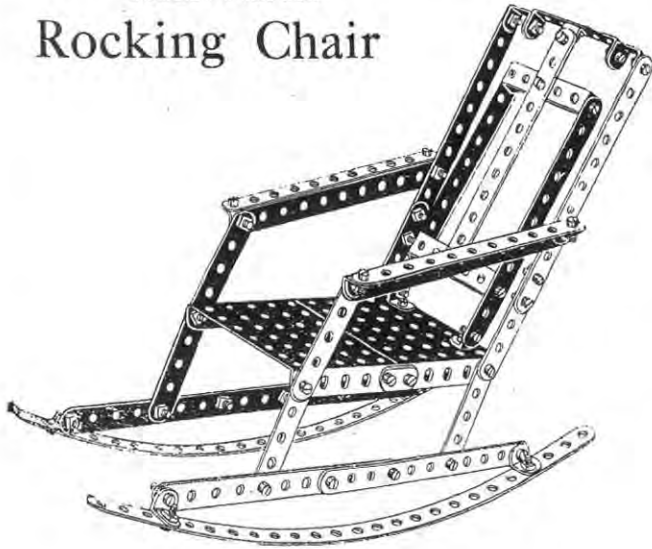


### Parts required :

1 of No. 3	1 of No. 24
8 " " 5	1 " " 26
2 " " 10	1 " " 28
4 " " 12	19 " " 37
1 " " 15	1 " " 46
2 " " 16	1 " " 59
1 " " 17	2 " " 60
1 " " 18A	1 " " 62
2 " " 19B	2 " " 63
1 " " 22	

The ploughshares 1 are raised or lowered by the handle 2 pivoted to an angle bracket on the far side of the seat pillar, and connected by strips 4 to a crank 5 secured on the bent axle 6 of the wheels formed by crank handles. The plough is driven by a Meccano 4-volt electric motor.

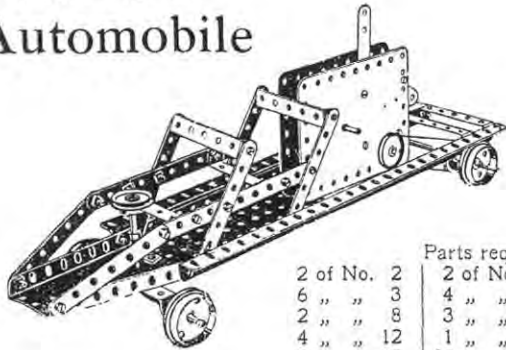
Model No. 530  
Rocking Chair



Parts required:

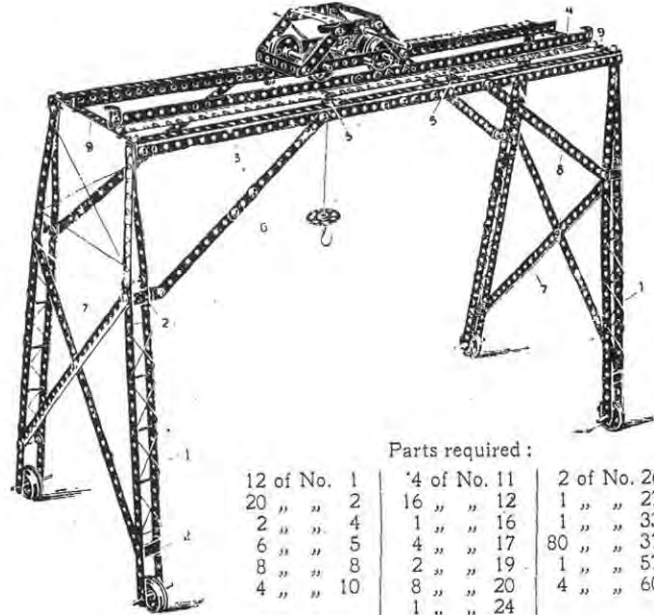
2 of No.	1
13 " "	2
8 " "	5
2 " "	10
2 " "	11
11 " "	12
48 " "	37
2 " "	53
3 " "	60

Model No. 532  
Automobile



2 of No.	2	2 of No.	17	1 of No.	46
6 " "	3	4 " "	20	1 " "	52
2 " "	8	3 " "	22	1 " "	54
4 " "	12	1 " "	24	3 " "	59
2 " "	15	38 " "	37	7 " "	60
		1 " "	45		

Model No. 531—Travelling Crane



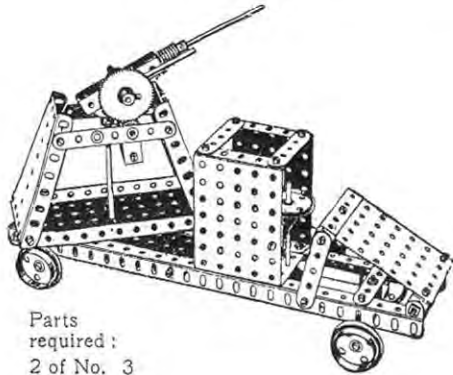
Parts required:

12 of No.	1	4 of No.	11	2 of No.	26
20 " "	2	16 " "	12	1 " "	27A
2 " "	4	1 " "	16	1 " "	33
6 " "	5	4 " "	17	80 " "	37
8 " "	8	2 " "	19	1 " "	57
4 " "	10	8 " "	20	4 " "	60
		1 " "	24		

The side frames of this model are similarly constructed, each leg being made of  $12\frac{1}{2}$ " and  $5\frac{1}{2}$ " perforated strips overlapped two holes and distended by double brackets 2 and bolted together at the top, and to angle brackets bolted to the ends of the outer horizontal angle girders 3. The inner angle girders 4 are reversed with their webs up, to form rails for the crane. The central parts of the girders 4 are supported by flat brackets 5, and the outer girders 3 are braced by the diagonal  $5\frac{1}{2}$ " strips 6 bolted to the legs 1 and the girders 3. Each end pair of legs is also braced by the crossed  $12\frac{1}{2}$ " strips 7. The whole gantry travels on the flanged wheels 8 carried on 2" rods passed through the lowest holes of the legs 1.  $5\frac{1}{2}$ " strips 9 connect the outer girders 3 and inner girders 4. The winch is constructed as shown in Fig. 527B.

Model No. 533

# Armoured Motor Car



Parts required :

- 2 of No. 3
- 9 " " 5
- 2 " " 8
- 2 " " 11
- 2 " " 12
- 2 " " 15
- 2 " " 15A
- 1 " " 16
- 3 " " 17
- 4 " " 20
- 1 " " 21
- 4 " " 22
- 1 " " 24
- 1 " " 26
- 1 " " 27
- 1 " " 32
- 43 " " 37
- 1 " " 45
- 2 " " 52
- 3 " " 53
- 2 " " 54
- 1 " " 59
- 7 " " 60
- 1 " " 62
- 1 " " 63

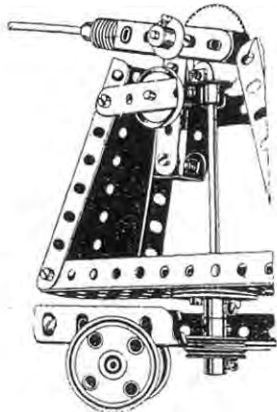
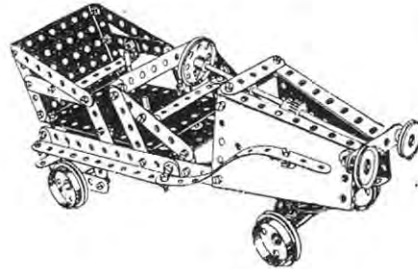


FIG. 533A

Model No. 534

# Automobile

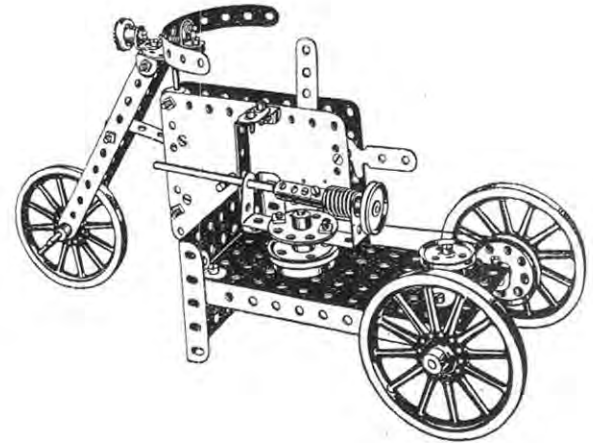


Parts required :

- |            |             |
|------------|-------------|
| 8 of No. 2 | 2 of No. 22 |
| 5 " " 3    | 1 " " 24    |
| 4 " " 4    | 2 " " 26    |
| 9 " " 5    | 1 " " 28    |
| 6 " " 10   | 1 " " 29    |
| 28 " " 12  | 17 " " 37   |
| 1 " " 14   | 1 " " 45    |
| 1 " " 15   | 1 " " 53    |
| 1 " " 15A  | 2 " " 54    |
| 1 " " 17   | 4 " " 59    |
| 4 " " 20   | 2 " " 60    |
| 1 " " 21   |             |

Model No. 535

# Armoured Motor Tricycle

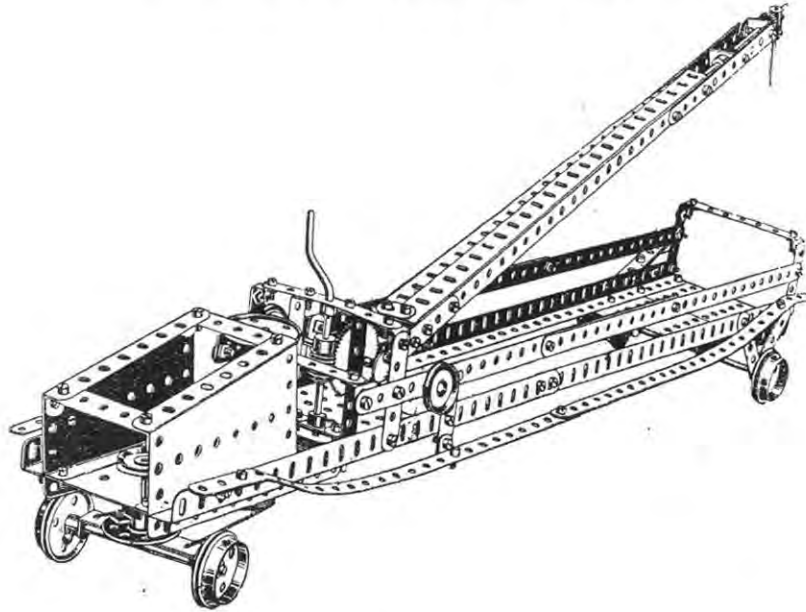


Parts required :

- |            |             |
|------------|-------------|
| 4 of No. 2 | 2 of No. 24 |
| 1 " " 5    | 1 " " 29    |
| 1 " " 10   | 1 " " 33    |
| 3 " " 11   | 29 " " 37   |
| 6 " " 12   | 2 " " 45    |
| 2 " " 15   | 1 " " 46    |
| 1 " " 17   | 1 " " 52    |
| 1 " " 18A  | 1 " " 53    |
| 1 " " 20   | 8 " " 59    |
| 1 " " 21   | 1 " " 60    |
| 4 " " 22   | 1 " " 62    |
| 1 " " 22A  | 1 " " 63    |

Model No. 536

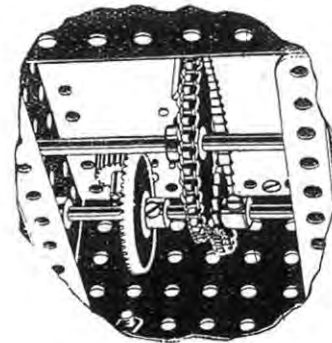
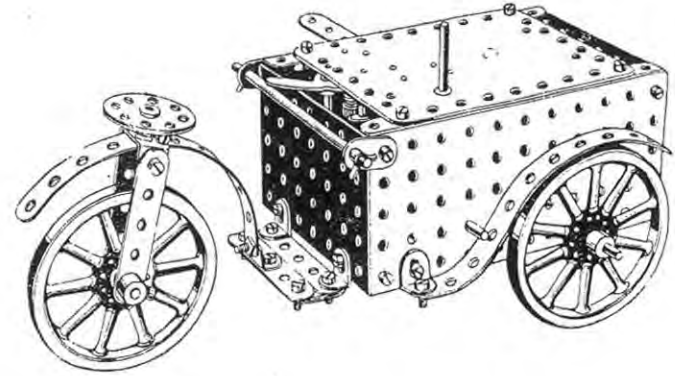
# Fire Watertower



Parts required:		
4 of No. 1	2 of No. 16	98 of No. 37
2 " " 2	2 " " 17	1 " " 45
5 " " 3	1 " " 19	1 " " 52
14 " " 5	4 " " 20	3 " " 53
8 " " 8	1 " " 21	2 " " 54
2 " " 10	4 " " 22	5 " " 59
2 " " 11	2 " " 24	3 " " 60
12 " " 12	1 " " 26	2 " " 62
3 " " 15A	1 " " 27A	1 " " 63
	1 " " 32	

Model No. 537

# Delivery Van



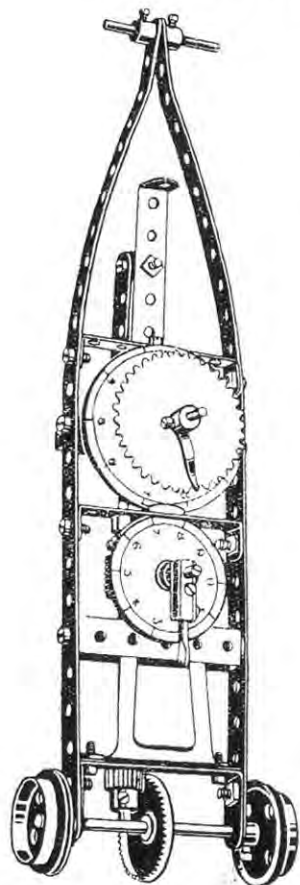
Parts required:

3 of No. 2	1 of No. 28
4 " " 5	2 " " 35
4 " " 10	27 " " 37
1 " " 11	2 " " 52
5 " " 12	2 " " 53
1 " " 15	6 " " 59
1 " " 15A	9 " " 94
1 " " 18A	1 " " 95
1 " " 24	1 " " 96
1 " " 26	

FIG. 537A

Model No. 538

## Measuring Machine



Parts required :

2 of No. 1	1 of No. 28
1 " " 5	1 " " 32
1 " " 12	16 " " 37
2 " " 15A	2 " " 46
1 " " 16	4 " " 59
2 " " 17	5 " " 60
2 " " 20	1 " " 63
1 " " 22	1 " " 65
2 " " 26	1 " " 95
	1 " " 96

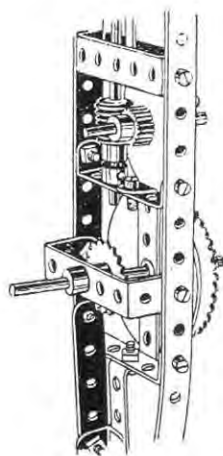
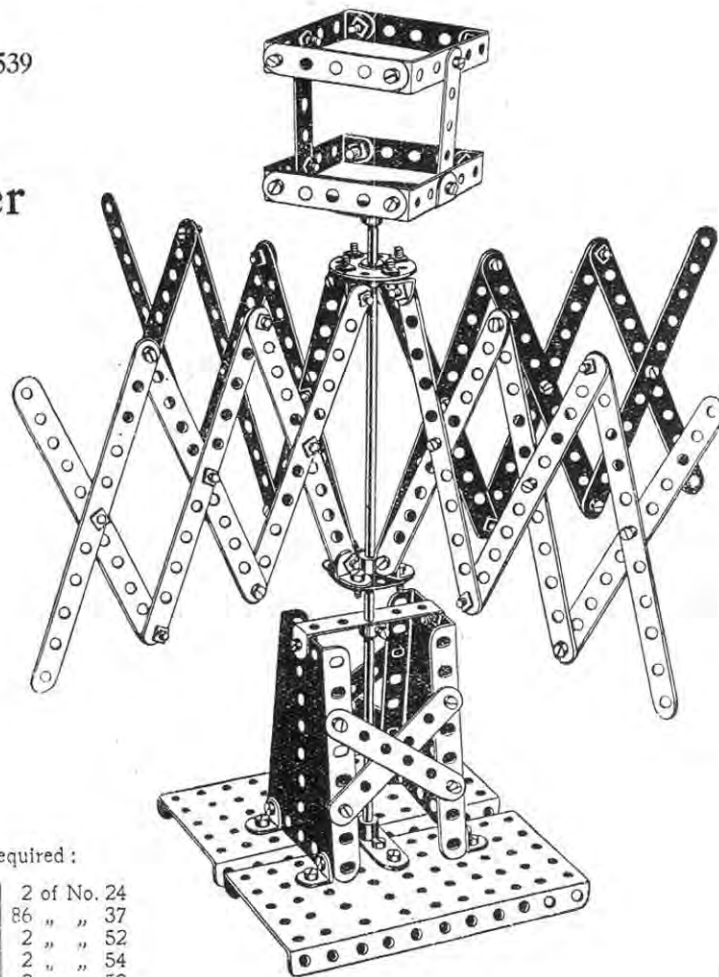


FIG. 538A

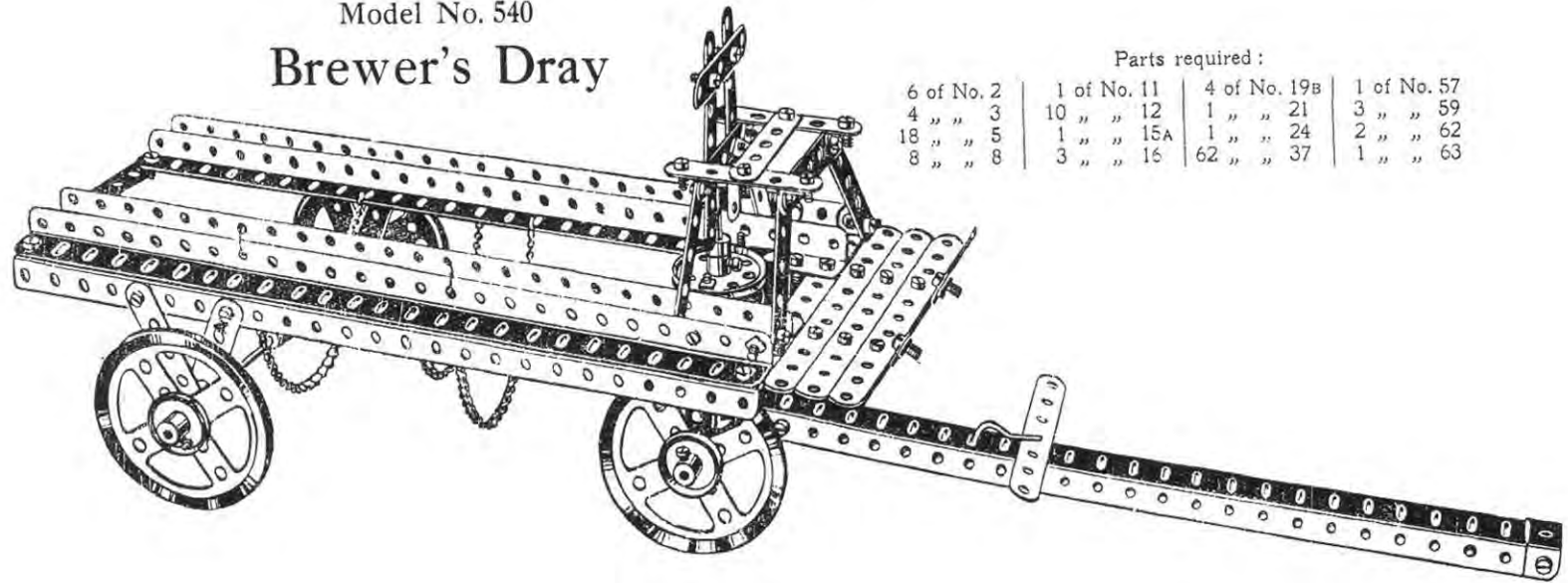
Model No. 539

Skein  
Winder

Parts required :

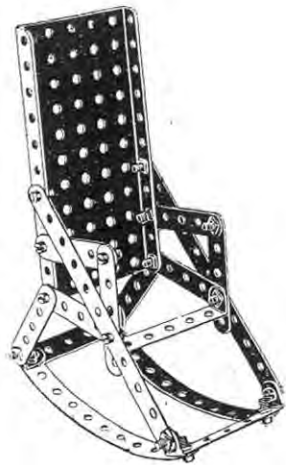
24 of No. 2	2 of No. 24
4 " " 4	86 " " 37
7 " " 5	2 " " 52
8 " " 12	2 " " 54
1 " " 13	2 " " 59
1 " " 21	6 " " 60

Model No. 540  
**Brewer's Dray**



Parts required:

6 of No. 2	1 of No. 11	4 of No. 19B	1 of No. 57
4 " " 3	10 " " 12	1 " " 21	3 " " 59
18 " " 5	1 " " 15A	1 " " 24	2 " " 62
8 " " 8	3 " " 16	62 " " 37	1 " " 63

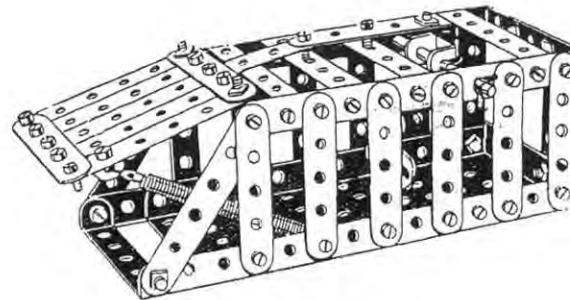


Model No. 541  
**Rocking  
 Chair**

Parts required:

4 of No. 2	18 of No. 37
9 " " 5	1 " " 52
2 " " 12	1 " " 60

Model No. 542—**Mouse Trap**



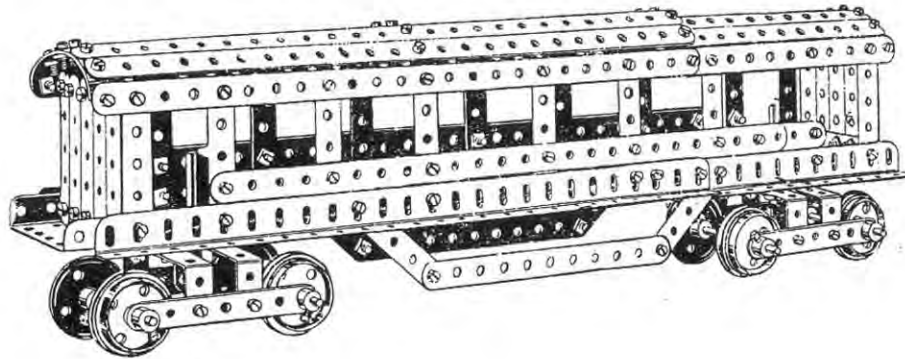
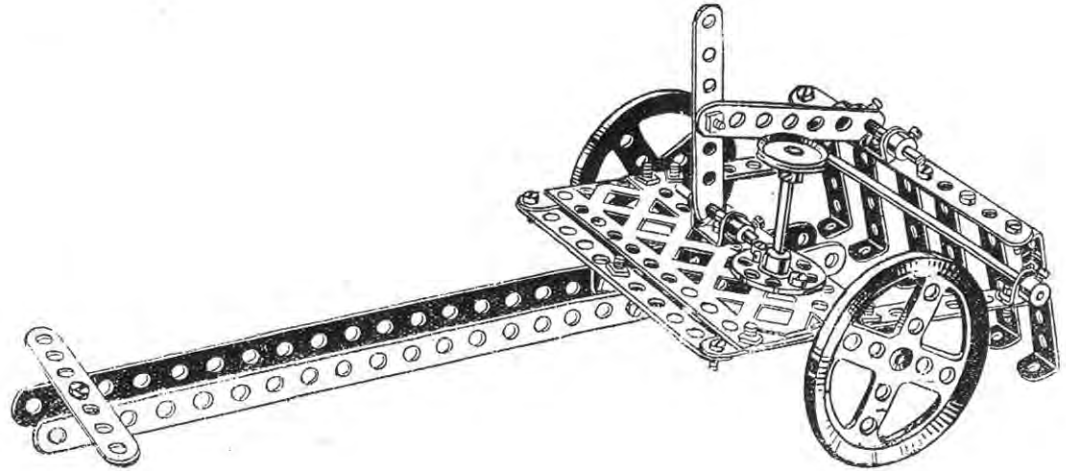
Parts required:

5 of No. 2	4 of No. 35
7 " " 4	59 " " 37
17 " " 5	5 " " 38
5 " " 10	1 " " 43
1 " " 11	1 " " 52
6 " " 12	8 " " 60
1 " " 16	

## Model No. 543 Horse Rake

Parts required:

2 of No. 1	2 of No. 19B
5 " " 2	1 " " 22
3 " " 3	1 " " 24
3 " " 11	27 " " 37
6 " " 12	6 " " 59
2 " " 14	6 " " 60
3 " " 17	1 " " 100



## Model No. 544 Pullman Car

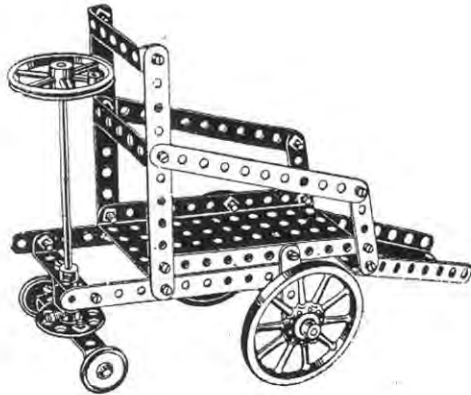
Parts required:

9 of No. 1	4 of No. 8	116 of No. 37
9 " " 2	4 " " 16	4 " " 46
8 " " 3	2 " " 17	3 " " 52
34 " " 5	8 " " 20	10 " " 59
	2 " " 21	



Model No. 545

## Invalid Chair

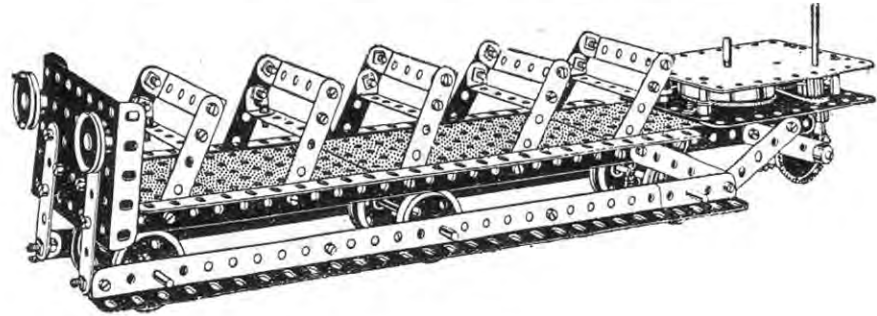


Parts required:

6 of No. 2	1 of No. 20A	1 of No. 46
4 " " 5	2 " " 22	1 " " 52
2 " " 15A	1 " " 24	1 " " 54
1 " " 16	24 " " 37	1 " " 59
2 " " 19A		4 " " 60

Model  
No. 546

## Touring Tram Car



Parts required:

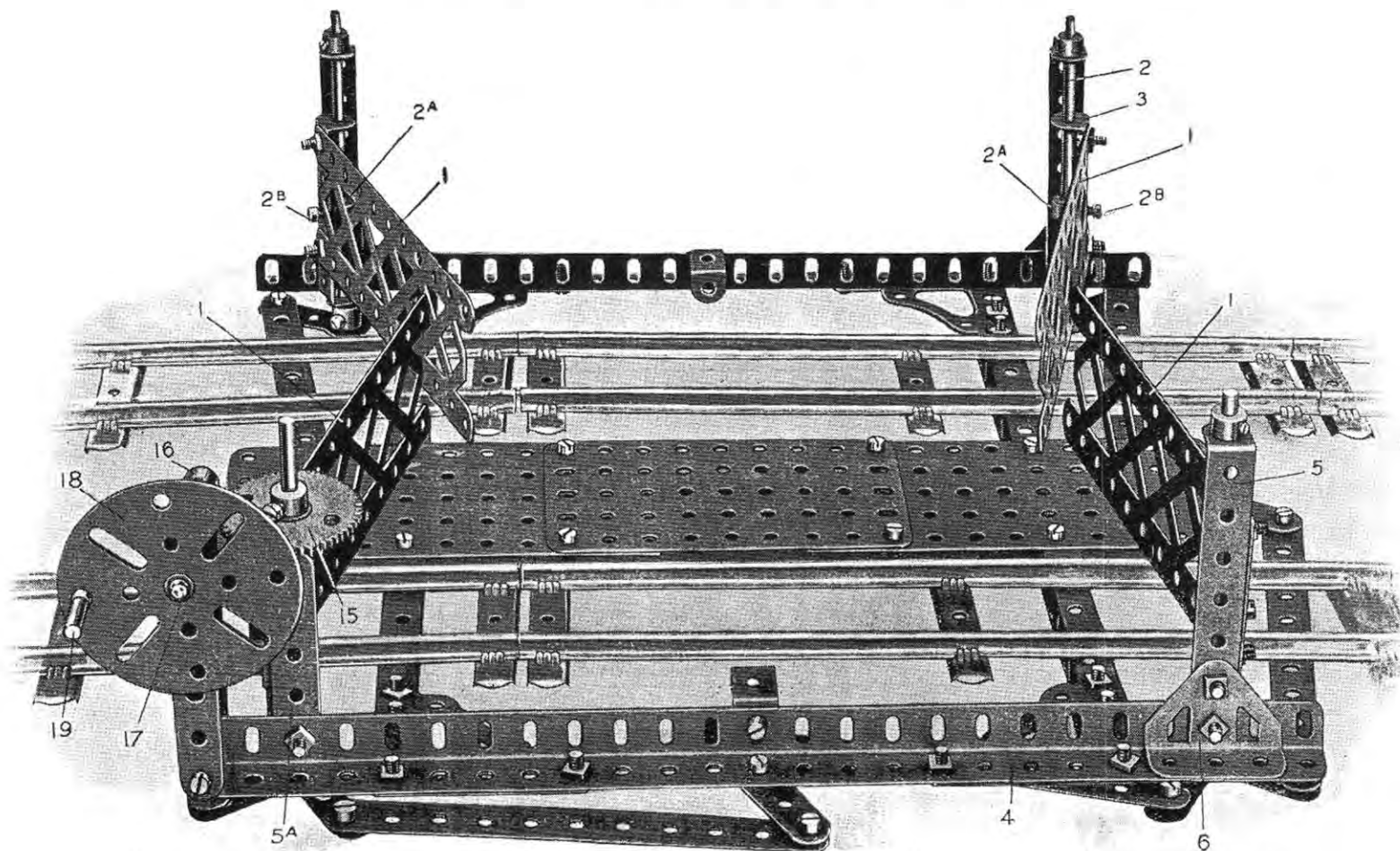
20 of No. 5	6 of No. 20	3 of No. 52
6 " " 8	2 " " 22	1 " " 53
8 " " 12	1 " " 26	2 " " 59
4 " " 16	1 " " 28	8 " " 60
	64 " " 37	

### HOW TO CONTINUE

This completes the Models which may be made with MECCANO Outfit No. 5. The next Models are a little more advanced, requiring a number of extra parts to construct them. The necessary parts are all contained in a No. 5A Accessory Outfit, the price of which will be found in the list at the end of the Manual.

This Model can be made with MECCANO Outfit No. 6, or No. 5 and No. 5A

## Model No. 601—Level Crossing Gates



## Model No. 601—Level Crossing Gates (continued)

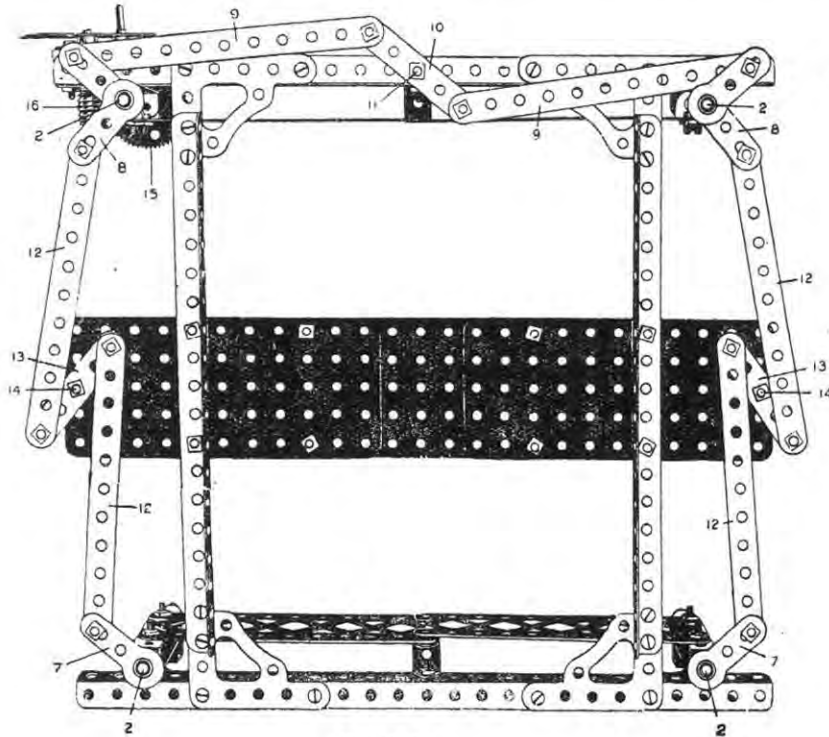


Fig. 601A

Parts  
required:

6 of No.	2
2 "	4
3 "	5
1 "	6A
2 "	8
2 "	8A
4 "	11
4 "	15A
1 "	17
1 "	27A
1 "	32
53 "	37
16 "	37A
1 "	53A
7 "	59
4 "	60
3 "	60B
2 "	62
3 "	70
4 "	100
4 "	108
1 "	109
1 "	115
3 "	126
2 "	128

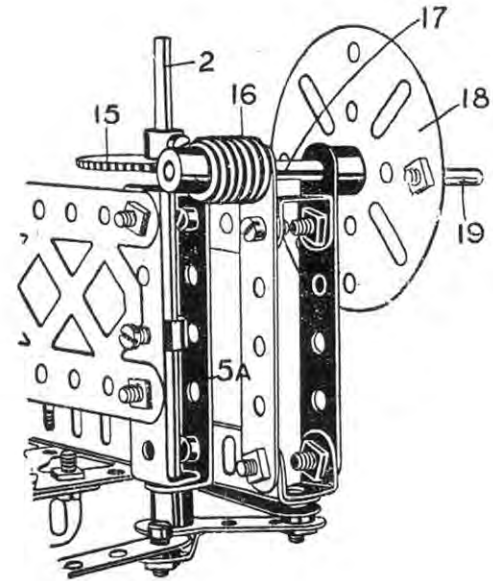
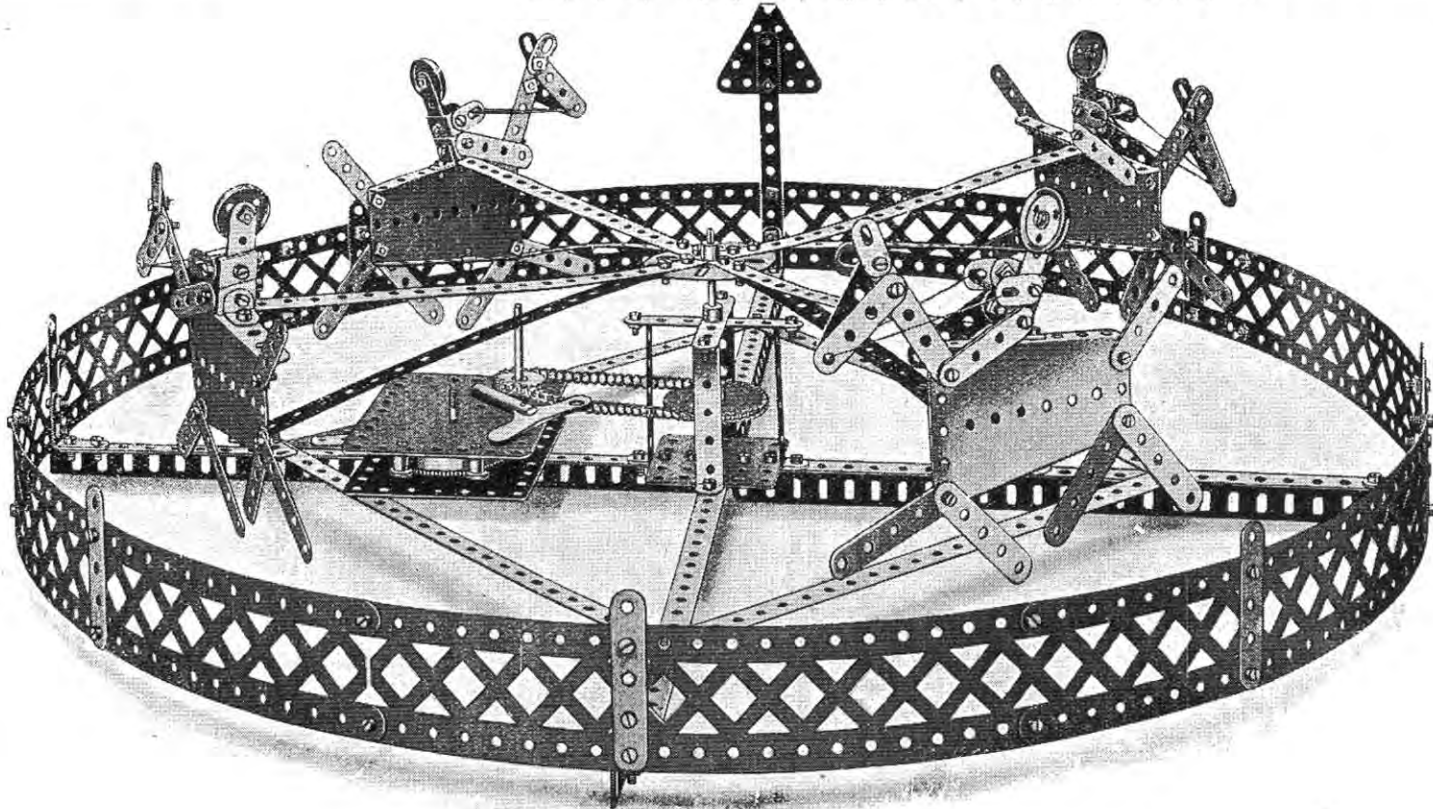


Fig. 601B

The gates consist of  $5\frac{1}{2}$ " braced girders 1 and are pivotally carried on the rods 2 being bolted to  $2\frac{1}{2}$ " by  $\frac{1}{2}$ " double angle strips 3. On each rod 2 is threaded a collar 2A, Fig. 601, and a bolt 2B is passed through the centre hole of the double angle strips 3 and screwed into the thread hole of the collar 2A, nipping the collar to the rod 2, thus ensuring that the braced girders 1 shall turn with the rods 2. Three of the rods 2 are carried from the lower angle girders 4 in  $3\frac{1}{2}$ " by  $\frac{1}{2}$ " double angle strips 5, and one in a  $2\frac{1}{4}$ " by  $\frac{1}{4}$ " double angle strip 5A, the feet of the strips 5 being reinforced to the angle girders 4 by the trunnions 6. The rods 2 are coupled together by cranks 7 on the rear rods, and bell cranks 8 on the other rods, the ends of the two bell cranks being connected by strips 9 to  $2\frac{1}{2}$ " strip 10 pivoted on the bolt 11, Fig. 601A, while the bell cranks 8 are connected to the cranks 7 by other strips 12, pivotally connected to  $2\frac{1}{2}$ " strips 13, pivoted on the bolts 14. Consequently, all the rods 2 are inter-connected. As will be seen from the Figs. 601 and 601B, a 56-toothed gear wheel 15 is secured on one of the rods 2, and is engaged by a worm 16 on a rod 17 to which is secured a face plate 18, fitted with a threaded pin 19, as an operating handle. By turning the face plate 18 the spindles 2 are all rotated, and the gates caused to open or close.

## Model No. 602 Roundabout

Parts required :					
12 of No. 1	24 of No. 6	4 of No. 12	135 of No. 37	1 of No. 72	1 of No. 96
1 " " 2	4 " " 8	4 " " 12A	4 " " 54	1 " " 76	7 " " 99
2 " " 3	16 " " 10	1 " " 15	2 " " 59	14 " " 94	1 " " 109
27 " " 5	8 " " 11	4 " " 22A	4 " " 60	1 " " 95	



In this model the animals, built up from sector plates and short strips to represent the limbs, are carried from  $9\frac{1}{2}$ " strips bolted to a face plate, which is rotated from the centre rod by means of a chain and a 1" sprocket wheel connected to the spring motor.

The centre rod, by means of which the rotating figures are driven, is supported below the face plate by a light framing to give rigidity.

The model is surrounded by braced girder strips bolted together, and strengthened by  $12\frac{1}{2}$ " cross angle girders, connected in the centre by a  $2\frac{1}{2}$ " by  $2\frac{1}{2}$ " flat plate. The centre hole of this plate carries the lower end of the vertical rod upon which the animals are mounted.

## Model No. 603—Portable Crane

Parts required :

14 of No. 2	5 of No. 17	1 of No. 33
2 " " 3	3 " " 18A	6 " " 35
4 " " 4	1 " " 19	85 " " 37
15 " " 5	1 " " 21	2 " " 38
2 " " 6	4 " " 22	1 " " 53
2 " " 9	4 " " 22A	1 " " 57
1 " " 11	1 " " 24	11 " " 59
17 " " 12	2 " " 26	4 " " 60
1 " " 15	1 " " 27A	2 " " 62
4 " " 16		2 " " 63

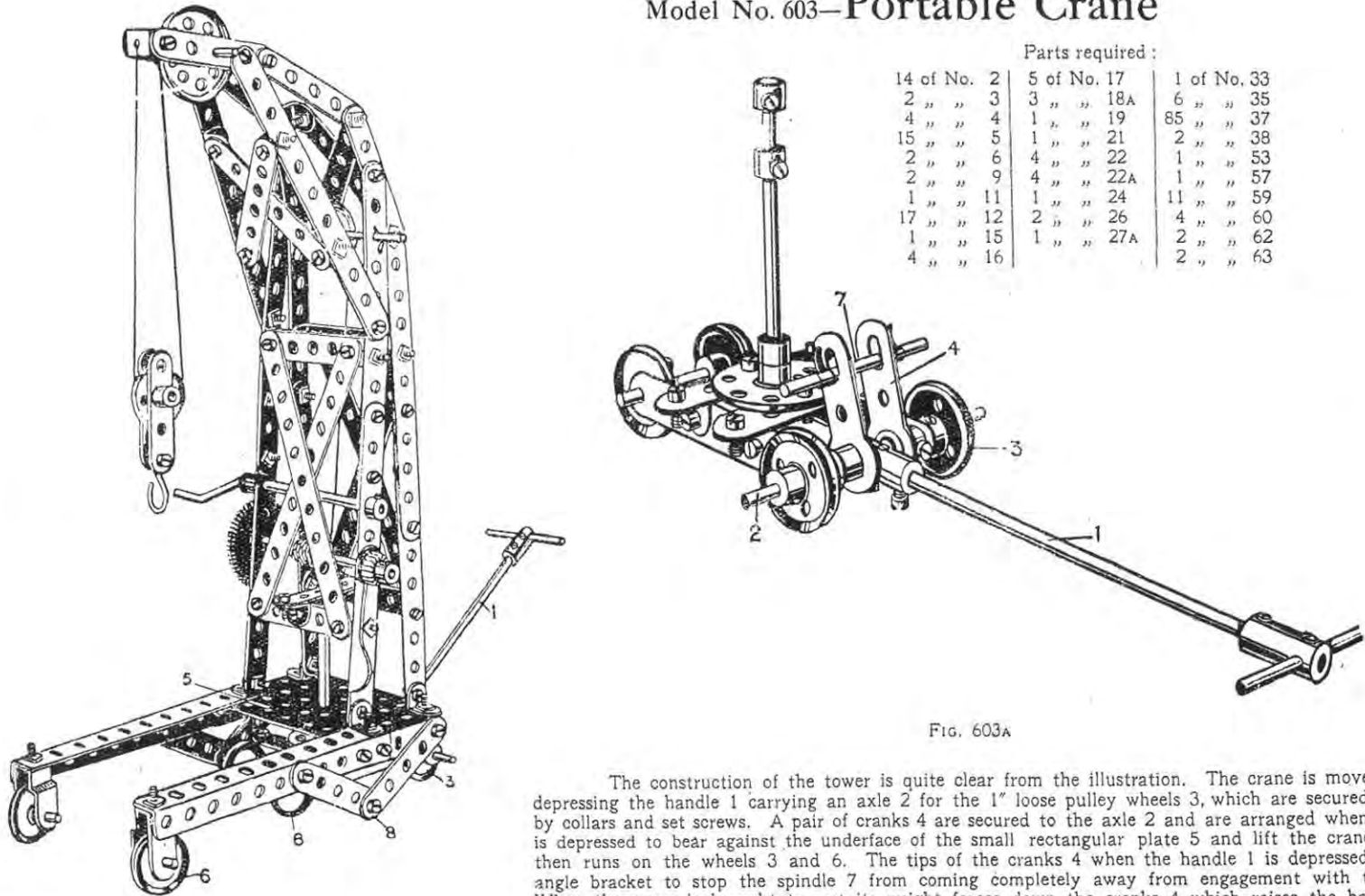
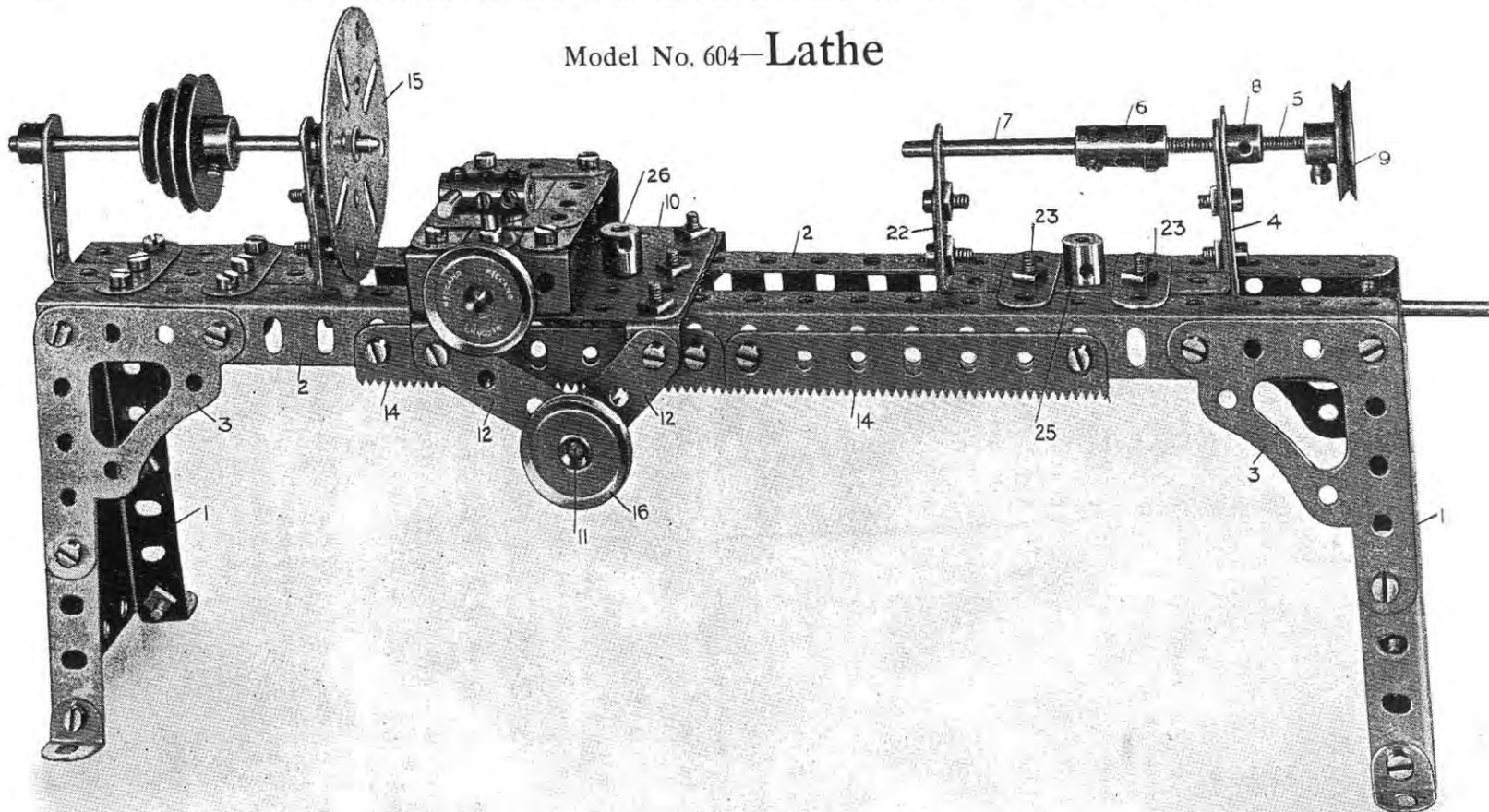


FIG. 603A

The construction of the tower is quite clear from the illustration. The crane is moved about by depressing the handle 1 carrying an axle 2 for the 1" loose pulley wheels 3, which are secured in position by collars and set screws. A pair of cranks 4 are secured to the axle 2 and are arranged when the handle is depressed to bear against the underface of the small rectangular plate 5 and lift the crane so that it then runs on the wheels 3 and 6. The tips of the cranks 4 when the handle 1 is depressed engage an angle bracket to stop the spindle 7 from coming completely away from engagement with the plate 5. When the crane is brought to rest its weight forces down the cranks 4 which raises the handle 1, and the tips 8 of the strips together with the front wheels 6 then support the crane.

### Model No. 604—Lathe



Parts required :

3 of No. 5	2 of No. 8	1 of No. 13	1 of No. 18	53 of No. 37	3 of No. 59	2 of No. 63	1 of No. 80A	1 of No. 109	1 of No. 115
3 " " 6	4 " " 11	2 " " 16	3 " " 22	3 " " 38	4 " " 60	3 " " 64	1 " " 81	2 " " 110	1 " " 123
14 " " 6A	4 " " 12	1 " " 17	1 " " 26	2 " " 54	1 " " 62A	1 " " 72	4 " " 108	2 " " 112	

## Model No. 604—Lathe (continued)

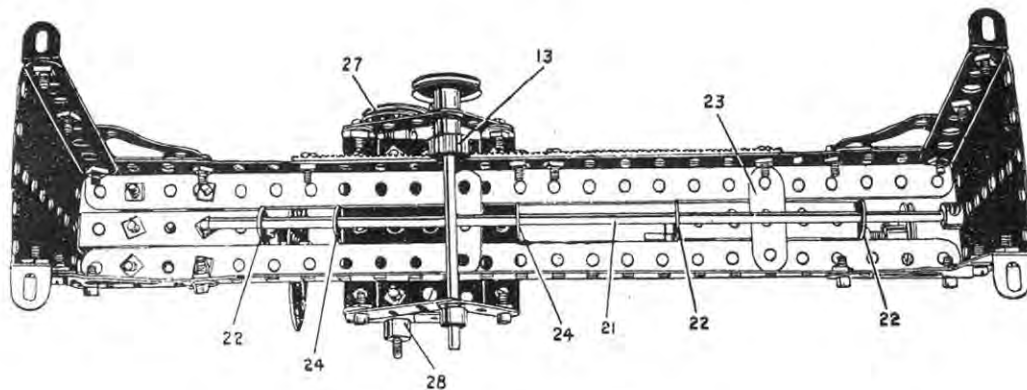


FIG. 604A

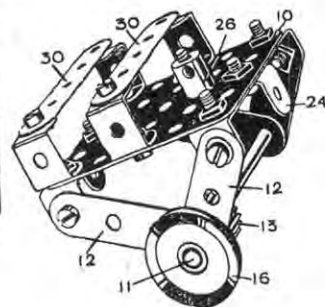


FIG. 604B

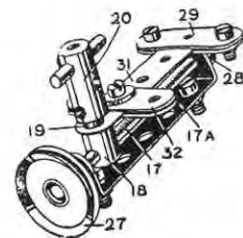


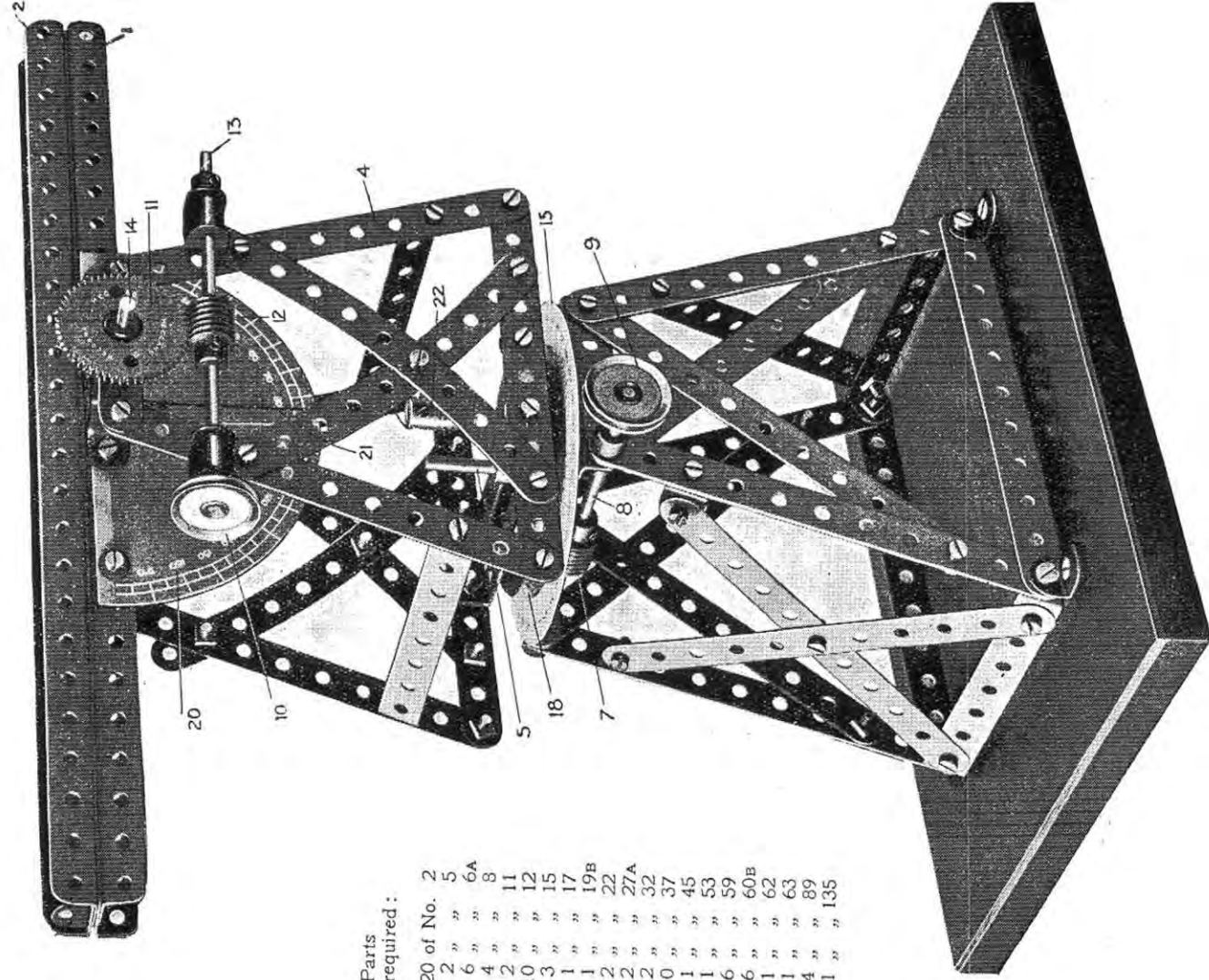
FIG. 604C

The lathe frame is built up from sector plates 1, at each end bolted to  $12\frac{1}{2}$ " angle girders 2, forming the bed, by means of architraves 3. The tail stock 4, slides between the angle girders 1, and has a screw adjustment 5, the screw of which is connected by the threaded coupling 6 to the rod 7; the screw 5 is threaded into a threaded crank 8, and is operated by the 1" pulley wheel 9. The tail stock is locked by turning the threaded boss 25, which engages the bolt holding the underneath cross strip 23, thus gripping it beneath the lathe bed. The saddle 10, consisting of a  $2\frac{1}{2}$ " by  $2\frac{1}{2}$ " flat plate, carries the rod 11, journalled in the strips 12, and carries a pinion 13, Fig. 604B, which engages the racks 14, so that the saddle may be moved to or from the face plate 15, by turning the pulley wheel 16. The traversing movement is obtained by means of the screw 17, which engages a threaded boss 18, into the end of which is screwed a threaded pin 19, carrying the coupling 20, which forms the tool post. The saddle is locked by the threaded boss 26, similar to the tail stock. The screwed rod 17, is held against end movement in the  $2\frac{1}{2}$ " by  $\frac{1}{2}$ " bent strip 17A, by the pulley wheel 27 at one side and the collar 28 on the other.

The construction of the saddle is shown in Figs. 604B and 604C, where the  $1\frac{1}{2}$ " strips 29, of Fig. 604C are shown removed from Fig. 604B; these strips 29, are bolted at the end of the guide strips 30, Fig. 604B, and form guides for the  $2\frac{1}{2}$ " strip 31, carrying the tool post. They are spaced apart by the thickness of the strips 30, and the  $1\frac{1}{2}$ " strips 32, bolted to the strip 31, slide on the strips 30. As will be seen from the underneath view, Fig. 604A, a guide rod 21, is fixed beneath the bed plates, and is engaged by the end holes of the  $1\frac{1}{2}$ " strips 22, secured to the sides of the head and tail stocks;  $1\frac{1}{2}$ " strips 23, being bolted above and below to retain the tail-stock in position. The saddle engages the rod 21 by means of a  $2\frac{1}{2}$ " by  $\frac{1}{2}$ " double angle strip 24.

This Model can be made with MECCANO Outfit No. 6, or No. 5 and No. 5A

## Model No. 605—Theodolite



Parts required :

20 of No.	2
2 "	5
6 "	6A
4 "	8
2 "	11
10 "	12
3 "	15
1 "	17
1 "	19B
2 "	22
2 "	27A
2 "	32
60 "	37
1 "	45
1 "	53
6 "	59
6 "	60B
1 "	62
1 "	63
4 "	89
1 "	135



## Model No. 605—Theodolite (continued)

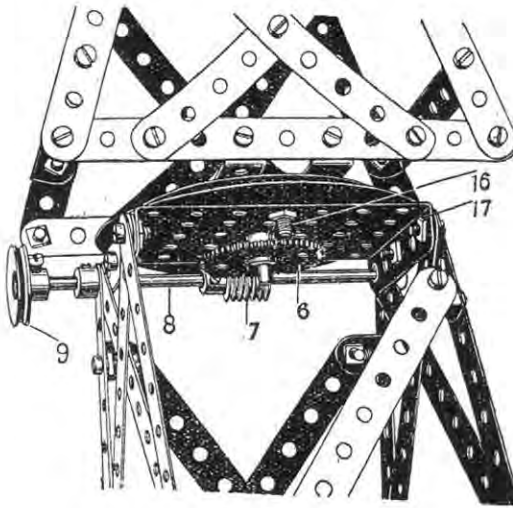


FIG. 605A

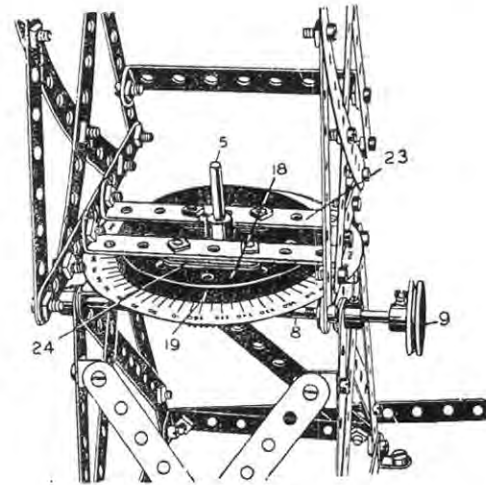


FIG. 605B

The Theodolite is represented by two reverse pairs of angle girders 1 and 2, which form a "sighting arm," an angle bracket 3 being bolted at one end to form an eye piece. A small piece of gummed paper is fastened over the aperture in the angle bracket, and a fine pin-hole made in the paper at the centre of the aperture. Two crossed threads are gummed across the aperture of the angle bracket bolted at the other end of the sighting arm.

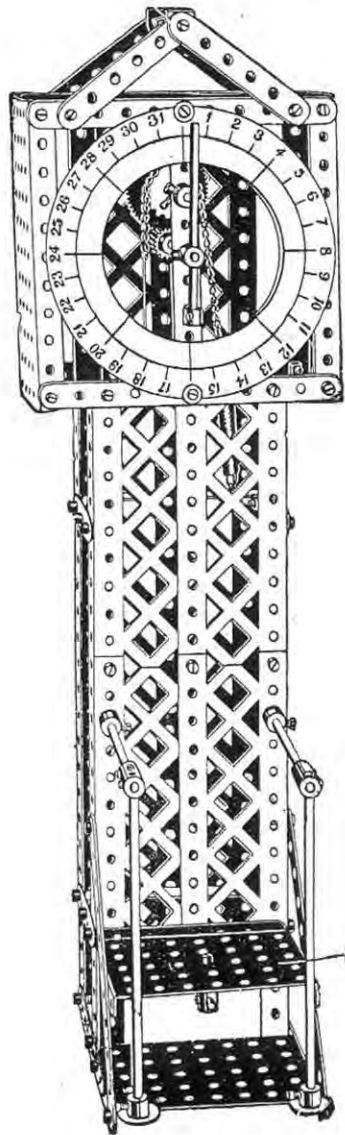
The upper framework 4 swivels horizontally with the vertical spindle 5 as a pivot. On the lower end of this rod is a gear wheel 6, Fig. 605A, engaged by a worm 7 on a rod 8, operated by the 1" pulley 9. This gives the horizontal traverse of the upper frame 4, in which the sighting arm is pivotally mounted upon a rod 14, on which is a gear wheel 11 engaged by a worm 12 on a rod 13 operated by a 1" pulley 10. This mechanism gives the vertical traverse or inclination of the sighting arm.

A protractor for the horizontal angular movement of the upper frame 4 consists of a graduated cardboard disc 15, which is bolted by a bolt 16 to a perforated flanged plate  $3\frac{1}{2}$ " by  $2\frac{1}{4}$ " 17, the head of the bolt 16 being above the cardboard disc, and beneath the 3" pulley wheel 18. The cardboard disc is thus held against movement by the bolt 16, its centre hole engaging round the pivot rod 5. An index mark or pointer 19 is made on the pulley wheel 18. The movement of this pointer round the graduated scale on the disc shows the horizontal angular traverse.

Similarly, the vertical traverse of the sighting arm is indicated by means of a semi-circular protractor 20, bolted to the lower angle girder 1 of the sighting arm, a cord 21 carrying a weight 22, being hung from the rod 14, the position of the thread 21 over the protractor 20 indicating the vertical angular adjustment of the sighting arm. The thread 21 has a loop by which it is hung on the rod 14, so that its direction always points truly radially to the rod 14, and this gives the correct angular reading. In order to bring the double angle strips 23 flush with the outer rim of the pulley wheel 18, three  $1\frac{1}{2}$ " packing strips 24 are bolted beneath the double angle strips, as shown in Fig. 605B.

The sighting arm is secured to the rod 14 by a crank bolted to the arm on the opposite side to the protractor and nipped by the set screw to the rod 14.

## Model No. 606—Automatic Weighing Machine



### Parts required :

9 of No. 2	61 of No. 37
4 " " 3	6" " " 42
4 " " 4	1 " " 43
4 " " 5	2 " " 52
4 " " 8	2 " " 53
4 " " 12	6 " " 59
1 " " 13	1 " " 60
2 " " 15A	2 " " 62
4 " " 16	3 " " 63
1 " " 24	1 " " 96
1 " " 26	2 " " 99
1 " " 27	6 " " 100

The platform 1 is connected by cross rod and coupling 2A to a rod 2 passing up the centre of the machine and guided in  $3\frac{1}{2}$ " strips 3 connected to side strips 4. At the upper end of this rod 2 is a bush wheel 5, to which is connected a cord 6 and chain 7 which passes round the sprocket wheel 8 on the spindle of which is a gear wheel 9 engaging a pinion 10 on the spindle 12 carrying the pointer 13. The other end of the chain is coupled by a spring 14 to the frame, and the pointer is thus always returned to zero.

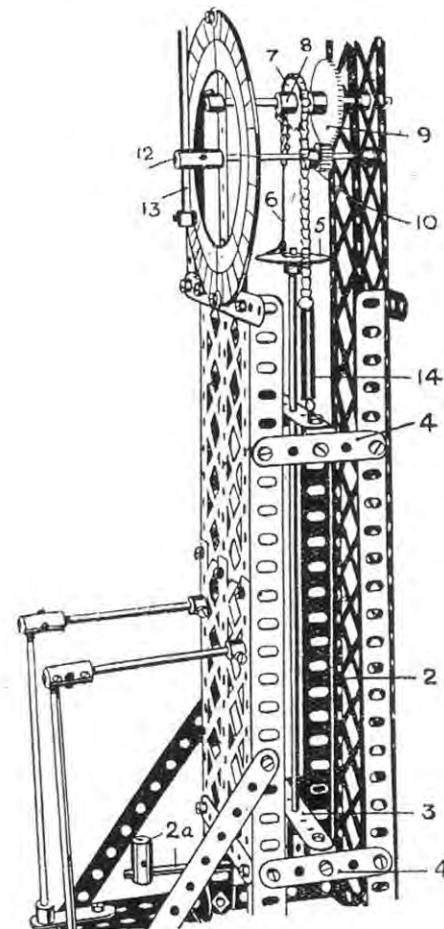
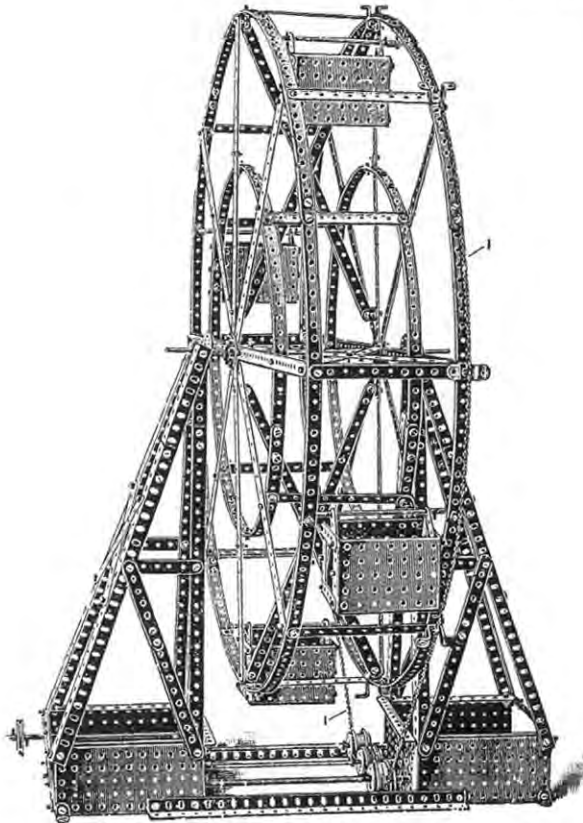


Fig. 606A

## Model No 607—Big Wheel



Parts  
required:

46 of No.	1
24 " "	2
4 " "	3
4 " "	4
35 " "	5
10 " "	8
4 " "	9
8 " "	11
68 " "	12
5 " "	13
1 " "	14
4 " "	15
6 " "	20
1 " "	21
4 " "	24
2 " "	25
2 " "	27A
12 " "	35
292 " "	37
6 " "	52
8 " "	53
2 " "	54
4 " "	59
7 " "	94

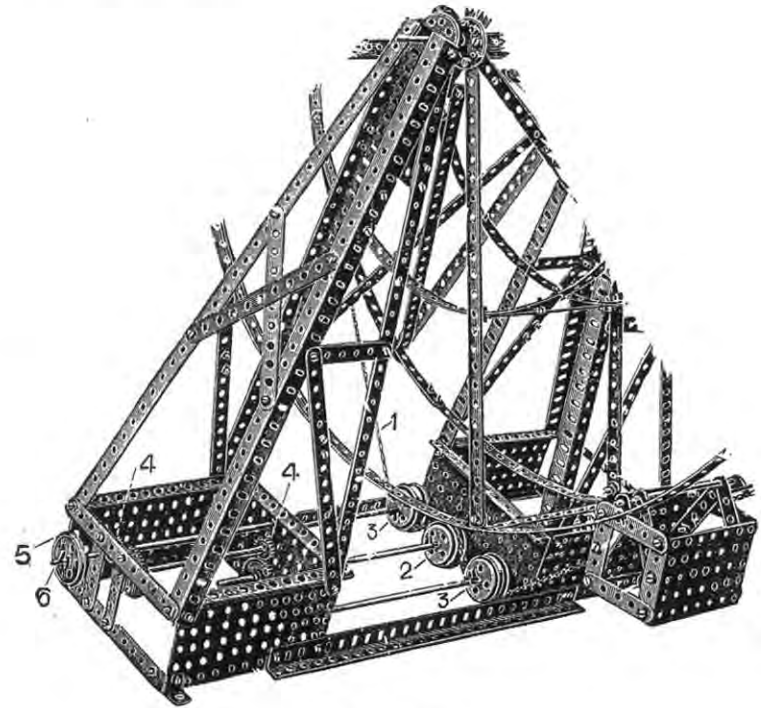


FIG. 607A

In constructing this model flanged plates are used to form the sides and inner part of the base of the side pedestals and also to form the suspended cages on the wheel.

The driving chain is conveniently kept in position round the periphery of one of the side elements of the wheel by a series of double angle brackets bolted on the ends of the spokes.

In Fig. 607A is shown how the driving chain 1, passing round the driving wheel 2, is held around the circumference thereof by the guide wheels 3. The driving wheel 2 is driven through the gear wheel 4 from a  $1\frac{1}{2}$ " pulley wheel 5 carried on the spindle 6.

A sprocket chain may also be used for driving the model from a sprocket wheel on the main shaft.

### Model No. 608—Steam Shovel

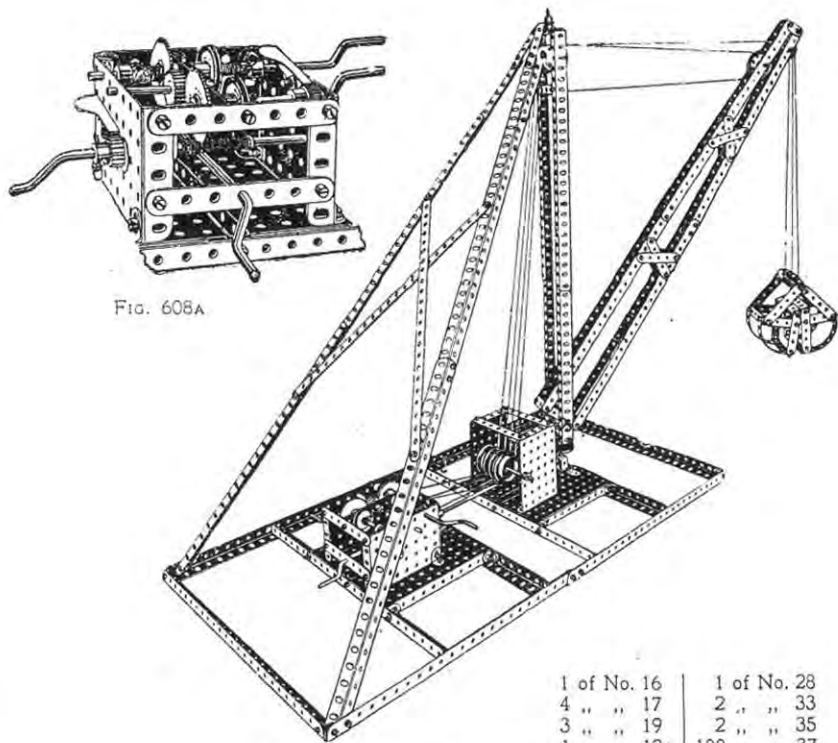
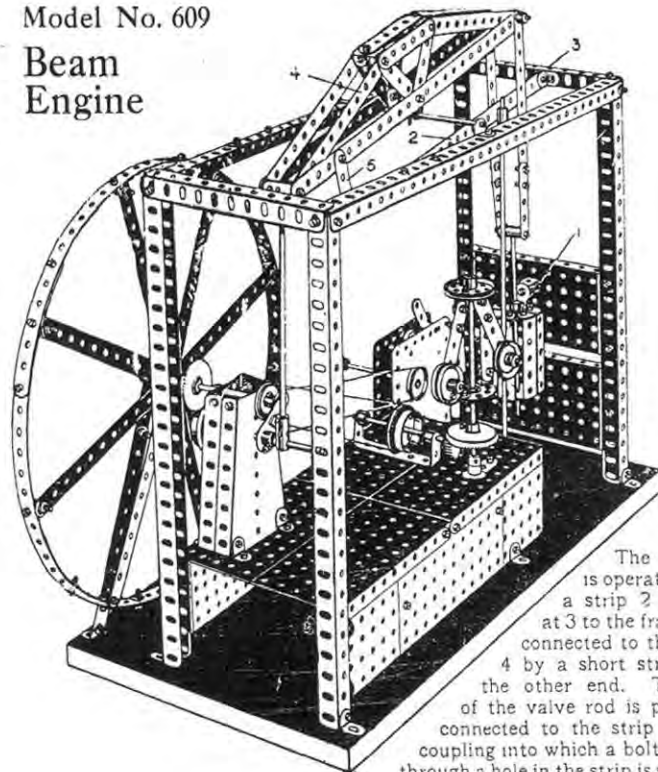


FIG. 608A

Parts required:		1 of No. 16	1 of No. 28
10 of No. 1	18 of No. 8	4 " " 17	2 " " 33
12 " " 3	2 " " 9	3 " " 19	2 " " 35
4 " " 4	3 " " 10	1 " " 19A	188 " " 37
16 " " 5	2 " " 11	8 " " 20	2 " " 45
4 " " 6	28 " " 12	1 " " 21	3 " " 46
	1 " " 13	2 " " 22	4 " " 52
		3 " " 22A	4 " " 53
		2 " " 24	11 " " 59
		4 " " 26	6 " " 60
		2 " " 27	1 " " 63

### Model No. 609 Beam Engine



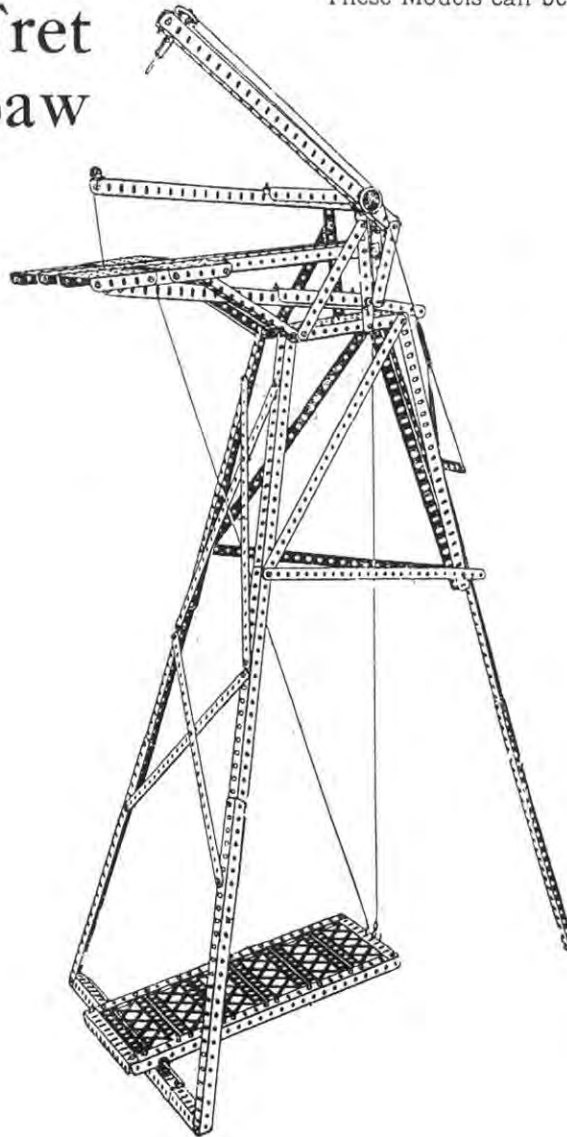
The valve 1 is operated from a strip 2 pivoted at 3 to the frame and connected to the beam. 4 by a short strip 5 at the other end. The top of the valve rod is pivotally connected to the strip 2 by a coupling into which a bolt passing through a hole in the strip is screwed.

Parts required:			
7 of No. 1	27 of No. 12	2 of No. 21	1 of No. 50
18 " " 2	1 " " 13	5 " " 22	7 " " 52
3 " " 4	1 " " 13A	2 " " 23	4 " " 53
10 " " 5	1 " " 14	4 " " 24	2 " " 54
1 " " 6	3 " " 15	2 " " 26	7 " " 59
8 " " 8	1 " " 16	1 " " 27	6 " " 60
4 " " 9	2 " " 17	1 " " 28	3 " " 62
6 " " 10	2 " " 18A	149 " " 37	5 " " 63
4 " " 11	2 " " 20	1 " " 46	Clockwork Motor

# Model No. 610 Fret Saw

Parts  
required :

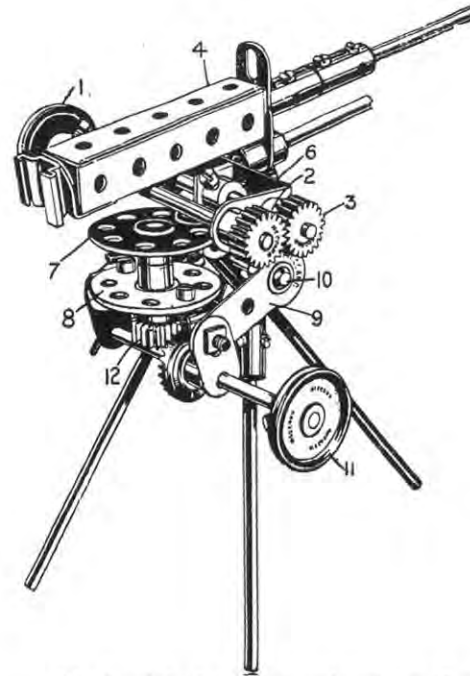
8 of No.	1
6 " "	2
3 " "	3
1 " "	4
1 " "	5
20 " "	8
4 " "	9
2 " "	10
3 " "	12
1 " "	13A
2 " "	15A
1 " "	16
1 " "	22
2 " "	22A
3 " "	37
2 " "	43
2 " "	52
4 " "	53
2 " "	54
2 " "	57
4 " "	59
1 " "	63
6 " "	100



# Model No. 611 Maxim Gun

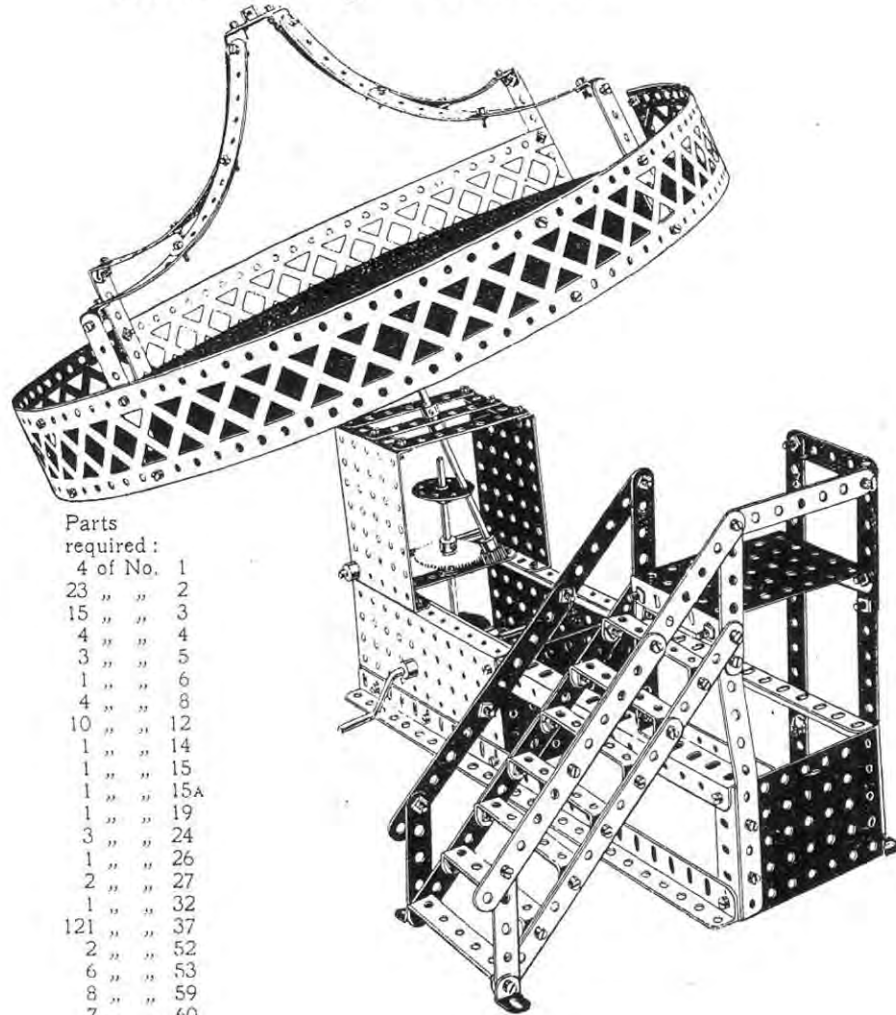
Parts  
required :

4 of No.	10
1 " "	11
5 " "	12
2 " "	15
2 " "	15A
3 " "	16
1 " "	17
1 " "	18A
2 " "	22
2 " "	24
3 " "	26
1 " "	29
1 " "	35
9 " "	37
1 " "	46
1 " "	50
5 " "	59
2 " "	62
5 " "	63



The handwheel 1 operates the pinions 2 and 3; on the spindle of the latter the gun frame 4 is mounted, movement of the wheel 1 elevating the gun. The double bent strip 6 is bolted by an angle bracket to the upper bush wheel 7, the spindle of which passes loosely through the lower bush wheel 8, which is bolted by angle brackets to the cranks 9, a rod 10 joining the cranks to which the front leg of the tripod is secured, the other legs being bolted to a pair of angle brackets secured to a coupling at the top of the front leg. The gun is swivelled horizontally by means of the handwheel 11, on the spindle of which is the contrate wheel engaging the pinion 12 on the spindle of the bush wheel 7.

## Model No. 612 Joy Wheel

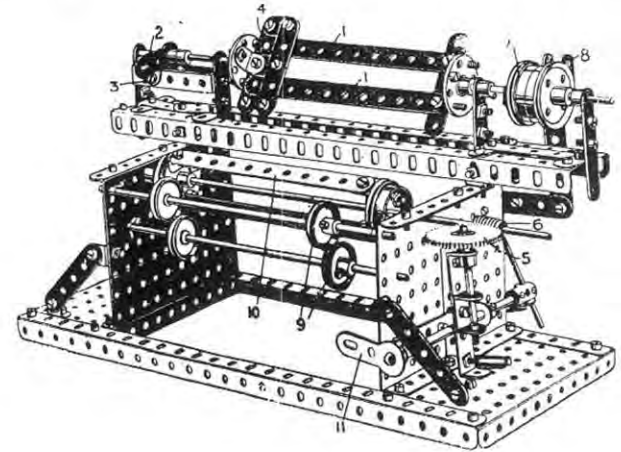


Parts

required :

4 of No.	1
23 "	2
15 "	3
4 "	4
3 "	5
1 "	6
4 "	8
10 "	12
1 "	14
1 "	15
1 "	15A
1 "	19
3 "	24
1 "	26
2 "	27
1 "	32
121 "	37
2 "	52
6 "	53
8 "	59
7 "	60
4 "	99

## Model No. 613 Linen Winder



Parts required :

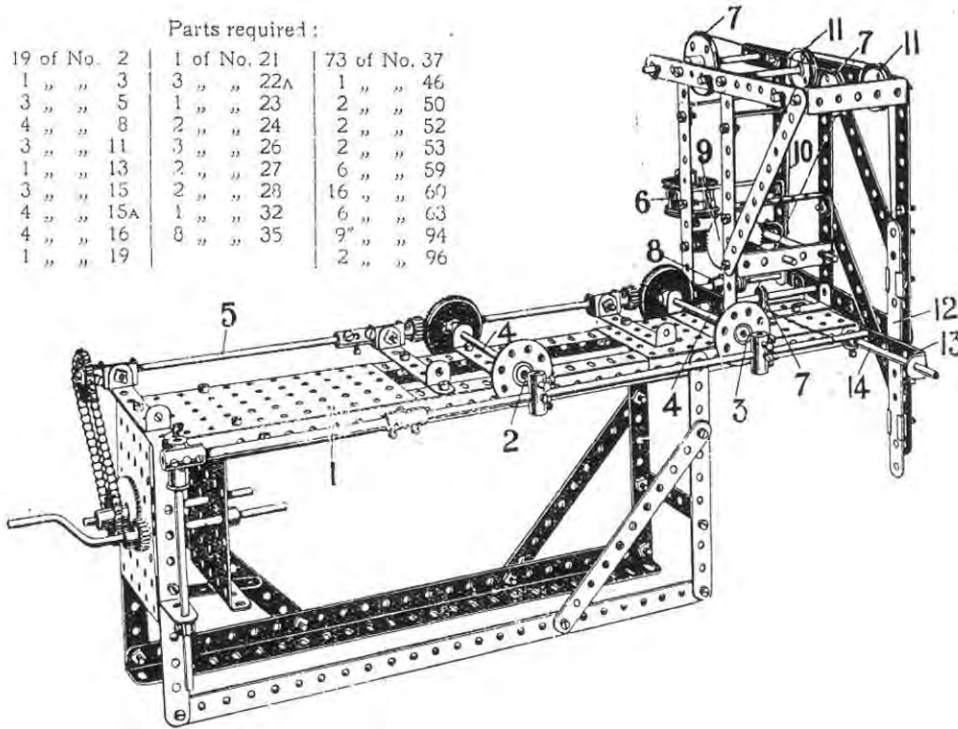
6 of No.	2	1 of No.	15	94 of No.	37
2 "	3	3 "	16	1 "	43
12 "	5	1 "	17	1 "	44
4 "	8	4 "	20	2 "	46
11 "	10	4 "	22	2 "	52
2 "	11	2 "	24	7 "	59
16 "	12	1 "	27	3 "	60
1 "	13	1 "	32	2 "	62
2 "	13A	5 "	35	1 "	63

In order to disengage the winding frame bars 1 the crank 2 is lifted clear of the stop 3 and drawn back, this action disengaging the end cross strips 4 from the tips of the frame bars 1 and permitting the wound linen to be removed. The gear wheel 5 engaging the worm 6 forms a counter. 7 are the bell pulleys, and 8 the bell striker operated by crank 11; 9 are the guide pulleys for the main linen drums 10.

## Model No. 614--Profiling Machine

Parts required:

19 of No. 2	1 of No. 21	73 of No. 37
1 " " 3	3 " " 22A	1 " " 46
3 " " 5	1 " " 23	2 " " 50
4 " " 8	2 " " 24	2 " " 52
3 " " 11	3 " " 26	2 " " 53
1 " " 13	2 " " 27	6 " " 59
3 " " 15	2 " " 28	16 " " 60
4 " " 15A	1 " " 32	6 " " 63
4 " " 16	8 " " 35	9 " " 94
1 " " 19		2 " " 96

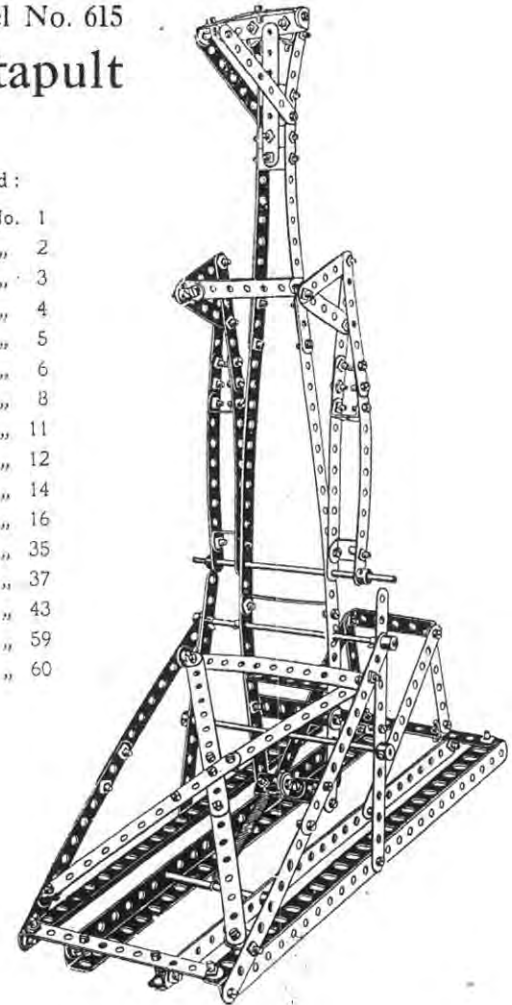


The side shaft 1 carries the follower tool 2 of the medal to be copied, and the cutting tool 3 for the work. The copy and work are rotated by the shafts 4 from the driving shaft 5, and resilient pressure is imparted to the cutting tool 3 by means of a weight 6, the cord of which passes over pulley 7 and is connected to shaft 1. The vertical traverse of the tool is effected by the worm 8 engaging the spur wheel 9, a cord winding on its spindle and passing over pulleys 11 and being connected to the girder strip 12 bolted to the double bent strip 13, which forms a bearing for a rod 14 on which the end of the shaft 1 rests.

## Model No. 615 Catapult

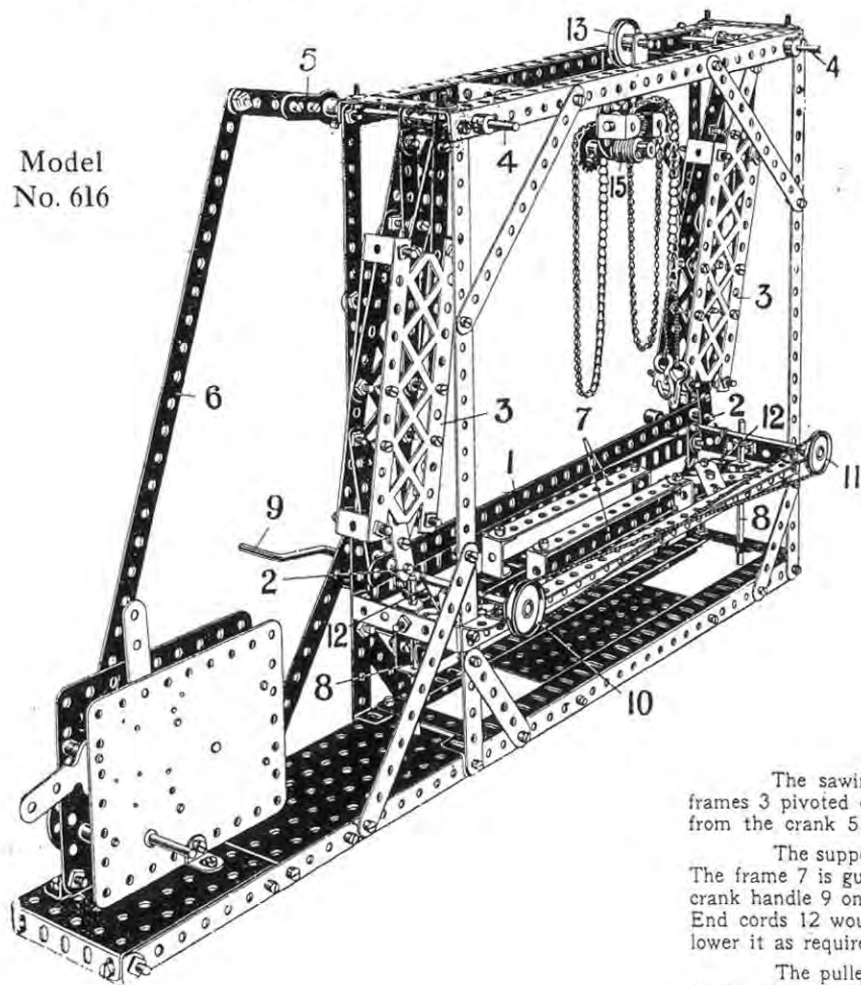
Parts  
required:

2 of No. 1
21 " " 2
12 " " 3
2 " " 4
4 " " 5
1 " " 6
4 " " 8
8 " " 11
19 " " 12
3 " " 14
1 " " 16
4 " " 35
98 " " 37
1 " " 43
8 " " 59
4 " " 60



# Stone Sawing Machine

Model  
No. 616

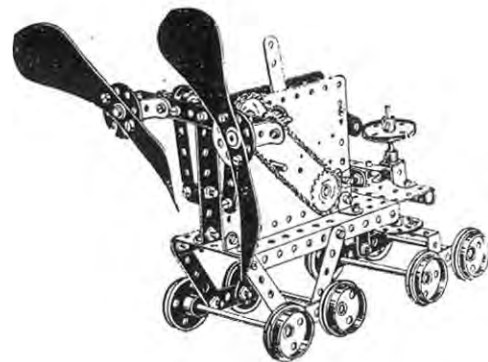


Parts  
required :

6 of No.	1
14 "	2
4 "	3
12 "	4
13 "	5
8 "	8
16 "	11
9 "	12
1 "	14
3 "	15A
2 "	16
2 "	17
1 "	19
3 "	22
2 "	24
1 "	26
1 "	32
6 "	35
126 "	37
1 "	44
2 "	52
1 "	53
2 "	57
10 "	59
4 "	60
2 "	62
2 "	63
2 "	94
2 "	96
4 "	100

Clockwork Motor

# Model No. 617—Velocipede



Parts required :

1 of No.	2	2 of No.	17	3 of No.	45
1 "	4	8 "	20	1 "	46
10 "	5	3 "	24	1 "	52
10 "	12	2 "	26	1 "	53
2 "	15A	2 "	29	2 "	59
4 "	16	47 "	37	2 "	96
		4 "	41		

Clockwork Motor

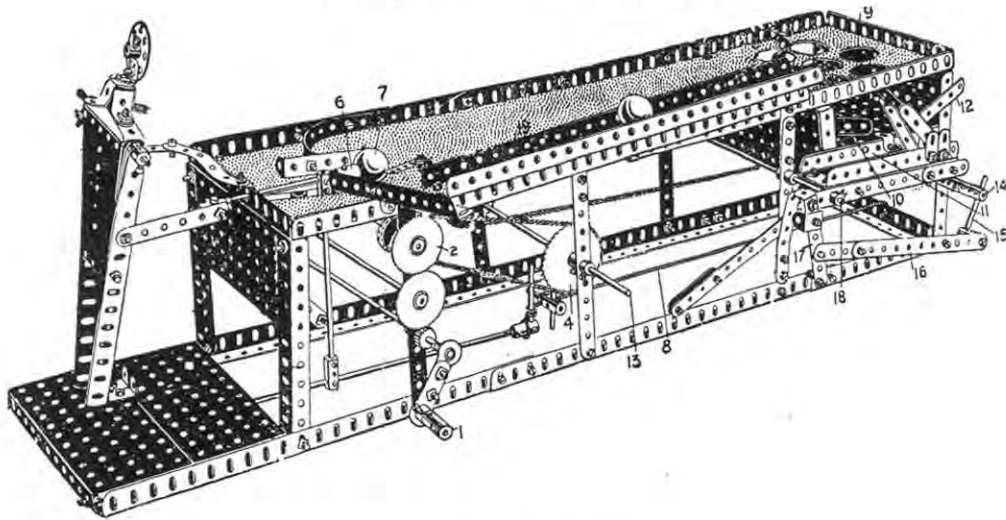
The sawing strip 1 is carried from the short rods 2 in the ends of the swinging frames 3 pivoted on the rods 4 carried in the frame. These swinging frames 3 are oscillated from the crank 5 and connecting rod 6 driven by the motor.

The support frame 7 for the stone blocks to be sawn is raised and lowered as follows: The frame 7 is guided on the vertical rods 8 and raised and lowered by the operation of the crank handle 9 on the end of which is a pulley 10 connected by a cord to another pulley 11. End cords 12 wound on the pulley axles are connected to the support frame 7 and raise or lower it as required.

The pulley block runs upon a rod supported by two 2½" bent strips across the upper framework, the top pulley 13 being carried in a cranked bent strip bolted by an angle bracket to the upper hole of a bush wheel, which forms the framework of the pulley block, two double brackets forming the bearings of a rod on which is the pinion 14 engaged by the worm 15.



## Model No. 618—Bagatelle

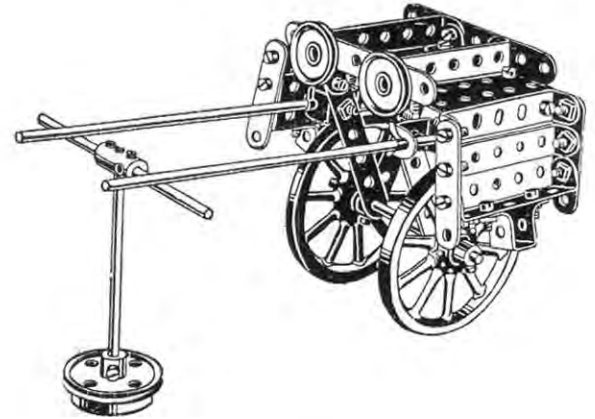


### Parts required :

1 of No. 1	12 of No. 8	1 of No. 13	1 of No. 18A	2 of No. 45	4 of No. 60
12 " " 2	16 " " 9	4 " " 13A	1 " " 24	7 " " 52	2 " " 62
4 " " 4	9 " " 10	3 " " 14	1 " " 26	2 " " 54	9 " " 63
3 " " 5	3 " " 11	1 " " 15A	2 " " 27A	1 " " 58	3 " " 95
10 " " 6	12 " " 12	2 " " 17	137 " " 37	11 " " 59	1 " " 96

The operating handle 1 drives the gear wheel 2, a sprocket wheel on the spindle being coupled to a sprocket wheel 4. The spindle 5 of this carries a crank made by short rods and coupling, which crank engages at each revolution and pushes back a pusher-bar 6 by means of which the ball is driven forward. A spring cord 8 returns the pusher-rod. After the ball is driven forward, it drops down one of the holes 9 and is led by the guides into the lifting pocket. The ball is held back by a pivoted strip 12 which is caught and pulled down as the pocket 11 descends, permitting the ball to fall out. The pocket is raised by a chain passing over a 2" sprocket at the opposite end of rod 13, which is coupled to another 2" sprocket on spindle 14, which latter carries a rod 15 arranged as a crank coupled by strips 16 to an arm 17 on the pivot 18 of the lifting pocket 11. The ball is lifted by the pocket and deposited into the chute 19, by which it is returned to the pusher-arm 6.

## Model No. 619 Jaunting Car



### Parts required :

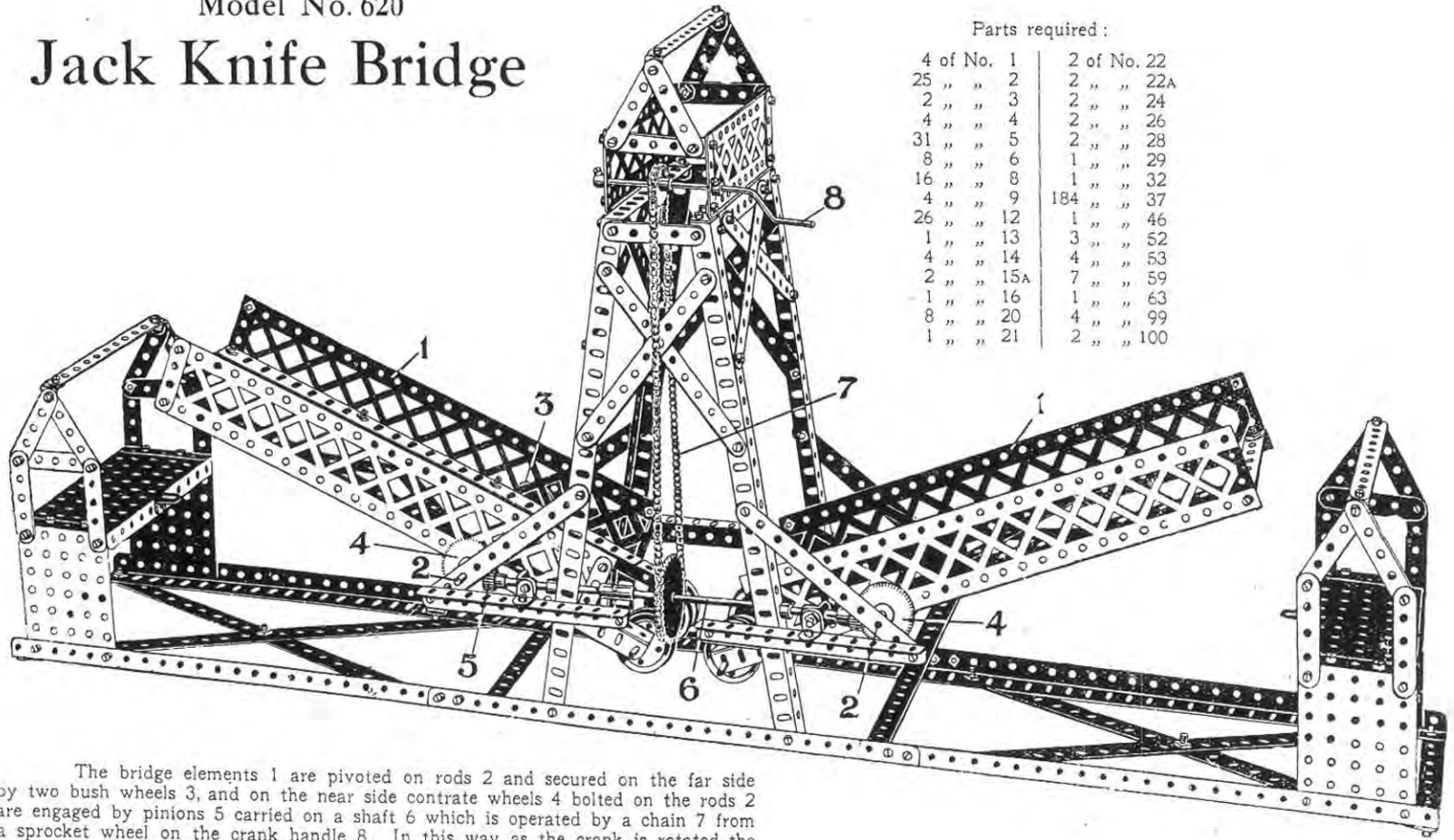
2 of No. 3	1 of No. 20
4 " " 4	2 " " 22
4 " " 6	4 " " 35
14 " " 12	40 " " 37
2 " " 13A	2 " " 45
1 " " 15	1 " " 53
1 " " 16	4 " " 59
2 " " 17	8 " " 60
2 " " 19A	1 " " 63

## Model No. 620

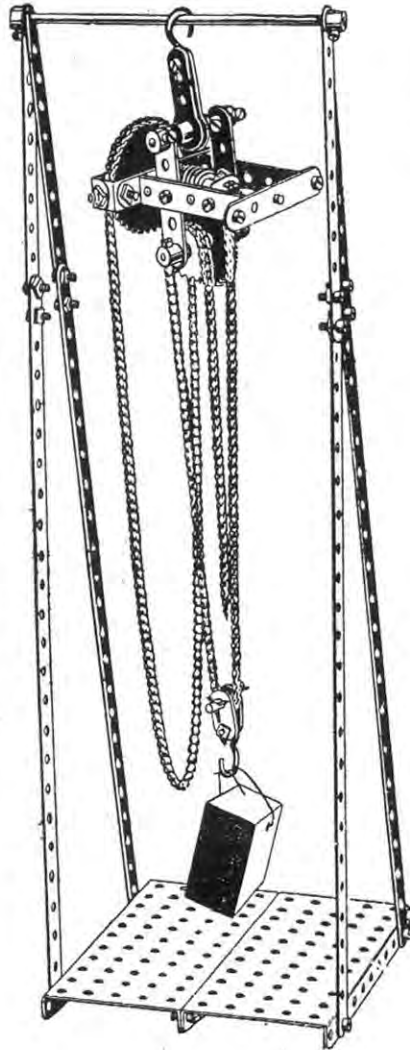
# Jack Knife Bridge

Parts required :

4 of No.	1	2 of No.	22
25 "	2	2 "	22A
2 "	3	2 "	24
4 "	4	2 "	26
31 "	5	2 "	28
8 "	6	1 "	29
16 "	8	1 "	32
4 "	9	184 "	37
26 "	12	1 "	46
1 "	13	3 "	52
4 "	14	4 "	53
2 "	15A	7 "	59
1 "	16	1 "	63
8 "	20	4 "	99
1 "	21	2 "	100



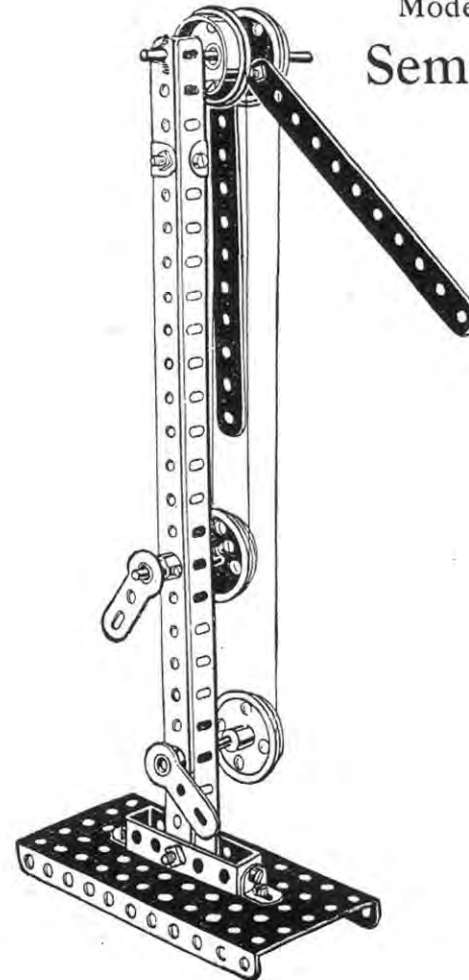
The bridge elements 1 are pivoted on rods 2 and secured on the far side by two bush wheels 3, and on the near side conrate wheels 4 bolted on the rods 2 are engaged by pinions 5 carried on a shaft 6 which is operated by a chain 7 from a sprocket wheel on the crank handle 8. In this way as the crank is rotated the shaft 6 swings the bridge elements 1 simultaneously.



Model No. 621  
Purchase  
Block

Parts  
required :

4 of No.	1
4 " "	2
3 " "	5
2 " "	10
1 " "	12
1 " "	15
1 " "	16
2 " "	17
1 " "	18 <sup>A</sup>
1 " "	27 <sup>A</sup>
1 " "	32
2 " "	35
23 " "	37
2 " "	52
2 " "	57
7 " "	59
4 " "	60
2 " "	62
4 " "	94
1 " "	95
1 " "	96



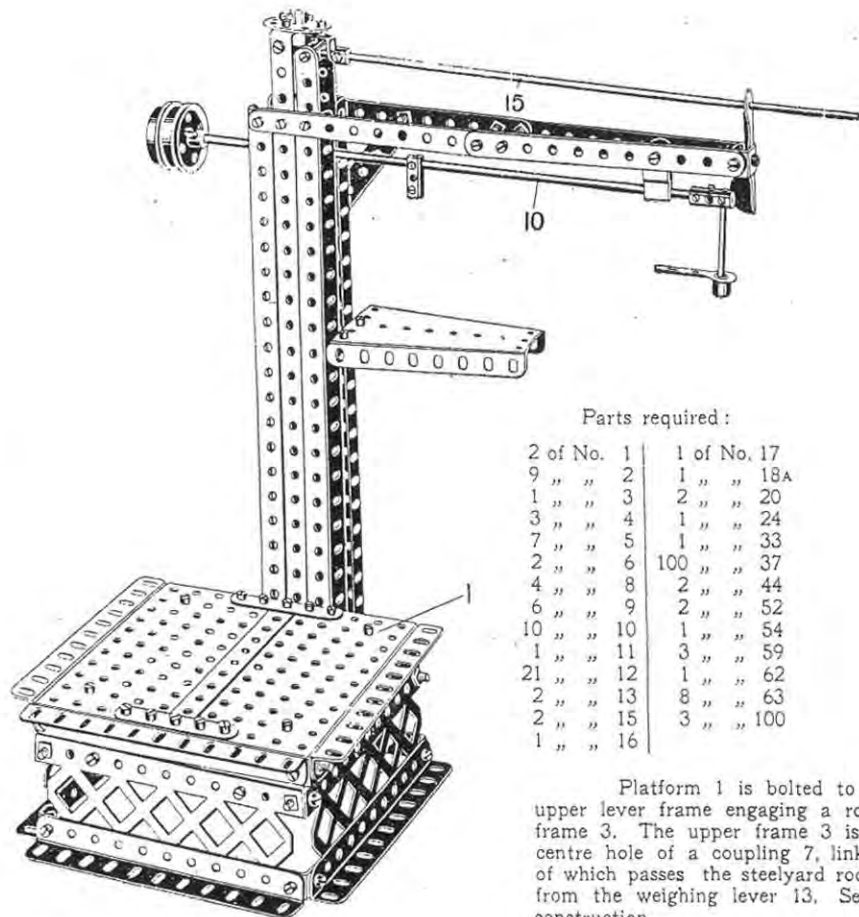
Model No. 622  
Semaphore

Parts  
required :

2 of No.	2
2 " "	8
4 " "	12
1 " "	16
2 " "	17
4 " "	20
9 " "	37
1 " "	52
1 " "	59
2 " "	60
2 " "	62

## Model No. 623

# Platform Scales



### Parts required:

2 of No. 1	1 of No. 17
9 " " 2	1 " " 18A
1 " " 3	2 " " 20
3 " " 4	1 " " 24
7 " " 5	1 " " 33
2 " " 6	100 " " 37
4 " " 8	2 " " 44
6 " " 9	2 " " 52
10 " " 10	1 " " 54
1 " " 11	3 " " 59
21 " " 12	1 " " 62
2 " " 13	8 " " 63
2 " " 15	3 " " 100
1 " " 16	

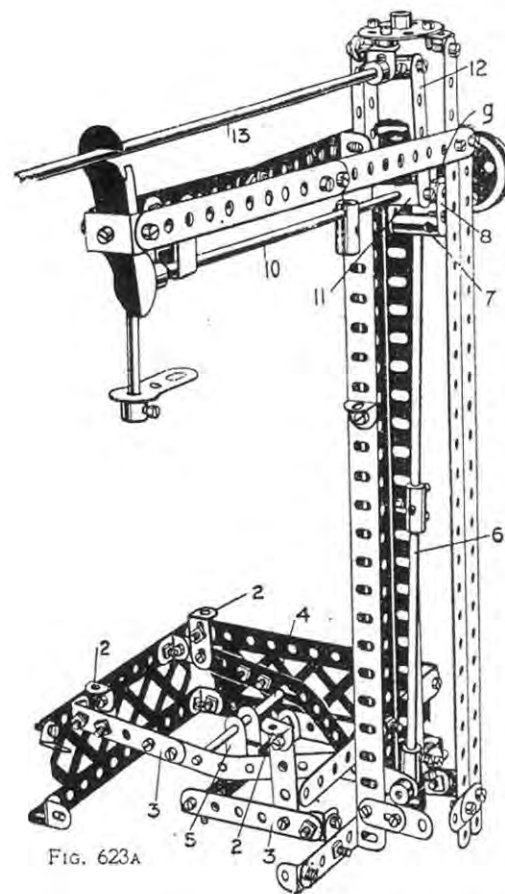
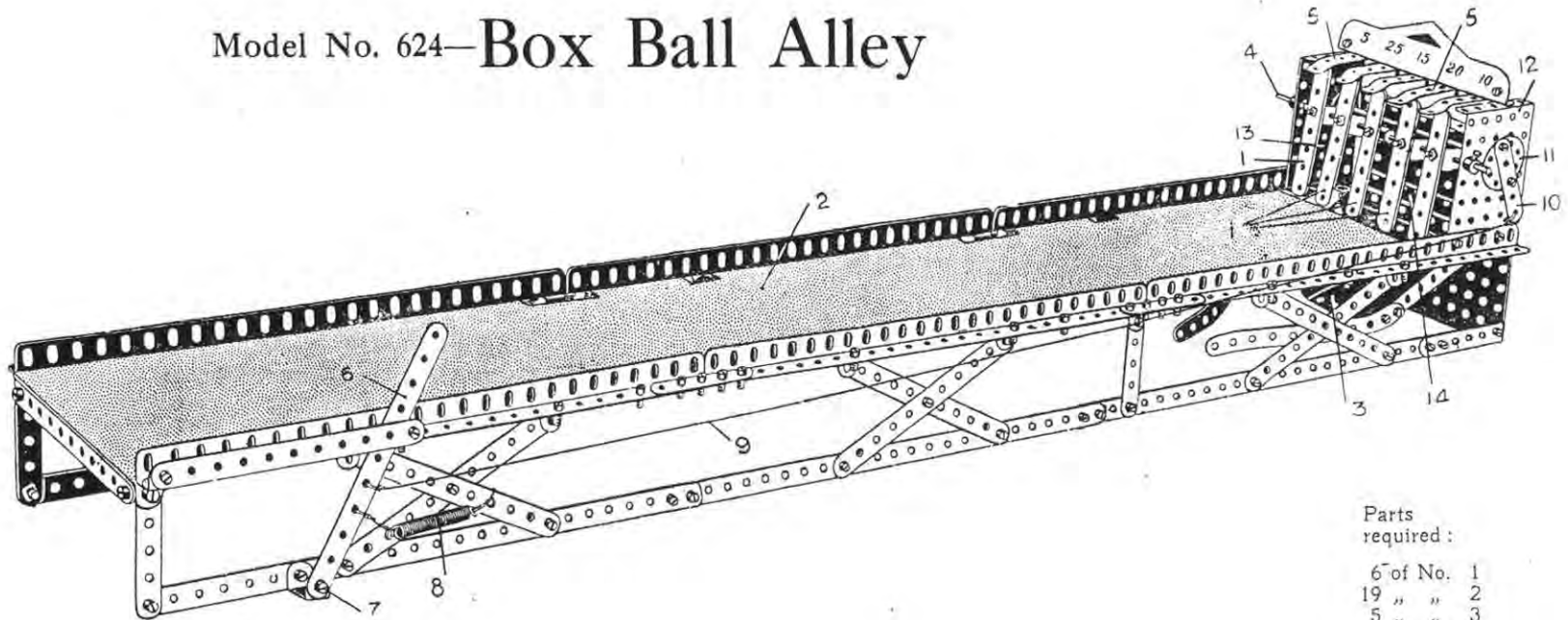


FIG. 623A

Platform 1 is bolted to four angle brackets 2, which are bolted to a pair of lever frames 3, the upper lever frame engaging a rod 4, which is also connected by a cranked bent strip 5 to the lower frame 3. The upper frame 3 is connected to the foot of a pull rod 6, the top of which engages the centre hole of a coupling 7, linked by flat brackets 8 to another coupling 9, through the centre bore of which passes the steelyard rod 10, which is pivotally suspended from another coupling 11 by strips 12 from the weighing lever 13. Sectional view shows the model slightly dismantled, better to show the construction.

## Model No. 624—Box Ball Alley



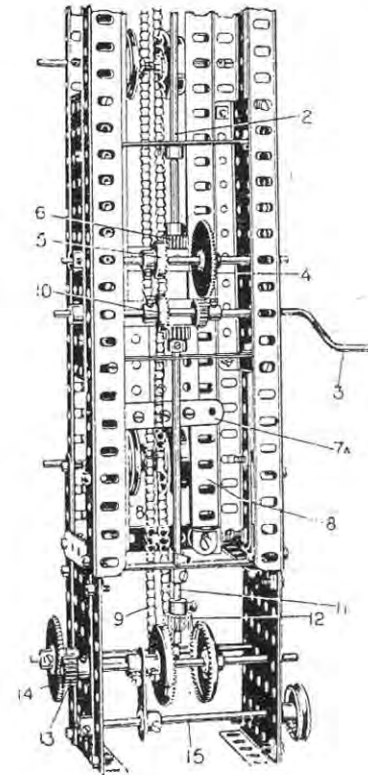
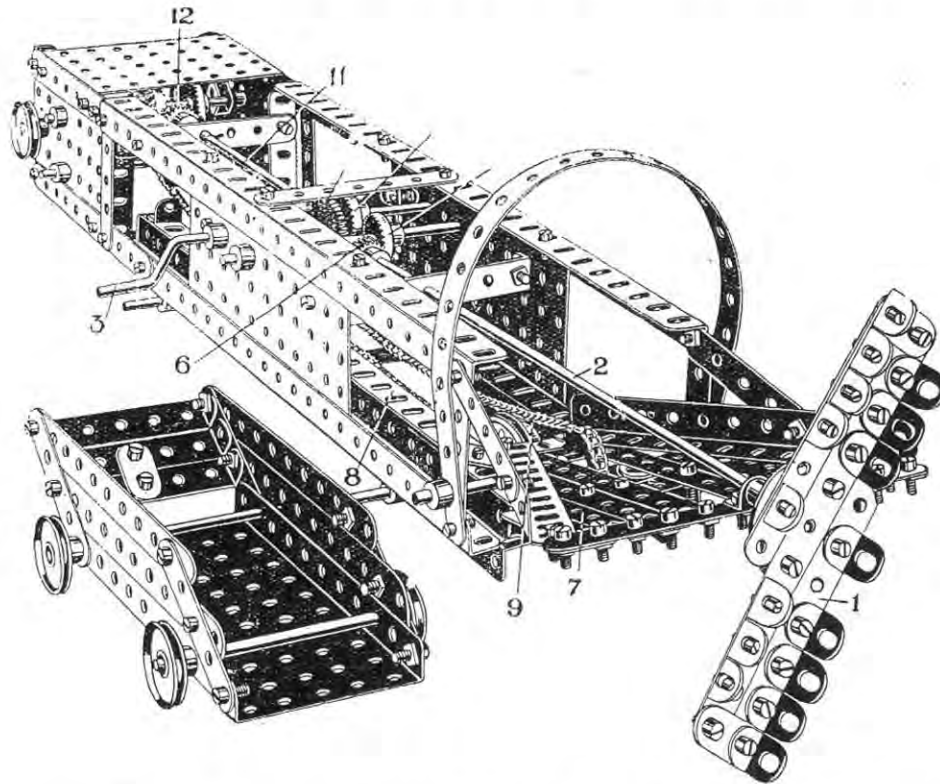
This model gives endless amusement.

The object is to hit one of the strips 1, which have various number values, by means of a ball rolled along the platform 2, the ball after striking and tipping one of the strips being returned by the tray 3 to the player. The strips 1 are pivoted by double bent strips on to a rod 4, so that each strip may swing independently. The upper end of each strip is engaged by strips 5, the ends of which are bent slightly down, as shown, so that while the strips 1 are normally held in the position shown, when one of the strips is struck by the ball it is deflected backward and its upper end snaps outward past the bent end of its strip 5, which thus acts as a spring, the deflected strip being then retained in that position until it is reset. To reset any or all of the strips 1 a handle is formed by a strip 6 pivoted at 7 and controlled by a tension spring 8. A cord 9 connects the strip 6 to a short strip 10 forming a crank and bolted to a bush wheel 11 on an axle journalled in the side plates 12. This axle on its interior carries two further bush wheels to which are secured two short strips 13 forming cranks, a long double bent strip 14 being in turn bolted to the strips 13. When therefore the handle 6 is pulled out against the spring 8 the cord 9 rotates the bush wheel 11 and forces out the long double bent strip 14 which pushes out the strips 1 and resets them in their normal positions. During this resetting operation the upper ends of the strips 1 snap back beneath the bent ends of the spring strips 5.

Parts  
required :

6 of No.	1
19	2
5	3
2	4
15	5
6	8
5	11
27	12
1	14
1	15
2	16
1	24
8	35
132	37
1	43
2	52
2	53
2	54
2	59
2	62
1	63

## Model No. 625—Tunnelling Machine



Parts  
required :

1	of No.	1
12	" "	2
10	" "	3
2	" "	4
17	" "	5
8	" "	8
2	" "	9
5	" "	10
23	" "	12
1	" "	13
1	" "	14
4	" "	15
3	" "	15A
2	" "	16
1	" "	19
4	" "	20
1	" "	21
5	" "	22
1	" "	25
4	" "	26
2	" "	27A
2	" "	28
2	" "	29
4	" "	35
103	" "	37
1	" "	46
1	" "	52
3	" "	53
12	" "	59
3	" "	60
1	" "	62
2' 6"	" "	94
2	" "	96

Fig. 625A

The main boring head 1 is driven by the shaft 2 from the crank 3, on the spindle of which a 20 tooth pinion engages a 56 tooth gear wheel 4 which is fixed on the same spindle as the 25 tooth contrate wheel 5, which is geared with the pinion 6 on the shaft 2. The earth removed by the boring head falls down the slope 7 and is removed by a traversing carriage 7A running on the rails 8 and operated by the chain 9. As the carriage reaches the inner part of its travel it tips by meeting a stop. The carriage is traversed by a large contrate wheel 10 engaging a 20 tooth pinion on the shaft 11, another pinion 12 on this shaft engaging one or other of the contrate wheels which form a clutch for reversing the carriage, the contrate wheels spindle carrying a 25 tooth pinion 13 which engages a 56 tooth gear wheel 14 on the spindle of the rear sprocket wheel carrying the chain. The reversing mechanism is operated by sliding the rod 15.

This Model can be made with  
MECCANO Outfit No. 6, or  
No. 5 and No. 5A

## Model No. 626—Crane

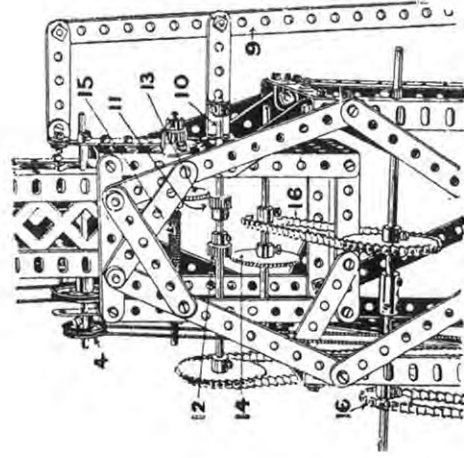
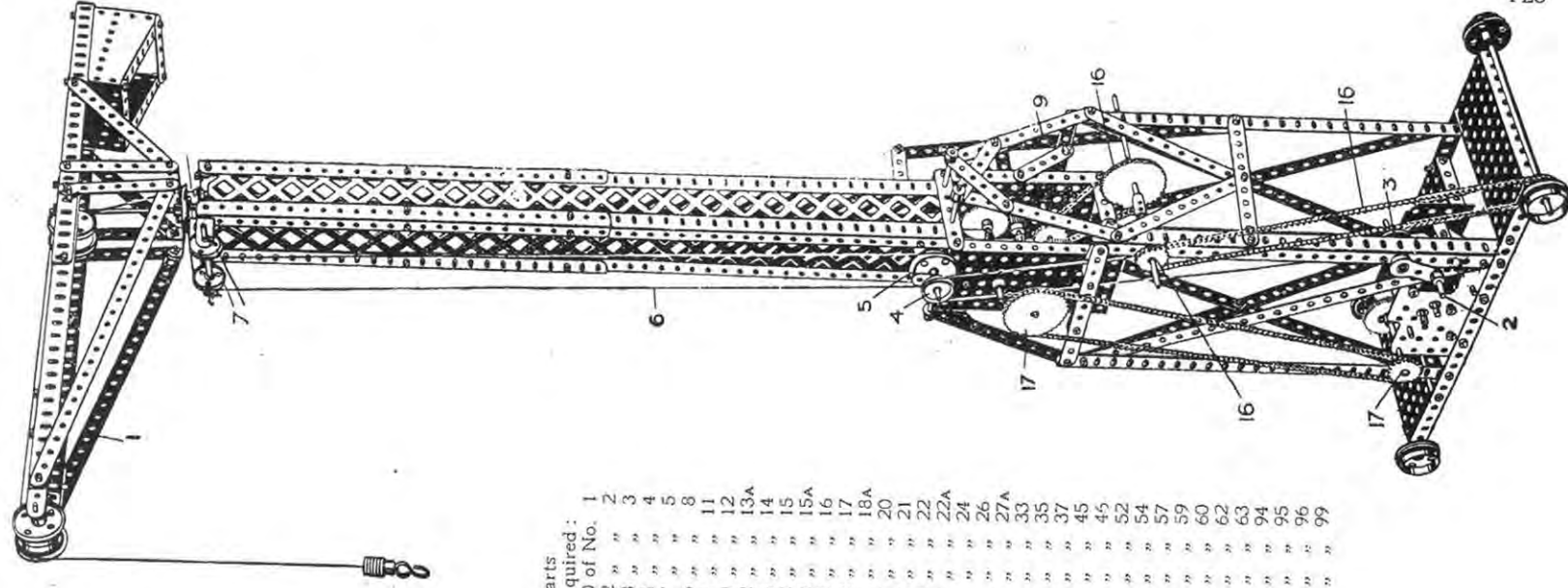


FIG. 626A

The frame of the model is well shown in the illustration. The swinging of the jib 1 is effected from the handle 2 by means of a cord coupling a pulley 3 to a pulley 4. Round a larger pulley 5 on the same shaft passes a continuous cord 6 which, after winding round guide pulley 7, passes round a pulley 8 fixed on the central spindle jib.

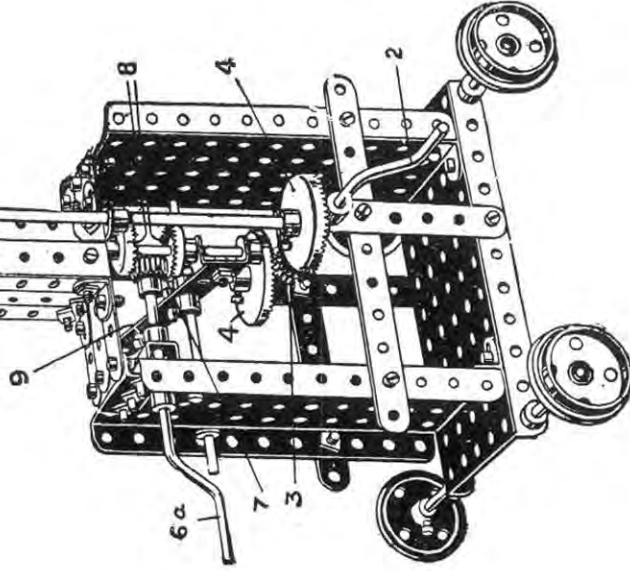
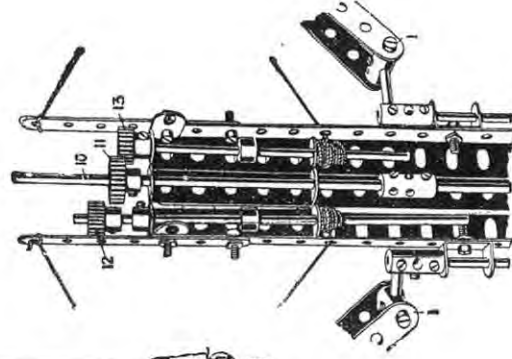
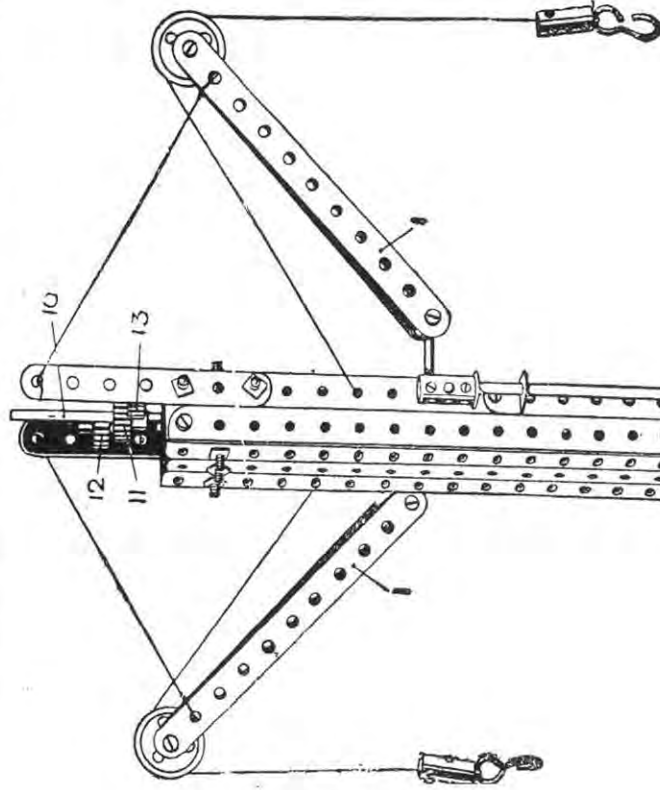
The handle 9 slides the spindle 10 carrying two pinions 11 and 12 so that either the pinion 11 may engage the gear wheel 13 or the pinion 12 the gear wheel 14. When the pinion engages the wheel 13 the cord 15 is wound on or off the spindle to raise or lower the load, and when the pinion 12 engages the wheel 14 the traversing movement is effected through the chain and sprocket 16. The power is taken from the motor by way of the 1" and 2" sprockets 17, the latter on the spindle carrying the pinions 11 and 12.



Parts required:	10 of No.
1	1
2	2
3	3
4	4
5	5
8	16
11	1
12	1
13A	2
14	2
15	2
15A	2
16	3
17	2
18A	1
20	8
21	2
22	2
22A	2
24	1
26	4
27A	3
33	1
35	4
37	139
45	1
45	1
52	5
54	2
57	1
59	14
60	2
62	1
63	1
94	6
95	2
96	4
99	8

Model No. 627

# Derrick



Parts required :

2 of No. 1	2 of No. 13a	2 of No. 29
6 " " 2	2 " " 14	3 " " 35
6 " " 3	2 " " 15	63 " " 37
2 " " 4	2 " " 18A	1 " " 45
4 " " 8	2 " " 19	3 " " 52
12 " " 10	4 " " 20	2 " " 57
3 " " 11	2 " " 22A	12 " " 59
14 " " 12	2 " " 26	3 " " 60
3 " " 13	2 " " 28	7 " " 63

The swinging of the jibs is effected from the handle 2 by sliding the pinion 3 until it engages with one or other of the contrate wheels 4 on the vertical spindles 5. The hoisting and lowering of the load from either of the jibs is effected from the handle 6a, the pinion 7 on which is engaged with one or other of the contrate wheels 8 by the clutch operating strip 9; movement of the strip 9 raises the centre spindle 10 and causes its pinion 11 to engage one or other of the pinions 12, 13, in the spindles of which the hoisting cords are wound.



Model No. 628

# Electric Loco

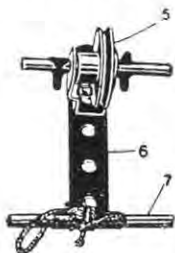
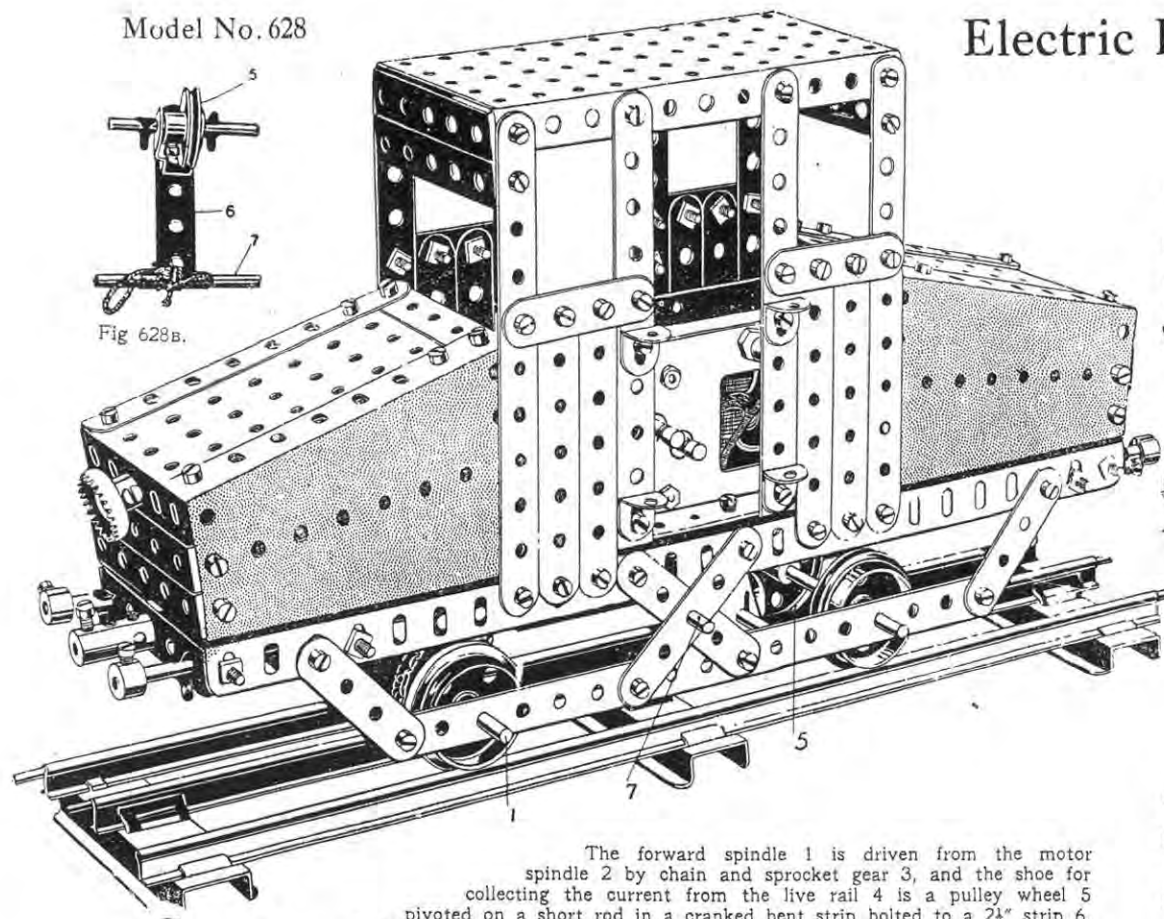


Fig. 628B.

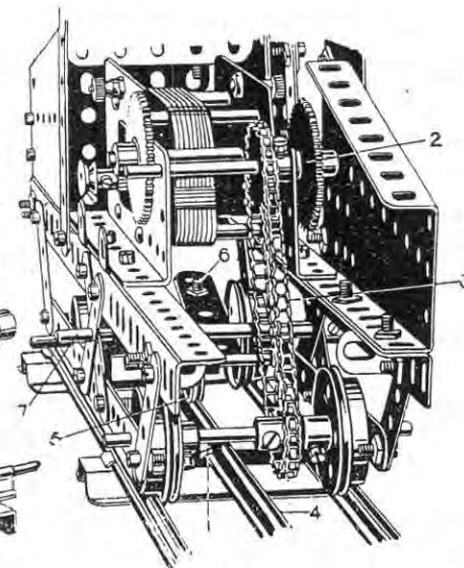


Fig. 628A.

The forward spindle 1 is driven from the motor spindle 2 by chain and sprocket gear 3, and the shoe for collecting the current from the live rail 4 is a pulley wheel 5 pivoted on a short rod in a cranked bent strip bolted to a 2½" strip 6, which is fastened to a rod 7, from which the strip is insulated, as shown in the detail (Fig. 628B). The positive electric wire is led from the strip 6 to the motor terminal, the running wheels forming the negative return of the circuit.

Parts required :

12 of No. 2	3 of No. 17	1 of No. 52
8 " " 3	1 " " 18A	2 " " 53
11 " " 5	4 " " 20	4 " " 54
8 " " 6	1 " " 22	5 " " 59
2 " " 8	1 " " 29	10 " " 60
12 " " 12	2 " " 35	1 " " 63
2 " " 15A	97 " " 37	9 " " 94
4 " " 16	1 " " 44	2 " " 96

Electric Motor

## Model No. 629—Radial Travelling Crane

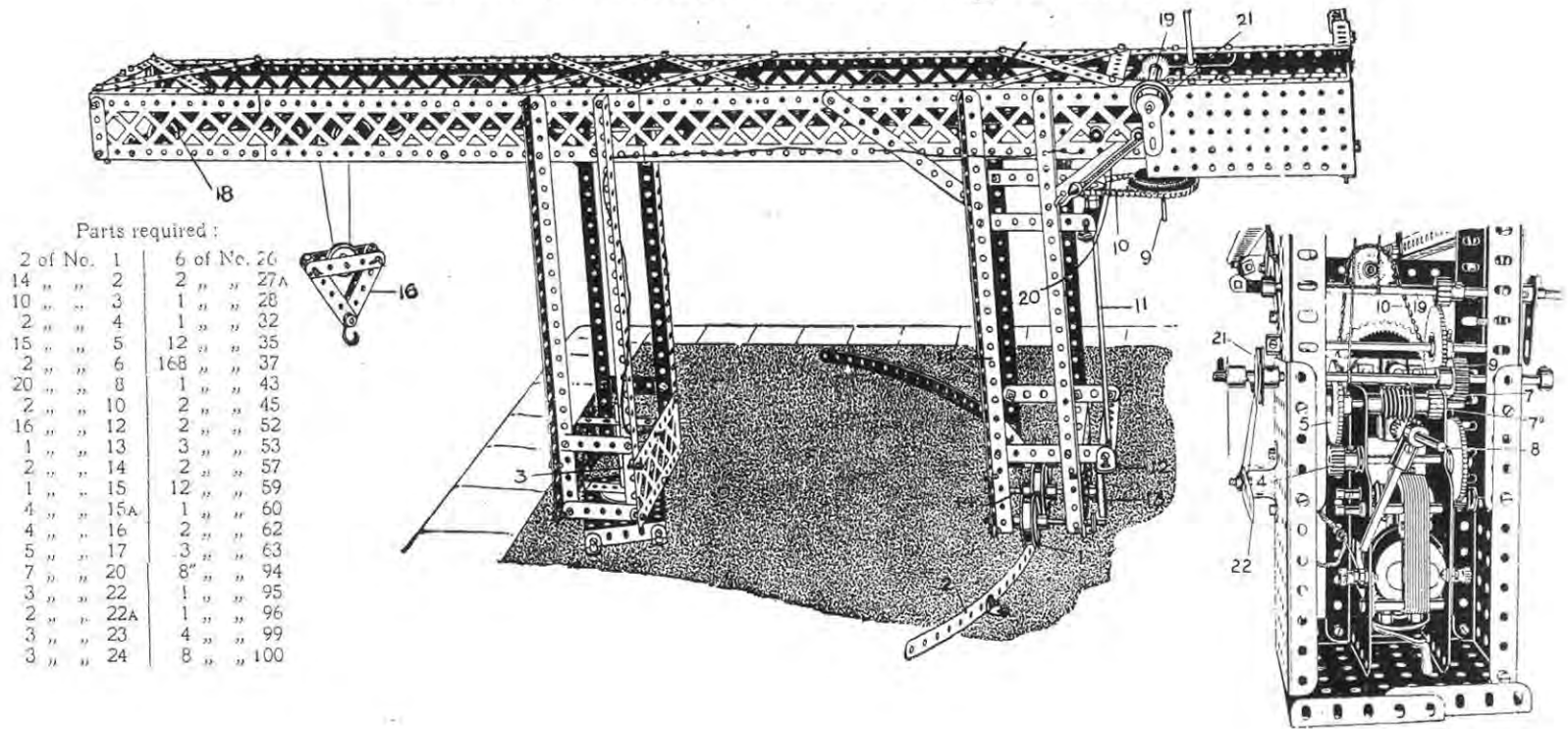
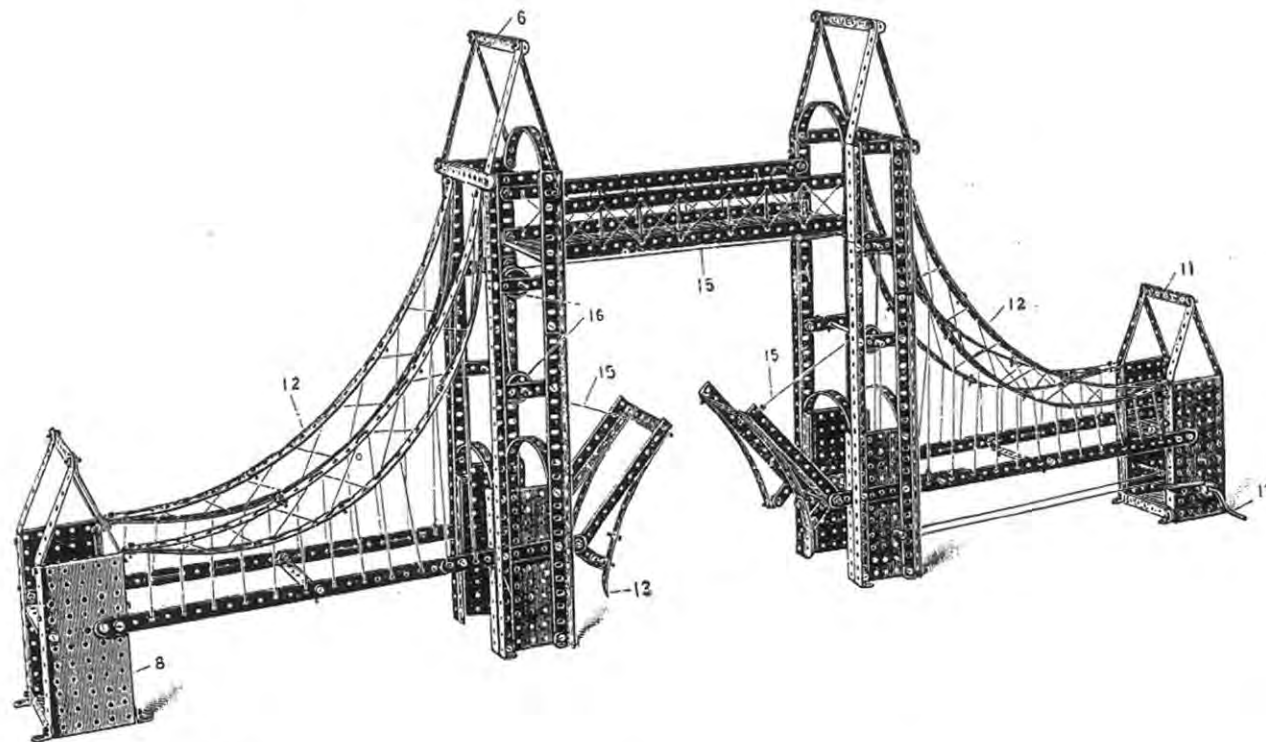


FIG. 629A

The structure of the crane runs on the rear wheels 1 on the circular rail 2 about the central pivot 3. The radial travelling movement is effected from the motor spindle, the pinion 4 of which gears from the secondary wheels 5 with a gear wheel driving a worm 7 which engages a pinion on a vertical spindle 8, at the foot of which is a pinion engaging with a gear wheel on the spindle 9, geared by chain and sprocket wheels 10 to a spindle 11, a pinion 12 on which drives a contrate wheel 13 keyed to the rod 14, on which is the central rolling spindle of the crane leg 15. If a few turns of cord are wound round this central pulley a better bite is obtained on the rail edge 2. The bearings of spindles 8 and 9 are carried in double bent strips secured to transverse strips bolted to the side flanged plates. The traversing mechanism of the carriage which supports the pulley block 16 is effected from the worm shaft 7, a  $\frac{1}{2}$ " pinion 7A on which drives a  $\frac{3}{4}$ " pinion 17, on the spindle of which is a continuous cord which traverses the frame. This cord passes round the pulley 18 at the extreme outer end of the crane jib. The hoisting rope is driven similarly from the pinion 7A, the hoisting cord winding on and off the rod 19. A brake for the spindle of the winding rod 19 is provided by a cord passing round a 1" pulley 21 and connected to a lever 22.

## Model No. 630—Tower Bridge



Parts  
required:

22 of No. 1	12 of No. 9	2 of No. 26	2 of No. 43
34 " " 2	28 " " 12	1 " " 27	2 " " 46
12 " " 3	6 " " 15	1 " " 33	8 " " 52
12 " " 5	1 " " 19	9 " " 35	4 " " 53
10 " " 8	6 " " 22	183 " " 37	1 " " 59

## Model No. 630—Tower Bridge (continued)

Begin by making the two main towers, the construction of one of which is shown in Fig. 630A. The four uprights 1 are made of angle girders, connected at their lower extremities by large flanged plates 2 and transverse strips 3. The sides of the tower are connected together by a small flanged plate 4 across the top of which and at the top of the tower are bolted bent  $5\frac{1}{2}$ " strips.

The top gable 6, constructed as shown, is then bolted at its lower edges 7 to the top of the uprights.

The short end towers, one of which is shown to the right of the figure, are built up from two large flanged plates 8 connected together by a small flanged plate 9 and two  $3\frac{1}{2}$ " strips 10, the gable 11 being then bolted on top.

The catenary member 12 is built up from four curved  $12\frac{1}{2}$ " strips overlapped, the lower member by 12 holes and the upper member by 15 holes, so as to produce a longer sweep in the lower member, and are bolted to the vertical angle girders of the higher towers, and by angle brackets to the shorter towers.

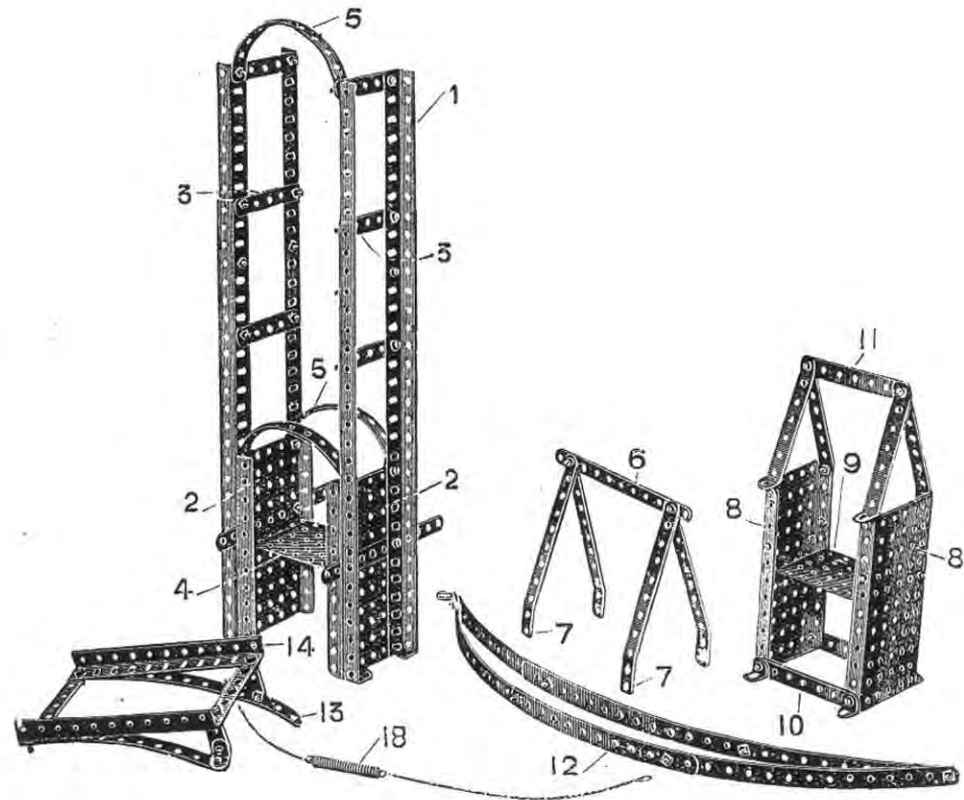
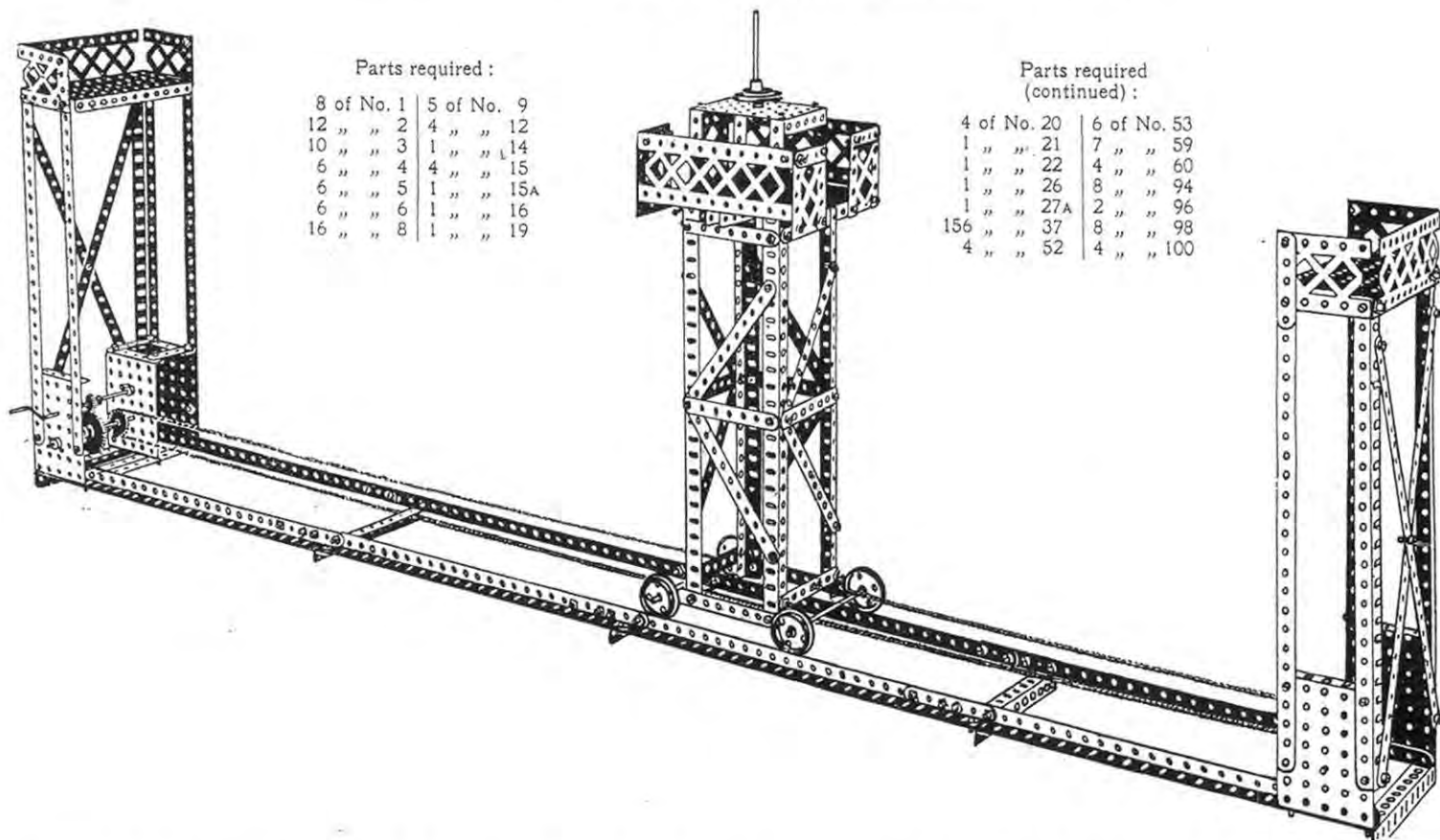


FIG. 630A

The bascules as illustrated in the left-hand corner of the picture are built up of two  $5\frac{1}{2}$ " angle girders braced with transverse  $3\frac{1}{2}$ " strips, and reinforced with bent  $5\frac{1}{2}$ " strips, one of which is provided with a projecting  $2\frac{1}{2}$ " strip 13, which bears against the main tower and acts as a stop when the bascules are horizontal. The bascules are hinged by fixing bolts in the end holes 14, and are opened by the cords 15 passing over the guide pulleys 16, and are controlled by the extension spring 18, which normally acts to return them to their closed position. In the right smaller tower is the operating handle 17, on which is secured a  $\frac{3}{4}$ " pinion meshed with a gear wheel on the spindle, on which the operating cords 15 are wound.

## Model No. 631—St. Malo Transporter Bridge



Parts required :

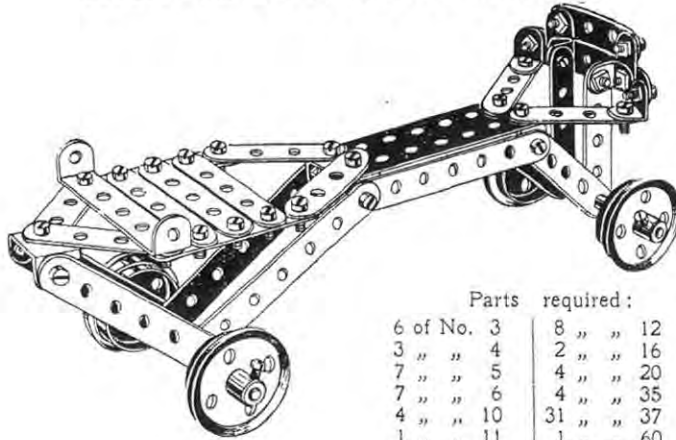
8 of No. 1	5 of No. 9
12 " " 2	4 " " 12
10 " " 3	1 " " 14
6 " " 4	4 " " 15
6 " " 5	1 " " 15A
6 " " 6	1 " " 16
16 " " 8	1 " " 19

Parts required  
(continued) :

4 of No. 20	6 of No. 53
1 " " 21	7 " " 59
1 " " 22	4 " " 60
1 " " 26	8 " " 94
1 " " 27A	2 " " 96
156 " " 37	8 " " 98
4 " " 52	4 " " 100

This is an excellent representation of the Rolling Bridge which conveys passengers from St. Malo to St. Servan. It is much less costly to construct than a transporter bridge of the Newport type, but of course it can only be used over marshy land with shallow water, over which a solid track can be laid. The clever Meccano boy will know how to add little decorations to the transporter and the landing platforms, in the way of flags, etc., and make a first-class toy of this fine model.

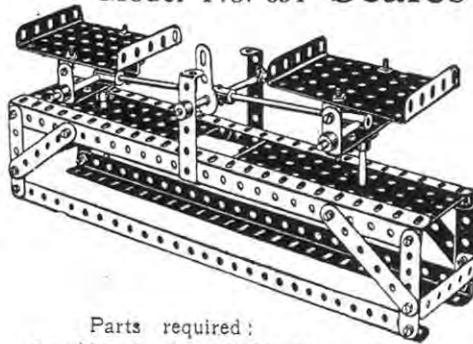
## Model No. 632—Roller Skate



Parts required:

6 of No. 3	8 "	12
3 " " 4	2 " "	16
7 " " 5	4 " "	20
7 " " 6	4 " "	35
4 " " 10	31 " "	37
1 " " 11	1 " "	60

## Model No. 634—Scales

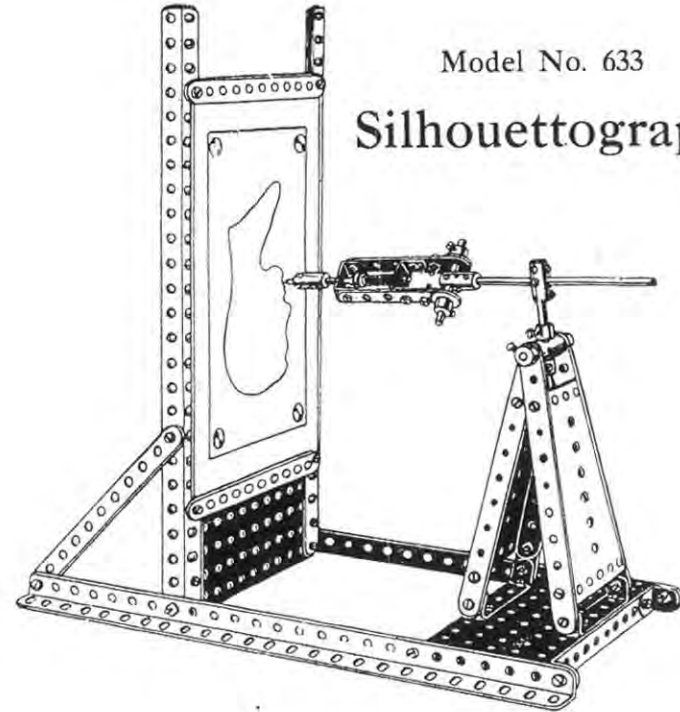


Parts required:

4 of No. 4	2 of No. 52
4 " " 5	2 " " 53
4 " " 8	6 " " 59
5 " " 16	6 " " 60
2 " " 17	3 " " 62
30 " " 37	3 " " 63
2 " " 46	

Model No. 633

## Silhouettograph



Parts required:

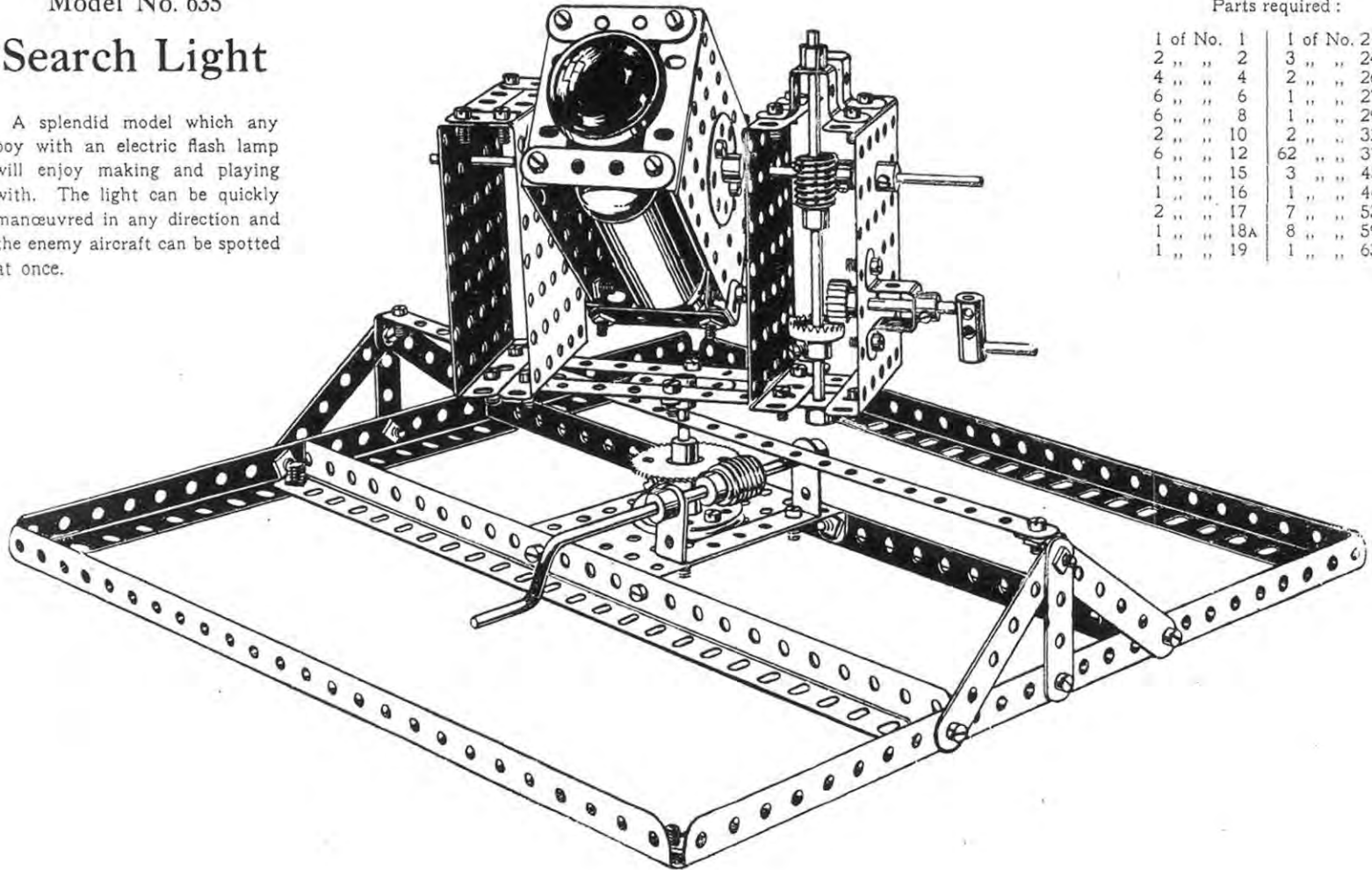
8 of No. 2	4 of No. 12	2 of No. 18A	2 of No. 54
2 " " 4	3 " " 13	42 " " 37	5 " " 59
4 " " 8	1 " " 16	1 " " 43	2 " " 62
2 " " 11	2 " " 17	2 " " 52	6 " " 63

The writing arm should be about 3' long. The person to be silhouetted should sit with his profile exactly opposite the centre of the writing board, upon which a sheet of plain paper has been fixed. The writing arm is then passed smoothly round the profile.

Model No. 635

# Search Light

A splendid model which any boy with an electric flash lamp will enjoy making and playing with. The light can be quickly manoeuvred in any direction and the enemy aircraft can be spotted at once.



Parts required :

1 of No. 1	1 of No. 21
2 " " 2	3 " " 24
4 " " 4	2 " " 26
6 " " 6	1 " " 27A
6 " " 8	1 " " 29
2 " " 10	2 " " 32
6 " " 12	62 " " 37
1 " " 15	3 " " 45
1 " " 16	1 " " 46
2 " " 17	7 " " 53
1 " " 18A	8 " " 59
1 " " 19	1 " " 63

## Model No. 636—Dutch Windmill

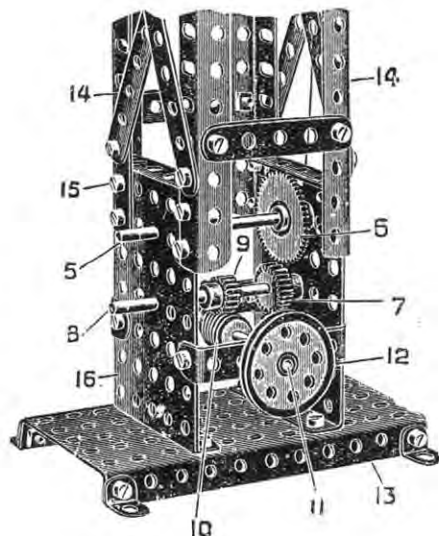
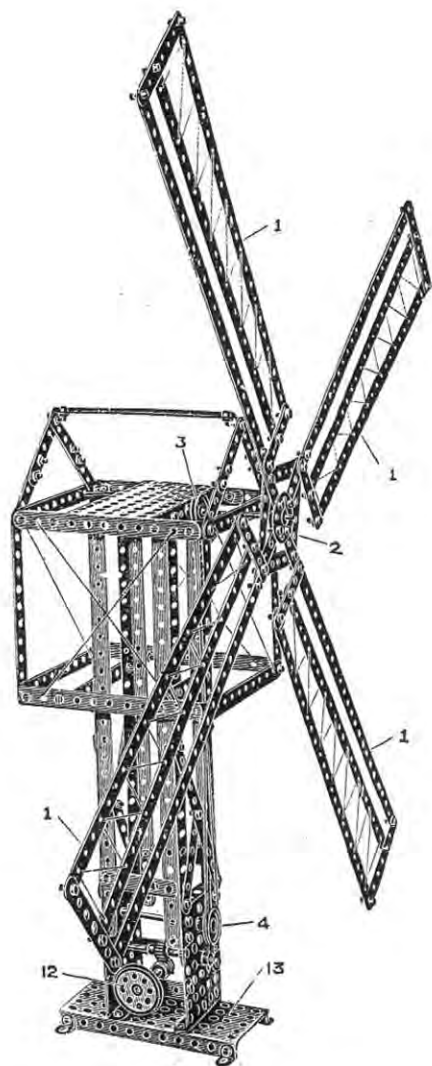


FIG. 636A

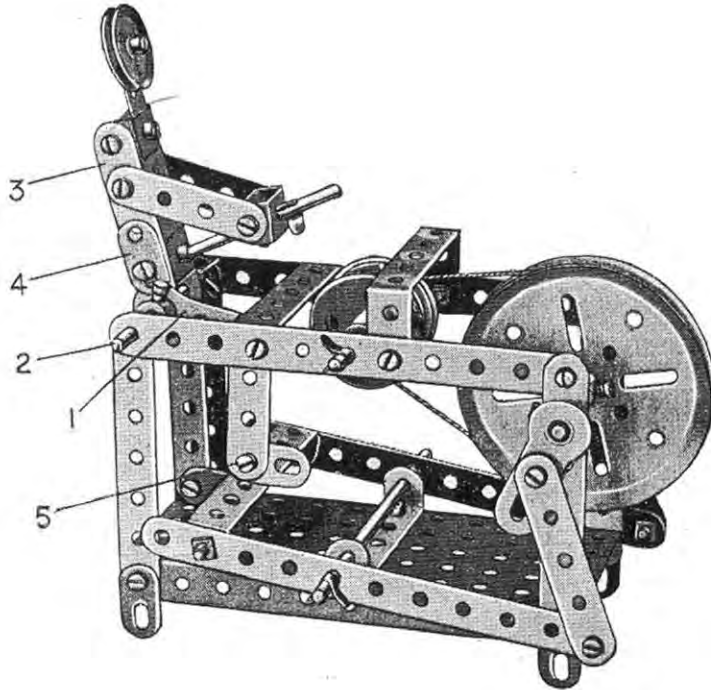
Parts  
required :

12 of No.	1
19 " "	2
4 " "	3
4 " "	4
14 " "	5
4 " "	8
22 " "	12
1 " "	14
3 " "	16
1 " "	21
2 " "	22
1 " "	24
2 " "	26
1 " "	27 <sub>A</sub>
1 " "	32
120 " "	37
2 " "	52
2 " "	53
3 " "	59
2 " "	60

The construction of the sails 1 of the mill will be readily followed from the illustration. They are bolted to an inner strip frame 2 and to a bush wheel fixed on a spindle, on which is also mounted a pulley wheel 3, the driving cord passing round this pulley wheel to a lower pulley wheel 4, the driving of which will be followed from the detail. The pulley wheel 4 is on the outer end of the shaft 5, on which is fitted a gear wheel 6 driven by a pinion  $\frac{3}{4}$ " 7 on the axle 8, this axle also carrying a pinion  $\frac{1}{2}$ " 9 engaged by a worm 10 on the driving shaft 11, which carries the driving pulley 12. This driving gear is enclosed in two small side flanged plates 16 bolted to a base plate 13, the vertical stroke of the mill being made from corner angle girders 14 bolted at 15 to the side plates 16.



## Model No. 637—Knife Grinder



Parts required:

4 of No.	2
4 "	3
2 "	4
4 "	5
3 "	6
4 "	10
3 "	11
2 "	12
1 "	15
3 "	16
1 "	17
1 "	19A
2 "	20
1 "	22
1 "	22A
2 "	35
32 "	37
6 "	37A
1 "	46
1 "	52
2 "	60
1 "	60B
3 "	62

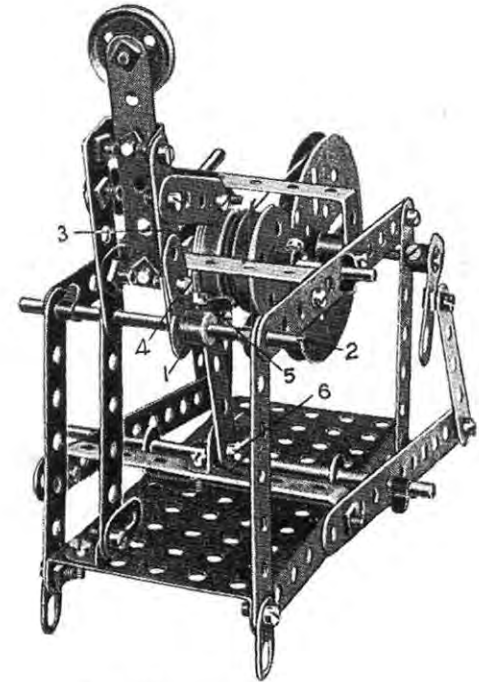
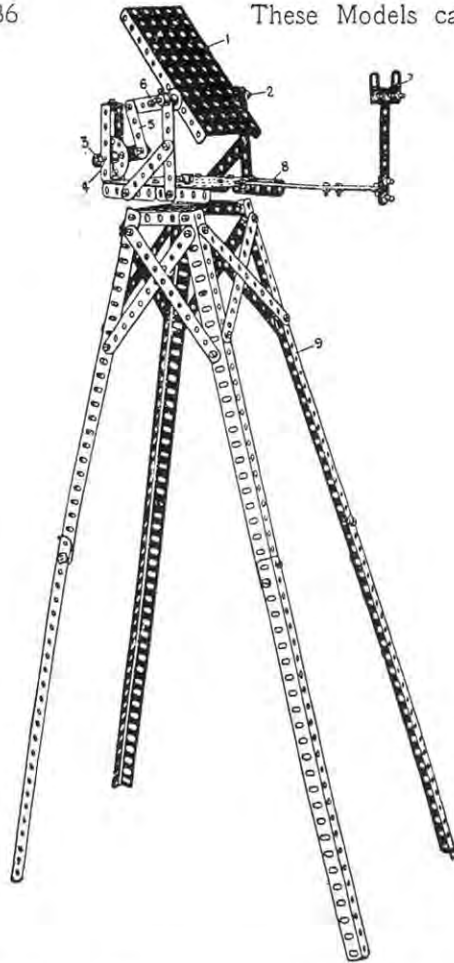


FIG. 637A.

The crank 1 is secured to the rod 2, and the 2½" side-strip 3 is clamped to the crank 1 by the flat bracket 4. The bolt at the end of the crank forming the knee and the bolt 5 are lock-nutted to allow free movement. When the treadle is operated the body works backwards and forwards.



## Model No. 638 Heliograph

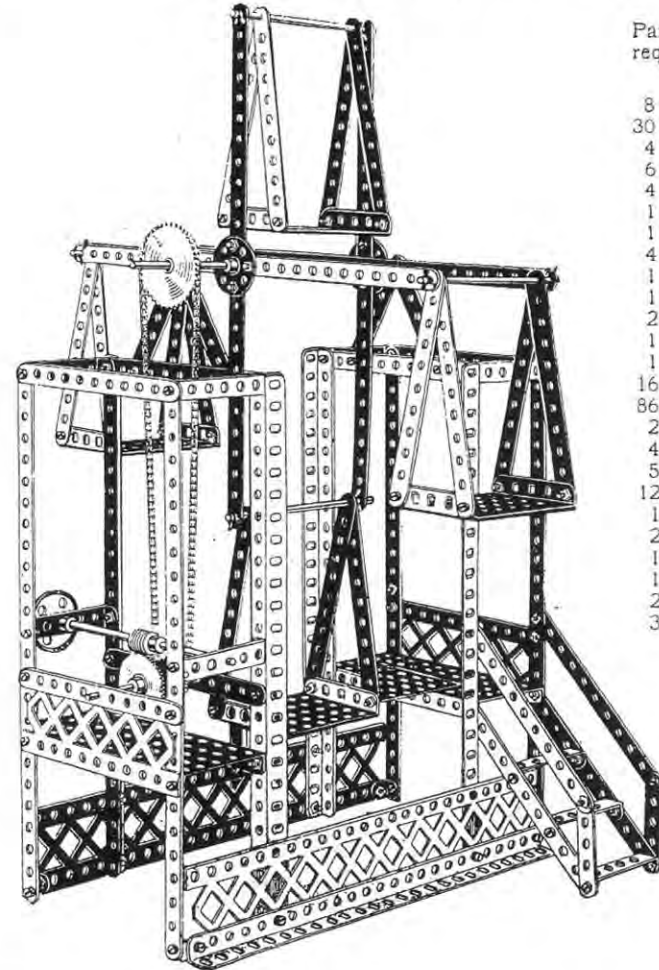
Parts  
required :

9 of No.	2
3 "	3
5 "	4
1 "	5
2 "	6
8 "	8
4 "	10
3 "	12
1 "	15A
1 "	17
1 "	18A
2 "	24
64 "	37
1 "	52
3 "	53
3 "	59
2 "	60
3 "	62

A large rectangular plate 1 is rocked about its pivots 2 by a lever 3, pivoted at 4 and connected by a 2" strip 5 to the outer end of a crank 6, to which is connected a 2" strip. The rectangular plate 1 should be fitted with

a mirror, and a sighting aperture 7 is mounted in front, the operator bringing one of the perforations in the plate 1 in line with the aperture 7, while signalling, so that he can see the opposite instrument in the distance. The platform 8 is pivotally mounted on the standard 9 so that it may be swung round to any position, a bush wheel being bolted to the top of the standard in which the pivot works. The platform is made of two small rectangular plates butted together and connected on each side by strips.

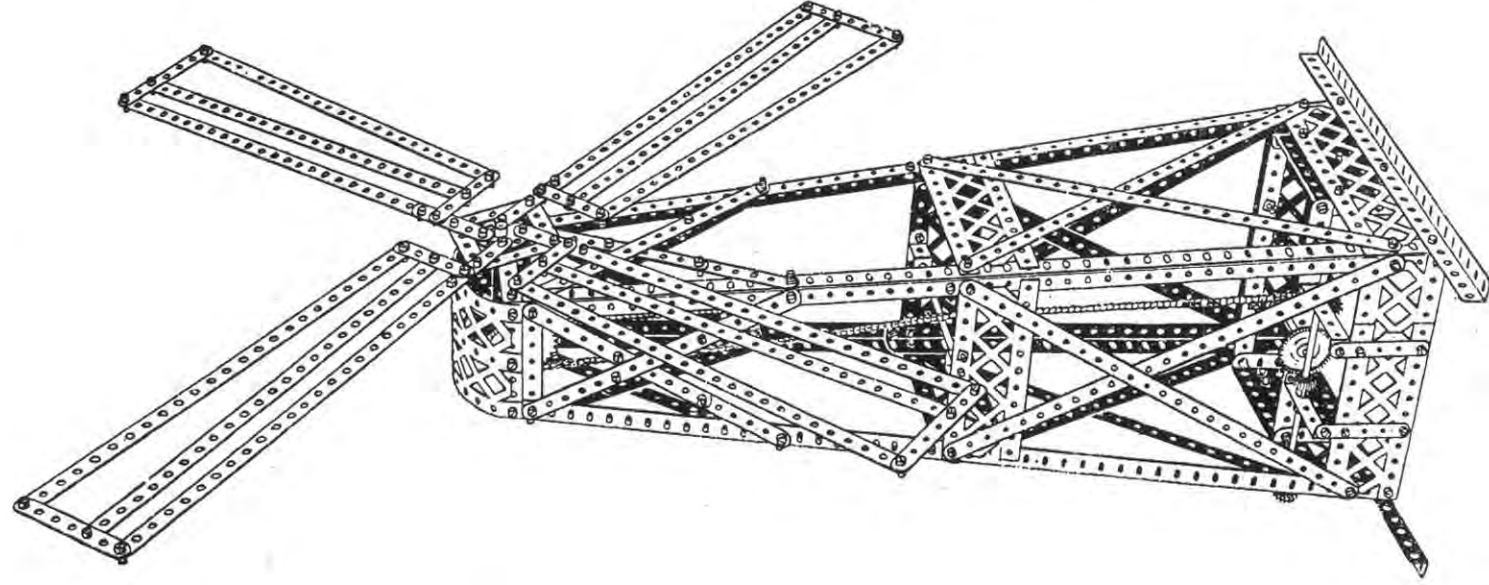
## Model No. 639—Fly Boats



Parts  
required :

8 of No.	1
30 "	2
4 "	3
6 "	8
4 "	11
1 "	13
1 "	14
4 "	15
1 "	15A
1 "	21
2 "	24
1 "	27A
1 "	32
16 "	35
86 "	37
2 "	52
4 "	53
5 "	59
12 "	60
1 "	70
2' "	94
1 "	95
1 "	96
2 "	99
3 "	100

This Model can be made with MECCANO Outfit No. 6, or No. 5 and No. 5A



## Model No. 640 Windmill

Parts  
required :

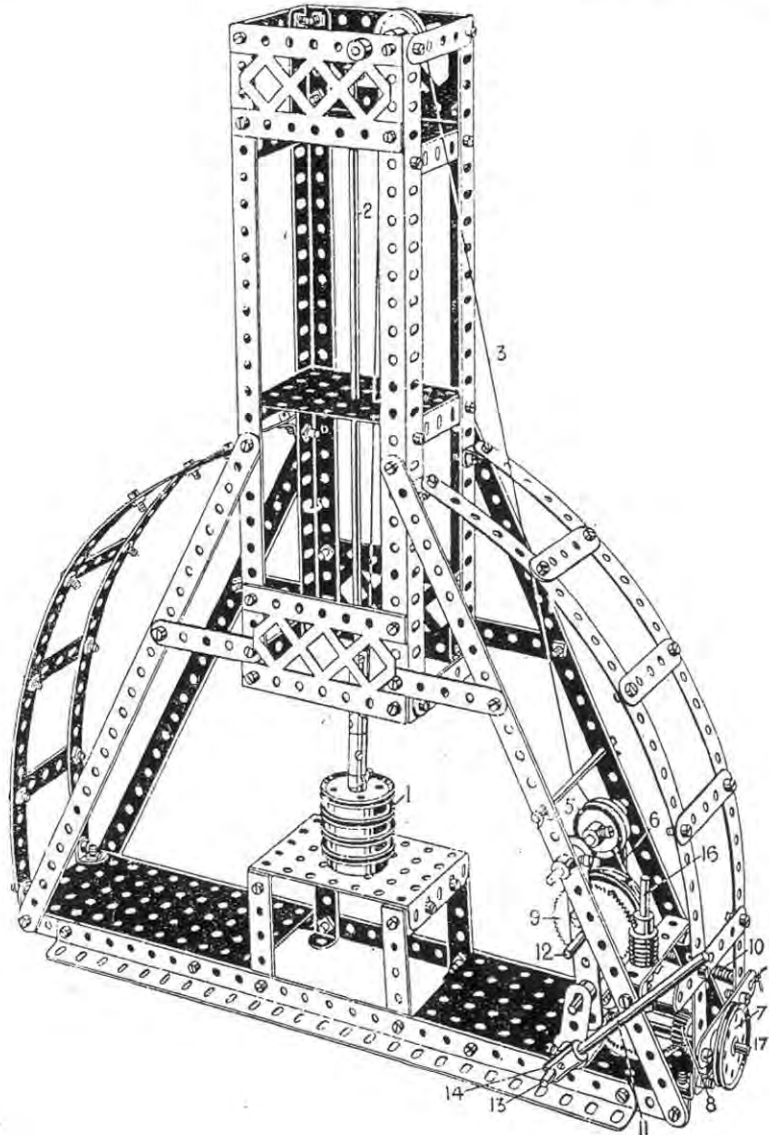
20 of No.	1
24 "	2
10 "	3
14 "	5
10 "	8
2 "	13A
2 "	14
1 "	15
1 "	24
1 "	26
1 "	27A
1 "	28
1 "	32
2 "	35
134 "	37
4 "	38
2 "	45
2 "	53
5 "	59
2 "	60
1 "	62
4 "	94
1 "	95
1 "	96
14 "	100

## Model No. 641

## Drop Hammer

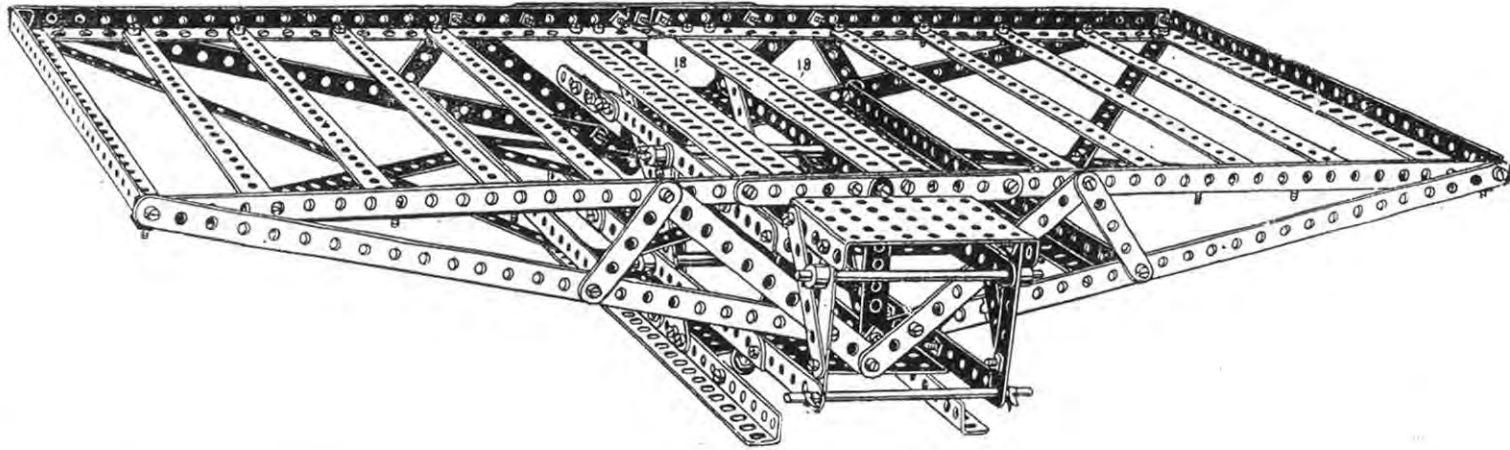
## Parts required :

8 of No. 1	4 of No. 16	2 of No. 35
3 " " 3	3 " " 17	112 " " 37
3 " " 4	5 " " 20	1 " " 43
13 " " 5	1 " " 21	2 " " 52
6 " " 8	3 " " 22	3 " " 53
2 " " 11	1 " " 24	8 " " 59
8 " " 12	1 " " 26	8 " " 60
1 " " 13	1 " " 27A	3 " " 62
1 " " 15	1 " " 28	6 " " 63
2 " " 15A	1 " " 32	4 " " 97



The weighted hammer head 1 is fixed at the end of the slidable rod 2 and lifted by a cord 3 connected to the head and passing over a pulley and between guide pulleys 5 on to a winding drum of two flanged wheels 6. The driving pulley 7 is geared by a pinion 8 to a contrate wheel, on the spindle of which is a worm gearing with a 57-toothed gear wheel 9 by which the cord is operated. The coupling 15 is threaded on the upright spindle 16 and forms a bearing for the axle 17. The gear wheel 9 and flanged wheels 6 are held in engagement with the worm by the pull of a spring 10 when raising the hammer, but may be disengaged, in order to drop the hammer, by the handle-rod 11 secured to the rod 12 about which the geared wheel 9 pivots. To the rod 13 a crank is secured on each side of the winding-drum mechanism, to which also is secured the coupling 14 and a corresponding coupling at the other end of the rod to which the spring 10 is attached. This rod is pivotally attached to a  $2\frac{1}{2}$ " bent strip bolted to the base plate.

## Model No. 642—Weighbridge



## Parts required :

22 of No. 1	4 of No. 15
12 " " 2	2 " " 15A
6 " " 3	2 " " 35
6 " " 4	130 " " 37
8 " " 5	6 " " 53
14 " " 8	10 " " 59
12 " " 12	1 " " 60

Begin the construction of this model by making the weigh beam, Fig. 642A. The side strips 1 are bolted to the base angle girders 2, and in the strips 1 are journalled the rods 3 which form the fixed pivots of the weigh beam. The upper and lower rods 4 are journalled in the strips 5 and form the moving pivots of the beam. All the rods 3 and 4 pass through perforations in the upper and lower strips 6 of the beam. Next construct the platform, Fig. 642B, leaving the strips at one side unconnected, as shown. The platform is then passed between the upper and lower parts of the weigh beam, and the unconnected strips then bolted, as follows. The ends 7 are bolted to the lowest hole 8, and the ends 9 to the angle bracket 10, and the end of the angle girder 11 is overlapped five holes of the strip 12 and bolted in the hole 13. The outer holes 14 of the  $1\frac{1}{2}$ " crossed strips, Fig. 642A, are then bolted to the same holes 15 in the angle girders 16 as the strips 17. The double angle girders 18 are then bolted in position, and the outer holes 19, Fig. 642A,

## Model No. 642—Weighbridge (continued)

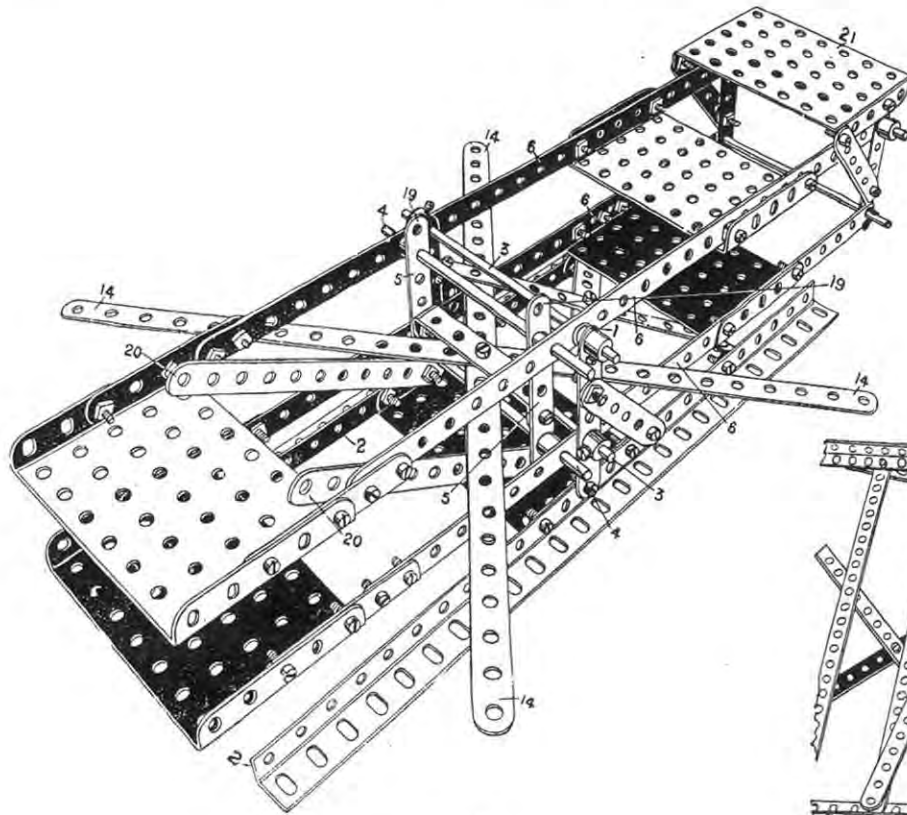


FIG. 642A

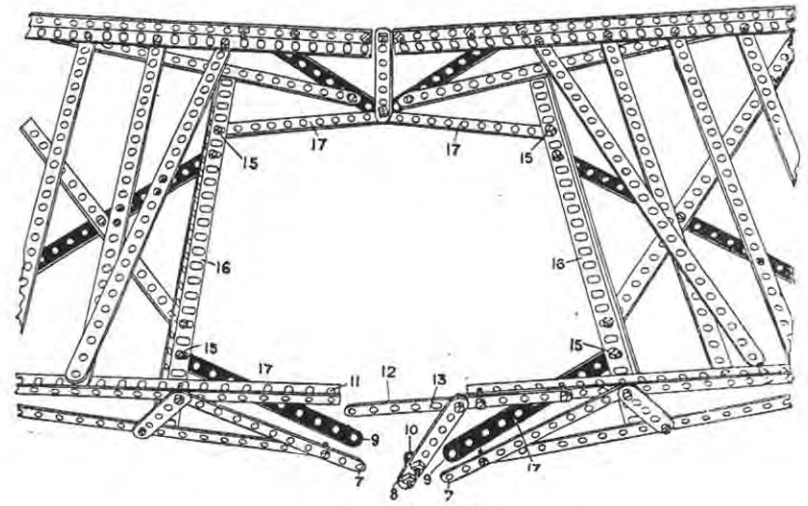
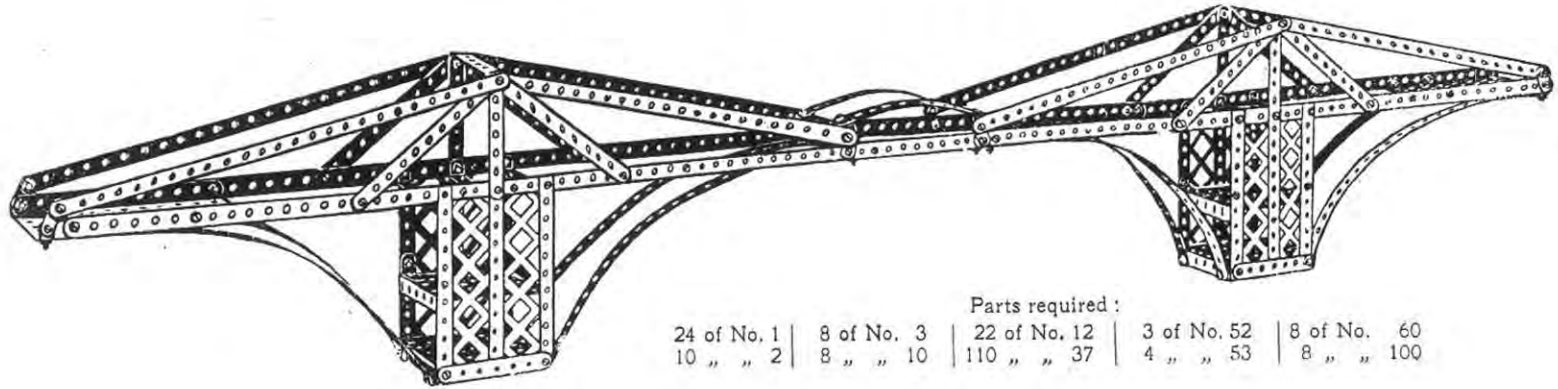


FIG. 642B

are bolted to the angle girders 18 in the centre holes and the holes 20, Fig. 642A, to the angle girders 18 at the fifth hole from the girder ends. The load to be weighed rests on the main platform, and the weights are placed on the small rectangular plate 21 at the end of the weigh beam.

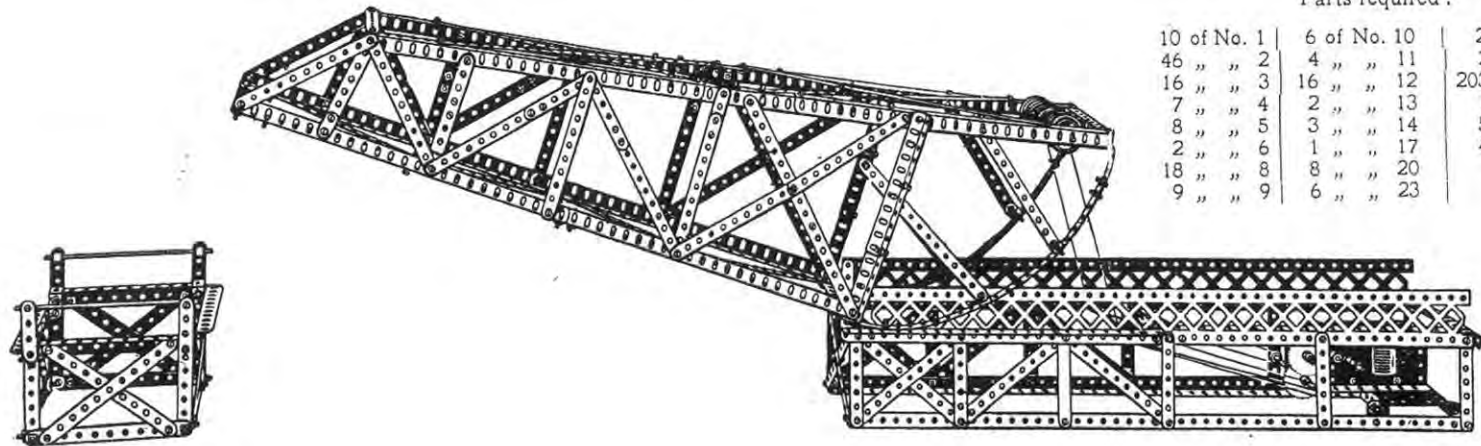
## Model No. 643—Cantilever Bridge



Parts required :

24 of No. 1	8 of No. 3	22 of No. 12	3 of No. 52	8 of No. 60
10 " " 2	8 " " 10	110 " " 37	4 " " 53	8 " " 100

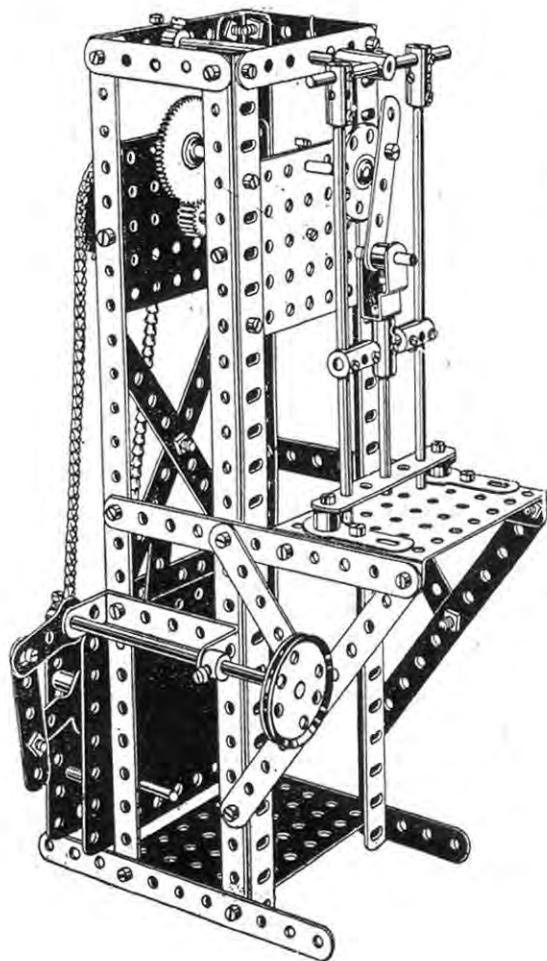
## Model No. 644—Rolling Lift Bridge



Parts required :

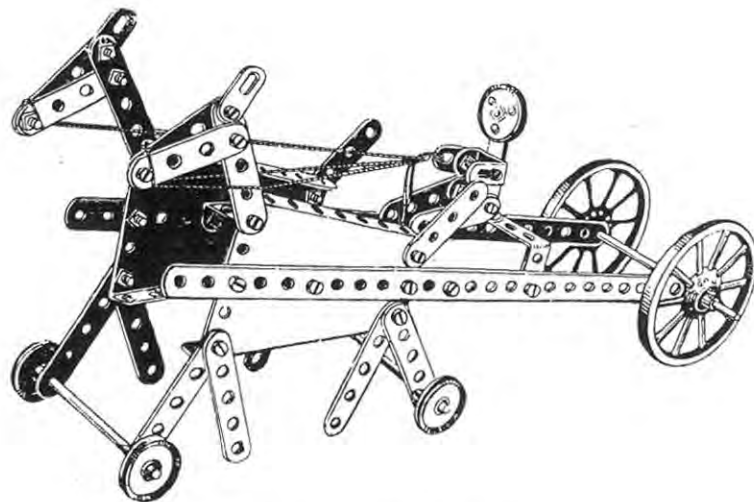
10 of No. 1	6 of No. 10	2 of No. 26
46 " " 2	4 " " 11	2 " " 27
16 " " 3	16 " " 12	203 " " 37
7 " " 4	2 " " 13	1 " " 52
8 " " 5	3 " " 14	5 " " 59
2 " " 6	1 " " 17	4 " " 99
18 " " 8	8 " " 20	
9 " " 9	6 " " 23	

## Model No. 645--Punching Machine



Parts required:

8 of No.	2
3 " "	3
2 " "	4
4 " "	5
4 " "	8
2 " "	14
2 " "	15A
2 " "	16
2 " "	17
1 " "	18A
1 " "	21
1 " "	24
1 " "	26
1 " "	27A
50 " "	37
2 " "	38
1 " "	44
1 " "	46
4 " "	53
6 " "	59
3 " "	62
6 " "	63
2 " "	94
1 " "	95
1 " "	96



Model No. 646

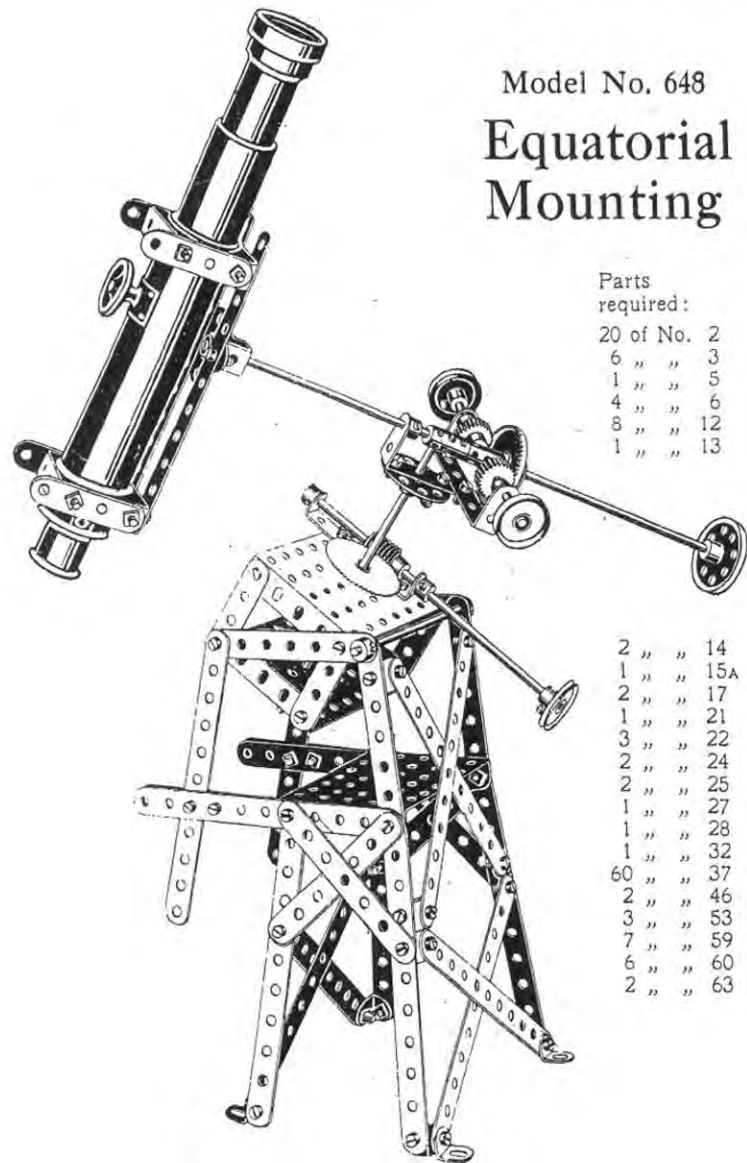
## Sulky and Driver

Parts required:

2 of No. 1	1 of No. 12	32 of No. 37
10 " " 5	3 " " 15A	1 " " 46
9 " " 6	2 " " 19A	2 " " 54
4 " " 10	4 " " 22	2 " " 60
2 " " 11	1 " " 22A	



## Model No. 648 Equatorial Mounting

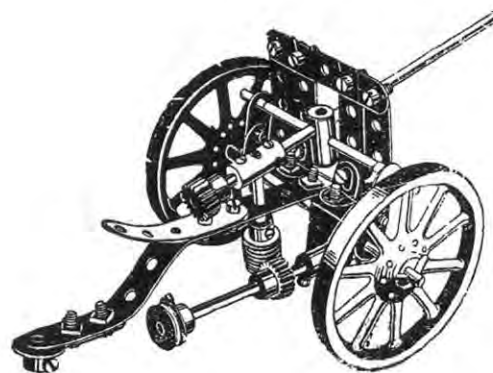


Parts  
required:

20 of No.	2
6 " "	3
1 " "	5
4 " "	6
8 " "	12
1 " "	13

2 " "	14
1 " "	15A
2 " "	17
1 " "	21
3 " "	22
2 " "	24
2 " "	25
1 " "	27
1 " "	28
1 " "	32
60 " "	37
2 " "	46
3 " "	53
7 " "	59
6 " "	60
2 " "	63

## Model No. 648 Field Gun



Parts required:

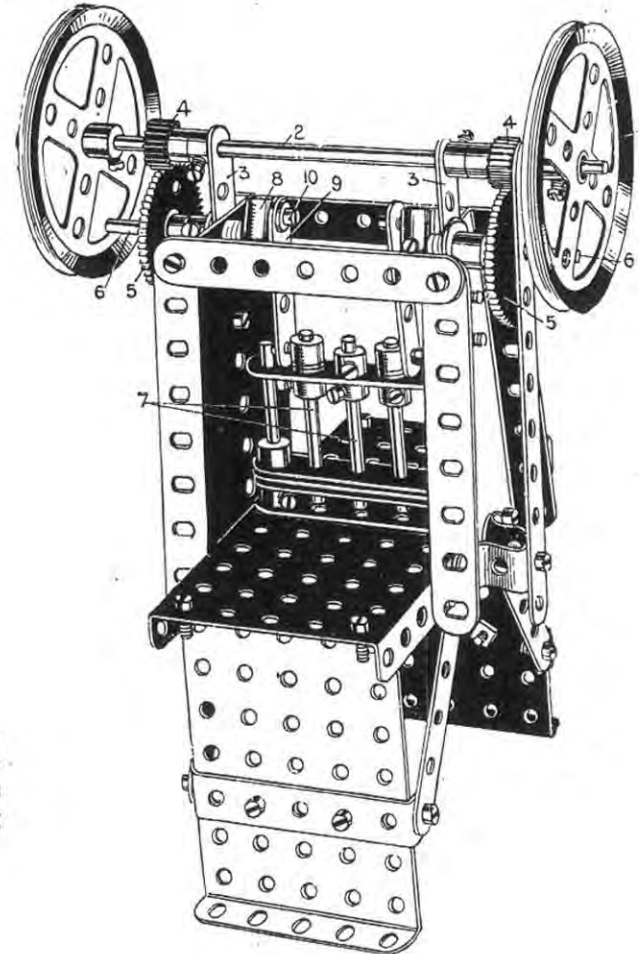
1 of No.	2	2 of No.	16	17 of No.	37
7 " "	5	1 " "	17	1 " "	44
2 " "	10	2 " "	19A	2 " "	59
6 " "	12	1 " "	23A	1 " "	60
1 " "	14	2 " "	26	1 " "	62
1 " "	15	1 " "	32	2 " "	63
		6 " "	35		

## Model No. 649—Punching Press

### Parts required :

1 of No. 2	29 of No. 37
2 " " 3	22 " " 38
4 " " 4	1 " " 45
7 " " 5	1 " " 52
2 " " 6	2 " " 53
1 " " 14	2 " " 54
2 " " 16	15 " " 59
5 " " 17	2 " " 60
2 " " 19B	2 " " 62
2 " " 26	2 " " 63
2 " " 27A	

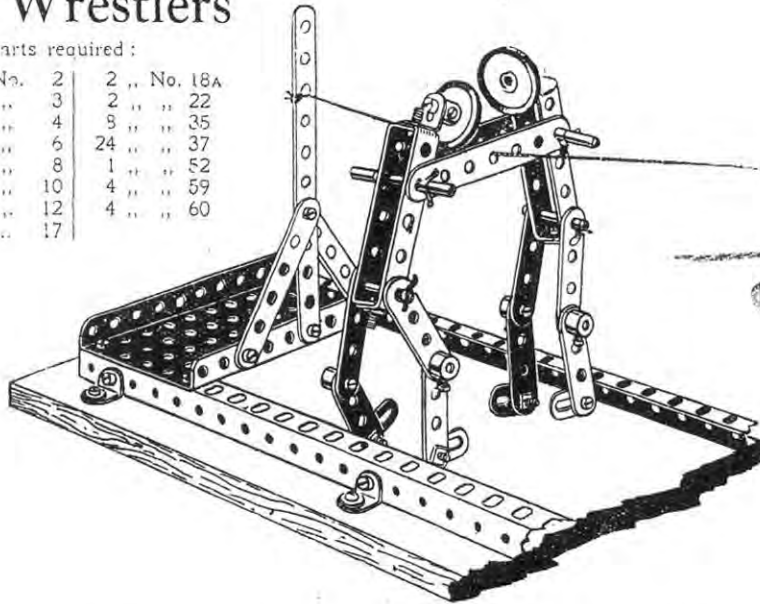
The rod 2 carrying the flywheels 1 is journalled in cranks 3, pinions 4 driving the large gear wheels 5 on short rods 6. The cranks by which the punch rods 7 are operated consist of couplings 8 secured at their middle holes to the ends of the short rods 6, the strips 9 operating the punch rods 7 being connected by screws 10 to one of the outer holes of the coupling.



## Model No. 650 The Wrestlers

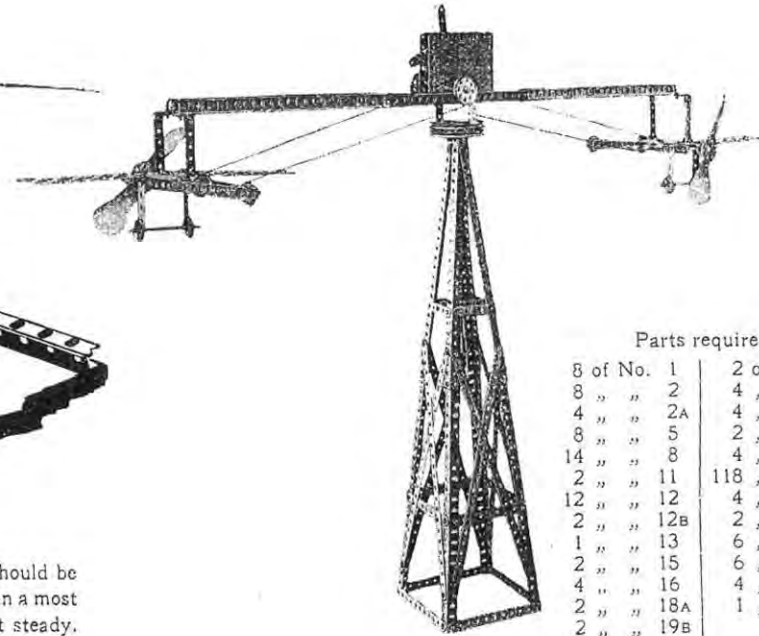
Parts required :

1 of No. 2	2 " No. 18A
2 " " 3	2 " " 22
2 " " 4	3 " " 35
8 " " 6	24 " " 37
2 " " 8	1 " " 52
4 " " 10	4 " " 59
8 " " 12	4 " " 60
2 " " 17	



Boys will at once recognise this familiar toy. When the cord, which should be about 4' long, is kept fairly tight and manipulated, the figures will wrestle in a most realistic manner. The model should be mounted on a board, to keep it steady.

## Model No. 651 Revolving Aeroplane



Parts required :

8 of No. 1	2 of No. 21
8 " " 2	4 " " 22
4 " " 2A	4 " " 22A
8 " " 5	2 " " 24
14 " " 8	4 " " 35
2 " " 11	118 " " 37
12 " " 12	4 " " 41
2 " " 12B	2 " " 54
1 " " 13	6 " " 59
2 " " 15	6 " " 60
4 " " 16	4 " " 100
2 " " 18A	1 " " 112
2 " " 19B	

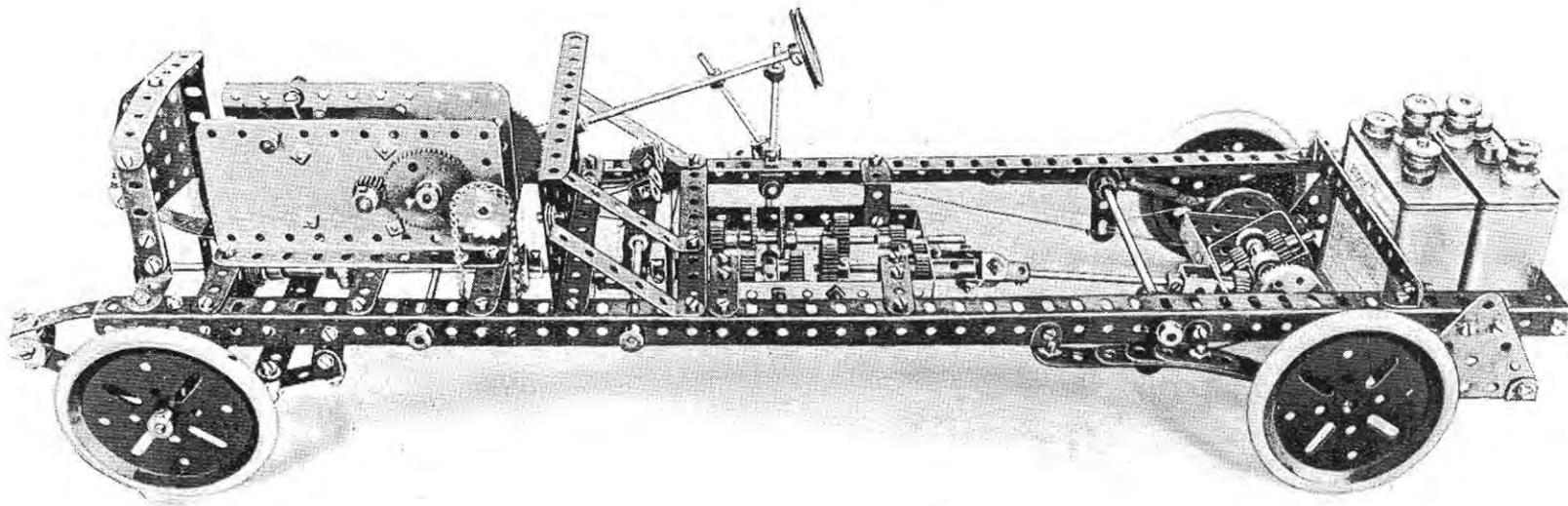
## HOW TO CONTINUE

This completes the Models which may be made with MECCANO Outfit No. 6. The next Models are a little more advanced, requiring a number of extra parts to construct them. The necessary parts, are all contained in a No. 6A Accessory Outfit, the price of which will be found in the List at the end of the Manual.

This Model can be made with MECCANO Outfit No. 7, or No. 6 and No. 6A

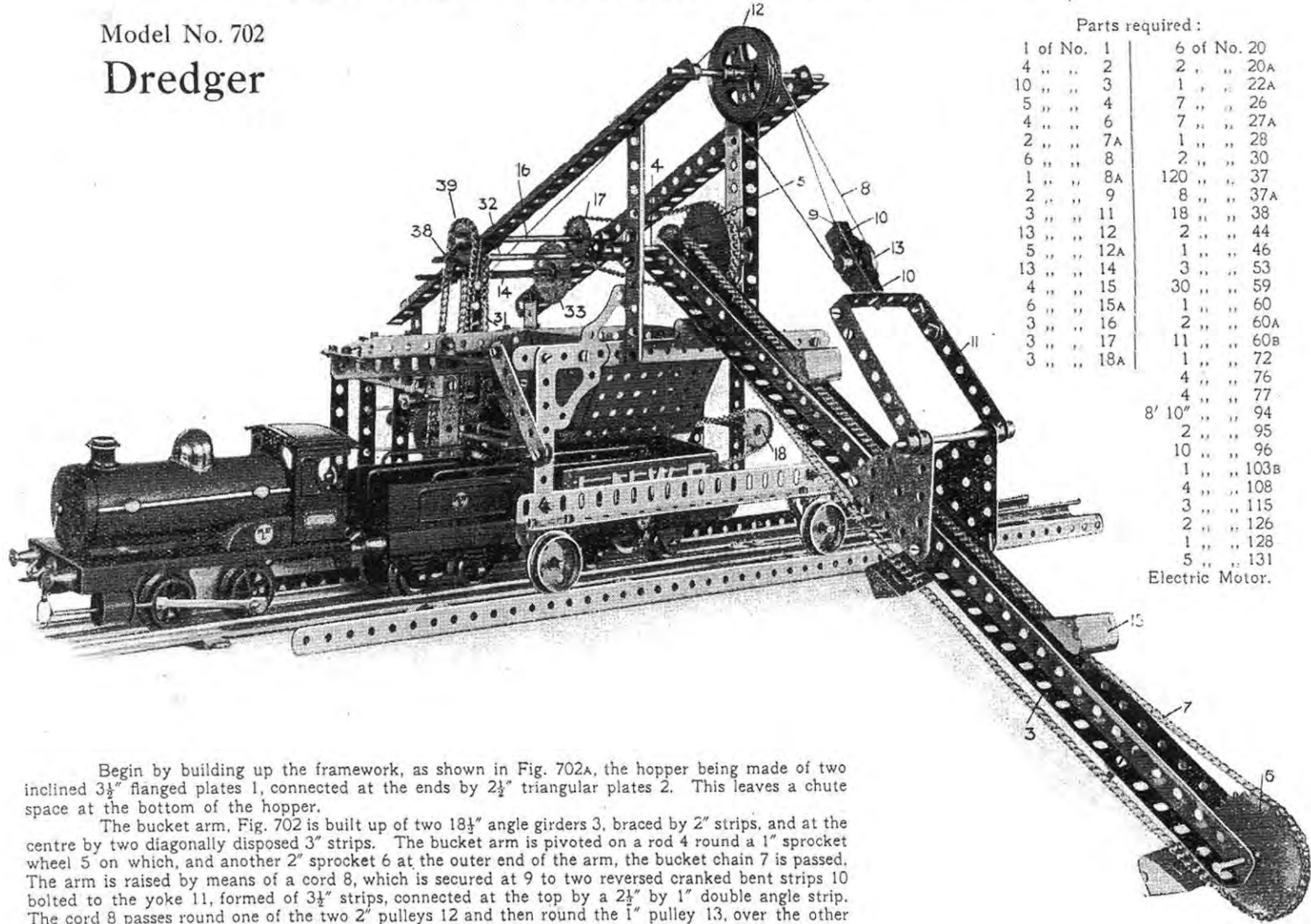
## Meccano Motor Chassis

Model No. 701



The Meccano Motor Chassis is a model of exceptional interest as it provides a complete demonstration of a real Motor Chassis. It is equipped with differential, steering gear and gear box, giving two forward speeds and a reverse. It is underslung and is provided with elliptical leaf-springs. In order to make its construction quite clear a number of sectional photographs and drawings are necessary, and it is impossible to find space for these and the necessary instructions which go with them, in this Manual. We have, therefore, compiled a separate sheet, printed on art paper, containing full instructions and clear illustrations. This may be purchased either from your dealer or from Meccano Limited, Liverpool. Price 3d. (post free 4d.)

Model No. 702  
Dredger



Parts required:

1 of No. 1	6 of No. 20
4 " " 2	2 " " 20A
10 " " 3	1 " " 22A
5 " " 4	7 " " 26
4 " " 6	7 " " 27A
2 " " 7A	1 " " 28
6 " " 8	2 " " 30
1 " " 8A	120 " " 37
2 " " 9	8 " " 37A
3 " " 11	18 " " 38
13 " " 12	2 " " 44
5 " " 12A	1 " " 46
13 " " 14	3 " " 53
4 " " 15	30 " " 59
6 " " 15A	1 " " 60
3 " " 16	2 " " 60A
3 " " 17	11 " " 60B
3 " " 18A	1 " " 72
	4 " " 76
	4 " " 77
	8' 10" " 94
	2 " " 95
	10 " " 96
	1 " " 103B
	4 " " 108
	3 " " 115
	2 " " 126
	1 " " 128
	5 " " 131
	Electric Motor.

Begin by building up the framework, as shown in Fig. 702A, the hopper being made of two inclined  $3\frac{1}{2}$ " flanged plates 1, connected at the ends by  $2\frac{1}{2}$ " triangular plates 2. This leaves a chute space at the bottom of the hopper.

The bucket arm, Fig. 702 is built up of two  $18\frac{1}{2}$ " angle girders 3, braced by 2" strips, and at the centre by two diagonally disposed 3" strips. The bucket arm is pivoted on a rod 4 round a 1" sprocket wheel 5 on which, and another 2" sprocket 6 at the outer end of the arm, the bucket chain 7 is passed. The arm is raised by means of a cord 8, which is secured at 9 to two reversed cranked bent strips 10 bolted to the yoke 11, formed of  $3\frac{1}{4}$ " strips, connected at the top by a  $2\frac{1}{2}$ " by 1" double angle strip. The cord 8 passes round one of the two 2" pulleys 12 and then round the 1" pulley 13, over the other

## Model No. 702—Dredger (continued)

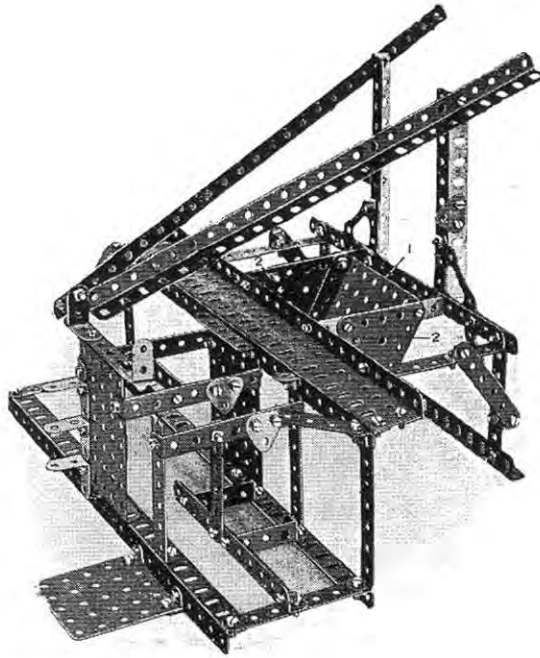


Fig. 702a

2" pulley 12 on to the winding rod 14. The buckets 15 are caused to move round the arm by rotation of the rod 4, which is effected from the rod 16 by chain and sprocket gear 17.

The motor spindle 18, Fig. 702, drives on to the sprocket wheel 19 on a rod 20 on which is a  $\frac{1}{2}$ " pinion 21. The upper and lower rods 22, 23, Fig. 702b, are controlled by their clutch handles 24, 25, and carry 57-toothed gear wheels 26, 27, either of which by sliding their rods may be brought into engagement with the driven pinion 21.

The rod 22, Fig. 702b and 702c, carries a  $\frac{1}{4}$ " pinion 28 which engages a contrate wheel 29, on the rod carrying which is a sprocket 30 which drives by a chain 31 a sprocket,

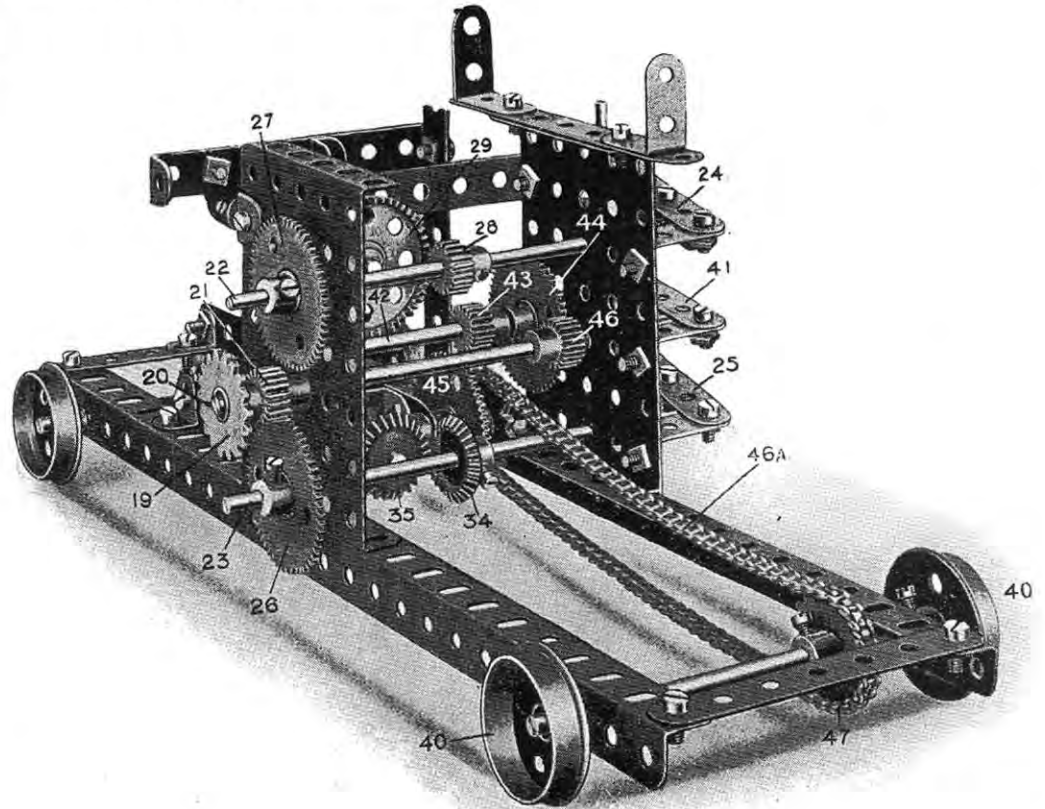


Fig. 702b.

## Model No. 702—Dredger (continued)

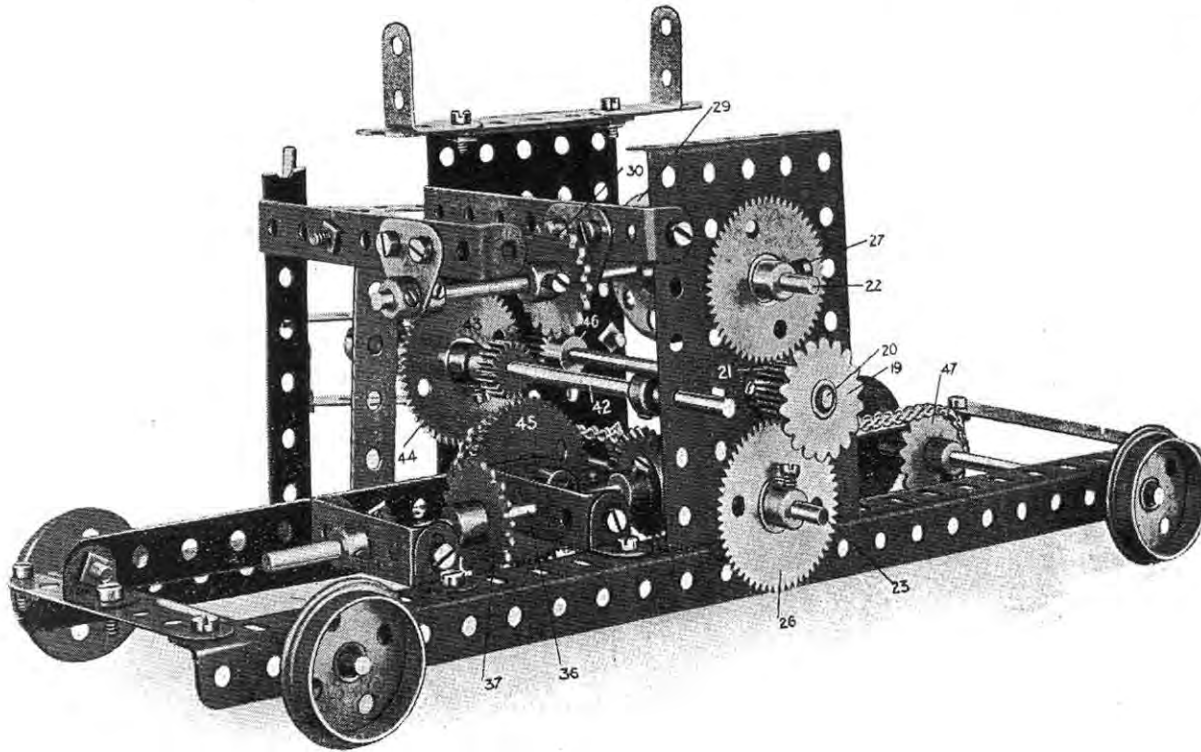


FIG. 702c

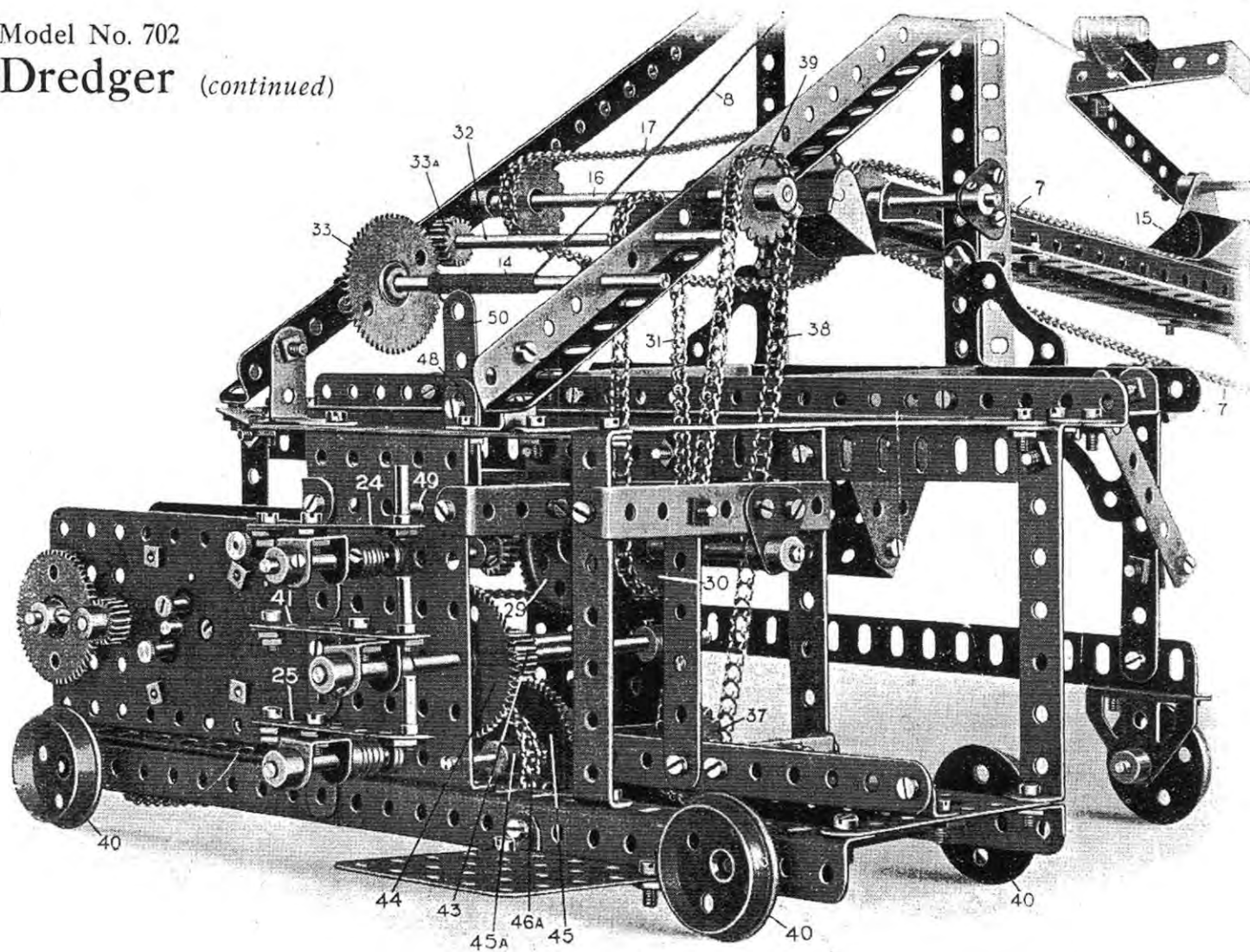
the latter being on the same rod as the pinion 21, whilst the gear wheel 45 is on a short rod, carrying a sprocket 45A, Fig. 702b, which drives through a chain 46A another sprocket 47, Fig. 702b, on the rod of the travelling wheels 40. Consequently, the drive from the motor is taken from the sprocket 19, Fig. 702b, through the pinion 46 and rod 42 to the chain 46A, and so to the sprocket 47 driving the travelling wheels 40. In order to reverse any of the movements, the switch handle of the motor is connected to the bell crank 48 pivoted on the rod 49, Fig. 702b, and provided with a handle strip 50.

on the rod 32, a  $\frac{1}{2}$ " pinion 33A on which engages and drives the gear wheel 33 on the winding rod 14 controlling the cord 8, which raises and lowers the arm. Consequently, by operating the clutch handle 24 the bucket arm may be raised or lowered.

The rod 23, Fig. 702b, similarly may be moved by its clutch arm 25 and the gear wheel 26 brought into engagement with the pinion 21. On the rod 23 is a bevel 34 engaging another bevel wheel 35, on a rod 36, Fig. 702c, on which is a sprocket wheel 37. This sprocket drives by a chain 38, Fig. 702b, a sprocket wheel 39, on the rod 16, which, as previously described, operates the movement of the buckets, which are thus under the control of the clutch handle 25.

The travelling of the apparatus on the wheels 40 is controlled by a middle clutch handle 41, which moves the rod 42, Fig. 702c, this rod carrying a  $\frac{1}{2}$ " pinion 43 and a 57-toothed gear wheel 44, which are operated by the sliding movement of the rod 42 to engage or disengage respectively with a gear wheel 45 and a  $\frac{1}{2}$ " pinion 46,

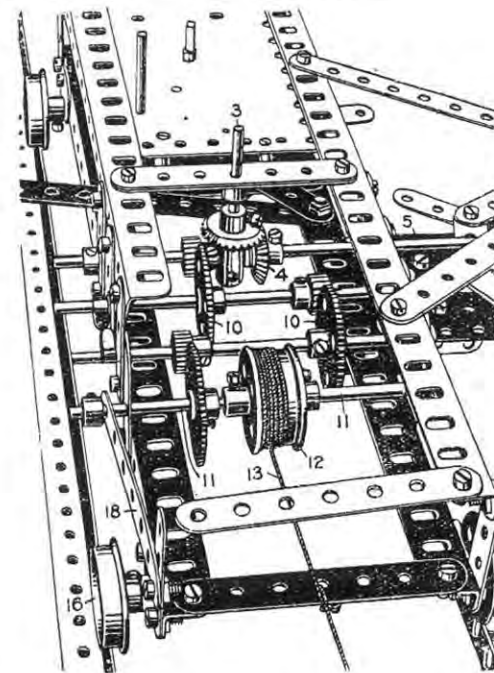
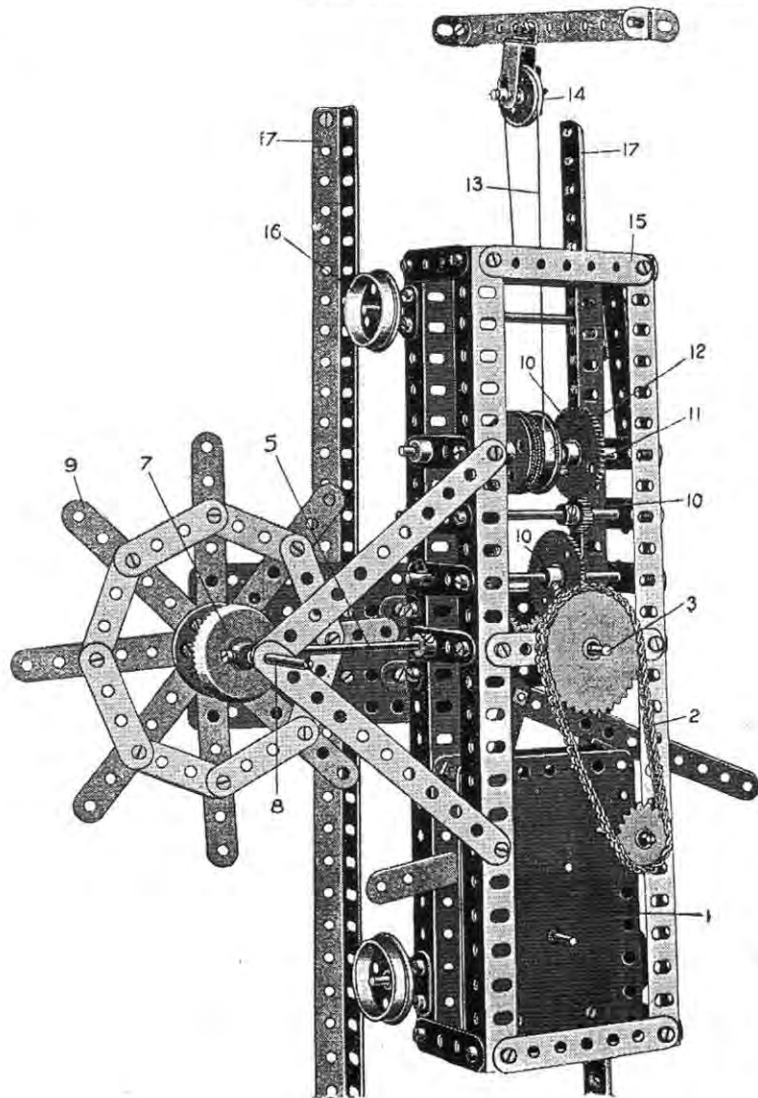
Model No. 702

**Dredger** *(continued)*



Model No. 703

# Coal Cutting Machine



Parts required :

4 of No. 2	4 of No. 26
6 " " 3	3 " " 27A
8 " " 4	1 " " 28
2 " " 6	2 " " 30
2 " " 7	6 " " 35
4 " " 8	75 " " 37
2 " " 9	1 " " 44
9 " " 12	1 " " 50
1 " " 13A	1 " " 52A
5 " " 15	6 " " 59
1 " " 16	1 " " 63
1 " " 17	4 " " 77
1 " " 18A	12 " " 94
6 " " 20	1 " " 95
1 " " 22A	1 " " 96
1 " " 24	1 Clockwork Motor

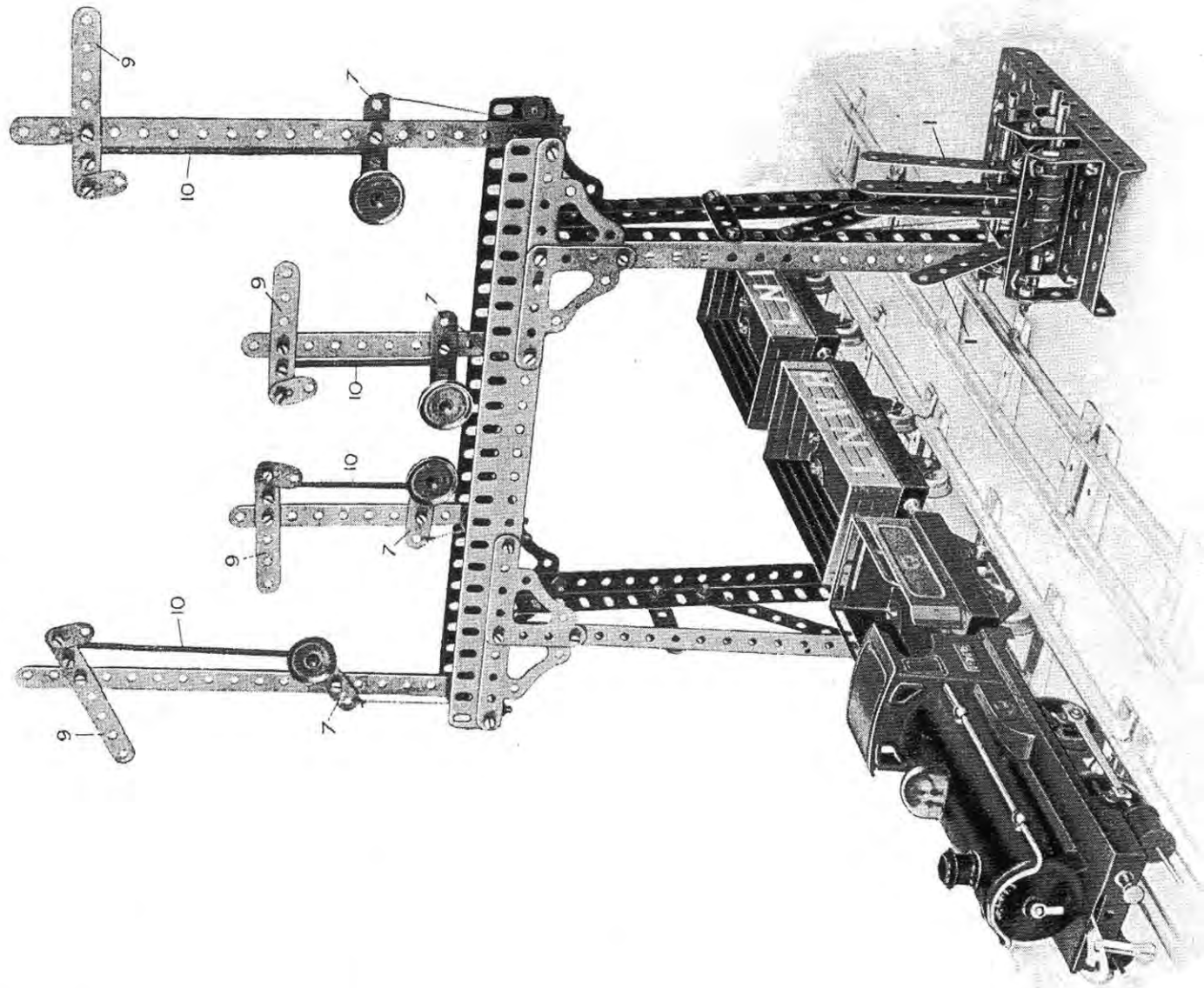
The clockwork motor 1 drives, by the chain and sprocket gear 2, the rod 3, which is connected by bevel wheels 4 to the horizontal rod 5, a  $\frac{1}{8}$ " pinion on the end of which drives a contrate wheel 7 on the rod 8 of the cutting wheel 9. The rod 3 also drives through a gear train 10 a rod 11 on which is a drum composed of two flanged wheels 12. A cord 13 winding from the drum round a pulley 14, is connected to the trolley 15. The pulley 14 is fixed to the trolley 15 which runs on flanged wheels 16 on the rails 17. Consequently, as the cutting wheel 9 is rotated from the motor, the cord 13 is also slowly wound on the drum 12, and the whole carriage moving along, the cutting wheel also travels along the coal face.

The mechanism may be thrown out of gear by pressing the rod 11 which slides in its bearings. The strip 18 forms a spring to hold it in gear.

This Model can be made with MECCANO Outfit No. 7, or No. 6 and No. 6A

Model No. 704

## Signal Gantry



## Model No. 704—Signal Gantry (continued)

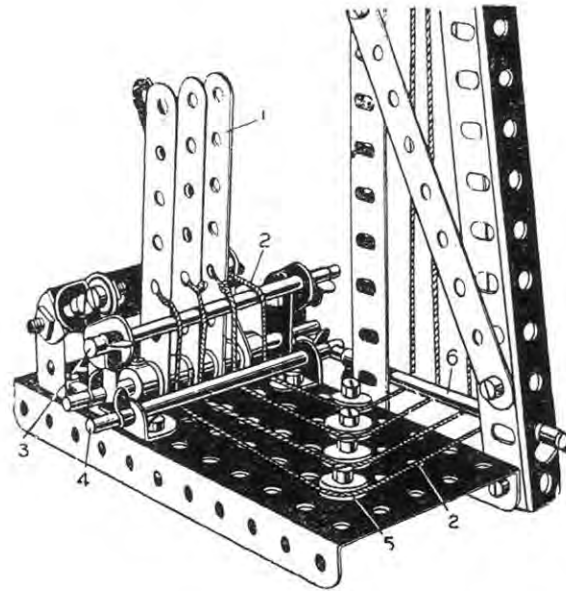


FIG. 704A

The detail views, Figs. 704A and 704B, bring out the construction of the various parts. In Fig. 704A the levers 1 which operate the cords 2 are passed round the upper and lower rods 3 and 4, and round the  $\frac{1}{2}$ " pulleys 5, giving the cords 2 a quarter turn before they pass round the rods 6, thence to the various weighted levels 7, which are connected as shown in Fig. 704B to threaded bosses 8 on the signal arms 9 by threaded rods 10.

Parts required :

2 of No.	1A
2 "	2
2 "	2A
6 "	3
2 "	4
1 "	5
6 "	6
4 "	8A
6 "	10
4 "	12A
4 "	16
1 "	17
4 "	22
8 "	23
4 "	33A
10 "	35
77 "	37
4 "	37B
10 "	38
2 "	46
1 "	52
5 "	59
1 "	60

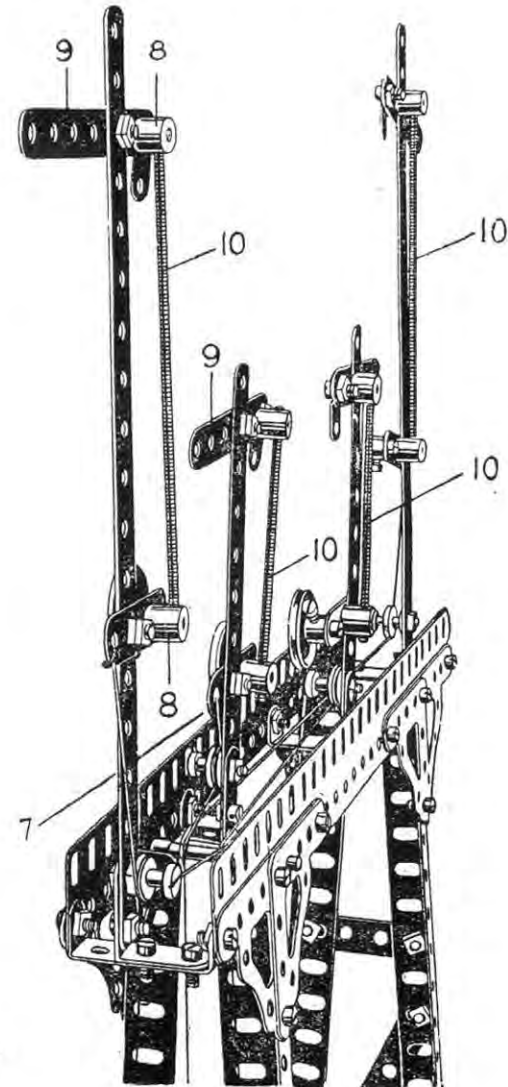
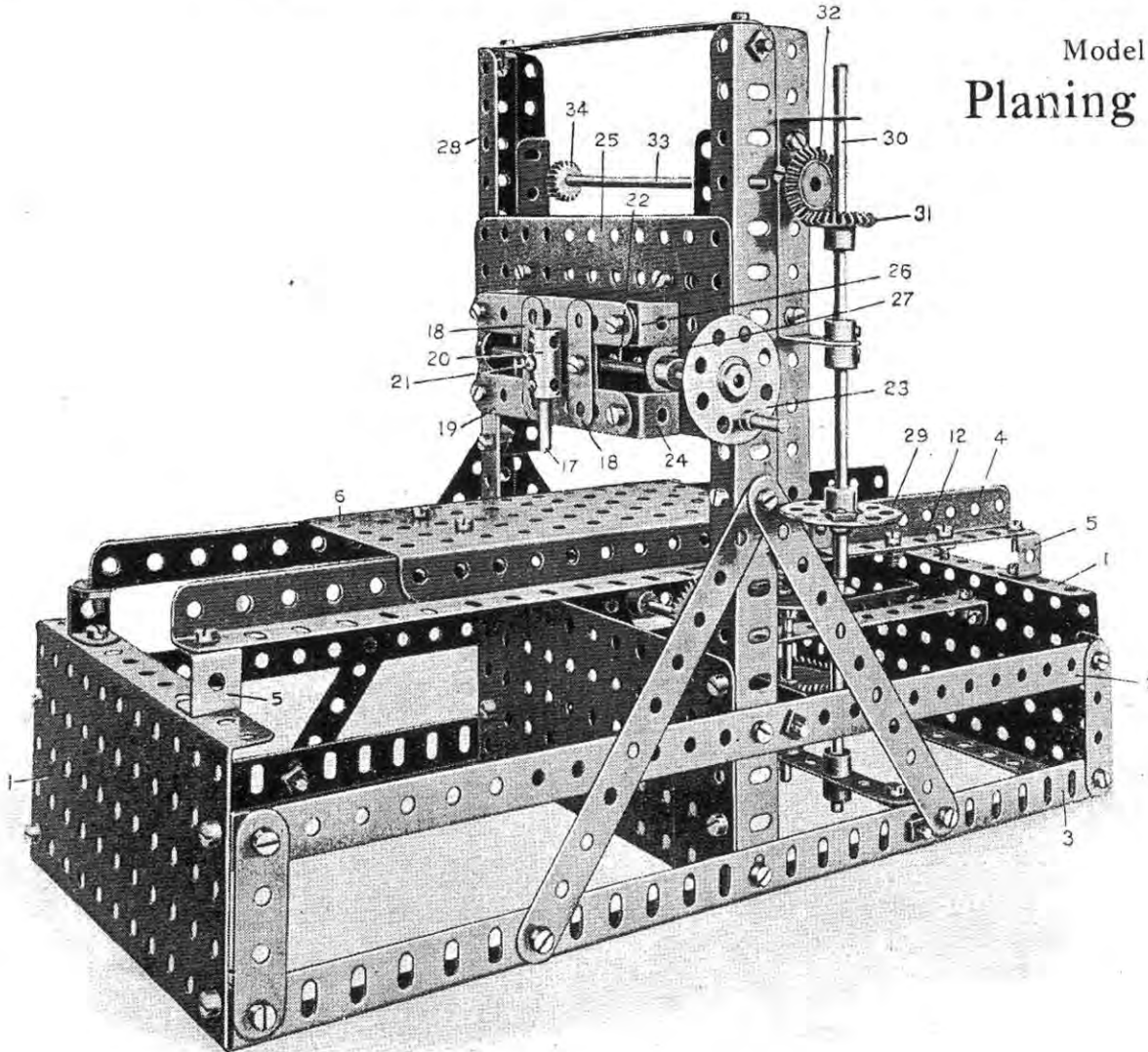


FIG. 704B

## Model No. 705 Planing Machine



Parts required :

2	of No. 1	1	of No. 29
7	" " 2	2	" " 30
3	" " 3	74	" " 37
1	" " 5	3	" " 37A
4	" " 6	9	" " 38
3	" " 6A	2	" " 46
4	" " 8	1	" " 50
2	" " 8A	2	" " 52
8	" " 11	12	" " 59
12	" " 12	1	" " 60B
1	" " 14	5	" " 60c
1	" " 15	1	" " 63
5	" " 16	1	" " 64
1	" " 18A	2	" " 70
2	" " 20	1	" " 80
3	" " 24	2	" " 103
5	" " 26	2	" " 110
2	" " 27A	2	" " 115

## Model No. 705—Planing Machine (continued)

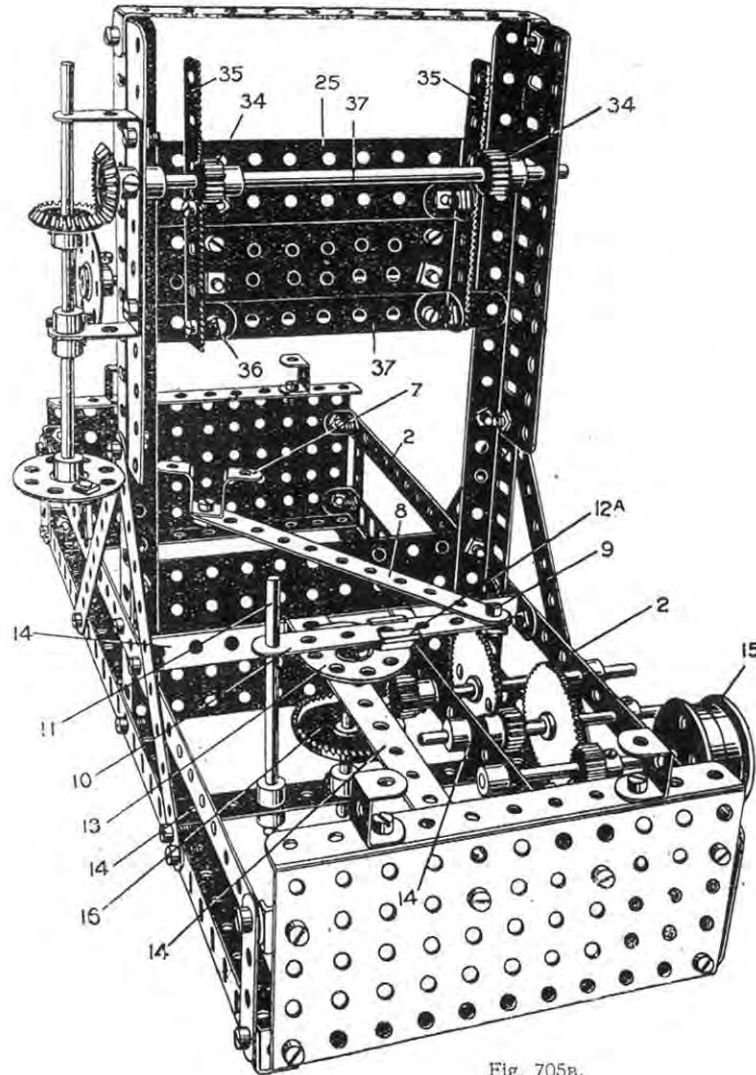


Fig. 705B.

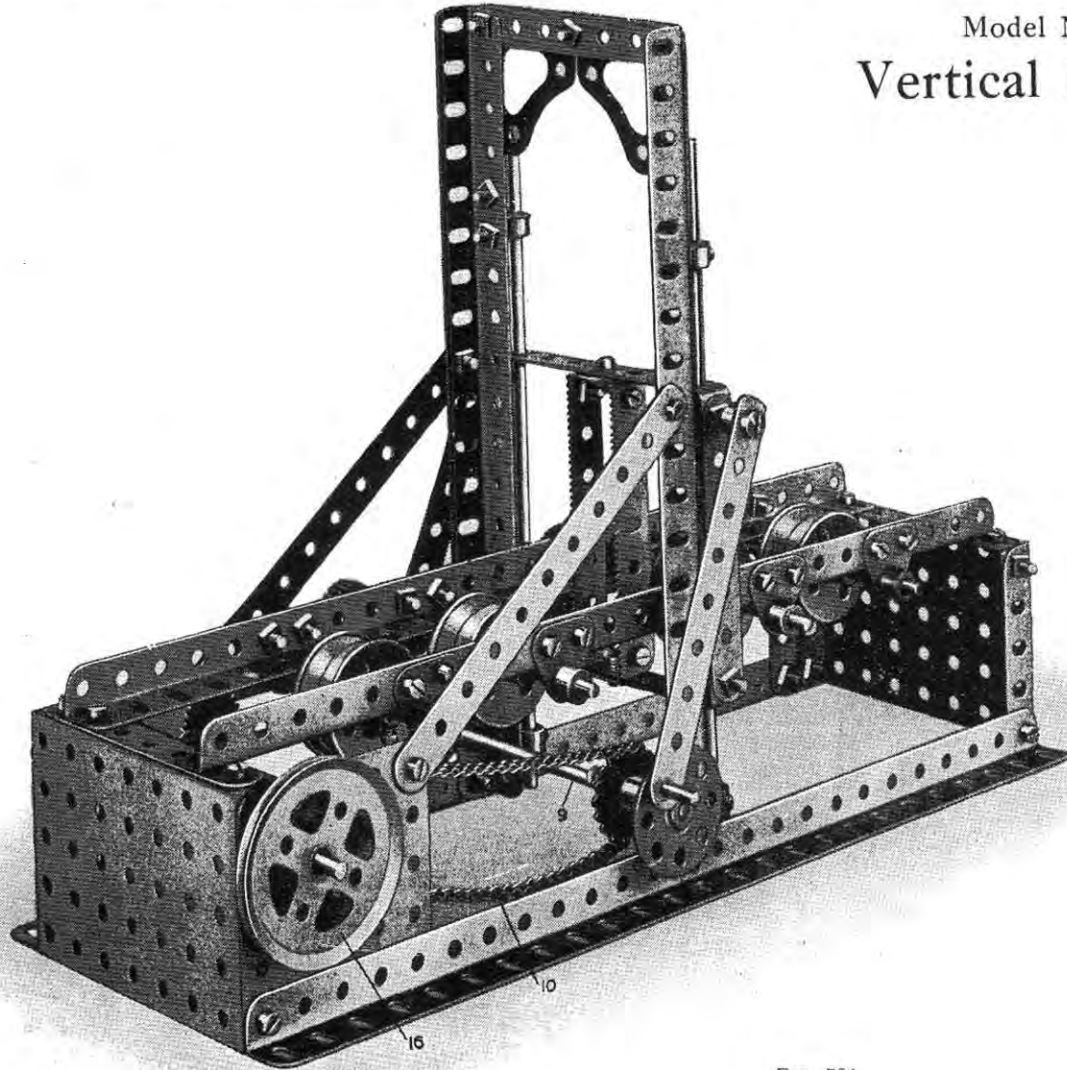
Fig. 705A is a perspective view from the front.

Fig. 705B is a rear view.

The main frame is built up from  $5\frac{1}{2}$ " flanged plates 1, connected by angle brackets to  $12\frac{1}{2}$ " strips 2 and lower angle girders 3. Angle girders 4 are bolted to the flanged plate 1 by double brackets 5. These angle girders 4 form the rails upon which the table 6 of the planer slides. The table consists of a  $5\frac{1}{2}$ " flanged plate. The table is moved to and fro, being bolted by the double bent strip 7, Fig. 705B, to a  $5\frac{1}{2}$ " strip 8 the end of which is attached at 9 to a  $3\frac{1}{2}$ " strip 10, pivoted on a rod 11. The strips should be lock-nutted to allow free movement. The rod 11 passes through one of the elongated holes in the angle girder 4, and to prevent play of the rod a  $2\frac{1}{2}$ " strip 12 is bolted on the flange of the angle girder 4, and in the end hole of this strip the top of the rod 11 is pivoted. The strip 10 engages an eye piece 12A bolted to a bush wheel 13. The eye piece is lock-nutted on the bush wheel, so that while held to the bush wheel it may rotate freely about the bolt as a pivot. Consequently, as the wheel 13 rotates, the table 6 will be moved in one direction, while cutting, more slowly than on the return movement when the work is being brought back. A gear framing by which the bush wheel 13 is driven is made by  $5\frac{1}{2}$ " by  $\frac{1}{2}$ " double angle strips 14, Fig. 705B. The gear is driven from the belt pulley 15, formed of two flanged wheels reversed. The gear train may be clearly followed from the illustration, terminating in a pinion driving the contra wheel 16, secured on the bush wheel rod.

The traversing movement of the cutting tool 17 is effected by means of a guide, formed of two  $1\frac{1}{2}$ " strips 18, bolted to two corresponding strips at the rear of the horizontal  $3\frac{1}{2}$ " strips 19, a middle spacing  $1\frac{1}{2}$ " strip being horizontally arranged between the strips 18. The cutting tool 17 is carried on a coupling 20, which is connected by a threaded pin 21, to a threaded boss on a feed screw 22, which is operated from the bush wheel 23, Fig. 705A. The horizontal strips 19 are supported by double angle brackets 24 from the face plate 25, and washers 26 are placed beneath the nuts on the strips 19, in order to give the necessary distance at the rear for clearance for the threaded boss on the threaded rod 22. The threaded rod 22 is journaled in the ends of a  $3\frac{1}{2}$ " by  $\frac{1}{2}$ " double angle strip 27, bolted to the plate 25. The vertical movement of the plate 25 on the upright angle girders 28 is effected from the bush wheel 29 mounted on a rod 30, a bevel wheel 31 engaging a corresponding bevel 32 on a rod 33, carrying 2 pinions 34, which engage the racks 35, secured by angle brackets 36 to  $5\frac{1}{2}$ " strips 37, bolted to the plate 25, with spacing washers between, so that a clearance is provided between the ends of the strips 37 and the plate 25, to engage in a sliding movement round the flanges of the angle girders 28.

Model No. 706  
Vertical Log Saw



## Parts required

2 of No.	2
2 "	2A
5 "	3
1 "	6
4 "	8
2 "	8A
12 "	12
2 "	12A
1 "	13
2 "	13A
1 "	15
4 "	15A
2 "	16
8 "	20
1 "	20A
2 "	24
2 "	25
1 "	26
1 "	27A
2 "	30
2 "	32
2 "	33A
59 "	37
6 "	37A
2 "	53
17 "	59
2 "	60B
2 "	72
10 "	77
12 "	94
2 "	95
2 "	108
2 "	110
2 "	115

FIG. 706

## Model No. 706—Vertical Log Saw (continued)

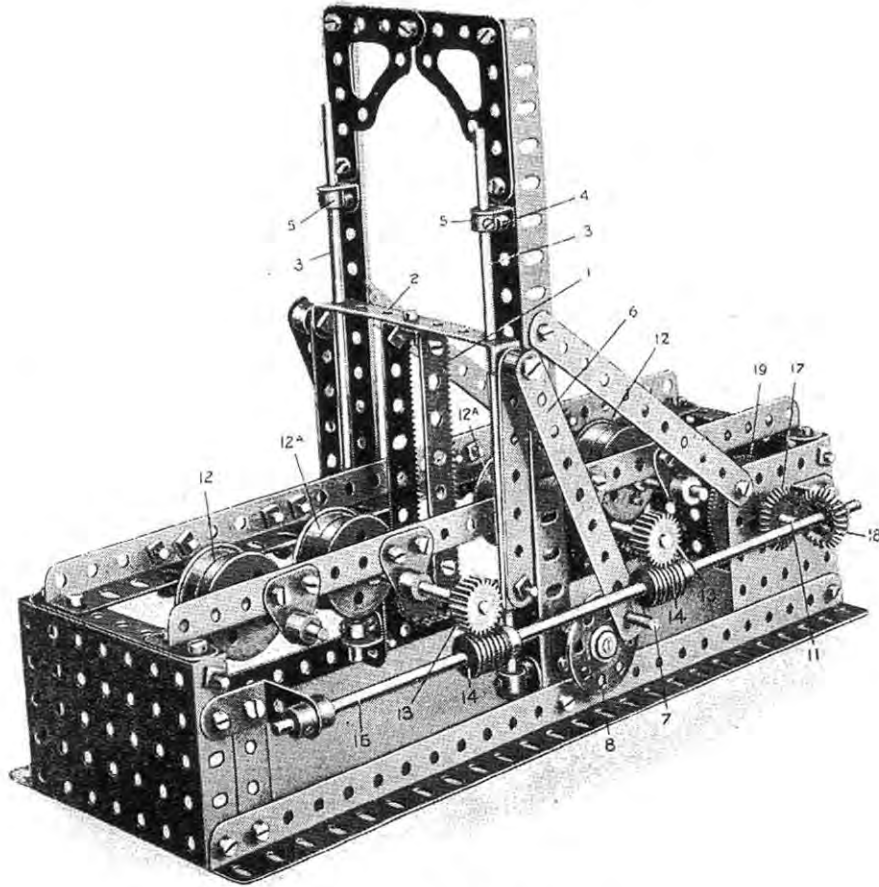


FIG. 706A.

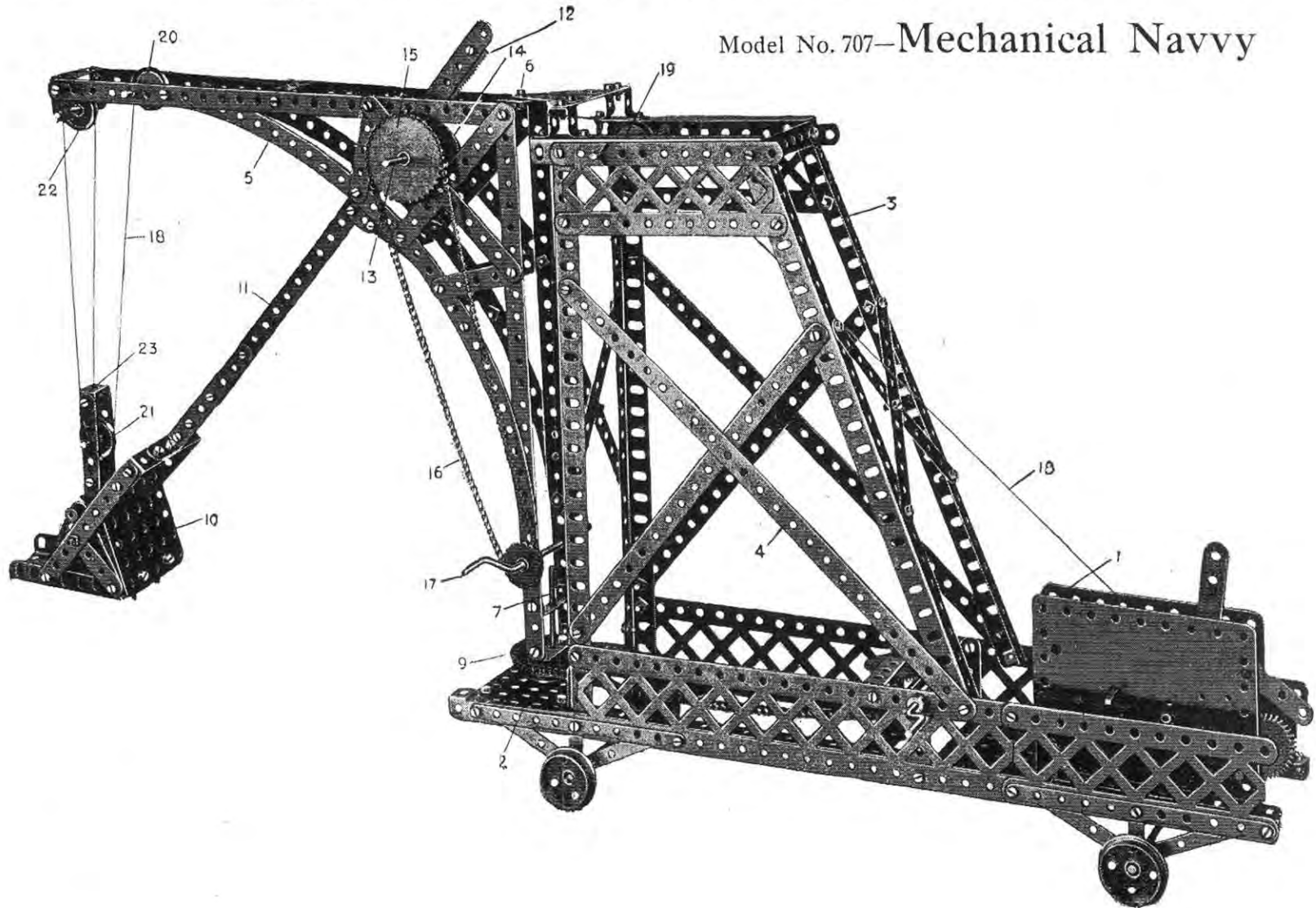
This is a model of a machine used for sawing logs into planks.

Fig. 706 is a front perspective view of the log saw, and Fig. 706A a rear perspective view.

The saws represented by the rack strips 1 are carried in a vertical moveable frame 2 which slides on the rods 3 as guides. These rods 3 are rigidly held in the angle brackets 4 by the collars 5. The saw frame is reciprocated on the guide rods 3 by the link strips 6, connected to the frame 2 by pivot bolts lock-nutted to the frame and spaced with collars and the lower holes engage the threaded pins 7 on the bush wheels 8, the rod 9 of which is connected by a sprocket chain 10 to a sprocket wheel on the spindle 11. The log is caused to move past the saws by being supported on the pairs of reversed flanged wheels 12 and 12A, the centre pairs of which are positively driven from the  $\frac{3}{4}$ " pinions 13, which are engaged by the worm 14 on the rod 15. The movement of the flanged pulleys 12A and of the saws 1 are both effected from the 2" pulley wheel 16, the rod of which carries a  $\frac{1}{2}$ " pinion engaging a 56-toothed wheel 19 on the rod 11. At the outer end of this rod 11 is a bevel wheel 17 engaging a corresponding bevel 18 on the rod 15. Consequently, if the pulley wheel 16 be driven, the saw frame is reciprocated vertically, and the centre pairs of the flange wheels rotated, causing the log to be fed towards the saws. The opposite end of the rod carrying the pulley wheel 16 passes through one of the holes of the 1" angle bracket forming the bearing for the rod 15.

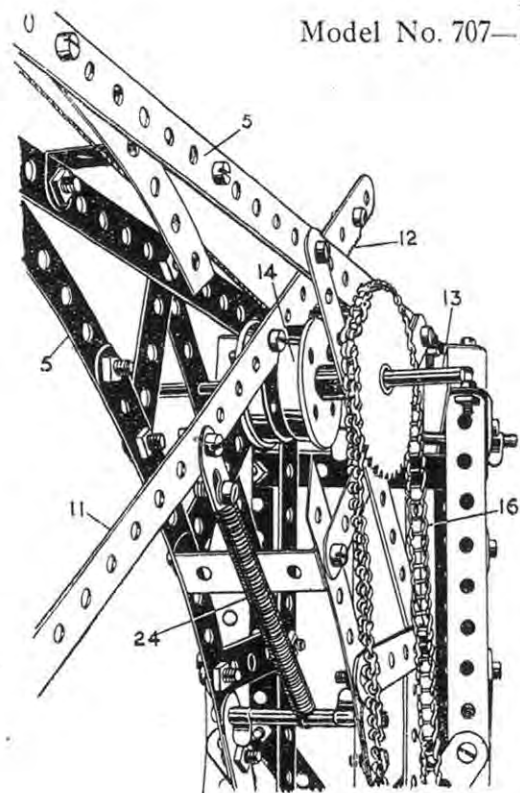
This Model can be made with MECCANO Outfit No. 7, or No. 6 and No. 6A

## Model No. 707—Mechanical Navyy





## Model No. 707—Mechanical Navy *(continued)*



Parts required :

7 of No.	1	2 of No.	27A
2 "	1A	1 "	32
6 "	2	17 "	35
4 "	2A	129 "	37
4 "	3	1 "	37A
2 "	4	3 "	38
4 "	5	1 "	43
4 "	6	2 "	45
2 "	7A	1 "	46
4 "	8	1 "	52A
2 "	9	1 "	53A
3 "	10	7 "	59
2 "	11	5 "	60A
3 "	12	1 "	60B
3 "	12A	1 "	72
2 "	15	6 "	89
1 "	15A	48 "	94
4 "	16	2 "	95
4 "	17	2 "	96
1 "	18A	2 "	99
2 "	19	4 "	100
6 "	20	1 "	110
2 "	22	4 "	113
4 "	22A	2 "	114
1 "	26		

Fig. 707A

In this model the framework can be readily built up from the information given in the illustration, the motor 1 being bolted on the lower platform 2 and the superstructure 3 being made up of angle girders at the corners and braced at 4. The jib 5 is pivotally carried by the bolt 6 at the top in the triangular plate and on a short rod 7 on the foot, a chain and sprocket gear 9 being provided to swing the jib. The bucket or grab 10 is mounted on the ram 11 to the upper part of which a rack 12 is bolted engaged by a pinion on the rod 13 mounted between two flanged wheels 14. A sprocket 15 on the rod 13 is engaged by a chain 16 operated from the cranked handle 17 so that by turning the handle 17 the bucket 10 may be adjusted. The bucket 10 is raised or lowered by the cord 18 which passes from the motor 1 over a pulley 19 and another pulley 20 at the end of the jib and round the lower pulley 21 on the bucket returning up round a second pulley 22 on the jib and being made fast to the bucket at 23. Springs 24, Fig. 707A, are provided to keep the rack 12 in engagement with the pinion.

This Model can be made with MECCANO Outfit No. 7, or No. 6 and No. 6A

## Model No. 708— Meccanograph

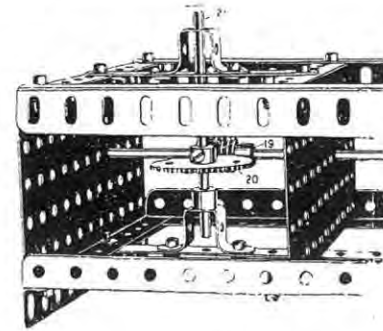


FIG. 708A

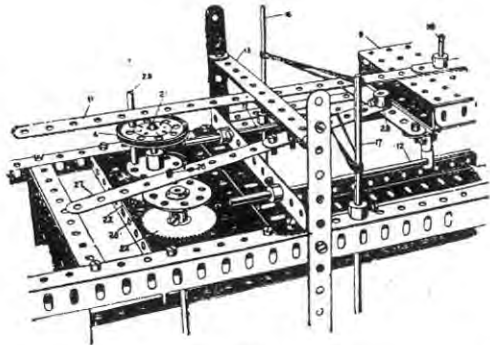
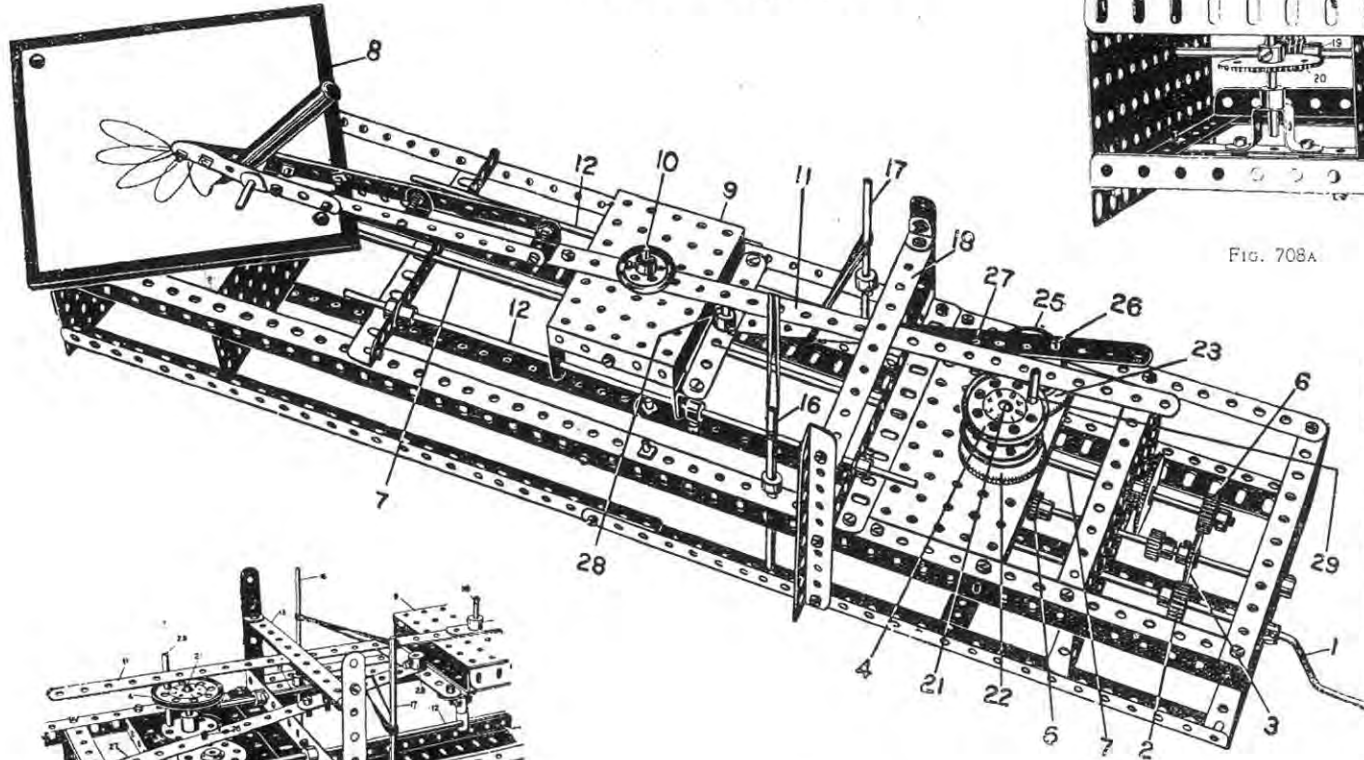


FIG. 708B

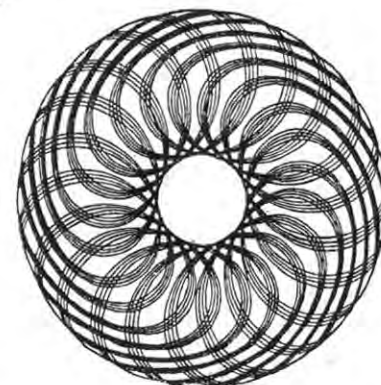
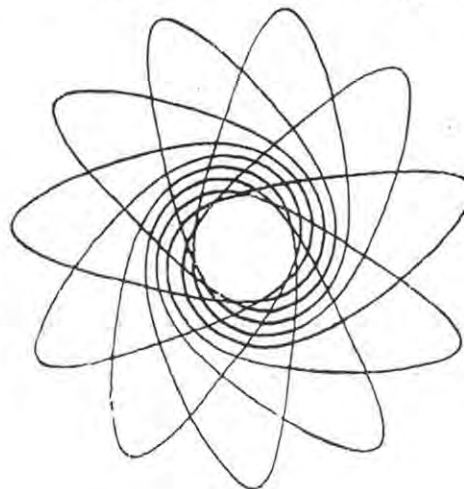
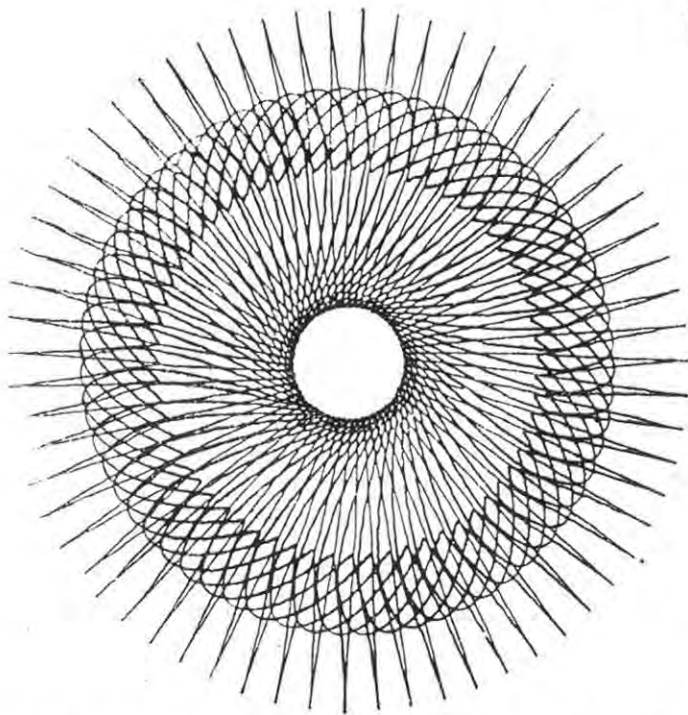
Parts required :

3 of No. 1	1 of No. 24
8 " " 2	2 " " 25
5 " " 3	2 " " 26
8 " " 8	1 " " 27
5 " " 9	4 " " 27 1/2
3 " " 11	1 " " 28
4 " " 12	1 " " 32
4 " " 13	87 " " 37
2 " " 14	2 " " 38
1 " " 15	2 " " 45
1 " " 15A	2 " " 46
2 " " 16	5 " " 52
5 " " 17	2 " " 53
1 " " 19	15 " " 59
2 " " 21	1 " " 63
1 " " 22	1 " " 107

This is a model of extraordinary interest, and we hope that all Meccano boys will build it. With it any boy can make an amazing variety of exquisite designs by fixing a sheet of paper and pencil in position and turning the handle.

We have reproduced on the next page one or two neat designs which have been made with this instrument and these could be supplemented by thousands of others if we had the space. We must content ourselves by saying that there is no limit whatever to the variety and beauty of the designs which may be made by simply varying the adjustments. When tastefully filled in with different tints of water colours, the effect is most pleasing.

## Model No. 708—Meccanograph *continued.*



the bolt 26 engages the same perforation in the strip 27, a different design may be further varied. The strip 27 may also be caused to engage by any of its perforations with the bolt 26.

TABLE.—The table has a bush wheel screwed on the underside and is secured on the upright spindle 21 by the set-screw of the bush wheel.

CARRIAGE.—The carriage 9 slides along the rods 12, or is secured to them by collars and set-screws, its position being decided by the adjustment of the arm 11 according to the designs to be produced.

ARM.—The arm 11 is formed of two  $12\frac{1}{2}$ " strips bolted together, on which a  $5\frac{1}{2}$ " strip overlapped 7 holes is fastened. The holder is connected to this  $5\frac{1}{2}$ " strip by means of double brackets. The near end of the arm 11 slides between two  $5\frac{1}{2}$ " strips 18, which are spaced with washers to permit a free movement.

To overcome any slack movement of the arm when working, thin rubber bands are passed around it and connected with upright rods 16 and 17.

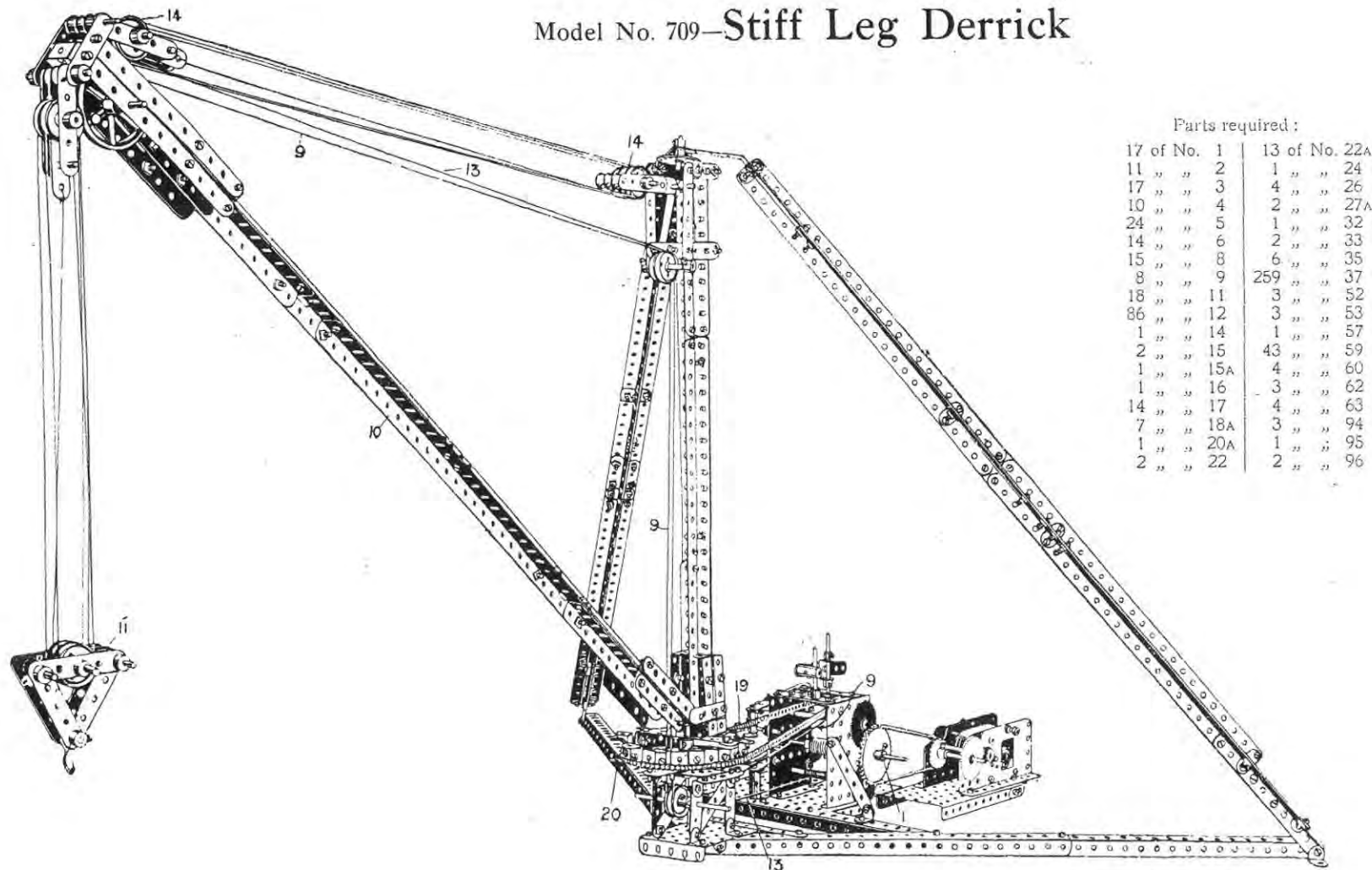
Care should be taken to see that all parts of the model work smoothly, and that no jolting takes place, otherwise the lines of the design will be uneven. The Meccanograph is driven from the handle 1 on which is a 25-toothed pinion 2 engaging a 50-toothed gear wheel 3 on the axle of which is a 20-toothed pinion 5 engaging an inverted crown wheel on the spindle 21. The gear wheel 3 drives a 25-toothed pinion 6 on an axle rod 7 extending along to the table, and by means of a worm 19 (see Fig. 707A) drives a 56-toothed gear wheel 20 on the upright spindle to which the rotating table is fixed.

Meccano users who are interested in this model should purchase the full Meccanograph manual (post free 8d), containing full detailed instructions and a full range of illustrations with formulæ.

The upright spindle 21 is driven by gearing, but below the crown head is fitted a 56-toothed gear wheel 22, which meshes with a similar gear wheel 23. On the spindle 24 of this latter gear wheel is

secured a bush wheel 25, in one of the holes of which is secured a bolt 26 which engages in one of the holes of a perforated strip 27 pivotally connected at 28 to the carriage. As the bush wheel 25 rotates it slides the carriage to and fro. The arm 11 pivotally mounted on the rod 10 of the carriage is transversely moved by the action of a short rod 29, fitted in one of the holes of the crown head 4. These holes in the crown head are numbered by means of a paper disc, which may be gummed on to the wheel. In fitting up the instrument it should be noted that hole No. 1 comes directly opposite to bolt 26. By changing the position of the rod 29 while the

## Model No. 709—Stiff Leg Derrick



## Special Meccano Model No. 709—Stiff Leg Derrick (continued)

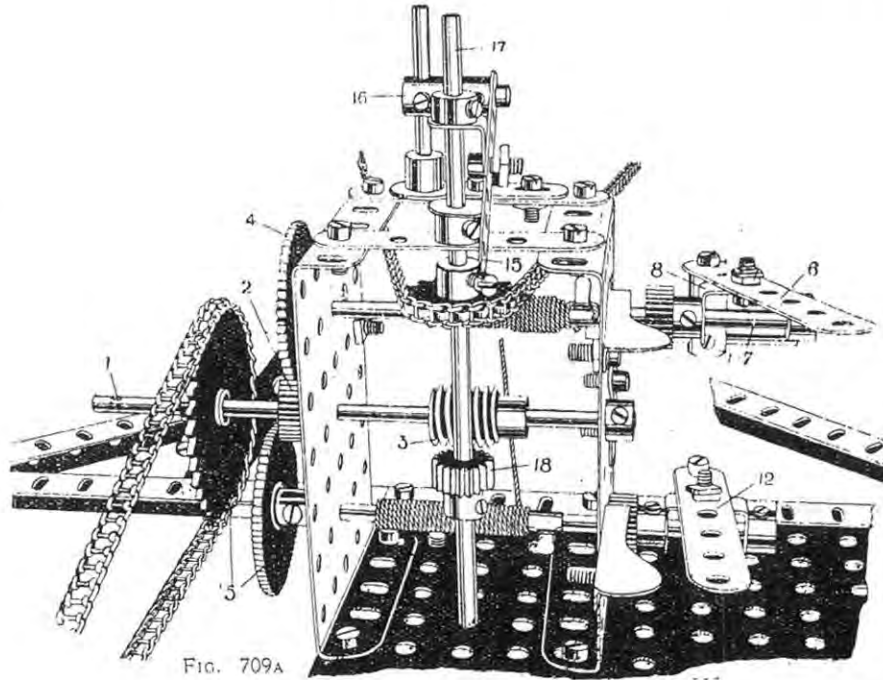


FIG. 709A

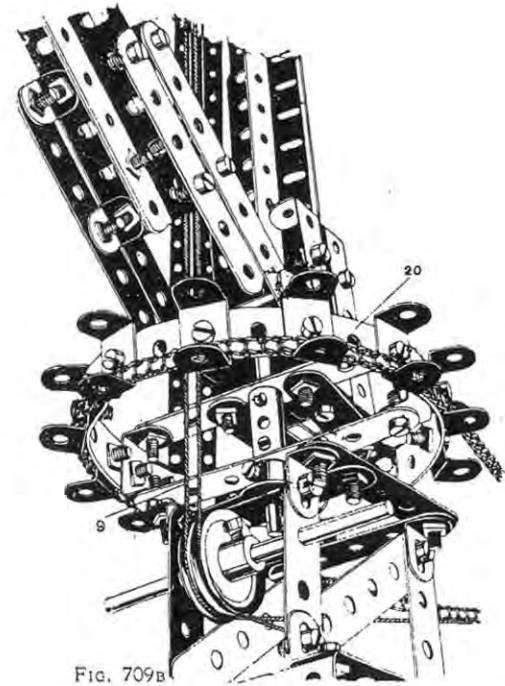


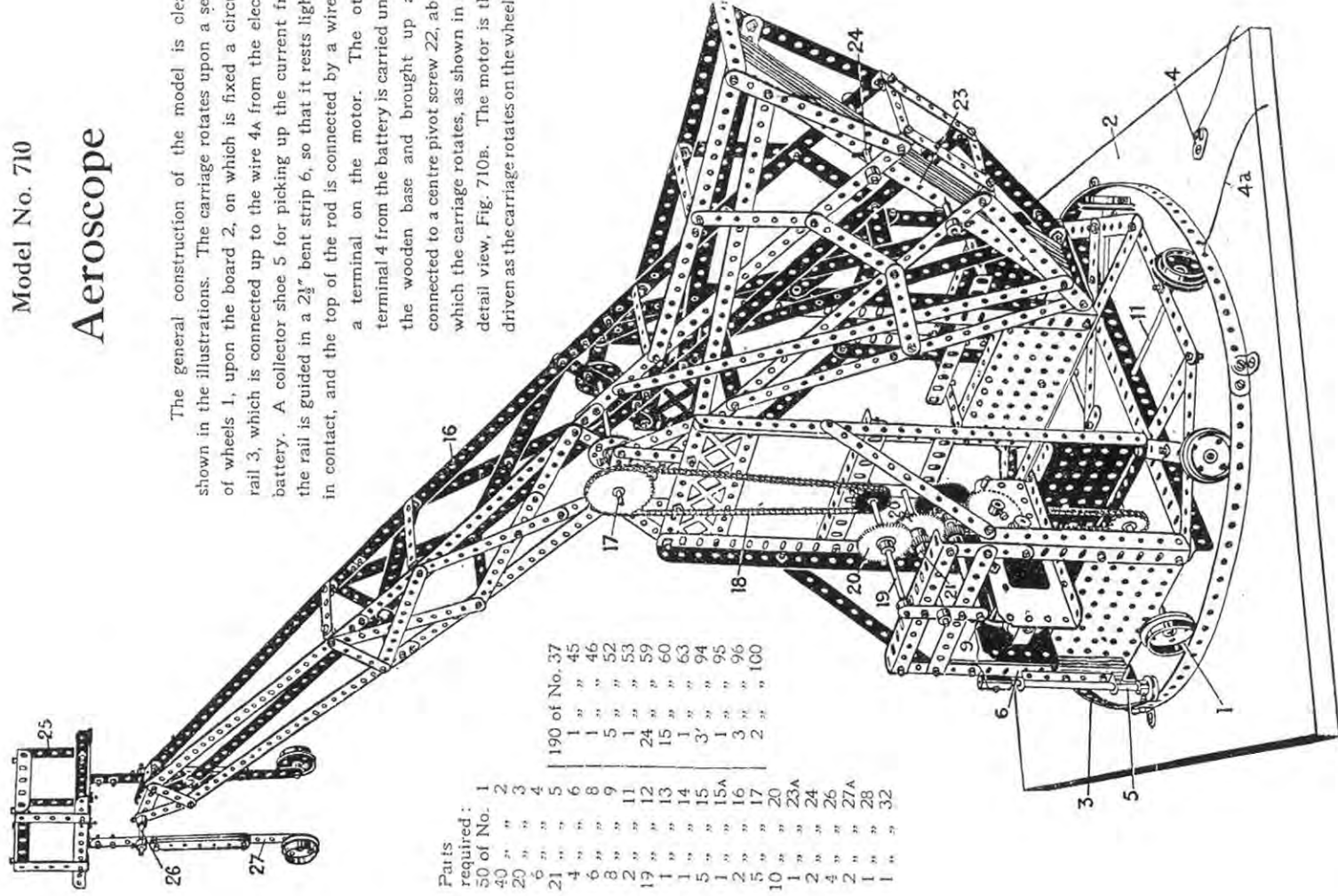
FIG. 709B

There are three motions in this Crane. hoisting, swinging and luffing the jib.

The main driving spindle 1 geared by chain and sprocket to the motor carries a pinion 2 and a worm 3. With the pinion 2 one or other of the gear wheels 4, 5 are engaged according as to whether the load is to be raised or the jib luffed. The spindles of the gear wheels are slidable in their bearings, and a lever 6, pivoted to a coupling 7 and pivotally bolted to a double bracket 8 on the hoisting spindle, is adapted to move the gear 4 into or out of engagement with the pinion 2, the cord 9 winding on or off the spindle. This cord passes round the purchase block 11. To luff the jib 10 the lower strip 12, pivoted like the upper one to a coupling and connected to a double bracket on the spindle of the gear wheel 5, is moved bringing the gear 5 into engagement with the pinion 2, the luffing cord 13 passing round the pulleys 14. To swing the jib a third lever 15, pivoted to a coupling 16, is connected by a double bracket to a vertically slidable rod 17, which carries a pinion 18. By moving the handle 15 the pinion is engaged or disengaged with the worm 3 on the main shaft and the jib swung round by reason of a chain and sprocket gear 19 passing round a wheel 20 formed by a bent  $12\frac{1}{2}$ " strip having double brackets bolted on its circumference.

## Model No. 710 Aeroscope

The general construction of the model is clearly shown in the illustrations. The carriage rotates upon a series of wheels 1, upon the board 2, on which is fixed a circular rail 3, which is connected up to the wire 4A from the electric battery. A collector shoe 5 for picking up the current from the rail is guided in a 2½" bent strip 6, so that it rests lightly in contact, and the top of the rod is connected by a wire to a terminal on the motor. The other terminal 4 from the battery is carried under the wooden base and brought up and connected to a centre pivot screw 22, about which the carriage rotates, as shown in the detail view, Fig. 710b. The motor is thus driven as the carriage rotates on the wheels 1.



Parts required:	190 of No. 37
50 of No. 1	1
40 " 2	1
20 " 3	5
6 " 4	1
21 " 5	1
4 " 6	5
6 " 8	1
8 " 9	1
2 " 11	24
19 " 12	15
1 " 13	1
1 " 14	3
5 " 15	1
1 " 16	3
2 " 17	2
5 " 20	
10 " 23A	
2 " 24	
4 " 26	
2 " 27A	
1 " 28	
1 " 32	

## Model No. 710—Aeroscope *(continued)*

The rotation of the carriage is effected from the pinion 7, which gears with and drives a gear wheel on the spindle 8, on which latter is a worm gearing with a gear wheel 9, the spindle of which latter drives through the sprocket chain 10 and rod 11 on the outer ends of which are fixed flanged pulley wheels 12.

The wheels 12 at each end of the rod 11 are caused to rotate in opposite directions by means of the gear shown in Fig. 710B, the rod 11 being divided and two pinions 13 and 14, secured on the separate parts of the rod, gearing with a contrate wheel 15, so that the flanged wheels at each end rotate in opposite directions. The end of one part of rod 11 is entered into the bore of the pinion 14, which is secured on the other part of the rod, the pinion 14 thus supporting the end of the other part of the rod 11.

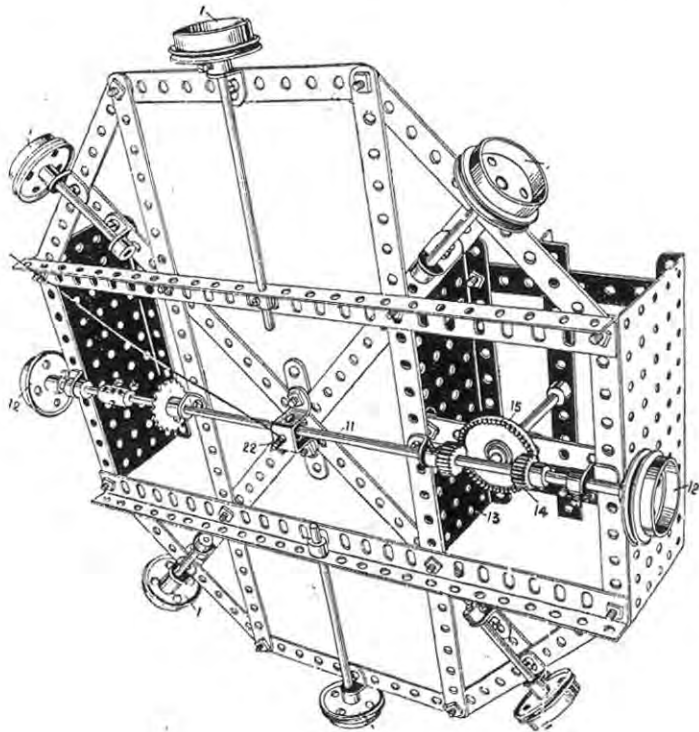


FIG. 710A

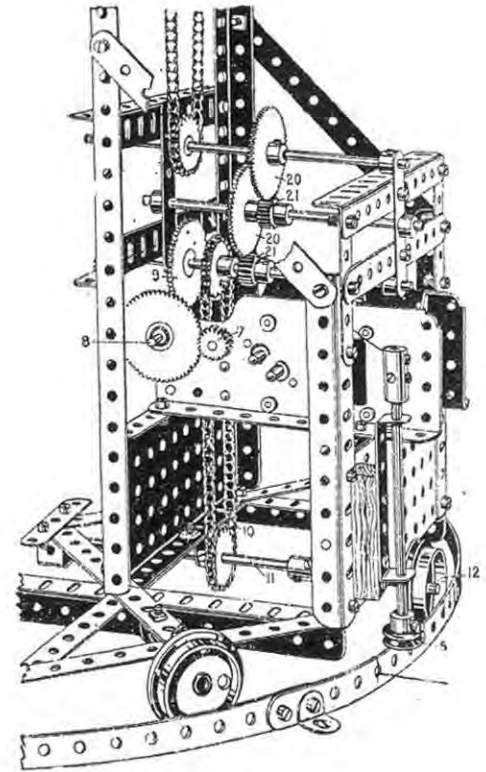
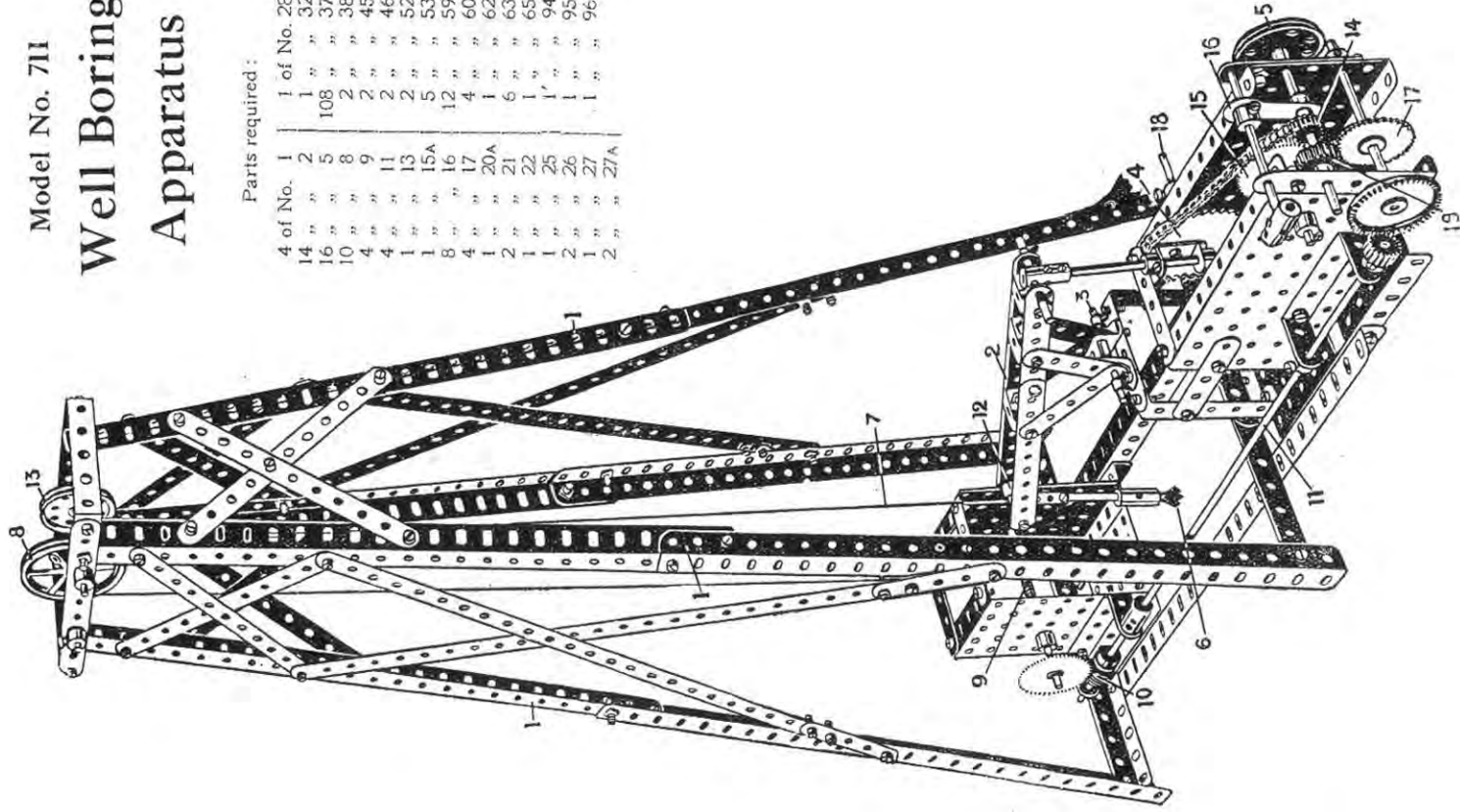


FIG. 710B

The weighted arm 16 is caused to swing about its pivot rod 17 by means of chain and sprocket gear 18 driven from a spindle 19 through a train of gears 20 and pinions 21 from the spindle 9. The arm 16 is balanced by a number of  $12\frac{1}{2}$ " strips 23, threaded on rods 24, secured to the framework. At the opposite end of the arm the carriage 25 is pivoted on a rod 26, which passes through strips 27, these being suitably weighted by a number of strips and flanged wheels, so that the carriage always remains vertical while the arm swings over.

## Model No. 711 Well Boring Apparatus



Parts required:

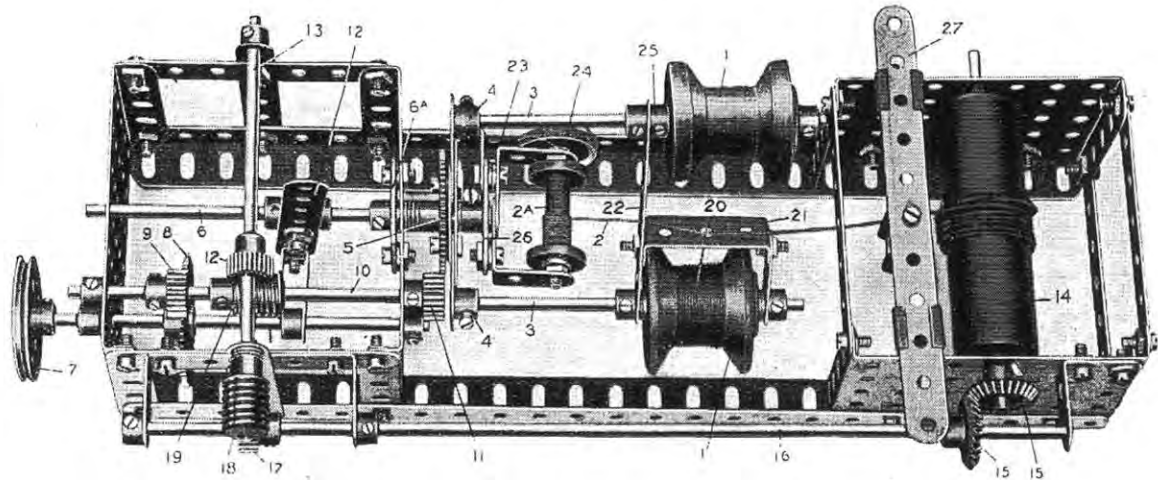
4 of No.	1	1 of No.	28
14 "	2	1 "	32
16 "	5	108 "	37
10 "	8	2 "	38
4 "	9	2 "	45
4 "	11	2 "	46
1 "	13	5 "	52
1 "	15A	2 "	53
1 "	16	12 "	59
4 "	17	4 "	60
1 "	20A	1 "	62
2 "	21	6 "	63
1 "	22	1 "	65
1 "	25	1 "	94
2 "	26	1 "	95
1 "	27	1 "	96
2 "	27A		



## Model No. 712—Wire Covering Machine

### Parts required :

1 of No. 2	2 of No. 27a
7 " " 3	2 " " 30
2 " " 4	2 " " 32
1 " " 5	41 " " 37
2 " " 6A	17 " " 38
2 " " 8	2 " " 44
1 " " 10	1 " " 46
2 " " 12	2 " " 50
3 " " 12A	4 " " 53
1 " " 13	12 " " 59
3 " " 15	1 " " 60A
4 " " 15A	2 " " 62
1 " " 21	1 " " 63
1 " " 22	1 " " 81
2 " " 24	1 " " 106
4 " " 26	1 " " 301



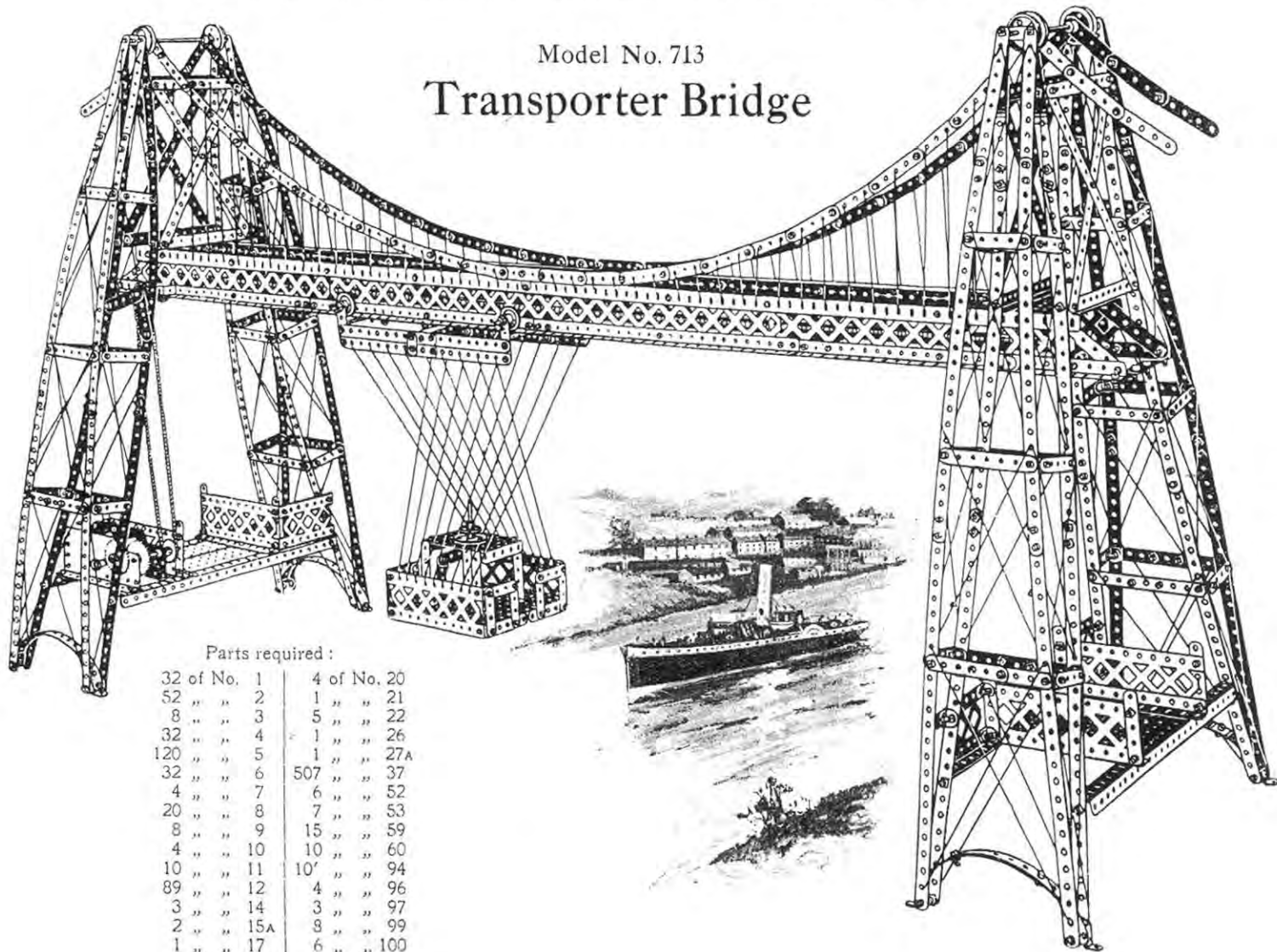
The bobbins 1, carrying the thread by means of which the wire 2 is covered, are carried in a yoke consisting of two rods 3, secured in cranks 4, between a  $2\frac{1}{2}$ " and  $1\frac{1}{2}$ " strip, and bolted to a 57-toothed gear wheel 5, rotatable loosely on a fixed 5" rod 6. On the rod 6, is a bush wheel 6A, bolted thereto and to the frame. This holds the rod against rotation. The bobbin 2A is carried in the two 1" angle brackets, forming a frame which is bolted to the bush wheel 26, the latter being held by its screw fixedly on the rod 6. The yoke is rotated from the pulley wheel 7, a 57-toothed gear wheel 8, on the spindle of which drives a  $\frac{1}{2}$ " pinion 9, on an upper 4" rod 10, another  $\frac{1}{2}$ " pinion 11, on the end of which engages and drives the gear wheel 5; this rotates the yoke. The gear 8 is caused to engage or disengage with the pinion 9 by a clutch mechanism operated by the handle 12. As the yoke rotates, the thread from the bobbins is wound closely round the wire 2, and in order to ensure an even wrapping of the thread on the wire, the take-up roller 14, is provided, on to which the wire as it is covered is wound. The take-up roller is driven with a very slow movement by bevel pinions 15, from a side rod 16, a  $\frac{1}{2}$ " pinion 17 on which is driven by a worm 18, on the rod 13. Consequently, the same rotary movement of the rod 10, to drive the bobbin yoke, also operates the worm 19, engaging the pinion 12 and worm 18, engaging the pinion 17, which slowly drives the take-up roller 14, bringing the uncovered wire 2 slowly past a perforation 20, in the guide strip 21, formed of  $1\frac{1}{2}$ " by  $\frac{1}{2}$ " double angle strip and carried from the yoke arm 22.

In order to prevent the wire 2 unwinding too freely from its bobbin 2A, a brake is provided, consisting of a cord 23, passing round a pulley 24, on the spindle of the bobbin 2A, and connected to a flat bracket bolted on the bush wheel 26.

It will be noticed that a collar 25 is placed on one side of the yoke strip 22, which has the effect of setting one of the bobbins slightly to the rear of the other, and the effect of this is to give two windings round the wire, one over the other. The thread on the bobbins may be of different colours, which would give a variegated effect to the covering. In order to cause the covered wire to be wound evenly on the take-up roller 14, a distributor is provided, consisting of a strip 27, beneath which is bolted a double bracket through which the covered wire passes. By moving the strip 27 from one side to the other, the wire winds evenly on the roller 14.

Model No. 713

# Transporter Bridge



Parts required :

32 of No.	1	4 of No.	20
52 "	2	1 "	21
8 "	3	5 "	22
32 "	4	1 "	26
120 "	5	1 "	27A
32 "	6	507 "	37
4 "	7	6 "	52
20 "	8	7 "	53
8 "	9	15 "	59
4 "	10	10 "	60
10 "	11	10 "	94
89 "	12	4 "	96
3 "	14	3 "	97
2 "	15A	8 "	99
1 "	17	6 "	100
4 "	18A		

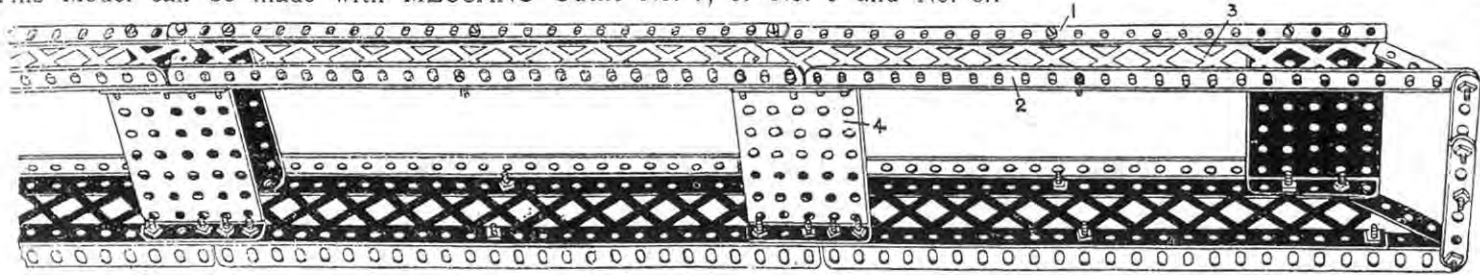


FIG. 713A—GIRDER SECTION.

Model No. 713  
**Transporter**  
*—continued*

The main girder is built up of side pieces, Fig. 713c consisting of top and bottom angle girders 1, 2, reversed, and connected together by braced girder strip 3. The sides are connected across by small rectangular plates 4. The ends of the main girder are supported from the end towers, as shown in Fig. 713b. The travelling platform 5, Fig. 713c, supported from the carriage 6, runs on 1" pulleys, which travel along the outer edges of the lower angle girders 2. The carriage 6 is moved by a sprocket chain 7 passing round wheels 8 supported in the main girder and operated from the pinion and 57-toothed gear wheel 9 by the sprocket chain 10 driven by the motor

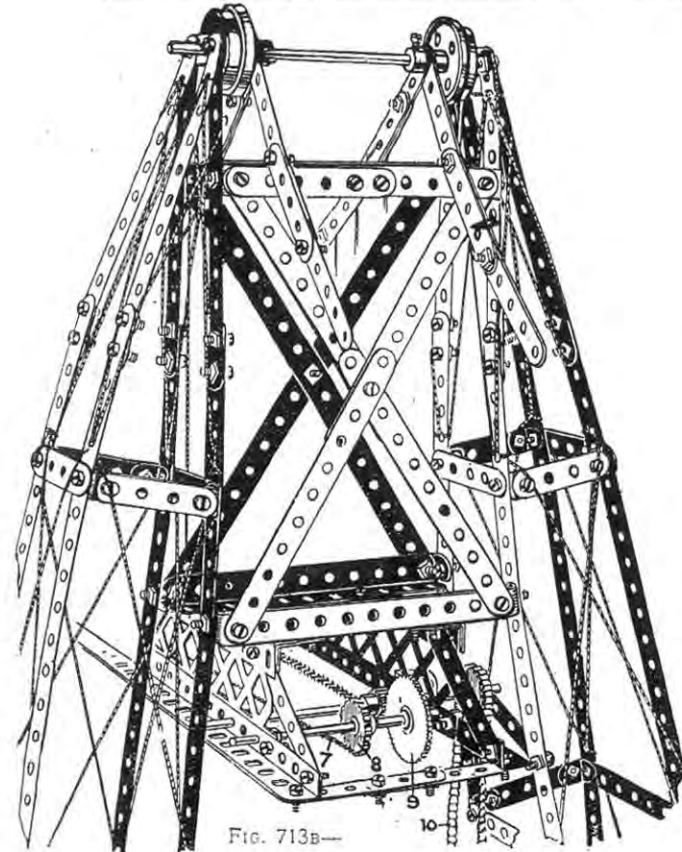


FIG. 713B—

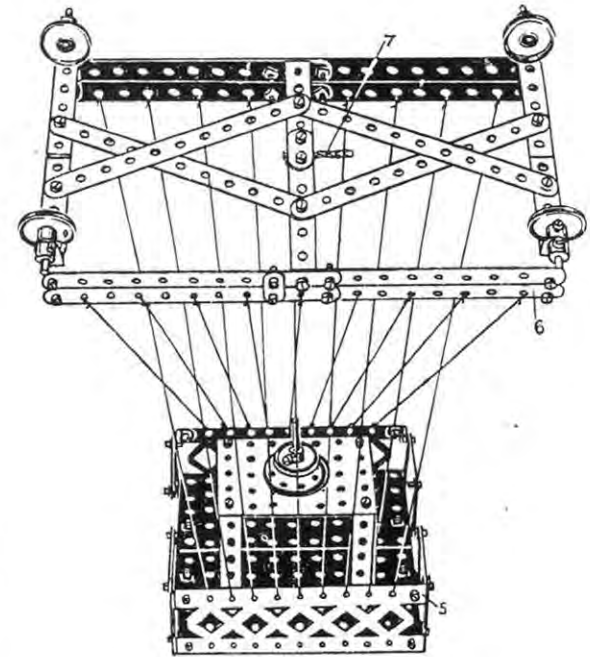


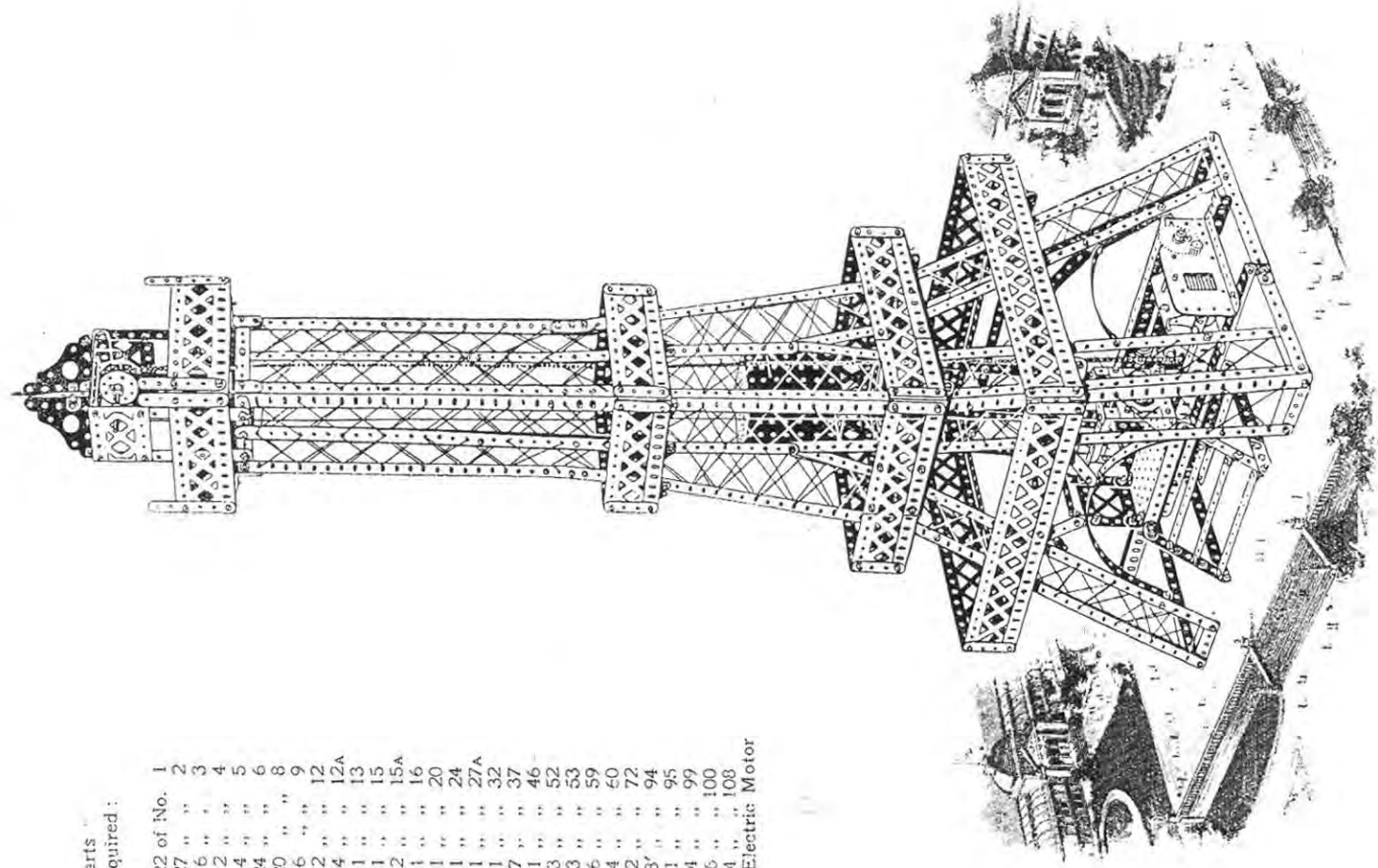
FIG. 713C—TRAVELLING PLATFORM

This Model can be made with MECCANO Outfit No. 7, or No. 6 and No. 6A

### Model No. 714—Eiffel Tower

Parts  
required :

22 of No.	1
27 " "	2
6 " "	3
12 " "	4
14 " "	5
24 " "	6
20 " "	8
16 " "	9
72 " "	12
4 " "	12A
1 " "	13
1 " "	15
2 " "	15A
1 " "	16
1 " "	20
1 " "	24
1 " "	27A
1 " "	32
1 " "	37
337 " "	46
1 " "	48
3 " "	52
3 " "	53
6 " "	59
4 " "	60
2 " "	72
8 " "	94
1 " "	95
4 " "	99
16 " "	100
4 " "	108
1	Electric Motor



## Model No. 714—Eiffel Tower (continued)

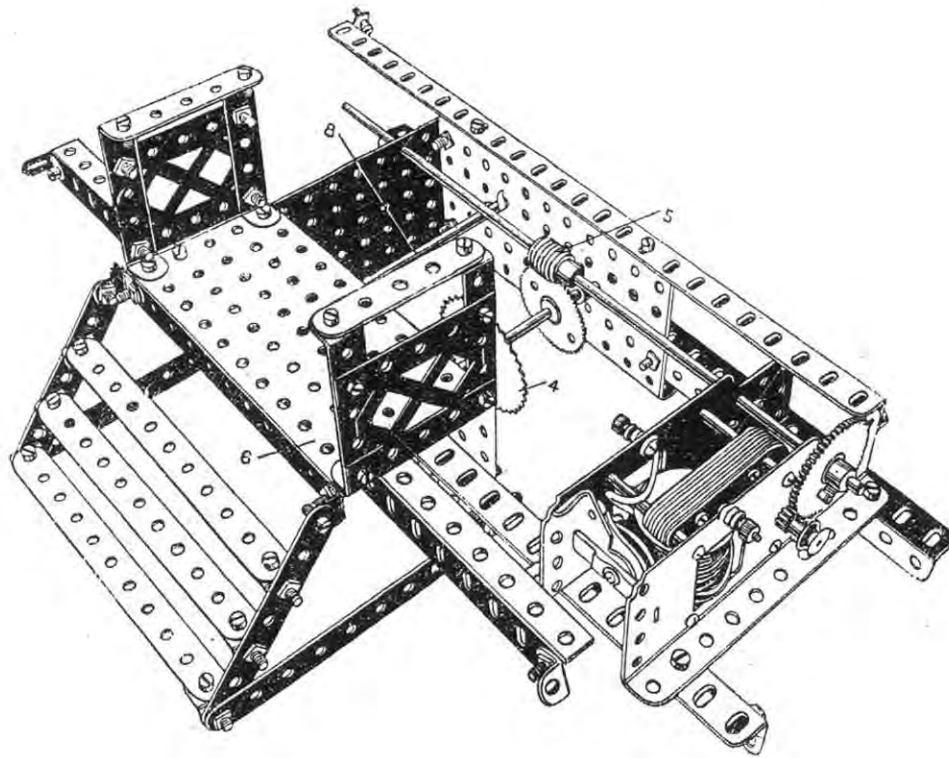


FIG. 714A

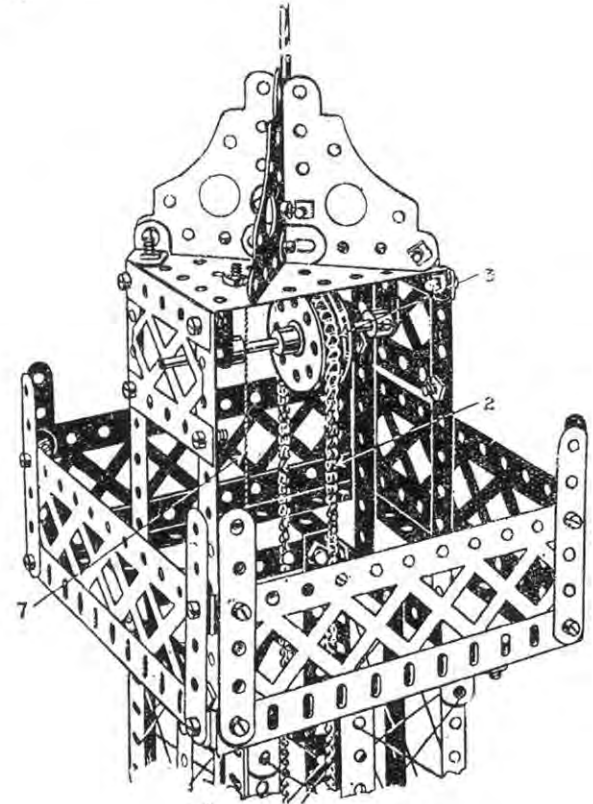
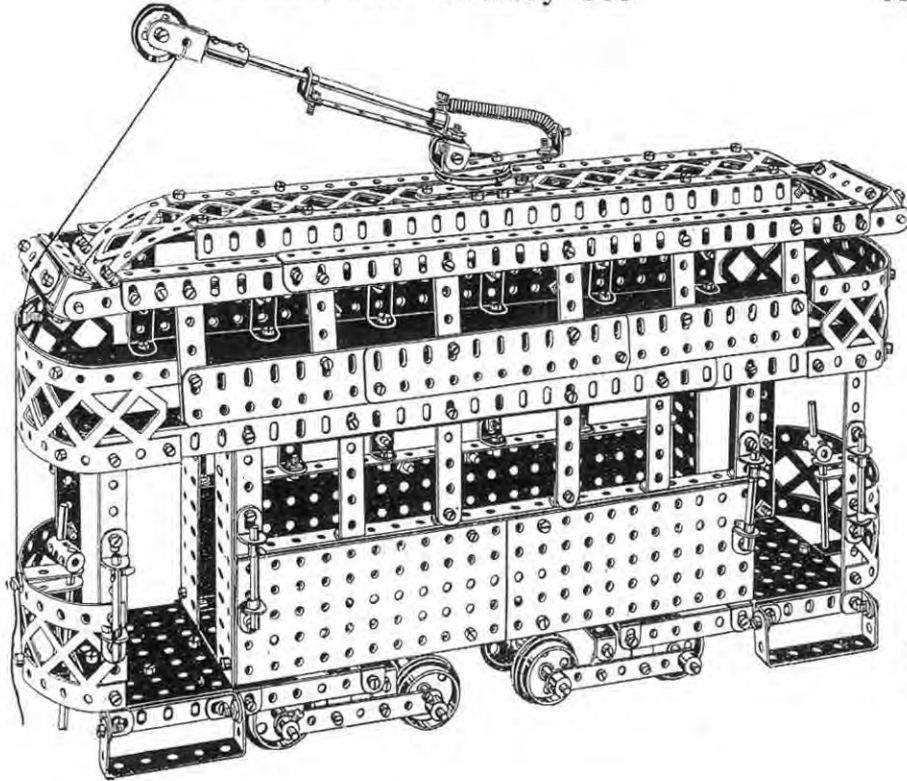


FIG. 714B

No description is necessary of the tower itself. The lift carriage 1 is raised and lowered by the chain 2 which passes over a pulley wheel 3 formed by butting a flanged wheel and a bush wheel together in the top, and a 2" sprocket wheel 4 in the bottom, driven by the worm gearing 5 from the motor. The lift carriage is brought to rest at the platform 6, and is guided by the cord 7 passing through the holes in the perforated plates of the lift carriages, the cord being secured to the top of the tower and to the rod 8 at the bottom.

Model No. 717—Trolley Car



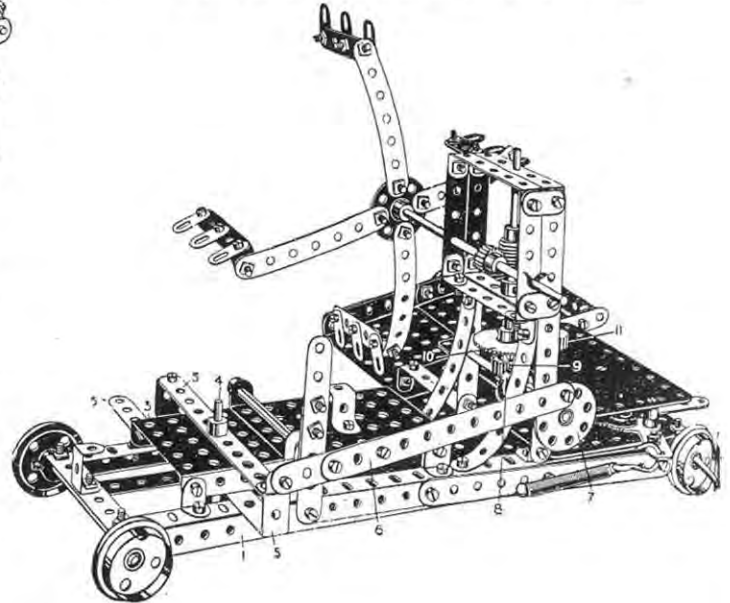
Parts required :

8 of No. 2	49 of No. 12	1 of No. 22A	2 of No. 53
11 " " 3	1 " " 15	21 " " 35	12 " " 59
2 " " 4	8 " " 16	225 " " 37	24 " " 60
17 " " 5	8 " " 17	1 " " 43	1 " " 63
8 " " 8	5 " " 18A	3 " " 44	2 " " 99
2 " " 9	10 " " 20	4 " " 46	6 " " 100
10 " " 11	1 " " 21	4 " " 52	6 " " 103

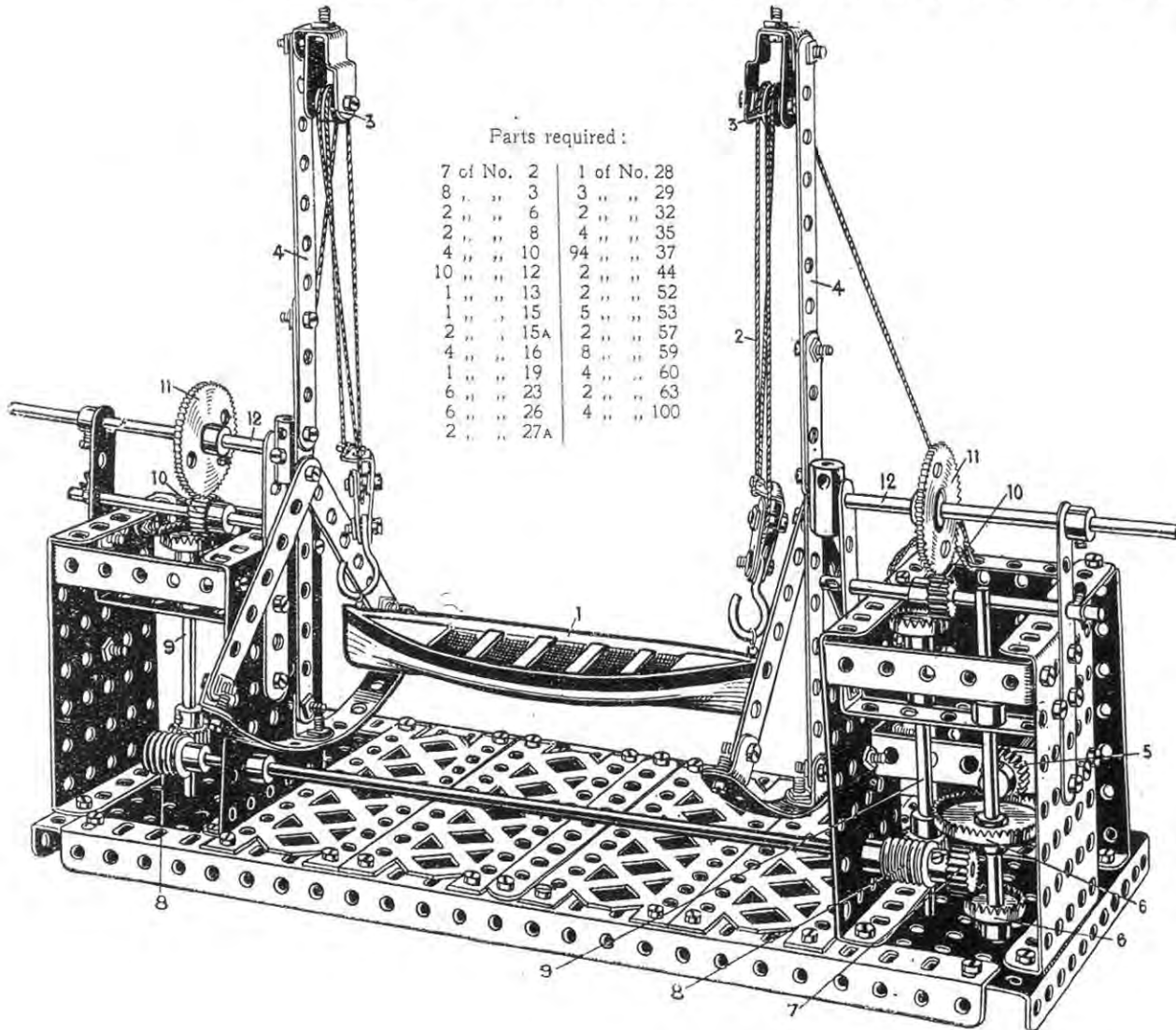
Model No. 715—Mowing and Reaping Machine

Parts required:

13 of No. 2	15 of No. 12	4 of No. 20	100 of No. 37
5 " " 3	1 " " 13	1 " " 22	1 " " 45
1 " " 4	7 " " 14	2 " " 24	2 " " 52
8 " " 5	3 " " 15	3 " " 26	3 " " 53
2 " " 8	2 " " 16	1 " " 27	7 " " 59
16 " " 10	1 " " 17	1 " " 29	5 " " 60
4 " " 11	1 " " 18A	1 " " 32	1 " " 62



Begin by building the base frame 1 from angle girders bolted to flanged plates 2, a flanged perforated plate 3 being also bolted by angle brackets on the top of frame 1. This forms the bearing for a short rod 4 which is the pivot of the cutter 5, which is oscillated by the strips 6 which form a connecting rod operated by the bush wheel 7. The spindle of this wheel is driven by a conrate wheel 8 from the pinion 9, which is on the same spindle as the gear wheel 10 driven by two pinions 11 on the driving spindle of the motor.



Parts required :

7 of No. 2	1 of No. 28
8 " " 3	3 " " 29
2 " " 6	2 " " 32
2 " " 8	4 " " 35
4 " " 10	94 " " 37
10 " " 12	2 " " 44
1 " " 13	2 " " 52
1 " " 15	5 " " 53
2 " " 15A	2 " " 57
4 " " 16	8 " " 59
1 " " 19	4 " " 60
6 " " 23	4 " " 63
6 " " 26	4 " " 100
2 " " 27A	

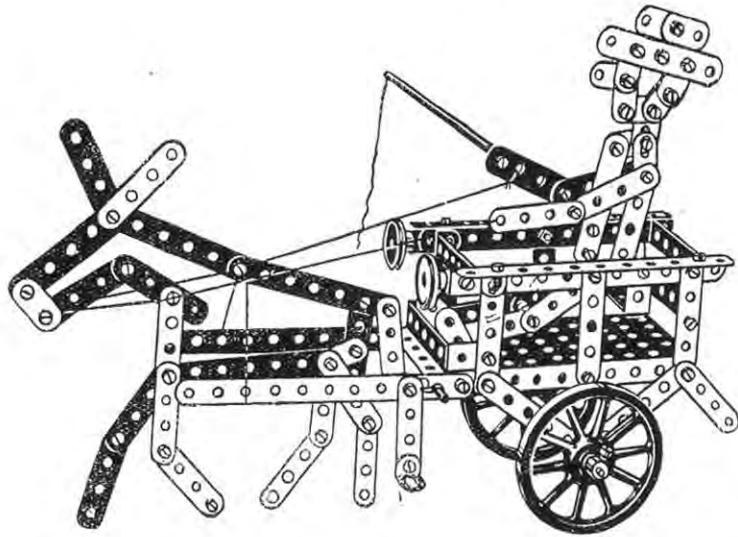
Model No. 717

# Boat Launching Gear

This is an extremely interesting model to construct. The boat 1 carried in the falls 2 from the upper blocks 3 composed of  $\frac{1}{2}$ " pulleys is swung outboard or inboard by the rotation of the weighted arms 4. The movement of the arms is effected from a cranked handle not shown, a  $\frac{1}{2}$ " pinion 5 on the end of which drives a  $1\frac{1}{2}$ " and a  $\frac{3}{4}$ " contrate wheel 6 and a  $\frac{1}{2}$ " pinion 7 on a shaft carrying worms 8 which drive vertical spindles 9 and through  $\frac{1}{2}$ " pinions 10 and 57-toothed gear wheels 11 the axle rods 12 upon which the arms 4 are pivotally supported.

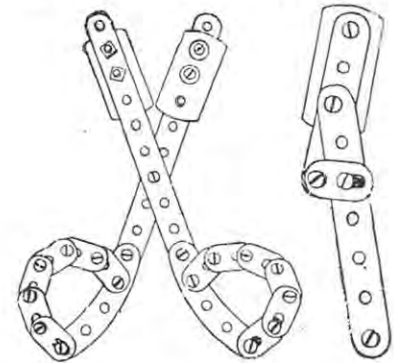
Model No. 718

# A Gay Start



- Parts required:
- 6 of No. 2
  - 2 " " 3
  - 5 " " 4
  - 10 " " 5
  - 24 " " 6
  - 23 " " 10
  - 8 " " 12
  - 1 " " 15
  - 1 " " 15A
  - 1 " " 16
  - 2 " " 19B
  - 2 " " 22
  - 2 " " 35
  - 71 " " 37
  - 2 " " 46
  - 1 " " 52
  - 3 " " 60

Model Nos. 720 and 721  
Scissors Knife

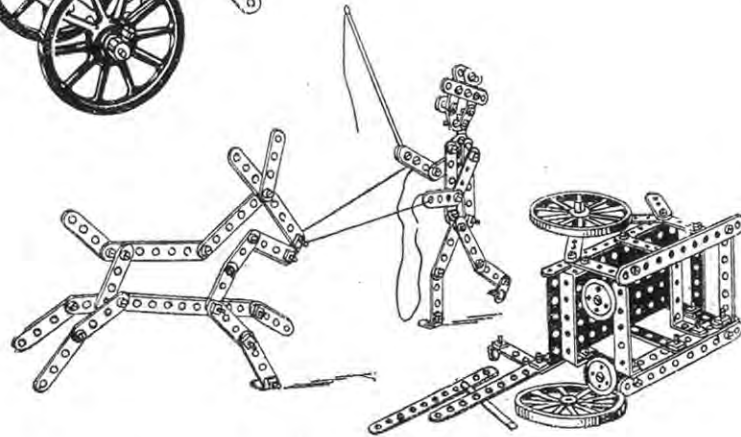


Suggestions for using old safety razor blades to make a pair of scissors and photographer's trimming knife.

- Parts required:
- | MODEL No. 720. | MODEL No. 721. |
|----------------|----------------|
| 2 of No. 2     | 2 of No. 3     |
| 12 " " 10      | 1 " " 5        |
| 21 " " 37      | 1 " " 10       |
| 2 " " 90       | 5 " " 37       |
| 2 razor blades | 1 razor blade  |

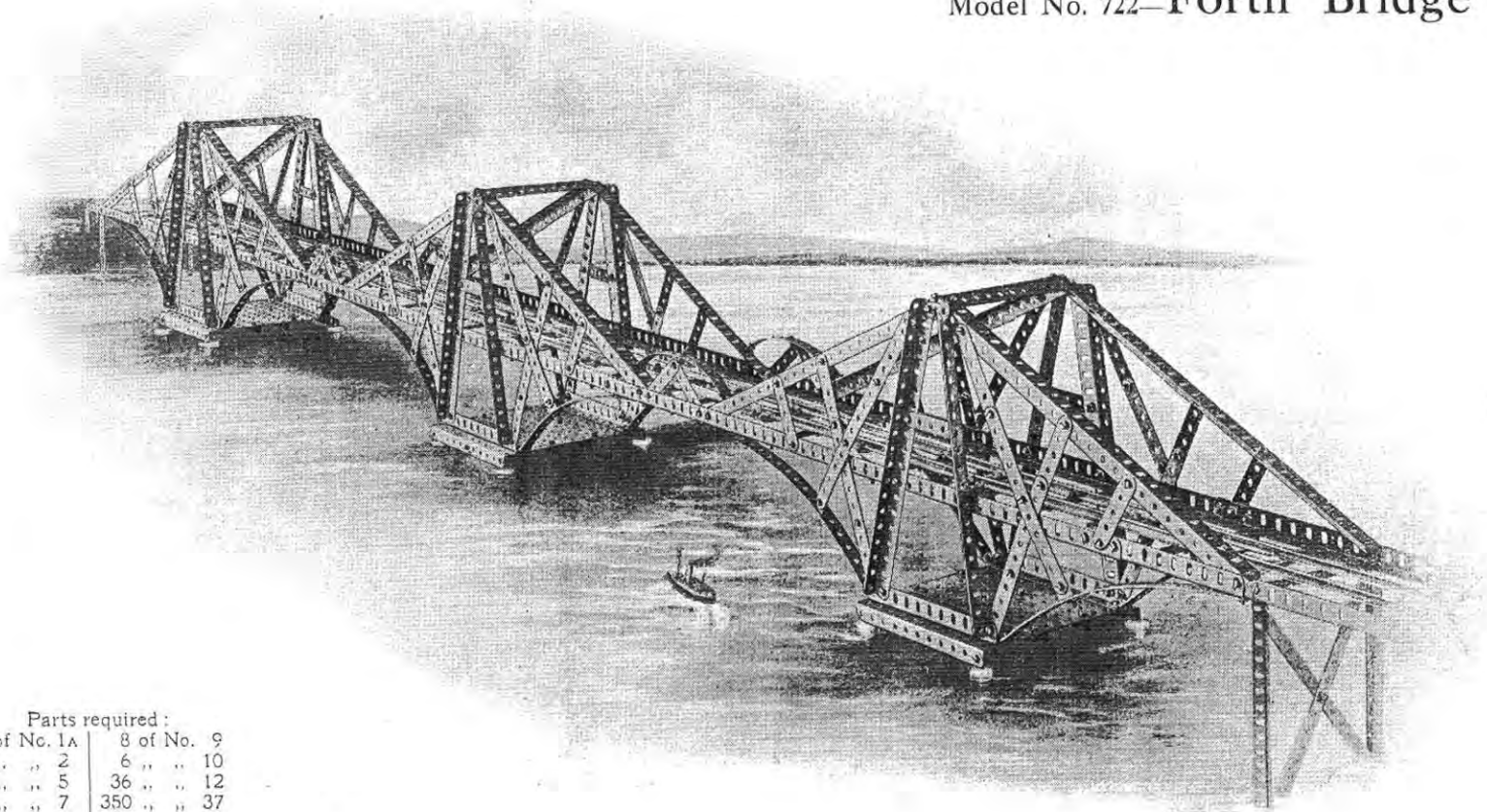
Model No. 719

# The End of a Perfect Day





## Model No. 722—Forth Bridge



Parts required :

12 of No. 1A	8 of No. 9
74 " " 2	6 " " 10
24 " " 5	36 " " 12
6 " " 7	350 " " 37
12 " " 8	26 " " 38
12 " " 8A	6 " " 52
	3 " " 52A

Each of the cantilever spans is made of  $9\frac{1}{2}$ " angle girders, connected by their lower ends to a  $5\frac{1}{2}$ " angle girder. The inclined  $12\frac{1}{2}$ " angle girders are connected at the apex of the cantilever to the top holes of the inclined girders coupled by flat brackets and at their lower outer ends to horizontal angle girders. The horizontal girders are connected across by  $5\frac{1}{2}$ " strips disposed at intervals of about 11 holes apart. On these are secured gauge O track rails, held to the cross strips by bolts, beneath the heads of which are washers engaging the lower flange of the track rails and binding them on to the cross strips.

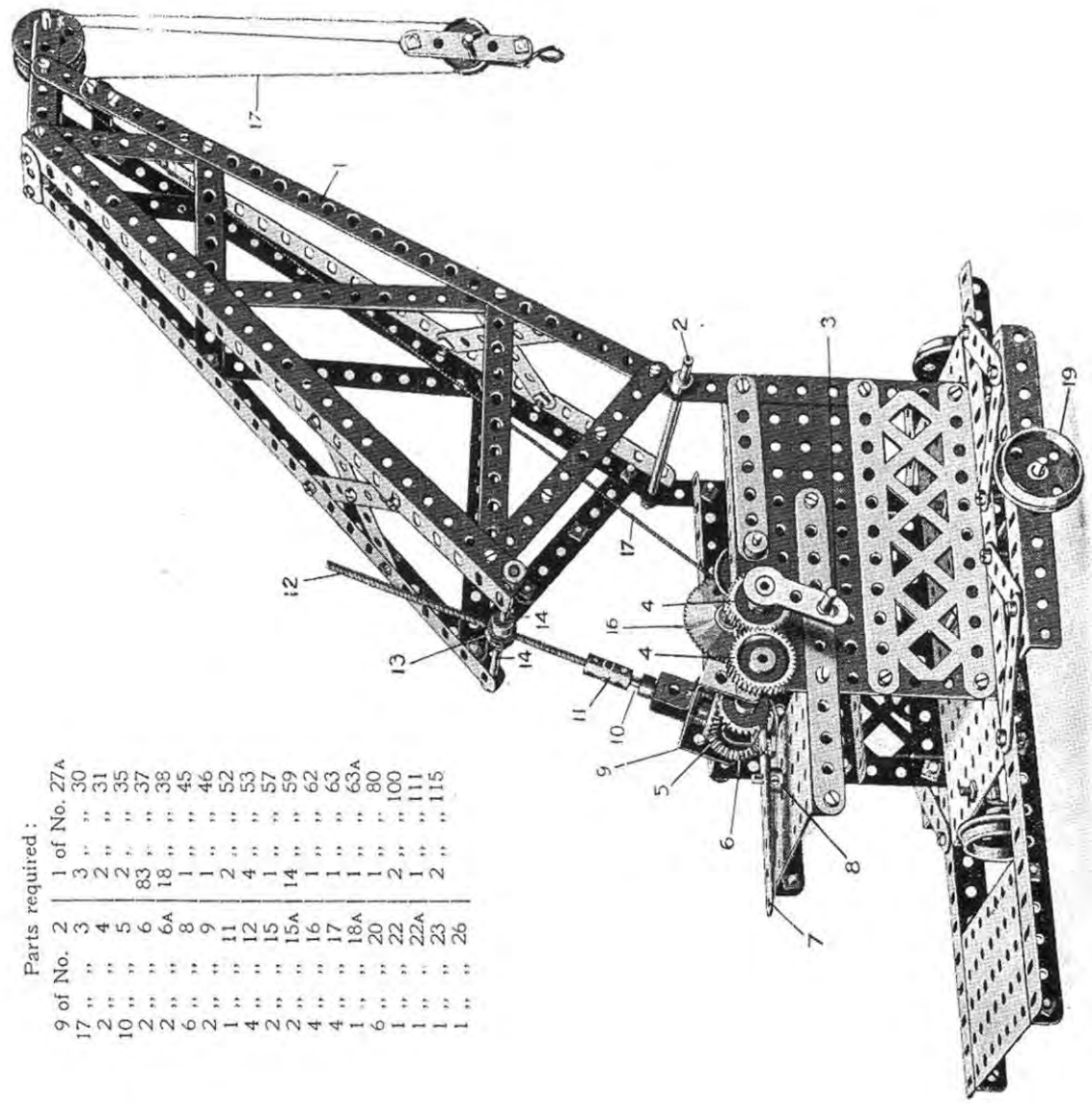
The bases of the cantilevers are formed by two  $5\frac{1}{2}$ " flanged plates coupled at the centre by a  $5\frac{1}{2}$ " flat plate.

This Model can be made with MECCANO Outfit No. 7, or No. 6 and No. 6A

## Model No. 723 Revolving Crane

Parts required:

9 of No.	2	1 of No. 27A
17 "	3	30
2 "	4	31
10 "	5	35
2 "	6	37
2 "	6A	38
6 "	8	45
2 "	9	46
1 "	11	52
4 "	12	53
2 "	15	57
2 "	15A	59
4 "	16	62
4 "	17	63
1 "	18A	63A
6 "	20	80
1 "	22	100
1 "	22A	111
1 "	23	115
1 "	26	



## Model No. 723—Crane (continued)

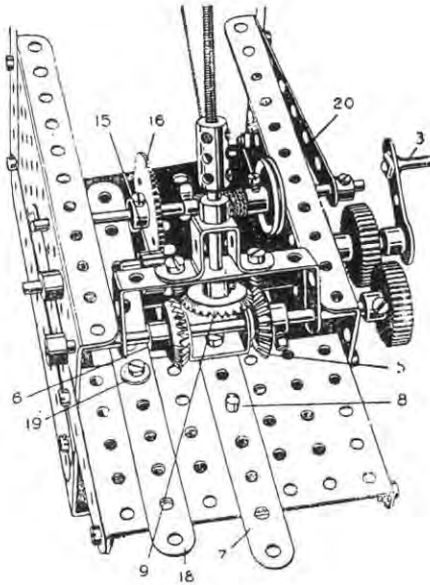


FIG. 723A

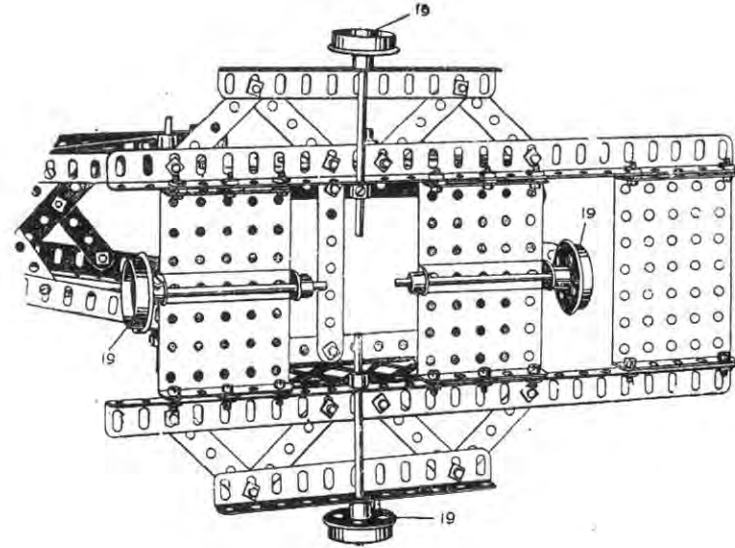


FIG. 723B

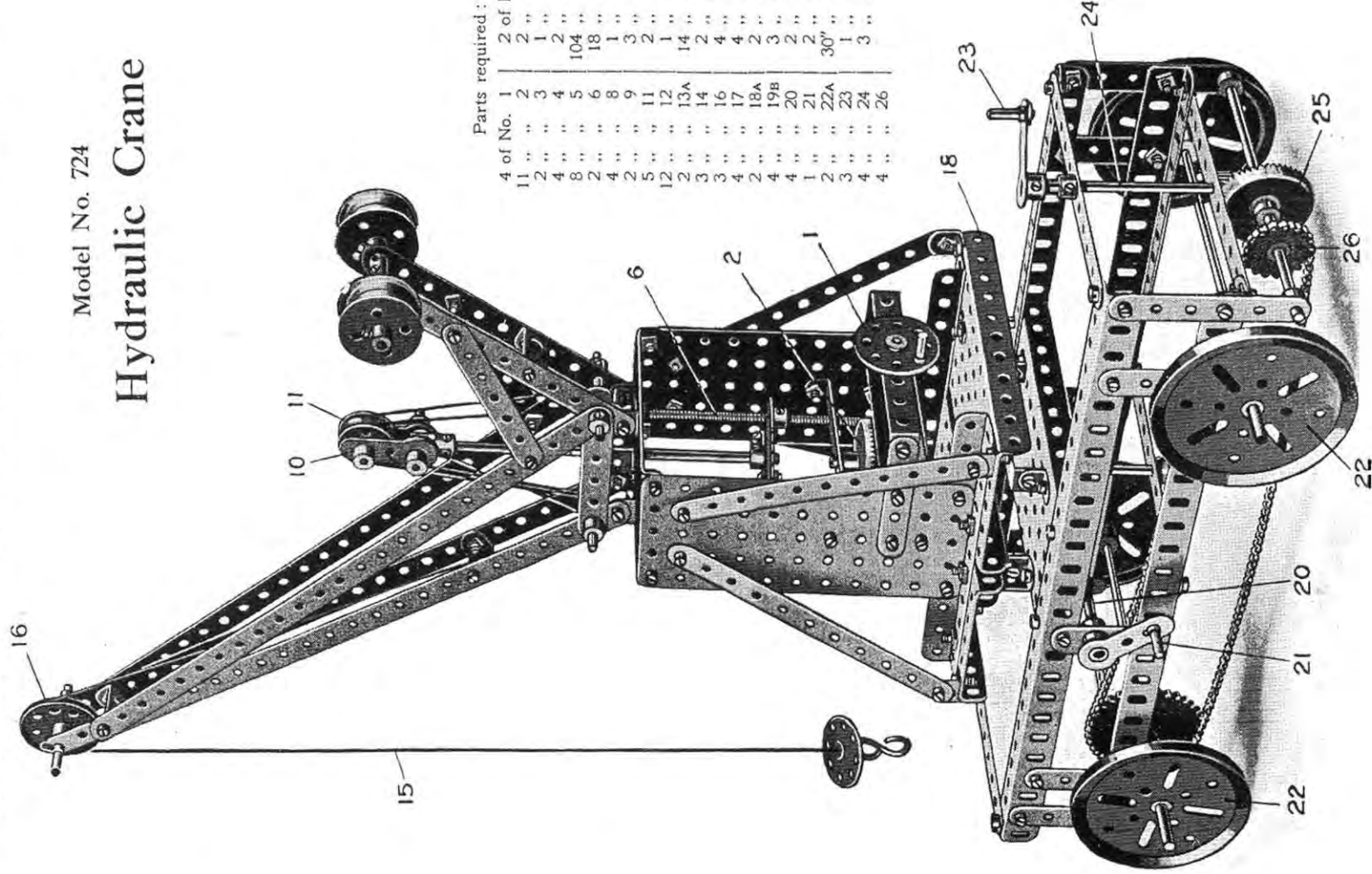
The jib 1, the construction of which is clear from the drawing, is pivoted at its lower end on a 5" axle rod 2, the movement of the jib about this pivot being obtained from the handle 3, which drives a rod carrying bevel wheels 5, 6 (from the 1" gear wheels 4). The bevel wheel rod is arranged to slide in its bearings by the strip 7, at the end of which is a double bracket, pivoted at 8, on the frame of the crane, on a threaded pin under which is a collar, and thus bring either the bevel 5, or the bevel 6, into engagement with a third bevel 9, Fig. 723A, on the end of a 2" rod 10, connected by the coupling 11, to a 5" screwed rod 12. This screwed rod engages the transverse threaded hole in an octagonal coupling 13, which is pivotally carried on two 2" rods 14, so as to give a clear way for the screwed rod 12. According to the direction in which the clutch handle 7 is thrown over, and the handle 3 turned, the jib will be raised or lowered. The rod of the handle 3, also carries a  $\frac{1}{2}$ " pinion 15, which is adapted to engage and drive a 57-toothed gear wheel 16, round the spindle of which is wound the cord 17, by means of which the load is raised or lowered. The spindle of the wheel 16, is caused to slide in its bearings to engage the pinion 15, by means of the 5" strip 18, Fig. 723A, pivoted at 19, by a bolt lock-nutted to the plate, the other end of which is bent up to engage between the boss of the gear wheel 16, and a collar (not shown).

A spring formed by slightly bending a  $3\frac{1}{2}$ " strip 20, bolted to the side of the frame, automatically releases the winding spindle from engagement with the pinion 15 when the handle 18 is released.

The crane rotates on the wheels 19, which are carried on rods at right angles, as shown in Fig. 723B.

Model No. 724

# Hydraulic Crane



Parts required:

4 of No.	1	2 of No. 27A
11	2	28
2	3	32
4	4	35
5	5	37
2	6	38
4	8	45
2	9	52
5	11	53
12	12	57
2	13A	59
3	14	60
3	16	60B
4	17	62
2	18A	62A
4	19B	63
4	20	70
2	21	80
2	22A	94
3	23	95
4	24	115
4	26	

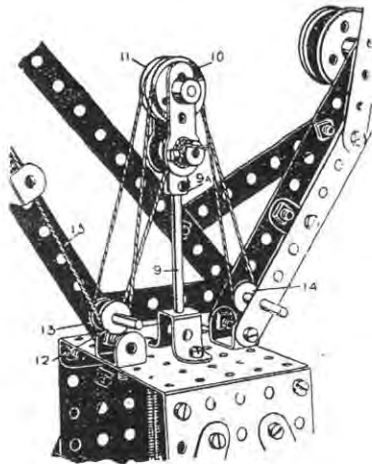
Model No. 724—Hydraulic Crane *continued.*

FIG. 724B

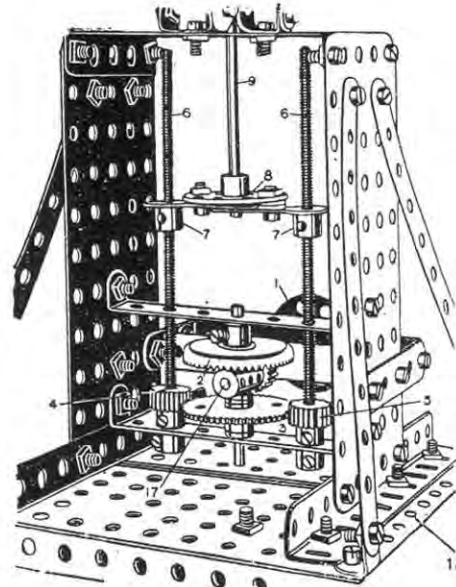


FIG. 724C

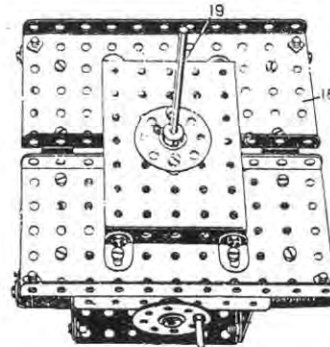


FIG. 724D

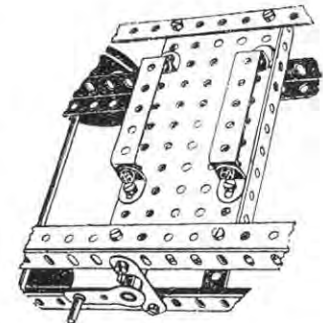


FIG. 724E

This model is designed to illustrate the operating of a Hydraulic Crane, in which great power is utilised to force two or more sets of pulley wheels apart, chains passing round the pulley wheels so that by a small movement of the operating power a great movement of the load is effected. In the model, instead of water-power, screws are used to move the chain or cord pulleys.

The weight is raised or lowered by operating the hand-wheel 1. The rod of this wheel carries a pinion which gears with a  $1\frac{1}{2}$ " contrate wheel 2. On the rod of the contrate wheel is a lower 57-toothed gear wheel 3, which engages two  $\frac{1}{2}$ " pinions 4 and 5, secured on vertical screwed rods 6, so that these rods are rotated in the same direction on the turning of the handle 1. The rods engage the bosses of threaded cranks 7, secured on a bush wheel 8, in the boss of which is fixed a 6" rod 9. This rod at the top is secured in a coupling 9A, to which are connected on a 1" transverse rod two cranks which support another 1" rod, forming a bearing for two 1" loose pulleys 10 and 11. Two  $\frac{1}{2}$ " pulleys 12 and 13 are loosely mounted on a 2" rod at the base of the jib on one side, and a single  $\frac{1}{2}$ " pulley 14 on another 2" rod at the other side.

The cord 15 passes over the pulley 16 at the top of the jib, round the pulley 12, up round the pulley 10, round the lower pulley 14, back round the other pulley 11, round the small pulley 13, and is made fast to the coupling 9A.

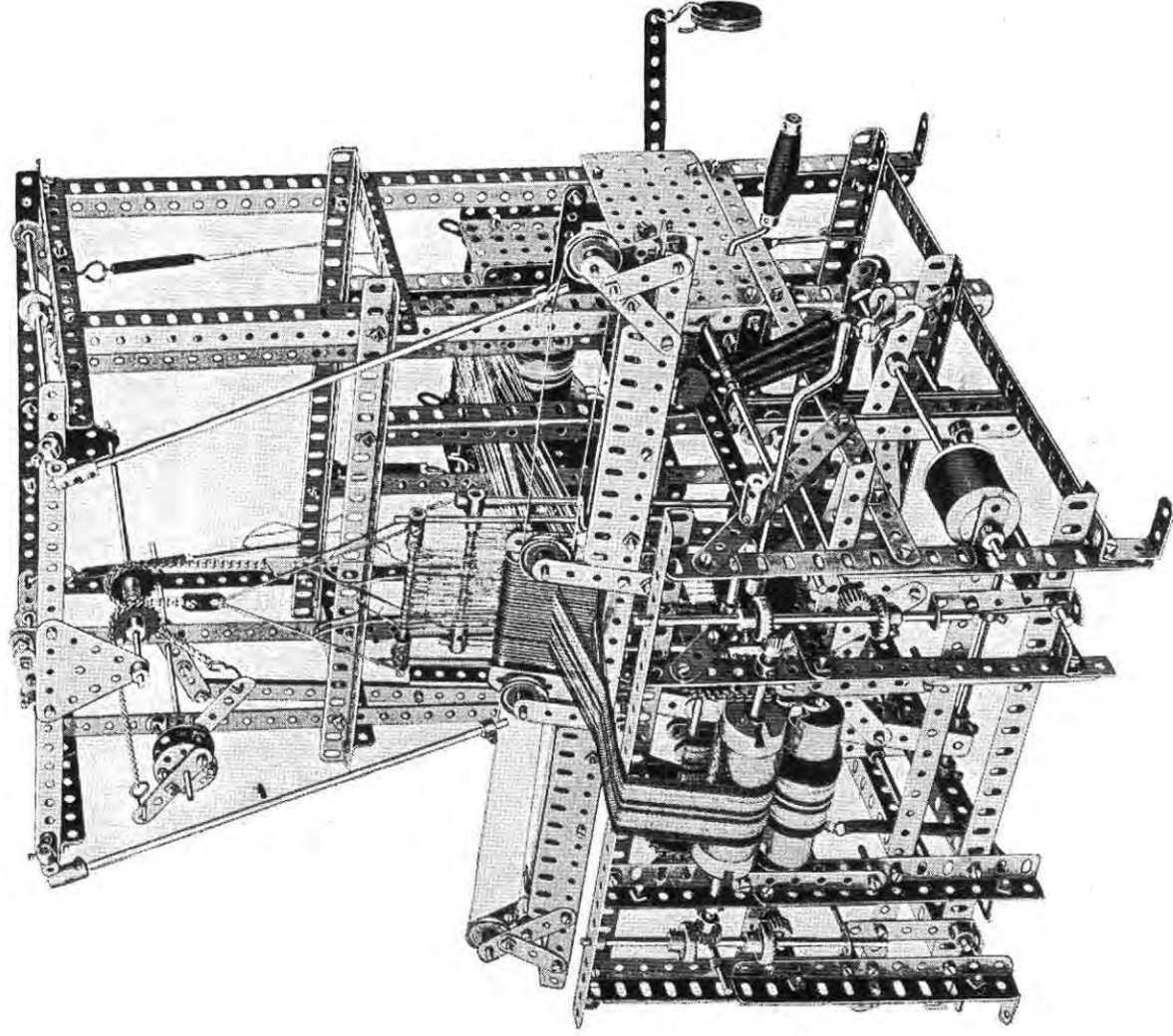
By turning the handle 1 the contrate wheel 2 is rotated, thus driving the pinions 4 and 5 and rotating the screwed rods, which causes the threaded cranks to be raised or lowered, and the rod 9, carrying the pulleys 10 and 11, also to be raised or lowered. As the pulleys 10 and 11 are forced up, the cord 15 travels round all the pulleys, and, due to the number of loops of the cord, the small movement of the top pulleys 10 and 11 results in a larger movement of the crane hook.

The rod of the bush wheel 1, which carries a  $\frac{1}{2}$ " pinion, is journaled in a coupling 17, above and beneath which are placed two washers. The rod is held in position by the wheel 1 on one side of the cross strip, and by a collar on the other side.

The crane is carried on a platform 18, pivoting about a vertical rod 19, on which is a 57-toothed gear wheel engaged and driven by a worm on a rod 20, on the end of which is the operating handle 21.

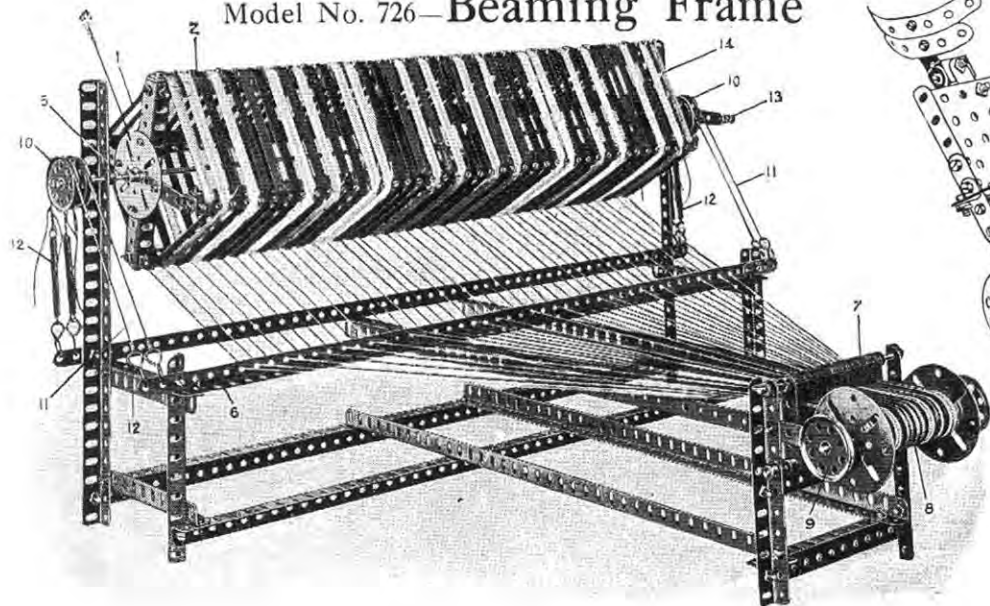
The crane is caused to travel on the wheels 22 by the handle 23, a  $\frac{1}{2}$ " pinion at the foot of its rod 24 driving a  $1\frac{1}{2}$ " contrate wheel 25 on the rod 26, coupled by chain and sprocket wheels to the front wheels 22.

### Model No. 725—LOOM

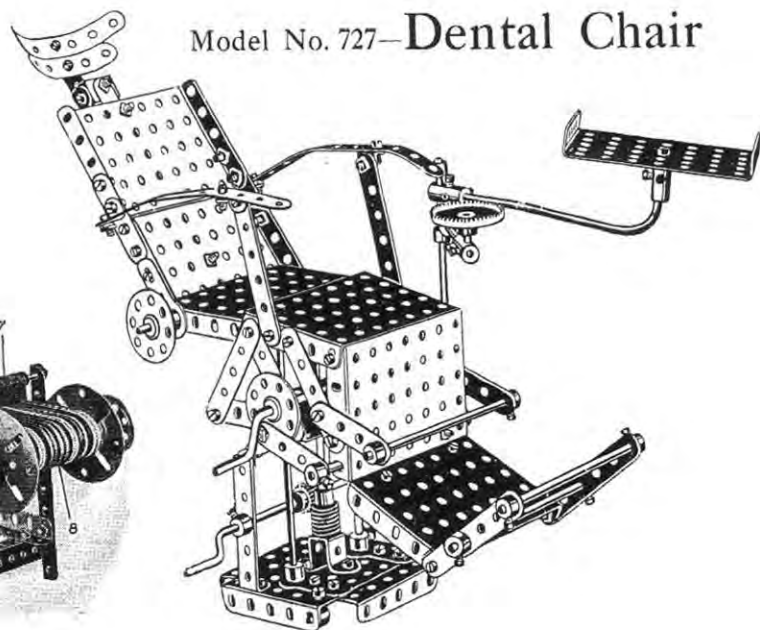


The Meccano Loom is one of the most remarkable and interesting models that can be made with Meccano. It is absolutely automatic and beautiful material may be woven by simply turning the handle. It is a somewhat complicated model, requiring careful construction and accurate adjustment and as it is impossible to do justice to it in this book, we have compiled a special sheet of instructions in which it is illustrated and described in detail. This may be purchased either from your local Meccano dealer or from Meccano Limited, Liverpool. Price 3d. (post free, 4d.)

### Model No. 726—Beaming Frame



### Model No. 727—Dental Chair



Parts required :

2 of No. 1	4 of No. 7	8 of No. 12	1 of No. 26	4 of No. 43	1 of No. 103
4 " " 2	2 " " 7A	2 " " 13	1 " " 33	8 " " 57	4 " " 109
44 " " 5	12 " " 8	3 " " 14	253 " " 37	10 " " 59	
4 " " 6	10 " " 9	6 " " 21	88 " " 38	1 " " 63	

Parts required :

3 of No. 2	1 of No. 14	63 of No. 37
2 " " 3	3 " " 15	1 " " 45
4 " " 4	5 " " 15A	2 " " 50
7 " " 5	1 " " 16	10 " " 53
6 " " 6	2 " " 19	17 " " 59
2 " " 11	2 " " 24	2 " " 60
6 " " 12	1 " " 26	3 " " 62
1 " " 13A	1 " " 28	4 " " 63
	1 " " 32	

The frame upon which the warp threads are wound is built up of 12½" angle girders, 2, overlapped seven holes and bolted to a 5½" girder 1 and 5½" strip crossed and connected to face plates 4 on the 11½" rod 5.

Inside the frame, two 5½" angle girders are bolted nine holes from each end to form the inner bearings for the rods 5. Another 5½" girder is bolted crosswise to these in the centre to form a stay.

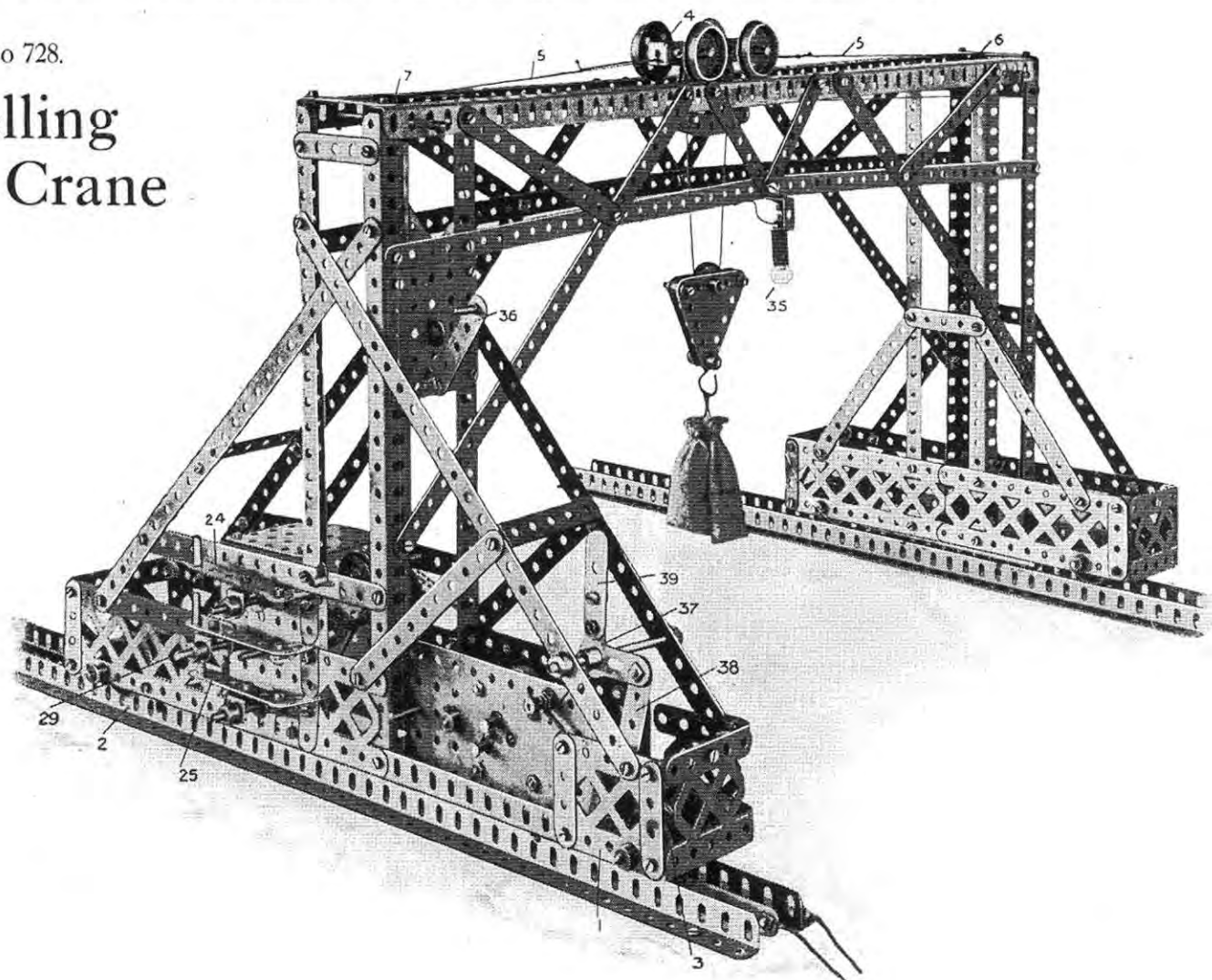
The warp threads are first wound upon the warp-frame, and pass through the holes in a 24½" angle girder 6, and, converging together, pass between the 2½" strips 7 forming the reed, and so on to the beam 8. On the far side of the beam rod is a ½" pinion engaged by a pawl (not shown on the photograph) which prevents backward rotation of the beam as the warp threads are wound thereon by turning the 1½" pulley wheels 9.

A brake mechanism for tensioning the frame 2 is provided by securing two 1" pulley wheels 10 at each end of the frame rod 5, cords 11, secured by hooks passing over the pulleys 10 and being kept taut by the springs 12.

A handle 13 is provided on the rod 5 by means of which the warp threads 14 are originally wound on the frame.

Model No 728.

# Travelling Gantry Crane





### Model No. 205—Travelling Gantry Crane—continued.

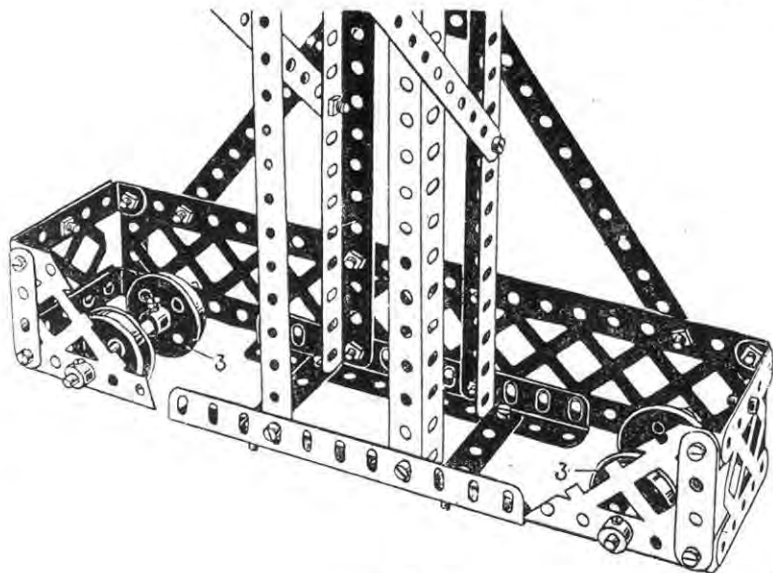


Fig. 728A

Parts required:

12 of No. 1	3 of No. 27
12 " " 2	3 " " 27A
6 " " 3	11 " " 35
3 " " 4	149 " " 37
17 " " 5	10 " " 37A
14 " " 6	38 " " 38
1 " " 6A	3 " " 44
6 " " 7	2 " " 53
10 " " 8	1 " " 57
2 " " 9	30 " " 59
6 " " 11	9 " " 60
4 " " 12A	1 " " 72
2 " " 15	2 " " 76
2 " " 15A	2 " " 90
11 " " 16	26 " " 94
1 " " 16A	1 " " 95
2 " " 17	3 " " 96
4 " " 18A	8 " " 98
12 " " 20	6 " " 100
8 " " 22A	2 " " 111
2 " " 23	1 " " 128
2 " " 25	Electric Motor.
3 " " 26	

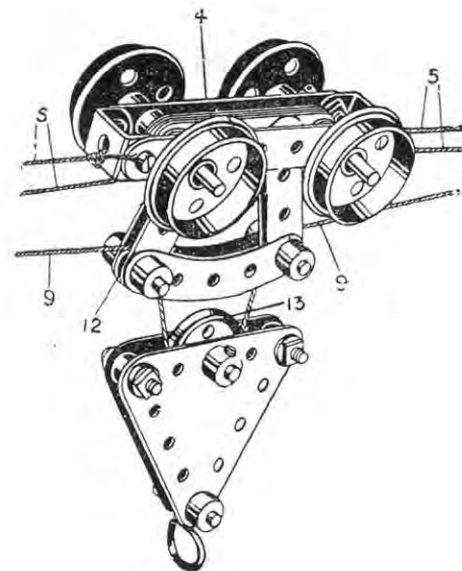


Fig. 728B

The upper part of the framework is well brought out in the illustration. It is to be noted that as regards the feet carrying the motor and the travelling wheels, the centre portion is composed of 12½" angle girders at the lower edge, extended on one side by 2½" braced girders 1, overhanging 4 holes, and on the other side by 5½" braced girders 2 overhanging five holes. The other shorter foot on the gantry is shown in Fig. 728A, and is built up of 5½" braced girders, overlapped and overhanging the lower angle girders five holes on each side. The travelling wheels 3 are carried in the lower holes of the braced girders.

#### TRAVERSING MECHANISM.

The traversing of the trolley 4, is effected by a cord 5 which passes from the far end of trolley 4, round a pulley 6, and is returned and passed over one of the 3" pulleys 7, down to, and has three turns round the rod 8, then passing up and round another of the pulleys 7, and is connected to the near-end of the trolley, Fig. 728B. Consequently, rotation of the rod 8 will wind up one end of the traversing cord 5 and pay out the other end, thus causing the trolley 4 to travel to or fro along the gantry rails.

The load is raised or lowered by another cord 9 which is wound round the upper rod 10, thence round the guide pulley 11, round the third of the pulleys 7, Fig. 728B, and over the ½" pulley 12, Fig. 728B, beneath the 1" pulley 13, on the load block round another ½" pulley, and is made fast on the far end of the gantry frame. If the rod 10 is not being rotated, therefore, the trolley 4 travels to and fro without the load being raised or lowered. Rotation of the rod 10, however, in one or other direction, will result in the load being raised or lowered.

#### TRAVELLING MECHANISM.

The travelling of the whole gantry crane upon the wheels 3 is effected from the rod 14, a sprocket wheel 15 on which is connected by a chain 16 to another sprocket wheel 17 on the rod 18 of the travelling wheels, Fig. 728c. The rods 8, 10 and 14 are operated as follows: The motor spindle 19, Fig. 728B, drives by the chain 20 a 2" sprocket wheel 21 on a rod 22, on which is a ½" pinion 23, Fig. 728c. The rods 10 and 8 are slideably controlled by the clutch operating handles 24, 25, which

## Model No. 728—Travelling Gantry Crane—continued.

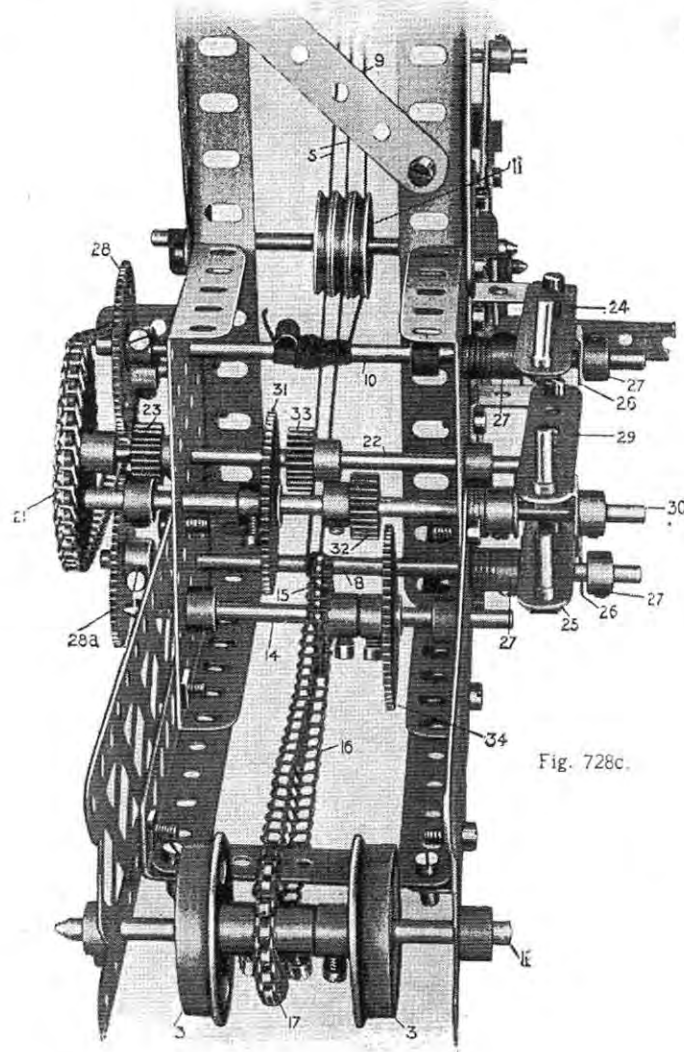


Fig. 728c.

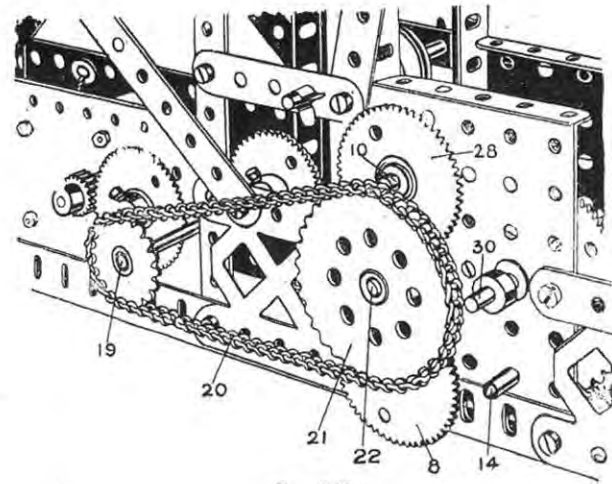


FIG. 728D

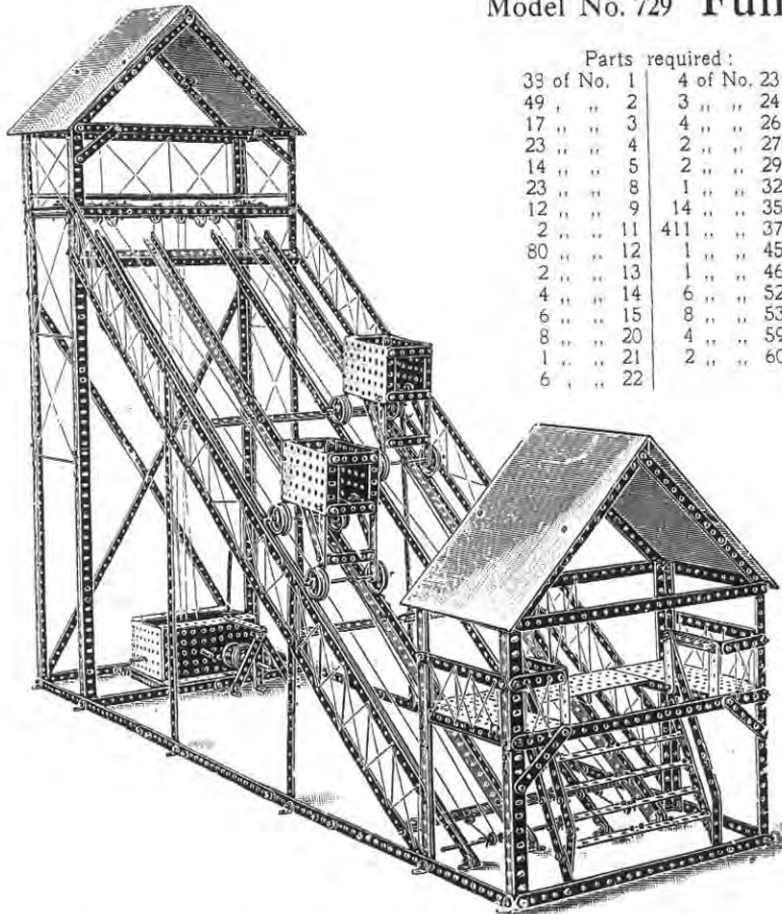
are bolted and lock-nutted to double bent strips 26, engaging between collars 27 nipped on the rods. On the outer end of the rod 10 is a 56-toothed wheel 28, a similar wheel being secured on the outer end of the rod 8. By operating the clutch handles 24, 25, either or both of the gear wheels 28 or 28A may be brought into engagement with the  $\frac{1}{2}$ " pinion 23 and thus cause the load to be raised or lowered, or the trolley 4 to be traversed.

The third clutch handle 29 similarly controls the sliding movement of a rod 30, on which is secured a 56-toothed gear wheel 31 and  $\frac{1}{2}$ " pinion 32, and on the rod 22 is secured another  $\frac{1}{2}$ " pinion 33, while on the rod 14 is a further 56-toothed gear wheel 34. By moving the handle 29, therefore, the gear wheel 31 and the pinion 32 may be brought into engagement respectively with the pinion 33 and the gear wheel 34, thus providing a reduced gear train from the driven rod 22 to the rod 14, and as the latter is coupled by the chain 16 to the rod 18 of the travelling wheels 3 the whole gantry is caused to move to and fro.

The reversal of the motor is controlled by a bell crank 37, coupled by a  $2\frac{1}{2}$ " strip 38 to the reversing lever of the motor, a strip 39 being bolted to the bell crank as an extension handle.

A small electric globe 35 may be mounted on the crane, and controlled by switch 36, Fig. 728

## Model No. 729 Funicular Railway



Parts required:			
33 of No. 1	4 of No. 23		
49 " " 2	3 " " 24		
17 " " 3	4 " " 26		
23 " " 4	2 " " 27A		
14 " " 5	2 " " 29		
23 " " 8	1 " " 32		
12 " " 9	14 " " 35		
2 " " 11	411 " " 37		
80 " " 12	1 " " 45		
2 " " 13	1 " " 46		
4 " " 14	6 " " 52		
6 " " 15	8 " " 53		
8 " " 20	4 " " 59		
1 " " 21	2 " " 60		
6 " " 22			

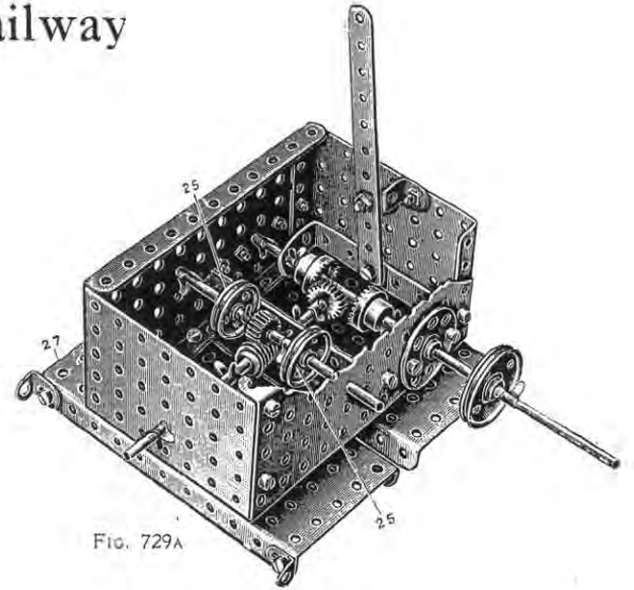


FIG. 729A

Begin by constructing the main tower, the corner pillars of which are made from two  $12\frac{1}{2}$ " angle girders and a  $5\frac{1}{2}$ " angle girder; the  $12\frac{1}{2}$ " girders overlapped three holes and the  $5\frac{1}{2}$ " girders two holes. The rear diagonal ties are made from  $12\frac{1}{2}$ " strips overlapped. The roof rafters consist of  $5\frac{1}{2}$ " strips overlapped five holes.

The inclined rails are made from 4 sets of  $12\frac{1}{2}$ " angle girders, butted together and connected by 3" strips. The rails rest on three upper crossing  $12\frac{1}{2}$ " angle girders, and a lower  $12\frac{1}{2}$ " strip to the ends of which are bolted the latticed side rails supported by the vertical members. The loading platform is built up from  $5\frac{1}{2}$ " girder strips to which are bolted side flanged plates which are again connected by two small flanged plates. The other constructional details of this loading tower should present no trouble.

The main tower, inclined rails, and loading platform are now coupled together by a series of horizontal  $12\frac{1}{2}$ " strips overlapped as shown.

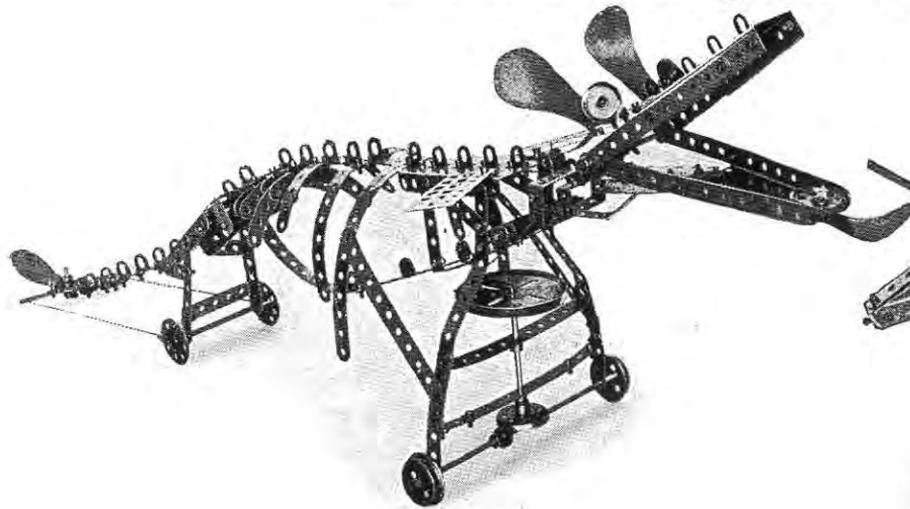
The wagons are made as follows: Two small flanged plates are connected top and bottom by  $2\frac{1}{2}$ " strips. The journals for the front axle are made by two  $3\frac{1}{2}$ " strips bolted inside the flanged plates, the axle being threaded through their lower projecting holes. The rear axle journals are made by carrying down two  $3\frac{1}{2}$ " strips bolted in their ends. The axle is again threaded through the lowest holes. One end of the operating cord as shown in this view is secured to this rear axle; the other end, after passing round the pulleys is secured to the front axle. The gear box for operating the main hauling shaft is very fully shown in Fig. 729A, the operating cords from the pulleys 25 passing round the pulleys in the upper gear platform.

upper holes to the flanged plates, and braced with the diagonal strips to the sides of the wagon. The axle is again threaded through the lowest holes. One end of the operating cord as shown in this view is secured to this rear axle; the other end, after passing round the pulleys is secured to the front axle. The gear box for operating the main hauling shaft is very fully shown in Fig. 729A, the operating cords from the pulleys 25 passing round the pulleys in the upper gear platform.

The Gear Box is mounted on two perforated plates 27, the angle brackets on which are bolted to the transverse strips at the base of the tower.

These Models can be made with MECCANO Outfit No. 7, or No. 6 and No. 6A

## Model No. 730—St. George and Dragon



Parts required, Dragon :

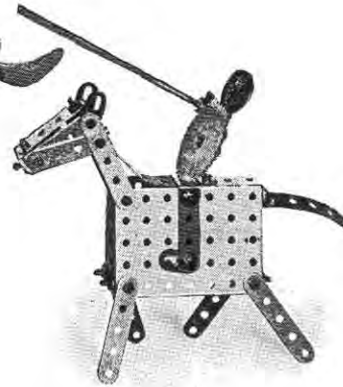
2 of No. 1	4 of No. 16	2 of No. 35	9 of No. 60
17 " " 2	1 " " 18A	126 " " 37	2 " " 61
7 " " 3	1 " " 19B	7 " " 38	1 " " 69
5 " " 5	2 " " 20	4 " " 41	2 " " 72
3 " " 6	2 " " 22	1 " " 43	6 " " 90
3 " " 11	3 " " 24	3 " " 46	2 " " 110
34 " " 12	1 " " 26	4 " " 54	2 " " 114
1 " " 13A	2 " " 28	6 " " 59	

This model requires little description. The jaws of the dragon work by means of a cord fastened to a  $3\frac{1}{2}$ " strip which is attached to the  $2\frac{1}{2}$ "  $\times$   $2\frac{1}{2}$ " flat plate forming the head. The cord is passed through a hole in the  $12\frac{1}{2}$ " strip, which forms the back-bone. It is attached at its other end to the periphery of a 3" pulley wheel, which is caused to rotate as the dragon moves along the ground. To make the tail wag, cords are fastened to each end of the pivoted  $3\frac{1}{4}$ " strip which carries the bush wheel and propeller blade forming the tail, and attached at the other ends to angle brackets bolted to the back wheels. As the model moves along the ground the tail wags in quite a realistic way.

## Model No. 731 Gallop ing Donkey

Parts required :

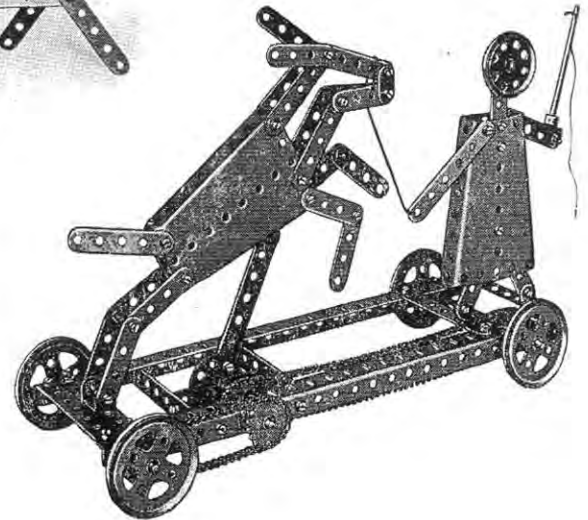
5 of No. 3	1 of No. 21
1 " " 4	1 " " 24
9 " " 5	1 " " 35
10 " " 6	52 " " 37
2 " " 8	5 " " 37A
2 " " 10	1 " " 38
1 " " 11	4 " " 54
2 " " 12	1 " " 59
2 " " 15	1 " " 60
1 " " 16	2 " " 60B
1 " " 16A	18 " " 94
4 " " 20A	4 " " 96



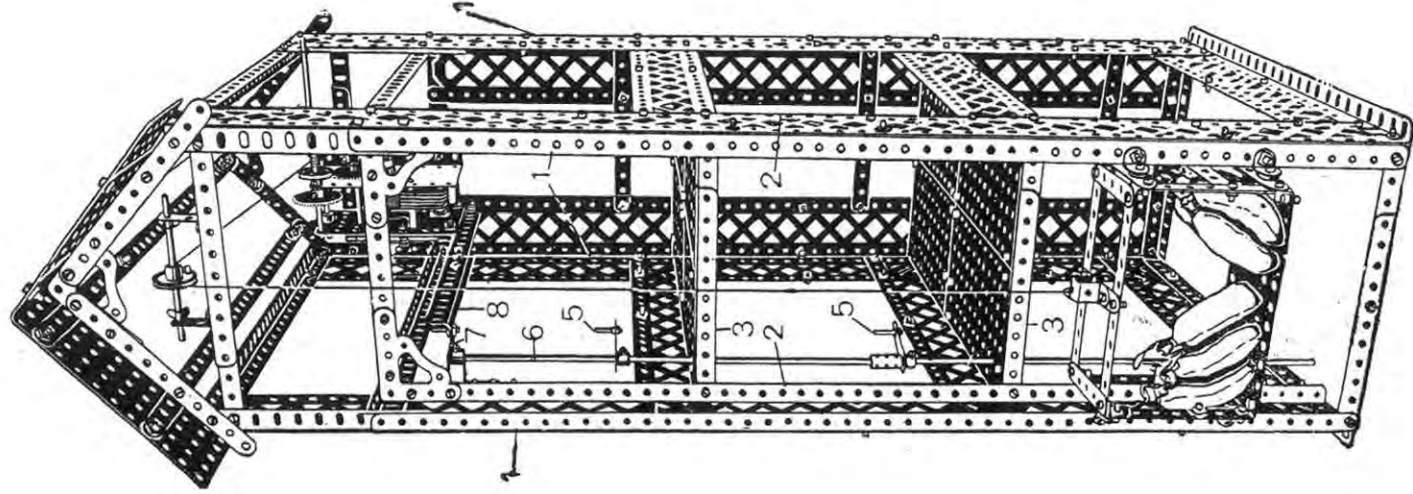
Parts required,

St. George:

1 of No. 3
7 " " 5
7 " " 6
7 " " 10
3 " " 11
2 " " 12
1 " " 14
1 " " 22A
31 " " 37
1 " " 37B
2 " " 53
2 " " 60
1 " " 62
1 " " 95



## Model No. 732 Warehouse



Parts required:	
18 of No.	1
21 " "	2
9 " "	5
1 " "	6
4 " "	6A
6 " "	7
6 " "	8
23 " "	9
16 " "	12
2 " "	12A
2 " "	13
1 " "	14
1 " "	16
3 " "	22
2 " "	35
240 " "	37
30 " "	38
1 " "	45
1 " "	46
8 " "	52A
1 " "	59
4 " "	62
1 " "	63
3 " "	70
18 " "	99
4 " "	100
2 " "	103
4 " "	108
4 " "	115

Commence this model by building the framework.  $24\frac{1}{2}$ " angle girders are used to form the corner uprights 1 with  $5\frac{1}{2}$ " angle girders overlapped three holes at the top. Two  $24\frac{1}{2}$ " angle girders 2 are also used to carry the front portion of the warehouse floors, the latter being bolted to two  $5\frac{1}{2}$ " angle girders 3 overlapped eight holes and connected across to the two inner angle girders 2. Two similar  $5\frac{1}{2}$ " angle girders are bolted to the back of the framework, to carry the other end of each of the floors. The floor is formed of four  $5\frac{1}{2}$ "  $\times$   $3\frac{1}{2}$ " flat plates butted together and bolted in the centre to a  $5\frac{1}{2}$ " double flat strip on the under-

## Model No. 732—Warehouse (continued)

side—the two outer ends being bolted to the angle girders 3. The horizontal side-strips are formed of  $12\frac{1}{2}$ " strips to which are bolted the braced girder strips.

Fig. 732A shows the construction of the Cage. This is guided by bolt heads, 4 at each side riding along the inwardly turned flanges of the angle girders 2. The bolts are attached to angle brackets which are secured to a  $1\frac{1}{2}$ " strip, this latter being secure to the side-strips of the cage, spaced with three washers to take up the play between the cage and the upright girders 2.

Fig. 732B shows the position of the motor, and this may be started and stopped from the control crank handles 5, one on each floor of the warehouse. These crank handles are fixed on a vertical rod 6 composed of two  $11\frac{1}{2}$ " rods connected by a coupling.

A crank 7 is secured to the upper end of this rod and is connected by a  $5\frac{1}{2}$ " angle girder and strip 8 to the operating lever of the motor.

One inch brackets secured to the sides of the Warehouse by strips form the bearings for the upper and lower ends of the vertical rod.

When the motor is wired up to the accumulator, the elevator is ready to be operated.

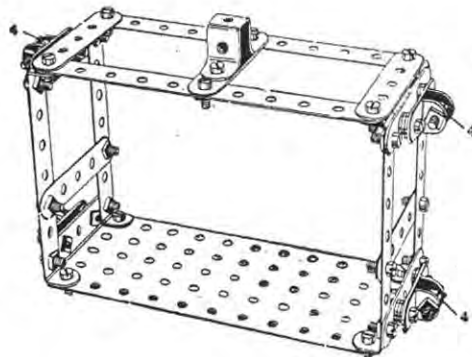


FIG. 732A

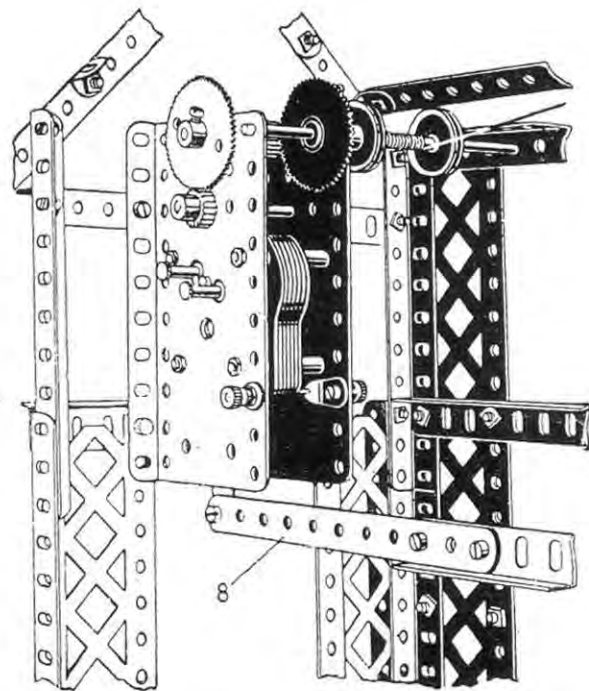
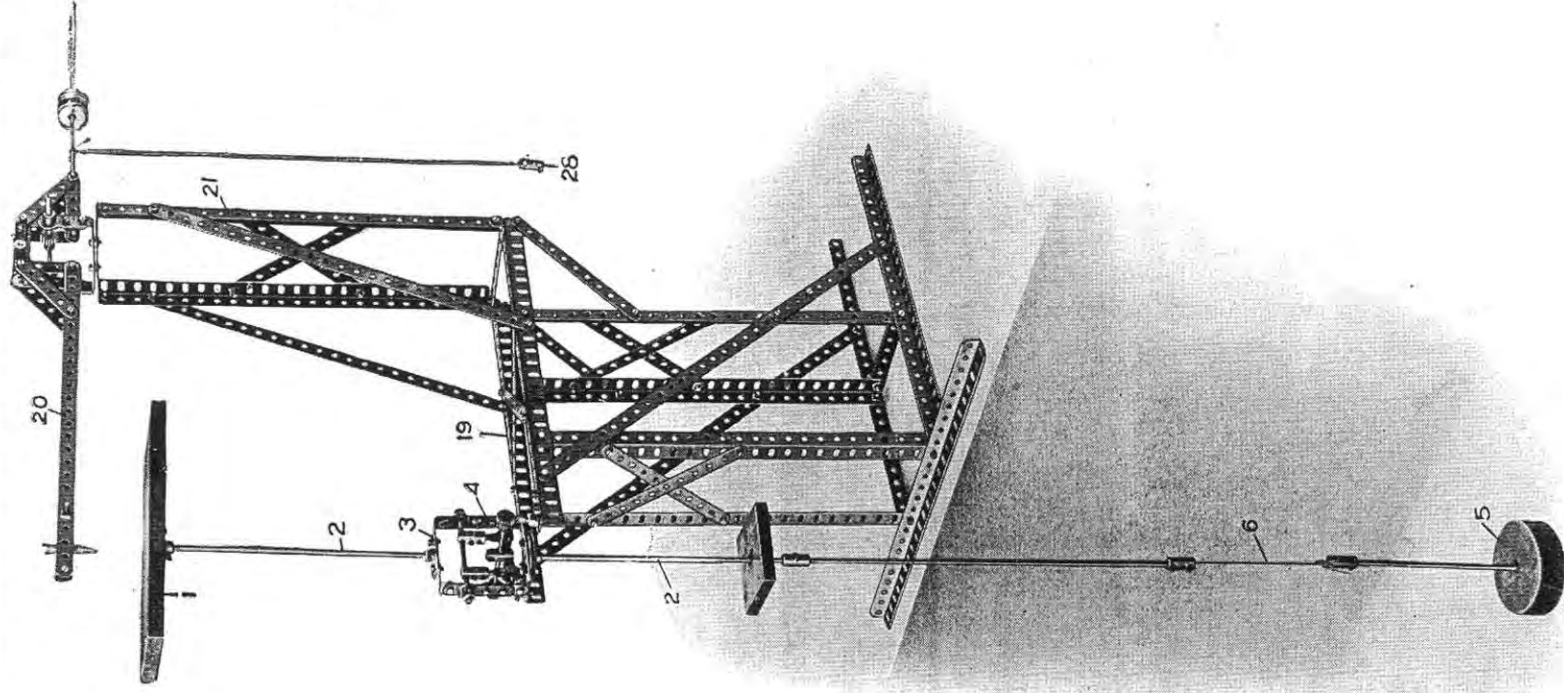


FIG. 732B

This Model can be made with MECCANO Outfit No. 7, or No. 6 and No. 6A



Model No. 733

# Twin Elliptic Harmono- graph

Parts required :	
8 of No.	1
10 "	2
3 "	3
4 "	4
6 "	5
4 "	6
11 "	7
5 "	11
2 "	12
2 "	13
2 "	13A
1 "	14
3 "	16
2 "	16A
1 "	17
1 "	21
3 "	22
2 "	22A
2 "	24
6 "	26
86 "	37
2 "	37A
2 "	38
3 "	46
4 "	59
1 "	60B
6 "	62
9 "	63
6 "	65
1 "	107
2 "	111

This Model can be made with MECCANO Outfit No. 7, or No. 6 and No. 6A

## Model No. 733—Twin-Elliptic Harmonograph (continued)

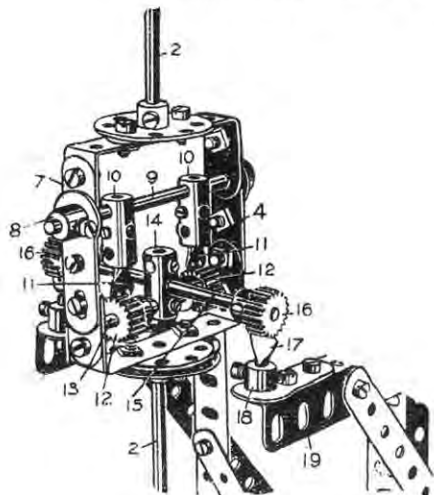


FIG. 733A

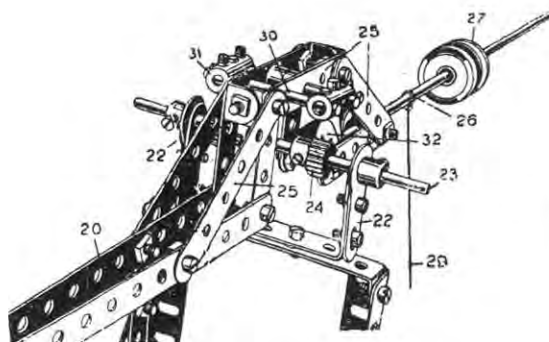


FIG. 733B

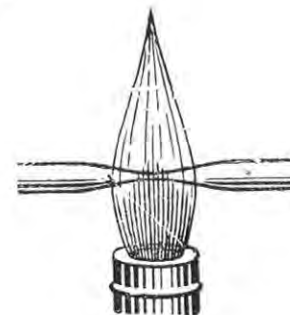


FIG. 733c

The table 1, upon which the paper for the design rests, is carried on a rod 2, the lower end of which is bolted to a bush wheel 3, which in turn is bolted to a frame 4, Fig. 733A, the lower rod 2 being similarly bolted to the frame 4 and carrying a somewhat heavy weight 5.

In order to obtain a flexible movement of the weight 5, the lower parts of the rod are coupled by a short length of string 6.

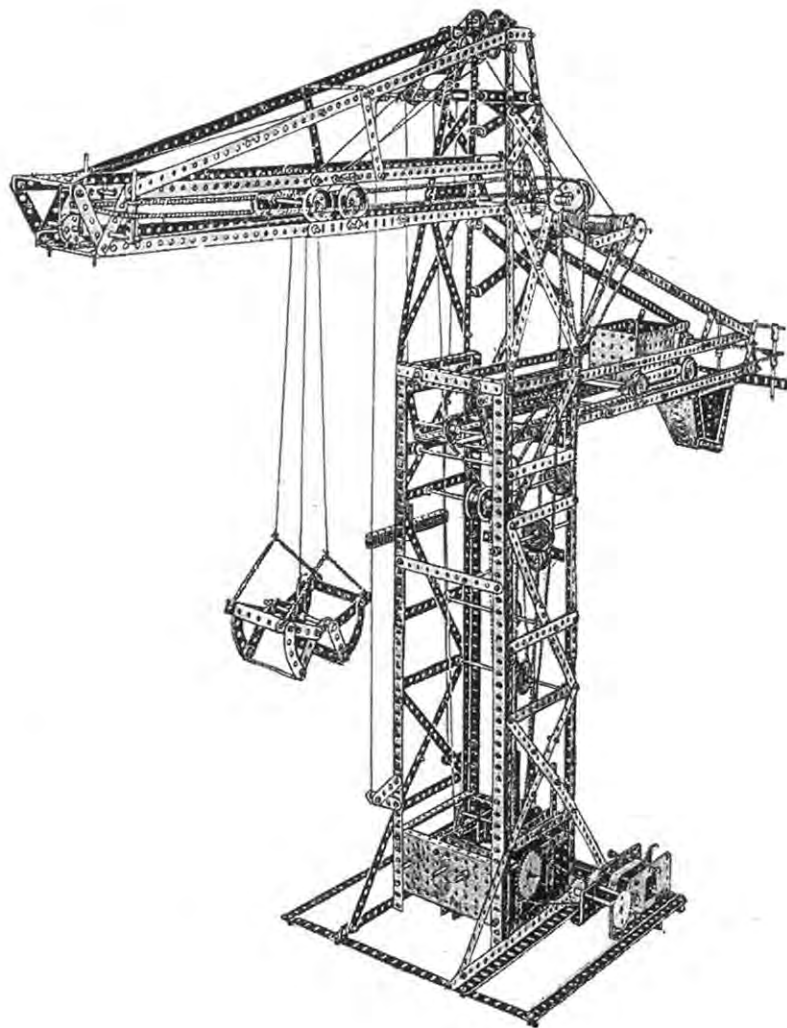
The frame 4 is built up as shown in Fig. 733A, of double angle strips  $2\frac{1}{2}$ " by 1", connected by  $2\frac{1}{2}$ " side strips 7, outside which are bolted cranks 8 to provide bearings for a rod 9 secured in the crank bosses. On the rod 9 are secured couplings 10 in the lower ends of which are mounted centre forks 11 forming knife edges engaging between the teeth of two  $\frac{1}{4}$ " pinions 12 fixed on a 2" rod 13, which is secured in a centre coupling 14 across which, in the centre hole of each, is bolted a  $3\frac{1}{2}$ " rod 15. On the outer ends of this rod 15 are two  $\frac{1}{4}$ " pinions 16 which rest upon centre forks 17 forming lower knife edges, secured in the bosses of cranks 18 carried on angle girders 19. Consequently, the frame 4 is balanced so as to swivel in two directions about the knife edges 17 and the knife edges 11. The ink pencil is gripped between the ends of two  $1\frac{1}{2}$ " strips 20, forming an arm which is pivotally supported as shown in Fig. 733. At the top of the arm 21, Fig. 733B, are bolted two cranks 22, in the bosses of which is secured a rod 23 carrying two pinions 24. The strips 20 are coupled by 3" and 2" strips 25 to form a yoke, in the rear of which is fixed a rod 26 on which is a balance weight 27, formed by a number of pulleys, and a further weight 28 is suspended from the rod 26 by cord 29. The balance weight is adjusted along the rod so that the pencil will just rest lightly on the paper on the table 1, and the extra weight 28, when hanging free, as in Fig. 733, just lifts the pencil clear of the paper. By lifting the weight 28 and resting it somewhere on the frame, the pencil is brought into light contact with the table 1.

In the yoke 25 are inserted two rods 30, each carrying couplings 31 in the centre holes of which are secured centre forks 32 forming knife edges, which engage the  $\frac{1}{4}$ " pinions 24 about which the pencil arm swivels.

The pencil is made by drawing out a short length of  $\frac{1}{8}$ " glass tubing in a bunsen or methylated spirit lamp, about  $\frac{1}{4}$ " taper, Fig. 733c, and the end ground smoothly on a clean wet hone laid on the table; the tube is then filled with ink, which flows freely through the fine perforation in the point.

To operate the apparatus, if the weight 5 be given a swinging movement, the table 1 is oscillated, and the stationary pencil describes a diagram on the paper, which is varied according to the direction in which the weight swings.





Model No. 734

## High-Speed Ship Coaler

This Model will appeal to most boys interested in shipping, as showing the manner in which ships can be coaled quickly. The apparatus is centrally controlled and is a good example of the adaptability of Meccano to the construction of such complicated mechanical models.

This is another model to which it is not possible to do justice in this Manual. Instructions for making it will be furnished on application.

These Models can be made with MECCANO Outfit No. 7, or No. 6 and No. 6A

## Interesting Experiments in Applied Mechanics with Meccano

Few boys know what an important part the science of "Applied Mechanics" plays in everything which they see around them. It is this science which enables engineers to design machines, so that they will withstand all kinds of strains. It enables bridge builders to make their constructions so that they are able to guarantee them to bear certain weights. When an engineer builds a crane and guarantees it to lift a load of so many tons, "Applied Mechanics" tells him where the strain will come, exactly what strength of materials he must use, and how his crane ought to be designed.

Of course "Applied Mechanics" is a big subject, and you can only grasp its principles thoroughly after a lot of study; but it is a very fascinating subject, and some of the elementary principles are most interesting and novel and not at all difficult to understand. To simplify the working out of the examples which will be found on the following pages, we have introduced a standard frame work, so that the various examples may be easily and quickly set up. Any boy can get lots of fun and learn a lot of useful points in mechanics, by making these experiments.

The following is a list of the parts required to build all the Scientific Examples illustrated here:—

No. 1.	2 Perforated strips, 12½"	No. 13A.	1 Rod, 8"	No. 57A.	6 Scientific hooks
.. 2.	12 .. .. 5½"	.. 15.	6 .. 5"	.. 59.	12 Collars and set screws
.. 3.	6 .. .. 3½"	.. 16.	1 .. 3½"	.. 60.	6 2½" bent strips
.. 4.	6 .. .. 3"	.. 17.	6 .. 2"	.. 62.	2 Cranks
.. 5.	6 .. .. 2½"	.. 19.	1 Crank handle	.. 63.	4 Couplings
.. 7.	4 Angle girders, 24½"	.. 19B.	6 Pulley wheels, 3"	.. 66.	12 50-gram weights
.. 7A.	4 .. .. 18½"	.. 20.	4 Flanged and grooved wheels	.. 67.	2 25 .. ..
.. 8.	6 .. .. 12½"	.. 21.	2 Pulley wheels, 1½"	.. 68.	12 ½" wood screws
.. 9.	1 .. .. 5½"	.. 22.	1 .. .. 1"	.. 81.	3 Screwed rods, 2"
.. 10.	24 Flat brackets	.. 24.	1 Bush wheel	.. 82.	1 .. .. 1"
.. 11.	2 Double ..	.. 37.	48 Nuts and bolts	.. 94.	5' Sprocket chain
.. 12.	12 Angle ..	.. 38.	12 Washers	.. 95.	1 .. .. wheel 2"
.. 12A.	4 .. .. 1"	.. 43.	1 Spring	.. 96.	1 .. .. 1"
.. 13.	1 Rod, 11½"	.. 52.	3 Perforated flanged plates, 5½" × 2½"		1 Board, 12½" × 11½" × ½"

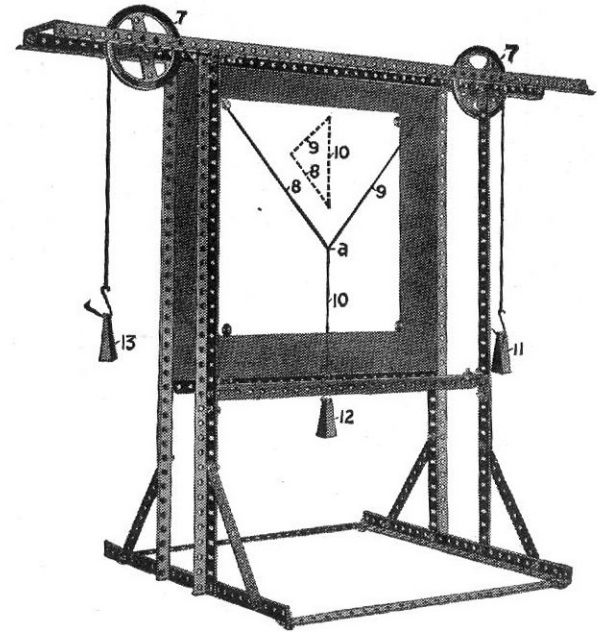
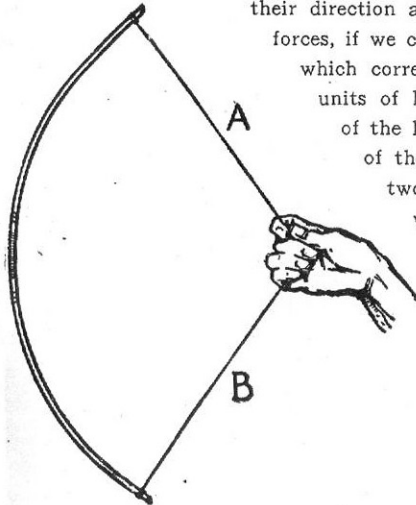
The board is not provided in this Outfit on account of its size. This, however, can be provided at little expense.

## Model No. 735 Triangle of Forces

The first example is called the "Triangle of Forces." Briefly, if three forces meet at a point and balance each other, and we know one of the forces, we can find out the other two by drawing a triangle, making each side parallel to the direction of one of the forces. To demonstrate this, two large pulleys 7 are carried on rods in the top rails, and cords 8, 9, passed over these pulleys and their ends joined to another cord 10. Weights 11, 12, and 13 are then hung on the ends of the cords 8, 9, and 10, and when the point of junction (a) of the three cords has come to rest, lines in the direction of the cords are drawn on the sheet of paper, which is afterwards removed and a triangle drawn, as shown in the illustration, with its sides 8, 9, and 10 parallel to the directions of the three cords. This triangle is shown in dotted lines. If the sides of the triangle are measured it will be found that they are in the same proportion as the weights 11, 12, and 13. For instance, if the weight 12 were 15 units and the weight 13 were 9 units, and the weight 11 were 7 units, the lengths of the sides of the triangle would be 15, 9, and 7 units. By this experiment, therefore, we demonstrate that when three forces meet at a point, and we know

their direction and the value in grammes or pounds of one of the forces, if we construct a triangle, making that side of the triangle which corresponds to the known force equal to a number of units of length, each unit representing a gramme or pound of the known force, then by scaling off the other two sides of the triangle we can determine the value of the other two forces in grammes or pounds. Several experiments with different weights should be tried and triangles drawn, and the accuracy of the apparatus for different weights tested.

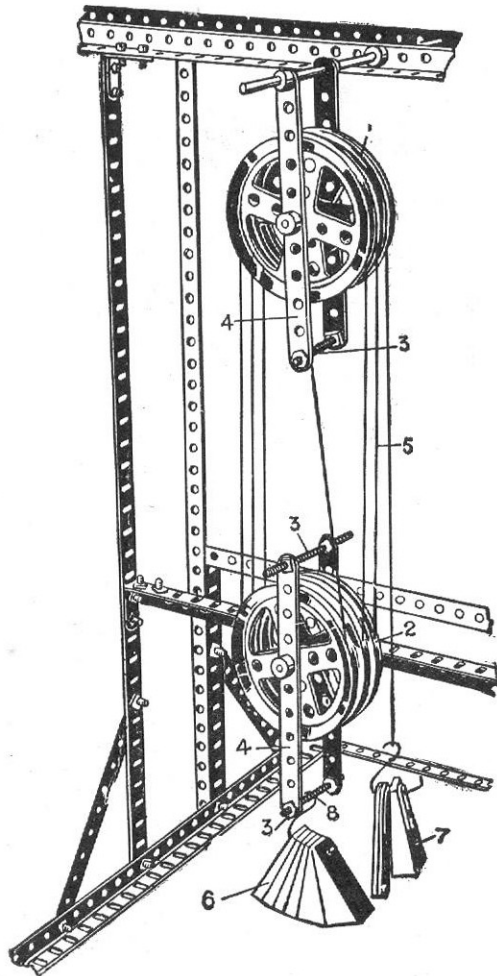
As an example of the triangle of forces, when a boy pulls a bow to shoot an arrow, if we know the force he pulls with, we can find the pull along each part A and B of the string by measuring the angle which the string forms.



Little difficulty will be experienced in constructing the Meccano Demonstration Frame from this illustration. It may be well to mention, however, that the rear uprights, which consist of  $18\frac{1}{2}$ " angle girders, are secured to the sides of the board shown in the illustration by ordinary wood screws. The  $24\frac{1}{2}$ " girder at the top is secured in the same manner, as is also the  $12\frac{1}{2}$ " girder at the bottom. The board is used for pinning on sheets of paper, upon which the diagrams are drawn.

## Model No. 736

## Pulleys

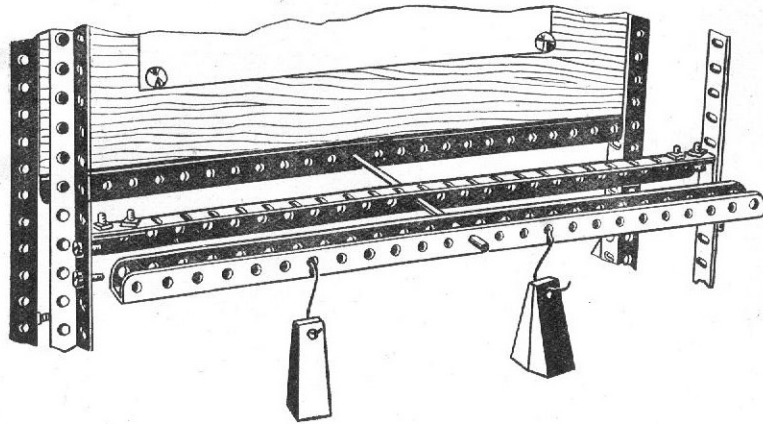


In this model the principle of a purchase pulley block is demonstrated. In engineering shops and other places where heavy weights are required to be lifted by hand, it is necessary to provide some means so that the ordinary power that a man can exert is multiplied to such an extent as to enable him to lift much heavier weights than would otherwise be possible without a pulley block. Whenever an apparatus for this purpose is used, what is gained in power is lost in speed. The pulley block shown consists of three 3" pulley wheels 1 in the upper block and a similar number of wheels 2 in the lower block. The construction of these blocks may be seen from the illustration, the rods 3 being screwed throughout their length, and the side strips 4 held thereon by nuts on the rods 3 inside and outside of the strips. The upper block 1 is fixed from the top girders of the frame, but the lower pulley block 2 is supported on the loops of the cord 5 and rises and falls carrying with it the weights 6 suspended from the lower block. The weights 6 represent the load to be lifted and the smaller weight 7 represents the power applied such as the pull of a man. If there were no such thing as friction in the bearings of the pulleys, then the proportion of the weight 7 necessary to balance or just raise the weights 6 would be as 1 is to 6. Of course the weight 7 moves six times the distance that the load 6 is lifted or lowered, so that although the heavy load 6 is overcome by a light power 7 the distance the power weight 7 has to move is considerably greater, in fact it is six times as great. In order to ascertain the amount of friction to be overcome, it is necessary in the first place to attach small weights to a hook 7, sufficient to counterbalance the weight of the lower block to the point when it commences to move. After the weights have been added as indicated above, that is, in the proportion of 1 to 6, the amount of friction can be ascertained by again adding small weights to the point when it commences to move, the weights added representing the amount of friction.

Different load weights 6 should be hung on the lower pulley, and it should be noted what are the corresponding power weights 7 required just to overcome the load weights. These results should be tabulated like the following which were obtained by experiment:

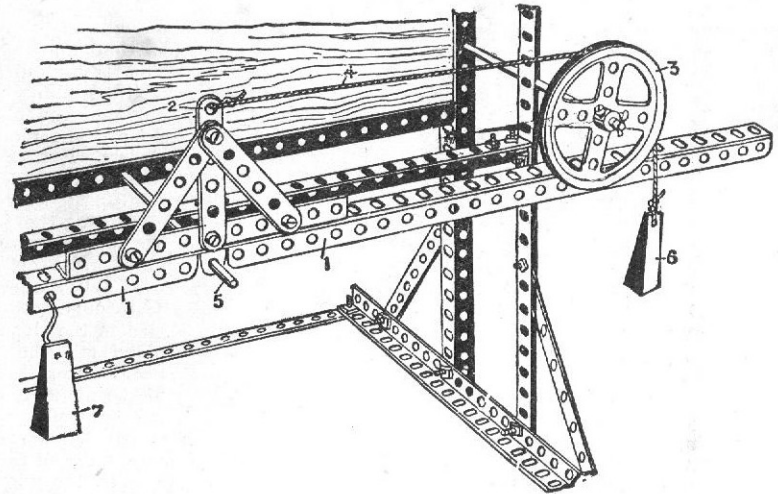
Power.	Load.	Friction.
$25 + 3.3 = 28.3$ grammes	150 grammes	2.2 per cent.
$50 + 6.6 = 56.6$ ,,	300    ,,	2.2    ,,
$75 + 8.8 = 83.8$ ,,	450    ,,	1.9    ,,

## Model No. 737 Levers



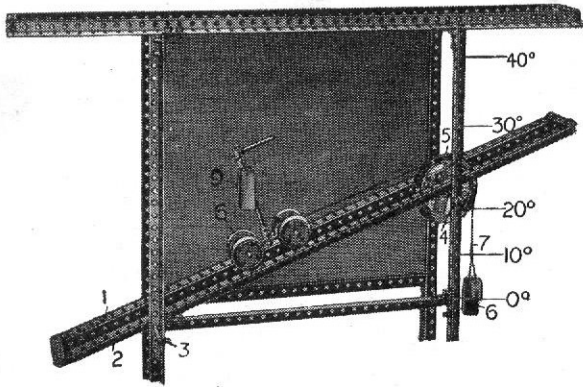
If we have a lever 6" long and pivoted 4" from one end, the arms of the lever will be 4" and 2", and if we hang a 2-lb. weight at the end of the 2" arm, we say that the moment of the force of the 2-lb. weight about the pivot is equal to the weight in pounds multiplied by the length of the arm in inches. In this case the moment, therefore, would be  $2 \times 2 = 4$ , and this would be called a moment of 4 inch-lbs. Similarly if a weight of 1-lb. were hung at the end of the 4" arm of the lever we would say that the moment of that weight would be 1-lb. multiplied by the length of the arm,  $1 \times 4 = 4$ , and we would call this 4 inch-lbs. Now when the moments of a lever obtained in this way are equal, the lever is balanced. Levers are of various kinds; they may be straight levers or bell-crank levers, that is to say, where one of the arms is at right angles to the other. A straight lever is shown in this Model and a bell-crank lever in Model No. 737A. Now we will demonstrate the principle of moments in the case of the straight lever. This is made up of two  $12\frac{1}{2}$ " angle girders bolted together as shown, and pivoted on a short rod. The holes in the Meccano strips are all at a standard distance of  $\frac{1}{2}$ " apart, so that we can easily fix the lengths of the lever arms in inches by counting the holes. If we hang two weights of 50 grammes (that is 100 grammes) from the third hole, or  $1\frac{1}{2}$ " from the pivot at one side, the moment of that weight will be  $100 \times 1\frac{1}{2} = 150$  inch-grammes. Now if we hang a single weight of 50 grammes on the other side at six holes or 3" from the pivot the moment will be  $50 \times 3 = 150$  inch-grammes, and as the moments are equal the lever will balance, though the weights themselves are unequal.

## Model No. 737a Bell Crank

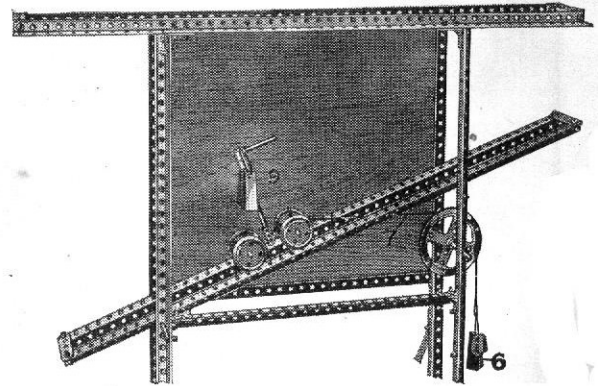


This Model is made up of two  $12\frac{1}{2}$ " angle girders 1 braced to a vertical strip 2, pivoted through a double bracket. A large wheel 3 is mounted on a rod in the side girders, care being taken that the cord 4 coming over the top of the pulley is parallel to the angle girders 1 of the lever. The arms of this lever are the left angle girder 1 and the vertical strip 2, and in order that this lever may balance about its pivot 5, the moment of the forces about the pivot must be equal, as we have previously described. Supposing, therefore, we hang a weight 6 of 50 grammes on the end of the cord 4 round the pulley 3, and connect the cord 4 to the strip 2 at 6 holes or 3" distance from the pivot 5 then the moment of the force will be the weight 50 multiplied by 3 = 150. The lever will be kept balanced if we hang an equal weight 7 of 50 grammes on the angle girder 1 at 6 holes or 3" distance from the pivot 5, because the moments  $50 \times 3 = 150$  inch-grammes, are then equal. If, on the other hand, we hang two weights 6 of 50 grammes each on the end of the cord 4, the lever will be balanced by one 50 gramme weight 7 at 12 holes or 6" distance from the pivot.

## Model No. 738 Inclined Plane



Another interesting principle which may be demonstrated on this apparatus is that known as the Inclined Plane. The force required to raise a body up an inclined plane varies according to the angle of the plane, that is to say, the slope. The plane is made of two angle girders 1, 2, connected together at each end by  $2\frac{1}{2}$ " strips and fixed on a rod 3 passed through holes in the vertical girders of the frame and the girders of the plane, and the other end of the plane rests on a rod 4 which carries a 3" pulley wheel 5. By placing the rod 4 through different holes in the side girders the slope or angle of the inclined plane may be varied. To obviate the need of a protractor to ascertain the slope of the plane, it may be stated that if the rod 4 be placed in the fourth hole with



the plane pivotally mounted on rod 3 (as shown in the illustration) the surface of the plane will represent an incline of  $10^\circ$ . If placed in the 9th hole,  $20^\circ$ . If in the 15th hole  $30^\circ$ , and if in the 21st hole  $40^\circ$ . The force or weight 6 on the cord 7 is arranged to act parallel to the plane, and the cord is connected to the carriage 8 so that the latter may roll up the plane. The bearings for the axles of the wheels are formed of couplings and connected by a 2" rod.

Before commencing the experiment, weights should be hung on the cord 7, which are just sufficient to balance the carriage 8. If a weight 9 be then hung on the carriage it should be noted what additional weight is required to be hung on the end of the cord 7 just to make the carriage slowly ascend the plane. The weight 9 should then be varied and the alteration in the weight 6 on the cord 7 to make the carriage ascend the plane noted, and these results should be tabulated.

When the student has finished this experiment he should try the second example illustrated above, where the force along the cord 7 is not parallel to the slope of the plane, but is horizontal, first hanging on weights 6 until the carriage is just balanced on the plane, and then hanging different weights 9 on the carriage and noting what additional weights at 6 are necessary just to cause the carriage to begin to move up the plane. These results should also be tabulated.

Experiments made with the apparatus have yielded the following results:

When forces are parallel to the plane:		
At	FORCE 6 Grammes.	WEIGHT 9 Grammes.
$10^\circ$	22.2	100
$20^\circ$	40.54	100
$30^\circ$	58.8	100
$40^\circ$	70	100

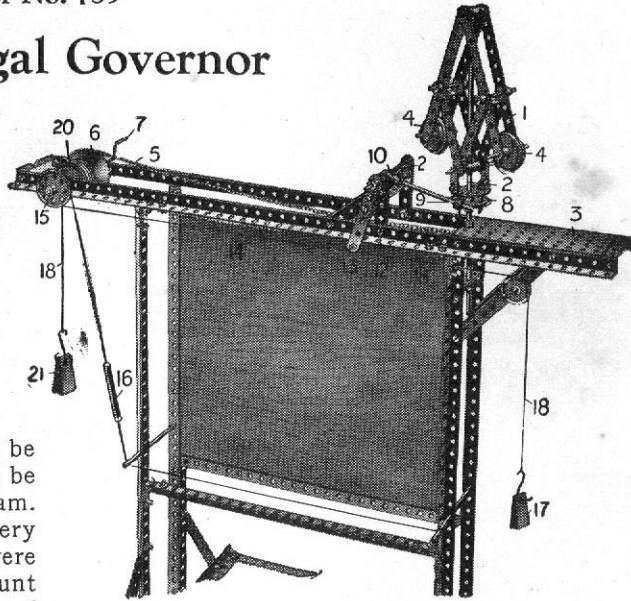
When forces are horizontal:		
At	FORCE 6 Grammes.	WEIGHT 9 Grammes.
$10^\circ$	23.31	100
$20^\circ$	43.87	100
$30^\circ$	63.2	100
$40^\circ$	89.43	100

A good example of an inclined plane is a horse pulling a cart up a slope, the horse being the force and the cart the weight.

Model No. 739

# Centrifugal Governor

In this model an apparatus is shown for demonstrating the controlling effect of a governor. A governor is a device which is fitted on an engine in order to make its speed constant. In the case of an engine driving a works, for instance, if all the machinery in the shop were running, the engine would be driving a heavy load and would be using a certain amount of steam. If a great portion of the machinery were stopped and the engine were allowed to take the same amount of steam, owing to the lightness of the load then on the engine it would race at great speed and probably be damaged. To prevent this engineers fit a governor device which, as the load on the engine is lightened, automatically shuts off the steam, or throttles it, and which, as the load comes again on the engine, permits it to take more steam. The governor thus arranges the steam supply to the engine to be suitable for the load which the engine bears and to drive it at a constant speed. Most governors are of the centrifugal ball type, that is to say, they have a pair of ball weights which are spun round by the engine. As the engine's speed increases, the ball weights fly out, and this flying out or centrifugal action is arranged to shut off the steam.



The governor 1, the construction of which is quite clear from the illustration, is mounted on a spindle 2 in a rectangular plate 3 fitted in the top girders. The flanged pulley wheels 4 represent the ball weights of the governor. Below the rectangular plate 3 and on the spindle 2 is a sprocket wheel 22 connected by the sprocket chain 5 to another sprocket wheel 6 on the cranked axle 7.

A bush wheel and a  $1\frac{1}{2}$ " pulley wheel 8 are fixed on the spindle of the governor a slight distance apart, and the head of a bolt in the collar 9 engages between the wheels 8. The collar 9 is connected by a coupling 10 to a rod 11 pivoted in the strips 12. The near end of the rod carries a strip 13, clamped between two cranks, to which is connected a cord 14 passed once round the  $1\frac{1}{2}$ " pulley 15 and connected to the spring 16. The cord 14 acts as a brake on the pulley 15, another cord 18 connected to the strip 13 carries a weight 17, and another cord 19, which is wound on the flanges of two reversed flanged and grooved wheels, is loaded with different weights 21 in order to conduct the experiments. The weights 21 correspond to the driving force of the engine, and the governor controls this varying driving force by applying the brake which is the cord 14. Different weights 21 should be hung on the cord 19, and the cord then wound up to the top by the crank axle 7. The time taken for different weights 21 to fall should be noted, and if the apparatus has been properly adjusted the different weights 21 should take nearly the same time to fall to the floor. If heavy weights are hung on, the governor ball weights 4 fly out and raise the discs 8 which swing the strip 13 and apply the brake thus retarding the fall of the weights. The student should tabulate his results, using different weights and noting the variation in seconds taken for the weights to fall. The following are examples:—

Weight.	Time in falling.	Weight.	Time in falling.	Weight.	Time in falling.
75 grammes	12 Secs.	100 grammes	11 Secs.	200 grammes	10 Secs.

# MECCANO ACCESSORY OUTFITS AND MOTORS



## Meccano Accessory Outfits

Our illustration shows one of the Meccano Accessory Outfits. As has already been explained, these Outfits connect the main Outfits from No. 00 to No. 7, making it possible for a boy who commences with one of the earlier Outfits to build up his equipment by easy stages, until he is the possessor of parts that cover the entire system. For prices see page 206.

## Electrical Outfit

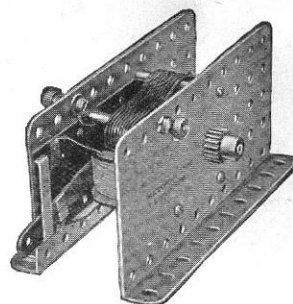
All Meccano boys are fascinated by electricity and never become tired of learning more about this wonderful subject. The application of electricity to the Meccano system adds a further and wonderful charm, and the joys of model-building are now increased by the fascinating pastime of carrying out delightful electrical experiments.

The Meccano Electrical Outfit contains a number of specially designed electrical parts which may be used in conjunction with any of the regular Outfits. For price see page 206.



## 4-Volt Electric Motor

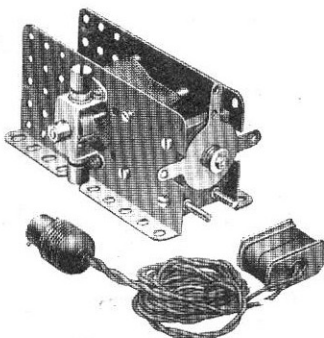
The 4-volt motor is also specially designed to build into Meccano models. It is a most reliable and powerful model and when properly geared will lift over 30 lbs. dead weight. It may be run by a 4-volt accumulator, or by employing a suitable transformer, direct from the main, fitted with reversing motion, provided with stopping and starting controls, and the gearing is interchangeable. For price see page 206.



## No. 2 Electric Motor (100-250 Volt)

This Electric Motor may be employed for any purpose for which a small motor is suitable, but it is specially adapted for driving Meccano models. The side plates are perforated with standard equidistant holes, thus allowing the motor to be built into any Meccano model. The motor is specially designed for connection with the electric-light main. It is supplied for 100-120 volts or 200-250 volts (alternating or direct), and is fitted with 6 ft. length of flex, an insulated plug for connection with the motor terminals, and an adapter for connection with an ordinary lamp socket.

A suitable resistance is required when the motor is run with a 200-250 volt current, and this is supplied by connecting a 20-watt lamp in series with the motor. A board on which are mounted a suitable lamp-holder (lamp not included) and a switch is provided separately. For prices see page 206.



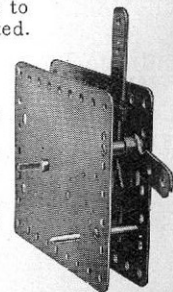
## 4-Volt Accumulator

This new and excellent type of accumulator has been adapted to drive the 4-volt Electric Motor. It has been subjected to the severest tests and has proved itself to be the most suitable accumulator for use with any type of electric motor. It is non-spillable, has remarkable recuperative powers, and will continue to supply current when nominally exhausted. For price see page 206.



## Clockwork Motor

How splendid it is, after spending hours in building a model, to be able to set it in motion with a motor, just as do real engineers! The Meccano Clockwork Motor is specially made for this purpose and is a fine piece of mechanism—simple, powerful, and reliable. It is fitted with starting and stopping levers, and has a reversing movement. For price see page 206.

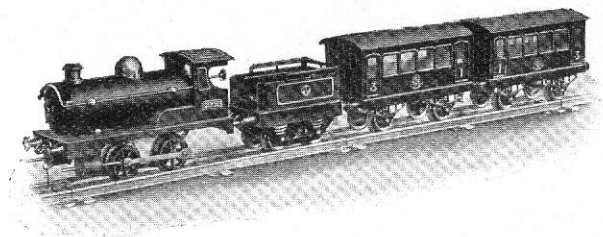
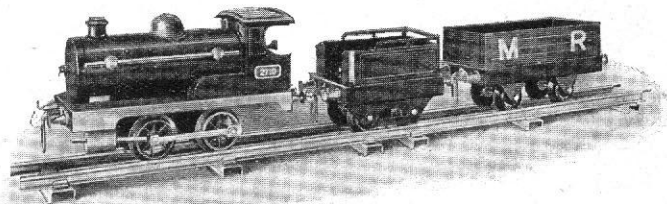




# HORNBY CLOCK WORK TRAINS

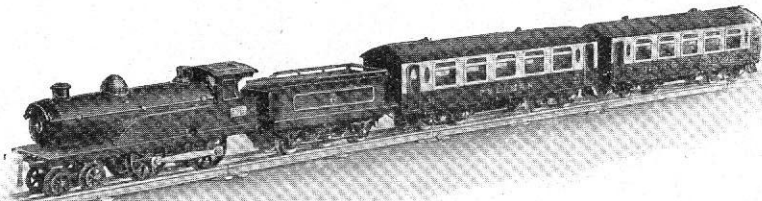
THE HORNBY TRAINS are manufactured by Meccano Ltd., and they are built on the Meccano principle. All the parts are standardised and Engines, Tenders, Coaches and Wagons may be taken entirely to pieces and rebuilt. If one of the parts is lost or damaged you may fit a new one yourself. *A Hornby Train lasts for ever!* The Hornby Train is a beautiful piece of workmanship, with perfect clockwork mechanism, ensuring smooth running. Each Train is guaranteed by Meccano Ltd.

No. 1 PASSENGER SET.—Gauge 0. Each Set contains Loco, Tender and two Coaches, with Rails for a 2 ft. diameter circle and two straights. The Loco is fitted with reversing gear, brake, and governor. In four colours to represent L. & N.W., G.N., Midland, and Caledonian rolling-stock. Complete in brown leather-finished gold-embossed box. *For price see page 62*



No. 1 GOODS SET.—Gauge 0. This Set is similar in every way to No 1 Passenger Set, except that it contains Loco, Tender and one Wagon. Complete in strong attractive gold-embossed box. *For price see page 62*

No. 2 PULLMAN SET.—This Set includes Loco and Tender of a larger type, measuring 17" in length. A superior mechanism has been adopted, making this the most attractive and satisfactory clockwork train yet produced. The Coaches are beautiful, both in colour and finish. Each Set includes Loco, Tender, one Pullman and one Dining Coach, as illustrated, with set of Rails making a 4 ft. diameter circle. Gauge 0. In four colours to represent L. & N.W., G.N., Midland, and Caledonian rolling-stock. The Loco is fitted with reversing gear, brake and governor. Complete in gold-embossed box. *For price see page 62*



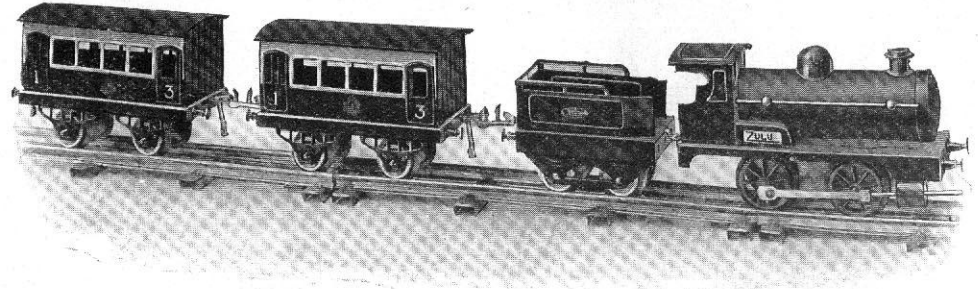
No. 2 GOODS SET.—Similar to Passenger Set No. 2 but two Wagons in place of Coaches. Complete in gold-embossed box  
SEND FOR SPECIAL LIST OF RAILS, POINTS AND CROSSINGS. (*See page 61*)

# ZULU CLOCKWORK TRAINS

Fine and durable mechanism and strength of construction of all parts are the main characteristics of this new type of clockwork train. The Zulu is a well designed and efficient train and will give excellent and long service. Richly enamelled and highly finished; fitted with brake and governor; non-reversing.

Each Set contains Loco Tender, two Passenger Coaches and Set of Rails, including a 2 ft. diameter circle and two straights. Gauge 0. In black only.

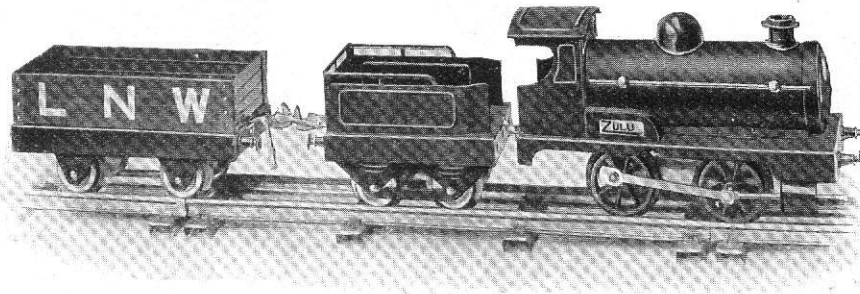
*For price see page 62*



ZULU PASSENGER SET

Zulu Goods Set as above but containing one wagon in place of passenger coaches.

*For price see page 62*



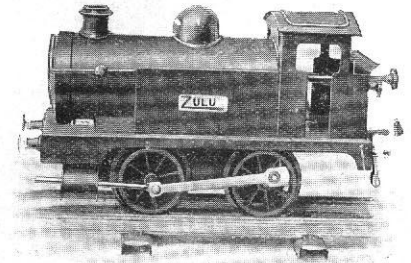
ZULU GOODS SET

## ZULU TANK LOCO.

A strong and durable loco capable of any amount of hard work; richly enamelled and highly finished; fitted with brake, governor, and reversing gear.

Gauge 0. In black only.

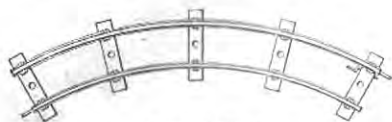
*For price see page 62*



ZULU TANK LOCO

## MECCANO RAILS, POINTS AND CROSSINGS

The range of Meccano Rails, Points and Crossings is now very comprehensive and a special leaflet is published (price 4d. post free) showing some of the combinations of rail designs to which Meccano Rails, etc., lend themselves. The curved rails are made in both 1-ft. and 2-ft. radius (to form circles of 2-ft. and 4-ft. diameter respectively). For those interested in electric railways these rails are also made with a third rail. Send for the latest list and prices.

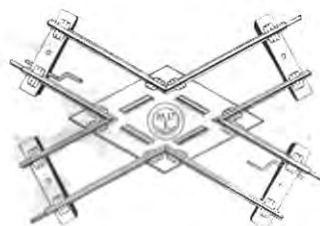


Curved Rails.

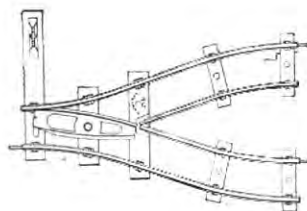
(Also made in half and quarter lengths)



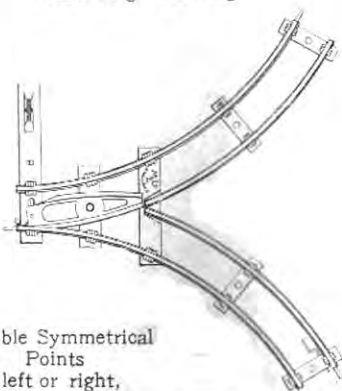
Straight Rails.



Acute Angle Crossing.



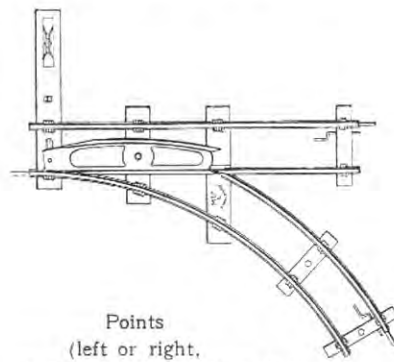
Parallel Points (left or right).



Double Symmetrical  
Points

(left or right,

in either 1 ft. or 2 ft. radius).



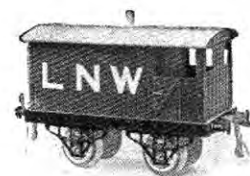
Points

(left or right,

in either 1 ft. or 2 ft. radius)

## TRAIN ACCESSORIES.

Gauge 0.



BRAKE VANS

Finished in colour to represent L. & N. W. system.  
Each 4/-



PETROL TANK WAGONS

Finished in red, lettered gold.  
Each 3/6



BRAKE VANS

Finished in colour to represent G.N. system.  
Each 4/-



CEMENT WAGONS.

Enamelled in colour.  
Each 4/6



GUNPOWDER VANS

Finished red. Each 4/-



SPRING BUFFER STOPS

Enamelled in colour.  
Each 2/-

## MECCANO PRICE LIST

### MECCANO OUTFITS

No. 0 Meccano Outfit	...	...	...	...	7/6
" 1	"	"	...	...	12/6
" 2	"	"	...	...	23/-
" 3	"	"	...	...	35/-
" 4	"	"	...	...	60/-
" 5 *	"	(Carton)	...	...	80/-
" 5 *	"	Presentation Outfit	...	...	125/-
" 6	"	Presentation Outfit	...	...	210/-
" 7	"	"	...	...	540/-
Meccano Clockwork Motor	...	...	...	...	13/6
" Electric Motor	...	...	...	...	18/6

### ACCESSORY OUTFITS

No. 0A Meccano Outfit	...	...	...	...	6/-
" 1A	"	"	...	...	11/6
" 2A	"	"	...	...	13/-
" 3A	"	"	...	...	26/-
" 4A	"	"	...	...	20/-
" 5A *	"	(Carton)	...	...	75/-
" 5A *	"	(Wood)	...	...	120/-
" 6A	"	"	...	...	300/-
Inventor's Accessory Outfit A	...	...	...	...	12/6
" " " " B	...	...	...	...	22/6
No. X1 Meccano Electrical Outfit	...	...	...	...	18/6
" X2	"	"	...	...	65/-

\* Outfits Nos. 5 and 5A are supplied in neat and well-made cardboard boxes (cartons) or in superior oak cabinets, with lock and key

## Clockwork Train Price List.

### HORNBY.

No. 1 Passenger Set complete	...	...	...	...	52/6
" 2 Passenger	"	"	...	...	105/-
" 1 Goods	"	"	...	...	37/6
" 2 Goods	"	"	...	...	67/6
No. 1 Locos	...	...	...	each	24/-
" Tenders	...	...	"	5/3	
" Passenger Coaches	"	9/6			
" Wagons	...	...	"	5/6	
No. 2 Locos	...	...	...	each	45/-
" Tenders	...	...	"	6/-	
" Pullman or Dining Cars	"	24/-			
" Wagons	...	...	"	5/6	

### ZULU.

Passenger Set complete,	37/6
Goods " "	27/6
Locos ... .. each	15/6
Tenders ... .. "	3/9
Passenger Coaches "	7/6
Wagons ... .. "	4/6
Zulu Tank Locos... "	18/-

# Contents of Outfits.

No.	DESCRIPTION OF PART.	0	0A	1	1A	2	2A	3	3A	4	4A	5	5A	6	6A	7
1	Perforated Strips, 12 $\frac{1}{2}$ "		4	4	6	10		10	2	12	4	16	32	48	2	50
1A	" " 9 $\frac{1}{2}$ "		2	6	8	14	4	18	3	21	5	26	24	50	25	12
2	" " 5 $\frac{1}{2}$ "	4														
2A	" " 4 $\frac{1}{2}$ "		1	1	1	2	4	6	2	6	2	6	6	18	6	24
3	" " 3 $\frac{1}{2}$ "															
3A	" " 3"															
4	" " 2 $\frac{1}{2}$ "	9		9	3	12	2	12	4	18	18	36	16	36	12	36
5	" " 2"															
5A	" " 2"															
6	" " 1 $\frac{1}{2}$ "															
6A	" " 1 $\frac{1}{2}$ "															
7	Angle Girders, 24 $\frac{1}{2}$ "															
7A	" " 18 $\frac{1}{2}$ "															
8	" " 15 $\frac{1}{2}$ "															
8A	" " 9 $\frac{1}{2}$ "															
9	" " 5 $\frac{1}{2}$ "															
9A	" " 2 $\frac{1}{2}$ "															
10	Flat Brackets	5		5	3	8		8	4	8	4	12	4	16	8	24
11	Double Brackets															
12	Angle Brackets, 1 $\frac{1}{2}$ " X 1 $\frac{1}{2}$ "	2		2	2	4	2	4	1	5	3	8	8	16	2	18
12A	" " 1 $\frac{1}{2}$ " X 1 $\frac{1}{2}$ "	8		8	2	12	1	14	3	22	14	36	44	80	16	96
13	" " 1 $\frac{1}{2}$ " X 1 $\frac{1}{2}$ "															
13B	Axle Rod, 11 $\frac{1}{2}$ "															
13A	" " 8"															
14	" " 6"															
15	" " 5"															
15A	" " 4 $\frac{1}{2}$ "															
16	" " 3 $\frac{1}{2}$ "	2		2	2	4	2	3	2	4	2	5	3	8	2	12
16A	" " 2 $\frac{1}{2}$ "	2		2	1	4		4	1	5	3	5	2	5	7	12
17	" " 2"															
17A	" " 1 $\frac{1}{2}$ "	2		2	1	2	2	2	3	5	4	5	2	5	9	14
18	" " 1 $\frac{1}{2}$ "															
18A	" " 1 $\frac{1}{2}$ "	2		2	1	2	2	2	3	5	4	5	2	5	9	14
18B	" " 1 $\frac{1}{2}$ "															
19	Crank Handle (short)	1		1	1	1	1	2	2	2	2	2	1	3	4	6
19A	Wheels, 30"															
19B	Pulley Wheels, 3"															
20	Flanged Wheels															
20A	" " 1 $\frac{1}{2}$ "	4		4	4	4	1	4	4	8	4	8	8	11	4	19
21	" " 1 $\frac{1}{2}$ " (Fast)															
22	" " 1" (Loose)	1		1	2	1		2	2	2	1	3	3	6	7	12
22A	" " 1" (Loose)															
23	" " 1" (Loose)															
23A	" " 1" (Fast)	1		1	1	1	1	1	1	2	1	2	1	3	4	7
24	Bush Wheels, $\frac{3}{8}$ inch	1		1	1	1	2	2	2	2	2	2	3	5	5	10
25	Pinion Wheels, $\frac{3}{8}$ inch															
26	Gear Wheels, 50 Teeth															
27	" " 57															
27A	Contrate Wheels, 1 $\frac{1}{2}$ " X $\frac{3}{4}$ "															
28	Bevel Gears															
29	Gear Wheels, 38 Teeth															
30	Worm Wheels															
31	Pawl (complete)															
32	Pivot Bolts with Nuts															
33	Spanners															
33A	" " (extra long)															
34	Spring Clips	6		6	4	12		12	6	16		18	6	24	12	36
35	Screw Driver	1		1	1	1		1	1	2		2	2	2	2	3
36	Nuts and Bolts	25		30	25	55	35	90	40	130	45	175	125	300	300	600
37	Washers	6		6	6	12	1	12	12	24	2	24	6	30	170	200
38	Hanks of Cord	1		1	1	2	1	3	1	4	2	6	2	6	4	8
40	Propeller Blades															
41	Cranks	1		1	1	1		1	1	1		1	1	2	3	8
43	Cranked Bent Strips															
44	Double Bent Strips															
45	Double Angle Strips, 2 $\frac{1}{2}$ " X 1"															
46	Eye Pieces	1		1	1	1	1	2	2	5	2	5	3	8	2	10
50	Perforated Flanged Plates, 5 $\frac{1}{2}$ " X 2 $\frac{1}{2}$ "															
52	Flat Plates, 5 $\frac{1}{2}$ " X 3 $\frac{1}{2}$ "															
52A	Perforated Flanged Plates, 3 $\frac{1}{2}$ " X 2 $\frac{1}{2}$ "															
53	Flat Plates, 4 $\frac{1}{2}$ " X 2 $\frac{1}{2}$ "	1		1	1	1	1	1	1	1	1	1	1	1	1	1
53A	Perforated Flanged Plates (Sector)															
54	Instruction Manual	1		1	1	1	1	1	1	1	1	1	1	1	1	1
56	Hook															
57	" (Scientific)															
57A	" (Loaded)															
57B	Spring Cord															
58	Collars with Set Screws															
59	Double Angle Strips, 2 $\frac{1}{2}$ " X $\frac{1}{2}$ "	4		6	2	8	4	10	6	10	3	13	6	18	37	55
60	" " 1 $\frac{1}{2}$ " X $\frac{1}{2}$ "															
60A	" " 5 $\frac{1}{2}$ " X $\frac{1}{2}$ "															
60B	" " 4 $\frac{1}{2}$ " X $\frac{1}{2}$ "															
60C	" " 4 $\frac{1}{2}$ " X $\frac{1}{2}$ "															
60D	Windmill Sails															
61	Cranks															
62																

# Contents of Outfits—continued

No.	DESCRIPTION OF PART.	0	0A	1	1A	2	2A	3	3A	4	4A	5	5A	6	6A	7
62A	Threaded Cranks ...													1	1	2
63	Couplings ...													1	1	13
63A	Octagonal Couplings													1	1	1
63B	Strip Couplings													2	2	6
64	Threaded Bosses ...													1	1	5
65	Conic Forks													3	3	5
66	Weights, 50 Gramme													2	2	5
67	Flat Plates, $5\frac{1}{2} \times 9\frac{1}{2}$ "													3	3	4
70	" " $2\frac{1}{2} \times 2\frac{1}{2}$ "													2	2	4
72	" " $2\frac{1}{2} \times 2\frac{1}{2}$ "													1	1	2
75	Triangular Plates, $2\frac{1}{2}$ "													2	2	4
77	" " $1\frac{1}{2}$ "													2	2	10
78	Screwed Rods, $11\frac{1}{2}$ "													1	1	2
80	" " $5\frac{1}{2}$ "													1	1	2
80A	" " $3\frac{1}{2}$ "													1	1	2
81	" " $2\frac{1}{2}$ "													1	1	2
82	" " $1\frac{1}{2}$ "													1	1	2
89	Curved Strip, $5\frac{1}{2}$ "													4	4	6
90	" " $2\frac{1}{2}$ "													4	4	6
94	Sprocket Chain						4	4	3'	3'	4	3'	5'	8'	17'	25'
95	Sprocket Wheels, $2\frac{1}{2}$ "													1	1	3
95A	" " $1\frac{1}{2}$ "													1	1	1
96	" " $1\frac{1}{2}$ "													2	2	1
96B	" " $1\frac{1}{2}$ "													2	2	1
96A	Brace Girder $3\frac{1}{2} \times 3\frac{1}{2}$ "													2	2	1
97	" " $2\frac{1}{2} \times 2\frac{1}{2}$ "													1	1	1
98	" " $12\frac{3}{8}$ "													1	1	1
99	" " $5\frac{1}{2}$ "													4	4	4
100	" " $5\frac{1}{2}$ "													4	4	6
101	Heads for Looms													1	1	2
102	Single Bent Strips													1	1	2
103	Flat Girders, $5\frac{1}{2}$ "													2	2	6
103B	" " $12\frac{3}{8}$ "													2	2	3
103F	" " $2\frac{1}{2}$ "													2	2	1
104	Shuttles for Looms													2	2	1
105	Reed Hooks ...													1	1	1
106	Wooden Rollers													1	1	2
106A	Sand Rollers													4	4	4
107	Designing Tables													2	2	1
108	Architraves													2	2	1
109	Face Plates, $2\frac{1}{2}$ "													4	4	4
110	Rack Strips, $3\frac{1}{2}$ "													2	2	2
111	Bolts, $\frac{3}{8}$ "						2	2	1	3	1	3	1	2	2	4
112	Double Angle Strips, $2\frac{1}{2} \times 1\frac{1}{2}$ "													1	1	1
112A	" " $3 \times 1\frac{1}{2}$ "													2	2	1
113	Girder Frames													1	1	1
114	Hinges													1	1	1
115	Threaded Pins													2	2	1
122	Miniature Loaded Sacks													1	1	12
123	Cone Pulleys													1	1	2
124	Reversed Angle Brackets, $1\frac{1}{2}$ "													4	4	2
125	" " "													4	4	2
126	Transmissions													5	5	2
126A	Flat Trunnions													1	1	1
128	Res Bell Cranks													4	4	2
130	Triple Throw Eccentrics													1	1	6
131	Drucker Bockets													1	1	1
132	Flywheels, $2\frac{1}{2}$ "													2	2	4
134	Crank Shafts, $1\frac{1}{2}$ " stroke													1	1	5
135	Theodolite Protractor													1	1	1
136	Ship's Funnels													1	1	1
138	Robbins													1	1	1
801	Busies, Insulating													2	2	2
802	Washers													12	12	12
803	6 B.A. Screws													12	12	12
804	6 B.A. Nuts													14	14	14
805	Terminals													30	30	30
806	Contact Screws													4	4	4
808	Pole Pieces													2	2	2
809	Coil Chassis													2	2	2
810	Lamp Holder													1	1	1
811	Lamp													1	1	1
812	27 Gauge B.I. Wire, 30"													1	1	1
813	25 " S.C.C. Wire Reel, 50'													1	1	1
814	23 " " Wire, 4 "													1	1	1
815	Bar Copper Wire, 4 "													1	1	1
	Electric Manual													1	1	1
	Loom Leaflet													1	1	1
	Chassis													1	1	1
	Charging Board Leaflet													1	1	1
	Clockwork Motor													1	1	1
	Electric Motor													1	1	1
	Accumulator													1	1	1



# MECCANO

Hornby's Original System, First Patented 1901

PATENTS AND DESIGNS, GREAT BRITAIN:

139,125	170,785	671,484	681,574	683,011	3,869/14
139,697	577,207	671,485	682,208	686,112	4,183/14
145,357	577,272	671,534	682,209	21,117/12	4,564/15
153,234	648,958	671,790	682,603	20,535/13	13,345/21
154,130	671,212	680,416	682,934	22,962/13	

PATENTED THROUGHOUT THE WORLD.

## Meccano is more than a Toy

**I**T is important to remember that when a boy is playing with Meccano he is using engineering parts in miniature and that these parts act in precisely the same way as the corresponding elements would do in actual practice. No other system of model construction can, therefore, be correct. Other toys which attempt the same object by other methods must avail themselves of other constructive elements which are not correct engineering elements. Consequently, though a boy may succeed in building playthings with them, they are merely toys and nothing else and his mind, as regards proper mechanical construction and methods, is distorted instead of instructed. He thus learns wrong principles and when his ambition tempts him to invent or construct more elaborate models, he will find that he cannot do so because of the deficiencies of his non-mechanical system.

No Outfit is genuine unless it bears the  
trade mark MECCANO.