

MECCANO

1932

BOOK OF PRIZE MODELS

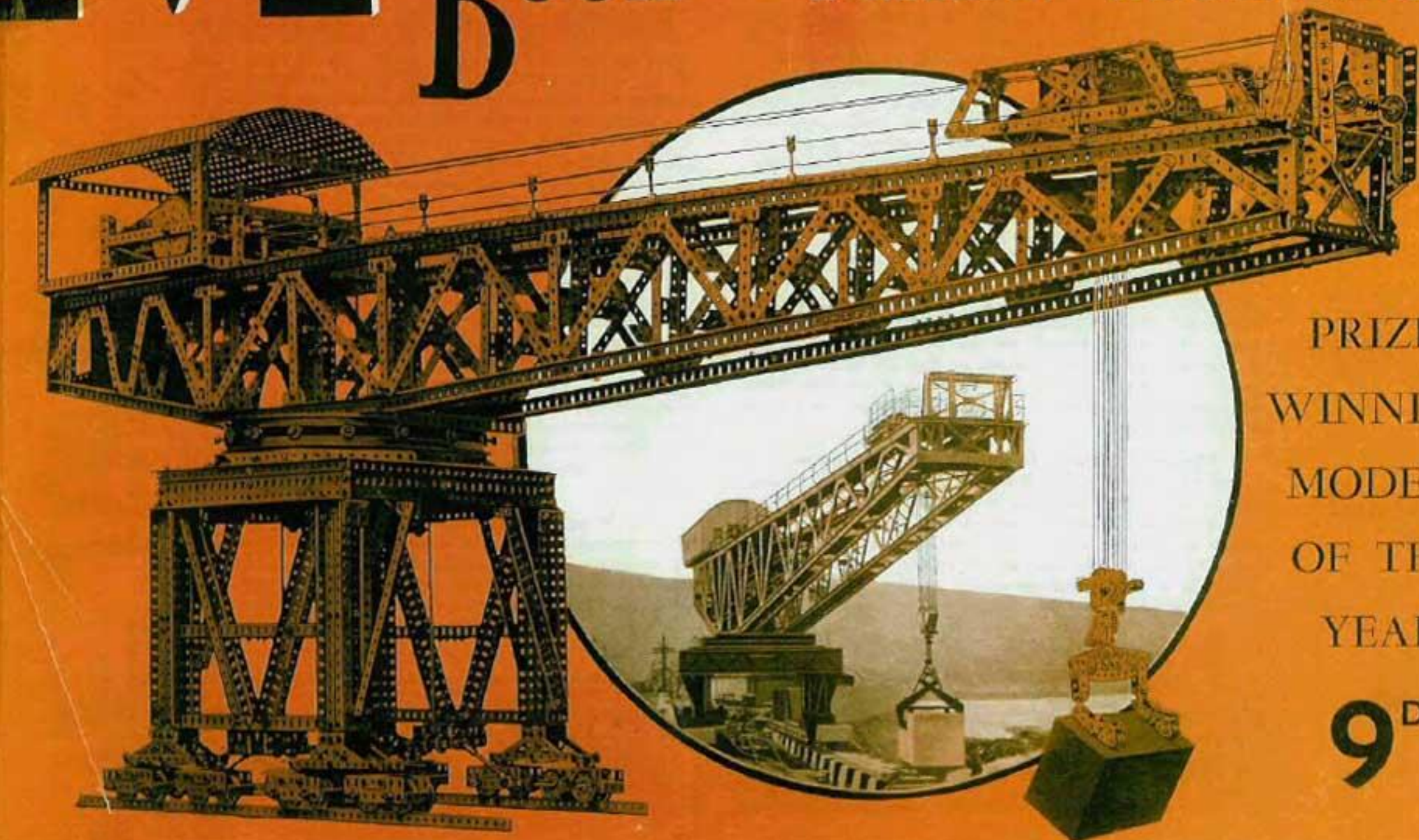

PRIZE-
WINNING
MODELS
OF THE
YEAR

9^D



GIANT FARMING, BORING AND CROSSING LATHE



ELECTRIC TRAIN



SUBMARINE



HIGH PRESSURE TURBINE

The Joy of Inventing

This book has been published with the main object of showing the endless possibilities of Meccano and the skill and originality of expert Meccano model-builders in all parts of the world. It contains illustrations and descriptions of models that won prizes in the recent International Model-building Contest, and a selection of prize-winning models in the competitions that are announced month by month in the "Meccano Magazine," and are open to all readers.

These models cover an enormous range of subjects, and they show clearly that Meccano is capable of reproducing practically every mechanical device that is used in actual engineering practice. Some of them are large and elaborate, involving the use of a great number of parts; others are simple in construction, and make use only of parts that are contained in the smaller Outfits. The important point to be noticed is that all these models, large or small, have won prizes, which shows that every Meccano boy, whatever the size of his Outfit, has a good chance of success.

Meccano is engineering in miniature. All the parts of which the system is composed are real engineering parts, and in making use of them to build models a boy learns how their prototypes are used to form the world's great engineering structures. A boy who contents himself with building the models that are illustrated in the Meccano Manuals of Instruction inevitably gains a sound general knowledge of engineering design and principles, but few

boys stop there. From the time when a boy first commences to use Meccano, he has before him a constant encouragement to make slight changes in the construction of the various models. Thus he is led on almost imperceptibly to build models from his own ideas, and then he has become in the true sense of the word an inventor. There is nothing in the world to be compared with the joy and satisfaction of creating something new, and inventing new models and movements in Meccano is the most fascinating of all pastimes.

Before the invention of Meccano, boys who wished to understand how the world's giant engines and machines work had to be content with book descriptions, and hours of study were spent with comparatively little result. Meccano has brought about a revolution in this respect. By means of it a boy can build models of an almost endless variety of engines and machines, and these models actually work on the same principles as the originals. The result is that, instead of a vague and often inaccurate idea of the most important mechanisms, the Meccano boy has a real and definite knowledge of how these work. By building models of intricate mechanisms he discovers their secrets for himself.

It is hoped that this book will encourage boys who have never entered a Meccano model-building competition to do so at the earliest opportunity; and also that it will stimulate those who have already won small prizes to persevere until they attain the higher honours.



THE FIRST PASSENGER LOCOMOTIVE



THE FIRST STEAMSHIP



CUGNOD'S ROAD VEHICLE

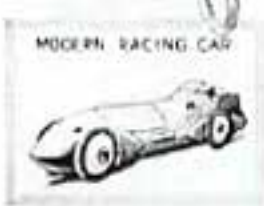

MODERN RACING CAR



ENGINE OF EARLY STEAMSHIP

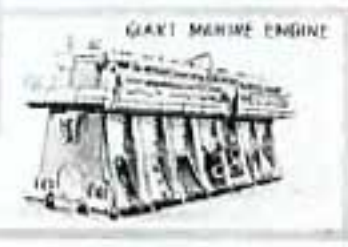

GIANT MARINE ENGINE



EARLY TRIP HAMMER

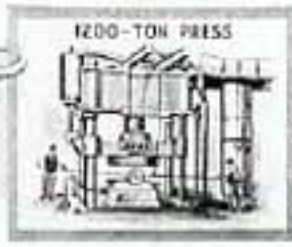

1200-TON PRESS

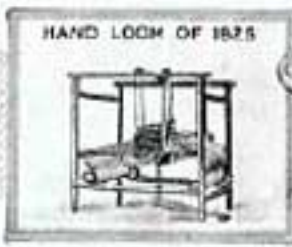

HAND LOOM OF 1825

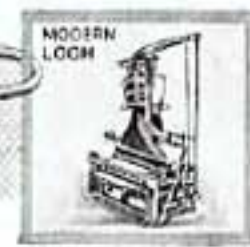

MODERN LOOM



H.M.S. NELSON



WRIGHT'S GLIDER



BIPLANE



DIRIGIBLE



DIRIGIBLE



EASTMAN

Model No. 1. Marine Type Diesel Engine. (J. H. Wilkins, London).

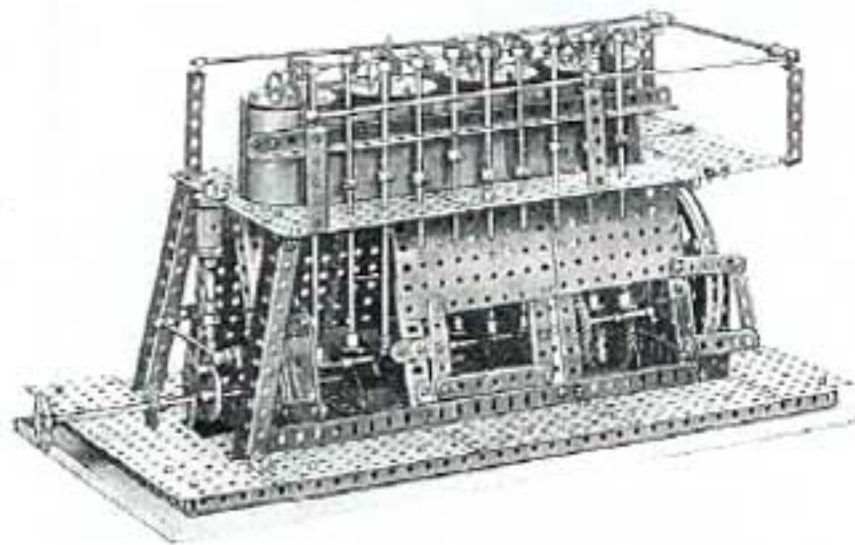

The camshaft that operates the valves is driven from the crankshaft by means of 4:1 ratio Sprocket Gearing. The valve tappets are made with Cranks and operate 8" Rods forming the push-rods. These are passed through a guide formed by an Angle Girder secured to the side of the cylinder block, through the Flat Plates of the upper platform, and then through the Plates covering the side of the crankcase. Compression springs placed on the Rods below the Angle Girder and retained in place by Collars

return the valves to the closed position, the extent of the movement of the valves being adjustable according to the positions of the Collars on the Rods.

Small inspection windows are provided in the crankcase so that the camshaft can be inspected while in operation, the windows being filled in with transparent celluloid sheet. Dummy valves are fitted to the cylinder heads, which are represented by Face Plates.

To operate the model an Electric Motor is coupled to a Sprocket on the crankshaft of the engine. Gearing is interposed between the Motor and the model in order to reduce the speed of the drive.

Model No. 2. Sports Motor Cycle. (Kenneth Brookes, Leek, Staffs.).

The front fork is supported by a 1 1/4" Strip and a Flat Bracket on a 2" Rod that is free to slide in the head of the tank, the amount of movement being limited to 1" by means of four Washers. A Collar and a Compression Spring on the same 2" Rod form a neat and efficient shock absorber.

The exhaust pipes are represented by thick canvas-covered aerial wire. The cylinder consists of three 1" loose Pulleys, two 1/2" Pulleys, and a Collar held on a 2" Screwed Rod. The lower end of the Rod is



threaded into another Collar loosely held in the middle of the driving shaft so that the cylinder is held quite firmly and the driving shaft is free to revolve without strain.

When the model is pushed along the ground the driving shaft with its flywheel and driving pulleys (1" and 1/2" Fixed Pulleys respectively) revolves, being driven by a cord from a secondary shaft. A dummy gear lever is fitted on the tank.

Model No. 3. Safe, with Combination Lock. (R. Shepherd, Weymouth).

The model represents a type of small wall safe often seen in large private houses. The door is constructed from two 4 1/2" x 2 1/2" Flat Plates and on one side is fitted with three Hinges. The locking mechanism is operated by two handles, one of which is a Coupling fitted with a Threaded Pin, and the other a 1" Gear Wheel fitted with a 1" Bolt. In order to make description clear the handle represented by the 1" Gear will be termed "A" and the other handle "B."

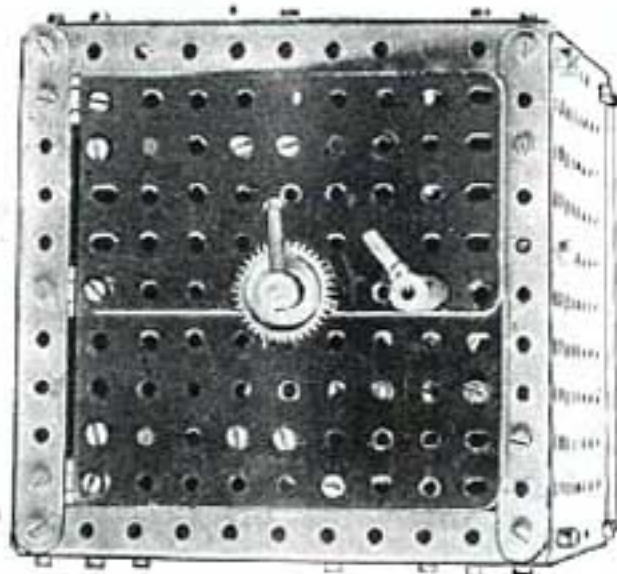

Each bolt of the door is composed of a Strip Coupling secured to a 2 1/2" Rod journalled in two 1" x 1" Angle Brackets spaced 1" apart. The Rod is fitted with a Coupling placed between two Collars and two Angle Brackets, and five Washers are placed between the Strip Coupling and its nearest 1" x 1" Angle Bracket. The end of the Rod nearest the Hinges of the door is fitted with a 3/4" Contrate Wheel that engages a 1/2" diam., 1/4" face Pinion on a 1" Axle Rod journalled at one end in a hole in the door, and at the other end in the end hole of a 1/2" Reversed Angle Bracket. When the 1/2" Pinion is rotated the Strip Coupling is also turned and a 1/2" Bolt in its centre threaded hole indicates the position of its slot. The Couplings on

the two door bolts are connected by a 3" Rod, and a Collar on this supports one end of a 2" Strip. The other end of the Strip is carried on a Threaded Pin attached to one end of a Double Arm Crank and this is connected to the handle "B" by a 1 1/2" Rod. A length of elastic attached to the 3" Rod keeps the two 1/2" Contrates normally out of gear with their respective 1/2" Pinions; a turn of the handle "B" brings the Gears into mesh.

Handle "A" is mounted on a 1 1/2" Rod, one end of which carries a fixed 57-teeth Gear and a loose 2" Strip to which is attached a second 57-teeth Gear. This completes the mechanism of the lock.

To operate the lock handle "B" is turned to the left, after which handle "A" is turned first to the right and then slightly to the left. This action raises or lowers the 2" Strip on the inside of the safe, and when the 57-teeth Gear engages with either of the 1/2" Pinions the Strip stops moving and the Gears commence to turn their respective Strip Couplings.

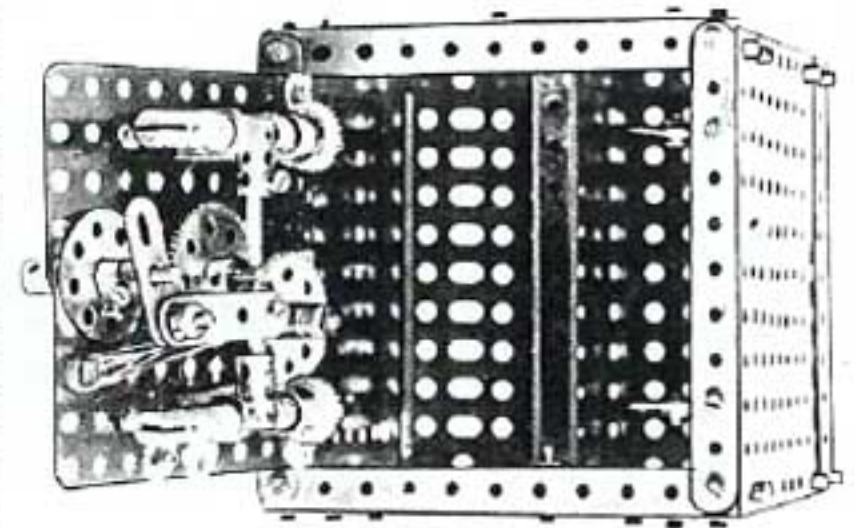

Models Nos. 8 & 9. The Oxford and Cambridge Boat Race. (P. B. le Claire, Worksop).

A popular event of the year is the rowing-boat race on the River Thames, between the Universities of Oxford and Cambridge. This unique race makes use of a very carefully streamlined type of boat propelled by a crew of eight oarsmen. The top illustration on this page shows two Meccano models of these boats and their crews, and by carefully arranging the attitudes of the rowers it has been possible to give an excellent impression of the finish of the race. Very few parts are used in building the models, and they may be constructed in a few minutes. Each boat consists of 12½" and 7½" Strips bolted end to end to form the sides, and these taper together at the ends where they are joined by 1" Bolts. The bodies of the oarsmen are represented by 2½" and 1½" Strips and 2½" large radius Curved Strips, their heads being formed from 1" Fast Pulleys secured to the bodies by means of Flat Brackets. Short Rods are used for the oars.

Model No. 10. 4-4-4 Locomotive. (D. Jepson, Manchester).

This model is designed specially for young constructors; few parts are needed, and it is easy to build. The frame of the model consists of two 5½" x 2½"

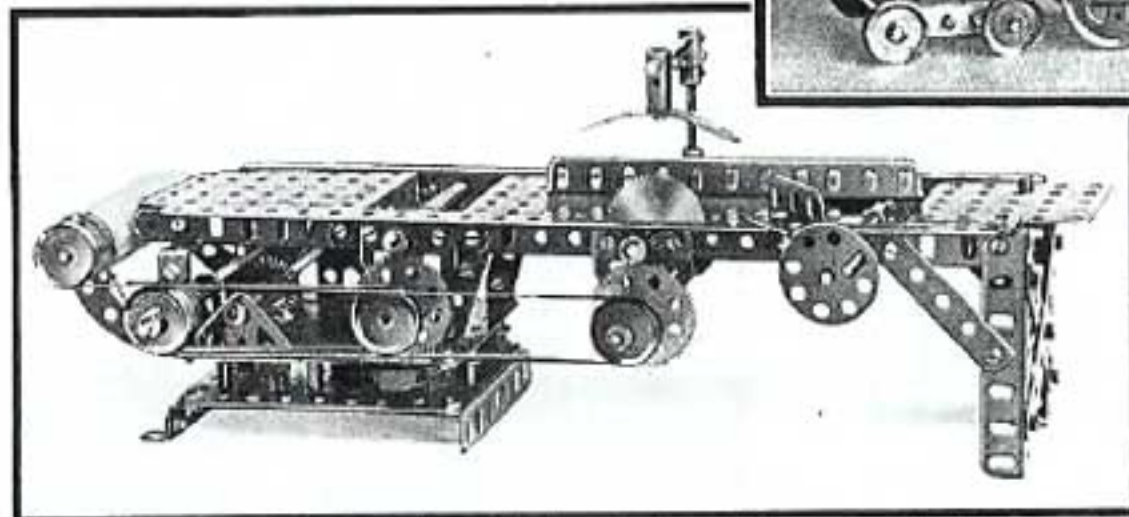

Flanged Plates connected together with long Strips. The fire-box is built up from three 3½" x 2½" Flanged Plates, and a Boiler with a Chimney Adaptor mounted on it represents the locomotive boiler. The coal bunker is made up from 2½" Double Angle Strips and 2½" Strips, and the front and rear of the cab consists of 2½" x 2½" Flat Plates. The roof of the cab is built up from a number of 2½" Strips. The main driving wheels are secured on Rods journalled in Double Angle Strips bolted to the underside of the main frame, and they are coupled together by connecting rods. Each bogie is constructed from 2½" Strips and 2½" x 1" Double Angle Strips. The driving wheels are coupled by means of two 2½" Strips overlapped and bolted together; these Strips must be joined very securely, otherwise they will work loose. Each end of the compound connecting link so formed is pivotally attached by a Bolt to the driving wheels and the same procedure is followed on both sides of the engine.

Model No. 11. Planing Machine. (R. J. Mason, Newcastle, Staffs.).

Nowadays single machines are being made to do work that a few years ago would have required two or even three separate machines. This improvement effects a great saving in production costs, so that goods can be manufactured more cheaply. The model described here represents a type of compound machine that is used in large woodworking factories. It incorporates three separate machines, circular saw, planing machine and wood-polishing roller. The model is operated

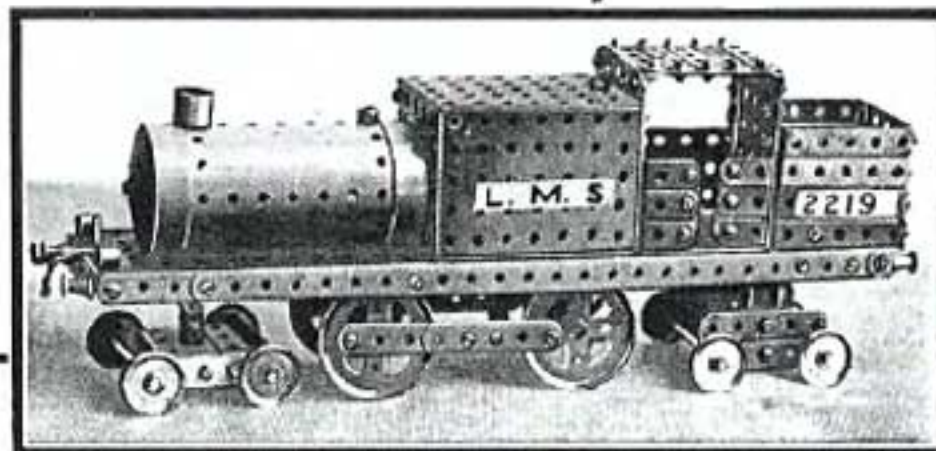

(Top) The "Oxford and Cambridge Boat Race."
(Centre) A neat 4-4-4 locomotive.
(Left) A three-purpose wood-working machine that incorporates a circular saw, planer, and polishing roller.
(Foot) A fine model punching press.

by a Meccano Clockwork Motor through gears and belt drive. A Meccano Circular Saw is mounted on a Rod journalled in the flanges of the Angle Girders that form the sides of the table. The end of the Rod carries a ½" Pinion that engages a 57-teeth Gear Wheel on a Rod journalled in Flat Trunnions that are bolted to the table in the positions shown. This Rod carries a 1" Pulley round which passes a belt of Meccano Cord that also passes round a second similar Pulley on the shaft driven by the Clockwork Motor. On this shaft are two other 1" Fast Pulleys, and a Meccano Cord belt round one of these rotates the polishing roller, which consists of a Meccano Wood Roller covered with a strip of sand or glass paper. The Roller is supported on a Rod journalled at each end in the end holes of 2½" large radius Curved Strips attached to the frame at each side of the machine. The remaining 1" Fast Pulley on the Motor-driven shaft is connected to the rotary plane by a belt of cord. The arrangement of the various belt drives is shown clearly in the illustration. The Clockwork Motor is placed horizontally, and a ½" Bevel on the driving shaft engages a similar gear on a Rod journalled in Trunnions that are bolted to the upper plate of the Motor.

Model No. 12. Roller Feed Press. (D. Hirst, Wakefield).

(D. Hirst, Wakefield).

The punching die is operated from a built-up crankshaft, formed from two short Axle Rods to each of which is secured a Coupling. These are rigidly secured together by a Screwed Rod that forms the crank pin, and carries a further Coupling serving as the big end for the connecting rod that operates the die, which is a short Rod held in a Coupling. The crank-

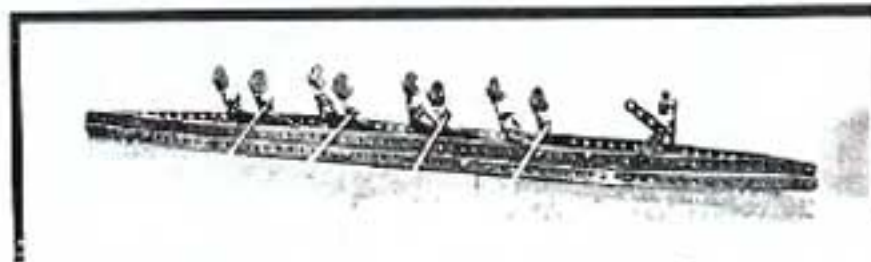

shaft is driven by a 3½" Gear engaging a ½" Pinion on the Rod carrying the flywheel. Normally, as this Rod rotates the Pinion is held out of engagement with the Gear by a Compression Spring, but by depressing a foot-pedal provided, the Pinion slides into mesh and causes the punching die to operate. The Pinion remains in engagement with the Gear only so long as the foot-pedal is depressed, so that the press is under perfect control at any point of the stroke.

The drive is taken from the crankshaft to the feed mechanism by Bevels and spur gearing, the final stage being led through Sprockets and Chain to a drum formed from two 1½" Flanged Wheels butted together. A strip of paper representing the metal to be punched passes over the drum and is gripped by a 1" Pinion mounted on a short Rod carried in the end transverse bore of a Coupling. A Spring keeps the Pinion continually pressing on the paper.

The accuracy with which the model operates depends to a large extent on the rigidity of its construction, and on the accurate fit of the sliding ram holding the stamping die.

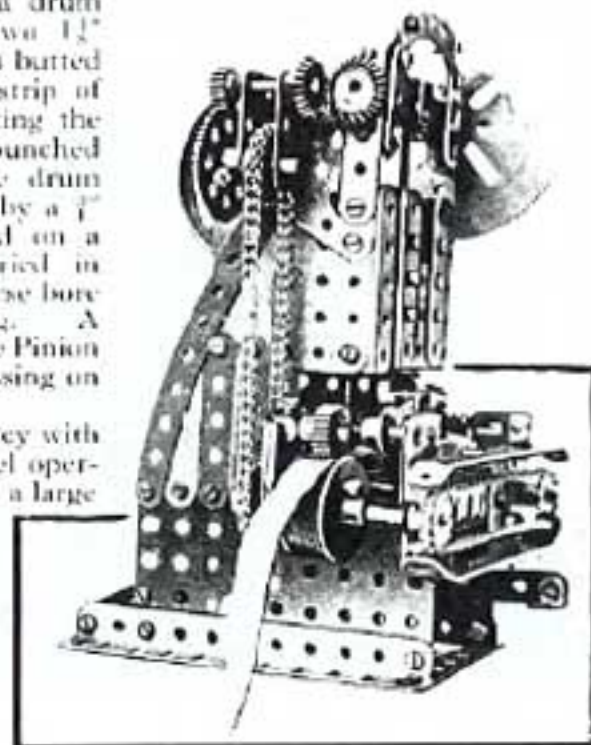

Model No. 13. Cable Armouring Machine.

(Miss W. Fairfield, Bowden).

This model represents a type of machine that is used for armouring electrical cables with a steel wire covering, and for stranding wire ropes. The model can be put to practical use for covering copper wire with an insulating layer of cotton strands.

It consists essentially of a revolving cage in which a number of bobbins of wire, or reels of cotton, are held on Rods. The bobbins are free to rotate on their respective Rods. The cable to be armouring is taken from a drum at one end of the machine and is passed through the interior of the cage and then through a guide, after which it is led over pulleys to a winding-in drum. The wire or cotton to be used for covering the cable is wound on the bobbins in the cage, and the free end of wire from each bobbin is passed through the boss of a Crank secured in the position shown. The cable is passed through the centre of the cage, then through the boss of the Crank, and is attached to the winding-in drum. The free ends of the wire from the bobbins are now given a few turns round the cable. When the cage is set in motion the bobbin wire is twisted around the cable. A Worm on an extension of the Crank Handle shown engages a 57-teeth Gear on the shaft of the guide pulleys and provides an effective take-up for the finished cable. The winding-in drum is driven by a belt that passes round a Pulley on the shaft of the 57-teeth Gear and another Pulley on the shaft of the winding-in drum.

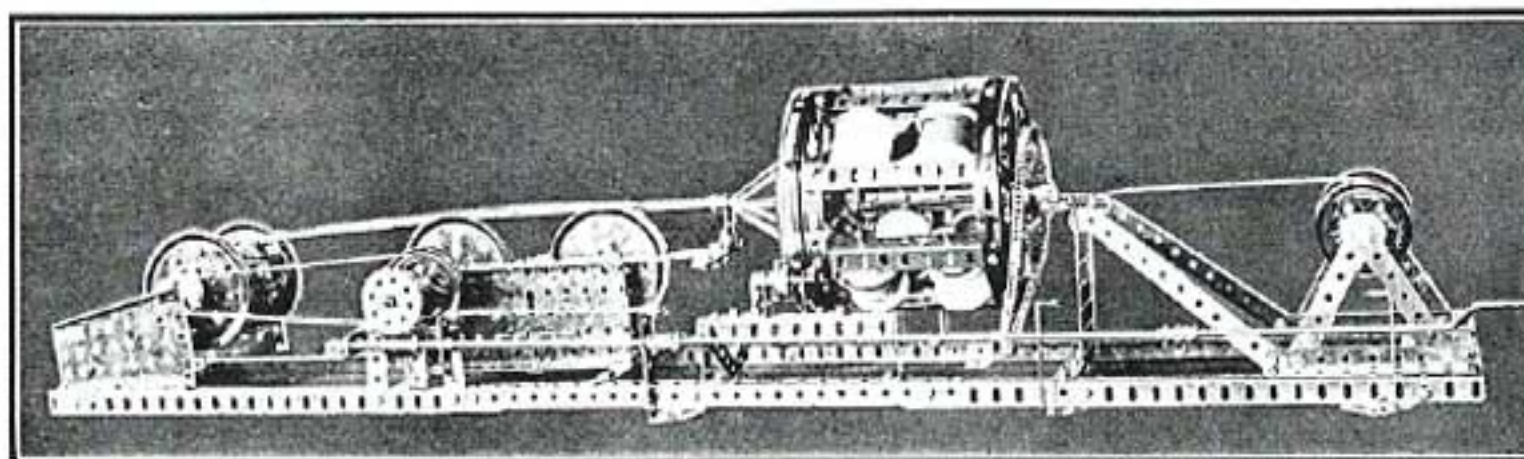

The revolving cage is built up from one Hub Disc and two Circular Girders. The Circular Girders are bolted together as shown in the illustration, and are secured to the Hub Disc by means of eight $4\frac{1}{2}$ " Angle Girders. The complete cage revolves on and is supported by four small Flanged Wheels that are loosely carried on $1\frac{1}{2}$ " Rods secured to the base of the model by $1" \times 1"$ Angle Brackets. The drive to the cage is conveyed through Sprocket Chain.

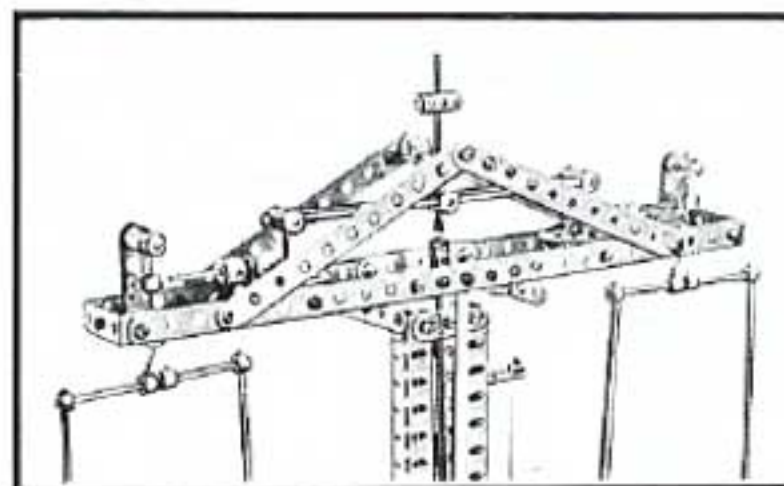

Model No. 14. Railway Signal Cabin.

(E. Salmon, Retford).

This model forms a useful accessory for use with a Hornby model railway layout. The four corner posts are built up from Strips, but $9\frac{1}{2}$ " Angle Girders are more suitable if these are available. The long sides of the base are $12\frac{1}{2}$ " Angle Girders, one at the front and one at the rear. The walls are made with Strips of various lengths, and similar parts bolted to a framework of Angle Girders are used for the roof. The gable ends are filled in with Strips and Flat Girders. A doorway is left at one end of the cabin and outside this is a platform that is made from $3\frac{1}{2}"$ and $1\frac{1}{2}"$ Flat Girders, and is secured in position by Angle Brackets. The platform is reached by a stairway made of $7\frac{1}{2}"$ Flat Girders with $1\frac{1}{2}" \times \frac{1}{2}"$ Double Angle Strips bolted between them for the steps.

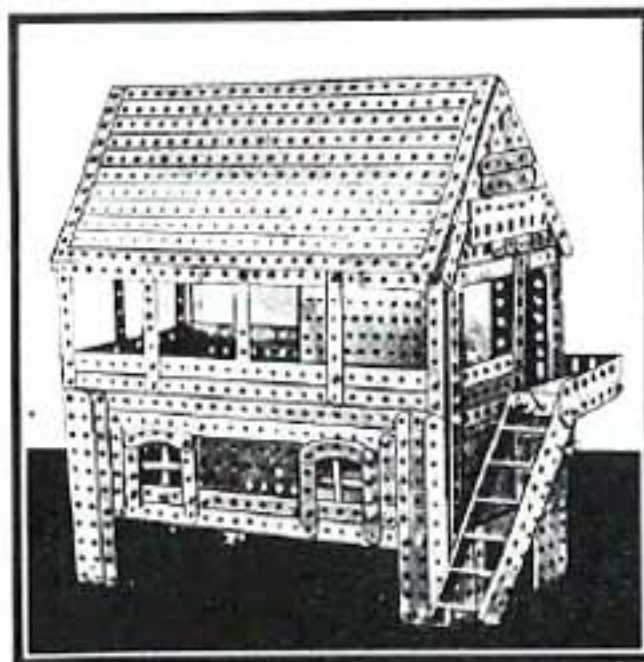

Model No. 15. Laboratory Balance.

(S. F. Desai, Bombay).

The fulcrum consists of a Centre Fork held in the centre transverse bore of a Coupling secured to the centre of a $6\frac{1}{2}"$ Rod. The Centre Fork pivots on a second Coupling on the upper end of a long Rod, which passes through the column of the model and is used to bring the Coupling into contact with the Fork Piece when the balance is in use. The long Rod that carries the Coupling

on which the Centre Fork pivots is pushed upward by turning the Bush Wheel shown in the centre of the base of the model. The Bush Wheel is secured to a Rod, at the inner end of which is a Collar with a Bolt projecting from its tapped bore. By turning the Bush Wheel the head of the Bolt is brought into contact with the end of the long Rod and so forces it upward.

The Rod carrying the Centre Fork is attached to the balance beam by two short vertical Rods, the lower ends of which are held in Bush Wheels attached to the beam. Adjusting devices are provided on each arm of the balance and these take the form of Threaded Bosses working on Screwed Rods, which are supported in Angle Brackets attached to $1"$ Rods held at right angles to the $6\frac{1}{2}"$ Rod. By screwing the Threaded Bosses either towards or away from the Centre Fork the balance may be adjusted with sufficient accuracy to weigh very light objects.

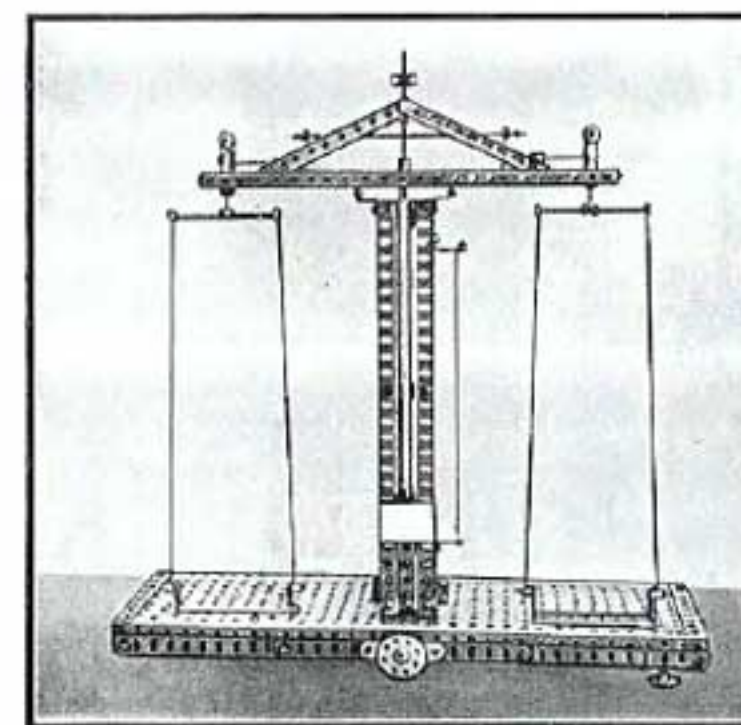

Model No. 16. Microscope. (R. Banks, Newton).

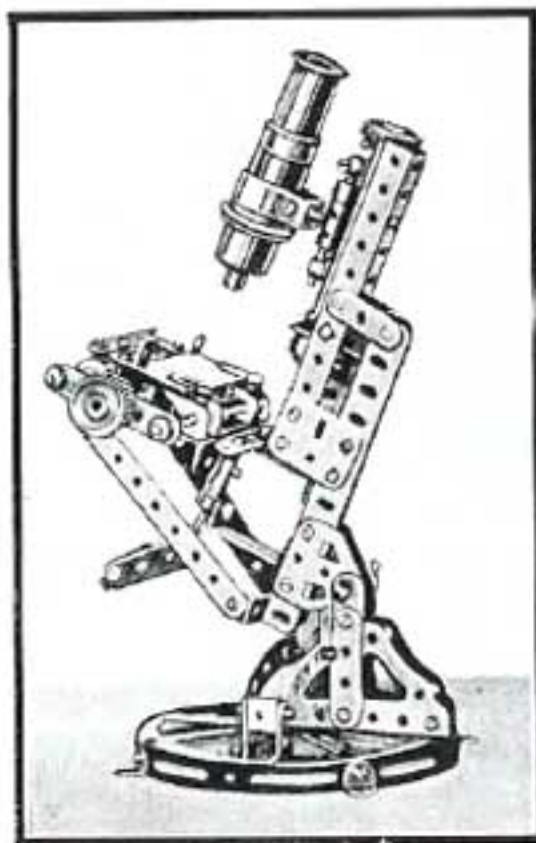

This model microscope will appeal to model-builders who are interested in scientific instruments, for when fitted with lenses it will fulfil all the requirements of the amateur scientist. Suitable lenses may be obtained from the eyepiece of a telescope, or failing this may be purchased from any dealer in optical accessories.

The chief feature of the model is a mechanical stage, which is in two parts, one being fixed and the other movable. The fixed portion consists of a 2½" Angle Girder to which a Flat Trunnion is attached, the Trunnion in turn being bolted to the main frame. Two 2½" × ½" Double Angle Strips are attached at right-angles to the 2½" Angle Girder, and a third 2½" × ½" Double Angle Strip is then bolted across their flanges. A 4½" Strip is bolted at each end of the front 2½" × ½" Double Angle Strip, and the ends of the 4½" Strips are attached to a 1½" × ½" Double Angle Strip joined to the bottom of the 5½" Angle Girders of the body.

The movable stage consists of 2½" Strips bolted together in the form of a square. In the centre holes of two opposite Strips a Bolt is lock-nutted, and then is screwed into a Collar on a Rod that slides in Double Brackets. A 2½" Double Angle Strip with a Threaded Boss in its centre hole bridges the ends of the Rod. A Screwed Rod is threaded into the boss and then through the Strip of the frame.

Tubes to hold the lenses can be easily made from cardboard, or brown paper wrapped several times round a wooden rod of suitable diameter.

Model No. 18. Vertical Boiler.

(Duncan Young, West Croydon).

Small vertical boilers such as that featured in this model are utilised for a variety of purposes, ranging from heating factories and blocks of office buildings to supplying steam at low pressure for portable dock-side cranes. The special advantages of this type of boiler are its simplicity and low maintenance cost.

The boiler of the Meccano model is built up from a number of Strips bolted to a framework of three hoops, each of which is composed of 12½" Strips. One portion of the barrel, for a distance of 10", is left open. A small square door for inspecting and cleaning the boiler tubes is formed on one side of the main opening, and when the boiler is under steam it is covered by two easily detachable 3" Flat Girders. The upper part of the larger opening is built out into the form of a smoke-box, into the back of which the ends of the fire tubes are fitted. An opening is also left in the front of the smoke-box and is covered with two doors made of mica inserted in frameworks constructed from Flat Brackets and 2½" Strips. The lower half of the opening is shaped into a fire-box, over which a slidable door is fitted. The bottom of the boiler is fitted with a number of fire tubes made from 5" Rods.

The chimney is constructed from two Boilers slightly compressed in diameter. They are connected end to end by means of a number of ½" × ½" Angle Brackets, and the entire chimney is secured to the top of the smoke-box by means of two 1" × ½" Angle Brackets. A Meccano Dunlop Tyre is used to fill the gap between the lower end of the chimney and the top of the smoke-box.

The boiler fittings include a weight-and-lever safety valve, a pressure gauge, two water gauges and a feed water injector.

The safety valve consists of a 2" Strip lock-nutted to a 1" × ½" Angle Bracket bolted to the top of the boiler. The Strip is notched along its upper edge and a wire loop carrying a 1" Loose Pulley rests in one of the notches. The blowing-off point of the boiler is determined by the position of the loop.

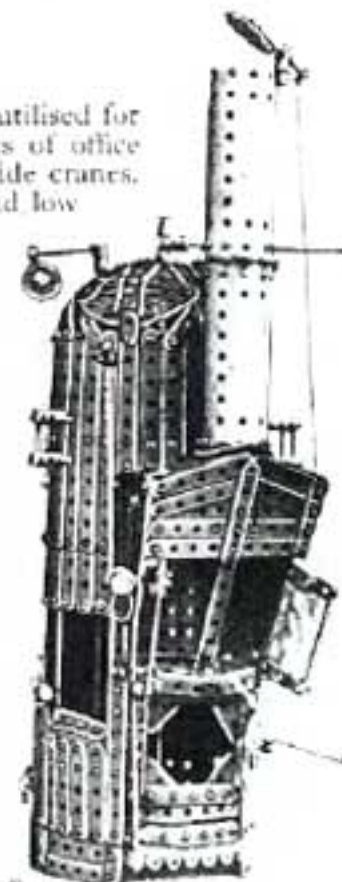

Model No. 17. Catapult for Launching Seaplanes.

(J. Wauquier, Houilles, France).

One of the most recent aircraft developments is the introduction of a transatlantic mail service, by means of which mails can be delivered more than 24 hours earlier than by the fastest mail steamers. The mail plane is carried on hoard ship until it is within one day's steaming of land. Then all the important letters and parcels are loaded into the aeroplane, which is released from its parent ship and proceeds at full speed towards land. The aerial portion of its journey of course presents no difficulties, but the take-off from the ship is liable to end in disaster unless a very sure means of taking-off is provided. The apparatus used for the purpose consists of a powerful catapult mounted on a large turntable.

The catapult consists of a long boom on the top of which a skid moves. This

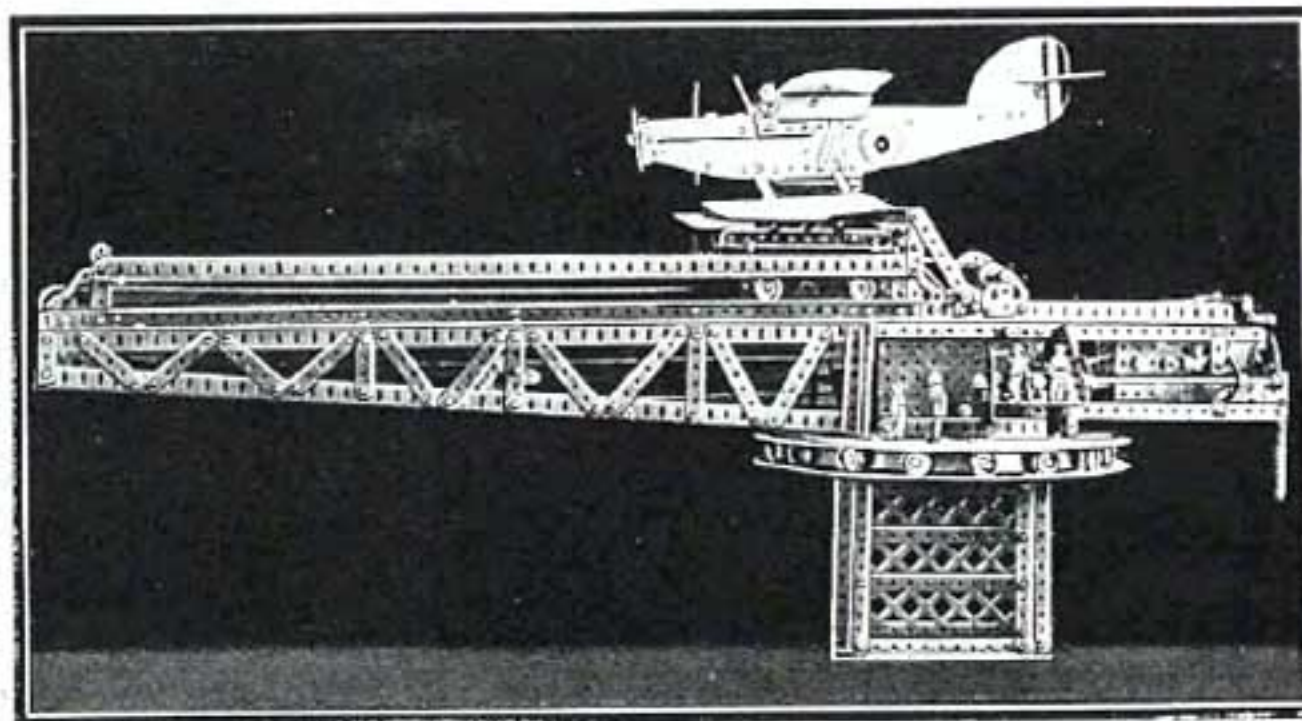

skid carries the seaplane to be launched, and it is actuated by a powerful compressed air piston and toggle link mechanism.

In the Meccano model described here the fixed base is a 5½" cube built up from 5½" Angle Girders and Braced Girders. It is surmounted by a Roller Race, and the upper Flanged Disc of this part supports the boom, which is 37" long fitted at the rear with a Meccano 6-volt Electric Motor taking the place of the compressed air ram used in the real apparatus.

The skid is a framework built up from Angle Girders and mounted on 7" Flanged Wheels that run on the top girders of the boom. It is driven forward by a length of Sprocket Chain operated by the Electric Motor, and is prevented from leaving the rails by overhead guides consisting of 24½" Angle Girders.

The aeroplane is beautifully constructed from the new Meccano Aeroplane parts, and model-builders who possess one of the new Outfits will be able to make good use of it in conjunction with this model.

Model No. 19. Detached Bungalow. (R. Kirkham, Sandbach).

The model bungalow shown here demonstrates the possibilities of Meccano in the reproduction of architectural subjects. As a structure it is simple and

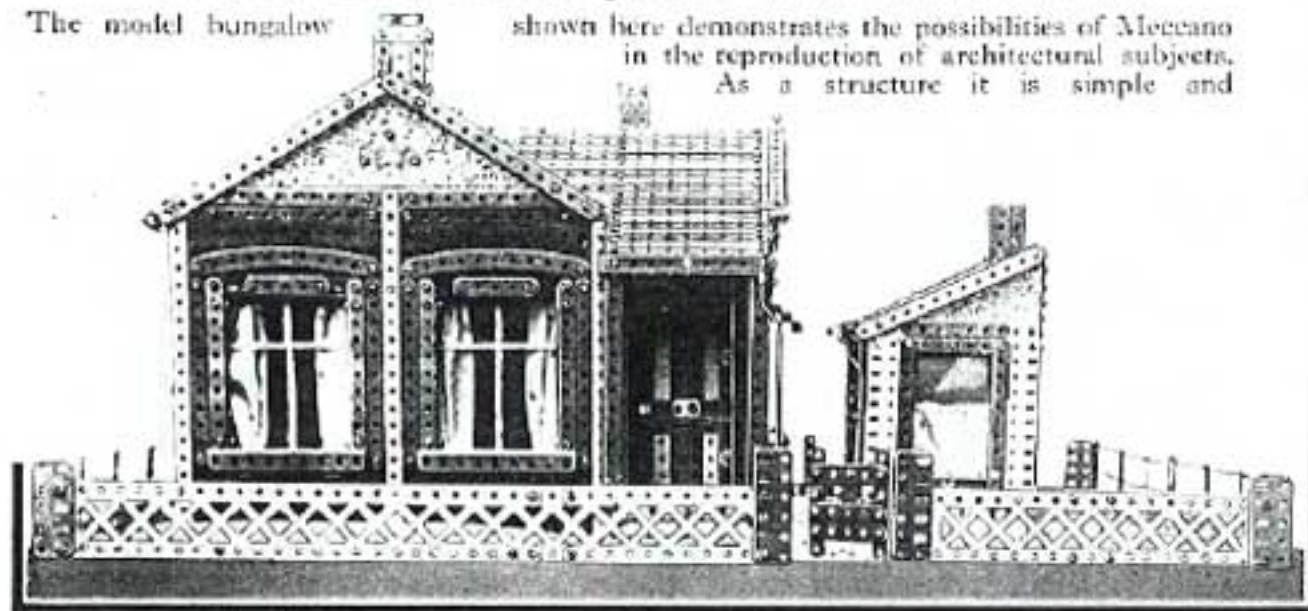

A Meccano bungalow constructed by Reginald Kirkham of Sandbach

unpretentious, but it immediately catches the eye on account of its truth to the type of house it represents.

The bungalow contains two bedrooms, bathroom, pantry, scullery, dining room, hall and entrance porch. The garden, which is of proportionate size, contains the usual outhouses, which add greatly to the effectiveness of the whole. The front garden fence is made of Braced Girders, and two 3" Flat Girders are used for gate posts, between which is a small gate built up from two vertical 3" Strips with horizontal 2½" Strips between them. At each corner of the garden is a 2½" Flat Girder fixed in the upright position, and the fences at each side are made by tying Cord between posts placed at regular intervals.

It should be noticed that the gable ends are pebble-dashed in modern fashion. One of the most striking features of the model is the clever use that is made of Crank Handles to represent the gutter down-cornor pipes, the gutters themselves consisting of Angle Girders of various lengths, placed as shown in the photograph. Flat Girders capped by Chimney Adaptors form solid-looking chimney stacks, and good use has been made of Buffers to provide knobs for the doors. The walls of the bungalow are constructed from Strips of various lengths, and Flat Plates and Strips bolted together are used for filling in the roof. The best feature of all, however, is the fine proportioning of the model. Each section appears to be of just the proper size to correspond with the adjoining sections, even such minor details as window sills and door space having been carefully considered in this respect.

Model No. 20. Motor Lawn Mower. (V. Kateley, Dorking, Surrey).

(V. Kateley, Dorking, Surrey).

The frame of the model is built up from 5½" x 2½" Flanged Plates and four 12½" Angle Girders. Cross members connecting the two sides of the frame consist of six 12½" Angle Girders and two 12½" Strips. The front of the frame is fitted with two 24½" channel section girders set at an angle of about 40° to the ground, and between them is carried the collecting pan for the cut grass. The pan is represented by a framework of Strips covered with cardboard.

The rear of the mower frame is fitted with handles constructed from two 24½" Angle Girders braced together by 12½" Strips, and the levers for manipulating the machine consist of two 5½" Curved Strips. The main

frame carries two box-like projections both constructed from 5½" x 3½" Flanged Plates. The projection shown in the front of the accompanying illustration houses a gear-box that transmits the engine drive to the cutters and roller, and it also contains a 6-volt Electric Motor controlled by a lever on the handles. The blades of the cutter consist of 9½" Strips mounted on 3½" x ½" Double Angle Strips, and the complete unit is driven from the gear-box by a ratio 3:1 Sprocket Chain drive. The dummy engine cylinder, which is mounted on the other box-like projection on the main frame, consists of two Boilers. They are bolted together, and the cooling fins, which consist of built-up rings of 2½" small radius Curved Strips, are

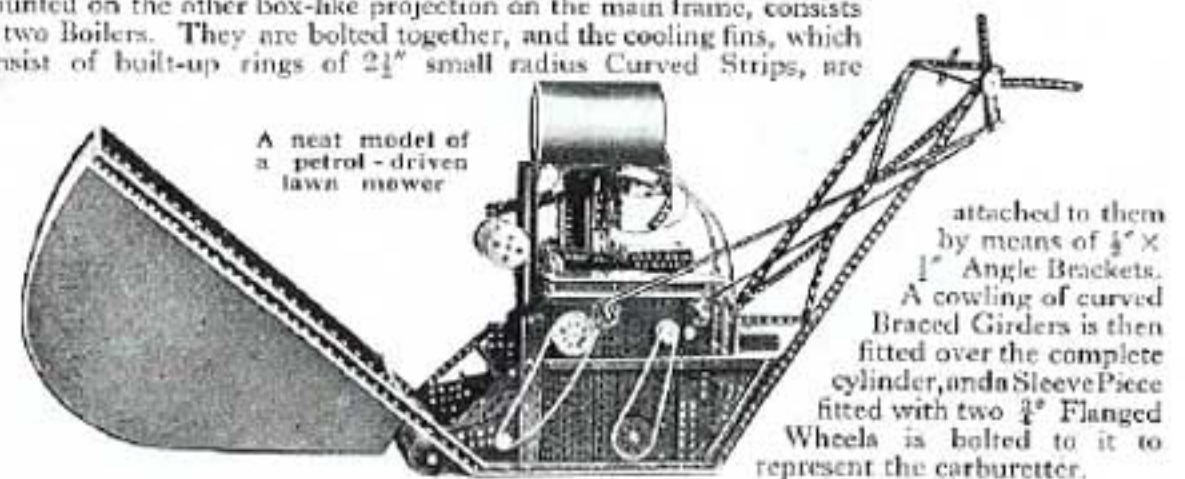

A neat model of a petrol-driven lawn mower

attached to them by means of ½" x 1" Angle Brackets. A cowl of curved Braced Girders is then fitted over the complete cylinder, and a Sleeve Piece fitted with two ½" Flanged Wheels is bolted to it to represent the carburetter.

Model No. 21. Breakdown Crane. (C. L. Vickers, Gainsborough).

Each side member of the frame of Angle Girders secured together bottom girders of each side Girders at their rear ends, and rear travelling wheel axles, springs, and the travelling Wheels. A front bogie is up from four 4½" Angle Corner Brackets; and in the side bogie is a 1½" Rod truck by

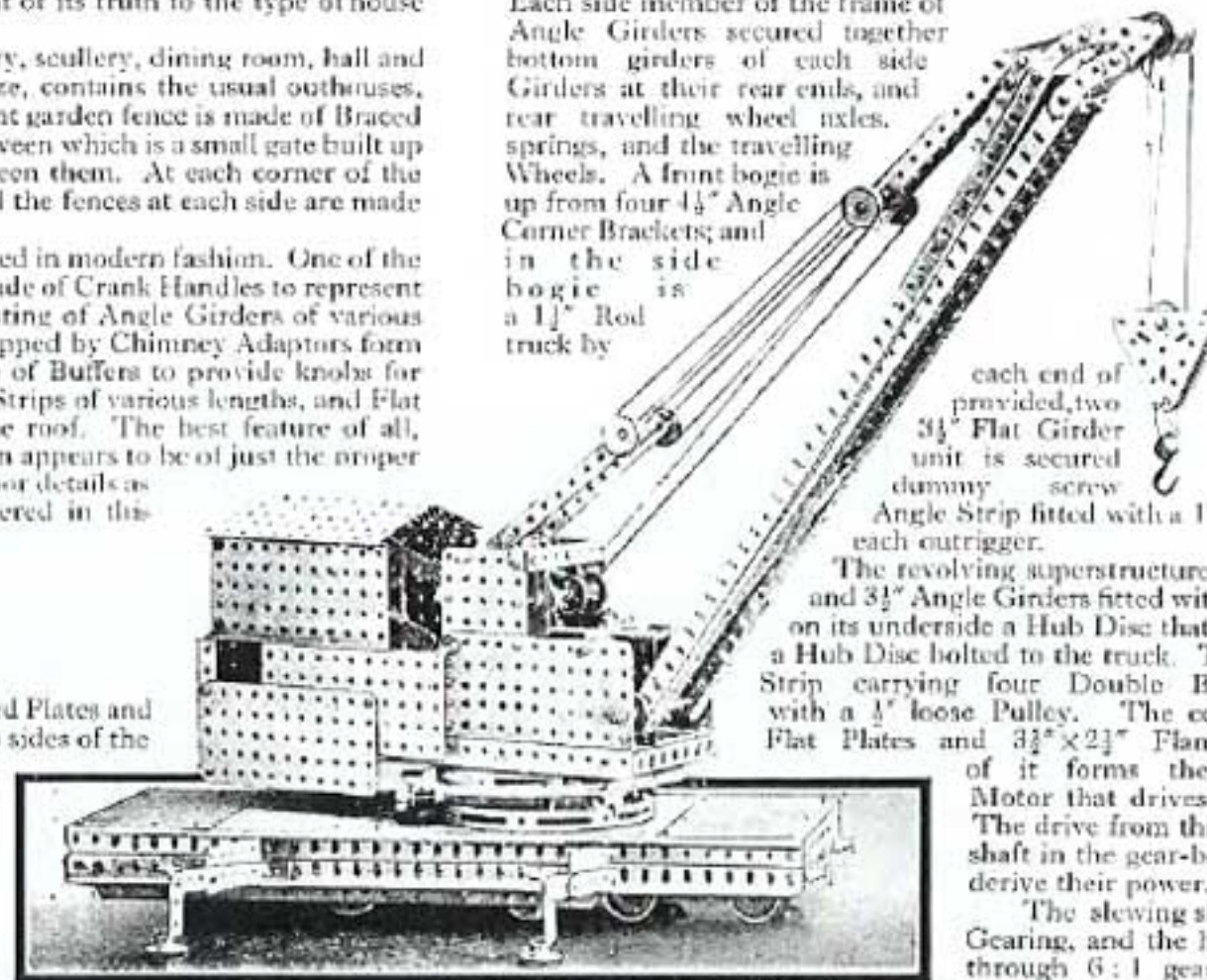

each end of provided, two 3½" Flat Girder unit is secured dummy screw Angle Strip fitted with a 1" Fast Pulley, is attached to the end of each outrigger.

The revolving superstructure is built up from 12½" Angle Girders and 3½" Angle Girders fitted with 3½" Flat Girders. This frame carries on its underside a Hub Disc that revolves on a roller frame turning on a Hub Disc bolted to the truck. The roller frame consists of a Circular Strip carrying four Double Brackets, each of which is fitted with a ½" loose Pulley. The control cabin is built up from 5½" x 2½" Flat Plates and 3½" x 2½" Flanged Plates, and the rear portion of it forms the cover for a No. 1a Clockwork Motor that drives the three movements of the model. The drive from this is taken by Sprocket Chain to a lay-shaft in the gear-box and from this the secondary shafts derive their power.

The slewing shaft is driven through ratio 3:1 Bevel Gearing, and the hoisting and luffing drums are driven through 6:1 gearing. These two drums are each built up from a Sleeve Piece clamped between two ½" Flanged Wheels.

C. L. Vickers won a prize with this neatly-built railway breakdown crane

Model No. 22. Dough Mixer for Bakery.
(R. Morris, Stratford-on-Avon).

In the model dough mixer shown here the pivoted arm moves slowly downward and then, with a quick action across the dough pan, moves upward. At the same time the pan slowly revolves. The arm is driven by a Clockwork Motor and is coupled by belt drive to the Circular Girders forming the flywheels. One of these is free to revolve idly, but the other is fixed to the shaft so that by sliding the belt from one Girder to the other the machine can be started or stopped without interfering with the Motor.

The Circular Girders are attached by $2\frac{1}{2}$ " Strips to Bush Wheels on the Rod of which is a 3 " Pinion in mesh with a 3 " gear wheel built up by bolting four Rack Segments to a Face Plate. A Crank bolted to the Face Plate so that its boss is near the rim forms a bearing for a Rod carrying an Eye Piece. A Strip passed through the Eye Piece is pivoted inside the body of the machine and provides the quick-return motion for the arm, which is fixed to the same Rod as the Eye Piece.

The front of the machine is formed by a Face Plate that is free to revolve between circles of $2\frac{1}{2}$ " small radius Curved Strips separated by Washers. The pan consists of an aluminium bowl and is mounted on a three-wheeled trolley so that it can easily be removed. To prevent the trolley from moving away while the machine is at work a locking device is provided. It can be seen immediately beneath the pan, and is made by pivoting a 2 " Strip to an Angle Bracket on the trolley. A bolt is passed through the second hole of the Strip and inserted in the tapped hole of a Collar carrying a 1 " Rod that slides in the boss of a Crank and engages one of the holes in the Strips of the base. The

trolley is released by raising the lever. The drive to the pan is transmitted by chain from the Rod carrying the built-up 3 " Gear. A $\frac{1}{2}$ " Pinion on the driven Rod engages a $1\frac{1}{2}$ " Con-
tate on the Rod to which the pan is fixed.

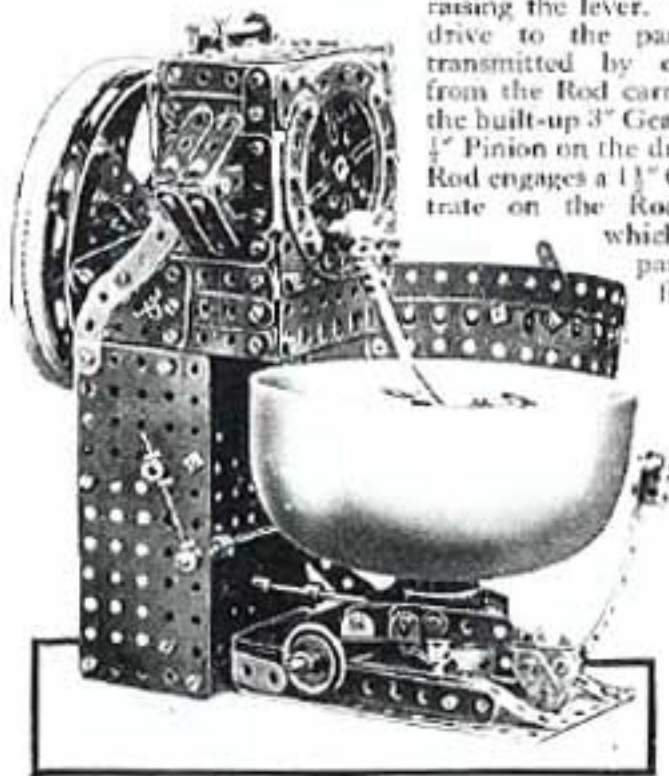

Model No. 23. Typewriter.
(F. Panzanella, Rome).

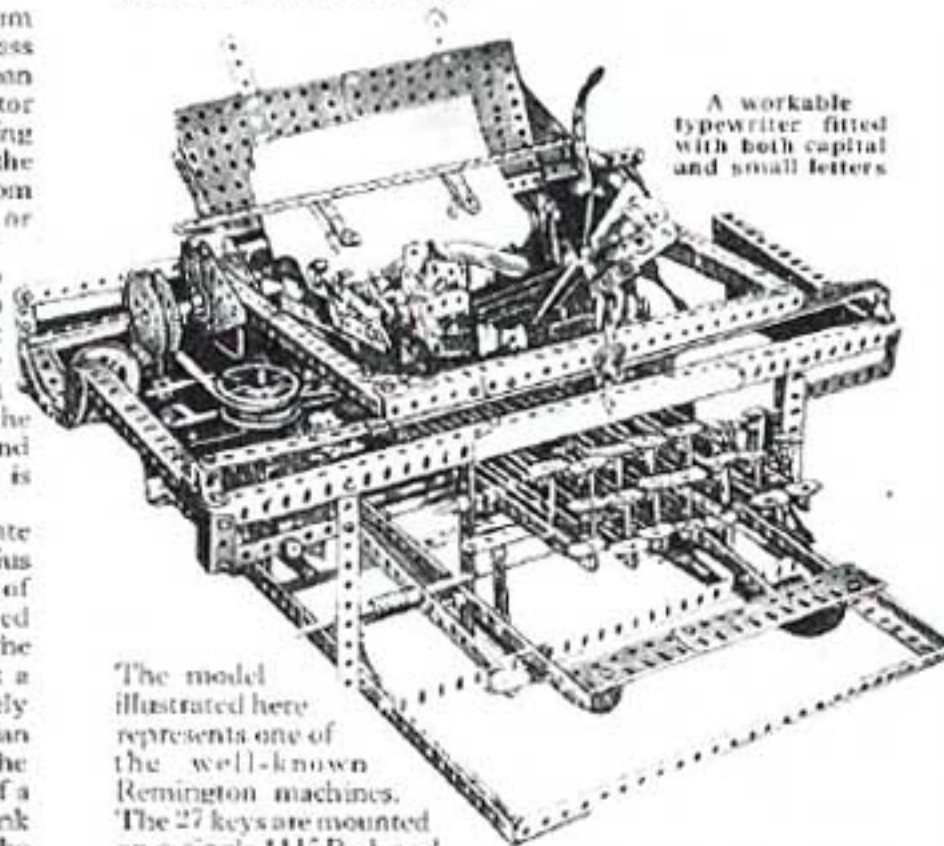

The model illustrated here represents one of the well-known Remington machines.

The 27 keys are mounted on a single $11\frac{1}{2}$ " Rod, and 26 of them carry letters of the alphabet. The inner end of each key arm carries a short Strip that connects the arm to its respective type holder, these holders being represented by Strips of different sizes, while the letters are held in $\frac{1}{2} \times \frac{1}{2}$ " Angle Brackets. The inner ends of the type holders are carried on a curved Rod so that all the types hit the paper at the same point. When a key is depressed, the corresponding type is thrown forward and passes between two Trunnions that guide it to the desired point before hitting the paper. A length of typewriter ribbon—which may be obtained from any stationer who supplies office requisites—is constantly being drawn across the space between the type guides and the paper.

The roller, together with its moving carriage, is constructed as a unit separate from the main framework of the machine. The carriage consists of a framework of Angle Girders, the underside of which is fitted with small rollers. To an Angle Girder forming the back of the frame several Rack Strips are bolted, and these engage with a $\frac{1}{2}$ " Pinion on the main frame of the typewriter. This Pinion is actuated by the operation of the keys and the spacing bar, and as it is rotated the moving carriage is drawn forward the space of one letter. The roller round which the paper is passed for receiving the impression is a circular wooden rod $1\frac{1}{2}$ " diameter. It is carried on an $11\frac{1}{2}$ " Rod mounted in suitable bearings, and a pawl and ratchet mechanism is fitted to one end. The ratchet enables the roller to be rotated a specified distance at the end of each line so that another line may be typed.

Model No. 24. Household Gas Cooker.
(Clifford P. Sharpe, Ilford).

The ingenious Meccano boy need never be short of a subject for a new model, for even the commonest objects can be reproduced with excellent results as shown by this realistic model gas stove. Four $7\frac{1}{2}$ " Angle Girders are used for the corner members, and the top and bottom of the oven each consist of two $5\frac{1}{2}$ " \times $2\frac{1}{2}$ " Flanged Plates placed side by side and secured together by bolts passed through their Flanges. The sides of the oven are each filled in with a $5\frac{1}{2}$ " \times $3\frac{1}{2}$ " Flat Plate and $5\frac{1}{2}$ " Strip secured to the lower Flanged Plates by Angle Brackets, and also to a $5\frac{1}{2}$ " Strip bolted across the top. The back is also made with Plates and Strips. Rests for the oven plates are made from two $4\frac{1}{2}$ " Angle Girders bolted to each side by Reversed Angle Brackets. Two $5\frac{1}{2}$ " \times $2\frac{1}{2}$ " Flat Plates overlapped two holes are used for the shelves.

To the top of the oven four Angle Brackets are fixed, and Flat Trunnions attached to them are joined by $5\frac{1}{2}$ " Strips. Angle Girders are bolted across their ends, and further $5\frac{1}{2}$ " Strips bolted between them serve as the bars for the pans. The gas burners are represented by 1 " fast Pulleys fixed to Strips by $\frac{1}{2}$ " Bolts.

A $5\frac{1}{2}$ " \times $3\frac{1}{2}$ " Flat Plate extended by a $5\frac{1}{2}$ " \times $2\frac{1}{2}$ " Flat Plate is bolted at the back of the stove, and carries two Angle Brackets to which are pivoted further Angle Brackets attached to the plate neck. This rack is made from a $5\frac{1}{2}$ " \times $2\frac{1}{2}$ " Flat Plate, and can be let down or folded back as desired.



Model No. 25. Automatic Coaling Plant. (L. W. Gray, Cowes, I.O.W.).

Outstanding features of a modern dock are the huge coal handling plants that are constantly at work loading thousands of tons of coal into the bunkers of ships. Many different types of coalers are in use, and one of the best known is that constructed by Vickers-Armstrong Ltd., of which the Meccano model described here is a reproduction.

The actual coaler is 74' in height and of this 18' are sunk into a well in the ground that accommodates the main gear-boxes and also the coal chute when the machine is not in use. Raising and lowering of the chute and the coal truck-tipper is carried out hydraulically, and the subsidiary movements are operated by electric motors, the drive from these being transmitted through separate gear-boxes.

The frame of the model is constructed from 24½" and 18½" Angle Girders in two separate units, and these are braced together leaving a central space 7½" wide. This space accommodates the cage and tip, which raises, lowers and tips the coal wagons. The cage is 7½" wide and 9½" long and is constructed from Angle Girders and Flat Girders of suitable lengths. The floor of the cage is hinged at the front and can be tilted by means of a ram acting on the underside. Short Angle Girders fitted to the upper side of the tip represent rails on which the wagon rests while being emptied.

The coal chute, which is 17" long, is constructed from a number of Flat Girders and Flat Plates of various sizes, and is pivotally attached at its base to the cage carrying the wagon tip. The rate at which coal is discharged is regulated by a vertically sliding door situated about midway down the coal chute. The jib is 17" long and the two main members are joined together by Threaded Bosses held in place by Bolts. Along the top of the jib runs a handrail carried in supports formed from Couplings and Handrail Supports. The jib is pivoted to the base of a vertical girder that is free to turn in bearings formed from a ball race at its lower end and a Pivot Bolt at its upper end. The support girder is 8" high and is fitted with three pulley sheaves near the top. The movements of hoisting, luffing and swivelling are carried out from a gear-box at the base of the model, and the controls are situated in a small cabin at the rear. The back of the cabin is fitted with a door that gives access to a platform extending to the rear of the model, where a ladder

running the entire height of the machine is held in place by ½" x ½" Angle Brackets.

As already mentioned, the actual machine is fitted with two hydraulic rams, one of which operates the truck cage and the other the tip. In the model link mechanism replaces the hydraulic movement and consists of Rack Strips bolted to the rams and actuated by 1" Gear Wheels. Each ram is fitted at its lower end with a 1½" Pulley, and a cord passed round this is attached at one end to the frame and at the other end to the cage. As a result of this arrangement the cage is raised or lowered by increasing or decreasing the length of the ram stroke. The ram piston for operating the cage is 9½" long and that for operating the tipping movement is 7½" long. The cord from the 9½" piston passes from the 1½" Pulleys to the top of the plant where it is taken over a 6" Pulley and secured to the hoisting cage. The cords from the 7½" ram pass from the ram pulleys to 2" Pulleys at the head of the model, and from there are led to the ram mechanism that tips the cage.

Two separate gear-boxes are provided for operating the hydraulic rams; these are situated in the base and are operated by a Meccano 6-volt Electric Motor. When the Motor is operating the hoisting ram the greater part of the load is counterbalanced by lead weights fitted to the cage. These weights are attached to cords that pass over 1" Pulleys at the top of the model and then down to the cage. The coal chute is luffed by means of four cords attached to winches situated in the base of the model, and the winch drums are rotated by the Clockwork Motor that works the derrick.

In actual practice it is frequently necessary to coal ships with very deep

holds and unless special precautions were taken the coal would be smashed into very small pieces and considerable loss would occur owing to the large quantities of coal dust produced. In order to overcome this difficulty an attachment termed an anti-breakage box is often fitted to the end of the coaling chute. In the model shown here this has been reproduced with considerable success. The body of the attachment is built up from 12½" Angle Girders and Flat Girders, and an endless belt consisting of Sprocket Chain is fitted inside. The belt has a number of 2" Flat Girders fastened to it at right-angles, which represent flaps that in the actual machine are used for conveying the coal to the bottom of the ship. As the coal enters the box it falls on to the first flap in its path and its weight causes the endless belt to rotate and so pass the coal safely to the bottom of the hold. During one flap's journey other flaps on the belt have been loaded and in this manner the continual stream of coal down the chute is dealt with.

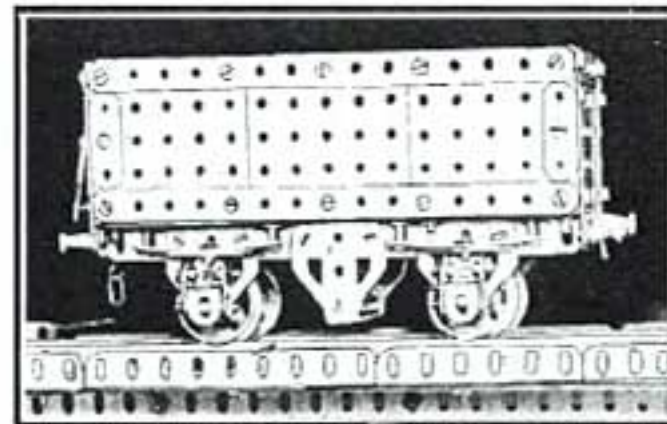
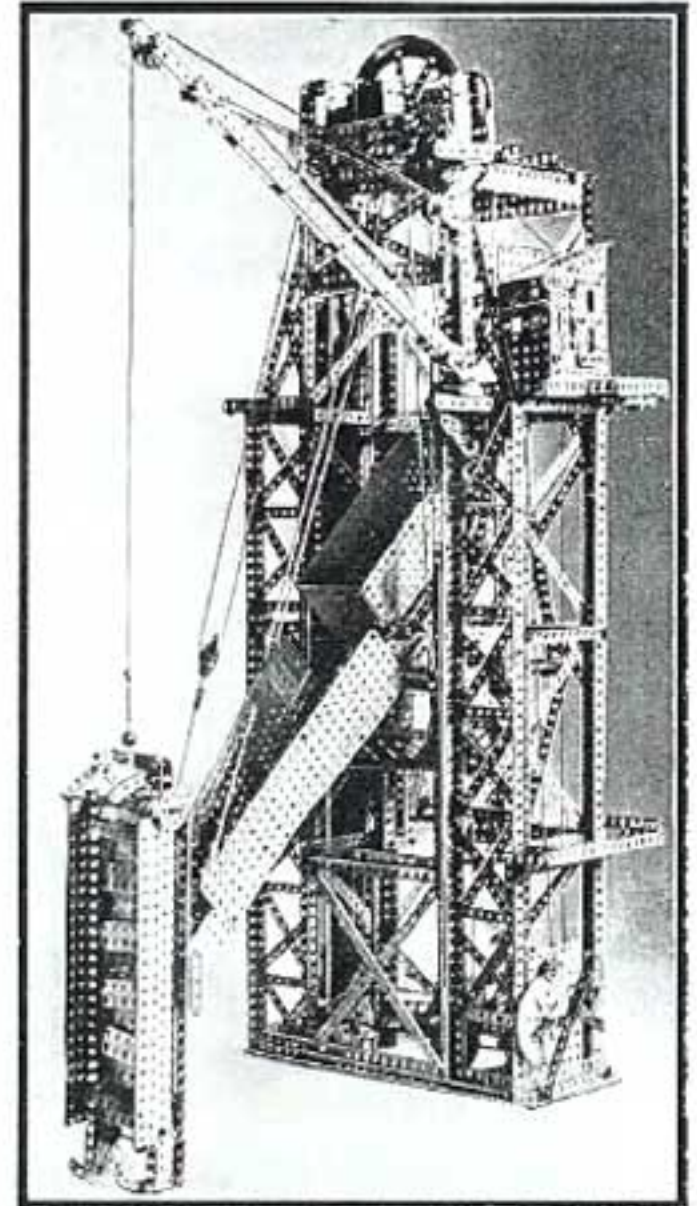
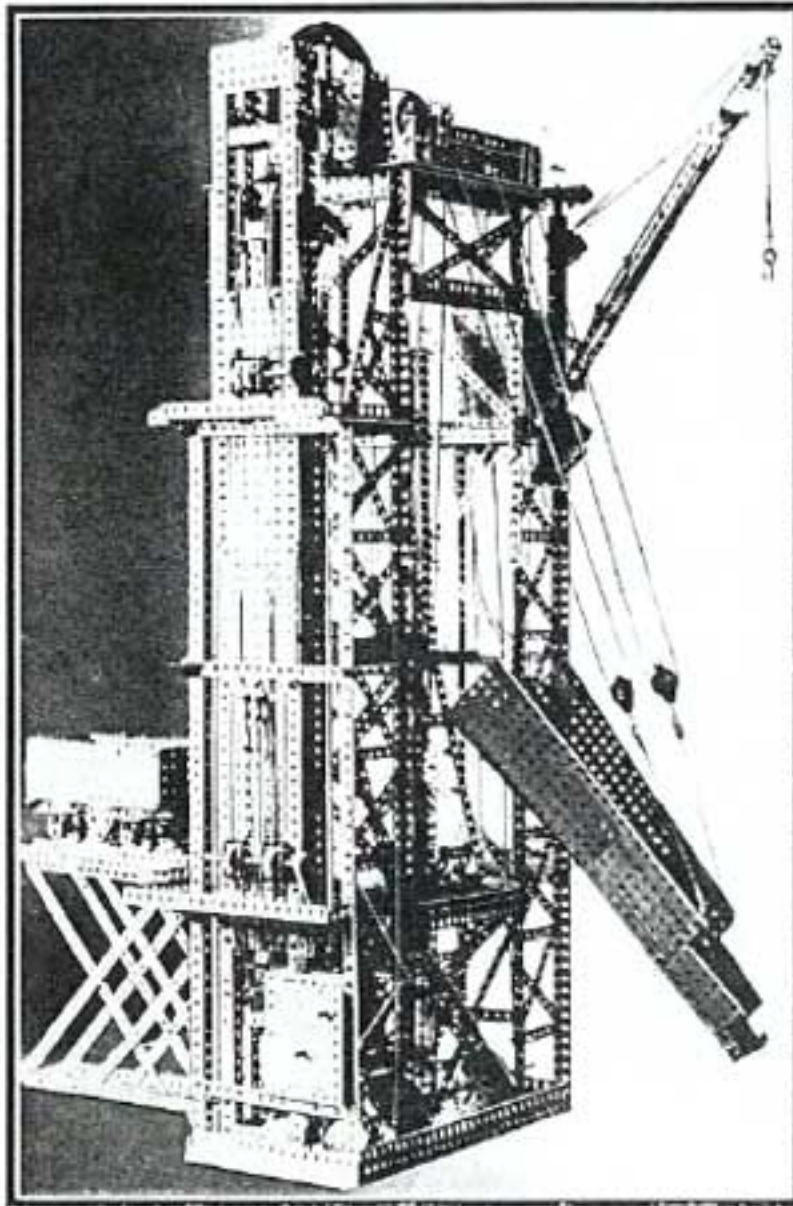

Model No. 26. French Military Tank. (R. Goffin, Roubaix, France).

The model represents one of the latest type French light tanks and is driven by a Meccano Electric Motor. This Motor is carried on a framework of Angle Girders, which accommodates

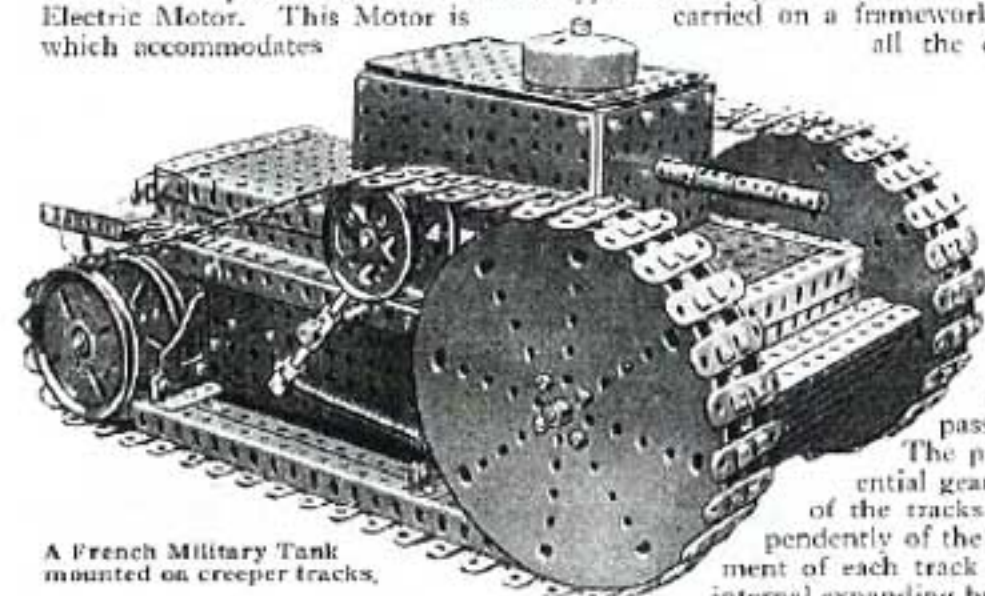

A French Military Tank mounted on creeper tracks.

all the controls and forms the main frame of the model. A train of gears transmits the drive from the Motor to a differential gear, each side of which is connected to two outside 3" Pulleys round which

passes the creeper track.

The purpose of the differential gear is to permit either of the tracks to be driven independently of the other. The movement of each track is controlled by an internal expanding brake, and by varying

the speed of either creeper the tank can be steered to right or left at will.

The tracks consist of a length of Sprocket Chain to which 2" Strips are attached at regular intervals. The chains are held in tension by a spring mounted jockey-pulley, and are kept in contact with the ground by means of 9 1/2" channel section Girders bolted to the body of the tank in the position shown in the illustration.

The gun barbette is built up from two 5 1/2" x 2 1/2" Flat Plates and two 3 1/2" x 2 1/2" Flanged Plates, these being bolted together by means of the flanges of the smaller Plates. The roof, a 5 1/2" x 3 1/2" Flat Plate, rests on 1/2" x 1/2" Angle Brackets secured to the inside of the barbette and it is fitted on top with a Boiler End representing the revolving look-out post.

The fine triple-expansion marine engine shown here was originally built for demonstrating to students the principles of this type of engine. One side of the cylinder block is left open to expose the pistons and valves, so that their movement can be watched while the engine is in motion. The base is constructed from 2 1/2" Angle Girders, and above this a second frame is built to accommodate the supports for the crankshaft bearings. These consist of 5 1/2" Angle Girders bolted across the frame of the model, and they each carry a Double Bent Strip fitted with a Handmill Support. Each web of the crankshaft is constructed from two Meccano Cranks bolted face to face so that their bosses lie at opposite ends of the finished web. Each pair of webs is connected together at one end by a 1" Rod, over which a Coupling is slipped to form the "big end."

The Couplings are connected by 5" Axle Rods to large Fork Pieces, and these are attached by Rods to the cross-heads. The cross-heads are realistically constructed from small Fork Pieces attached to Eye Pieces that slide between parallel 5 1/2" Strips. The Strips are bolted to 5 1/2" x 2 1/2" Flat Plates that form part of the stanchions supporting the cylinder block. The stanchions on the opposite side of the model consist of 8" Rods held in the bosses of Double Arm Cranks. The head for the high-pressure cylinder is a Bush

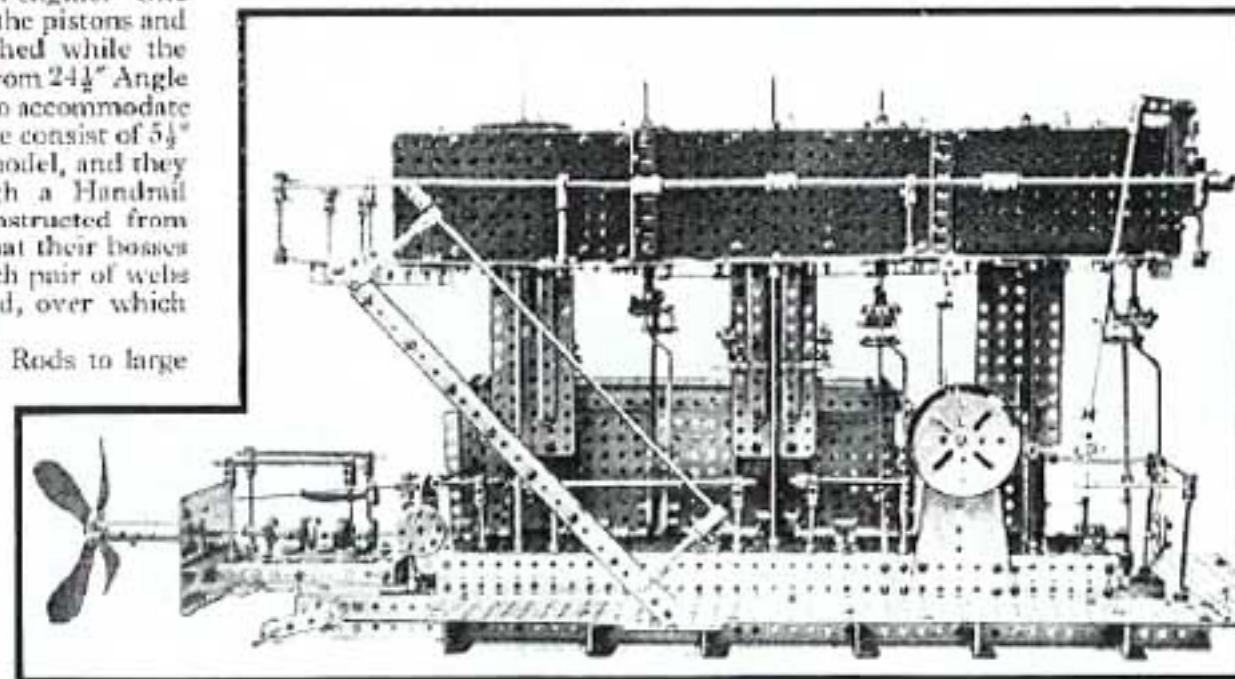

Model No. 27. Triple-Expansion Marine Engine. (P. Hoyaux, Antwerp).

Model No. 28. Mechanical Washing Machine.

(M. Lyzet, Gauderan, France).

The model consists essentially of a circular tank constructed from Circular Girders, round the outside of which are secured by two Face Plates to a secured together by 5 1/2" Angle Girders and Strips. Inside the tank a set of agitators or pegs are arranged to oscillate backward and forward, being driven by a governor-controlled Clockwork Motor.

The pegs consist of short Rods mounted on a Face Plate by means of Couplings as shown in the illustration. A 1" Pulley on the Motor driving shaft is connected by a belt with a 3" Pulley on a Rod journalled in a Double Bent Strip bolted to the Circular plate that forms the cover for the washing tank. This Rod carries at the end opposite to the 3" Pulley a Double Arm Crank, to one arm of which a 2 1/2" Strip is pivotally attached. The other end of the Strip is pivotally bolted to an Angle Bracket secured to the centre spindle of the agitator pegs.

In actual practice clothes to be washed are placed in the tank, which is then partly filled with boiling water. The Motor is set in motion and the pegs are oscillated rapidly, thus whirling the clothes through the water and thoroughly washing them. The governor is easy to build, and the bearings for its vertical shaft consist of a Bush Wheel bolted to two 1 1/2" x 1/2" Double Angle Strips.

of a circular tank constructed from Circular Girders, round the outside of which 2 1/2" Strips are bolted. The complete tank is based on a base that consists of two 5 1/2" x 2 1/2" Flat Plates

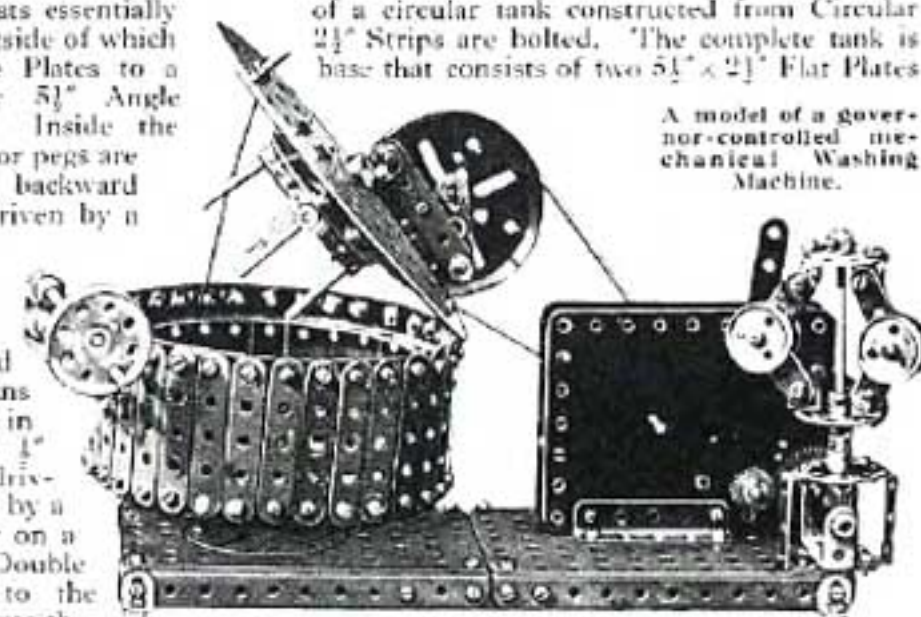

A model of a governor-controlled mechanical Washing Machine.

Wheel, and 3" Pulley Wheels are used for the heads of the low and intermediate-pressure cylinders.

The three piston rods are secured in the bosses of their respective Fork Pieces and pass through the bosses of the Bush Wheel and 3" Pulley Wheels forming the cylinder heads. Pistons are fitted to the piston rods in order that their movement in relation to the valves may be seen.

The valves are operated by Triple-throw Eccentrics secured on the crankshaft and connected to the reversing link by 5" Rods and 3 1/2" Crank Handles. This reversing link is built up from two 2 1/2" large radius Curved Strips coupled together by two Couplings, and the centre holes of these carry the ends of the 3 1/2" Crank Handles. A small sliding block forms the connection between the reversing link and the valves, and the ends of the three links are pivotally attached by 2" Strips to a horizontal Rod running the entire length of the engine. This Rod is geared to the shaft of the 3" Pulley seen on the near side of the model in the illustration. By turning this Pulley the position of all three reversing links can be adjusted simultaneously.

Model No. 29. Harvesting Combine.

(Morton Stanley, Edmonton, Alberta).

This is a model of an ingenious portable harvesting machine that cuts the corn, collects it, and after threshing it separates the grain from the husks. The chief features of the harvester have been reproduced with great accuracy in the model. This has been mounted on a base-board for convenience in photographing it, but this is not necessary to maintain rigidity, as the entire structure is very sturdily built.

The machine consists of two distinct units, the reaper and the thresher, joined together and connected by a conveyor so that as the corn is cut it is taken by a belt to the thresher. The main front of the reaper is made of Angle Girders, and a long rod consisting of several $1\frac{1}{2}$ " Rods connected with Couplings carries the reel. The construction of this is quite clear, 2" Strips being bolted radially about Bush Wheels and carrying the long slats at their outer ends by means of Angle Brackets. The knife is built up of Flat Girders and is mounted in guides so that it slides to and fro, the oscillating movement being imparted by a Coupling mounted by its centre transverse hole on a rotating Rod. A 2" Strip is pivotally attached to the Coupling and the knife to form a connecting rod, and the drive to both reel and knife is led through flexible shafts from an Electric Motor mounted on the thresher.

The threshing unit is built on a framework of Angle Girders, and travels on three wheels. Hub Discs are used for the rear wheels and at the front is an Artillery Wheel. At the outer end of the reaper are mounted 3" and $1\frac{1}{2}$ " Pulleys. The belt conveyor that carries the corn from the knife to the thresher is fitted over drums at each end of a frame made of Strips. The threshing mechanism is enclosed by Flat Plates and Angle Girders, and is driven by Sprocket Chains on the outside of the Plates. A Worm on the armature shaft of the Electric Motor engages a $\frac{1}{2}$ " Pinion, on the Rod of which is a 2" Sprocket that drives the chains.

As the machine is drawn forward the eight laths revolve and force the wheat against the cutting blade. The cut wheat then falls on to a long moving belt, and is transported by a series of shorter belts to the thresher. Here the ears of grain are forced from the stalk and are collected in a funnel, from where they are taken to the winnowing chamber to be separated from the chaff.

Model No. 30. "Collis" Commercial Truck. (J. J. Pienaar, Johannesburg).

In operation and construction the "Collis" Truck is extremely simple. It corresponds to the chassis of a motor car, having no body, but only a frame and a compact type of elevating mechanism. The goods to be moved are stored on wooden platforms fitted with runners that raise the platform from the ground to allow the truck to be run underneath; then both load and platform are lifted clear of the ground simply by moving the truck handle up and down. When the load has

been lifted it can be pushed or pulled anywhere, and lowered to the floor at its destination just as easily as it was raised. The truck represented by this model is worked hydraulically, and the up and down movement of the handle is used to operate a small ram working in an oil-filled cylinder fitted at the end of the truck. The ram is attached to the front of the lifting frame of the truck by an ingenious arrangement of toggle links, and as the ram is forced upward the lifting frame is raised. In the model shown on this page the frame is raised by a few up and down strokes of the truck handle operating a link and rod motion that pulls the lifting frame upward.

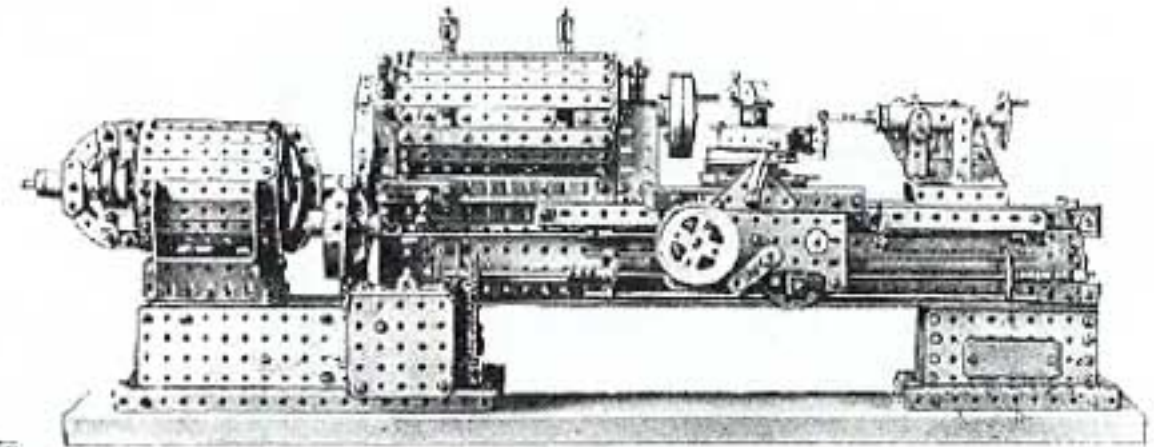

The chassis is built from Angle Girders with Strips as cross members. The lifting frame also is constructed from Angle Girders, and the hydraulic cylinder is represented by a Sleeve Piece. The yoke that secures the truck handle to the chassis is built up from a $1\frac{1}{4} \times \frac{1}{2}$ " Double Angle Strip, to the ends of which $1\frac{1}{2}$ " Strips are bolted. Cranks bolted to the $1\frac{1}{2}$ " Strips provide reinforced bearings for a short Rod on which the handle pivots. The toggle links are connected to a lever at the front of the handle, and are also attached to a Rod placed across the front of the lifting frame so that as the handle is worked up and down the lifting frame is pulled forward and upward as in the actual truck.

Model No. 31. "Lodge and Shipley" Lathe. (J. Ringnalda, Leeuwarden, Holland).

Model-builders who are interested in machine tools will find much to admire in the work done in this fine reproduction of a "Lodge and Shipley" Lathe. The slide rest is moved forward and backward by means of three Rods driven from a gear-box. The slide can be coupled to the driving Rods by means of a second handle placed near the head of the machine. Above the longitudinal slide is a second transverse slide, and running in guides on this there is a third slide that works at right-angles to the second slide.

An interesting feature is the dummy electric motor on the left of the model. This is represented by $3\frac{1}{2}$ " Strips bolted round circles of $2\frac{1}{2}$ " Small Radius Curved Strips. The cylinder so formed is secured to $3\frac{1}{2}$ " Flat Girders that are bolted to the Flat Plates of the base. Curved Strips are bolted to Double Brackets at each end of the motor as shown, and carry the bearings for the "armature" shaft. A Meccano 6-volt

Electric Motor is fitted inside the Plates beneath the dummy motor, and the drive is taken to the gear-box enclosed in the $2\frac{1}{2} \times 2\frac{1}{2}$ " Flat Plates. A Strip protruding from the top of the frame operates the gears and the drive is conveyed through Sprockets and Chain to a Rod, placed alongside the lathe bed. A handle consisting of a Double Arm Crank and Threaded Pin is mounted at the side of the slide and engages or disengages the drive. Dummy grease boxes are made by fitting a Screwed Rod in the boss of a Fork Piece and gripping a Washer between two nuts on the Rod. The Washer fits between the perforations in the arms of the Fork.

(Top) Screw-cutting Lathe, by J. Ringnalda. (Centre) M. Stanley's Harvesting Machine. (Bottom) "Collis" Truck, by J. J. Pienaar.

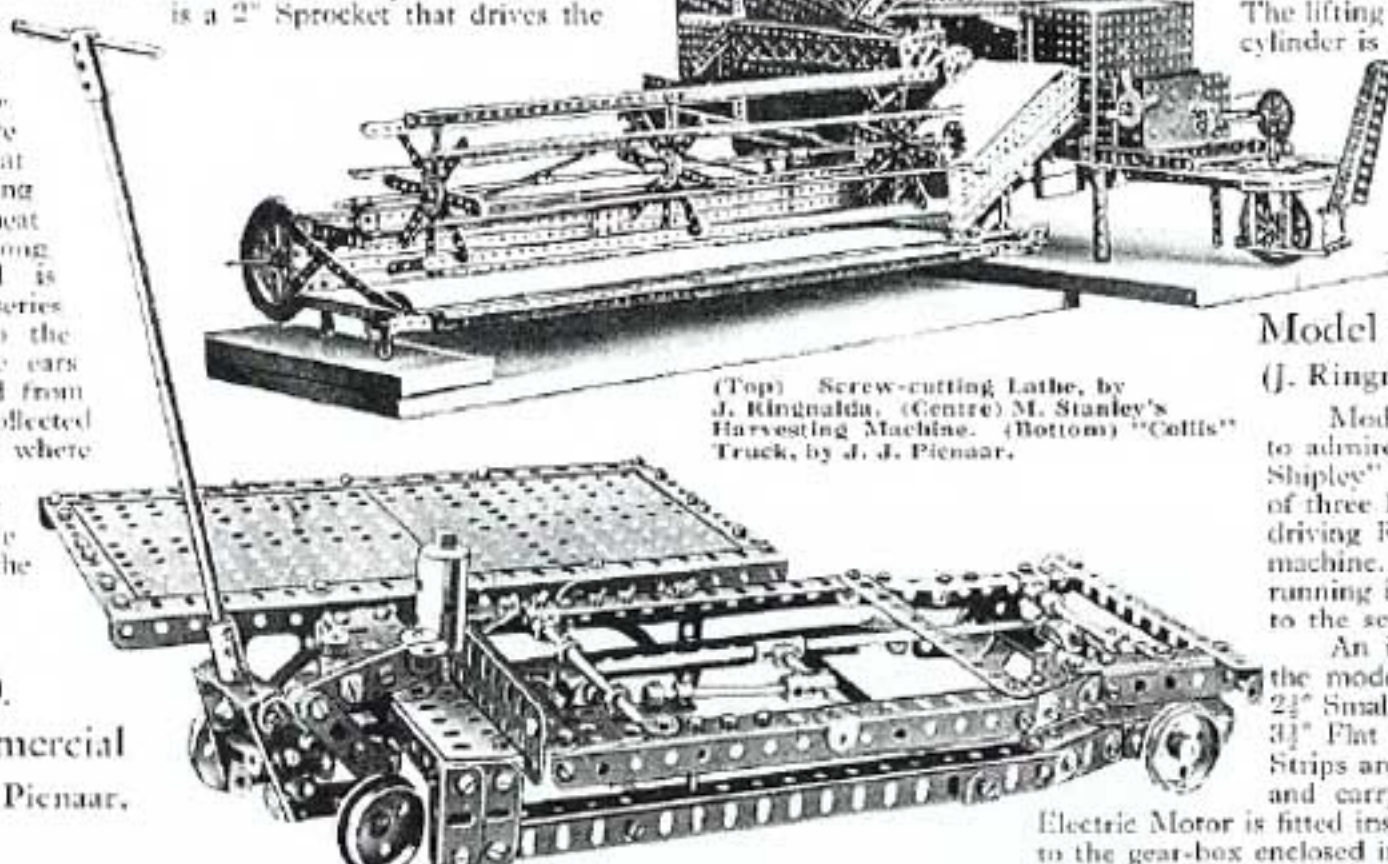

Model No. 32. Automatic Fortune-telling Machine. (J. Harris, Sanderstead).

When a coin is inserted in a slot at the top of the model it drops on to a pivoted lever 7 consisting of a $2\frac{1}{4}$ " Strip bolted to a Double Arm Crank. One end of the Strip has a piece of string tied to it and the other end carries a $1\frac{1}{2}$ " Strip, which points inward to prevent it fouling a trip-arm 11. This is a $5\frac{1}{2}$ " Strip weighted at one end with a lock-nutted $2\frac{1}{4}$ " Strip, and it is pivoted by means of a Crank on an Axle Rod that carries a Collar. One set-screw hole of the Collar carries a Threaded Pin, the end of which lies between two Collars mounted on a shaft, so that when the Threaded Pin is moved the Pinion 10 engages with the Contrate 9. The end hole of the trip-arm 11 carries a length of cord, the free end of which is tied to the bottom of the model.

The top of the model carries a box containing an electric light bulb that flashes intermittently and illuminates a revolving tape, which automatically stops for a short period every one and a quarter revolutions in order to attract the attention of prospective customers!

The motor drive to the tape is transmitted in the following way. A $\frac{3}{4}$ " Contrate 17 secured to the Axle 21 engages with another Contrate that is carried in a Socket Coupling 4, at the other end of which is a $\frac{3}{4}$ " Sprocket Wheel connected by Chain to a second similar Sprocket Wheel. This second Sprocket is held in one end of a Socket Coupling on the bottom axle of the tape roll. The Coupling carries also a $1\frac{1}{2}$ " Pulley. The Socket Coupling units are free to turn on their respective axles, but they are held in position by a Rod 16. The automatic stop drive is operated through Gear 23 on a Rod carrying a $1\frac{1}{2}$ " Gear Wheel 14 engaging with a second $1\frac{1}{2}$ " Gear Wheel. The Rod of the latter Gear carries also a $\frac{1}{2}$ " Pinion, which meshes with

a $2\frac{1}{2}$ " Gear Wheel 3 mounted on a $1\frac{1}{4}$ " Axle Rod carrying a $1\frac{1}{2}$ " Bevel Gear. The Axle Rod 24 is secured at one end to the main frame by a Double Arm Crank, and the other end carries a Coupling forming a bearing for the $1\frac{1}{4}$ " Axle Rod and for the Rod 12 carrying a $1\frac{1}{2}$ " Bevel Gear. This latter Gear meshes with the Bevel on the $1\frac{1}{4}$ " Axle.

The opposite end of the Axle 12 carries a Coupling supporting a $1\frac{1}{2}$ " Axle Rod. The front of the machine is filled in by means of two sheets of white cardboard on which verses representing the "fortunes" are written. When the propellers stop revolving the arrows on the propeller shafts indicate one of the verses.

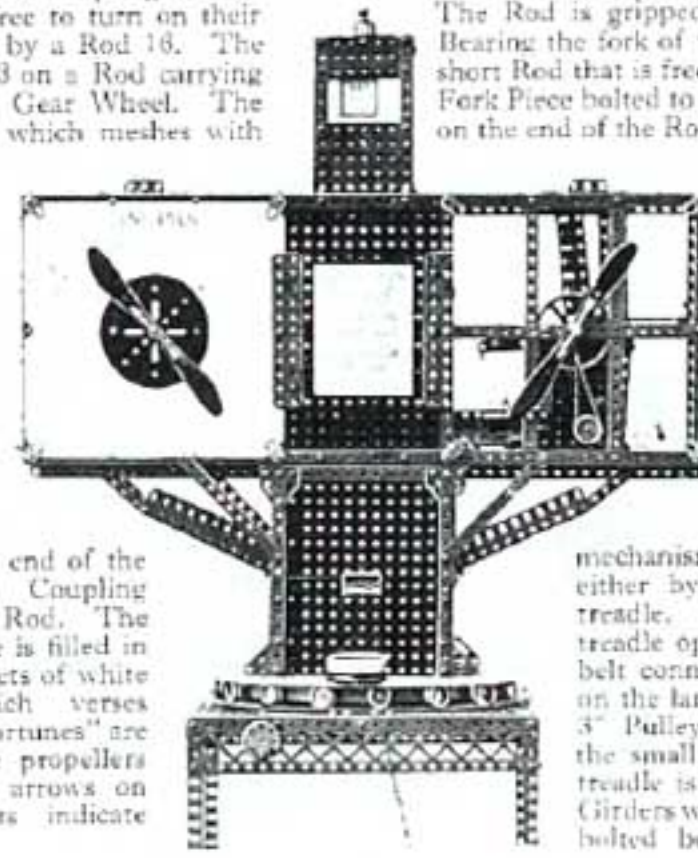
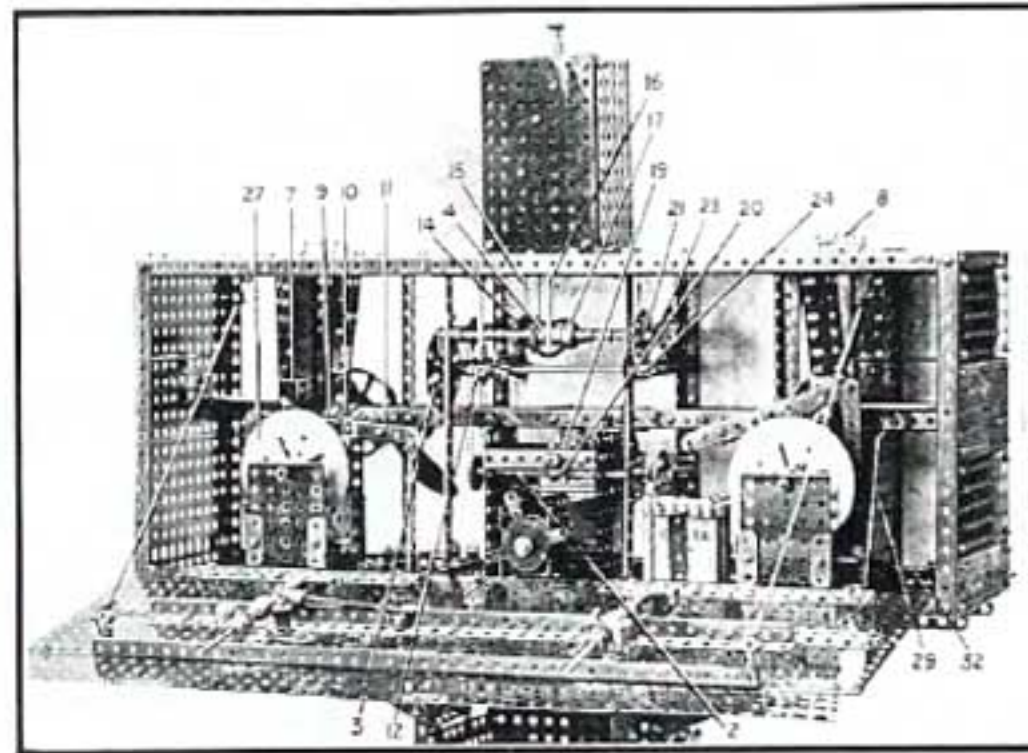

Strips and Angle Girders. At the end of the upper arm a Boiler is attached. This carries the "needle," which is represented by an Axle Rod actuated by a horizontal beam that is pivotally mounted on the arm. The Rod is gripped in the "spider" of a Swivel Bearing the fork of which is fitted on the end of a short Rod that is free to slide in the boss of a large Fork Piece bolted to the end of the beam. A Collar on the end of the Rod limits its movement.

The beam is operated by a triple-throw Eccentric mounted on the Rod of the small flywheel and crank handle. A $3\frac{1}{2}$ " Strip is pivotally attached to the end of the beam by means of a Pivot Bolt, and its other end is bolted to the arm of the Eccentric. The mechanism may be operated either by hand or by the treadle. When used as a treadle operated machine, a belt connects the $6\frac{1}{2}$ " Pulley on the large flywheel with a $3\frac{1}{2}$ " Pulley on the shaft of the small flywheel. The treadle is built up of Angle Girders with Braced Girders bolted between them.

Model No. 33. Antwerp Cathedral. (K. van Dommelen, Antwerp).

Two competitors in the £500 Contest recently organised chose this beautiful Cathedral as the subject of their entries. In the model shown here all the main external features of the Cathedral have been cleverly reproduced and the complete model is a strikingly realistic representation of the prototype. Angle Girders, Braced Girders and Strips are used for the greater part of the construction of the building, and the arches over the windows and doors are formed by means of Curved Strips. The spires are cleverly made from a number of different sized Wheels mounted on Axle Rods and surmounted by Collars.

The clock is very ingeniously constructed from a Circular Girder, round the face of which Flat Brackets are bolted to represent the hour figures. Short Rods held in the transverse holes of a Coupling are used for the fingers.

Model No. 34. Bootmaker's Sewing Machine. (K. Tanner, Johannesburg).

The housing for the mechanism is built up from Strips and the two arms are formed from

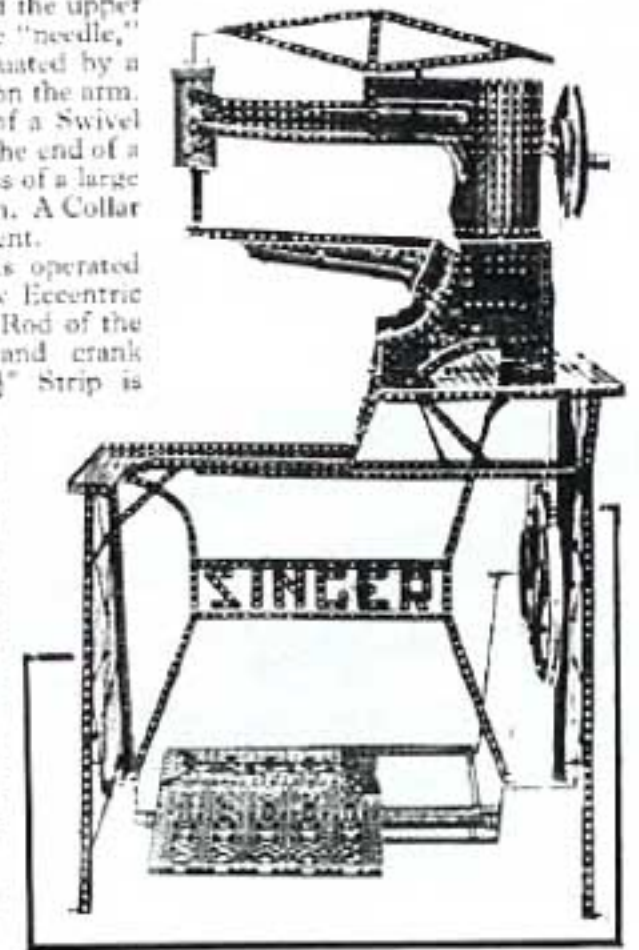

Model No. 35. "Anderson" Mechanical Butter Churn. (R. Jukes, Christchurch, N.Z.).

This model represents one of the big mechanical butter churns used in the dairies of New Zealand farms. It is copied from a popular churn known as the "Anderson Internal Worker," and those who like building intricate models will find it a splendid subject for their attention.

Essentially the machine consists of a large barrel arranged to rotate on trunnions and inside which is a set of revolving rollers. Cream is placed in the barrel and it is then set in motion. The revolving rollers beat up the cream and in due course the butter is collected on a semi-circular platform mounted on wheels, and so designed that it may be run into the revolving barrel to catch the butter as it falls from behind the churning rollers.

The barrel is constructed from $5\frac{1}{2}$ " Strips bolted to Channel Segments at the back end and to curved strips at the front. The front ring, on which the barrel revolves, is built up from Channel Segments. Three sets of Flat Girders bolted on the front end of the barrel carry six roller bearings. A $5\frac{1}{2}$ " Circular Girder bolted to the front of the barrel forms the door ring, and the door itself is made from a 4" Circular Plate with $2\frac{1}{2}$ " Curved Strips (2" radius) bolted round its periphery. The door is held in place by four levers each of which is made from a Screwed Rod; and a handle formed from a Threaded Boss and two Threaded Pins is also provided. When the door is on the barrel the handle is screwed up tight, so forcing the levers against the door ring. To remove the door the handle is slackened off and the weight is taken by the door-arms, which swing on the column shown on the left-hand side in the lower illustration. The trunnion rollers can rock freely on two pedestals, one of which carries a lever frame for the control gear. It is fitted with a quadrant made from a 2" Flat Girder, with the slotted holes cut out to locate the gear lever in the different gear positions. The lever frame is shown clearly in the illustrations.

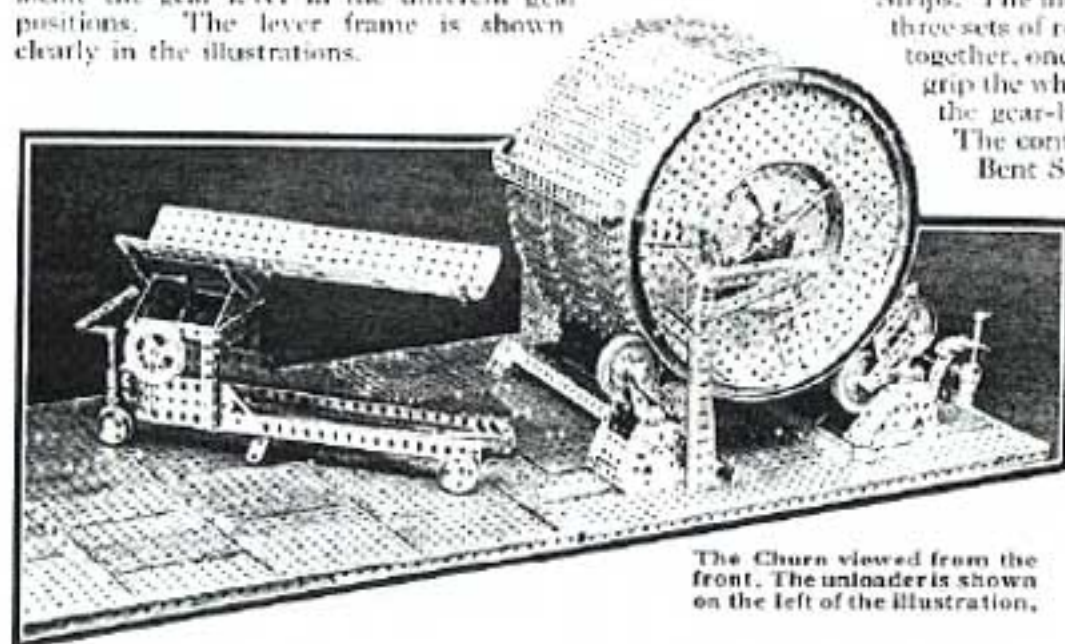

The Churn viewed from the front. The unloader is shown on the left of the illustration.

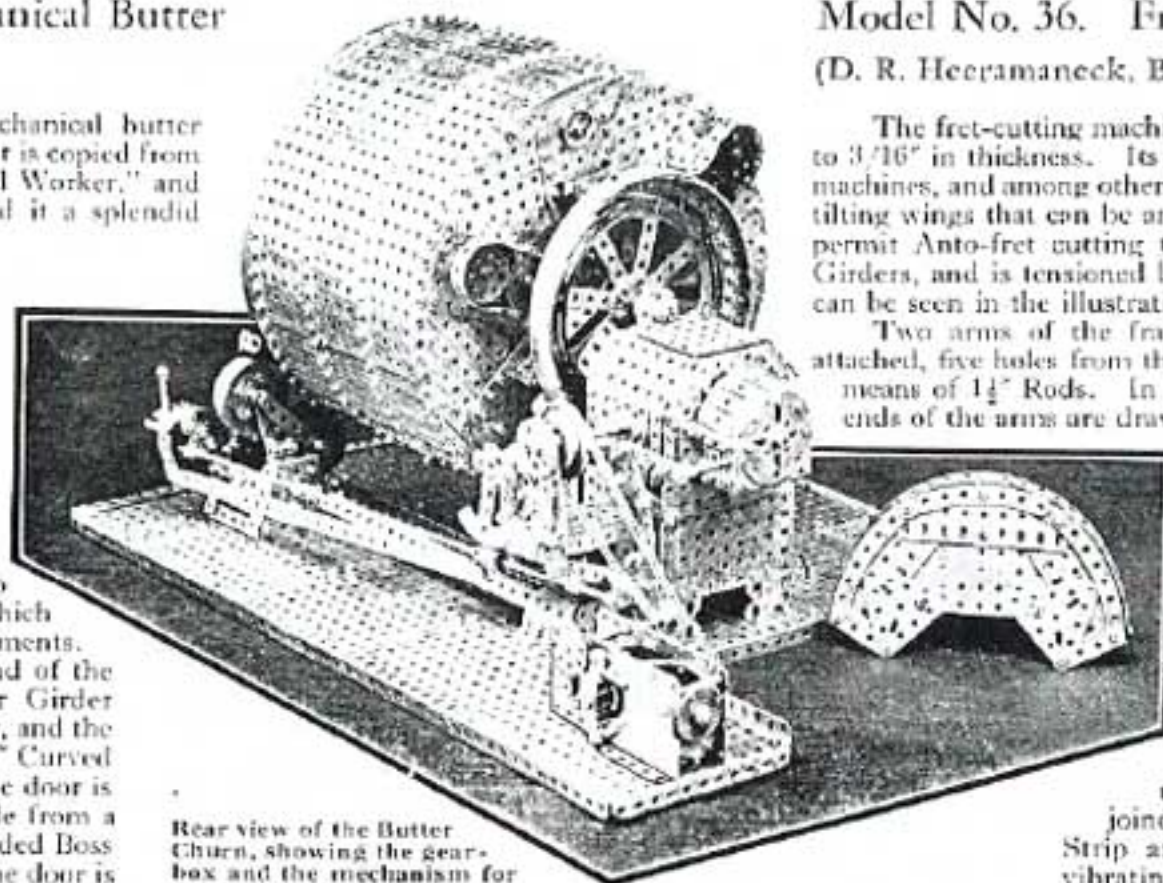

Rear view of the Butter Churn, showing the gear-box and the mechanism for driving the drum.

The rear end of the barrel is constructed from three $4\frac{1}{2}$ " x $2\frac{1}{2}$ " Plates, to which an outer gear wheel is bolted. This is made from a $7\frac{1}{2}$ " diameter Circular Strip with $\frac{1}{2}$ " Angle Brackets bolted round it and a strip of rubber placed over the outside to provide a good grip. Six rollers geared together by 57-teeth Gear Wheels are supported on bridge pieces made from $\frac{1}{2}$ " Reversed Angle Brackets and $1\frac{1}{2}$ " Strips. The internal and external mechanism that drives the three sets of rollers is made from two $5\frac{1}{2}$ " Hub Discs bolted together, one of which has a rubber band round its edge to grip the wheels; the other Disc is driven internally from the gear-box.

The control lever is a Screwed Rod bolted to a Single Bent Strip fastened to a Collar on the main control shaft, and the lower end of the Single Bent Strip is bolted to a Strip that lies alongside the control shaft at the back of the barrel. A Worm Wheel on the shaft meshes with two Rack Segments, one on the clutch control shaft and the other connected to the brakes; and at the extreme end of the control shaft is a Rack Segment in mesh with a gear that carries two levers connected to cranks on the roller and the speed control shafts. When the control lever is pulled right back the clutch is disengaged and the brake is applied; and by moving the lever to right and left the various gears are brought into operation. The unloader is shown in the lower illustration.

Model No. 36. Fret-cutting Machine. (D. R. Heeramaneck, Bombay).

The fret-cutting machine illustrated is capable of cutting through wood up to $3/16$ " in thickness. Its principal features are based on the famous Hobbies machines, and among other refinements it includes an adjustable work-table and tilting wings that can be arranged at various angles to the plane of the saw, to permit Auto-fret cutting to be done. The saw frame is built from Angle Girders, and is tensioned by a specially designed mechanism, details of which can be seen in the illustration.

Two arms of the frame are built-up channel section girders pivotally attached, five holes from their rear ends, to two vertical $5\frac{1}{2}$ " Angle Girders, by means of $1\frac{1}{2}$ " Rods. In order to tighten the saw blade the two overhanging ends of the arms are drawn together by means of Threaded Rods working in the tapped holes of two Couplings that are secured to the frame arms. The saw blade is gripped in Couplings held in the ends of the arms. Reciprocating movement is given to the frame by a Meccano Electric Motor, the drive from which is transmitted, by means of a Spring Cord belt from a $\frac{1}{2}$ " Pulley Wheel on the Motor armature shaft, to a 6" Pulley Wheel, on the shaft of which is secured a Crank pivotally connected to the saw frame by an 8" Axle Rod. When the Motor is set in motion the Crank causes the Rod to move upward and downward, and so transmit the

necessary movement to the saw frame. Two Rods joined together by a Coupling slide in holes of a $5\frac{1}{2}$ " Strip and form guides to prevent the saw frame from vibrating when the machine is working.

The cutting-table is mounted on a horizontal 8" Axle Rod journaled in the top of the framework of the model. This Rod carries a Crank, and a 2" Bolt held in the end hole in the Crank arm engages with the holes in a built-up quadrant. The table is held securely at various angles according to the hole in the quadrant in which the bolt is placed. The quadrant is made from two $2\frac{1}{2}$ " small radius Curved Strips. The work-table is a Hub Disc, and Sector Plates are used for the wings. If desired a lay-shaft can be fitted to accommodate sand-papering and buffing wheels.

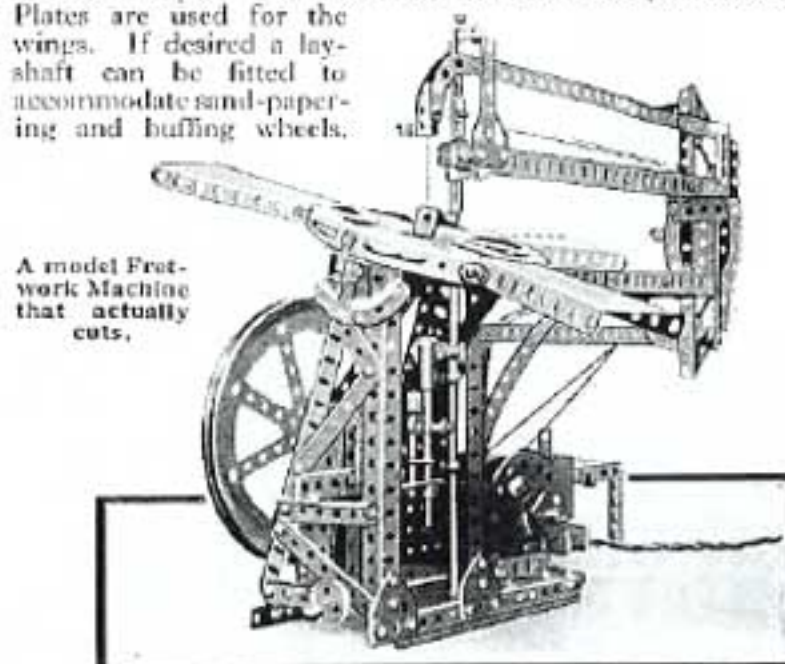

A model Fret-work Machine that actually cuts.

Model No. 37. Electric Clock. (J. F. Huson, London).

The fine electric "slave" clock illustrated keeps accurate time and can be used in conjunction with the Meccano Super Model Grandfather Clock or the Mantel Clock (Model No. 7.13) by fitting electrical contacts to these models. The frame of the model is constructed from two 13½" lengths of Strips, each built up from two 7½" Strips overlapping each other three holes. The two lengths are connected together by twenty-seven 3¼" Strips as shown, and when these are all in place this section of the model is curved to shape. Each end is supported on two vertical 2½" Angle Girders carrying 3½" Strips that are fitted in a similar manner to those used previously. The two ends of the clock frame are connected together by two 9½" Angle Girders, and these support the base of the model that is constructed from three 5½" x 3½" Flat Plates. The complete clock casing is raised on four Handrail Supports.

A fine example of an electrically operated clock. It was built by J. F. Huson, London, and keeps accurate time.

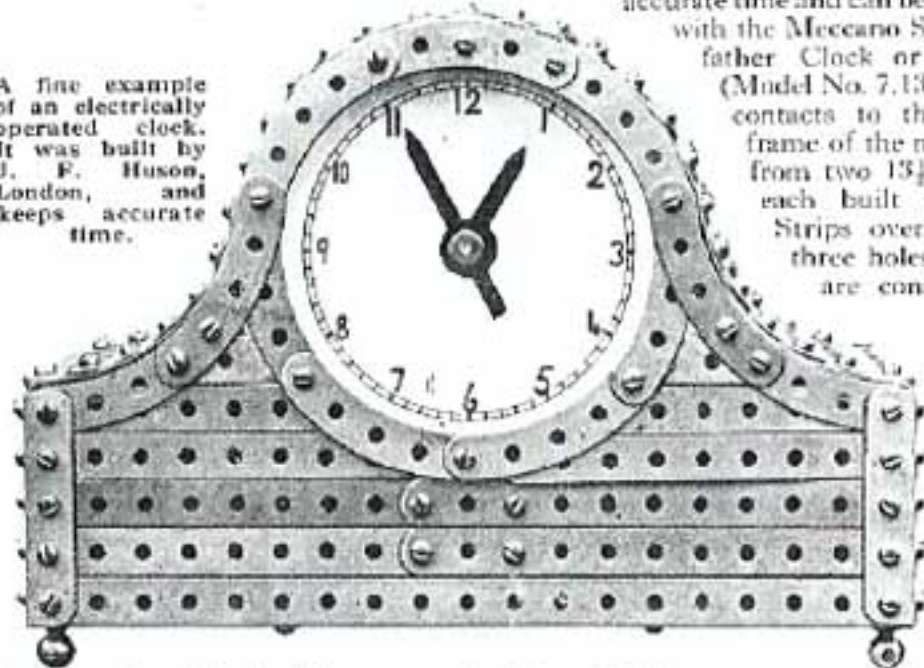

The front of the clock is a fine piece of work and it is doubtful if a neater appearance could possibly have been gained. The edging is built up from seven 2½" Large Radius Curved Strips, and the face circle is moulded into this by the use of three further 2½" Curved Strips. The lower section of the front is built in by means of Strips of various lengths.

The clock mechanism is carried in a frame consisting of two 21" x 2½" Flat Plates connected together at three of their corners by 1" x 1" Angle Brackets. These Plates are attached to two 1½" x ½" Double Angle Strips, bolted to the clock frame, by means of four 1½" Strips. The two electro-magnets controlled by the master clock are secured in place by two ½" x ½" Angle Brackets and a 1½" Flat Girder, a suitable yoke for the magnets being composed of three 1½" Strips. The magnets when excited cause an arm to rock, and this action actuates a ratchet mechanism by means of a Pawl on the end of the arm. This movement, which gives the Ratchet Wheel 1/20th of a complete turn every third of a minute, is geared down to the hands of the clock. The oscillating arm consists of a Screwed Rod with 1½" Strips fixed across one end and a Pawl pivoted at the other. The Strips are attracted by the magnet cores and so raise the

The front of the clock is a fine piece of work and it is doubtful if a neater appearance could possibly have been gained. The edging is built up from seven 2½" Large Radius Curved Strips, and the face circle is moulded into this by the use of three further 2½" Curved Strips. The lower section of the front is built in by means of Strips of various lengths.

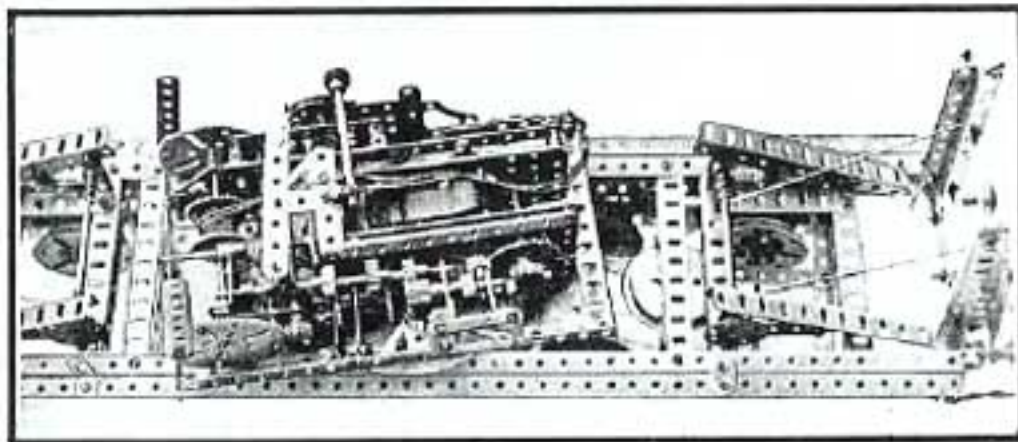

Pawl, which drops as soon as the current is cut off and moves the Ratchet through 1/20th of a revolution. A second Pawl prevents backward movement of the Ratchet.

Model No. 38. Portable Truck Tip. (R. van Bulek, Brussels).

The Meccano model is built to a scale of 1" to 1', and is complete in every detail, including a railway wagon. The main frames are 24½" long and 1' high, and are constructed from 24½" Angle Girders and 12½" and 5½" Flat Girders. The two sides are connected together by means of a number of 5½" Angle Girders, and to the centre of the frames a 5½" x 3½" Flat Plate strengthened with 5½" Angle Girders is bolted. Each of the two swivelling bogies is constructed from two 5½" Angle Girders for the sides and four 4½" Angle Girders for the cross members, two of the 4½" Girders being used for carrying the swivel pin. The sides of the bogie are fitted with 5½" Flat Girders, and these carry the wheel springs, each of which consists of three 2½" Strips clamped together by ½" Bolts and secured to the bogie frame by two Threaded Bosses.

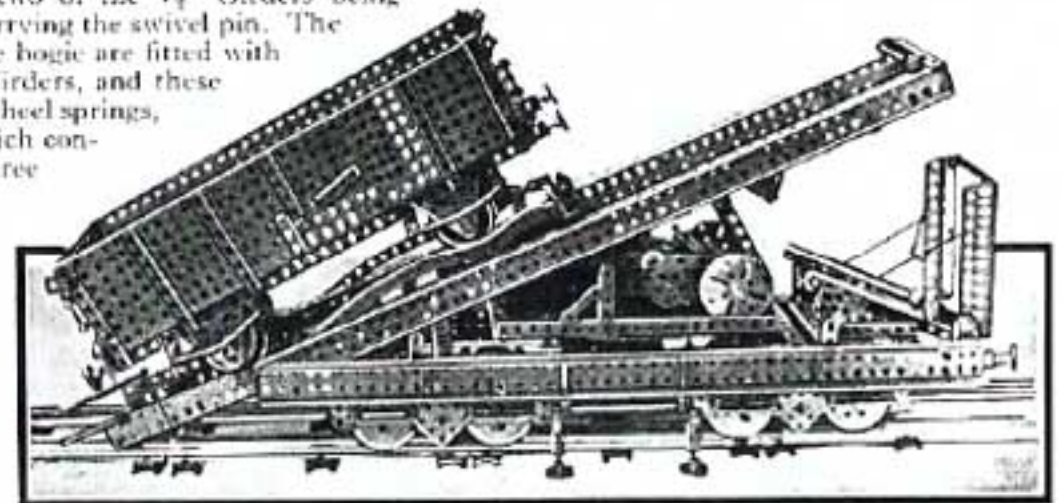

The axle-box, which is attached to the spring, consists of a Collar. The wheel axles are held in the Collars, the wheels being free to rotate.

Four screw jacks are fitted, two to each side of the main frames, and each of them consists of two Cranks bolted together with their respective bosses at opposite ends, one of the bosses being passed over and secured to a vertical pivot rod in the frames. The boss of the other Crank carries a Threaded Coupling in which a 1" Threaded Rod forming a screw jack operates. The lower end of the Threaded Rod carries a 1" fast Pulley.

The 5½" x 3½" Flat Plate bolted across the main frames carries a 4" Ball Bearing on which is mounted a framework that supports the Electric Motor used for working the model. Two Architraves, fitted one on each side of the Motor, form the pivots for the tipping girders.

These are constructed in two portions from Angle Girders and Flat Girders of various sizes, and are connected together by cross members made with 5½" Angle Girders. When the Girders form rails on which a sliding wheel is completed a sliding wheel of in hollows truck, and a trolley operates. The front the wagon to be tipped rest on each side of the sliding Crane Grab is hitched to the wheel axle to prevent the wagon from breaking loose while it is being tipped. The illustration on the left is an underneath view of the model and shows the mechanism clearly.

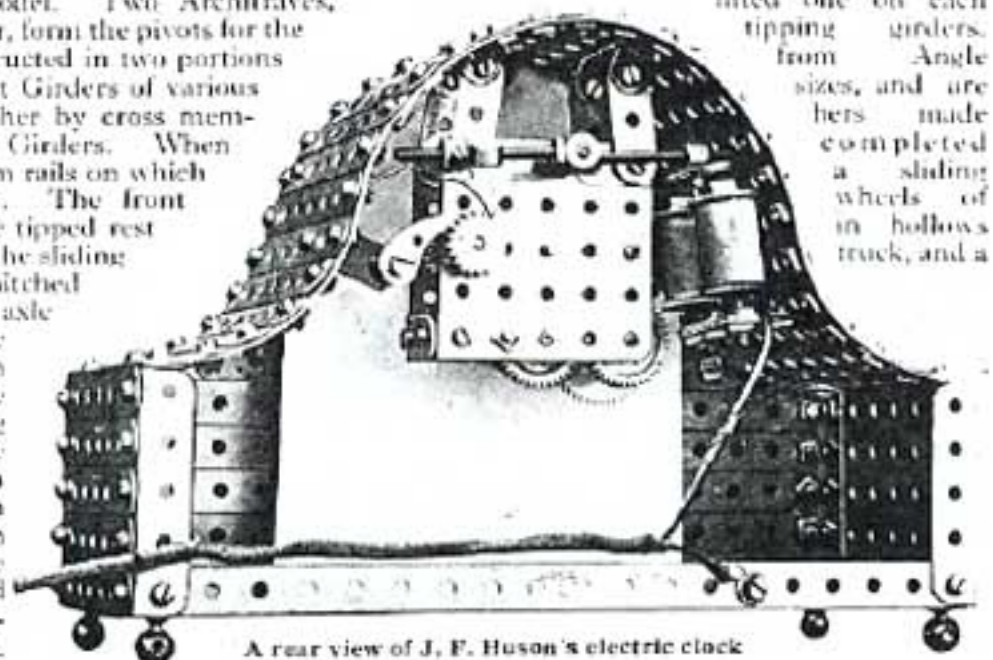

A rear view of J. F. Huson's electric clock

Model No. 39. Railway Footbridge. (L. Hollyoak, Coventry).

The two main vertical supports are each constructed from 12½" Angle Girders bolted to a base consisting of a 5½" x 2½" Flanged Plate. Each corner of the Plate is then fitted with a channel section girder composed of two 12½" Angle Girders. The centre span or bridge proper is 12½" long and is constructed from 12½" Angle Girders and 5½" x 3½" Flat Plates. The span is connected at each end to the two main supports

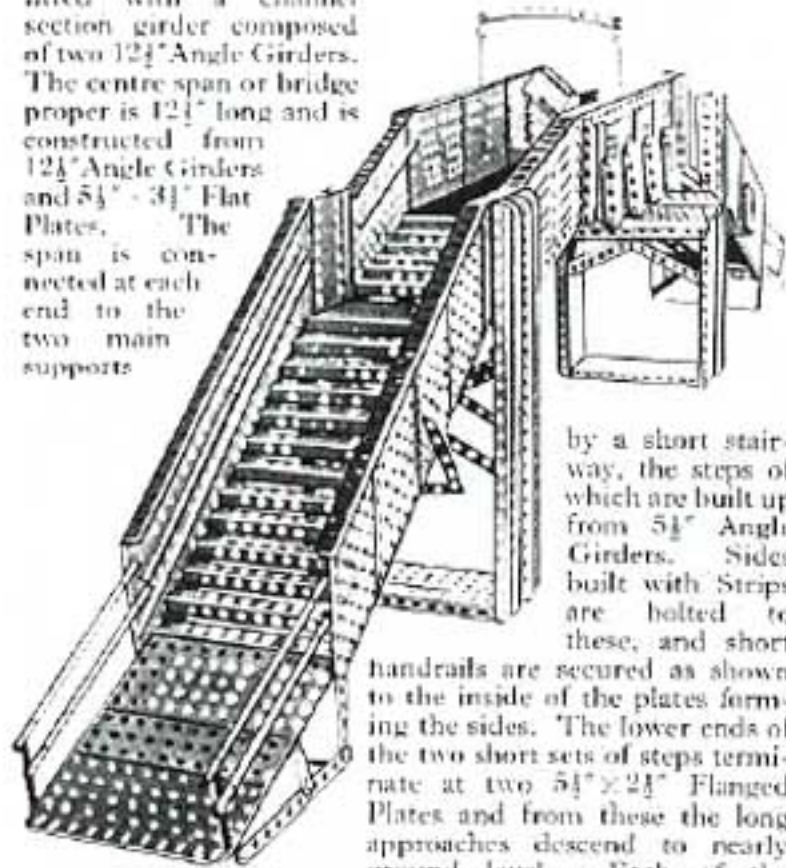

by a short stair-way, the steps of which are built up from 5½" Angle Girders. Sides built with Strips are bolted to these, and short handrails are secured as shown to the inside of the plates forming the sides. The lower ends of the two short sets of steps terminate at two 5½" x 2½" Flanged Plates and from these the long approaches descend to nearly ground level. Each of the approaches is built up from 5½"

Angle Girders, and the lower end of the steps is raised about 2" off the ground. The intervening space is covered by a gently sloping ramp constructed from 5½" x 2½" Flat Plates.

The sides of the long sets of steps are composed of 5½" x 3½" Flat Plates, and handrails consisting of 11½" Rods fitted to the insides of the Plates are held in place by means of Dredger Bucket Clips. The short ramps leading up to the steps have no sides, but are fitted with double handrails. These are carried on 2½" Strips at their outer ends and secured to the lower ends of the step sides at their raised ends. The connections consist of Dredger Bucket Clips, fitted in a similar manner to those of the longer handrails.

The under side of the centre span is fitted with two sets of smoke deflectors, each of which consists of two 5½" x 2½" Flanged Plates, bolted together at their end flanges.

An arch is fitted across the foot way of the centre span, and this not only adds to the appearance but also forms an efficient handle by means of which the model may be moved from one point to another.

Model No. 40. Arch Bridge. (A. Robert, Johannesburg).

Another fine example of bridge construction is shown in this model arch bridge, which forms an attractive accessory for use in connection with a model railway layout.

The model is 8" 6" in length and is built on similar lines to the fine new bridge that spans the chasm below the Niagara Falls. Each side of the bridge is built as follows. The lower curve of the arch is made from two 24½" lengths of channel section girders and six lengths of 5½" built-up channel section girders, and the separate sections are joined together by means of Flat Brackets. The upper curve of the arch is represented by two 24½" channel section girders. These are secured at one end to the lower ends of the bottom curve of the arch, and their other ends are bolted to

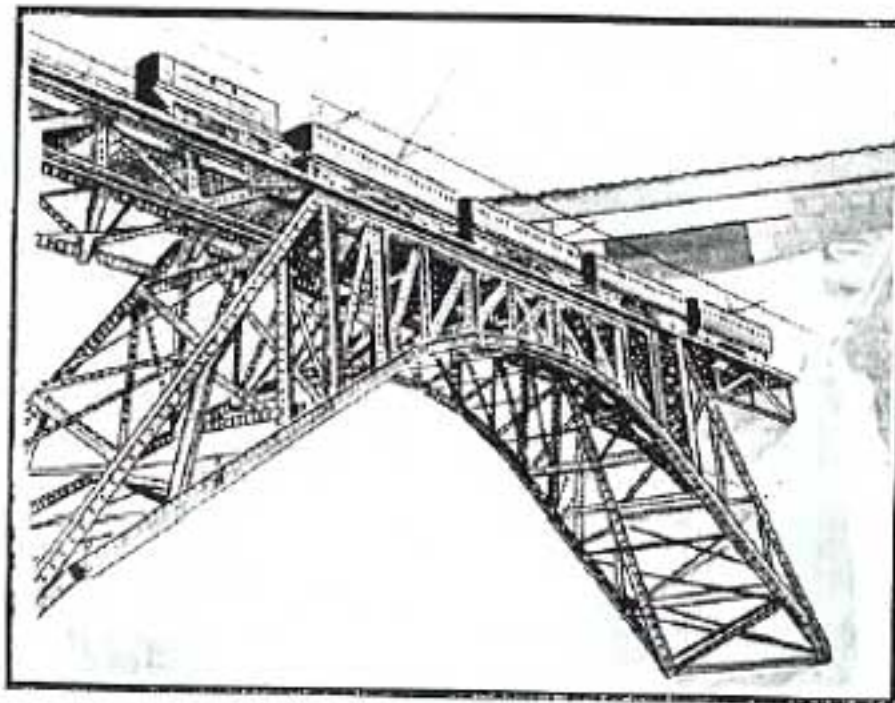

24½" girders forming the roadway of the bridge proper. The lower arch is braced to the sections of the upper arch, and also to the level roadway portion of the bridge, by Angle Girders and Strips, and the two sides of the bridge are connected together by 9½" Angle Girders and Strips.

The sides of the roadway are constructed from a number of 24½" Angle Girders, the two sides being connected together by short Angle Girders that support a double track railway. The photograph shows a Hornby Electric Locomotive and Coaches passing over the bridge and the effect is quite realistic.

The appearance of the bridge is enhanced by fitting side-walks, electric lamps and overhead wire support standards. The side-walks are built of 12½" Strips and handrails running down the inside of these are constructed from short Rods and Couplings. The overhead standards are of the inverted "L" type and they are each constructed from one 5" Rod and one 3½" Rod. The electric lamps are held in Lamp Holders secured to the upper lugs of 1" Reversed Angle Brackets and are wired in series.

Model No. 41. Beam Lifting Bridge. (J. H. Beecroft, Nottingham).

The fine bridge shown at the bottom of this page is an accurate reproduction of a type of beam lifting bridge that is quite common in some European countries where it is used for bridging canals. In England the only example is that at West Bridgford.

The bridge, which is 12½" in width and 18½" in length, is constructed from 5½" x 3½" Flat Plates bolted to a framework of 12½" and 18½" Angle Girders. It is hinged at its lower end to a soundly constructed base, and raising and lowering is accomplished by means of two lengths of cord, one being secured to each side of the bridge. These cords pass over ½" loose Pulleys carried mid-way up a vertical framework, the top of which carries the beam pivots. The lower ends of the two cords are wound on a drum operated by a Meccano Electric Motor.

The beam, which gives the model its distinctive appearance, is pivoted in its centre on an 11½" Rod, situated at the top of the vertical framework just mentioned. One end of the beam is coupled to the outer end of the bridge by means of 11½" Rods and Swivel Bearings, and the other end carries a large balance weight. Whatever is used for the weight, it should be enclosed in a box constructed from 5½" x 2½" Flat Plates and 12½" Flat Girders.

The bridge is raised and lowered by a Meccano Electric Motor, and a ¼" Pinion on the armature shaft engages with a 57-teeth Gear. The Rod on

which this Gear is mounted carries a Worm on its opposite end and this engages with a 57-teeth Gear driving a 50-teeth Gear through a ¼" Pinion.

The 50-teeth Gear rotates the hoisting drums, which consist of two 1½" Rods, one of which is situated on each side of the model. The drive from one of the drums is transmitted to the second drum by means of Sprocket Chain so that both drums rotate together.

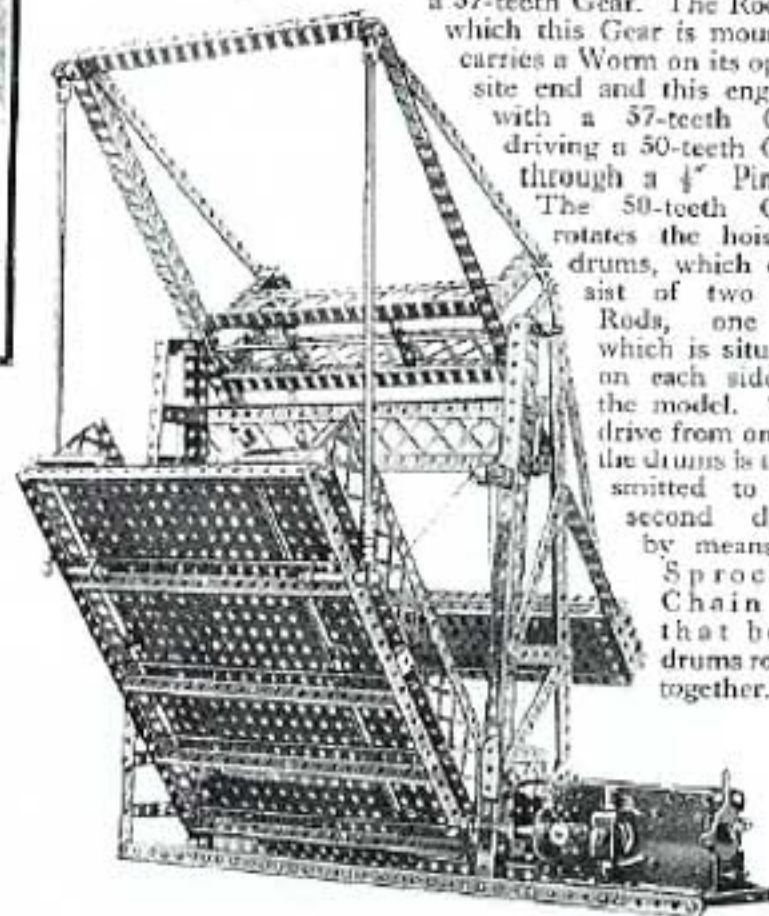

Model No. 42. Bascule Bridge. (J. de Proft, Willebroeck, Belgium).

In this model the river portion of the bridge is hinged at one end, and lifts from the horizontal to the vertical position to enable traffic to pass. The model is of sturdy yet neat construction and is fitted with many refinements that are frequently overlooked by model-builders.

Built-up channel section girders are used for the main girders of the centre span, and each of the bridge sides is braced by pairs of Strips. The roadway passes between the side members, but the footwalks are built on the outside and are fitted with handrails consisting of Axle Rods held in Handrail Supports. These are fixed in Couplings extended by means of Collars.

The approaches are constructed from Plates and Angle Girders, and one of them is made larger than the other in order to accommodate the mechanism for raising the bridge. A framework of Girders is constructed to house the mechanism and control cabin, which is clearly shown in the illustration. A Meccano Electric Motor provides the motive power and is fitted with Worm gearing to give a big reduction ratio. This is necessary to provide a slow powerful drive for lifting the bridge, which is done through Rack and Pinion mechanism. Rotating Pinions on each side of the fixed framework engage movable Rack Strips connected to the bridge. In order to ease the load on the Motor a counterpoise is arranged to operate a system of levers, the purpose of which is to balance the weight of the bridge. This mechanism closely follows actual practice, and a careful examination of the photograph will reveal how it operates. The counterweight is mounted on the end of a lever of the first order formed by a triangulated girder construction, and at the other end of the lever pivoted Girders connect up with the bridge. In the model illustrated the counterweight is represented by Flat Plates, but as a large number of these are required to completely balance the bridge, a built-up box filled with pieces of lead or any other heavy objects might be used instead.

Handrails enclose both of the bridge approaches and are formed from Axle Rods carried in Handrail Supports and Couplings, in a similar manner to those on the bridge itself. Lamp standards are built up from Strips and Girders, and are surmounted by Axle Rods bent to a right-angle. The lamps are wired up to a dry battery placed under the approach. The same battery is used to supply current for the lamps in the control cabin, and further lamps coloured red are mounted on the gates to serve as danger signals when the bridge is raised.



This Vertical Lifting Bridge is operated by a Meccano Electric Motor and embodies several different forms of girder construction.

Model No. 43. Vertical Lifting Bridge. (H. Bertrous, Nantes).

Bridges of this type consist of a roadway suspended between end towers, one on each shore of the river. Normally the roadway is level with the river banks, but when it is necessary to allow a ship to pass the span is lifted high above the water by means of machinery and is lowered into its original position again after the ship has gone through.

The end spans of the Meccano model are built up from Angle Girders and Strips, the sides being spaced apart by Angle Girders at the base and Double Angle Strips at the top. Four 2 1/2" Angle Girders form the corner members of each of the towers and are rigidly braced by means of Strips. The towers taper towards their upper extremities and are surmounted by Flanged Brackets in which are journaled short Rods carrying 1 1/2" Pulleys, over which the hoisting cords for raising and lowering the centre span are passed.

Small ladders are fitted inside each tower and consist of Strips connected at each end by Double Brackets, with Angle Brackets secured in every other hole for the rungs.

Two 1 1/2" Angle Girders spaced apart by further Girders form the framework on which the centre span is built. Strips are bolted vertically to the side Girders and braced by additional Strips; and short Strips bolted together to form a long curved strip are secured to the upper extremities of the vertical members. Guides for the centre span are provided by lengths of Cord stretched between the upper and lower ends of the towers and passed through the Angle Girders fitted across each end of the span.

The hoisting mechanism is mounted in the right-hand tower and is driven by a Meccano Electric Motor. A control cabin is built on to the side of the tower and from this point the Motor can be started, stopped and reversed. Suitable mechanism for this model may be copied from Model No. 6.30, Vertical Lifting Bridge, in the Nos. 5-7 Instruction Manual.

Model No. 44. Drawbridge and Entrance to Norman Castle. (A. Chew, Wilmslow).

The model is built on a flat base consisting of four 1 1/2" Braced Girders bolted edge to edge. One side of the base carries a vertical 3 1/2" x 2 1/2" Flanged Plate to which a second similar part is secured at right-angles. The outer end of this latter Plate is supported on a 2 1/2" Strip, which is secured by a Double Bracket and a 3 1/2" Strip to the base.

The towers at each side of the gateway are 12 1/2" in height and 2 1/2" in width, and each is built up from two channel section girders formed from 1 1/2" Angle Girders connected together by three 7/8" Strips. The centre of the space between the two Girders is fitted with a 1 1/2" Strip, and the two narrow slots remaining are filled with 5/8" Strips. The two complete towers are connected by two 5 1/2" x 2 1/2" Flanged Plates, to the lower one of which the drawbridge is hinged. The drawbridge is raised and lowered by means of cords attached to each side of its outer end and then passed through holes in the 5 1/2" x 2 1/2" Flanged Plate spanning the archway. The other ends of the cords are then attached to a long shaft consisting of an 11 1/2" Rod, to which a Bush Wheel carrying a Threaded Pin is secured to form a handle.

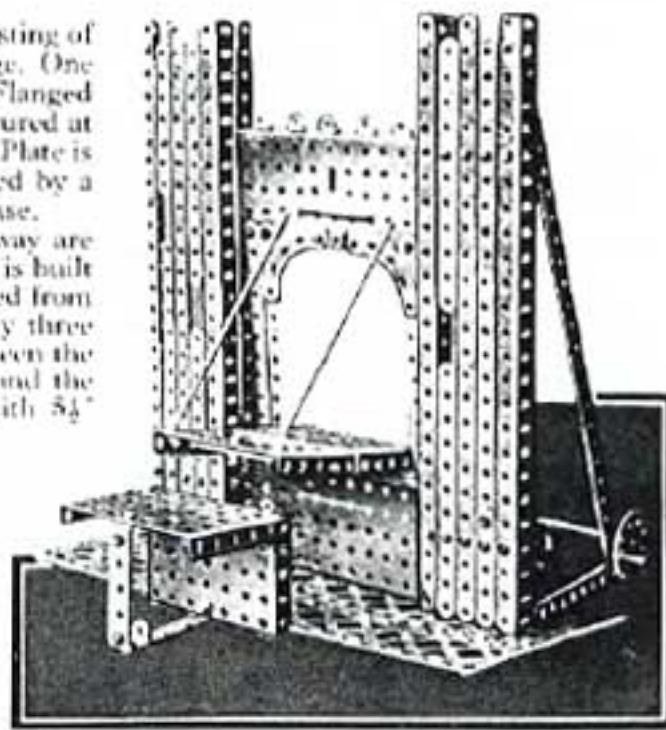

A simple drawbridge suitable for incorporation in a model of a castle.

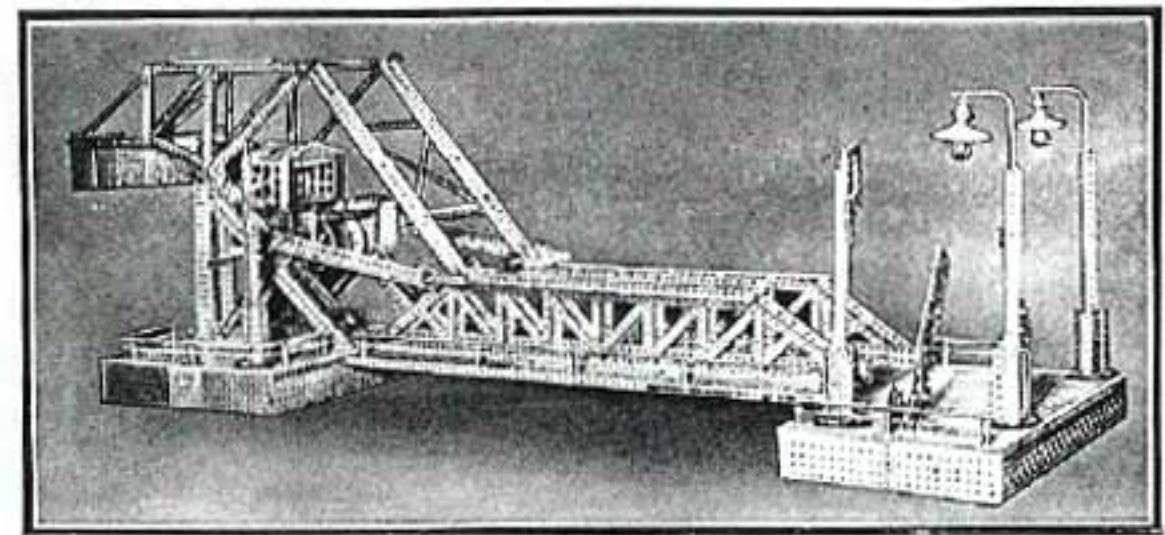

A fine example of model bridge-building. The bascule is counterbalanced and is raised and lowered by an Electric Motor.

Model No. 45. Hoisting and Grabbing Crane. (R. Heris, Brussels).

Cranes may be divided into two main groups—those that are used for lifting heavy solids, and those that are fitted with special grabs and are intended for handling sand, mud and similar materials. Sometimes these two functions are incorporated in a single crane, and it is one of these that forms the prototype of the model described here. The model represents a huge dock-side crane that is capable of unloading a ship of almost anything from locomotives to wheat.

The square base of the model is constructed from four $12\frac{1}{2}$ " compound girders, and $5\frac{1}{2}$ " \times $3\frac{1}{2}$ " Flat Plates are used to connect the girders at the corners. The inner edges of the Plates are supported by means of four $12\frac{1}{2}$ " Angle Girders, and these are utilised

also for carrying the lower Flanged Disc of a Roller Bearing. The complete base is carried on four bogies, each of which is $5\frac{1}{2}$ " long and is fitted with two large Flanged Wheels. Each bogie is attached by means of two Girder Frames to a bracket consisting of two Flat Trunnions secured to the crane base by means of two $1\frac{1}{2}$ " Angle Girders. One wheel of each bogie is driven by Sprocket Chain, which passes round $1\frac{1}{2}$ " Sprocket Wheels carried on an $11\frac{1}{2}$ " Rod mounted transversely on the underside of the base. The Rod is driven by two $1\frac{1}{2}$ " Bevels, one of which is secured to the Rod and the other to a vertical $3\frac{1}{2}$ " Rod passing through the centre of the Roller Bearing.

The base of the revolving superstructure is composed of two channel section girders, each built up from two $18\frac{1}{2}$ " Angle Girders secured edge to edge by two $9\frac{1}{2}$ " Flat Girders. The two channel girders form the long sides of the base and they are secured together by two $5\frac{1}{2}$ " Girders of similar section, one of which is bolted to each end of the longer Girders. The oblong frame so formed is bolted to the upper Flanged Disc of the Roller Race so that it overhangs on one side only. Each rear side of the frame carries a built-out platform $12\frac{1}{2}$ " long and projecting $3\frac{1}{2}$ ". One of these is equipped as a control platform, and the other carries a long hut in which a section of the gear-box is enclosed. The "A" frames are built up from six $18\frac{1}{2}$ " Angle Girders and support the Pulleys over which the hoisting and luffing cords pass.

The jib is pivoted on a Rod carried in the front portion of the "A" frames and is constructed in the form of a "V," the first section being $19\frac{1}{2}$ " long and the upper section $25\frac{1}{2}$ " long. Suitable bracing is provided by Strips of various lengths. At the junction of the two sections of the jib the framework carrying the Rod of the head Pulleys is bolted in place. The Rod on which the head Pulleys rotate also has two extra $1\frac{1}{2}$ " loose Pulleys secured to it, and these form guides for the two hoisting cords, one of which is used for the grab and the other for the pulley block. The jib is prevented from swaying by a set of chains on each side, the upper ends of which are attached to the jib. The lower ends are secured to the "A" frames,

General view of the Hoisting and Grabbing Crane described here. The gear-box and controls are shown in a plan view at the foot of the page.

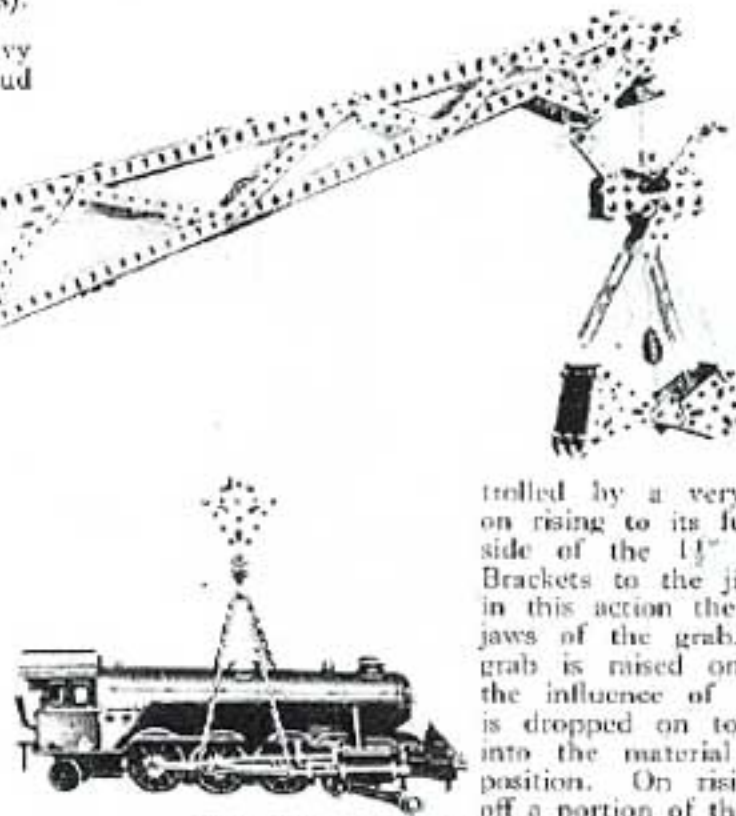

and screw tension members are provided to maintain the jib in a central position.

Two further sets of pulleys are provided, one being situated mid-way along the upper section and the other at the outer extremity of the jib. The first of these is fitted with three $1\frac{1}{2}$ " Loose Pulleys that support the block hoisting cords, while the Pulley at the outer-end of the jib carries the grab cord. The pulley tackle is similar to Standard Mechanism No. 32 and the grab is identical to that used on the Meccano Super Model Grabbing Crane. This type of grab is operated by one cord only, the four movements necessary for filling and emptying it being controlled by a very ingenious claw mechanism. The grab on rising to its fullest extent forces its two claws one each side of the $1\frac{1}{2}$ " Pulley that is secured by $\frac{1}{4}$ " \times $\frac{1}{4}$ " Angle Brackets to the jib head. The grab is then lowered and in this action the claws catch on the Pulley and open the jaws of the grab. In order to disengage the claws, the grab is raised once more and the claws fly apart under the influence of the two short springs. When the grab is dropped on to the material to be lifted the jaws bite into the material and the claws snap into their original position. On rising, the jaws close and the grab carries off a portion of the material.

The main gear-box, which is capable of five distinct movements, is enclosed between the sides of the swivelling superstructure. The power unit is an electric motor and the drive is transmitted by a Spring Cord belt to a clutch shaft, on which is mounted a single plate clutch of a similar type to that used in the Meccano Motor Chassis.

The six levers shown on the rear side of the model actuate the various gear trains. The lever nearest the left-hand side controls a two-speed gear-box and close to this a clutch pedal is situated. The next three levers control the slewing, luffing and travelling movements respectively, and the two levers at the outer edge of the control platform engage or disengage the two hoisting movements as required. Owing to the fact that all the controls are centralised in this way the operation of the crane is greatly simplified.

There are many types of gear-boxes suitable for a crane of this kind and experienced model-builders should have little difficulty in designing one to meet their requirements. Those who are not familiar with complicated mechanisms will find the Standard Mechanisms Manual of great assistance for it contains several examples of gear arrangements, clutches and traversing mechanisms that can be built into almost any kind of model crane.

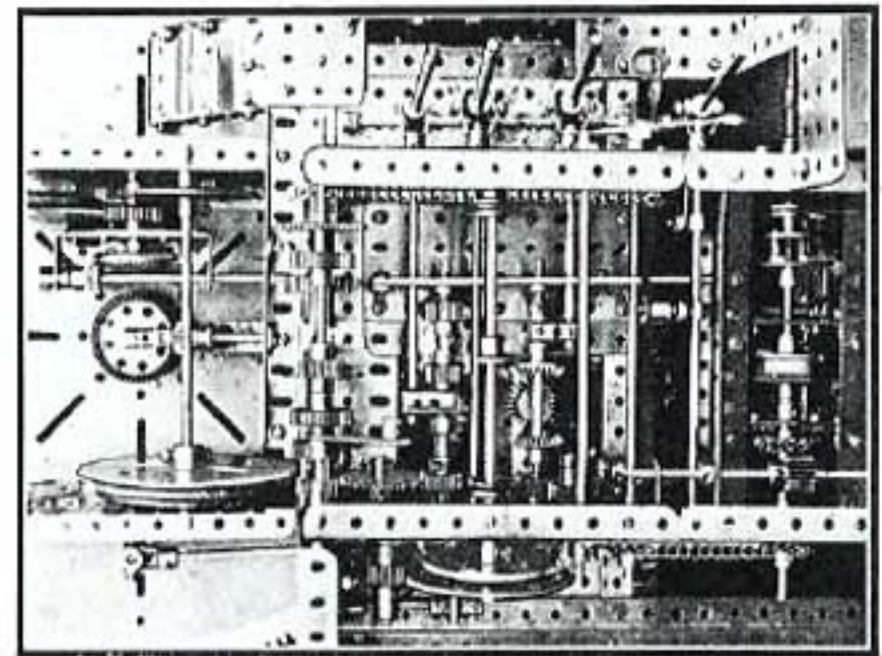

Model No. 46. 350-ton Floating Crane.
(A. Campbell, Exmouth).

This fine model is based on one of the world's largest cranes, a 350-ton monster built at the works of Cowans, Sheldon and Co., Ltd., of Carlisle, and owned by Mitsubishi Shoji Kaisha Ltd., of Japan. This crane is capable of lifting tremendous loads through a vertical distance of 140' and its safe working radius is 120' from the crane pivot. An auxiliary hoisting block for small loads is provided and with this it is possible to raise loads of 50 tons through a distance of 200'. The actual crane is equipped with a navigating bridge and all the fittings necessary for a sea-going vessel. These fittings do not appear in the model.

The jib of the model is built from Angle Girders and is counter-balanced by a heavy weight at the rear. Luffing is done by means of two vertical screws. A modified form of screw gear that might be used in a crane of this kind is described in the Standard Mechanisms Manual under item S.M. 181.

The entire centre of the base is occupied by a gear-box controlled by three levers placed close together. These levers control the slewing, hoisting and luffing movements, all of which are operated from a Meccano 6-volt Motor that is supplied with current from a 6-volt 20 amp. Accumulator. The Accumulator is enclosed in a neat housing so that the revolving portion of the crane forms an entirely self-contained unit.

The crane pivot consists of a number of 1/2" Flanged Wheels mounted on the underside of the revolving structure and running on a built-up circle of Channel Segments. The lower section of the roller race is bolted to a pontoon 4' long and 2' wide. This section of the model must be very strongly built in order to withstand the weight of the great jib and superstructure.

The appearance of the model may be improved by the addition of deck fittings and a navigating bridge. These form a very necessary part of the equipment of the actual crane, for it must be remembered that it is sometimes necessary for it to undertake long voyages entirely under its own steam.

The bridge is raised more than 20' above the level of the deck in order that it may be clear of high waves and it carries all the necessary navigating equipment, including a powerful searchlight.

A model of a 350-ton Floating Crane.

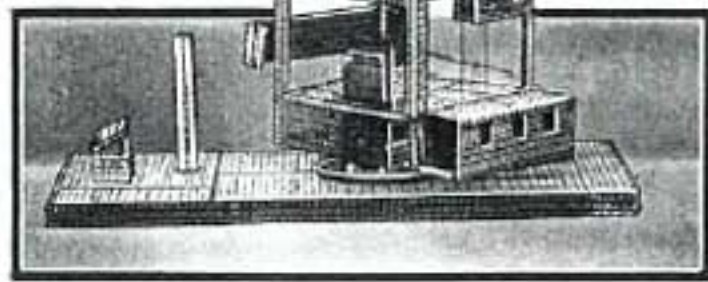

Model No. 47. "Mammoth" Crane. (P. Banks, Dunstable).

The prototype of this model is the well-known "Mammoth" crane, owned by the Mersey Docks and Harbour Board. It was built in Holland and was towed to the River Mersey without the jib being dismantled.

Those who are familiar with the actual crane will realise that the Meccano model illustrated below is a faithful reproduction of the original. The massive proportions of the actual crane are well copied, and many new uses for Meccano parts will be found in the construction.

There are two main and two auxiliary hoists as in the original, and the jib is raised and lowered by a very efficient screw mechanism. All movements of which the crane is capable are controlled from a central gear-box situated in the base of the revolving portion of the crane, and an Electric Motor supplies the necessary motive power. The operation of the various lay shafts is carried out from one point and in this way the manœuvring of the crane is greatly simplified.

The crane pivot is of very massive construction. It is 7 1/2" square and the rollers and roller races on which the superstructure swivels are built from Circular Plates and 1/2" Flanged Wheels, the complete unit

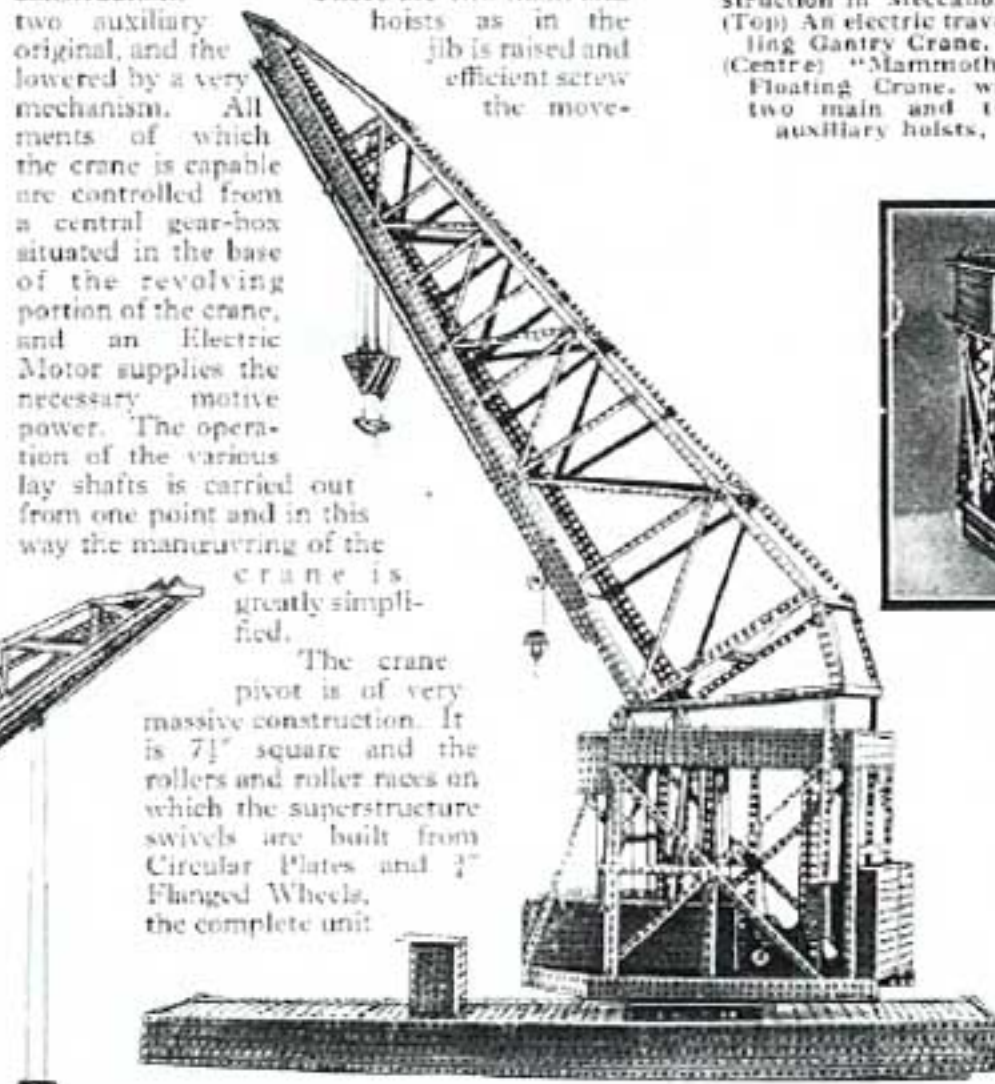

being secured to a pontoon that is of considerable strength although not built to correct scale. The pontoon contains about ninety 12 1/2" Strips, and although watertight compartments, which are a feature of the real crane, are not included, strong internal bracing gives the rigidity necessary for supporting the great weight of the jib. Details of a suitable gear-box for the model will be found in the Standard Mechanisms Manual.

Model No. 48. Gantry Jib Crane.
(J. Willems, Antwerp).

This model is of special interest because of its remarkable neatness and the novel manner in which the Meccano parts are utilised. A good example of this is found in the gantry, where 12 1/2" Braced Girders have been used in order to give the legs the massive appearance they have in the actual crane. The gantry is 24 1/2" in length and travels on eight 1 1/2" Flanged Wheels, four of which are driven.

Two remarkable examples of crane construction in Meccano. (Top) An electric travelling Gantry Crane. (Centre) "Mammoth" Floating Crane, with two main and two auxiliary hoists.

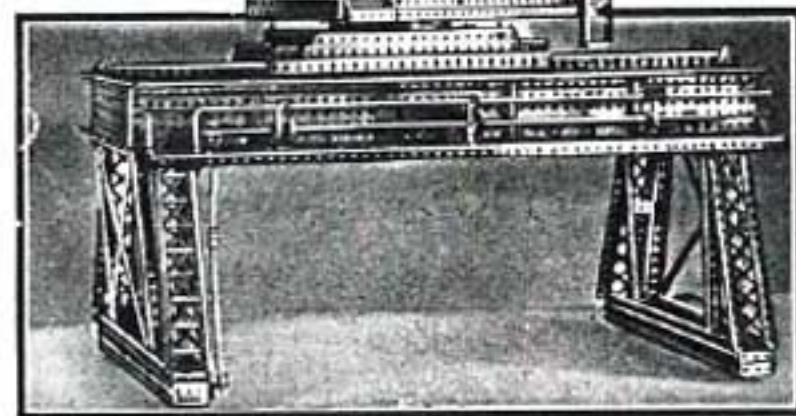

The jib is built up from 2 1/2" Angle Girders and is 5 1/2" square at the base, the head tapering off almost to a point. Luffing of the jib is carried out by an ingenious link motion on each side of the jib, the links being operated by Threaded Rods. The sides of the jib are braced by diagonal and vertical tension members, but the underside and top are fitted only with evenly spaced cross members. The appearance of the jib is improved by the addition of a hand-rail built up from Rods and secured to the jib by Threaded Pins.

The drive to the travelling wheels of the gantry enables the entire crane to travel along the ground independent of the position of the crane on the gantry.

The gear-box is driven by an Electric Motor, and the five movements of the crane are controlled from one point. A separate control lever and quadrant frame is provided for each movement, and these, together with brake and motor reversing levers, are mounted in an impressive array on a central control platform. It will be noticed that cardboard painted in panels is used for the cabin sides, giving a very finished appearance to the model.

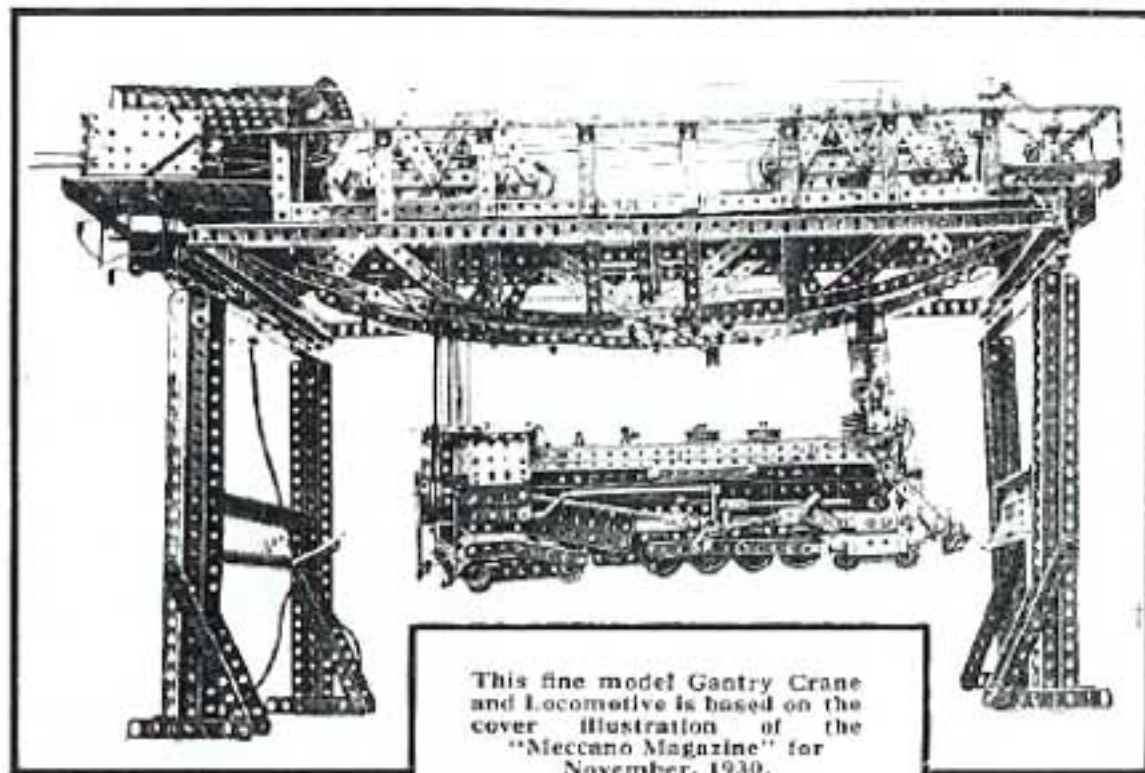

This fine model Gantry Crane and Locomotive is based on the cover illustration of the "Meccano Magazine" for November, 1930.

Model No. 49. Gantry Crane and Locomotive. (E. Whalley, Blackburn).

The large girder of the crane from which the locomotive is suspended is constructed from Angle Girders, Flat Girders and Strips, as follows. First, two $2\frac{1}{2}$ " Angle Girders are bolted side by side to two $12\frac{1}{2}$ " Flat Girders. Then two $12\frac{1}{2}$ " and one $3\frac{1}{2}$ " Flat Girders are bolted together in one length, and the extended girder thus formed is bolted in turn, in the form of a bow, to each end of the $2\frac{1}{2}$ " Angle Girders. This bow-piece is then strengthened by a number of $2\frac{1}{2}$ " Flat Strips. Two of these built-up girders are placed side by side, $5\frac{1}{2}$ " apart, and are connected at their ends by means of Angle Girders, Plates, and Strips.

The crane gantry is fitted with two separate crabs, each of which is $9\frac{1}{2}$ " long and is mounted on four large Flanged Wheels, two being allotted to each end of the structure. Two separate pulley hoists are carried by each crab and each of the four blocks may be operated simultaneously or separately as desired. Each pulley system consists of two double sheave pulleys, one of which is fixed to the crab and the other to a cross beam. This cross beam couples together the two hoists fitted to each crab and is built in the form of an "H" section girder, from four $7\frac{1}{2}$ " Angle Girders.

The movements of the model are all controlled from one main gear-box situated at one side of the crane gantry. The power is derived from a Meccano Electric Motor, the speed of which is controlled by a rheostat. The drive from the Motor is transmitted through suitable gears to a master shaft from which it is taken to the secondary gear trains. The three traversing movements are controlled by three horizontal gear levers and the four hoists are fitted with four independent and one master lever. Thus each pulley block may be raised or lowered separately or, by moving the master lever, all four may be thrown in engagement at the same moment.

The model C.N.R. engine is of the 4-8-4 type. The boiler is made from three curved $5\frac{1}{2}$ " \times $3\frac{1}{2}$ " Flat Plates, and a $5\frac{1}{2}$ " Flat Girder bolted to an Angle Girder forms the running board. The chimney stack is built up from four 1" loose Pulley Wheels bolted to the top of the smoke-box.

Current is conveyed to the 6-volt Electric Motor by two lengths of flexible wire, each of which is insulated from the other and also from the model.

Model No. 50. "Demag" Floating Crane. (K. Holland, Liverpool).

Each side of the hull of the model is built up from three $12\frac{1}{2}$ " Braced Girders with the addition of nine $12\frac{1}{2}$ " Strips, two above and one below each Braced Girder. The main deck is filled in with Flat Plates, the centre portion containing eight $5\frac{1}{2}$ " \times $3\frac{1}{2}$ " Flat Plates and three $5\frac{1}{2}$ " \times $2\frac{1}{2}$ " Flat Plates, flanked at each side by two $5\frac{1}{2}$ " \times $2\frac{1}{2}$ ", one $2\frac{1}{2}$ " \times $2\frac{1}{2}$ ", and one $5\frac{1}{2}$ " \times $3\frac{1}{2}$ " Flat Plates.

The after portion of the main deck consists of two $5\frac{1}{2}$ " \times $2\frac{1}{2}$ " Flanged Plates and two $3\frac{1}{2}$ " \times $2\frac{1}{2}$ " Flanged Plates, and the irregular space in the stern is filled in with three $2\frac{1}{2}$ " \times $2\frac{1}{2}$ " Flat Plates and one $2\frac{1}{2}$ " Triangular Plate. The sides of the top deck are composed of two $9\frac{1}{2}$ " Braced Girders, and the deck itself is constructed from two $5\frac{1}{2}$ " \times $2\frac{1}{2}$ " Flanged Plates butted together by their flanges.

The crane crab consists of a $3\frac{1}{2}$ " \times $2\frac{1}{2}$ " Flanged Plate with Windmill Soils for the sides and $2\frac{1}{2}$ " Flat Girders for the ends, and is mounted on four $\frac{7}{8}$ " Flanged Wheels that travel on rails formed from Angle Girders bolted to the upper surface of the bridge structure. A three-sheave pulley block formed from three 1" loose Pulleys mounted on a short Rod journaled in a Channel Bearing, is bolted to the underside of the crab.

The device for gripping the concrete block comprises four $1\frac{1}{2}$ " Strips secured in pairs by their centre holes to two Cranked Bent Strips bolted to Double Bent Strips, which in turn are bolted to the underside of the balancing beam. Spring Cord is used to hold open each pair of $1\frac{1}{2}$ " Strips so that they grip the sides of the holes in the concrete block. The crab is traversed by an endless length of Sprocket Chain, which runs over a 1" Sprocket Wheel at each end of the Bridge.

Motive power is supplied by an Electric Motor. A $\frac{1}{2}$ " Bevel on one end of the Motor armature shaft engages a $1\frac{1}{2}$ " Bevel on a short Rod on which is wound the hoisting cord.

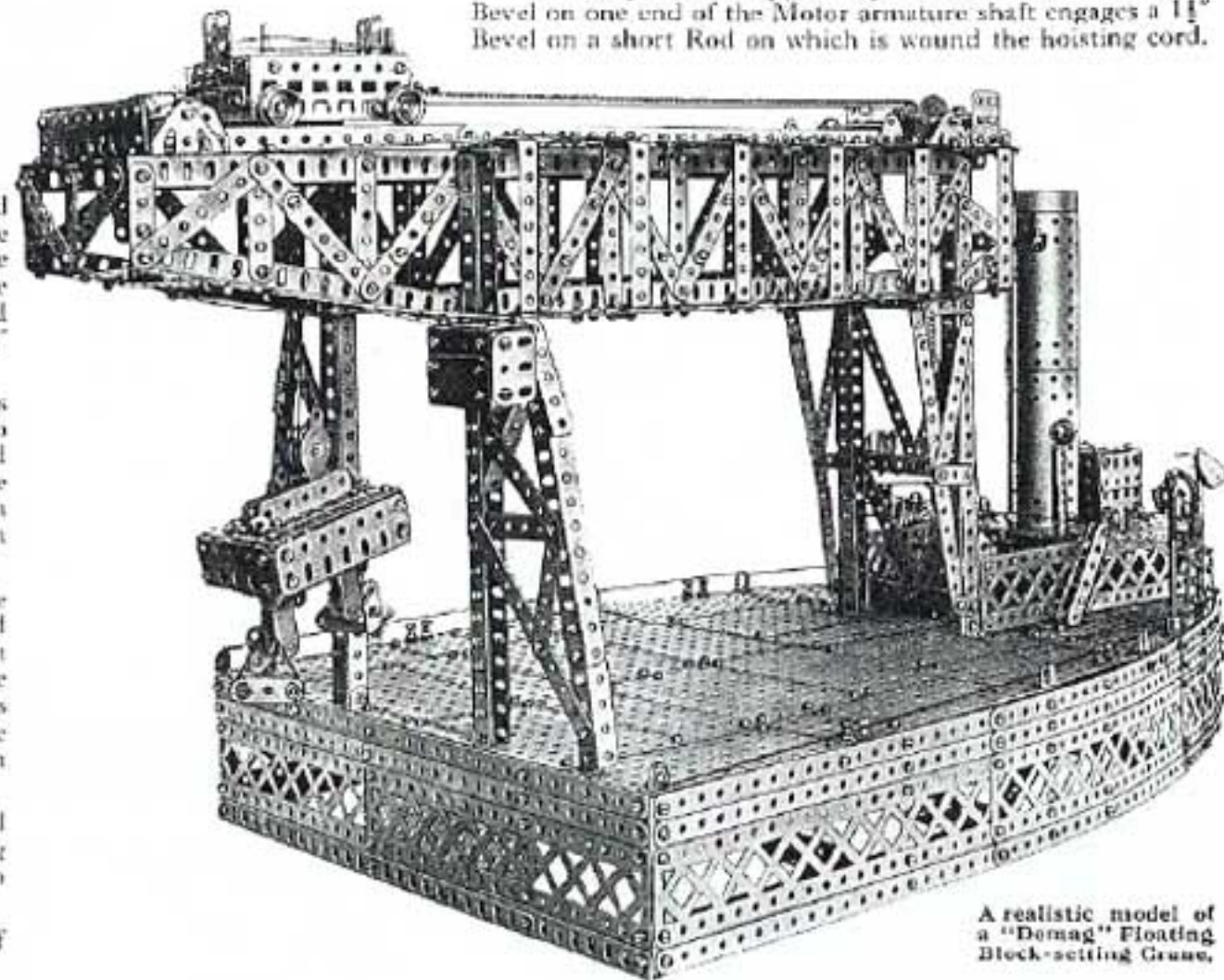

A realistic model of a "Demag" Floating Block-setting Crane.

Model No. 51. Electric Travelling Crane. (N. Batchelor, Westcliff-on-Sea).

This model represents an electrically operated travelling crane capable of handling loads up to 25 tons. It is fitted with a 6-volt Electric Motor and will lift 22 lb. with ease.

The travelling gantry is of very robust construction, Angle Girders being used throughout, and it is mounted on four bogies each fitted with four wheels, two of which are driven. The drive is supplied by a Motor mounted in the swivelling superstructure, and is passed through the central pivot, to be transmitted to the travelling wheels by Bevel Gears and Universal Couplings. A ladder is fitted at one corner and consists of 12½" Strips with 1" Screwed Rods secured in each hole to serve as rungs. At the upper extremity of the ladder is a miniature "gallery," as in the actual crane, to enable the operator to reach the control gear. To form the gallery 3" x 1½" Flat Plates are secured to 12½" Strips and attached by ½" Reversed Angle Brackets to the gantry. A Handrail runs the entire length of the gallery, and consists of a length of heavy gauge wire held by Nuts to vertical 1" Screwed Rods.

The superstructure rotates on a geared Roller Bearing Unit and is constructed from 18½" and 7½" Angle Girders secured at each end to 1½" Angle Girders forming the corner members. Flat Girders are used to fill in the sides of the frame so formed, and Flat Plates cover the floor.

The jib is formed from 18½" and 12½" Angle Girders braced with Strips. Axle Rods pivotally attached to the jib head carry the Pulleys for the luffing cords, and a short Rod journalled between two 3½" Flat Girders is fitted with Pulleys from which the pulley block is suspended.

A model of 25-ton Electric Travelling Crane. It is driven by an Electric Motor and will lift a load of 22 lbs.

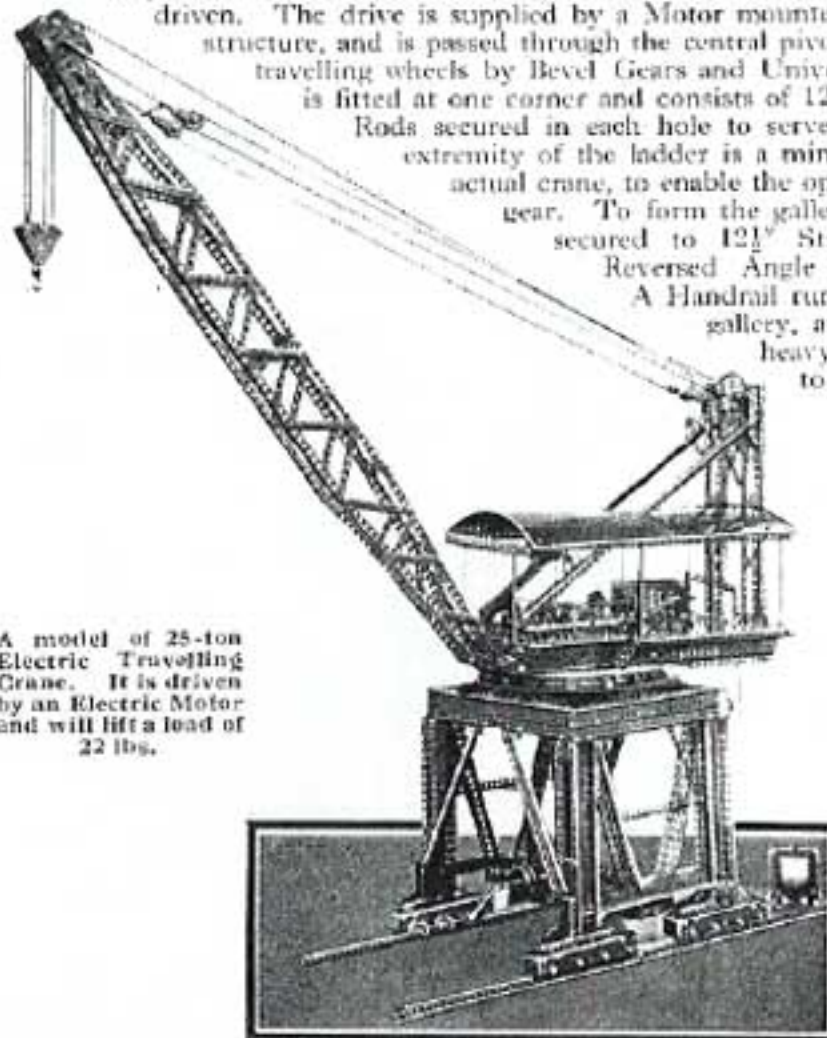

This is built up in the usual manner from 2½" Triangular Plates.

The gear-box sides consist of 7½" Flat Girders bolted with the elongated holes downward, the upper holes forming the bearings for the rotating shafts. The gear-box is of the constant-mesh type, Socket Couplings fitted with clutches being used for bringing the different movements unto operation. Contrate Wheels (¾" diameter) are found more effective than Dog Clutches for this purpose as they engage quicker. They occupy more space, however, and for this reason Dog Clutches are used where space is limited. The hoisting barrel is fitted with a two-speed gear so that light loads can be dealt with quickly. A band brake, consisting of a loop of cord wound round a 1½" Pulley, is fitted on the drum and is operated by means of a handwheel and screw mechanism. The levers controlling the various movements are neatly grouped together, and the motor reversing switch is coupled up by a connecting rod and Cranks to a conveniently placed handlever.

The entire cab and gear-box is roofed in, and for this purpose four Axle Rods are mounted vertically on each side of the model to support a framework of Angle Girders. Sheet metal is cut to the required size and bolted to these, but there is no reason why standard Meccano parts should not be used instead.

Current for the Motor is supplied by a Transformer, and to prevent the wires from becoming entangled, owing to the swivelling of the superstructure, a collector ring should be

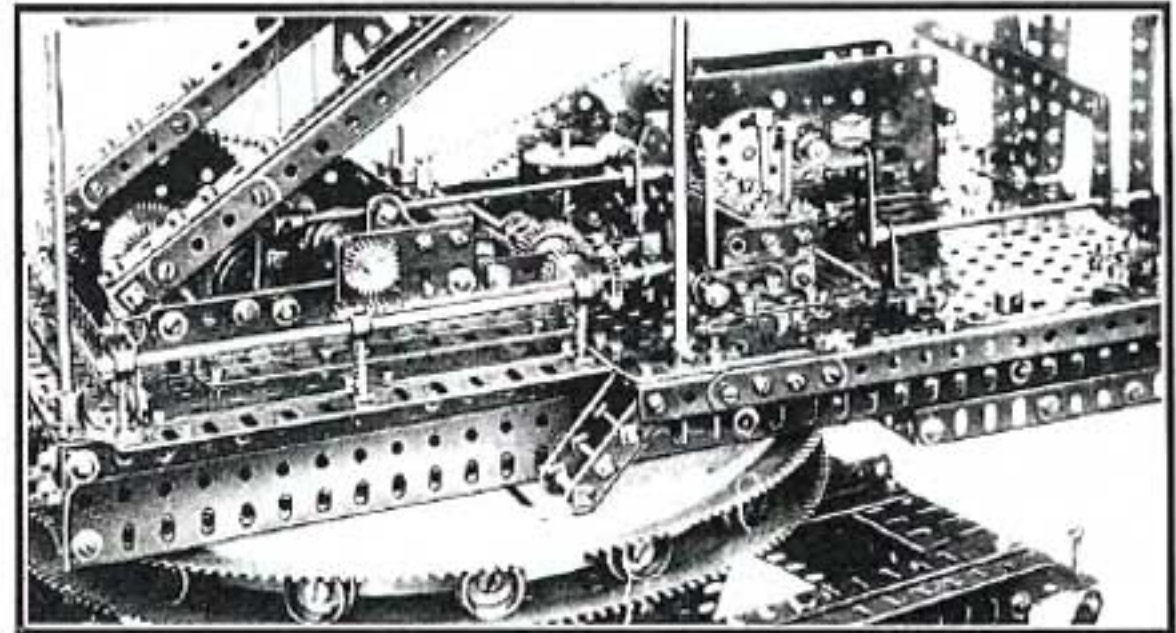

fitted. This need only consist of Strips bent to form a circle and insulated from the gantry. A suitable collector attached to the rotating part should press lightly on the edge of the Strips, and should be connected to one of the Electric Motor terminals. The other terminal should be "earthed," that is, connected to the frame, and one of the Transformer terminals must also be "earthed." The other Transformer terminal should be connected to the collector ring.

Model No. 52. Grinding Mill and Water-wheel.

(Michel Montu, Levallois Perret).

The water-wheel consists of two Hub Disks secured to a Rod by means of Face Plates bolted to their centres. The Disks are joined together by 1½" Angle Girders that form the water blades. The grinder is represented by a 3" Pulley Wheel shod with a Rubber Ring and secured to a Rod journalled in a Coupling as shown. The Pulley runs on a 3½" Gear Wheel that forms the bed of the mill and is secured to a Rod journalled in the longitudinal bore of the Coupling already mentioned.

When the water-wheel is rotated its motion is transmitted to the grinder by means of a gear on the axle of the wheel. This Gear engages a Contrate secured on a Rod fixed in the transverse bore of the Coupling, in which the Rod of the 3" Pulley is also fixed. The various Rods in the mechanism are provided with bearings in the manner shown in illustration. A very realistic effect is obtained by placing a number of Meccano Miniature Sacks in the interior of the mill as shown.

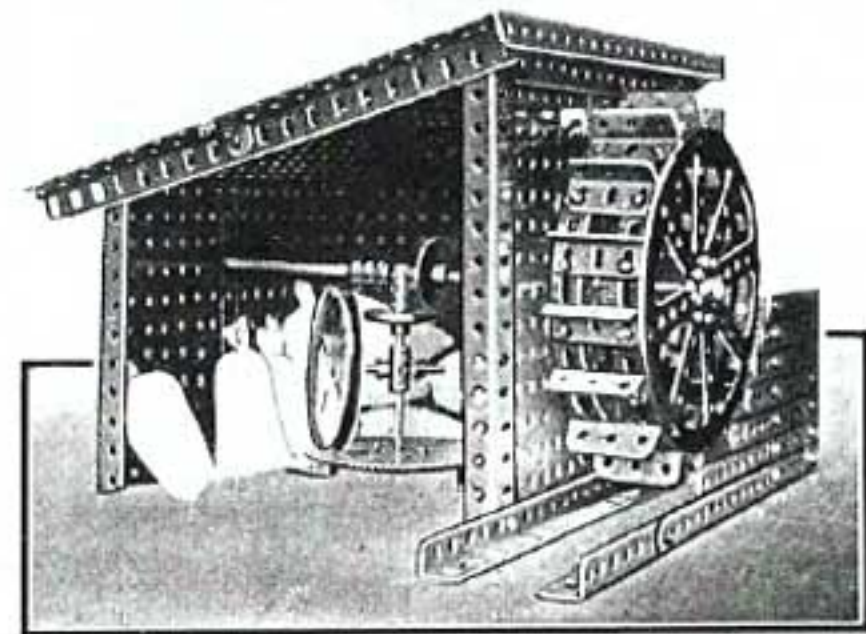

Model No. 53. 50-ton Crane. (A. M. Campbell, Exmouth).

Large cranes usually are either secured rigidly to the ground or mounted on a floating pontoon of massive proportions. The fixed cranes are generally confined to ship construction work, and the floating types have the disadvantage that they can only be used where there is a sufficient depth of water available. For such purposes as handling heavy loads in large metal storage yards and foundries, special types of travelling cranes are used, and it is one of these that forms the prototype of the fine Meccano model described here.

The crane travels on 20 wheels arranged in two rows spaced 25½" apart, and each axle is carried on a group of volute springs. The jib, which is really two separate jibs braced together, is very strong and heavy, and in order to balance it when under load nearly 100 tons of concrete is carried at the rear of the rotating base. This great mass is supported on four strong cross girders hung from the underside of the rotating base on 2" diameter steel rods.

The entire superstructure rotates on a big turntable,

the diameter of which is 30' and its total height 8'. The turntable is fitted with 48 wheels, all of which are mounted on a central ring frame. The jib of the crane is 81½' in length, and when it is fully raised the total height of the crane is approximately 110'. When in working order the crane weighs 355 tons.

The height above the rails to which a load may be lifted is 47', but a depth of 43' below the rails can be reached when lifting is

being carried out from the bottom of a ship's hold, so that the total range is approximately 90'. The lifting speed, when using low gear, is 16' per minute, but when using top gear the rate is 56' per minute. The crane makes one complete revolution on the turntable in 2½ minutes, and its travelling speed along the rails is a little over 30' per minute. All the above figures refer to the crane when carrying full load.

The motive power is supplied by five electric motors, all of which are situated in the revolving superstructure.

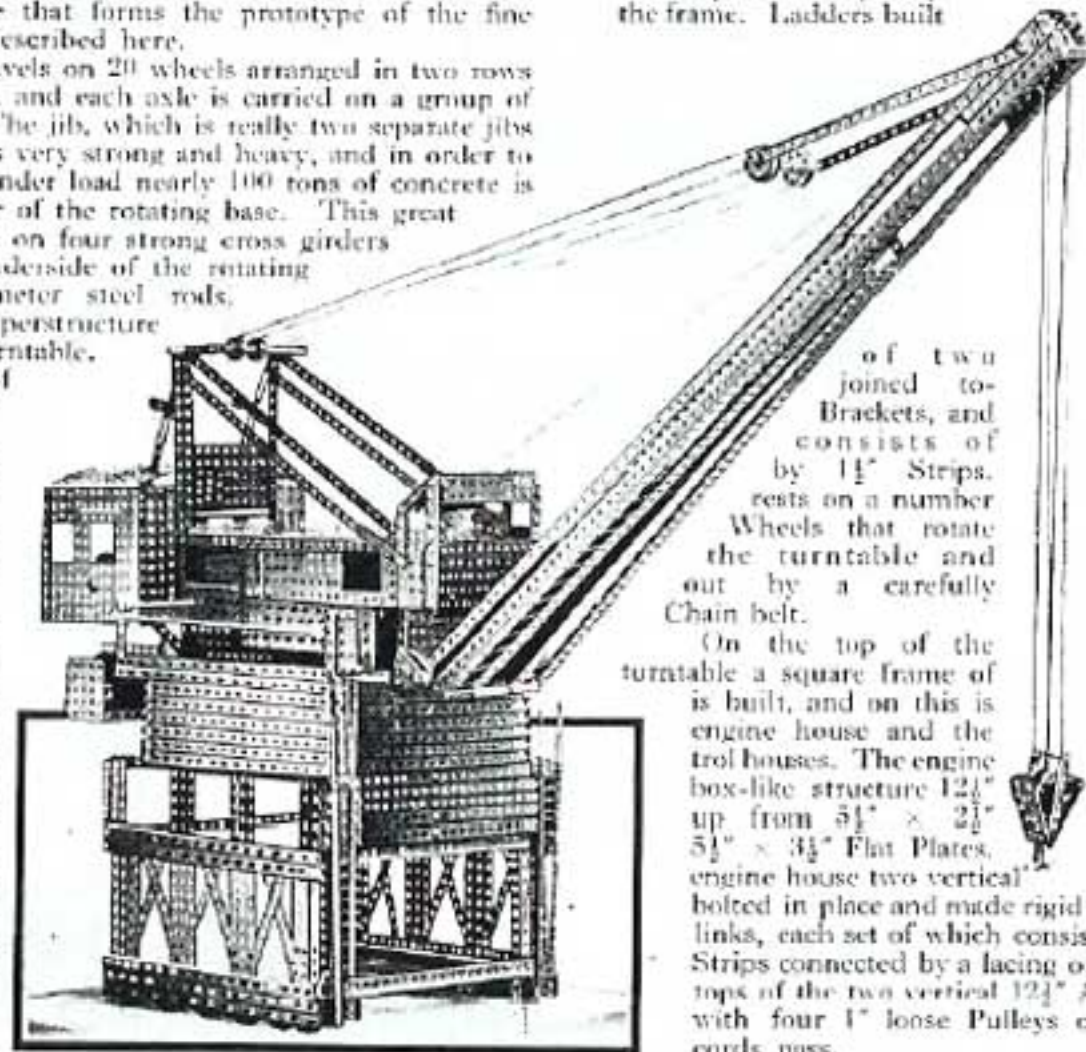

A model of a 50-ton Crane at Southampton Docks.

Two of the motors rated at 50 h.p. are used for lifting. Slewing is carried out by a 25 h.p. motor, and the jib is raised and lowered by an 80 h.p. motor. A 50 h.p. motor is used for operating the travelling movement.

Most of the important features of this fine crane are embodied in the Meccano model. The base frame of the model is 12½" square and 9" in height, and it is mounted on 12 large Flanged Wheels, six of which are fitted to each side. Each side is braced by 5½" Strips and 5½" Flat Girders. The Flat Girders are bolted together in pairs, and the columns so formed are spaced equally across the length of up from 11½" Rods and lengths of cord are fitted to each corner of the base. The Rods represent the sides of the ladders and the cord is stretched between them to form the rungs.

The lower half of the turntable consists of two hoops of 12½" Strips joined together by Flat Brackets, and consists of 1½" Strips. The upper half of the turntable rests on a number of wheels that rotate the turntable and is carried out by a carefully fitted Chain belt.

On the top of the turntable a square frame of 12½" Angle Girders is built, and on this is mounted the engine house and the trol houses. The engine box-like structure 12½" up from 5½" x 2½" 5½" x 3½" Flat Plates. At the rear of the engine house two vertical 12½" Angle Girders are bolted in place and made rigid by two sets of coupling links, each set of which consists of two 18" lengths of Strips connected by a lacing of Meccano Cord. The top of the two vertical 12½" Angle Girders are fitted with four 1" loose Pulleys over which the luffing cords pass.

The counterweight of the actual crane is represented in this model by a built-up box suspended from the ends of two 2" Threaded Rods at the rear of the superstructure. The box is built from two 5½" x 2½" Flanged Plates and two 3½" x 2½" Flanged Plates connected together in the form of an oblong structure by means of Angle Brackets. The box is filled with pieces of lead pipe in order to give the necessary weight.

The actual crane is provided with separate electric motors for each of the operations of lifting and lowering the load, slewing, luffing the jib and travelling. In the model, however, all these movements are operated by one Motor only.

Model No. 54. Breakdown Crane. (J. L. Merson, Stockton-on-Tees).

Four ½" loose Pulleys, secured by Double Brackets to an old style Circular Strip, run on the rim of a Circular Girder

bolting to the truck and support a Hub Disc to which two 5½" x 2½" Flanged Plates are fixed. These Plates form part of a rectangular framework, 12½" in length and 5½" in width, the rear portion of which carries a raised platform built up from 5½" Strips and 2½" x ½" Double Angle Strips. On this frame is mounted a Meccano Boiler, complete with Ends, which represents the steam generator of the actual crane. A small coal bunker composed of 2" Strips and 1½" Angle Girders is built close to the rear of the boiler.

The front end of the swivelling platform is fitted at each corner with a vertical 5½" Angle Girder, and these

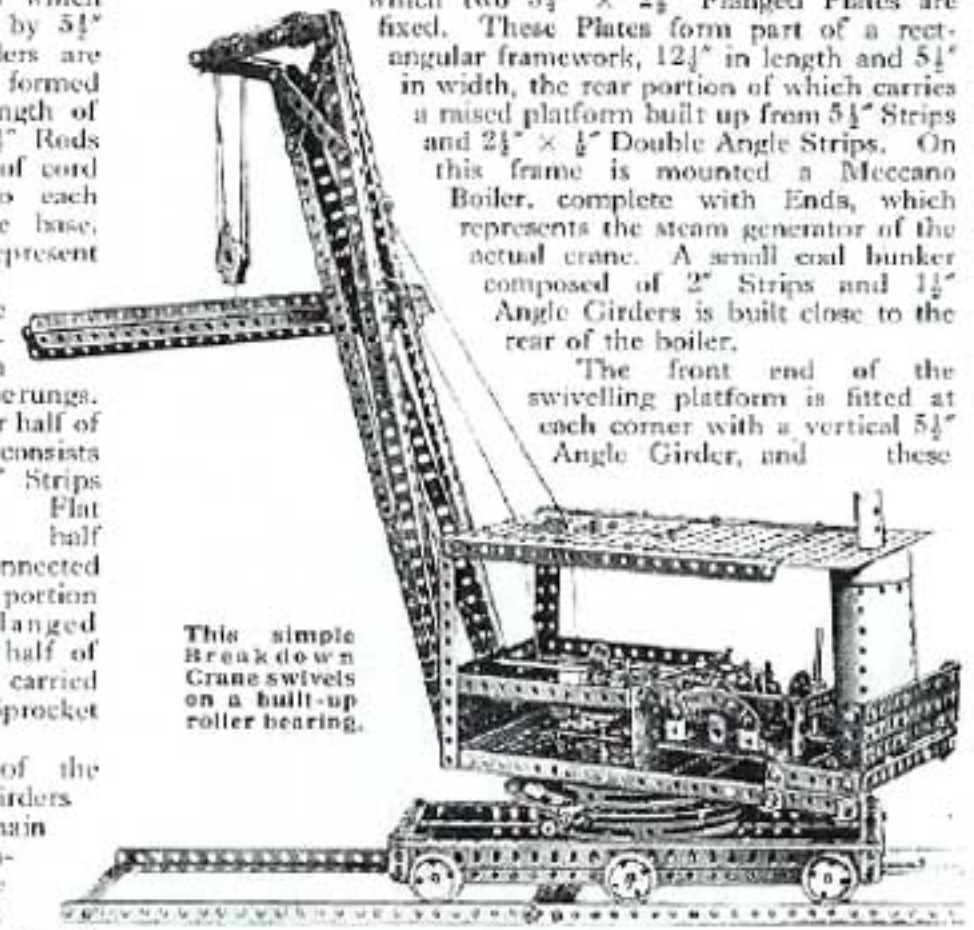

This simple Breakdown Crane swivels on a built-up roller bearing.

support the front end of the roof, the rear of which is carried on top of the boiler. The roof is built up from two 5½" x 3½" Flat Plates and two 5½" x 2½" Flat Plates, edged with two 9½" Angle Girders. The chimney of the boiler is a Sleeve Piece and is passed over a Chimney Adaptor secured to the roof. The Flat Plates of the roof are arranged so that their long sides run parallel with the sides of the roof, and a gap is left to accommodate two Pulleys, one of which guides the hoisting cord and the other the luffing cord. Both Pulleys are secured on 1" Rods carried in ½" x ½" Angle Brackets bolted to the underside of the roof.

The driving spindle of the Motor is replaced by a slightly longer Rod, and this carries a Worm that meshes with a 57-teeth Gear secured on a central lay-shaft, from which the drives for the hoisting and luffing movements of the crane are taken. The slewing motion is operated through two 1" Gears and a 1½" Contrate secured on a vertical 3" Rod. The Rod is mounted in suitable bearings, and at its lower end carries a ½" Pinion meshing with a 3½" Gear bolted by four ½" Bolts to the crane truck.

Model No. 55. Portable Grabbing Crane. (A. Bulot, Calais).

The motor chassis is 24½" long and tapers from 9½" in width at the rear to 3½" at the front. The motor, which is hidden under the bonnet, is a 6-volt Meccano Electric Motor, and the drive is transmitted through 3:1 reduction gearing and a single-plate clutch to a three-speed and reverse gear-box. A ½" Bevel Gear on the end of the driven shaft of the gear-box engages with the crown wheel of the differential, and ½" Sprockets on the differential driving shafts are coupled by Sprocket Chain to 1½" Sprockets on the back wheels, each of which is fitted with double tyres.

Approximately midway along the chassis an additional pair of wheels is fitted in order to take part of the load from the chassis when the crane is working. These wheels may be raised or lowered from the ground by means of two screw-operated Bell Cranks. Each side of the chassis is fitted with two outrigger screw jacks, which give the additional support necessary when the crane is working at right-angles to the chassis.

Between the two rear sets of wheels the chassis is plated in with two 5¼" x 3¼" Flat Plates supported on four 9½" Angle Girders. The centre of the Plates is fitted with a Ball Bearing, the lower Toothed Disc of which is spaced away from the Plates by means of four Threaded Bosses. The upper Flanged Disc of the Ball Bearing carries a square framework 15" in length and 9½" in width that is covered in with Flat Plates of various sizes. A space 5" by 2½" is left in the front of the cab, and two doors are provided in one of the cab sides.

The cab roof has a space 1½" square at the rear end to accommodate the luffing cords. Immediately over this space two 1½" Pulleys are carried in a framework of Flat Girders and Angle Girders,

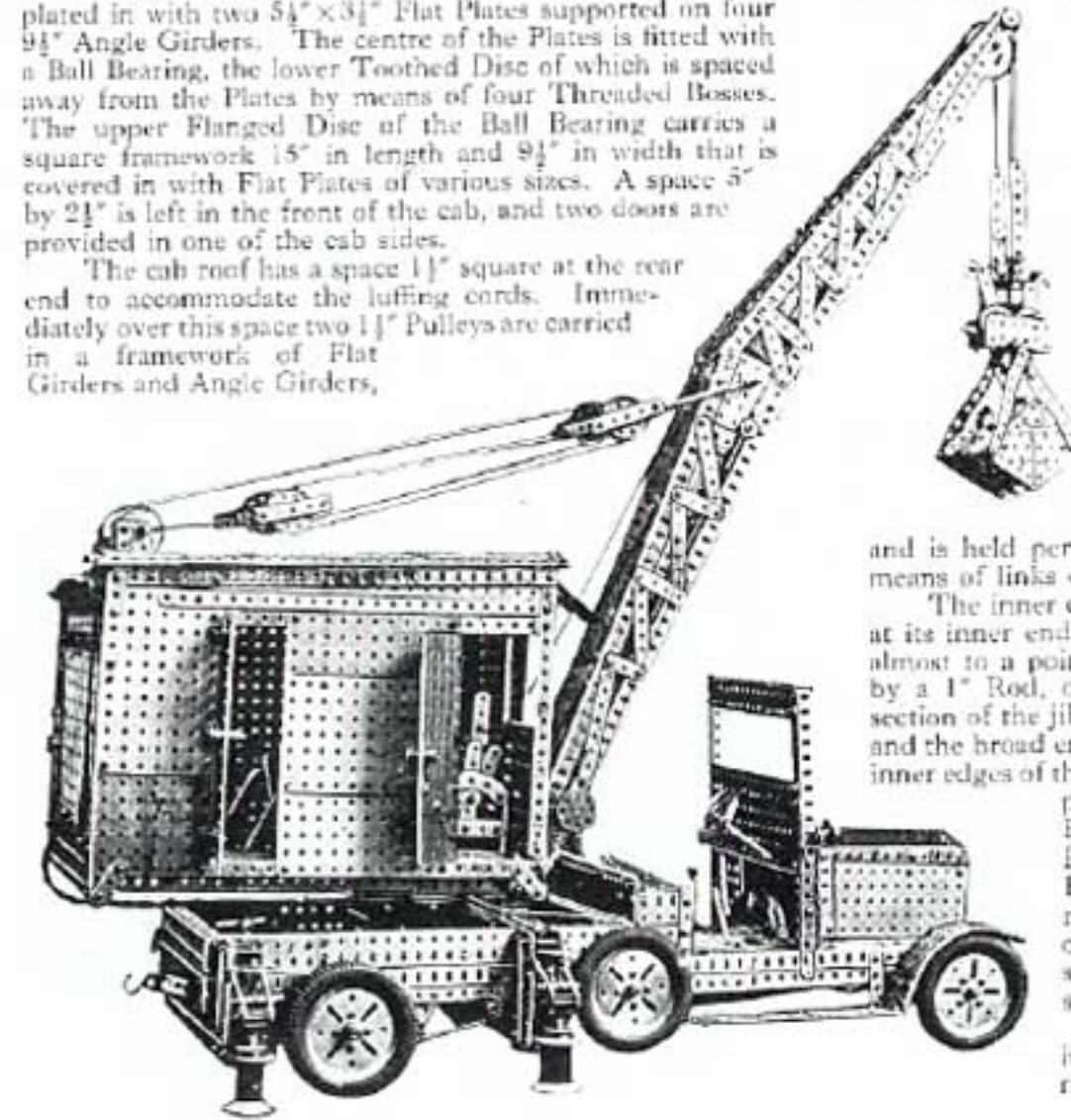

and the ends of the Rod carrying the Pulleys are each fitted with a Collar in which a 3¼" Threaded Rod is secured. These Rods are connected to a framework supporting two further 1½" Pulleys. The luffing cords pass over the Pulleys on the cab roof, over two 1½" Pulleys secured to the jib, then round the Pulleys at the end of the Threaded Rods, and are finally secured to the frame holding the two jib Pulleys.

Model No. 56. Floating Crane with Telescopic Jib. (J. Willems, Antwerp).

This model represents a unique type of floating crane with a telescopic jib. It is very powerful, and when properly constructed is capable of lifting heavy loads. The jib is carried on a sturdy superstructure built on a revolving base, the two main supports of the superstructure consisting of channel section girders built up from two 9½" Angle Girders braced to the base by means of 5½" Angle Girders diagonally disposed. The two supports are connected together by a 7½" channel section girder, and each of the 9½" Angle Girders is fitted with a second 9½" Girder, the outer end of which is attached to the base by a 5½" Angle Girder. The complete frame is suitably braced by means of 5½" Strips.

The jib is constructed in two separate sections, one of which is secured to the superstructure of the model and has the same cross-section for its entire length. It is built up from four 24½" Angle Girders joined together by 5½" Angle Girders, and the long square frame so formed is braced on two of its opposite sides with 5½" and 2½" Strips. The two remaining sides are braced with 12½" and 5½" Strips. This section of the jib is attached to the crane superstructure at one of its lower edges

and is held permanently in one position by means of links composed of 5½" Strips.

The inner or sliding section of the jib is 24½" long and at its inner end is 4½" square. At the outer end it tapers almost to a point, the two sides being connected together by a 1" Rod, on which a 1" loose Pulley rotates. This section of the jib is braced with 5½", 4½", 3½" and 2" Strips, and the broad end is fitted with eight rollers that run on the inner edges of the 24½" Angle Girders forming the stationary part of the jib. These rollers consist of ½" Flanged Wheels, and are carried on 1½" Rods mounted in the end holes of Double Brackets. The sliding part of the jib is raised and lowered by four hoisting cords operated by an ingenious lever mechanism situated at the top of the crane superstructure.

The underwater portion of the pontoon is constructed from 12½" Strips bolted to ribs formed by 5½" Curved Strips. These

are bolted to the keel, which is built up from 18½" Angle Girders. The deck space is filled in by means of 5¼" x 3¼" Flat Plates bolted to deck beams consisting of 12½" Angle Girders. The complete deck is surrounded by a low rail of 12½" Angle Girders, and on this rail 10 fairleads are provided, three at each side and two at each end. Each of the fairleads consists of a Single Bent Strip fitted with two Rods. The pontoon is equipped with four winches, each of which is constructed from two Sector Plates joined together by two 1½" x ¼" Double Strips and then secured by four 1" x ¼" Angle Brackets. The hauling drums consist of two 1½" Flanged Wheels butted

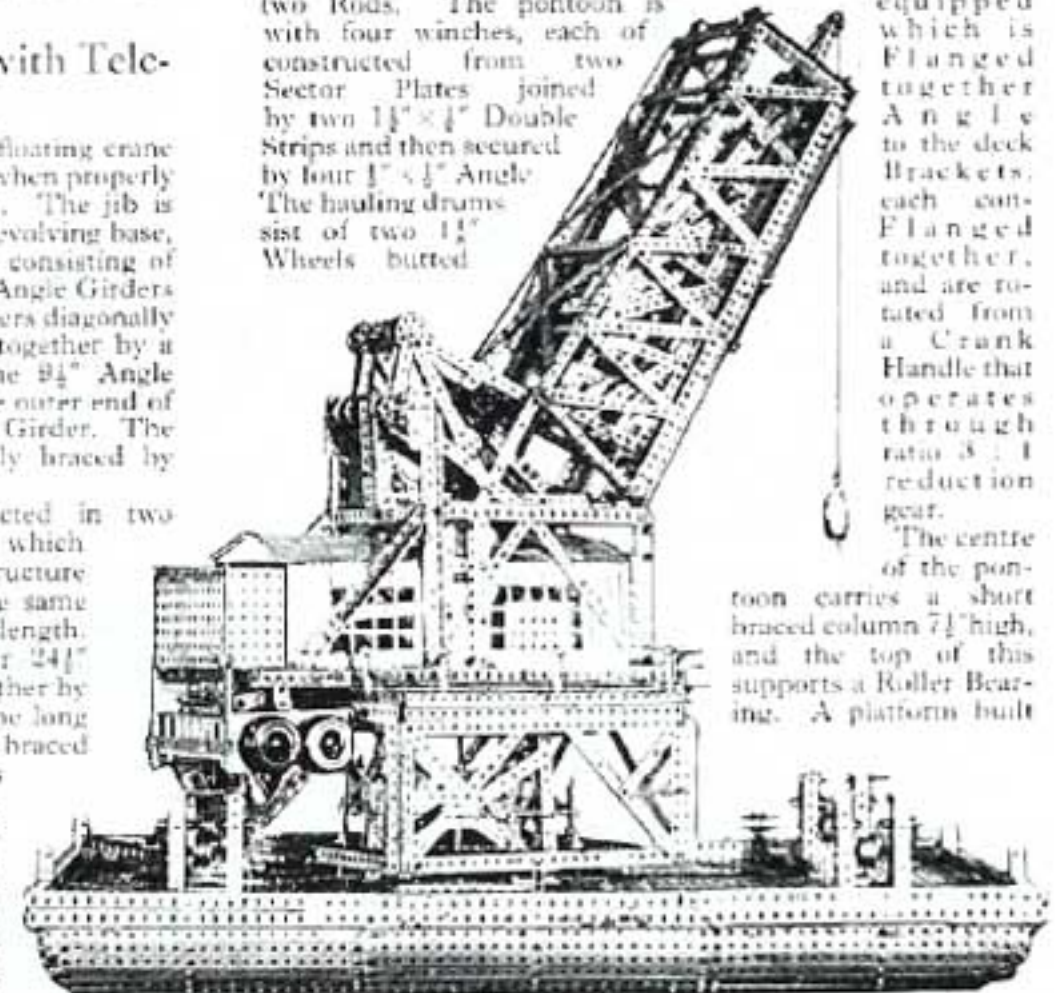

up from 5½" and 18½" Angle Girders is bolted to the upper section of this Roller Bearing, and at the rear carries a square box-like frame filled with pieces of lead and fitted outside with three electric switches, two on one side and one on the opposite side. The movements of the crane are actuated by separate Motors so that the construction of elaborate gear-boxes is made unnecessary and the control of the model is greatly simplified. The Motors are mounted on the 5½" x 18½" framework already mentioned, and are controlled by the switches on the platform. Each movement is driven by its respective Motor through a clutch controlled by a foot-pedal in the control house. The use of these clutches eliminates the use of rheostats.

The entire gear-box is covered in with cardboard, which is mounted on a framework built up from Angle Girders of various lengths. The frame is 17" in length and 3½" in height, and at the sides the cardboard is cut away to represent windows. A touch of realism is given by drawing lines on the cardboard to reproduce the effect of panelling.

Model No. 57. Two-seater Sports Car. (J. Magnussen, Oslo).

Very pleasing results can be obtained by covering the bodywork of a model car with sheet metal, and a fine example of this is shown in the front-wheel drive two-seater Sports Car illustrated on this page. The constructional details of the model have been carried out with the same care and skill as the bodywork.

The chassis is built up of strong channel section girders formed from Angle Girders, and the two side members are rigidly braced by means of Strips. An Electric Motor is mounted at the front of the chassis and a three-speed gear-box is fitted immediately beneath it. The drive from the Motor is taken through Bevel Gearing to a friction clutch, consisting of a $1\frac{1}{2}$ " Flanged Wheel and a 1" rubber-shod Pulley. The final drive to the axle is passed through a $\frac{1}{2}$ " Bevel in mesh with a $1\frac{1}{2}$ " Bevel Wheel in the differential. The $\frac{1}{2}$ " Bevel is on a short Rod attached to the final driven Rod of the gear-box by a Universal Coupling, and similar Couplings allow for the flexibility of the drive to the stub axles.

Steering is effected by a Pinion on the end of the steering column engaging a $1\frac{1}{2}$ " Contrate Wheel on the Rod of which a Crank is fixed. A Handrail Support is attached to the web of the Crank and carries an Axle Rod connected to the stub axle. Internal expanding brakes are fitted to the rear wheels, the brake drums being formed by bolting Boiler Ends to 3" Pulley Wheels representing the road wheels.

Bumpers are fitted at the front and rear, and are built up of pairs of Strips bent to the shape required. The body is attached to a framework of Strips secured to the chassis Girders, and is equipped with hinged doors, seats, windscreen with side extensions, hood, headlamps, spotlight and a tail lamp. A spare wheel is mounted on each wing, part of which is cut away to receive it, and on the luggage grid is a trunk built up from Plates and Angle Girders.

Model No. 58. Two-seater Tourer. (G. Sabajno, Milan).

The model is driven by a Clockwork Motor fitted at the rear of the chassis and the drive is taken to the back axle through Bevel Gearing. The Axle is provided with a novel form of differential to allow for the difference in speed of the two wheels when turning a corner. The complete axle consists of two Rods, one of which carries a $1\frac{1}{2}$ " Bevel taking the drive from the Motor and also a 1" Pulley fitted with a Rubber Ring. A similar rubber-shod Pulley is carried on the end of the other Rod, so that the two form a friction clutch that allows sufficient slip when turning corners, and yet transmits the drive to both wheels. The device is not so efficient as the ordinary differential gear, but it is ingenious and works quite well. To reverse the car a foot-pedal

is depressed, and this pulls over the reverse lever of the Clockwork Motor. A Spring returns the lever to its normal position as soon as the foot-pedal is released. A hand lever

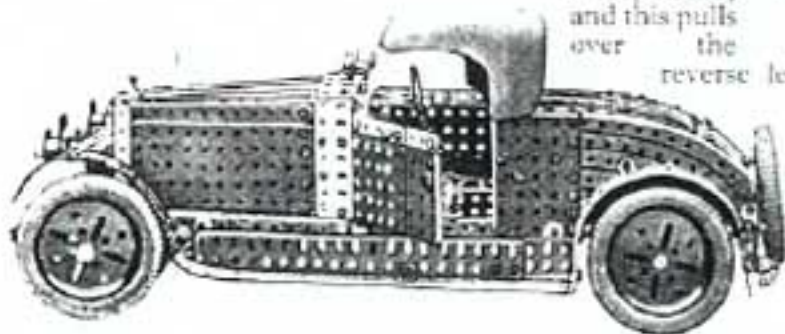

(Above) This fine Motor Fire Escape extends to a height of 9ft. (Left) Two-seater Touring Car driven by a Clockwork Motor.

applies the brake of the Clockwork Motor and is mounted in a quadrant formed from $2\frac{1}{2}$ " Curved Strips. The Strips hold the lever against the pull of a Spring attached to the Motor, which tends to keep the lever in the "off" position.

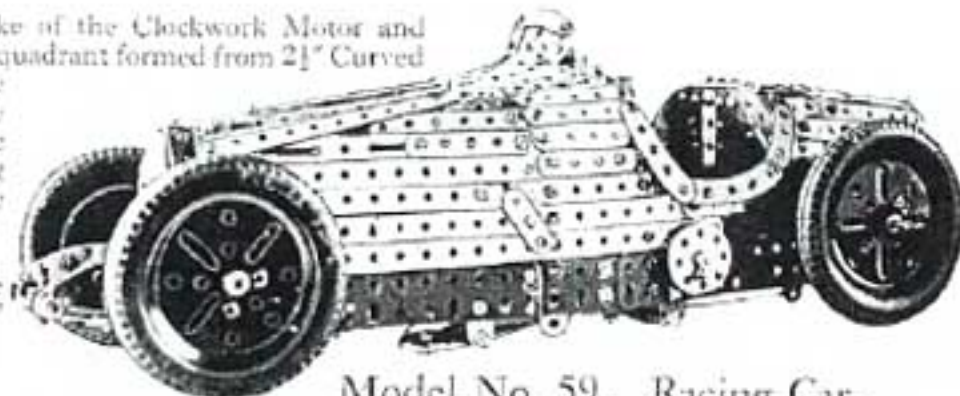

Model No. 59. Racing Car. (L. Paris, Orléans).

The racing car shown here is modelled on a typical speed car of the "baby" class. The chassis is composed of Flat Girders and Angle Girders, and is extended at the front by $2\frac{1}{2}$ " large radius Curved Strips. Semi-elliptic springs are fitted to each axle, and each spring consists of

Strips of various lengths, bent slightly and pivotally connected to the chassis by Flat Brackets lock-nutted to Double Brackets bolted to the ends of the spring. The front

wheels are controlled by Ackermann steering gear operated through Bevel Gearing. The power is supplied by a 6-volt Electric Motor, and a novel feature of the gear-box is that it is mounted transversely in the chassis and drives the back axle through Bevel Gears.

Internal expanding brakes are fitted on all four wheels, and in each case the brake drums are formed by Wheel Flanges and the slippers are mounted on a Face Plate. The rear wheel brakes are operated by a hand lever and those on the front wheels by a foot-pedal.

Strips are used for covering in the body and are bolted to a framework of transverse Strips bent to the correct shape and secured to the chassis. Curved Strips are used to form the cut-away portion round the driver's seat, and at the rear the body tapers to a point. The driver's seat is composed of Strips and a $5\frac{1}{2}$ " x $2\frac{1}{2}$ " Flat Plate is used for the floor. The bonnet can be lifted to allow access to the Electric Motor.

Model No. 60. Motor Fire Escape. (A. Robert, Johannesburg).

The chassis of this model fire escape is similar to the Meccano Super Model Chassis except that it is a little longer. An Electric Motor is housed beneath the bonnet and the drive is transmitted through a single plate clutch to a three-speed and reverse gear-box. A short cardan shaft connects the gear-box with the differential gear.

The extending escape is the main feature of the model. It is mounted on a turntable framework immediately over the rear axle, and the base of the frame consists of a Circular Plate that rotates on the $\frac{1}{2}$ " Loose Pulleys of a roller bearing. The controls for slowing, elevating and extending the ladder are mounted on this frame, and the drive for the three movements is taken from the Motor by means of Bevel Gears operating a short Rod that passes through the centre of the Roller Bearing.

The first section of the extending ladder is 40" long, and it is mounted on a triangular frame, to which it is pivotally attached by Angle Brackets and Eye Pieces. The apex of the triangle is fitted on each side with an Octagonal Coupling, and the centre threaded hole of this carries an $11\frac{1}{2}$ " Threaded Rod that is rotated by 1" Bevels at its lower end. The ladder is elevated or lowered by rotating the two Threaded Rods. The first section of the ladder also carries the hoisting drum for extending the three telescopic sections.

Model No. 61. Six-wheeled Lorry. (K. W. Ingram, Chelmsford, Essex).

This model lorry is driven by an Electric Motor and will run along under its own power if an Accumulator is placed on the platform.

Each side of the main frames is 45" long and the main girder of each consists of two 2½" Angle Girders bolted together and overlapping each other nine holes. The shape of the finished girder is obtained with the aid of a number of shorter Angle Girders, the necessary connections being shown fairly clearly in the upper photograph. The two complete side girders are connected together by short girders so that they taper slightly towards the front. The rear cross girder is 4½" long, and that at the front 3½" long.

At a point 10½" from the rear of the frames two Trunnions are fitted on each side, and these form the pivots for a Rod carrying the rear wheel compensating beams. These beams are constructed in the form of powerful leaf springs, and are pivoted at their centres by means of Double Brackets to the Rod passing through the Trunnions. The ends of the beams carry Face Plates, and in these are journalled the two rear axles. The Face Plates also form part of the brakes, which work on the internal expanding system, and are constructed in a similar manner to those incorporated in the Meccano Super Model Motor Chassis. The four brakes are coupled together by an ingenious link mechanism that ensures an even braking pressure on each wheel, and they are coupled to a hand lever by means of Boom Hauls and Cranks.

The front of the frame carries two massive semi-elliptic springs, on which the steering gear is mounted. As is the case with most petrol-driven vehicles, Ackermann steering gear is fitted, but in the model slight modifications have been found necessary owing to the position of the steering column. These alterations do not impair the working of the gear, however.

A 6-volt Electric Motor that represents the engine of the actual machine is placed directly over the front axle. Ratio 3:1 Bevel Gearing transmits the

drive to a compact single plate clutch, from which it is taken to a standard Meccano three-speed and reverse gear-box, and thence through two Universal Couplings to the differential.

This latter part of the model is carried in an enlarged framework

in order that an extra ratio 3:1 reduction gear may be incorporated.

The radiator is an almost exact replica of the original, and the typical brightly plated bending has been successfully represented by means of Spring Cord. This radiator is bolted direct to the front of the driver's cab, and the Electric Motor is placed immediately behind. The lower portion of the cab is built up from three 4½" x 2½" Flat Plates, and two side doors are fitted, each constructed from one 2½" and one 3" Flat Girder. These two Girders are bolted together edge to edge, and the unsightly extension caused by the 3" Girder is covered by means of a 2½" large radius Curved Strip. The complete doors are attached to the cab by means of Hinges. The back of the cab consists of two 5½" x 2½" Flanged Plates, and to

the top of these a 5½" x 3½" Flat Plate is bolted. This Plate forms the roof and a 3½" Flat Girder is fitted on each side. The sloping windscreen supports are represented by 3" and 3½" Strips, and the seat inside the cab is built up

from four 4½" Flat Girders. The front mudguards each consist of a 7½" Flat Girder attached to the underside of the cab by two 1" x ½" Angle Brackets.

The rear mudguards on each side of the lorry are built from 4½" Flat Girders, and are secured to the main chassis frames by means of 1" x ½" and ½" x ½" Angle Brackets.

The petrol tank is constructed from four 7½" Angle Girders and four 5½" Strips, and is secured in place by 1" x ½" Angle Brackets at a point midway between the front and rear wheels on the left-hand side of the lorry.

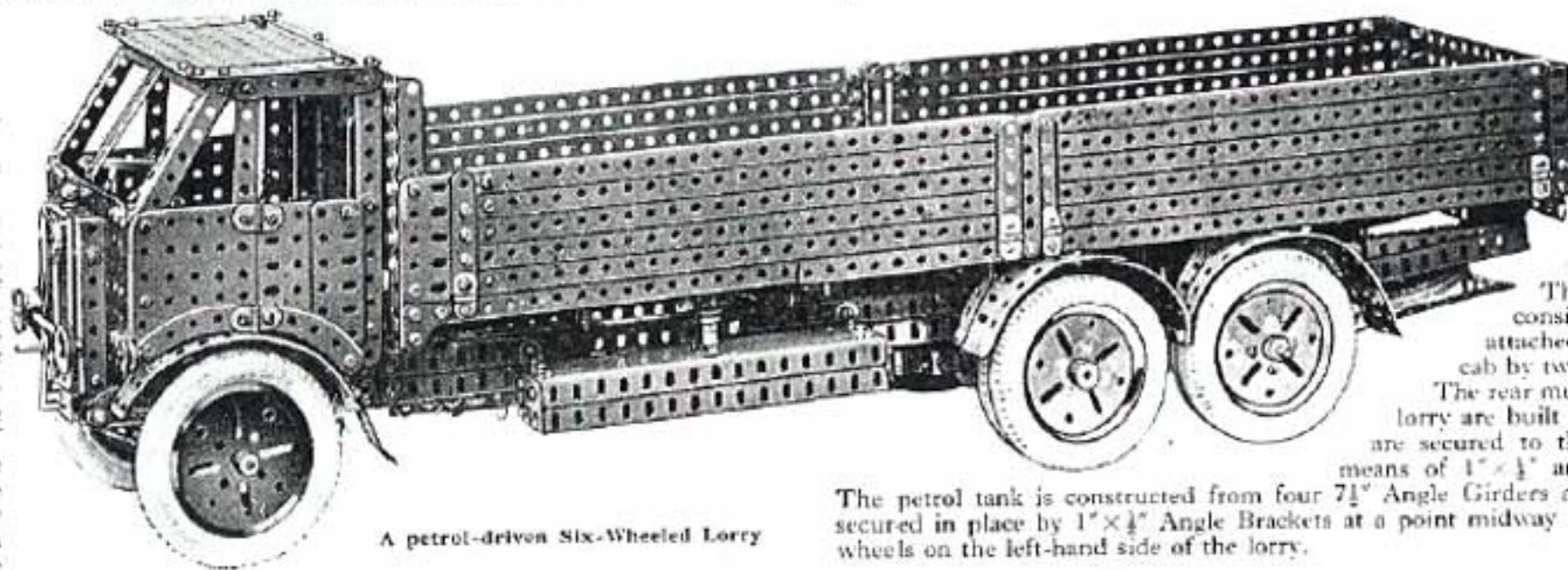

A petrol-driven Six-Wheeled Lorry

Model No. 62. Reaping Machine. (J. W. Rickett, Takeley, Essex).

In this ingenious model, 5½" x ½" Double Angle Strips secured between the side girders of the frame form bearings for a Rod carrying the driving wheel. For this wheel a Flywheel is used, and the drive from the Rod is taken through Sprocket Gearing to a secondary shaft, a 57-teeth Gear on which engages a 7" Contrate Wheel on a Rod that carries also a ½" Sprocket. A length of Chain is passed round the ½" Sprocket and also round two 1" Sprockets. One of these is on a Rod carrying Collars, the tapped bores of which are fitted with ½" Bolts that deliver the sheaves of corn. The Rod of the other 1" Sprocket has a 1½" Gear at its opposite end, the Gear being in mesh with a 1½" Contrate, on the shaft of which is a ½" Sprocket that takes the drive to the reel. This is made by bolting four 2½" x ½" Double Angle Strips radially to each of two Bush Wheels, the outer ends of the Strips being connected in pairs by 5½" Strips.

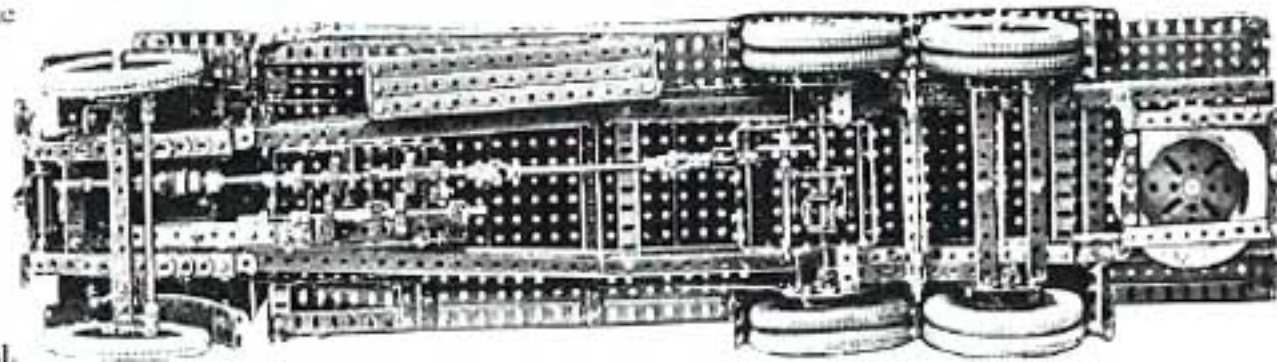

Underneath view of the Six-wheeled Lorry, showing the gear-box, clutch and differential, etc.

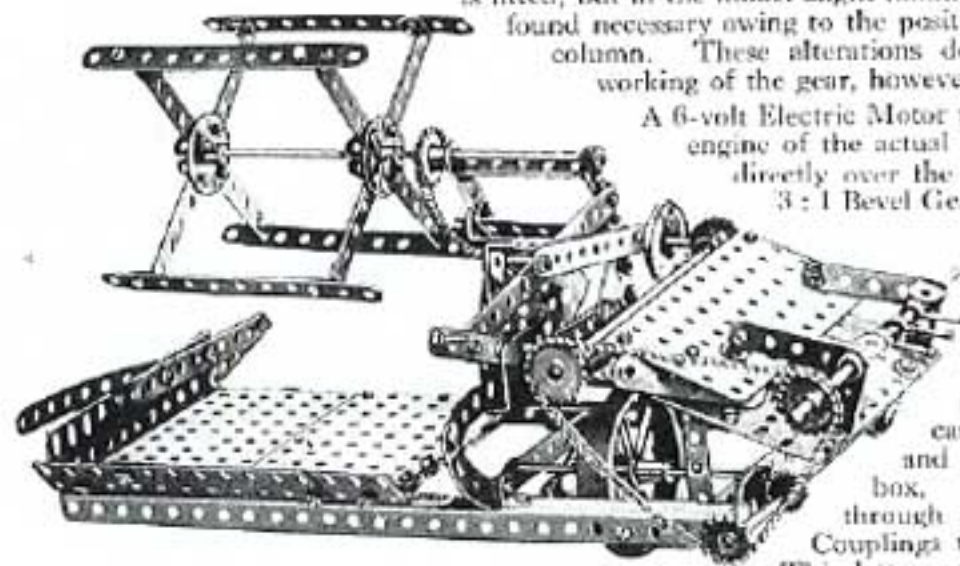

An original model of a self-binding Reaping Machine

Models Nos. 63 and 64. Eight-wheeled Tipping Steam Wagons.

(J. Hedley, Johannesburg, and C. J. McCain, Sydney, N.S.W.).

The original steam wagon from which these models have been reproduced is the Sentinel type D.G.8, which is designed to meet the demand for a large road vehicle capable of handling heavy loads without damage to the road surface. This result is achieved by dividing the weight of the vehicle and its load over eight wheels, so that the total weight is spread over a large road area and is less likely to damage the foundations. The wheels are mounted in pairs on oscillating arms to reduce vibration to a minimum.

The model shown in the bottom illustration has a chassis of very rigid construction, the side members being made of strong channel section girders built up from Flat Girders and Angle Girders. The side members are spaced apart by Angle Girders and the necessary rigidity is provided by bolting the boiler at the front and the water tank at the rear. The vertical boiler is made by bolting Strips round the rims of two Hub Discs, which form its top and bottom. To each side Gider a $5\frac{1}{2}$ " x $2\frac{1}{2}$ " Flanged Plate is secured, immediately behind the Motor, to form bearings for the gear-box. The drive passes from the gear-box to the differential on the rear driving axle, bearings for which are formed by the Flanged Plates. A $\frac{1}{2}$ " Sprocket on each end of the Axle is connected up by Chain to a Sprocket on the Rod of the leading road wheels, and another Sprocket on the same Rod takes the drive to the rear wheels. The oscillating frame in which the axles are mounted is formed from a $5\frac{1}{2}$ " Angle Girder, to each end of which a $2\frac{1}{2}$ " Strip is fitted, the two Strips being connected at the centre by a $1\frac{1}{2}$ " Strip.

All four front wheels are used for steering the model, and the steering gear works on the usual Ackermann principle. The wheels are free to rotate on their stub axles and track rods connect the corresponding pairs of wheels. The movement of the front pair is imparted to the back pair by means of a Rod pivotally connected at each end to a Crank on a vertical Rod to which the stub axle is fixed. Thus the movement of the front stub axle is conveyed to the axle behind it, the stub axles on the other side being moved through the track rods.

The other model eight-wheeled lorry illustrated differs considerably in constructional details from the model just described, and its proportions also are different. In this case Angle Girders are used for the chassis and are spaced apart $4\frac{1}{2}$ ". The spacing members protrude for $1\frac{1}{2}$ " on each side of the chassis and are used for supporting the body. The laminated springs for the axles are made of curved Strips of different lengths and the rear springs are pivoted at their ends to Flat Trunnions secured to the chassis. An 8" Axle Rod is passed through Double Brackets attached to the centres of the springs, and on this the oscillating arms are pivoted, each arm consisting of two $5\frac{1}{2}$ " Strips, between which the Axle Rods carrying the wheels are journaled.

The front compensating arms are formed from Angle Girders, and Cranks are bolted at the ends of these to form

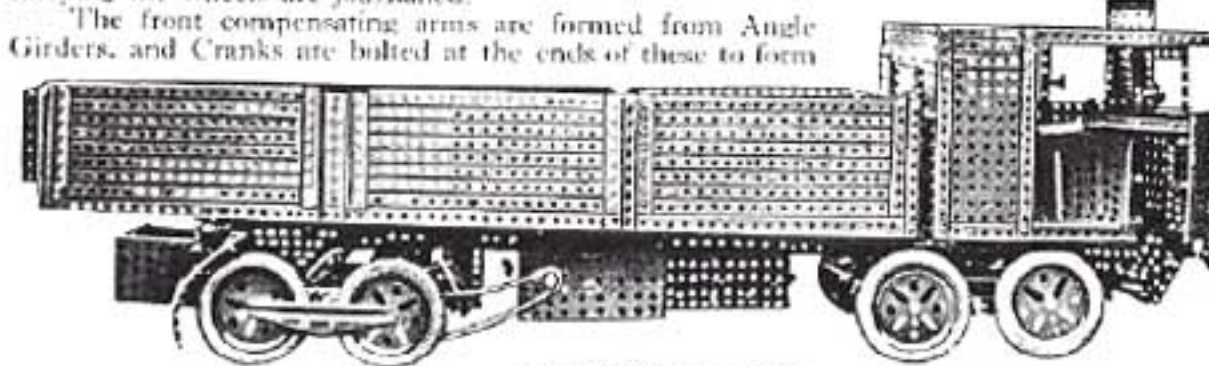

Another Steam Wagon,
by J. Hedley

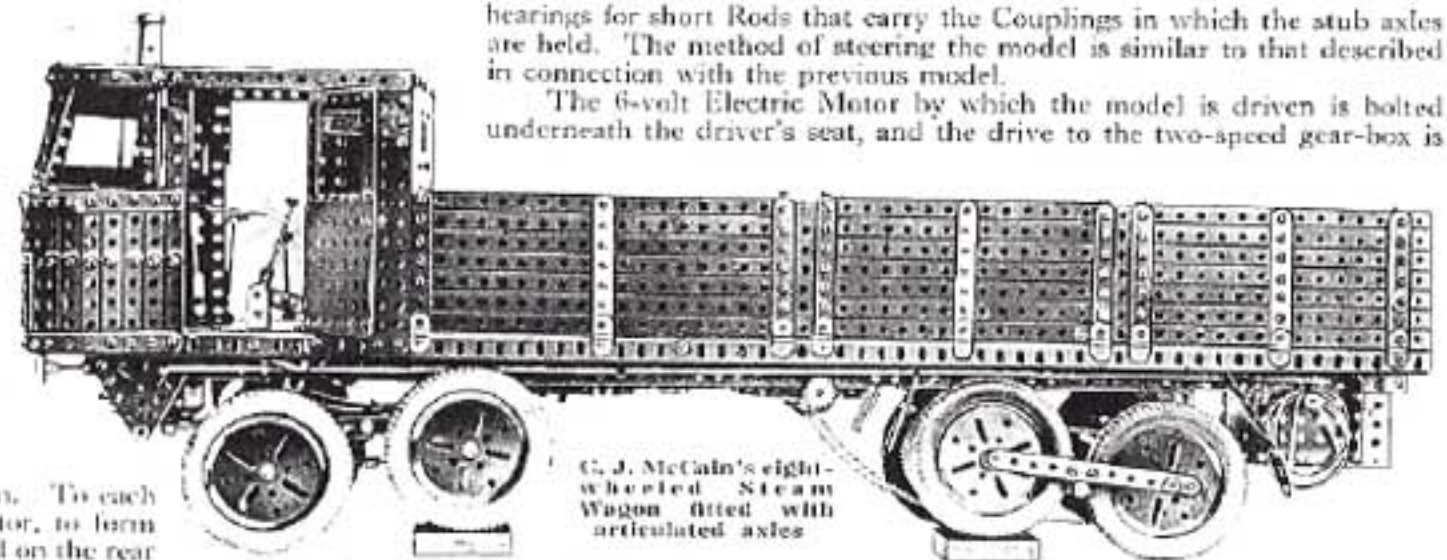

C. J. McCain's eight-wheeled Steam Wagon fitted with articulated axles

bearings for short Rods that carry the Couplings in which the stub axles are held. The method of steering the model is similar to that described in connection with the previous model.

The 6-volt Electric Motor by which the model is driven is bolted underneath the driver's seat, and the drive to the two-speed gear-box is

taken through Sprocket Chain. A Universal Coupling on the driven Rod of the gear-box carries a short Rod on the end of which is a $\frac{1}{2}$ " Bevel Wheel meshing with the differential gear. Sprocket Chain transmits the drive from the differential to the rear wheels, and the two wheels on each compensating beam are coupled by Chain so that all four rear wheels are driven.

Strips and Angle Girders are used for the construction of the cab and wagon body. The sides of the wagon are made in three sections built up from Strips and hinged to the Angle Girders at the side of the platform. Two vertical posts made from Angle Girders are placed between the three sections, each of which can be let down independently.

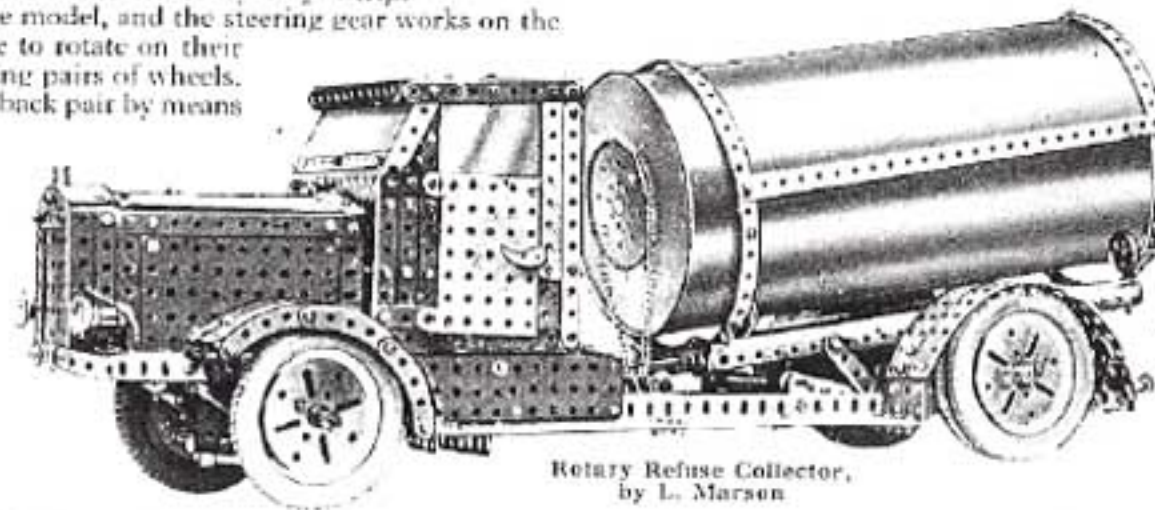

Rotary Refuse Collector,
by L. Marson

Model No. 65. Rotary Refuse Collector. (L. Marson, Bexhill-on-Sea).

An original subject for a model is the rotary refuse collector illustrated here. The main features of the lorry include a three-speed forward and reverse gear-box, front wheel drive, internal expanding brakes on the rear wheels, and rotating and mechanically tipped rotating barrel.

An Electric Motor is housed in the bonnet and is fixed in position with its armature shaft vertical. A $\frac{1}{2}$ " Pinion on the lower end of the shaft engages a $1\frac{1}{2}$ " Contrate on a Rod journaled longitudinally in the chassis. The clutch is carried on this Rod and the gear-box is mounted below the axle, the drive being taken through Sprocket Chain. The drive from the gear-box to the front axle is conveyed through a short Rod with a Universal Coupling at each end, to a Rod fitted with a $\frac{1}{2}$ " Pinion that engages a $1\frac{1}{2}$ " Contrate incorporated in the differential. The front driving axle has a $\frac{1}{2}$ " Contrate at each end, and these mesh with $\frac{1}{2}$ " Pinions that are free to rotate on the pivot pins of the stub axles. Each front wheel is free on its axle and $1\frac{1}{2}$ " Contrates bolted to the wheels mesh with the $\frac{1}{2}$ " Pinions.

The barrel tipping mechanism is driven from the gear-box and is operated through Worm gearing. The Worm engages a $\frac{1}{2}$ " Pinion on a Rod mounted transversely in the chassis directly beneath the tipping frame and is fitted with two Cranks, the arms of which are extended by $2\frac{1}{2}$ " Strips, pivotally connected by further $2\frac{1}{2}$ " Strips to the frame carrying the barrel.

The barrel rotates on four 1" loose Pulleys, and a 3" Sprocket is attached to the end of the barrel and is driven from a 1" Sprocket Wheel on a Rod placed horizontally in the tipping frame. The drive to this Rod is conveyed through Bevels from the Rod about which the barrel support pivots, and a $\frac{1}{2}$ " Pinion on the latter Rod is driven by a Worm on a short vertical shaft. The lower end of this shaft carries a $\frac{1}{2}$ " Pinion that meshes with a Worm on a Rod driven from the gear-box.

Model No. 66. Petrol Tank Lorry. (E. S. Turner, Toronto).

The tank lorry illustrated represents a type of wagon used for transporting petrol in large quantities. It is driven by an Electric Motor, the drive from which is transmitted through a clutch to a four-speed gear-box. The clutch consists of a Socket Coupling to which a $\frac{3}{4}$ " Flanged Wheel is secured. The Wheel and Coupling are slidable on a Rod, but a Compression Spring normally holds the Wheel tightly against a 1" Fast Pulley, to the face of which a flat piece of rubber is gummed. A Collar is placed behind the Socket Coupling so that its Set Screw engages the slot of the Coupling. A Rod fits the selector groove in the Socket Coupling, and by operating a foot pedal the Coupling may be withdrawn in order to ease the pressure of the Flanged Wheel against the rubber of the Pulley. By this means the drive from the Motor to the gear-box can be interrupted.

An interesting feature of the four-speed gear-box is the method of fitting the selector rod. The gear change lever is connected by a Coupling to a short Rod at the end of which is a Crank. An Eye Piece slides on the Crank, and is attached to a Collar that is free to rotate on the sliding shaft of the gear-box, but is held in place against one of the gear bosses by a further Collar. The drive from the gear-box is led through a Universal Coupling to a Rod fitted with a second Universal Coupling on a Rod driving a $\frac{1}{2}$ " Pinion that engages the Contrate of the differential gear. A $1\frac{1}{2}$ " Flanged Wheel on the rear axle is used as a brake drum, the brake strap being operated by a foot-pedal.

The petrol tank is made by bolting 12 $\frac{1}{2}$ " Strips round the peripheries of Hub Discs, and side lockers are made from Strips and Flat Plates. A space is left in the sides as shown to give access to the rear wheels. Hinged doors are fitted to the driver's cab, and are provided with celluloid windows, celluloid being used also for the windscreen. The bonnet is made to open, and a neat radiator is built from 3" Strips and finished with a 2 $\frac{1}{2}$ " Curved Strip across the top.

Model No. 67. Armstrong-Siddeley Limousine.

(J. Matthews, Fillongley, Nr. Coventry).

The saloon car illustrated below is a fine reproduction of one of the Armstrong-Siddeley models. It bears a remarkable resemblance to the actual car and a great deal of detail is incorporated, the interior fittings, not visible in the illustration, being reproduced with the same care as the external details. It is driven by an Electric Motor, a $\frac{1}{2}$ " Bevel on the armature shaft of which engages a similar gear on a Rod carrying at one end part of the clutch unit, and at its other end the female member of a Dog

Clutch. The male member is secured to the driven shaft, and the Clutch is normally held out of engagement by a Compression

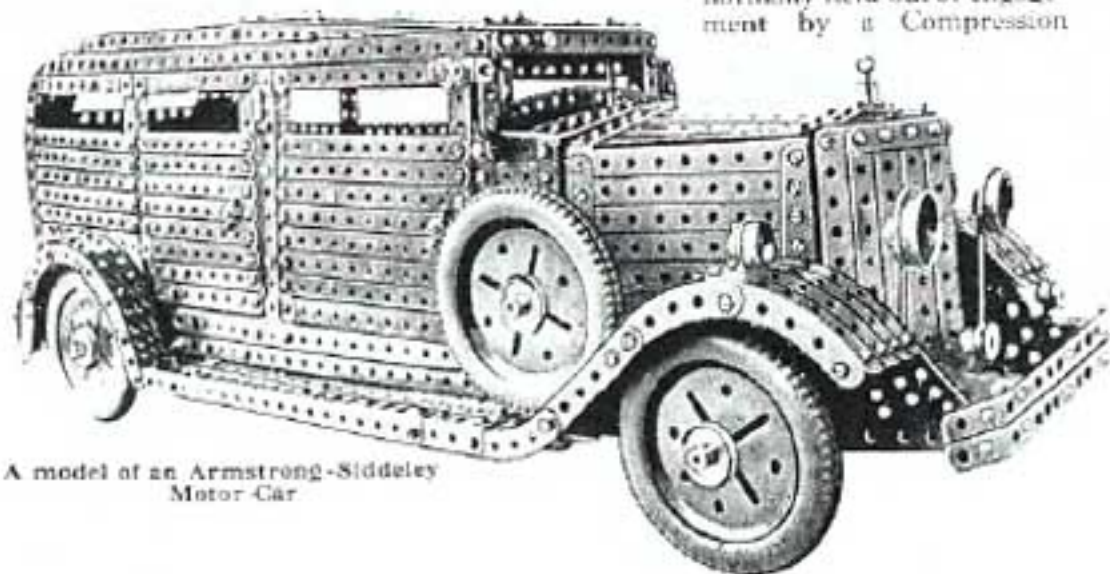

A model of an Armstrong-Siddeley Motor Car

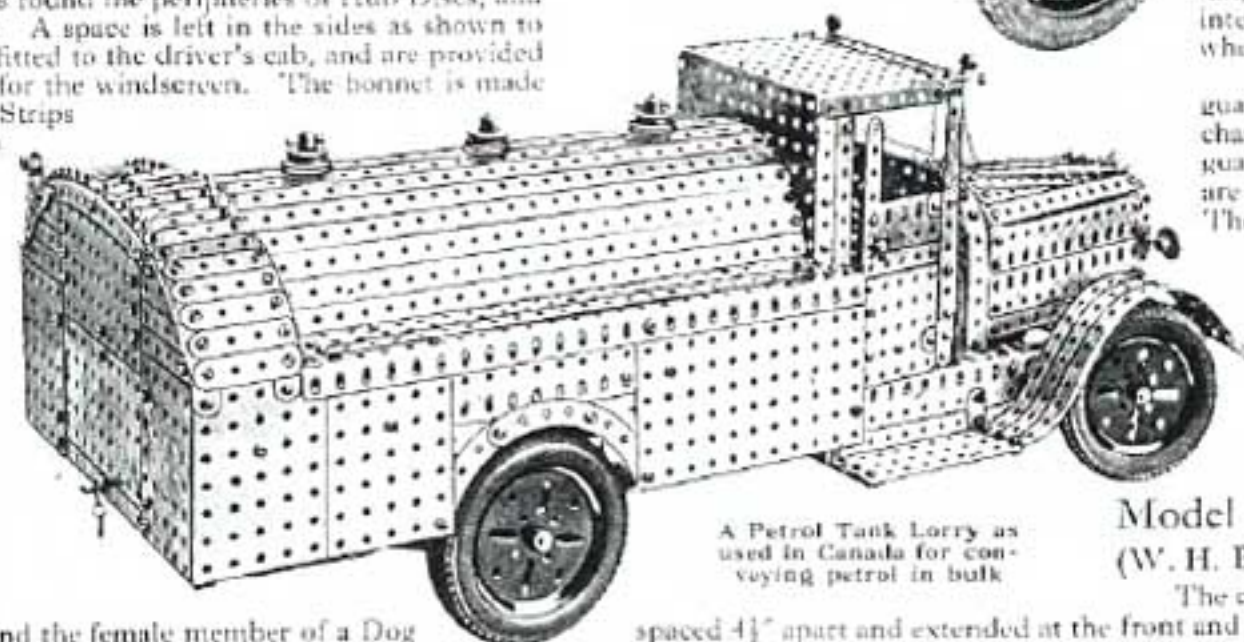

A Petrol Tank Lorry as used in Canada for conveying petrol in bulk

spring. The three-speed forward and reverse gear-box is of the sliding countershaft type, and the drive is transmitted through a Universal Coupling to a flexible shaft carrying a $\frac{1}{2}$ " Bevel that engages a $1\frac{1}{2}$ " Bevel of the differential on the rear axle. Cantilever springs support the rear axle, and are formed from Strips ranging in length from $1\frac{1}{2}$ " to $5\frac{1}{4}$ ". Powerful internal expanding brakes are fitted on all four wheels.

The footboards and front and rear mudguards are attached to the side Girders of the chassis. The turned down flanges of the mudguards are formed from Curved Strips, and Strips are made to fit round the outer edges of these. The side-lamps are made from $\frac{1}{2}$ " Flanged Wheels attached to the wings by $\frac{1}{2}$ " Bolts screwed into their bosses, and two $1\frac{1}{2}$ " Flanged Wheels mounted on 2" Screwed Rods serve as headlamps. Below these are fog lamps made from $\frac{1}{2}$ " Fast Pulleys. Following the Armstrong-Siddeley practice, the radiator is pointed and is surmounted by a Threaded Boss and Handrail Support.

The chassis is composed of two 12 $\frac{1}{2}$ " Angle Girders spaced 4 $\frac{1}{2}$ " apart and extended at the front and rear by Curved Strips. The Strips at the rear curve upward and then sweep down in a semi-circle, to allow space for the rear axle unit. Semi-elliptic laminated leaf springs fitted at the bonnet end support the front axle, which is composed of Strips, to the ends of which are pivoted Couplings carrying the stub axles. The Couplings also carry short Rods pivotally linked together by the track rod, connections being made by means of Swivel Bearings. To one of the short Rods held in the Coupling at right-angles to the stub axle is fixed a Swivel Bearing holding another Rod carrying a Collar, which is pivotally connected to a Crank on the lower end of the steering column.

The drive is from a 6-volt Electric Motor, a $\frac{1}{2}$ " Pinion on the armature shaft of which engages a 57-teeth Gear on a Rod journalled in the Motor side plates. This Rod also carries a $\frac{1}{2}$ " Pinion that engages a $\frac{3}{4}$ " Contrate Wheel on a vertical Rod journalled in 1 $\frac{1}{2}$ " Strips bolted to the Motor side plates. A $\frac{1}{2}$ " Pinion on the lower end of the Rod meshes with a $1\frac{1}{2}$ " Contrate, and the drive from the Contrate is transmitted through a clutch to a three-speed gear-box. A Universal Coupling provides the necessary flexibility in the shaft to the differential gear, which is ingeniously housed in a Boiler. Internal expanding brakes are fitted to the rear wheels and are operated by means of a hand lever. A foot-operated brake also is fitted.

The sides of the long bonnet are built up from Flat Plates and the top from Strips, and a rear radiator is made from Angle Girders in conjunction with 2 $\frac{1}{2}$ " Curved Strips. The "honeycomb" or network of small tubes is represented by Sprocket Chain. Flat Plates are used for the bodywork and also for the saloon roof, the frames for the windows being made from Strips.

Spring. The three-speed forward and reverse gear-box is of the sliding countershaft type, and the drive is transmitted through a Universal Coupling to a flexible shaft carrying

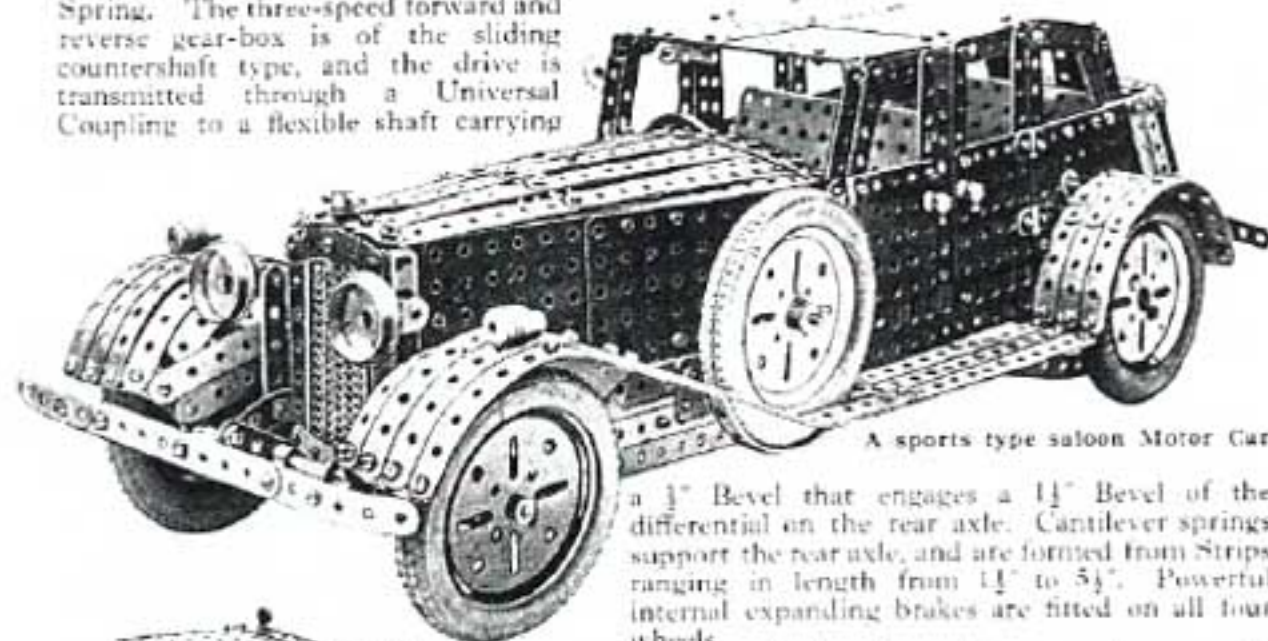

A sports type saloon Motor Car

Model No. 68. Saloon Sports Car. (W. H. Barber, Hornechurch, Essex).

The chassis is composed of two 12 $\frac{1}{2}$ " Angle Girders

spaced 4 $\frac{1}{2}$ " apart and extended at the front and rear by Curved Strips. The Strips at the rear curve upward and then sweep down in a semi-circle, to allow space for the rear axle unit. Semi-elliptic laminated leaf springs fitted at the bonnet end support the front axle, which is composed of Strips, to the ends of which are pivoted Couplings carrying the stub axles. The Couplings also carry short Rods pivotally linked together by the track rod, connections being made by means of Swivel Bearings. To one of the short Rods held in the Coupling at right-angles to the stub axle is fixed a Swivel Bearing holding another Rod carrying a Collar, which is pivotally connected to a Crank on the lower end of the steering column.

The drive is from a 6-volt Electric Motor, a $\frac{1}{2}$ " Pinion on the armature shaft of which engages a 57-teeth Gear on a Rod journalled in the Motor side plates. This Rod also carries a $\frac{1}{2}$ " Pinion that engages a $\frac{3}{4}$ " Contrate Wheel on a vertical Rod journalled in 1 $\frac{1}{2}$ " Strips bolted to the Motor side plates. A $\frac{1}{2}$ " Pinion on the lower end of the Rod meshes with a $1\frac{1}{2}$ " Contrate, and the drive from the Contrate is transmitted through a clutch to a three-speed gear-box. A Universal Coupling provides the necessary flexibility in the shaft to the differential gear, which is ingeniously housed in a Boiler. Internal expanding brakes are fitted to the rear wheels and are operated by means of a hand lever. A foot-operated brake also is fitted.

The sides of the long bonnet are built up from Flat Plates and the top from Strips, and a rear radiator is made from Angle Girders in conjunction with 2 $\frac{1}{2}$ " Curved Strips. The "honeycomb" or network of small tubes is represented by Sprocket Chain. Flat Plates are used for the bodywork and also for the saloon roof, the frames for the windows being made from Strips.

Model No. 69. Heavy Transport Lorry. (J. K. Garner, Bickenhill).

One of the most interesting lorries in the world is that owned by M.R.S., a Liverpool road transport Company. It was built by the Scammell Motor Company, is the largest petrol-propelled road vehicle in existence, and is capable of carrying loads up to 100 tons. It is 70' in length and in order to enable it to negotiate corners steering gears are provided for both back and front wheels. The man in charge of the rear wheels is over 60' from the man at the front and in order that they may work together successfully it has been necessary to install a telephone! This is operated from the lorry's battery. With this arrangement steering is carried out so efficiently that the lorry can turn at right-angles from a road 15' in width into a road no more than 24' in width.

The lorry is built in two separate units, the first of which is similar to an ordinary lorry. The second portion consists of two long parallel girders, joined together at three points and secured to the first part by a massive articulated joint. The rear of the girders is carried on

eight wheels four of which may be omitted if required.

The articulated joint takes the form of a massive steel swan neck that is attached to the girders by two large pivot pins and to the rear of the front part of the lorry by a turntable. This swan neck, in addition to forming a connection, can be used in conjunction with two hydraulic rams to raise and lower the front end of the girders, and in this way large loads may be loaded and unloaded with comparative ease.

The fourteen wheels over which the load of the lorry is distributed are all mounted in pairs with the exception of the front steering wheels. Each of these sets of wheels is mounted on an oscillating beam that gives a fully compensating movement when running on the camber of the road or over humps. Each of the fourteen wheels is fitted with two tyres, their overall width being 9". Thus the wheels are 18" in width overall and, as will be imagined, a considerable load may be carried in perfect safety.

The manner in which the weight is distributed over the fourteen wheels is largely responsible for the success of the lorry, for at first glance it might be thought that a giant of this kind would pound the surface of any road to pieces when carrying a full load. On the contrary, owing to its slow speed on a large road surface, its destructive effect is less than that of a large saloon car! Springing is of course of considerable importance, and rubber in conjunction with spiral steel springs, is freely used in order to give the necessary resilience. The rubber is used in the form of flat rings, which are placed on the centre moving shaft between sheets of steel plate. The thin layers are built up into a column 12' high and the element so formed acts as a shock absorber. The springing system comprises four powerful spiral steel springs, two of which are used on the driving wheels and two on the swan neck.

The lorry is driven by a four-cylinder petrol engine of 80 h.p. and the drive from this is taken through a standard Scammell four-speed and reverse gear-box to the main differential. This drives two subsidiary differentials, each of which drives two of the four rear wheels.

Although the model does not follow this specification in every detail, it incorporates all the most interesting features of the original. The power unit is a Meccano 6-volt Electric Motor, and the drive is taken via a clutch to a three-speed and reverse

gear-box. The gear-box and clutch are built on similar lines to those incorporated in the Meccano Super Model Motor Chassis (Special Instruction Leaflet No. 1), and the controls pass into the driver's cab. The gear-box transmits the drive to a lay-shaft, each end of which is fitted with a 1" Gear that meshes with a 57-teeth Gear Wheel. Each of the 57-teeth Gears is secured on a short Rod that carries also two 1" Sprocket Wheels, and these are connected by means of Sprocket Chain to 2" Sprocket Wheels on the rear axle. The rear axles are

formed from two 4½" Rods carried in the centre tapped holes of two Couplings each held on two 3" Rods, the inner one of which is supported by a Handrail Support. The outer Rod is

journalled in the "spider" of a Swivel Bearing and the boss of this part carries a 1½" Rod that serves as a shock absorbing element, of which there are two, the other being a second Rod placed parallel to the first.

By building the rear axle as two separate units in this manner, the four driving wheels are at all times in full contact with the road, so that the greatest use is made of the load-carrying capabilities of each wheel. This arrangement also enables a positive grip to be obtained by the driving wheels, a point that is of vital importance when a full load is being carried. Ackermann steering gear is fitted to the front wheels, and the characteristic long leaf springs of the actual lorry are faithfully reproduced. The steering is actuated by a specially-designed bell crank mechanism, a feature that does not appear in the actual lorry. The steering wheel is rotated by means of a handle formed by a Threaded Pin set at right-angles to the wheel, a handle being provided on account of the very slow steering that is necessary when the lorry is under load.

The swan neck structure connecting the tractor unit to the carrying girders is an excellent reproduction of the original, and although the raising and lowering movement is not incorporated it fulfils its primary purpose, that of forming a strong link between the two sections of the lorry, remarkably well. The swan neck pivots on a Ball Race.

Part of the equipment of the actual lorry are two sets of load-carrying girders, one long and one short set. The short girders are used only on special occasions, an example of which occurred recently when the lorry was employed to carry a giant girder weighing nearly 100 tons. This particular load was nearly twice the length of the entire lorry, and for this reason the short girders, together with a trailer, were used. The longer girders

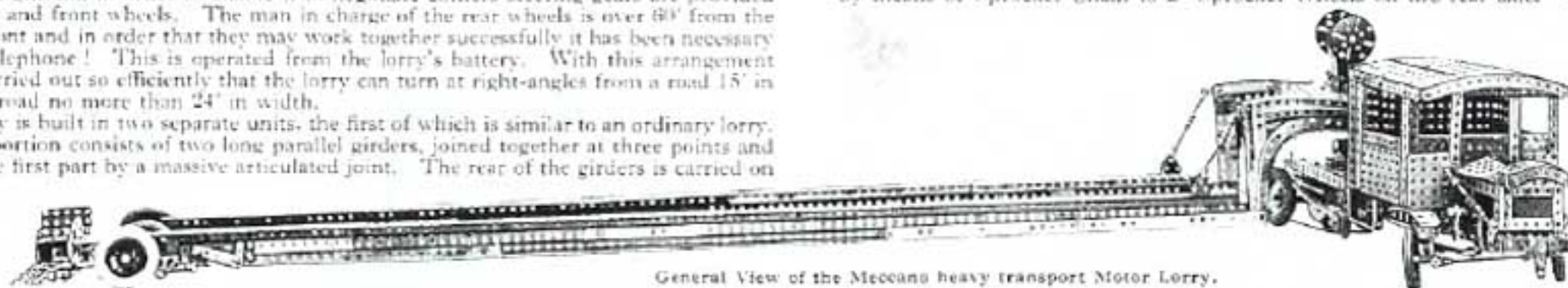

General View of the Meccano heavy transport Motor Lorry.

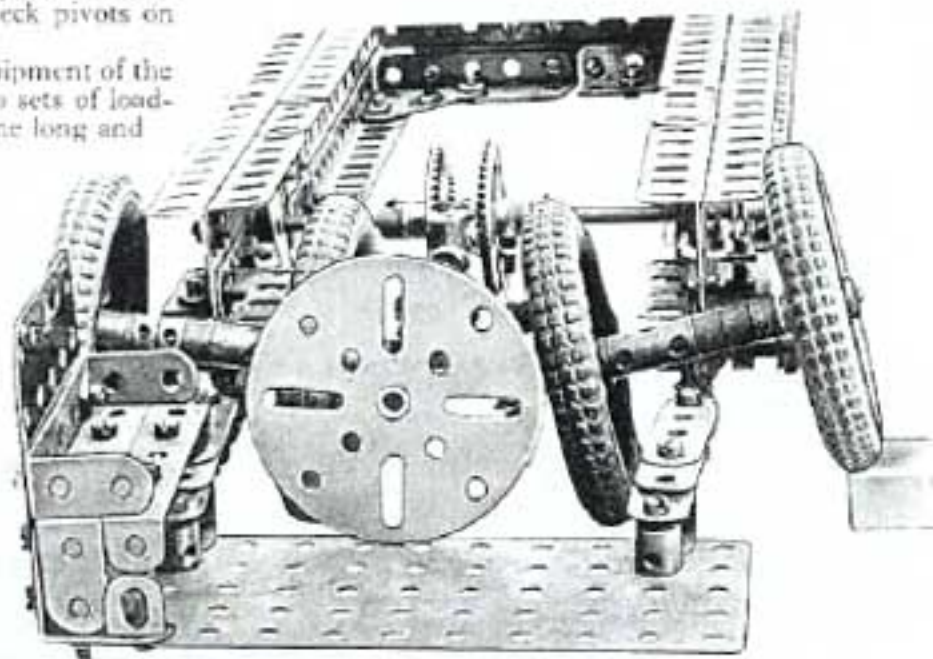
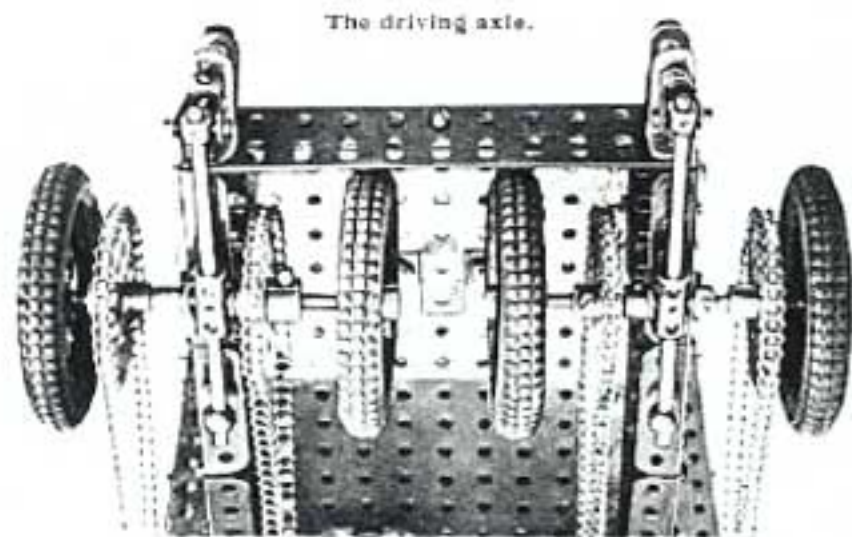

The steering gear at the rear end of trailer.

are used for carrying locomotives and similar loads. The Meccano model is fitted with a set of long girders only. These are 5' in length, and are built from Angle Girders and Flat Girders of various sizes. The average depth of the built-up girders is 2", except for a distance of 5" at the rear, where they are cut away to a depth of 1". This construction is necessary in order that the rear wheels and steering may be accommodated without raising that end of the girders.

The two girders are secured rigidly together by means of three stout cross members, each of which is 4½" long, 1½" deep and 1" wide; and in order that the finished framework may be absolutely rigid a large number of Corner Brackets are used to strengthen all vital points.

The most complicated section of the actual lorry is the rear wheel attachment, for when very heavy loads are being carried this end of the girder is subjected to greater strain than any other part of the lorry. The road wheels must be fully compensating so that they remain in good contact with the road under all circumstances,

and in order that the lorry may be under complete control four of these rear wheels are made steerable. The operation of the four steering wheels is carried out from the rear, where a man, standing on a platform provided for the purpose, receives his orders by telephone from the driver of the lorry. The steering wheel consists of an iron hoop 4' diameter and fitted with spokes in a similar manner to a ship's steering wheel. The steering column is hollow, and down the inside of this tube passes a shaft controlling the brakes on all the wheels.

In the model only the four road wheels are shown attached to the girders. The construction of the attachment on each side is as follows. A compensating beam consisting of a 6½" Rod is pivoted by means of a Coupling in its centre to two Trunnions, and these are bolted to their respective girders. As only four wheels are fitted, the front end of the beam is attached to the girder by means of a Double Bracket, and the opposite end carries a loosely mounted Handrail Support. The threaded portion of the Handrail Support points upward and is fitted with a Coupling that carries a 2½" Rod. This Rod carries two of the four rear wheels that are free to rotate on the axle, Collars being provided to prevent them slipping off the ends of the Rod. Steering is carried out from a Face Plate that is coupled by means of a 6½" Rod to a 1" Bevel Gear. This Gear meshes with two 1½" Bevel Gears, each of which is fitted with a Flat Bracket. The Brackets are connected by 3" Rods to the inner ends of the two rear

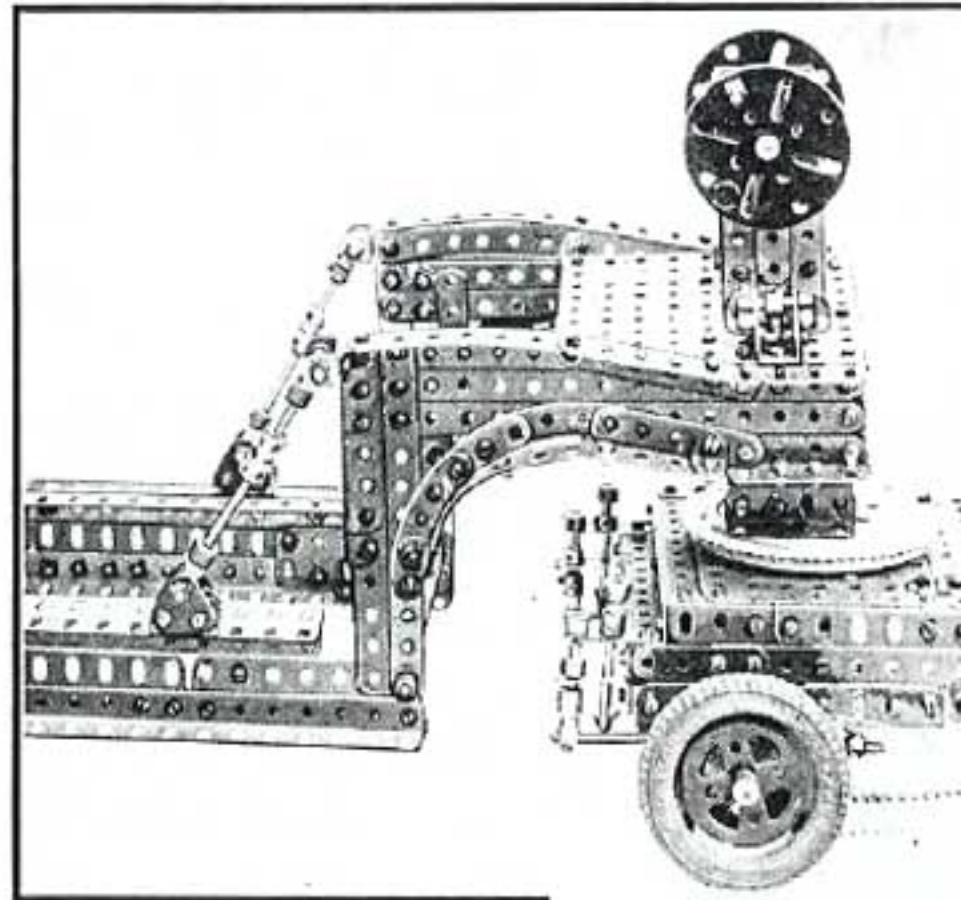

(Above) The neatly constructed swan neck and Ball Race pivot.
(Right) The complete power unit.

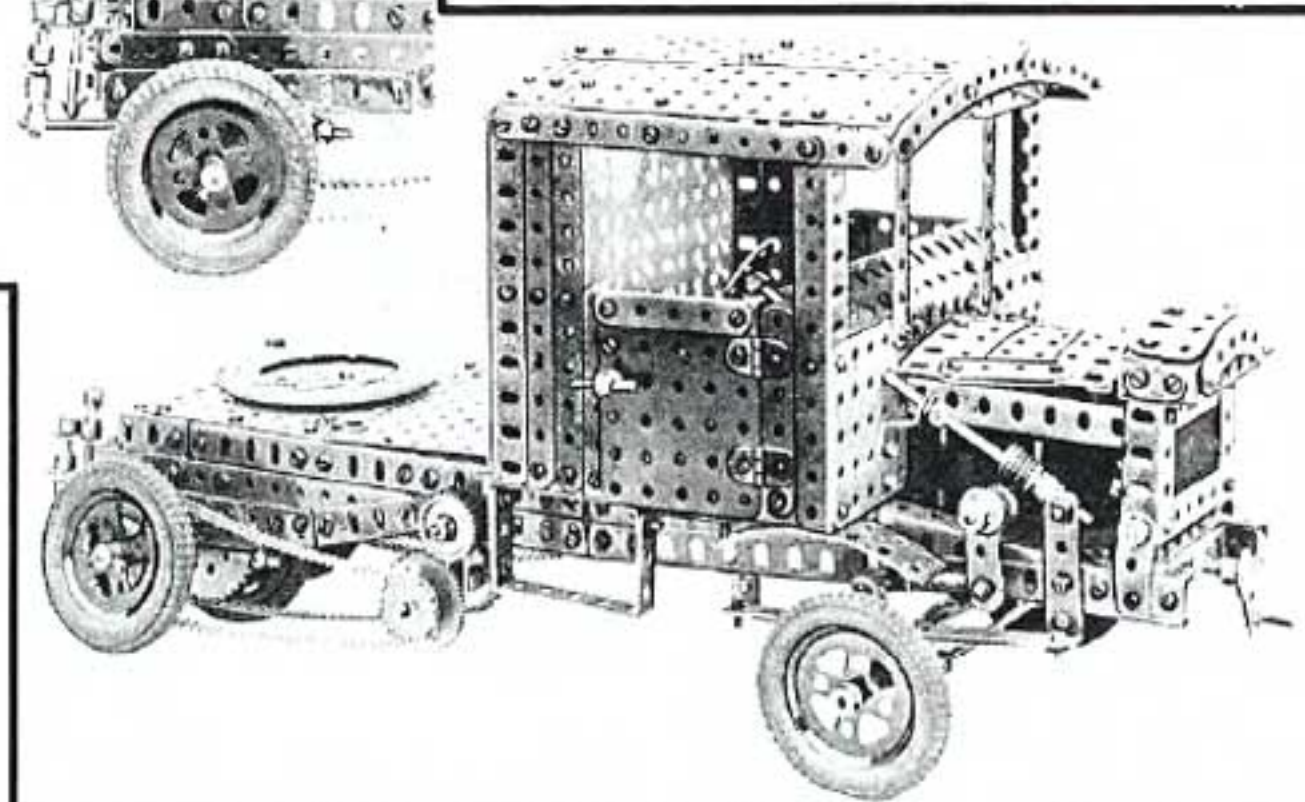

axles, the Rods being attached to the Flat Brackets by Collars and to the rear axles by Swivel Bearings. When the Face Plate forming the steering wheel is turned, the 1½" Bevels turn in opposite directions to each other, and in this way transmit the necessary movement through the connecting links to the rear axles.

A leaf spring built up from one 2", one 2½" and one 3" Strip is attached to the outer end of each compensating beam, and these are attached by means of ½" Reversed Angle Brackets and Threaded Bosses to a 5½" x 2½" Flat Plate. The Plate forms a platform for the rear steersman and one side is fitted with a seat, the back of which consists of a 2½" x 2½" Flat Plate that is secured to the platform by means of two 1" x 1" Angle Brackets. A seat consisting of Double Angle Strips of varying sizes is fitted also to the inner side.

Since this model was designed many alterations have been made to the original lorry, one of which is the fitting of a sleeping compartment behind the driver's cab. This refinement has been found essential when very long journeys have to be undertaken. On these occasions a change of drivers and crew every eight hours is necessary, and to prevent waste of time one crew sleeps on the lorry while the other is on duty. It has also been found necessary to fit a powerful flood-light near the centre of each side of the load-carrying girders. This became necessary owing to an unfortunate accident that occurred when the lorry was proceeding over a crossing one dark night. The front portion of the huge lorry had indicated its passing by the glare from its headlamps, but as the vehicle was travelling at a speed of only 2 m.p.h. it naturally required a considerable time to completely cross the junction. A motorist who was travelling down the cross-road at right-angles to the lorry was unaware of the presence of so large a vehicle, and on seeing the passing of what was apparently a normal lorry proceeded to increase his speed. Unfortunately he arrived at the crossing when only one half of the huge lorry had passed,

and found his small car attempting to overturn the world's largest lorry! Since this unfortunate occurrence, however, all possibilities of a similar accident have been eliminated.

The braking system of this lorry is very complete, and although no attempt has been made to reproduce it in the model, it is worthy of a little explanation. There are two braking systems on the motive unit, one of which is operated by a combination of foot and hand levers and the other by a screw mechanism. The former operates on drums incorporated in the differential unit, and the latter consists of four separate brake drums, one of which is fitted to each driving wheel. They are of the

internal expanding type and are the most powerful brakes fitted to any road vehicle in the world.

A separate braking system is fitted to the wheels at the rear of the girders and these are controlled by the steersman at this part of the machine. These are also internal expanding and are eight in number. Owing to the necessity of allowing for continual oscillation of the wheels the brake-coupling arrangement is naturally complicated, yet it works very satisfactorily. All eight brakes are, as stated previously, controlled by a small wheel situated in the centre of the large steering wheel.

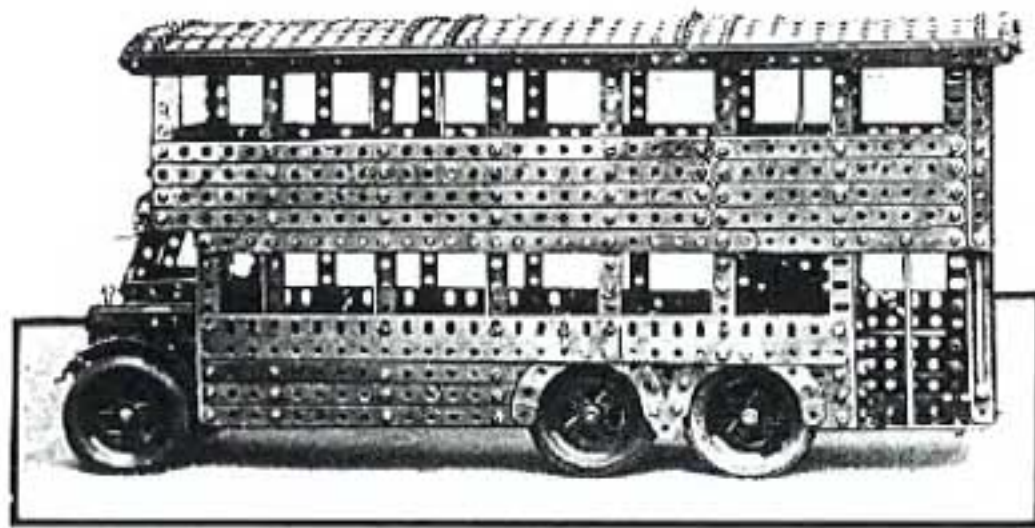

Model No. 70. Six-wheeled Double-Deck Motor Omnibus. (A. Leonard, Blackheath).

The above illustration shows a six-wheeled double-decked motor bus, in building which the chief aim has been to incorporate as much detail work as possible. Another view of the model is shown in the centre of this page and will give an idea of its pleasing lines, although it is difficult to appreciate the full merit of the model from illustrations alone.

The chassis is constructed on similar lines to the Meccano Super Model Motor Chassis (Instruction Leaflet No. 1), and the rear axles are mounted between short Strips pivoted in the centre and arranged to form springs. The steering gear is of regulation pattern and operates on the Ackermann principle, the wheels being moved by a Crank on the lower end of the steering column. The other controls are grouped together in the driver's cab, which as will be seen is built out on the "off" side of the bonnet.

Angle Girders are used for the framework of the body and this is filled in with Strips and Flat Girders. Strips are used for the upper deck and roof. The interior is fitted with seats arranged in a similar manner to those in the real vehicle, which, by the way, is designed to accommodate 56 passengers. At the rear of the vehicle a stairway with handrails connects the conductor's platform and the upper deck.

The bonnet and radiator consist of Strips, and a touch of realism is given by the addition of two $\frac{1}{2}$ " Flanged Wheels to represent head lamps. Flat Girders are bent to form the front mudguards, and a miniature destination indicator is mounted over the driver's cab.

Considerable interest would be added to the model by fitting the interior of the body with electric lighting. To do this a number of bulbs should be screwed into Meccano Lamp Holders connected to a switch mounted in the driver's cab. A suitable switch can be built up from a Flat Bracket mounted on a 6 B.A. Bolt, taking care to insulate the Bolt from the framework of the model. The Bracket should be made movable so that it can be brought into contact with a second 6 B.A. Bolt to complete the electric circuit.

Full details of a suitable gear-box, clutch and differential for this model are contained in the Special Instruction Leaflet describing the Meccano Super Model Motor Chassis. By modifying the details of the chassis illustrated in the Leaflet it is possible for any model-builder to incorporate it in other models of motor vehicles, such as that described above.

Model No. 71. Trolley Omnibus. (R. Grenier, Barcelona).

In many towns and cities electric street tramcars have been replaced by trolley omnibuses which, although relying on electric motors for their power, are fitted with pneumatic tyres and steering gear. The electric current is collected from overhead conductors by means of the usual overhead trolley, and is returned to a second overhead wire instead of through metal rails as in the case of ordinary tramcars. These trolley buses run much more smoothly than tramcars and possess several advantages over the older type of vehicles.

The fine model of a trolley bus shown below is simple to build and will amply repay the labour needed in its construction. The overhead trolleys collect the current for the 6-volt Electric Motor mounted in the front of the model, and the Motor drive passes through a two-speed gear box before being transmitted to the back axle through a Universal Coupling and Bevel Gearing. Internal expanding brakes operated by a foot pedal are fitted to the rear wheels and the steering is Worm operated on the Ackermann principle. Both the front and the rear axles are mounted on semi-elliptic springs.

The saloon is built mainly from plates and is roofed in with Strips. The trolleys are each mounted on separate Strips that are insulated from the saloon roof by 6 B.A. Bolts and Insulating Bushes and Washers. The Strips are connected by rubber-covered wire to the motor terminals, and $\frac{1}{2}$ " Loose Pulleys mounted in small Fork Pieces at the upper extremities of the trolleys engage with the overhead wires and pick up the electric current. The conductors are suspended from a number of standards built up from Angle Girders with Strips for the overhanging arms.

By collecting the current in this manner it is not necessary to make provision for carrying an accumulator on the model. The deadweight of the model is thus considerably reduced and a high rate of travel can be obtained. The overhead system also is particularly suitable when using a Transformer, owing to the fact that it is necessary for the Transformer to be plugged in at a fixed point.

Alternatively the accumulator may be placed outside the model and connected to the Motor terminals by long lengths of flexible wire. This method will greatly limit the travel of the model, however, and should only be employed when materials are not available for building overhead conductor supports. The supports for the overhead collecting wires may be constructed in many ways, but by far the simplest method is to use Rod construction throughout. The main upright must be about 15" in height and the horizontal members about 11 $\frac{1}{2}$ " in length. The supports for the wires are constructed from $\frac{1}{2}$ " Strips secured to Rod by means of insulated $\frac{1}{2}$ " x $\frac{1}{2}$ " Angle Brackets.

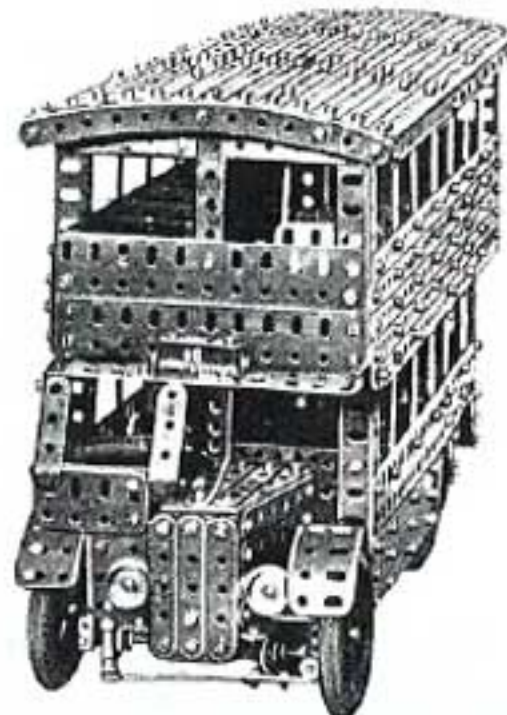

(Top) Side view of a fine Meccano model of one of the latest types of motor omnibuses.

(Centre) A front view of the motor bus giving a clear idea of the seating arrangement.

(Bottom) This electrically-driven omnibus picks up its current supply from overhead conductors. It is fitted with leaf type springs and balloon tyres.

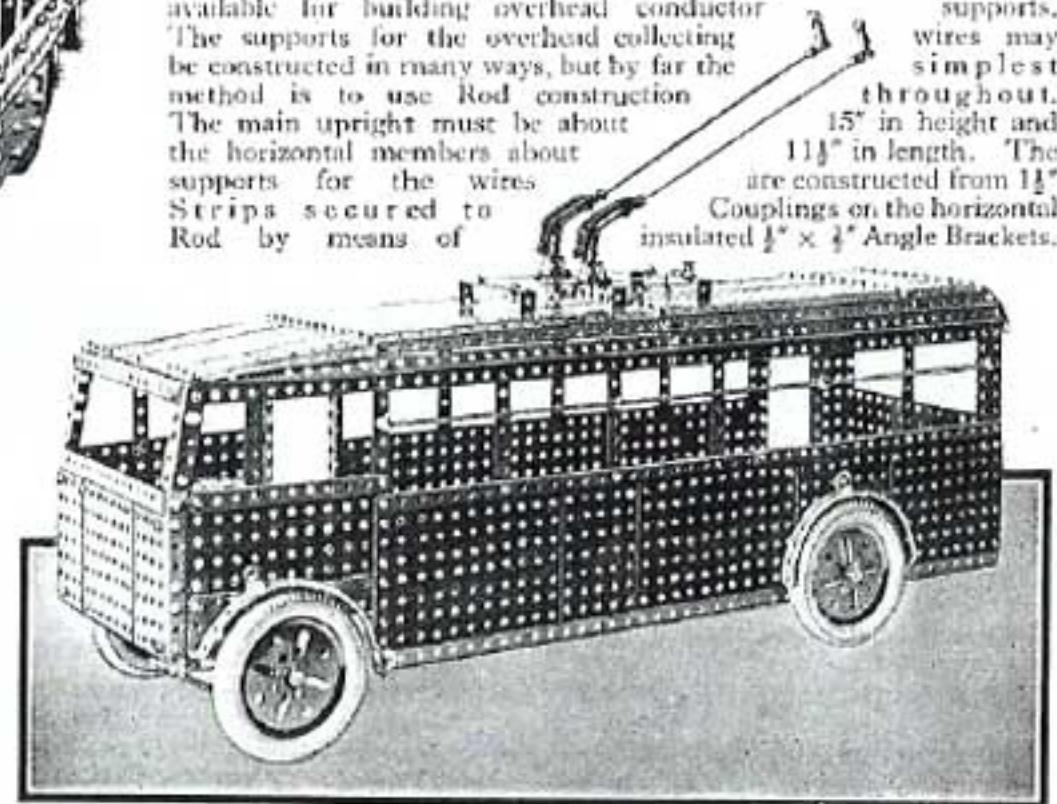

Models Nos. 72 and 73. Garner Six-wheeled Motor Chassis. (J. K. Garner, Bickenhill, and P. M. Worfolk, Caterham Valley).

Amongst the most successful of recent commercial motor vehicles is the Garner rigid six-wheeled lorry. This incorporates many excellent features that render it useful for transport purposes over ordinary roads and the roughest ground alike.

The Garner chassis affords a splendid subject for reproduction in Meccano as will be seen from the accompanying photographs. The fine scale model shown in the upper illustration was constructed by Kenneth Garner, son of Mr. Garner, of Garner Motors Ltd., and the centre illustration shows a model by P. M. Worfolk.

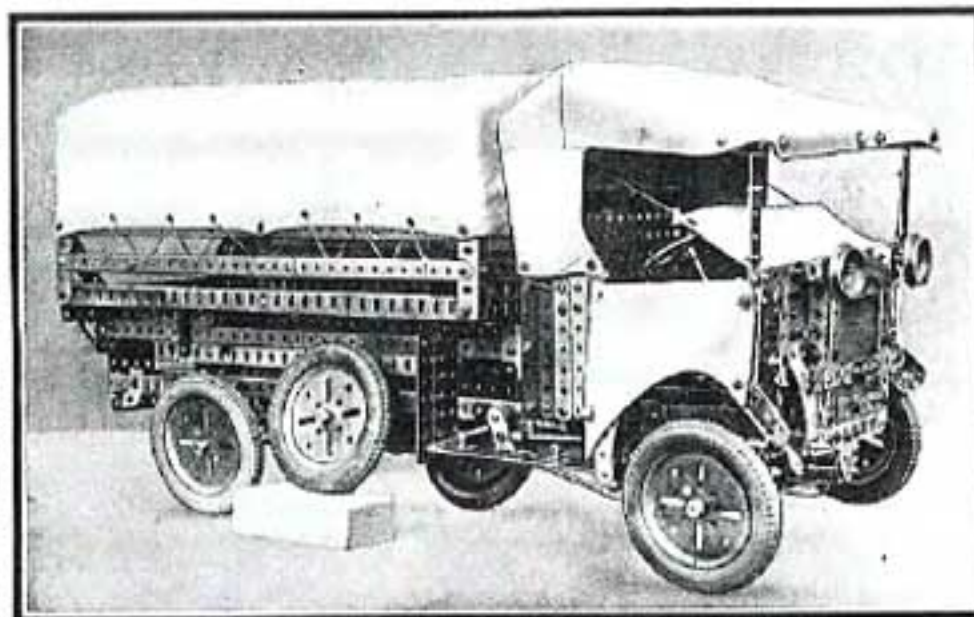

The greater portion of Garner's model, namely, the frame, bogie, and articulating front axle, was developed from the original drawings of the actual chassis. The cab and bodywork are built to scale, the measurements being based on the dimensions of actual vehicles in the Garner Works.

The model is driven by a six-volt Meccano Electric Motor that is incorporated in the frame as a substitute for the orthodox engine. The gear-box gives two speeds forward, and reverse travelling is obtained by reversing the Motor. The final drive to the second and third axles is transmitted by Worm gears. Steering is by means of Ackermann type linkage, and the change-speed lever for the gear-box is placed at the driver's left-hand side. The special Garner front wheel articulation system is faithfully reproduced in the model, and it is interesting to note that, by incorporating two quarter-elliptical springs arranged in V formation and working in combination with a radius rod, a considerable difference in front wheel level is possible. The springs are centrally pivoted to the chassis and give free articulation of the front wheels within a limit of $1\frac{1}{2}$ ".

The rear axle suspension consists of two inverted semi-elliptical springs built up from Strips of various lengths on each side of the frame, and these also incorporate the bogie mounting system. An important feature of this method of suspension is that the front wheels are mounted in practically the same position fore and aft as when the usual semi-elliptical spring system is provided, thereby reducing the total length of the chassis and wheelbase without reducing the available loading space. The body is of the "well" type, and is equipped with small hooks to which a canvas covering may be attached. A hinged tail-board also is provided.

The model chassis is 24" in length overall and 8" in width, the track width being 7". The overall measurements of the body are length 15½", width 8", and height 8".

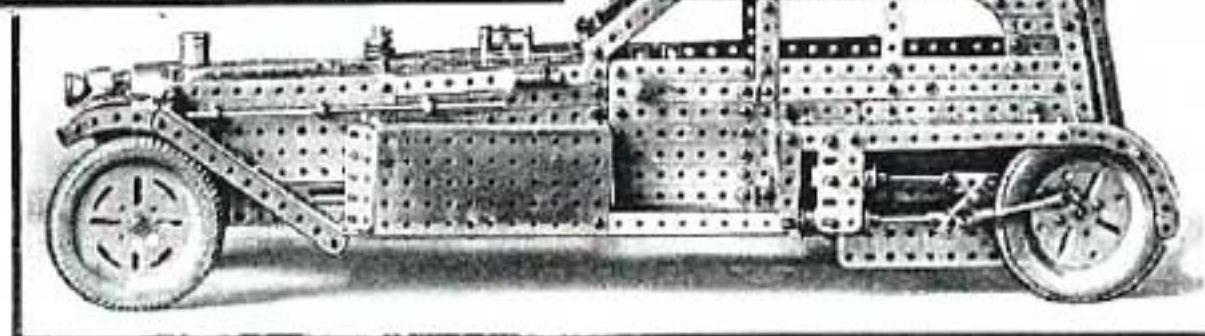

(Top and Bottom). Two splendid models of the Garner Six-wheeled Lorry in which a special method of articulating the axle is used.

(Centre). A unique steam-driven Auto-Car.

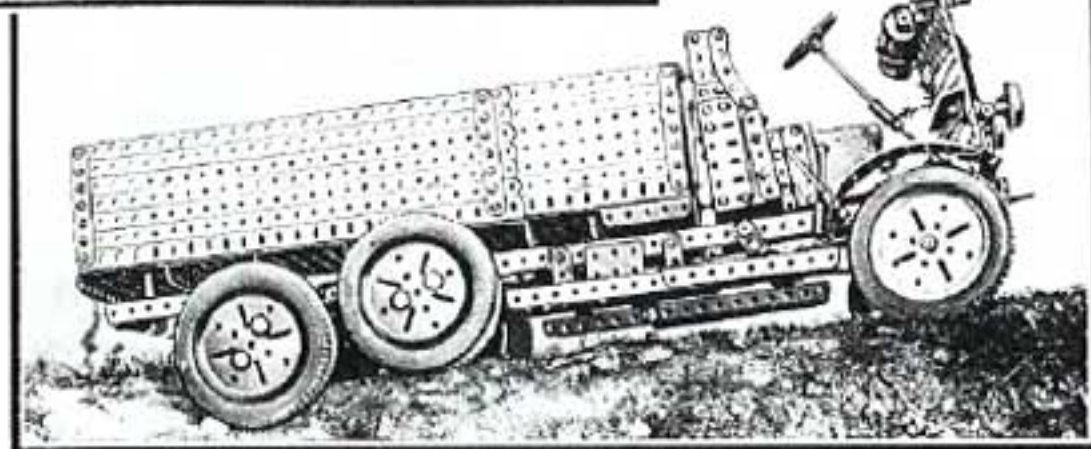

Every part of the chassis consists of standard Meccano parts. The transmission incorporates several Universal Couplings in order to provide flexibility of the inner bogie axle for travelling over uneven ground. The six road wheels consist of 3" Pulleys fitted with 3" Meccano Dunlop Tyres, and these give to the model a very finished and realistic appearance.

In the model constructed by P. Worfolk the gear-box is of the Meccano standard type and provides three forward and reverse speeds.

A chassis of this type, in which the four rear wheels are driven, necessitates the provision of two differential gears, one for each of the twin rear axles, and for these a modified form of the standard differential that is incorporated in the Meccano Motor Chassis is used. Instead of the 1" Bevels that form a prominent feature of the standard differential, however, ½" Bevels are used in this model and function very satisfactorily.

Insufficiency of parts presumably prevented Worfolk from including a clutch in his model and therefore the Motor drives direct to the gear-box. A ½" Pinion on the Motor armature shaft meshes with a 57-teeth Gear Wheel, on the Rod of which is also a Sprocket Wheel. A length of Sprocket Chain connects the Sprocket Wheel with another Sprocket Wheel on a Rod that carries also a Worm. This is in direct engagement with a 1½" Contrate that is secured to the fixed shaft of the gear-box.

Model No. 74. Steam-driven Saloon Car. (J. Ringnalda, Leeuwarden, Holland).

The model steam-driven auto-car shown on this page forms a unique subject for model-builders. Apart from the cylinders, which drive direct on to the rear wheels, the external appearance of the model does not differ very much from that of an ordinary motor car.

The "boiler" is hidden under the bonnet, and is represented by a Meccano Boiler. On the top of the bonnet is a realistic Ramsbottom-type safety-valve constructed from two Spring Buffers, a short Strip and a 1" Bolt. The cylinders and valve chests are Sleeve Pieces capped at each end with ½" Flanged Wheels; the piston rod is coupled to the connecting rod by means of a Universal Coupling, and the "big end" is a Fork Piece. The Fork Piece is connected direct to a crank-pin, which

consists of a Pivot Bolt held in one of the holes in a 3" Pulley that forms the rear wheel. Each of the rear driving wheels is fitted with a separate cylinder. The fuel is carried in bunkers situated on the running boards.

A point that will appeal to model-builders who appreciate the finer details of model construction is the use of a Pawl to represent the familiar pattern door handle! If desired either a Clockwork or an Electric Motor may be fitted under the chassis and coupled to the back axle via the usual clutch, gear-box and differential. By driving the model in this way the piston rods will work backward and forward in a most realistic fashion as the car travels along.

Model No. 75. Motor Ship. (H. Roden, Kilmacolin, Renfrewshire).

This model is a reproduction of the M.V. "Ulster Monarch," owned by the Belfast Steamship Co., Ltd. The actual vessel has a gross tonnage of 3,780, and a maximum speed of 19 knots. She is propelled by twin screws driven by 10-cylinder double-acting Diesel engines that develop 3,000 h.p. at 160 r.p.m.; and there are also smaller Diesel engines from which is used for lighting the cabins and for operating the auxiliary machinery. The corridors, cabins and saloons are heated or cooled as conditions render necessary by means of compressed air, which is supplied by a compressor in the engine room.

The model is 4 1/2" in length and the hull is in five separate sections, two of which are constructed from 5 1/4" Strips and the remaining three from 12 1/2" Strips, the separate sections being connected together by means of 2 1/2" Flat Girders. The stern consists of a 2 1/2" x 2 1/2" Flat Plate held in place by 2 1/2" Angle Girders, and the deck is filled in with Flat Plates and Sector Plates. The fore-castle deck is constructed from 5 1/4" Strips and 3" x 1 1/2" Flat Plates, and is equipped with two well-made models of a "Harfield" windlass. This section of the vessel also carries a vertical warping capstan, represented by two 1/2" loose Pulleys carried on a Pivot Bolt. The anchors are excellent models of the well-known "Byers" stockless anchors, and are composed of three Handrail Supports mounted on a 1" Rod. The two outer Handrail Supports are secured to the Rod slightly out of line with the centre one, the shank of which passes into the threaded hole of a Threaded Boss that passes through a hole forming the hawse pipe, and is held in place on the inner side of the hull by an Angle Bracket.

The raised after deck consists of a 5 1/4" x 2 1/2" Flanged Plate fixed to the main deck by means of four 3" x 1 1/2" Flat Plates. These Plates are bolted in pairs to each side of the Flanged Plate, and are secured to the main deck in such a position that a gangway 1/2" in width is formed on each side of the deck.

The main cabin is built up from 12 1/2" and 2 1/2" Angle Girders, fixed together so that they form a shallow oblong box. The top of the structure is fitted with a large platform, built up from 5 1/4" x 3 1/4" Flat Plates, representing the boat deck, and carrying the bridge, eight lifeboats and two squat funnels. The funnels consist of Boilers without Ends, and vent pipes are fitted to the front of each by means of Handrail Supports. The boats are each represented by two 3" Angle Girders joined together in the form of a channel section girder and filled in at the ends by 1/2" x 1" Angle Brackets. The boats are hung in miniature "Webb" davits, the falls of which consist of lengths of Meccano Cord. The roof of the bridge is a 4 1/4" x 2 1/2" Flat Plate, and this carries a searchlight that consists of a Threaded Boss fitted to a 1" x 1" Angle Bracket. The inside of the bridge structure is fitted with a dummy helm and two dummy engine room telegraphs.

The masts support a wireless aerial, and the shrouds and stays are represented by Cord. The derricks are fitted to Collars on the masts by means of Small Fork Pieces, and are held in place by dummy luffing tackle. Hatches are built up from 3 1/4" x 2 1/2" Flanged Plates fitted with 3 1/2" Angle Girders bolted to their long sides, and they can be lifted from their seatings by means of hoisting cords.

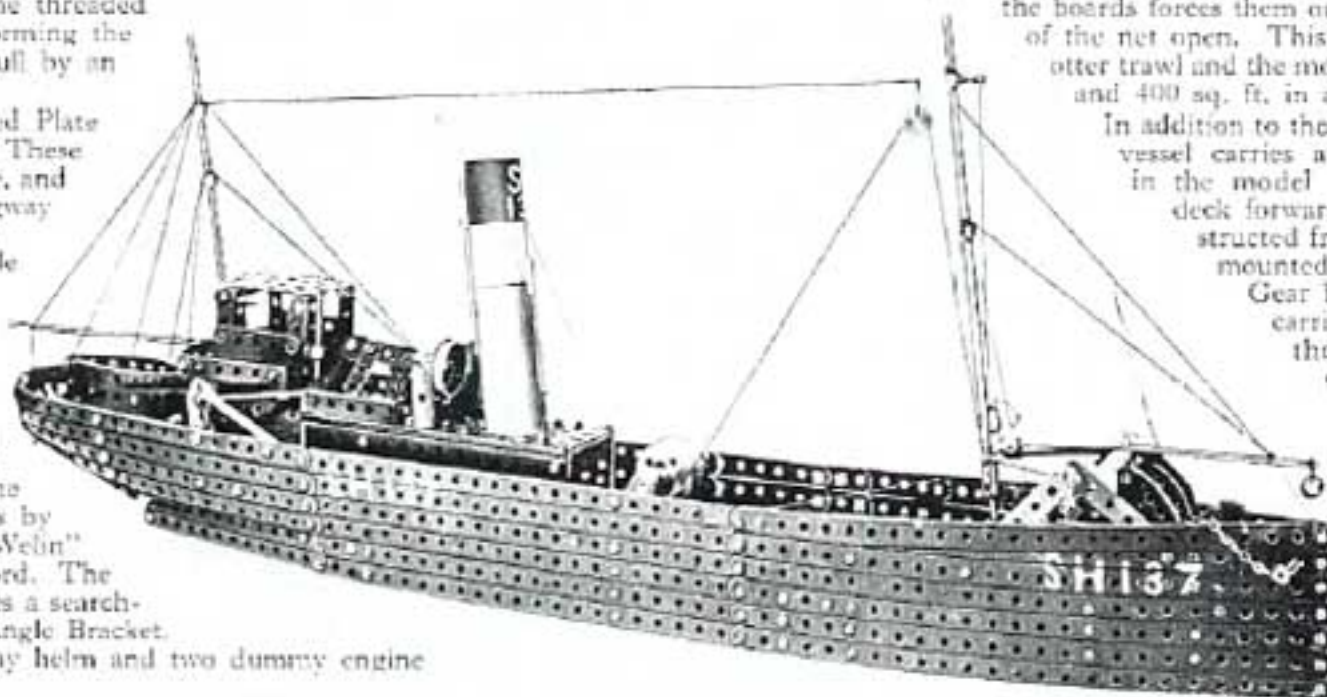
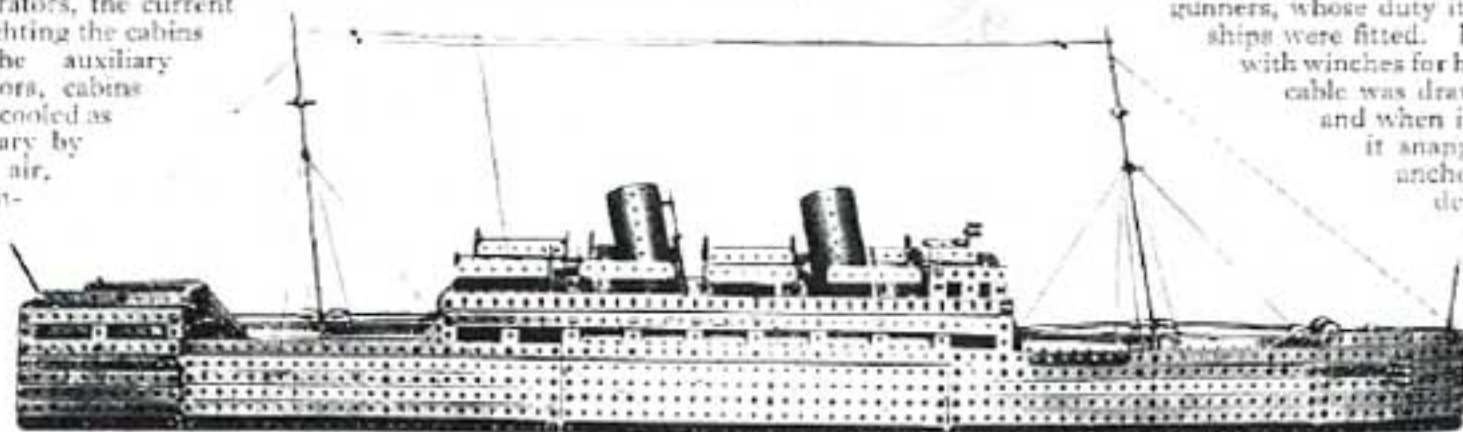

Model No. 76. Steam Trawler. (T. Robson, Scarborough).

This model is a scale reproduction of a typical steam trawler. Actual vessels of this type are about 90' in length, and they play an important part in the British fishing industry. During the Great War large numbers of them were used as armed patrols or mine sweepers. For service as armed patrols they carried, in addition to their usual crews, one or two R.N.R. gunners, whose duty it was to lay and fire the small guns with which the ships were fitted. For mine sweeping purposes the vessels were fitted with winches for handling a long length of strong steel wire cable. The cable was drawn through the water between two of the trawlers and when it came in contact with the mooring wires of a mine it snapped them. The mine was thus released from its anchorage and floated to the surface, where it was readily destroyed by gunfire.

The model has a beam of 5 1/2", and the height from the waterline to the top of the foremast is 12". The hull is constructed from 12 1/2" Strips and it will be noticed that the stern has been moulded with considerable care. In order to cover a number of unsightly Strip ends, a Face Plate has been very carefully curved and bolted in place across the stern. The deck is built in by means of 5 1/4" x 3 1/4" Flat Plates and Flanged Sector Plates, and the fore-castle carries a neatly built companion ladder, hatch and a capstan for handling the trawler and anchor chains.

Two otter boards are also carried, and these are represented by 3 1/2" x 2 1/2" Flanged Plates. The trawl warps are long lengths of Meccano Cord twisted together to represent three-strand rope, and the otter board chains are reproduced by short lengths of Sprocket Chain. In actual practice the otter boards are constructed of stout planks with iron fittings, and are connected with the warp by four short chains, the pull on which keeps the boards vertical and at an angle to the direction of movement. The thrust on the boards forces them outward and holds the mouth of the net open. This kind of trawl is termed an otter trawl and the mouth is often over 100' across and 400 sq. ft. in area.

In addition to the capstan on the fore-castle the vessel carries a powerful steam winch and in the model this is fitted on the well deck forward of the funnel. It is constructed from two 1 1/2" Flanged Wheels mounted on a Rod with a 57-teeth Gear between them. The Rod is carried in Trunnions bolted to the deck, and at each of its ends is a 1/2" fast Pulley.

The part of the engine house protruding through the deck is built up from Flat Plates of various sizes. On it is mounted a cardboard funnel, stayed to the deck by Meccano Cord, and with a 5" Rod attached to it by Collars to represent the vent pipe. The wheel house and engine room hatch are both constructed from Strips and Double Angle Strips of various sizes, and ventilators for the engine room are built up from Sleeve Pieces and large Flanged Wheels.

The rowing boat is carried in skids at the rear of the wheel house, and is built up from four 5 1/4" Strips bent to shape and secured together at each end by Flat Brackets.

Model No. 77. Four-Funnelled Liner.

(V. C. Kaile, Mayford, Woking).

The fine four-funnelled liner appearing on this page represents one of the great vessels that travel across the Atlantic Ocean between Europe and America. The tonnage of some of these ships exceeds 50,000 and their giant engines give them a speed of nearly 30 knots.

The model is nearly 3' long and has five decks. The hull is built up from 30" lengths of Strips, each of which comprises two 12½" Strips and one 5½" Strip. Eight of these compound Strips are required, four for each side of the hull. At the stern the three lower Strips are bent round a 1½" Pulley, and the upper Strip is curved round a Face Plate to form the overhanging stern. A shelter rail is provided at this point, and is constructed from two 5½" Strips moulded to shape and secured in place by means of ¼" x ¼" Angle Brackets. The forward shelter deck consists of two 4½" Strips secured at one end to the stem and at the other end to the deck by ¼" x ½" Angle Brackets.

The main deck is filled in with 12½" Strips, and at the fore end 4½" and 2½" Strips are used. A Face Plate provides a neat means of covering the difficult space in the stern. The four upper decks are represented by two lengths of Angle Girders, one of which is secured to each side of the hull, and the two Girders are connected together by 2½" Flat Girders and 2½" Strips. All four decks are built up in this manner and the outer flanges of the Girders carry long lengths of cord, which is threaded from one Girder to the next in the form of stitching, to represent deck stanchions. The upper or boat deck is divided into two portions, both of which are plated in with the aid of 4½" x 2½" Flat Plates and 2½" Flat Girders. Each of these portions carries two Meccano funnels painted in White Star colours. The lifeboats are represented by 1½" Strips, which are slung in davits made from Meccano 22-gauge Bare Copper Wire.

The masts are 11½" Rods, and suitable stays and shrouds are made from lengths of Meccano Cord attached to the masts by Spring Clips and to the decks by Bolts. Two Collars at the top of each mast support a short length of Meccano Cord, to the ends of which a 2" Rod is attached to represent a wireless aerial spreader. The two spreaders are joined together by an aerial of 22-gauge Bare Copper Wire. The lead-in is also made from 22-gauge Bare Copper Wire.

Miniature cranes are fitted to the model, three being near the stern hatch and two near the fore hatch. Each crane is composed of a Rod that is attached to a Cranked Bent Strip by means of a Coupling, the Cranked Bent Strip being pivotally attached to the deck. The anchors are built up from 2" Strips and 1½" Strips, and the anchor chains are represented by lengths of Sprocket Chain. The inner ends of the Sprocket Chains are passed over capstans constructed from the sleeve portions of Spring Buffers, the sleeves being carried on Threaded Pins secured to the fore-castle deck by means of 1" x ½" Angle Brackets.

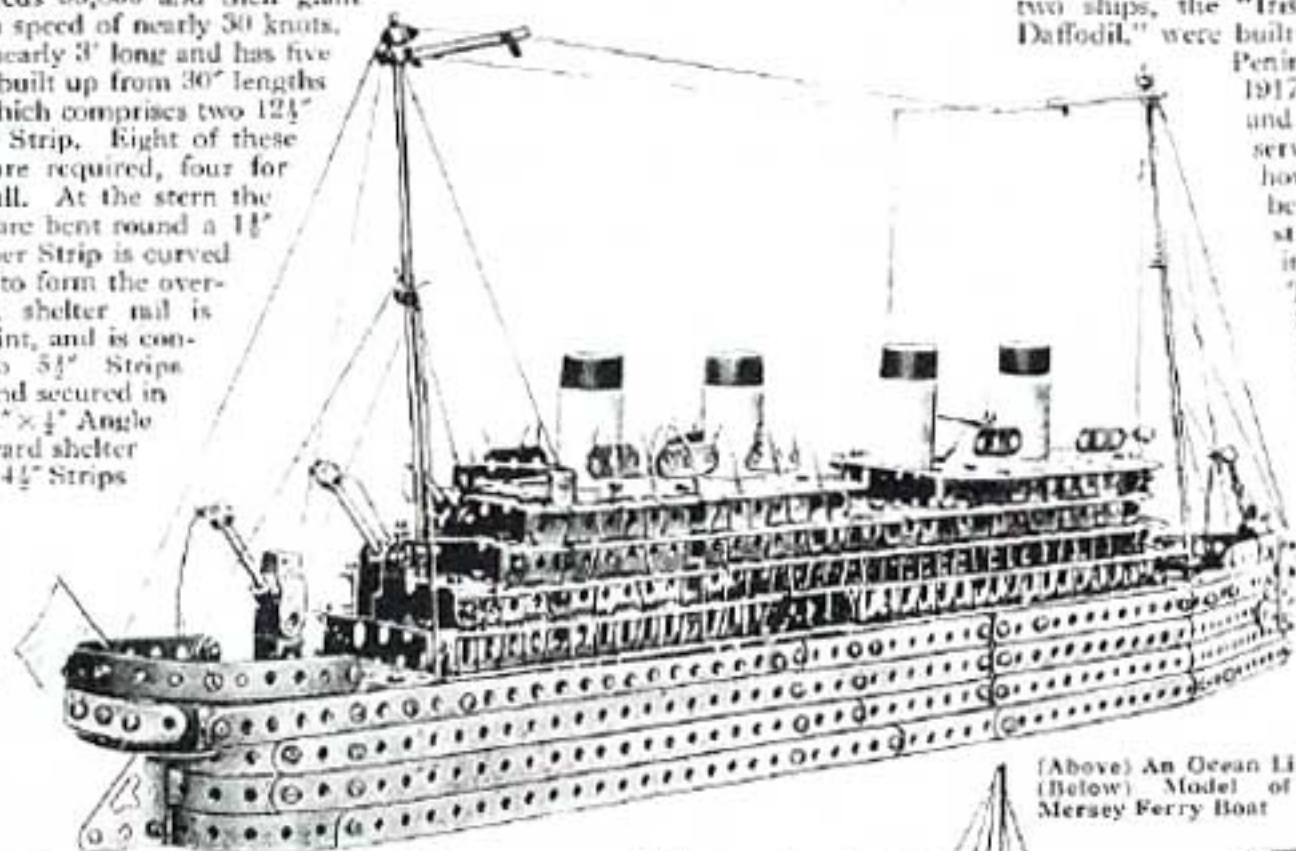

Model No. 78. Mersey Ferry Boat. (W. Caton, Liverpool).

One of the most glorious feats in naval history took place on April 23rd, 1918, when the German submarine base at Zeebrugge was successfully stormed by a British force consisting of over 200 vessels of almost every description. Among this motley collection were included two tiny passenger ships that had been taken from ferry service on the River Mersey. These two ships, the "Iris" and the "Daffodil," later renamed the "Royal Iris" and "Royal Daffodil," were built for ferry passenger service on the River Mersey between the Wirral Peninsula and Liverpool, and they served in this capacity for many years. In 1917 they were taken over by the British Admiralty for special war work, and it was not until nearly a year later that they returned to resume their service on the Mersey. They did not take up their normal work immediately, however, for they were badly damaged, and considerable repairs had to be carried out. Their funnels had to be replaced and new plates substituted for those damaged by shell fire, and in the case of the "Daffodil" it was found necessary to replace the entire superstructure.

The "Daffodil" is the prototype of the fine Meccano model shown below. The boat is 34" long and has a beam of 6½", the height from the keel to the top of the funnel being 13½". The hull is built as in actual practice, the keel first being laid. This is constructed from two 12½" Strips bolted together at their ends, and to it are bolted 16 frames or ribs, eight of which are fitted to each side. The upper edges of the ribs carry ¼" x ¼" Angle Brackets to which the deck plates are bolted. The plating of the sides of the hull is carried out with 5½" and 12½" Strips, bent at the stern to give the correct outline. The stern tubes each consist of three Sleeve Pieces joined together by a 4½" Strip, and the end Sleeve Piece is capped with a ¼" Flanged Wheel, in the boss of which the propeller shaft revolves. The propellers are each made from two Flat Brackets clamped on to the shaft by two Collars, the blades being twisted slightly in order to give them a realistic appearance. The propeller shafts are driven by an Electric Motor hidden inside the hull.

The saloons on the first deck are built up from 5½" x 2½" and 3½" x 2½" Flanged Plates, and are fitted with sliding doors. The forward and after saloons are partly cut away to accommodate two stairways that give access to the upper deck, which is constructed from 5½" x 3½" Flat Plates bolted securely to the tops of the cabins. The outer edges of the upper deck are supported by 2" Strips, the lower ends of which are bolted to the bulwarks of the lower deck.

The upper deck is fitted with a funnel, bridge, ventilators and a boat in davits, and is surrounded by a rail of cord, which is carried by a number of 1" Screwed Rods representing stanchions. Realistic lifebelts are formed from 1" Rubber Rings, and as these are painted white they enhance considerably the appearance of the boat.

Owing to the continual shocks and straining experienced by this type of vessel

when mooring alongside a landing stage in rough weather, thick hemp bumpers are hung over the sides of the lower deck. On the model these great pads have been represented by 1" Pulleys fitted with ½" Rubber Rings.

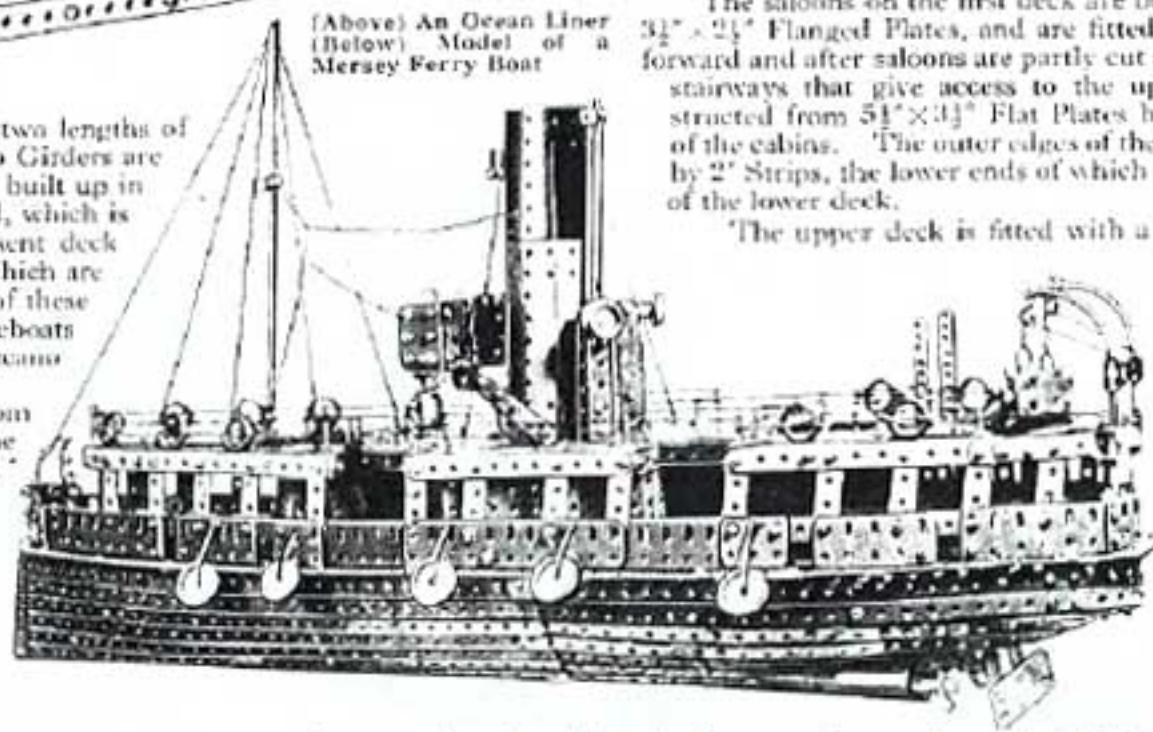

(Above) An Ocean Liner
(Below) Model of a
Mersey Ferry Boat

Model No. 79. Steam Tug Boat. (K. Hart, Bristol).

Model No. 80. Oil Tanker S.S. "Pana." (J. Rodriguez, Montreal).

The hull of the realistic tug-boat shown on this page is composed entirely of rows of Strips bolted end to end, and the rows being joined together side by side by short Strips

bolted across them. Flat Plates are used for filling in the deck spaces, and the bridge superstructure is built on a skeleton framework of Angle Girders. The sides of the engine-room hatch are made from Flat Plates, and the funnel is built from $5\frac{1}{2}$ " Strips bolted at top and bottom to a ring made from a Strip bent into a circle. A Rod held close to the funnel in a Collar represents the exhaust steam pipe. Windmill sails are used for the sides and front of the bridge, which is reached from the deck by means of port and starboard companions made from two 3 " Strips with six $\frac{3}{4}$ " Bolts for the steps. The engine-room skylight is realistically constructed from Flat Girders joined together by Angle Brackets, the roof being hinged to the sides to permit opening.

Model-builders who are able to compare the illustration of the model oil tanker on this page with the actual ship, which was illustrated in the "Meccano Magazine" for June, 1928, will see that remarkably close copying has been done, not only of the principal features of the prototype, but also of the most minute and generally overlooked details. Although the hull of the model possesses an air of distinction it is quite easy to build, and, as will be seen, is constructed principally from Strips. Detail items on the decks include oil hydrants formed from Handrail Supports, anchors, ventilators, winches, and a double skylight over the after cabin. The anchors are two railway wagon couplings taken from Hornby Rolling Stock, with the interlocking links removed and bolted together back to back! For life-belts Rubber Rings are used. These have been carefully and neatly wound with Cord in order to obtain as nearly as possible the true appearance of real life-belts. Another little item of construction that makes a useful contribution towards the realism of the model is the use of Windmill Sails to represent the front rails of the bridge.

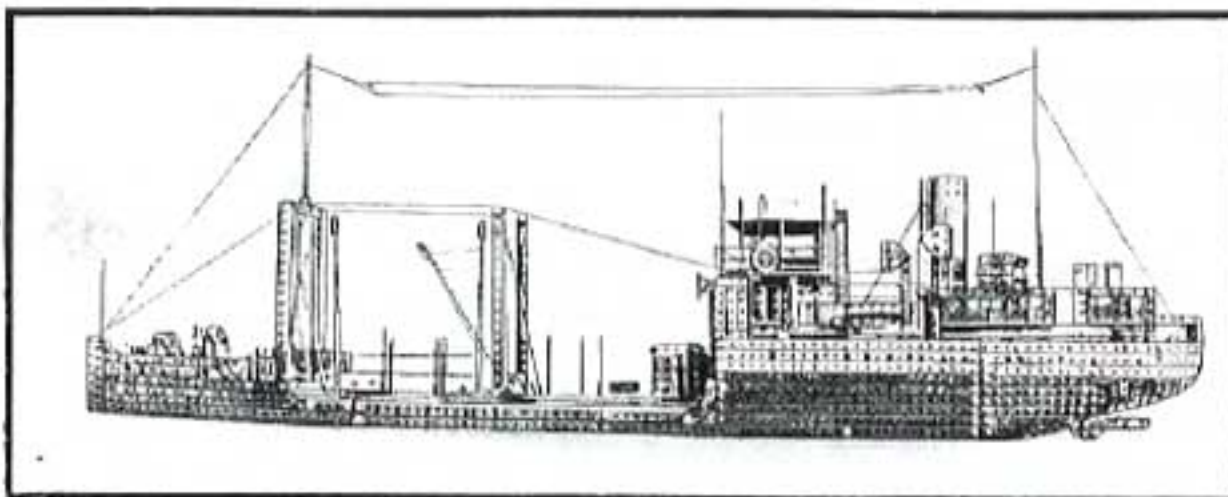
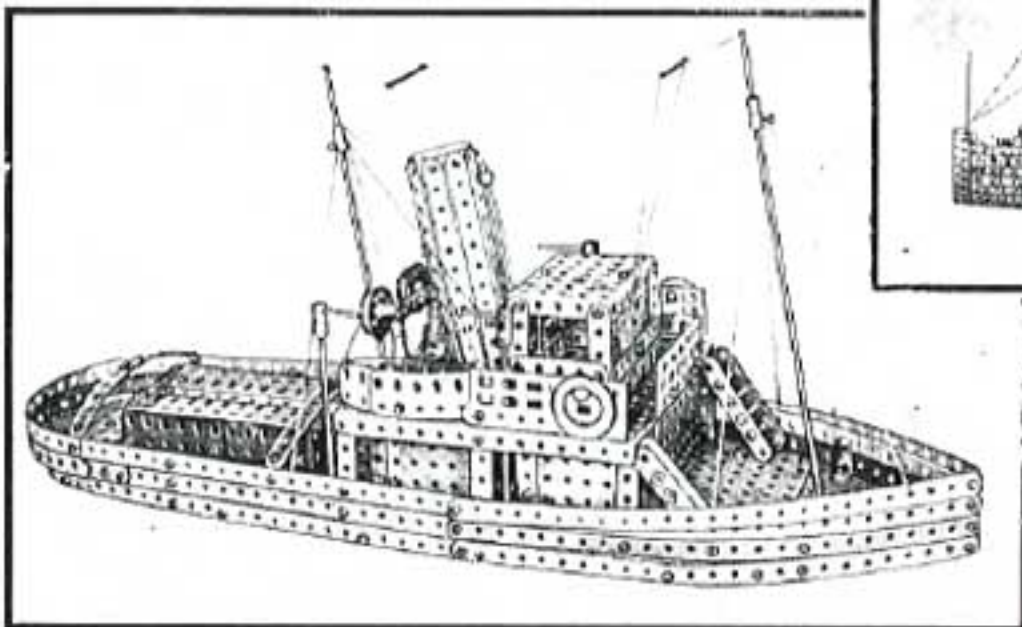

Above) A super-detail model of a typical coastal Oil Tanker.
(Left) A neat Tug-boat.

Model No. 81. Ocean Liner. (W. E. Hunt, London, W.5).

Model No. 82. River Steamer. (J. L. Lee, Bolsover).

Referring first to the ocean liner it will be seen that the hull is constructed from sections of Strips placed side by side and bolted together by cross Strips. Each section of Strips overlaps the other by three holes to give rigidity and strength, and the two sides are joined at the bows, a $3\frac{1}{2}$ " Strip being placed vertically between them.

The promenade decks consist of three $12\frac{1}{2}$ " Angle Girders on each side, which are fixed to the hull with two $3\frac{1}{2}$ " Strips. The raised part of the after deck just behind the promenade decks is made with a $5\frac{1}{2}$ " x $2\frac{1}{2}$ " Flanged Plate, and the stern end of the promenade decks consists of three $5\frac{1}{2}$ " x $\frac{1}{2}$ " Double Angle Strips fixed to the second of the two 3 " Strips at the end of the decks. The stern is made from a $3\frac{1}{2}$ " x $2\frac{1}{2}$ " Flanged Plate, attached to and above which is a $2\frac{1}{2}$ " x $2\frac{1}{2}$ " Flat Plate. The masts are simple and are clearly shown in the illustration.

A very different type of ship from that just described is the river steamer. Each side of the bridge deck consists of two $18\frac{1}{2}$ " Angle Girders bolted back to back and joined together with $5\frac{1}{2}$ " x $3\frac{1}{2}$ " Flat Plates; and underneath this structure are attached six 1 " x 1 " Angle

Brackets each bolted $\frac{1}{2}$ " from the back. The front of the bridge is filled in by two $5\frac{1}{2}$ " Strips, and the sides by a double row of $12\frac{1}{2}$ " and $2\frac{1}{2}$ " Strips placed end to end and overlapped one hole along each side. A space of $\frac{1}{2}$ " is then left to serve as a door, the remainder being filled in by Strips. The funnel consists of $5\frac{1}{2}$ " Strips, and an Axle Rod fastened at the front serves as an exhaust steam pipe. The main deck comprises a framework of $12\frac{1}{2}$ " Angle Girders bolted back to back and joined together by six $5\frac{1}{2}$ " x $3\frac{1}{2}$ " Flat Plates at the stern end and two similar Plates at the bow end.

The long sweeping bow is made from $5\frac{1}{2}$ " Strips, with a short Strip on each side to represent the forecandle. The deck space in the bow is filled in by two Flanged Sector Plates placed side by side. The awning supports over the after deck are constructed from $5\frac{1}{2}$ " x $\frac{1}{2}$ " Double Angle Strips, on the top of which is fastened the cover—a piece of linen wrapped round a $11\frac{1}{2}$ " Axle Rod that is fastened to the bridge deck by a Coupling.

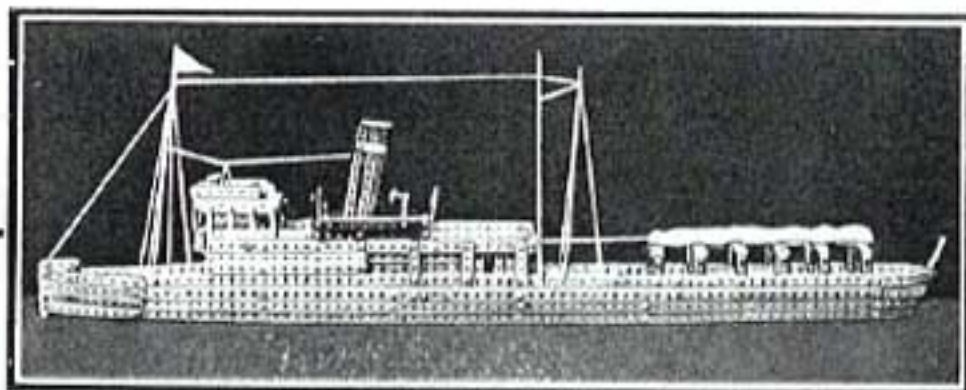

(Above) A River Steamer. (Left) A fine passenger Liner

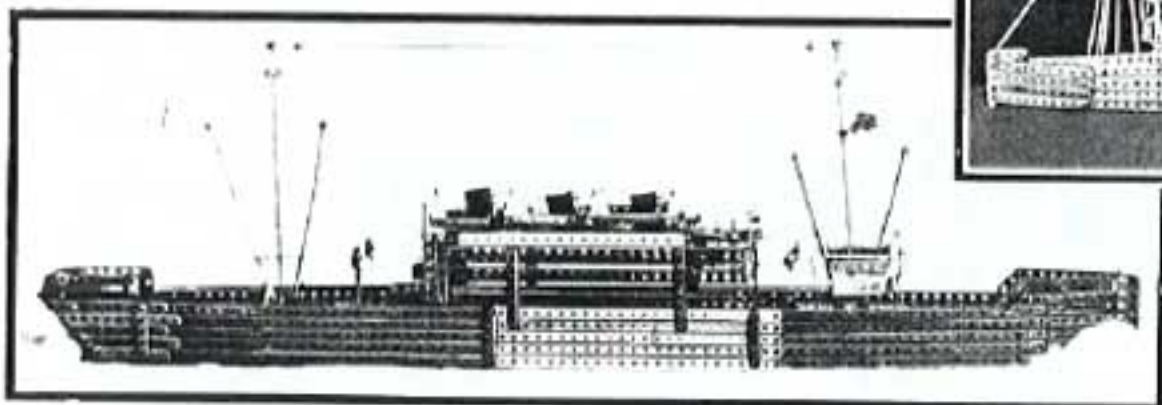

Model No. 83. Desoutter Monoplane. (M. McDonald, Dublin).

The Desoutter cabin monoplane is a popular British machine equipped with a D.H. "Gipsy III" engine that gives a speed of 125 m.p.h. This machine forms the subject of the Meccano model shown in the top illustration on this page.

Each of the four cylinders of the engine consists of a Worm secured by means of a Threaded Rod to a Double Bracket. The four Double Brackets attached to the cylinders are then built into the crank-case of the engine. Valve rods are represented by 1" Rods secured at their upper ends to 1" Triangular Plates by means of Collars. The Triangular Plates are fixed to the Worms by Bolts, each of which passes through one of the holes in its respective Plate, into the threaded hole of the boss of the Worm. The complete engine is secured by four $\frac{3}{4}$ " Bolts to a number of $2\frac{1}{2}$ " \times $\frac{1}{2}$ " Double Angle Strips that form the nose of the aeroplane. The propeller is built up from standard Meccano Propeller Blades and the appearance of a tapered hub is given by the use of a $\frac{1}{2}$ " width $\frac{1}{4}$ " face Pinion and a Collar held on a short Rod.

The sides of the fuselage are constructed from Strips of varying lengths, and Flat Plates and Strips are used for the top and underside. A door is fitted to one side of the hull, but it will be noted that this opens in the wrong direction. In actual practice the door hinges are always placed on the side of the door nearest to the nose of the machine so that the wind pressure, when the machine is in flight, will prevent the door from opening.

The tailplane consists of two $4\frac{1}{2}$ " \times $2\frac{1}{2}$ " Flat Plates and the rudder is represented by a third plate of similar size. A $2\frac{1}{2}$ " Large Radius Curved Strip gives the rudder a neat appearance. In the model the tail skid has been replaced by a rubber shod 1" Fast Pulley, and although this is unusual it does not look out of place.

The wings are built in one piece from $12\frac{1}{2}$ " Strips and are secured by Angle Brackets to the hull so that they form the roof of the cabin. The front windows of the cabin have been cleverly represented in the model, and by judicious use of parts many awkward corners have been filled in.

The landing gear is suspended from both the wings and the fuselage and although it is incorrect to use an unbroken wheel axle with oleo legs it adds a certain amount of strength to the undercarriage of the model.

Model No. 84. Do.X. Flying Boat. (G. R. Home, Bristol).

During the last year the great German flying boat DO.X., which recently has returned to Germany from America, was a very popular subject with Meccano model-builders. The centre illustration on this page shows one of the many models submitted in a Meccano Competition that was organised recently. The contest was devoted entirely to aeroplane subjects and hundreds of excellent models were sent in.

The hull of this model is built up from $12\frac{1}{2}$ " Strips, the doors and windows being shaped by the use of shorter Strips. The inside of the hull contains seats and bulkheads, and the pilot's cabin is situated above the main hull immediately beneath the wings. The cabin also serves as a support for the wings.

The tail unit of the model is of sturdy construction, and is built up from a number of Flat Plates. The tailplane consists of two $5\frac{1}{2}$ " \times $2\frac{1}{2}$ " Flat Plates, braced to the end of the hull by means of $5\frac{1}{2}$ " Strips; and the tail is a $4\frac{1}{2}$ " \times $2\frac{1}{2}$ " Flat Plate fitted with a $2\frac{1}{2}$ " Triangular Plate.

The mainplane is constructed from $12\frac{1}{2}$ " Strips and $5\frac{1}{2}$ " \times $3\frac{1}{2}$ " Flat Plates, and it measures 2' 4" in length and $5\frac{1}{2}$ " in width. It is secured at its centre to the roof of the pilot's cabin and is braced by four $7\frac{1}{2}$ " Strips on the underside, the lower ends of the Strips being bolted to floats secured to the hull. The floats are constructed from $3\frac{1}{2}$ " and $2\frac{1}{2}$ " Strips and $\frac{1}{2}$ " \times $\frac{1}{2}$ " Angle Brackets bolted together to form a square frame.

The most outstanding feature of the actual machine is the position of the engines and propeller, and in the model they are mounted, as in the original, on a built-up platform of Strips on top of the mainplane.

Each engine is represented by three $2\frac{1}{2}$ " \times $\frac{1}{2}$ " Double Angle Strips bolted together, and an Axle Rod, passing through the centre of the engine, carries a propeller on each end.

There are twelve propellers, each of which is constructed from $2\frac{1}{2}$ " Strips and secured to the

centre Rods of the engines by Double Arm Cranks.

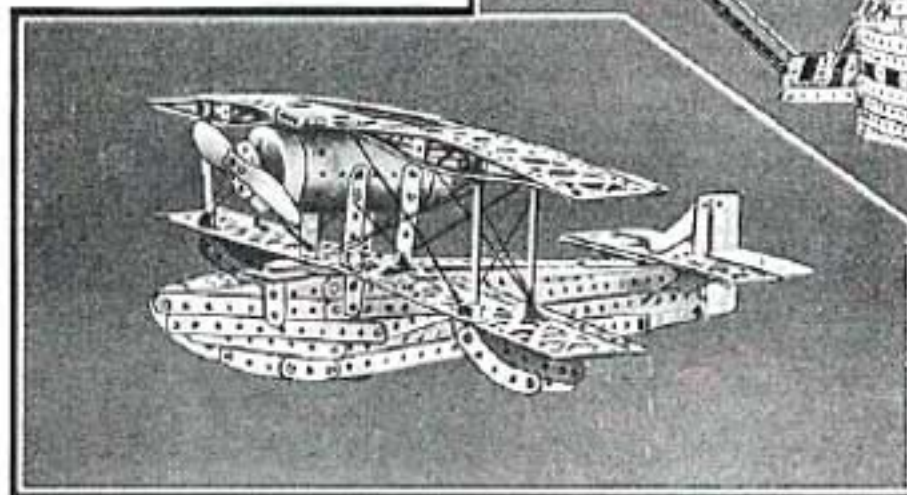
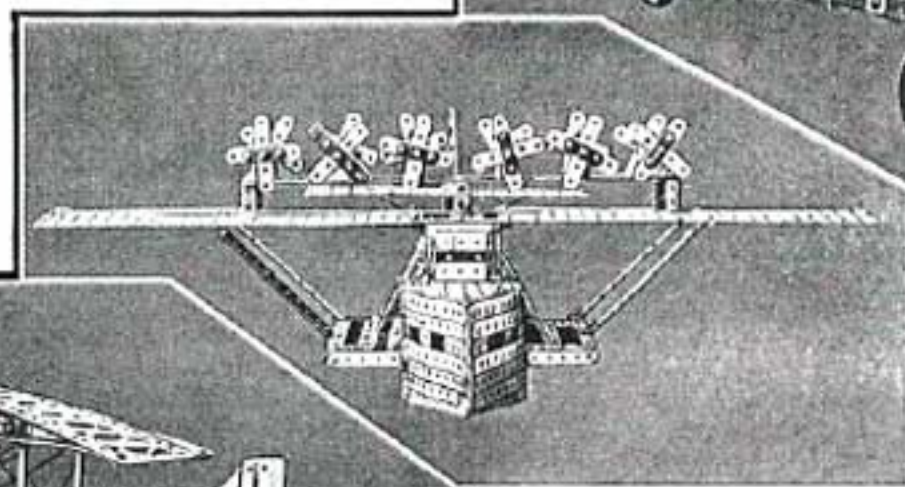
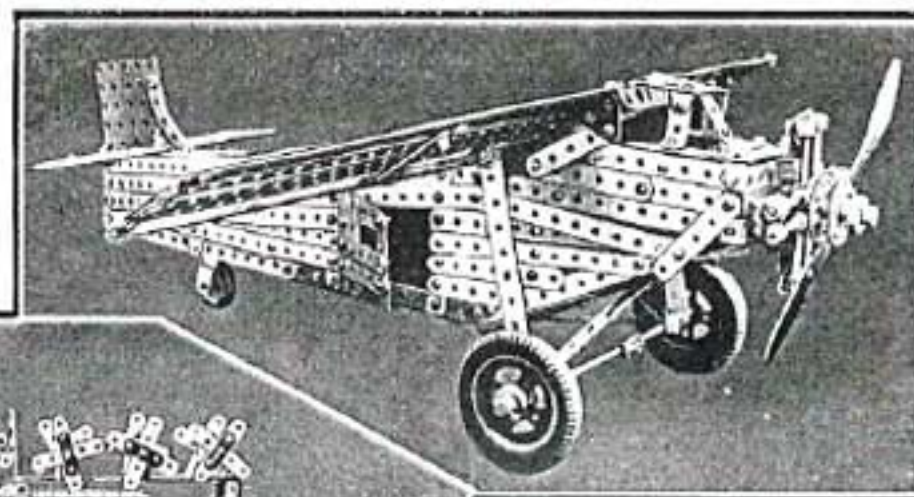

(Top) Desoutter Monoplane.
(Centre) A model of the German Flying Boat DO.X.
(Bottom) Flying Boat.

Model No. 85. Vickers Vedette Flying Boat (G. Moore, London, E.3)

Although the prototype of this model is a difficult subject to reproduce in Meccano, its shape and general appearance are well displayed by the model shown in the bottom illustration on this page. Sharp-eyed constructors will discover several novel uses for various Meccano parts in the model.

The fuselage is built up from a number of various-sized Strips, and the sweep of the nose has been very cleverly shaped with the aid of short Strips and two $2\frac{1}{2}$ " Large Radius Curved Strips. The hull of the model is 17" long and its greatest width is $2\frac{1}{2}$ ". At the rear it tapers nearly to a point, and a long rudder consisting of a $3\frac{1}{2}$ " Flat Girder gives the impression of a sharp trailing edge. The leading edge of the upper half of the rudder is fitted with a $2\frac{1}{2}$ " Curved Strip. The tailplane is represented by one $5\frac{1}{2}$ " Braced Girder, and the ailerons, which are formed from $2\frac{1}{2}$ " Braced Girders, are bolted to each side of the rear edge. The wings are constructed from $12\frac{1}{2}$ " Braced Girders and the upper and lower planes are connected together by four $3\frac{1}{2}$ " Rods, the bracing wires being represented by lengths of Meccano Cord. Floats are attached to the outer extremity of each lower wing, and these are built up from $3\frac{1}{2}$ " Strips and $2\frac{1}{2}$ " Large Radius Curved Strips, the necessary attachments being made by $\frac{1}{2}$ " \times $\frac{1}{2}$ " Angle Brackets.

The engine casing consists of a Boiler, complete with Ends, bolted to the underside of the upper wings, and also attached to the lower wing by means of four $2\frac{1}{2}$ " Strips. An Axle Rod passing through the centre holes of the two Boiler Ends carries the propeller at one end, and a Collar is fitted on the opposite end to secure the propeller in place. The two blades of the propeller overlap each other two holes, and the Bolts passing through these holes are used for securing the blades to a Bush Wheel.

Model No. 86. Giant Flying Boat Do.X.
(H. B. Bell, Hoylake, Cheshire).

The sides of the hull of the model are built up from $12\frac{1}{2}$ " Strips and $5\frac{1}{2}$ " \times $3\frac{1}{2}$ " Flat Plates, and the bows are represented by two $2\frac{1}{2}$ " Small Radius Curved Strips. The two sides are spaced apart at bow and stern by two Flanged Sector Plates, and the uncovered spaces at each end of the hull are filled in with $2\frac{1}{2}$ " Strips. The remainder of the top of the hull is covered in with three $5\frac{1}{2}$ " \times $2\frac{1}{2}$ " and two $3\frac{1}{2}$ " \times $2\frac{1}{2}$ " Flanged Plates. Doors are represented by $2\frac{1}{2}$ " Flat Girders secured in place by means of Hinges.

The vertical fin at the tail consists of a $5\frac{1}{2}$ " \times $2\frac{1}{2}$ " Flat Plate, the outer edges being formed by the use of $2\frac{1}{2}$ " Strips and $2\frac{1}{2}$ " Curved Strips. Each elevator comprises two $3\frac{1}{2}$ " \times $2\frac{1}{2}$ " Flanged Plates rigidly joined together by two $2\frac{1}{2}$ " Strips, and the complete unit is secured to the tail fin by means of two $\frac{1}{2}$ " \times $\frac{1}{2}$ " Angle Brackets. The elevators are braced to the hull by means of four $3\frac{1}{2}$ " Strips, two of which are bolted to each elevator. The necessary connections are made by means of Flat Brackets bent to the required shape.

The two edges of each half of the main plane consist of $12\frac{1}{2}$ " Angle Girders and the intervening space between them is filled in by alternate $5\frac{1}{2}$ " \times $2\frac{1}{2}$ " Flat Plates and $5\frac{1}{2}$ " \times $2\frac{1}{2}$ " Flanged Plates. Each half of the main plane is fitted on its underside with three bracing members consisting of $7\frac{1}{2}$ " Strips, the lower ends of which are attached by means of Angle Brackets to $3\frac{1}{2}$ " \times $2\frac{1}{2}$ " Flanged Plates projecting from the lower portion of the hull. The Flanged Plates represent floats, and they are held in place by means of $3\frac{1}{2}$ " Angle Girders. The front edge of the plane over the hull rests against the control cabin, which consists of a $2\frac{1}{2}$ " \times $2\frac{1}{2}$ " Flat Plate fitted with a Face Plate. The sides and front of the cabin are formed from a single $9\frac{1}{2}$ " Strip curved to the desired shape.

The upper face of the main plane is fitted with six engine housings, each of which is built up from two $3\frac{1}{2}$ " Flat Girders joined together by means of four Double Brackets. In the illustration the flying boat is mounted on a catapult, by means of which it is possible to send it racing along the ground.

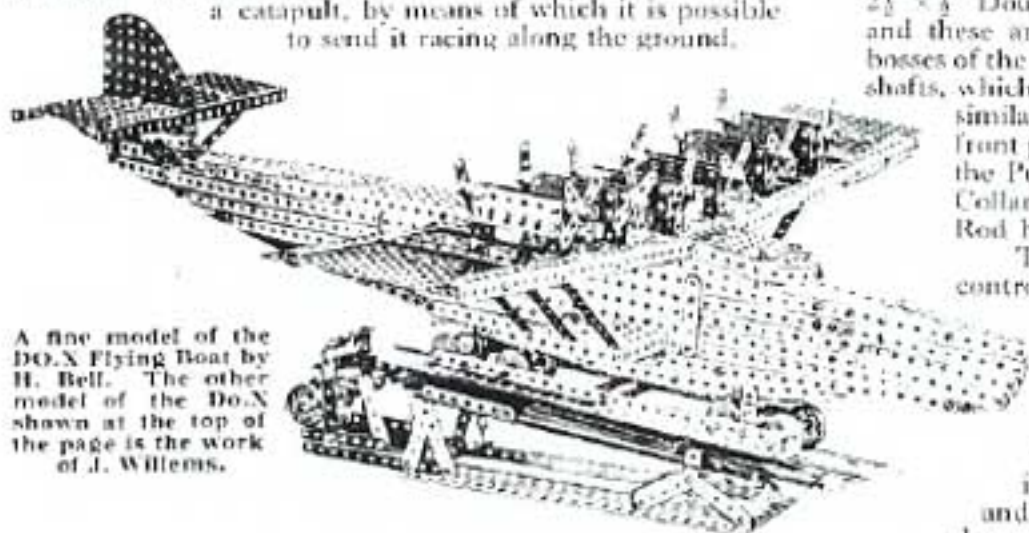

A fine model of the DO.X Flying Boat by H. Bell. The other model of the Do.X shown at the top of the page is the work of J. Willems.

Model No. 87. Do.X. Flying Boat with Driven Propellers.

(J. Willems, Hoboken, Antwerp).

Each side of the fuselage is built up from $12\frac{1}{2}$ " Flat Girders and

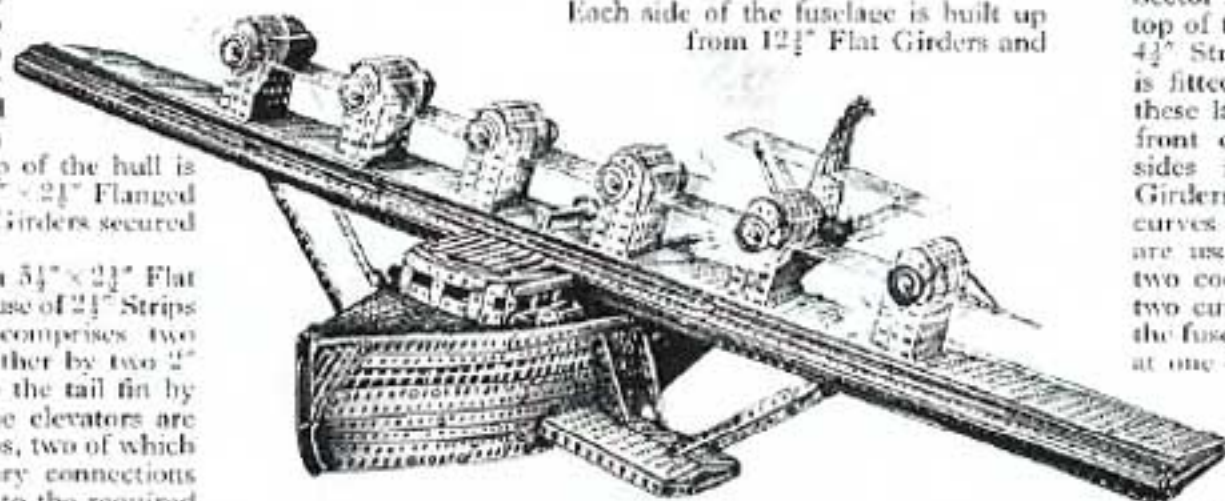

Strips, the bow being formed from $4\frac{1}{2}$ ", $3\frac{1}{2}$ " and $1\frac{1}{2}$ " Strips, and the top is covered in at the front by means of $12\frac{1}{2}$ " Strips, and at the rear by similar Strips and Flanged Sector Plates. The rudder consists of a vertical $4\frac{1}{2}$ " \times $2\frac{1}{2}$ " Flat Plate, the edges of which are fitted with $5\frac{1}{2}$ " and $2\frac{1}{2}$ " Curved Strips as shown in the illustration. To this Plate are secured $5\frac{1}{2}$ " \times $2\frac{1}{2}$ " Flat Plates representing the tail planes, and two bracing members secured to the underside of these are attached to the rear of the fuselage.

The main plane consists of $5\frac{1}{2}$ " \times $3\frac{1}{2}$ " Flat Plates on both its under and upper side, and these are bolted to a framework of Strips, the leading edge being streamlined with the aid of $12\frac{1}{2}$ " Strips, bolted together in 60° lengths.

The upper face of the wing carries six engine housings, each of which is constructed from two $3\frac{1}{2}$ " \times $2\frac{1}{2}$ " Flanged Plates secured together at their flanges by means of four $1\frac{1}{2}$ " Strips, the spaces between them being filled in by $3\frac{1}{2}$ " Strips. The top of the housing consists of three $2\frac{1}{2}$ " \times $\frac{1}{2}$ " Double Angle Strips bolted to two Bush Wheels, and these are attached to the two Flanged Plates. The bosses of the Bush Wheels serve as bearings for the propeller shafts, which carry a $1\frac{1}{2}$ " fast Pulley at one end and two similar Pulleys at the other end. The front propeller is placed on the Rod against the Pulley and is clamped in position by a Collar. The rear propeller is held on the Rod between the other two Pulleys.

The drive from an Electric Motor in the control cabin is transmitted by an endless belt to one of the Pulleys on one of the centre pair of propeller shafts, and each of the Pulleys on the rear ends of the other shafts is connected by a belt to its neighbour, so that the Motor drive is transmitted to all twelve propellers. In the illustration the propellers are shown in motion and their effect when revolving at a comparatively slow speed adds greatly to the realism of the model.

Model No. 88. Bombing Biplane.

(R. Atter, Tyseley, Birmingham).

At the nose the sides of the fuselage consist of Flanged Sector Plates and the nose itself is a $3\frac{1}{2}$ " Pulley Wheel. The top of this section of the fuselage is built from two curved $4\frac{1}{2}$ " Strips that support seven $12\frac{1}{2}$ " Strips, each of which is fitted at the rear end with a $2\frac{1}{2}$ " Strip. The ends of these latter Strips are moulded into the front edge of the front cockpit. The remaining portion of the fuselage sides is constructed from $12\frac{1}{2}$ " Strips and $12\frac{1}{2}$ " Flat Girders, and at the rear, where the lower face of the fuselage curves upward to meet the top face, $5\frac{1}{2}$ " Curved Strips are used. The curved top of the fuselage between the two cockpits is built up from seven $3\frac{1}{2}$ " Strips bolted to two curved $4\frac{1}{2}$ " Strips, and the rear portion of the top of the fuselage consists of six $12\frac{1}{2}$ " Strips. These are attached at one end to a $4\frac{1}{2}$ " Strip at the back of the rear cockpit, and their other ends are then brought together at one point at the extremity of the model where they are secured in position by a $\frac{1}{2}$ " Bolt to a Double Bracket.

The tail plane is built up from three $5\frac{1}{2}$ " \times $2\frac{1}{2}$ " Flat Plates and it is secured in place by means of four $1\frac{1}{2}$ " \times $1\frac{1}{2}$ " Angle Brackets. The three rudders are each constructed from one $2\frac{1}{2}$ " Triangular Plate and one $2\frac{1}{2}$ " \times $2\frac{1}{2}$ " Flat Plate. The connection between the two Plates is made by means of two $1\frac{1}{2}$ " Strips, and the complete unit is held in place by means of a $2\frac{1}{2}$ " Angle Girder. Meccano Bare Iron Wire is used for the control wires, which are secured to the elevators and rudders, and then pass into the fuselage at a point behind the rear cockpit.

The main plane is built from $5\frac{1}{2}$ " \times $3\frac{1}{2}$ " Flat Plates, the ends being shaped with short Strips and $2\frac{1}{2}$ " Curved Strips. The plane is fastened to the fuselage by means of two Double Bent Strips. The lower wings are each represented by a $5\frac{1}{2}$ " \times $3\frac{1}{2}$ " Flat Plate shaped at the ends in a similar manner to the main plane, and are held in place by $\frac{1}{2}$ " \times $\frac{1}{2}$ " Angle Brackets.

Short Rods, Couplings and Handrail Supports are used in building the miniature guns on the main plane, and the engines are built up from Worms attached to $\frac{1}{2}$ " \times $\frac{1}{2}$ " Angle Brackets by means of Threaded Pins. The complete units are held in place by $\frac{1}{2}$ " Bolts and $1\frac{1}{2}$ " \times $\frac{1}{2}$ " Angle Brackets.

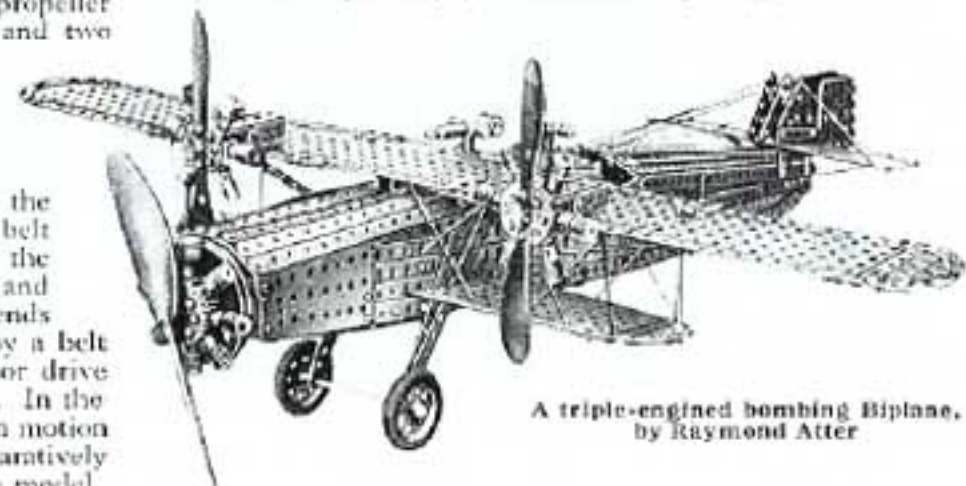

A triple-engined bombing Biplane, by Raymond Atter

Model No. 89. Two-Seater Low Wing Monoplane. (P. Senft, Barr, France).

Monoplanes may be divided into three main classes known as the low wing, high wing and parasol types. In the low wing machines the wings are secured to the sides of the fuselage near the lower edge, and in the high wing monoplanes they are attached higher up, sometimes being secured across the top of the fuselage. Parasol monoplanes are really of the high wing type, but in these the wing is raised above the fuselage by means of struts. The model monoplane described here is of the low wing type and is similar in many respects to the Avro "Avian Monoplane," a British machine in this class. The fuselage of the model is built up of Angle Girders and Strips. Four $1\frac{1}{2}$ " Angle Girders form the frame for the rear section of the fuselage, and at the tail are spaced apart $1\frac{1}{2}$ " and secured at each side to a $2\frac{1}{2}$ " Strip, the lower hole of which forms a bearing for a Rod carrying one of the landing wheels. The tail is extended by Flat Girders. At the front of this section the Angle Girders are spaced apart by $2\frac{1}{2}$ " Strips, and are extended by means of $5\frac{1}{2}$ " Angle Girders joined at the nose by a 3 " Angle Girder at each side, and by $3\frac{1}{2}$ " \times $\frac{1}{2}$ " Double Angle Strips across the top and bottom. The nose is formed from four Sector Plates attached to the fuselage by Angle Brackets. Strips of various lengths are used for filling in the spaces between the Angle Girders, but in the top of the fuselage openings are left for two cockpits. These are fitted with Trunnions at each side and the celluloid windscreens are gummed between them.

A miniature three-cylinder air-cooled engine is mounted at the nose, and the cylinders are represented by Worm Wheels fixed in place by Angle Brackets. In the illustration the Clockwork Motor drive to the air

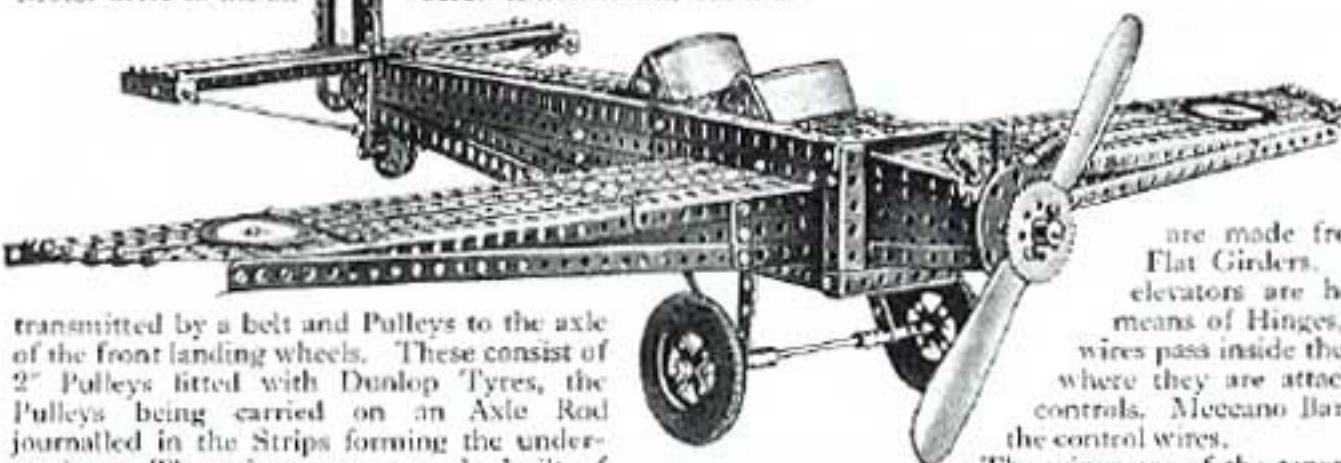

transmitted by a belt and Pulleys to the axle of the front landing wheels. These consist of 2 " Pulleys fitted with Dunlop Tyres, the Pulleys being carried on an Axle Rod journaled in the Strips forming the undercarriage. The wings are strongly built of Angle Girders connected together by 3 " Strips, the space between them being filled in with longitudinal Strips. The tail plane is constructed in a similar manner, and at right-angles to this the fin and rudder are fixed, these being made up of Strips and Curved Strips.

Model No. 90. Long Distance Monoplane. (G. Humiere, Versailles).

The fine model shown in the upper illustration on this page represents a type of monoplane used for long-distance passenger flights. The rear of the fuselage of the model is cleverly moulded by carefully bent $12\frac{1}{2}$ " Strips, and bent $5\frac{1}{2}$ " Strips are used for

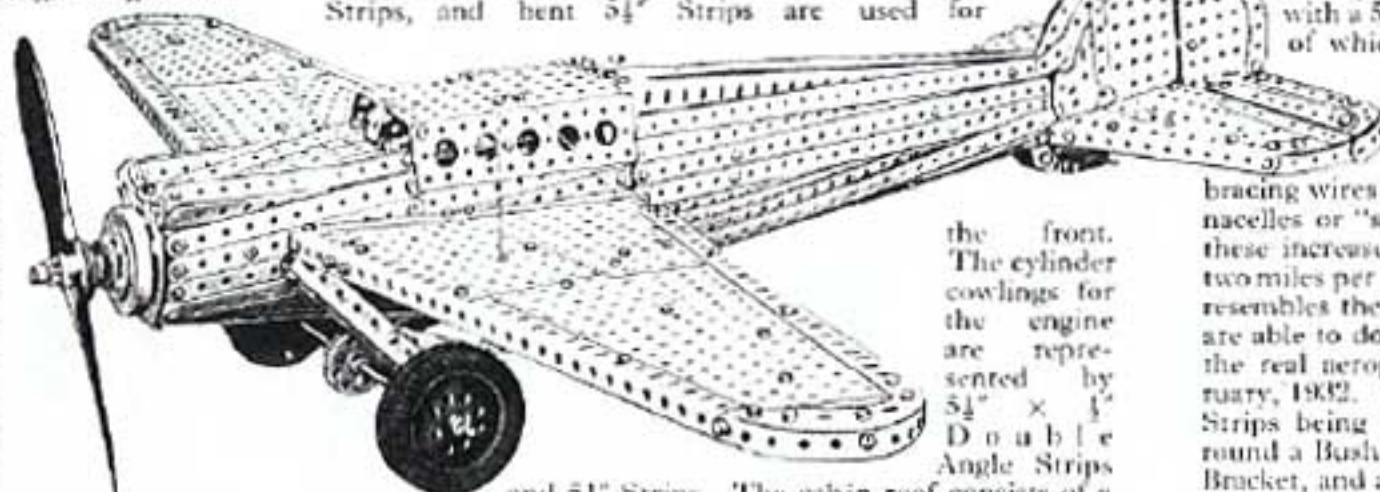

the front. The cylinder cowlings for the engine are represented by $5\frac{1}{2}$ " \times $\frac{1}{2}$ " Double Angle Strips and $5\frac{1}{2}$ " Strips. The cabin roof consists of a $5\frac{1}{2}$ " \times $2\frac{1}{2}$ " Flanged Plate, and each side of the cabin is built up from two 3 " \times $1\frac{1}{2}$ " Flat Plates that overlap each other two holes, and in which $\frac{1}{4}$ " holes are drilled to represent the windows. It is, of course, bad practice to mutilate Meccano parts to this extent, and it is better to use 1 " loose Pulleys bolted to the Plates. The complete cabin is secured in place by means of two Double Brackets, and at the rear is moulded into the fuselage by a long sloping projection constructed from two $12\frac{1}{2}$ " Angle Girders. The space between these two Girders is filled in by means of three $12\frac{1}{2}$ " Strips, the ends of which are brought together and bolted at one point at the rear of the model.

The rudder is built up in two separate units, each of which consists of two $3\frac{1}{2}$ " \times $2\frac{1}{2}$ " Flanged Plates fitted with two Face Plates. The rounded outside edge is obtained by using $2\frac{1}{2}$ " Large Radius Curved Strips. The tail planes are each built up from a Sector Plate and a $4\frac{1}{2}$ " \times $2\frac{1}{2}$ " Flat Plate, and the elevators are made from $5\frac{1}{2}$ " and $4\frac{1}{2}$ " Flat Girders. The rudder and elevators are held in place by means of Hinges, and the control wires pass inside the fuselage to the cockpit, where they are attached to their respective controls. Meccano Bare Iron Wire is used for the control wires.

The wings are of the tapered type, and are neatly constructed from $5\frac{1}{2}$ " \times $3\frac{1}{2}$ " and $5\frac{1}{2}$ " \times $2\frac{1}{2}$ " Flat Plates. An edging consisting of two $12\frac{1}{2}$ " Angle Girders and a curved $5\frac{1}{2}$ " Strip is provided to each wing. The $5\frac{1}{2}$ " Strip is bent round the outside of a $2\frac{1}{2}$ " Small Radius Curved Strip, and is bolted to the ends of the two $12\frac{1}{2}$ " Angle Girders.

Model No. 91. Fairey Long Range Monoplane. (G. S. Thomson, Pinner, Middlesex).

The actual machine from which this model is copied is designed for endurance and speed, with a minimum fuel consumption. It is a single-engined high wing monoplane with a totally enclosed cabin, and is fitted with a 530 h.p. Napier "Lion" engine, the carburettor of which is specially tuned to keep the fuel consumption as low as possible. The monoplane is 48' 6" in length, 12' in height, and has a wing span of 82'. The wings and tail are of the cantilever type, and the only external

bracing wires are those supporting the tail fin. Streamlined nacelles or "spats" are fitted over the wheels, and although these increase the weight of the machine slightly, they add two miles per hour to the speed. The Meccano model closely resembles the actual machine in appearance, and those who are able to do so should compare it with the illustrations of the real aeroplane in the "Meccano Magazine" for February, 1932. The fuselage is constructed from Strips, $5\frac{1}{2}$ " Strips being bolted at the nose to Angle Brackets secured round a Bush Wheel. Two Strips are bolted to each Angle Bracket, and at their opposite ends they are spaced out and secured round the periphery of a Face Plate. The $5\frac{1}{2}$ " Strips are extended by $12\frac{1}{2}$ " Strips tapering towards the rear end, where they are secured round the rim of a Bush Wheel by means of Angle Brackets. They are extended by further $5\frac{1}{2}$ " Strips that taper almost to a point and are bolted to Double Brackets at the tail. The main plane is composed of four $5\frac{1}{2}$ " \times $3\frac{1}{2}$ " Flat Plates bolted to Angle Girders that form the front edge of the plane. Two $2\frac{1}{2}$ " Curved Strips are bolted to each end and the spaces so formed are filled in with Strips. The tail is made of two $4\frac{1}{2}$ " \times $2\frac{1}{2}$ " Flat Plates with a $2\frac{1}{2}$ " large radius Curved Strip bolted across their ends. Angle Brackets secure the Plates to the fuselage. To form the fin and rudder, Strips are bolted to a $2\frac{1}{2}$ " vertical Flat Girder, and the fin is fixed between two Double Brackets bolted to the top $5\frac{1}{2}$ " Strips of the fuselage.

The undercarriage is made of Strips, and 1 " Pulley Wheels fitted with Dunlop Tyres are used for landing

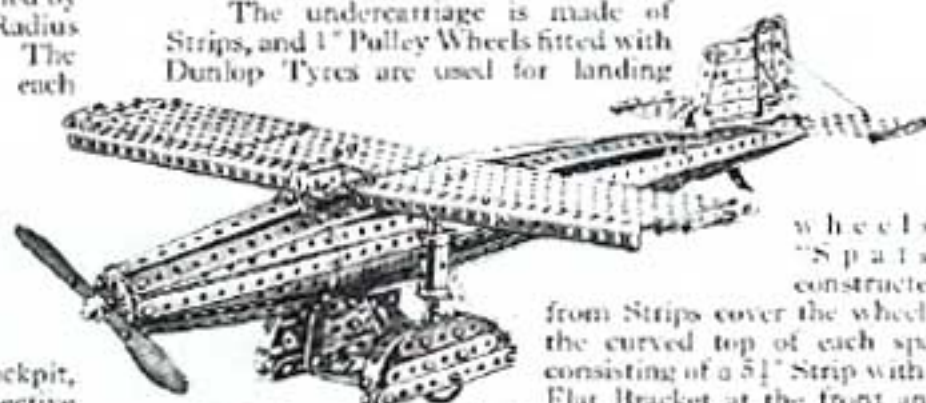

wheels. "Spats" constructed from Strips cover the wheels, the curved top of each spat consisting of a $5\frac{1}{2}$ " Strip with a Flat Bracket at the front and a $1\frac{1}{2}$ " Strip at the rear. Double Arm Cranks fitted to the $5\frac{1}{2}$ " Strips carry Axle Rods on each of which two $\frac{1}{2}$ " Flanged Wheels are mounted, the upper ends of the Rods being attached to the underside of the wings. Sleeve Pieces fitted between the Flanged Wheels represent the shock absorbers. The sides of the nacelles are filled in with $4\frac{1}{2}$ ", $3\frac{1}{2}$ " and $2\frac{1}{2}$ " Strips. Each end of the long Strip is attached to a Double Bracket fitted to the built-up curved strip.

Model No. 92. C.N.R. Locomotive. (A. S. Park, Calgary, Canada).

The subject of this model is one of the latest Canadian National Railway locomotives of the K-5-a class, the numbers of which range between 5700 and 5704. These great Hudson locomotives are used for fast passenger service on two or more divisions of the Montreal and Chicago run and they are also used for hauling the *International Limited* train. They were constructed at the Montreal Locomotive Works at the end of 1830, and are amongst the most powerful locomotives designed and constructed by this firm.

They have an overall length of 92' 6½" and in working order they weigh, with tender, 652,200 lbs. The boiler is of the straight top type with radially stayed fire-box and it has a diameter of 7' 2", with a working pressure of 275 lb. per square inch. In order to save weight this part of the engine has been constructed from high-tensile silicon steel.

The fire-box is very large and roomy, measuring 10' 6" in length and 7' 1" in width, and is constructed throughout of steel. The cylinders are 23" in diameter with a stroke of 28"; and the driving wheels are 6' 8" in diameter and are fitted with steel hub liners made in a single piece. The axles on which the wheels are carried are of hammered carbon steel, quenched and drawn in oil. The driving journals are 12" in diameter and 13" in length.

The bogie wheels have a diameter of 2' 10½" and are made from cast-iron, the tyres being of forged steel. The rear bogie, situated under the fire-box, is fitted with a booster for the purpose of increasing the nominal tractive effort of the engine from 43,300 lb. to 53,300 lb. The cylinders, valves and guide bars are lubricated by six-feed mechanical lubricators with a total capacity of 20 pints, this amount being necessary on account of the long runs made by the engines. A hydrostatic lubricator in the cab distributes oil to the various auxiliaries.

The tender is carried on 12 wheels and has a capacity of 20 tons of coal and 14,000 gallons of water, the total weight being 305,600 lb. In the actual engine the main frames, together with all cross ties, front buffer beam, rear boiler cradle, cylinders and the air reservoirs, are cast in one piece of solid steel.

The model illustrated here differs from the original in that it is fitted with Walchaerts valve gear instead of the Baker-Pillio gear fitted to the actual engine. Very close examination is necessary, however, to detect the difference between the two kinds of gear. Reversing is carried out by means of a handle in the cab of the engine, and an interesting lever mechanism is fitted that enables the movement of the reversing link to be transmitted to the reversing lever of the 6-volt Electric Motor by means of which the model is driven. In this manner the valve gear is made to appear responsible for the reversing of the locomotive. The coupled wheels are all sprung, and each separate wheel is carried on compensating levers.

The boiler of the model is 7" in diameter over its entire length, and its fittings include

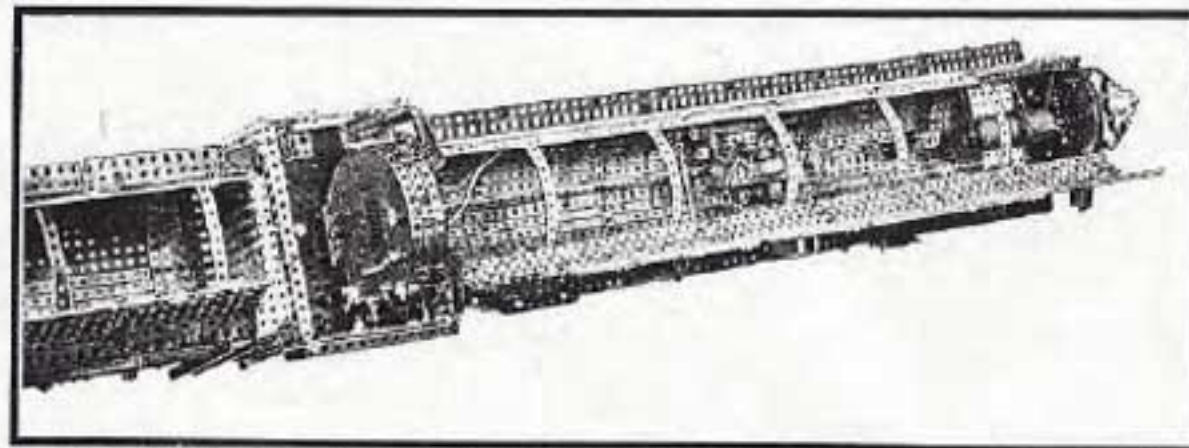
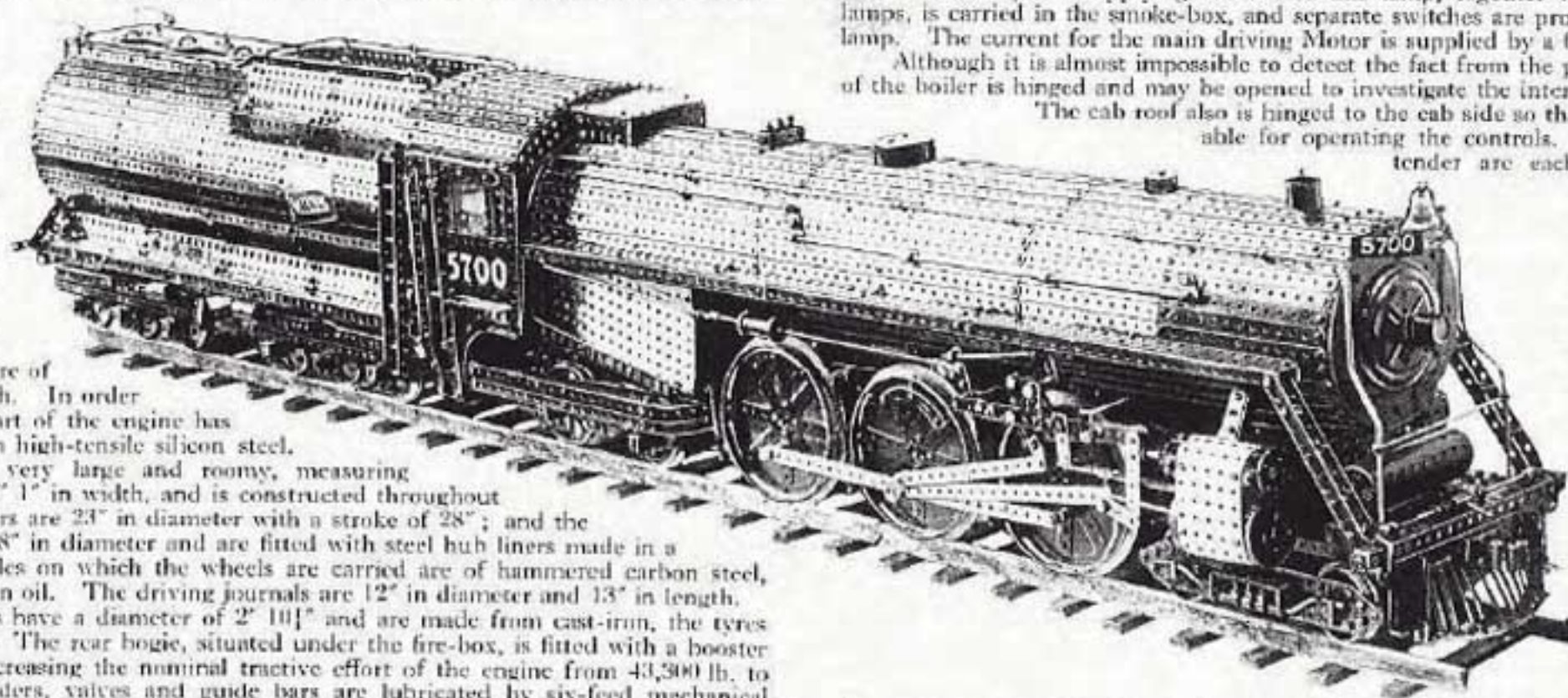

The upper photograph is a general view of the Meccano model C.N.R. locomotive, and shows the valve gear and driving-wheel arrangement. The lower illustration is a plan view of the model, showing the hinged top of the boiler open.

safety valves, steam dome, whistle, bell and headlamp. The front of the locomotive carries an air reservoir, a neat cow-catcher, and steps that give access to a platform running the length of the boiler.

The cab is a good representation of the short vestibule type usually fitted to these engines, and the boiler fittings include water and steam gauge, power reverse lever, injector control and a brake lever. The interior is illuminated by a 6-volt lamp situated in the roof. A battery for supplying current to this lamp, together with the head and tender lamps, is carried in the smoke-box, and separate switches are provided in the cab for each lamp. The current for the main driving Motor is supplied by a 6-volt Transformer.

Although it is almost impossible to detect the fact from the photograph, the entire top of the boiler is hinged and may be opened to investigate the interior working of the model.

The cab roof also is hinged to the cab side so that plenty of space is available for operating the controls.

The two bogies of the tender are each fitted with six wheels constructed from Wheel Flanges and Face Plates, the complete units being attached to the tender frame by means of Ball Bearings. Each axle of the bogies is sprung by means of spiral springs, and realistic axle boxes are fitted to each wheel. Dummy vacuum brake cylinders and track sprinklers add to the realistic appearance of the tender. The main body, which in actual practice carries the water, is constructed from a number of 12½" Strips, and its rear consists of a Circular Plate on which are mounted

the automatic coupler, vacuum brake connections, ladder, electric lamps and buffers. The automatic coupler is built up from Flat Brackets and Couplings and its action is similar to a spring jaw trap. It is attached to the tender by means of a Double Bracket and a 1" Axle Rod. The vacuum brake connections are represented by Springs carried on a 2" Rod and held in place by Collars. The springs should be curved slightly in order to obtain a realistic effect. The ladder is built up from two 7½" Strips that are secured parallel to each other by

two Double Brackets, the steps being formed from 1" Threaded Rods held in place by lock-nuts. The electric lamps, three in number, are built up from Chimney Adaptors secured to the tender by ½" x ½" Angle Brackets. Small bulbs fitted in these are operated by the battery in the smoke-box. The forward end of the almost circular tank is cut away in the form of a square well, which is used for carrying coal. An enclosing wall is fitted round the top of the well and a fine effect is obtained by the use of handrails. A sliding door is provided to enable the coal to be man-handled in case of emergency, but normally the furnace is fed by a mechanical stoker.

Three filling ports or manholes (Wheel Flanges) are arranged in the top of the tender and are mounted on a platform constructed from Angle Girders and Flat Plates.

Models Nos. 93 and 94. L.N.E.R. High-Pressure Locomotive "No. 10000". (R. O. Jukes, Christchurch, N.Z., and R. S. Miller, Newark).

On this page are shown two interesting models of the wonderful L.N.E.R. high-pressure locomotive "No. 10000."

Dealing first with the model shown in the upper illustration, it will be seen that the construction of the main frame follows very closely the method adopted in the construction of actual locomotives. Although the driving wheels are not sprung as in the case of the actual engine, the appearance does not suffer greatly in consequence. The six driving wheels are each fitted with brakes operated from a handle in the driver's cab.

The front bogie is $7\frac{1}{2}$ " long and $3\frac{1}{2}$ " wide and the wheels are constructed from Face Plates and Wheel Flanges. Two $3\frac{1}{2}$ " Angle Girders are bolted across the centre of the bogie, and these support the sliding pivot pin. The bogie is held in a central position by means of two Springs. The axle of the front pair of wheels of the rear bogie is mounted in correctly designed axle-boxes connected to the main frames by neat leaf springs. The Bissel truck is of massive construction and is built from $3\frac{1}{2}$ " and $5\frac{1}{2}$ " Angle Girders. The rear axle is carried in two Handrail Supports attached to the truck.

The boiler is cleverly constructed from $5\frac{1}{2}$ " x $3\frac{1}{2}$ " Flat Plates and $12\frac{1}{2}$ " Strips. By using Plates instead of Strips, a much neater appearance is obtained. The streamlined chimney is constructed from two 1" loose Pulleys and four $1\frac{1}{2}$ " Strips, the Strips being carefully moulded into a trailing edge in faithful imitation of the original. The handrails are represented by Rods of various sizes.

The cab is constructed from a number of $5\frac{1}{2}$ " x $3\frac{1}{2}$ " and $4\frac{1}{2}$ " x $2\frac{1}{2}$ " Flat Plates, and the curves at the roof corners are moulded with the aid of $2\frac{1}{2}$ " Triangular Plates and short Strips. The cab fittings include steam pressure and water gauges, vacuum gauge, brake, and valve gear levers, seats for driver and fireman, and a hinged fire-box door fitted with a draught screen. In a real engine this screen is used for the purpose of protecting the legs of the engine crew from the heat of the furnace.

The tender is a scale reproduction of an L.N.E.R. corridor-type tender and runs on eight wheels, each of which is sprung independently of the others. The corridor, which runs down one side of the tender, opens into the cab of the locomotive through a small door, and communication is also provided between the tender and the train by means of a model of an L.N.E.R. corridor connection. Small lumps of coal placed in the tender add greatly to the realism of the model.

The model shown in the lower photograph is driven by means of a Meccano 6-volt Electric Motor. The main frames are built in a similar manner to the Meccano Super Model Baltic Tank Locomotive, and the six coupled wheels are each mounted on springs

and compensating levers. The front bogie is $7\frac{1}{2}$ " long and $3\frac{1}{2}$ " wide, and is controlled by two springs that tend to keep it always in line with the main frame. What appears to be a rear bogie in the illustration is actually two separate units, one of which is mounted direct on the main frames by leaf springs and axle-boxes. The other axle unit, placed directly under the cab, is carried on a Bissel truck, constructed from Angle Girders in the form of a "T."

The end of the long arm of the Meccano Bissel truck is attached by a massive pivot to the underside of the locomotive, and the short arm carries bearings for the wheel axle.

There are four cylinders on the model, two inside and two outside, the inner pair representing the high-pressure cylinders and the outer pair the low-pressure cylinders. The outer cylinders are coupled to the centre driving wheels by $9\frac{1}{4}$ " Strips that represent the connecting rods, and the valves of these cylinders are operated by Gresley-Walschaerts valve motion. The inner cylinders are connected by $7\frac{1}{4}$ " Strips to cranks on the leading driving axle, and the valves

for these are operated by links coupled to the outer sets of valve gears. These links are constructed from Double Arm Cranks and $1\frac{1}{2}$ " Strips, an arrangement that allows the high pressure steam to be cut off independently of the low-pressure steam. In actual practice the valves are controlled from small levers in the cab operating through telemotors, but in the Meccano model the movement of these levers is transmitted direct to the reversing links by means of rods.

The boiler, which is the most unusual part of the actual engine, presents many difficulties to the model-builder, but in the model shown here most of them have been successfully overcome. The front end is fitted with specially designed smoke deflectors and a sliding door for regulating the air supply to the furnace. The cab is equipped with all the principal fittings found in the original and a small electric light bulb is built into the cab roof.

The tender is a faithful reproduction of the original and the corridor, running down one side, is cleverly built into this section of the model. The eight wheels are all correctly sprung and fitted with brakes; the brake control being situated on the tender platform.

The rear of the tender is fitted with a vacuum pipe connection, buffers and lamp brackets, and a realistic finish is given to the model by painting appropriate letters and numbers on both sides of the locomotive cab and tender.

In the actual tender the wheels are $4\frac{1}{2}$ " in diameter, and as the scale of this model happens to be slightly less than 1" to 1', it was found necessary to use 3" Pulley Wheels. Although these are a little too small the fact is not easily noticeable.

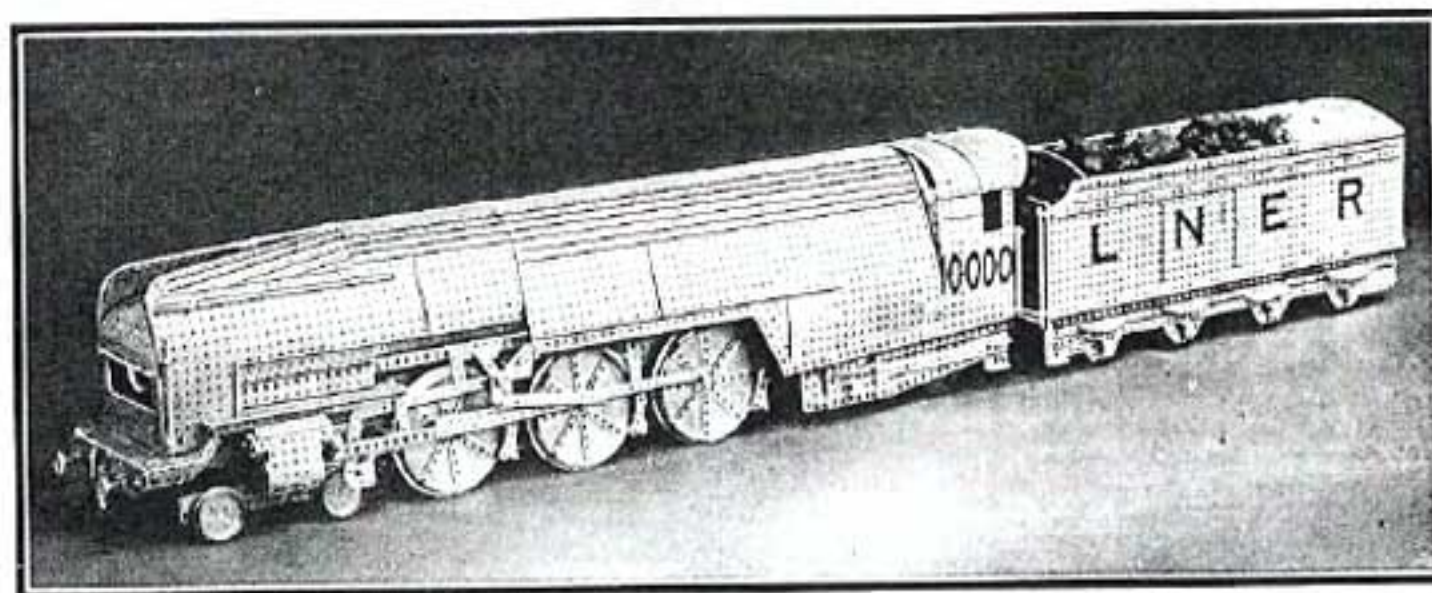

A model of the L.N.E.R. Locomotive "No. 10000," by R. O. Jukes.

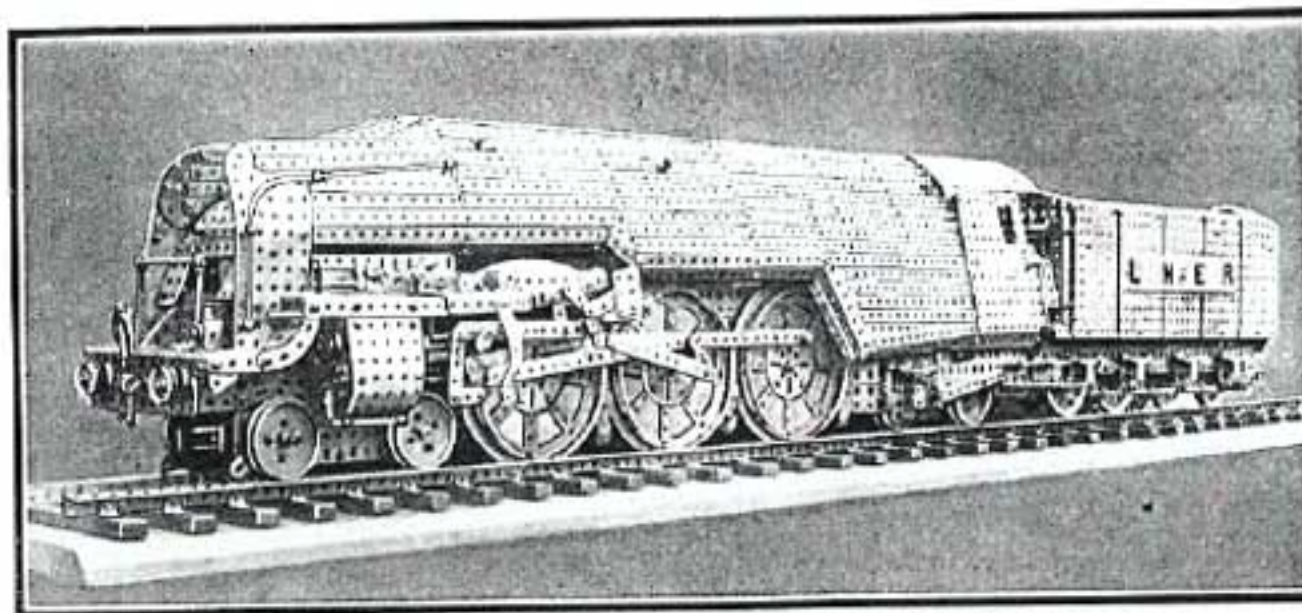

This model by R. S. Miller forms an interesting comparison with that shown above.

Model No. 95. L.M.S.R. High-Pressure Locomotive "Fury." (K. W. Cameron, Birkenhead).

Towards the end of 1929 two experimental locomotives using high-pressure steam were produced in this country. The first of these to appear was the L. N. E. R. "No. 10000," two models of which were described on page 36. This was followed after a short interval by the L.M.S.R. "Fury," the prototype of the fine Meccano model illustrated on this page. It will greatly assist

constructors in reproducing the model to know something of the special and unusual methods adopted in building the actual engine. The design follows that of the L.M.S.R. "Royal Scot" class with regard to the frames, but in this case the engine is a three-cylinder compound, the high-pressure cylinder being situated between the frames and the two low-pressure cylinders outside the frames.

The high-pressure boiler consists of three distinct systems or boilers, each carrying a different pressure. The system having the highest pressure—1,400 lb. to 1,800 lb. per sq. in., the variation in pressure depending upon the rate of firing—is in the form of a closed circuit consisting of a number of pipes that form the sides, roof, and back end of the fire-box. These pipes are connected at the bottom to a foundation ring and at the top to equalizing drums, into which they are expanded. From the equalizing drums pipes are led to evaporating elements situated in the high-pressure drum. This closed circuit is initially filled to a pre-determined level with pure water, which is the medium by means of which heat is transmitted from the fire-box to the evaporating elements in the high-pressure drum. This drum, which furnishes steam at 980 lb. per sq. in. for the high-pressure cylinder of the locomotive, is of nickel steel, but is not in any way in contact with the fire. It is fed by water drawn as required from the low-pressure boiler by means of a pump.

The low-pressure boiler occupies the same position as the barrel of the normal locomotive boiler, and the water is evaporated by the gases passing through the boiler tubes. The barrel of this low-pressure boiler also is of nickel steel, but both tube plates are of mild steel.

The method of working the locomotive is more or less normal. The regulator handle operates both the high-pressure and the low-pressure regulator simultaneously. On opening the regulator steam is admitted into the high-pressure cylinder after passing through the high-pressure superheater situated in the lower boiler tubes. Exhausting from the high-pressure cylinder, the steam enters a mixing chamber, where it is met by low-pressure steam at 250 lb. pressure, which

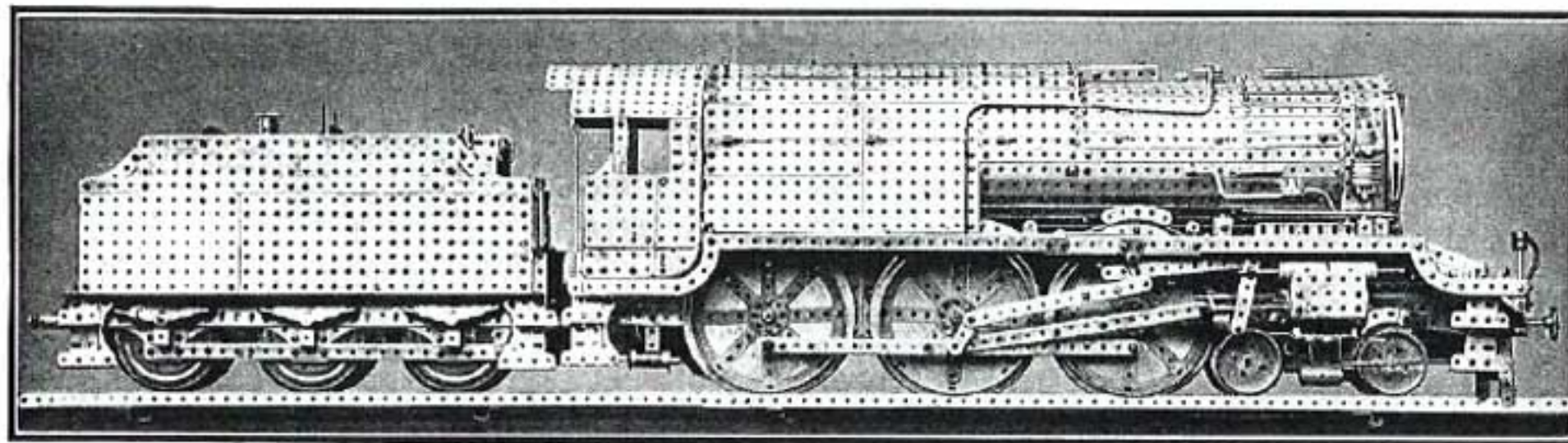

previously has passed through a low-pressure superheater situated in the upper boiler tubes. From the mixing chamber steam enters the two outside cylinders and goes thence to the exhaust.

The "Fury" hauls an L.M.S.R. standard tender, the carrying capacity of which is 5½ tons of coal and 3,500 gallons of water, and a scoop

is fitted for picking up water from troughs between the metals while the engine is in motion. The scoop is pivoted to the underside of the tender, and is lowered as the locomotive approaches the water trough so that it dips into the water. The speed of the engine forces the water up a pipe situated above the scoop, and at the top of the pipe it strikes a dome and is diverted so that it falls into the water tank of the tender. This system works very satisfactorily and enables about 2,000 gallons of water to be picked up in about 30 seconds when the engine is at speed.

The splendid Meccano model shown here is 5½' in overall length, and its particularly life-like appearance is largely due to the vast amount of detail that is incorporated.

The boiler is undoubtedly the most difficult portion of the model to construct and it will be seen that it is built in one unit. The cut-away portion of the boiler behind the smoke-box contains a very realistic reproduction of the feed pump that in actual practice feeds the high-pressure steam drum.

The valve gear of the model is similar to that fitted to the Meccano Tank Locomotive (Super Model Instruction Leaflet No. 15). The interior of the cab contains many interesting features, among which are steam gauges and water injectors for both the high and the low-pressure systems. The regulator handle, which works both the high-pressure and low-pressure regulators simultaneously, is of the standard L.M.S.R. pattern and is coupled to the starting and reversing handle of a 6-volt Electric Motor by means of a series of Cranks and Strips. This Motor is used for turning the driving wheels of the locomotive so that it is possible to "drive" the completed engine in a railway-like manner.

The tender fitted to the model is a good reproduction of the original and although no scoop is fitted all the main external features are faithfully represented. The frames are 18½" long and are fitted with three pairs of wheels formed from Flanged Ball Races. The wheels have realistic leaf springs, and carefully shaped steps at each end give the tender a pleasing appearance. Dummy handles for the brake and for lowering and raising the water scoop are mounted on the platform.

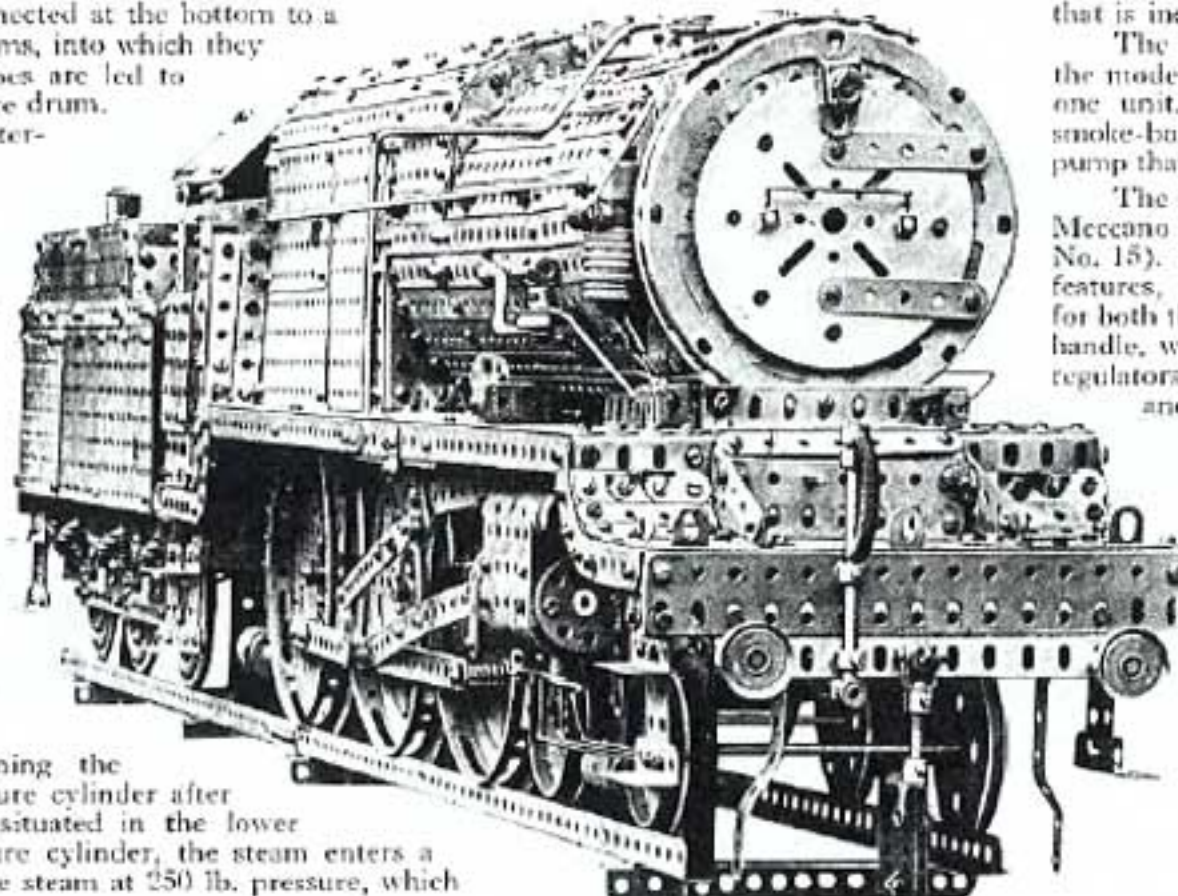

Model No. 96. Löffler High-Pressure Locomotive.

(J. Ringnalda, Leeuwarden, Holland).

In addition to the two British high-pressure locomotives, L.M.S.R. "Fury" and L.N.E.R. "No. 10000," models of which are illustrated on pages 37 and 38, several experimental high-pressure locomotives have been constructed by other countries. Of these the most outstanding is a fine engine owned by the German State Railways. It is constructed on the Schwartzkopff-Löffler system, the principle consisting of evaporating water by means of a jet of superheated steam in a non-fired boiler.

A splendid model of this locomotive, in which all the essential external details have been reproduced, is shown on this page. The main frames are built of Angle Girders and Flat Plates, and the bearings for the axles of the driving wheels are supported on springs built up from a number of short Strips. The driving wheels consist of 6" Circular Plates and Hub Discs, and spokes are added by securing Strips to the Hub Discs by Angle Brackets. The counter-balance weights on the centre pair of driving wheels are represented by 2½" Curved Strips.

Flat Plates and Strips form the sides of the cab, the roof of which is made with Flat Plates. In front of the cab is the housing for the high and low-pressure superheaters, feed-heater and air pre-heater, the housing being built up from 5½" x 3½" Flat Plates and 12½" Strips secured to transverse ribs curved to the shape of the top. Forward of this structure are the circulating pump for the high-pressure steam, and the high-pressure feed-pump. These are mounted one at each side of the frame.

The low-pressure boiler at the front of the locomotive is built by bolting Strips round the peripheries of Hub Discs, and a 4" Circular Plate is fitted to represent the smoke-box door. Above this boiler is the high-pressure oil separator and casing for the low-pressure feed heater. Face Plates joined by Strips are used for the oil separator. The chimney is placed behind the low-pressure boiler and is represented by Boiler Ends. The outside cylin-

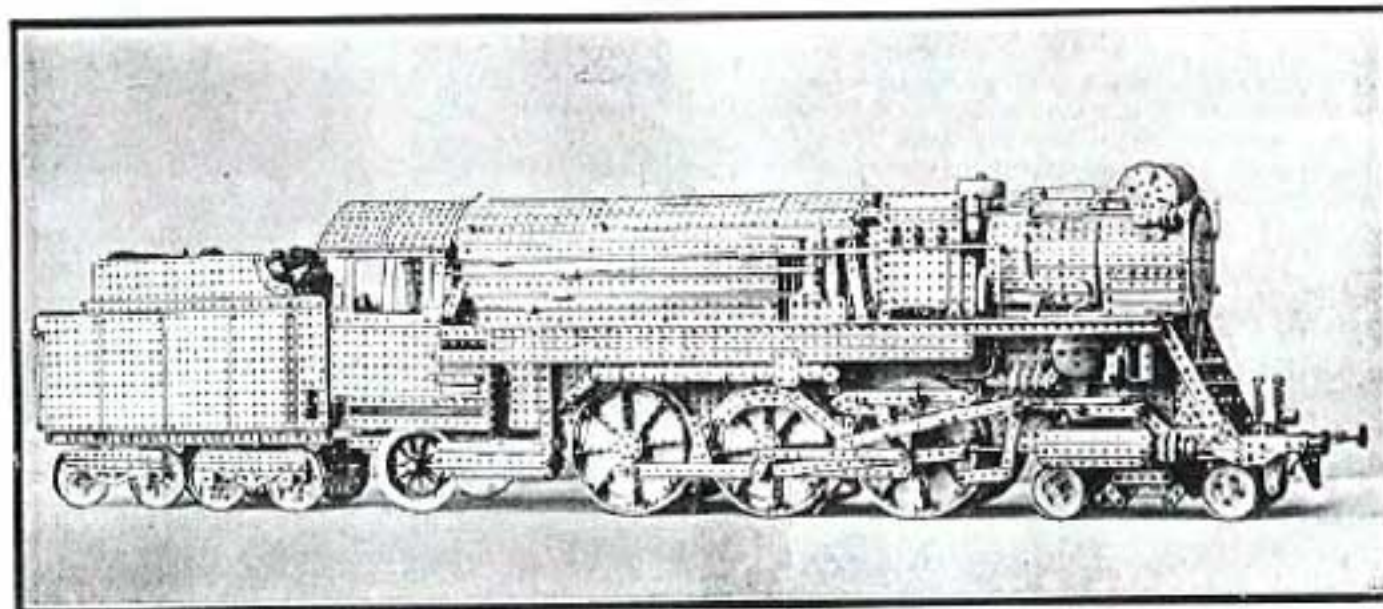

ders are formed by securing 4½" Strips round Bush Wheels by means of Angle Brackets, and are finished by two 1¼" and two ¾" diameter Flanged Wheels at the front. The model is fitted with Walschaerts valve gear, and constructors who wish to obtain details of this mechanism should refer to Super Model Instruction Leaflet No. 15, Baltic Tank Locomotive, where it is fully described.

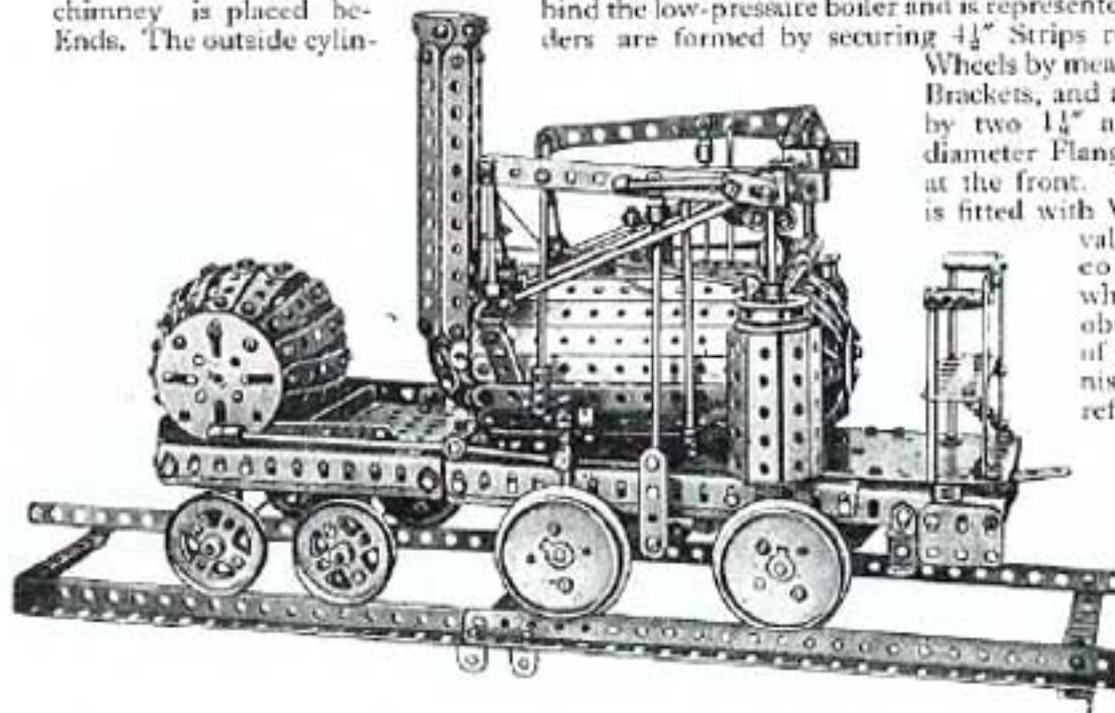

Model No. 97. "Puffing Billy." (A. Holmes, Manchester).

The "Puffing Billy" was one of the earliest steam locomotives, and was built by William Hedley in 1813 for work at the Wylam Colliery, Northumberland. A realistic model of this locomotive is shown below. The main frame is built of Angle Girders and at the rear a Clockwork Motor is fitted between them. A ¼" Pinion is secured on the lower end of the

Motor driving spindle, and meshes with a ¾" Contrate Wheel on a horizontal Axle Rod, which also carries a ½" Pinion. This Pinion engages a 1¼" Contrate on a Rod placed across the frame between the driving wheels, and on this Rod are two Couplings that transmit movement of the overhead beams, which in turn operate the piston rods, valve rods and the water pump. The drive to the front wheels is conveyed from the centre axle through 57-teeth Gears.

The boiler is made from two circles of Strips, to which 5½" Strips are bolted, and the back of the boiler is finished off by the use of carefully curved Strips secured to a Bush Wheel. At the front of the boiler the chimney is fitted, and is built up from 5½" Strips, Curved Strips being used to obtain the rounded shape at the base where it is secured to the boiler. A small circle of Strips surmounts the chimney and is held in

position by Flat Brackets. The cylinders, which are attached to the side of the boiler, are made up of 2½" x 1" Double Angle Strips bolted to Bush Wheels.

The safety valve mounted on the boiler is of the weighted lever type, the lever being a 2" Screwed Rod at one end of which is a ½" Fast Pulley forming the weight, and at the other end a Collar in which is gripped a ¼" Bolt. A Collar on the lower end of the Bolt is pivoted between Angle Brackets attached to the boiler, and a second Collar on the 2" Screwed Rod rests on a Coupling fitted vertically to the boiler. The water barrel is built up from short Strips curved to the correct shape, and these are attached by means of ½" x ½" Angle Brackets to two Face Plates forming the ends of the barrel.

Model No. 98. 4-4-4 Electric Locomotive.

(E. Grubb, Vancouver, B.C.).

The Axle Rods forming the driving axles are journalled in axle boxes carried on compensating laminated springs. The bogies are each built up of two 2½" Flat Girders connected together by two Double Angle Strips and the wheels are carried on 2½" Strips and are allowed a certain amount of vertical movement in

the slots of the Flat Girders. Angle Girders are used for the body, which is filled in with Strips, spaces being left for the windows; and a Windmill Sail is placed behind the centre window at each side. The electric current is collected from the overhead wire by two collapsible pantographs that are held in a raised position by springs.

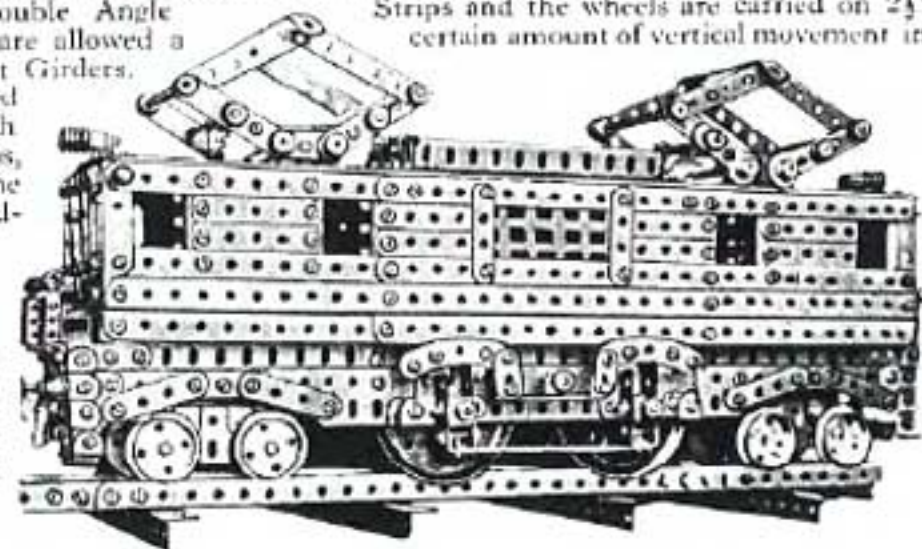

Model No. 99. Giant Electric Shovel. (A. Bulot, Calais).

The prototype of this model has the distinction of being the largest shovel in the world. It was fully described and illustrated in the "Meccano Magazine" for December, 1930.

The main platform or base of the model is $12\frac{1}{2}$ " square, each side being constructed in the shape of a massive bow girder. The four girders are secured together in the form of a hollow rectangle, and numerous members consisting of $12\frac{1}{2}$ " Angle Girders are then bolted in place. These cross Girders form supports for the floor of the deck, which is built up from Flat Plates and carries the lower flange of a Roller Bearing.

The base is carried at each corner on two creeper track units, each of which is constructed in the following manner. Two side members are built up in the shape of a narrow triangle, and are secured together by means of three $1\frac{1}{2}$ " x $\frac{1}{2}$ " Double Angle Strips. Each corner of the double triangular frame so formed carries a Rod on which is mounted two $\frac{7}{8}$ " Conrutes, and these three points support a wide canvas belt representing the creeper track. Two of these tracks are mounted on an equalising beam that facilitates travelling over uneven ground. The drive to the four sets of creepers is transmitted through Bevel Gears and Universal Couplings. The front of the base carries a short ladder built up from $5\frac{1}{2}$ " Strips and 1 " Threaded Rods.

The bed of the revolving superstructure is $24\frac{1}{2}$ " in length and $12\frac{1}{2}$ " in width. The structure is constructed from two $24\frac{1}{2}$ " girders joined together by Flat Girders to form a channel section girder, and the two ends are constructed in a similar manner from $12\frac{1}{2}$ " Angle Girders. Flat Plates of various sizes are used for plating the bed, and the whole is bolted to the upper section of the Roller Bearing fixed to the base.

The front section of the "A" frames is built up from four $18\frac{1}{2}$ " Angle Girders braced together by $7\frac{1}{2}$ " Strips, and the two rear frame members are each $24\frac{1}{2}$ " in length and of channel girder section. Suitable bracing members are constructed from $9\frac{1}{2}$ " Angle Girders held in place by $3\frac{1}{2}$ " and $2\frac{1}{2}$ " Strips.

The framework of the motor and gear-box housing is constructed from $7\frac{1}{2}$ ", $12\frac{1}{2}$ " and $18\frac{1}{2}$ " Angle Girders, the $7\frac{1}{2}$ " Girders serving as corner posts and the $12\frac{1}{2}$ " Girders as cross members. The $18\frac{1}{2}$ " Angle Girders are used as main horizontal side members and are also needed for the apex of the roof. The complete frame is covered with $5\frac{1}{2}$ " x $2\frac{1}{2}$ " Flat Plates and $5\frac{1}{2}$ " x $3\frac{1}{2}$ " Flat Plates, and two square spaces are left to represent windows and doors.

The side of the superstructure shown in the photograph carries the control platform, on which is a lever frame fitted with five levers, each controlling one of the five movements of the model. This platform and the base on which it is mounted are surrounded by a neat handrail built up from Threaded Pins, Couplings, and long Rods.

The jib is 46 " in length, and the four compound girders used in its construction are braced together by $2\frac{1}{2}$ " Strips and lengths of Meccano Cord. The digger arm is built up from four $24\frac{1}{2}$ " Angle Girders, and the construction of the bucket, which is a very fine replica of the original, is shown clearly in the illustration.

The racking movement for the bucket arm is driven through Universal Couplings from the main shaft of the gear-box, and is carried out by a $3\frac{1}{2}$ " Rod carrying two 1 " Pinions that mesh with Rack Strips secured to the bucket arm.

The bed of the revolving superstructure is $24\frac{1}{2}$ " in length and $12\frac{1}{2}$ " in width. The long sides are each constructed from two $24\frac{1}{2}$ " Angle Girders joined together by Flat Girders to form a channel section girder, and the two ends are constructed in a similar manner from $12\frac{1}{2}$ " Angle Girders. Flat Plates of various sizes are used for plating the bed, and the whole is bolted to the upper section of the Roller Bearing fixed to the base.

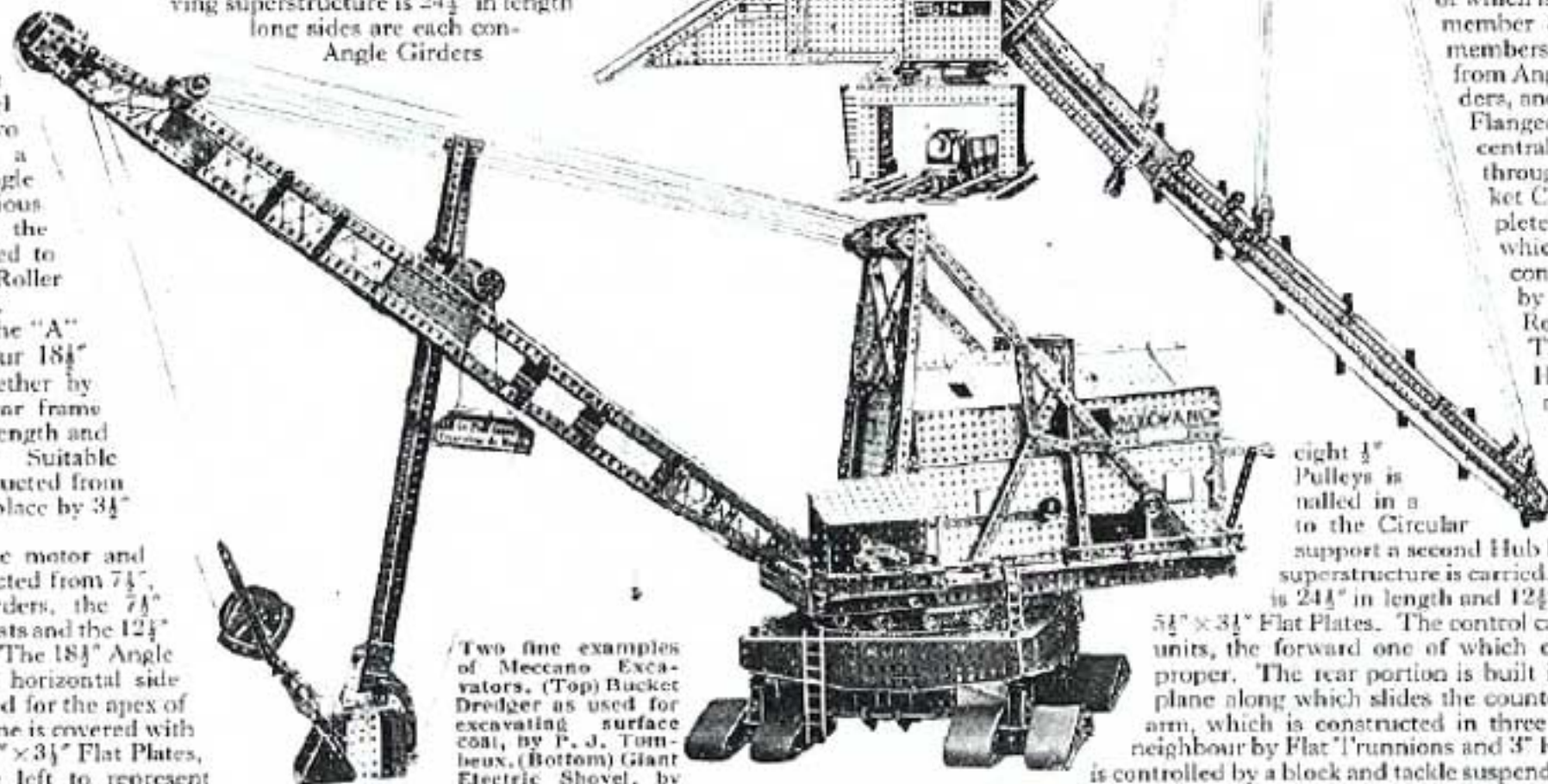

Two fine examples of Meccano Excavators. (Top) Bucket Dredger as used for excavating surface coal, by P. J. Tombeux. (Bottom) Giant Electric Shovel, by A. Bulot.

Model No. 100. Giant Bucket Dredger. (P. J. Tombeux, Courtrai, Belgium).

(P. J. Tombeux, Courtrai, Belgium).

Although in the great majority of coal mines the coal lies many hundreds of feet below the surface of the ground, in a few instances it is covered by only a thin layer of soil, and is then known as surface coal. One of the largest deposits of surface coal is in Northern Germany, and it is excavated by means of ingenious machines specially designed for the purpose. One of the most interesting of these operates in a similar manner to a dredger, and it is this type of excavator that forms the subject of the fine model shown in this page. It consists essentially of a number of buckets fixed to an endless chain that travels round the end of a long arm. This arm is mounted on a revolving superstructure supported on a base that spans a double railway track, wagons on which receive the coal as it is dug from the seam face by the buckets.

The travelling base of the model is built in the form of an inverted "U," the top of which is $9\frac{1}{2}$ " in length, and each side member $5\frac{1}{2}$ " in height. The side members are strongly constructed from Angle Girders and Braced Girders, and each is fitted with four $1\frac{1}{2}$ " Flanged Wheels driven from the central pivot of the superstructure through Bevel gearing and Sprocket Chain. One side of the complete base is fitted with a ladder, which consists of two $7\frac{1}{2}$ " Strips connected parallel to each other by a number of 2 " Threaded Rods.

The top of the base carries a Hub Disc on which rotates a roller race built up from an old style Circular Strip and loose Pulleys. Each of the eight $\frac{1}{2}$ " Pulleys is carried on a $1\frac{1}{2}$ " Rod journalled in a Double Bracket secured to the Circular Strip. The eight Pulleys support a second Hub Disc on which the revolving superstructure is carried. The base of this structure is $24\frac{1}{2}$ " in length and $12\frac{1}{2}$ " in width, and is built from $5\frac{1}{2}$ " x $3\frac{1}{2}$ " Flat Plates. The control cabin is built in two separate units, the forward one of which constitutes the control cab proper. The rear portion is built in the form of an inclined plane along which slides the counterbalance for the dredging arm, which is constructed in three lengths, each hinged to its neighbour by Flat Runners and 3 " Rods. Each separate section is controlled by a block and tackle suspended from a fixed jib situated above the model. The top members of the jib are 32 " in length and the bottom members 28 " in length, the four being braced together by Strips of various sizes. The digging buckets are carried on two belts of Sprocket Chain that pass round $\frac{7}{8}$ " Sprocket Wheels at each end of the flexible arm and also at each joint of the arm. In order to take up any slack in the chain when the arm is bent, a jockey lever is fitted inside the cab and carries two $\frac{7}{8}$ " Sprocket Wheels that are held in contact with the Chain by means of a Spring. The balance weight that slides on the inclined plane at the rear of the cab consists of a Boiler mounted on four $\frac{7}{8}$ " Flanged Wheels, and the Boiler is filled with lead to a sufficient weight to counterbalance the dredging arm. The gear-box is of a very complex nature and the motive power is provided by two Electric Motors, to which current is supplied from the mains through a Transformer. Six electric lamps are placed at various points in the model in imitation of those fitted to the actual machine to facilitate working at night.

The top of the base carries a Hub Disc on which rotates a roller race built up from an old style Circular Strip and loose Pulleys. Each of the eight $\frac{1}{2}$ " Pulleys is carried on a $1\frac{1}{2}$ " Rod journalled in a Double Bracket secured to the Circular Strip. The eight Pulleys support a second Hub Disc on which the revolving superstructure is carried. The base of this structure is $24\frac{1}{2}$ " in length and $12\frac{1}{2}$ " in width, and is built from $5\frac{1}{2}$ " x $3\frac{1}{2}$ " Flat Plates. The control cabin is built in two separate units, the forward one of which constitutes the control cab proper. The rear portion is built in the form of an inclined plane along which slides the counterbalance for the dredging arm, which is constructed in three lengths, each hinged to its neighbour by Flat Runners and 3 " Rods. Each separate section is controlled by a block and tackle suspended from a fixed jib situated above the model. The top members of the jib are 32 " in length and the bottom members 28 " in length, the four being braced together by Strips of various sizes. The digging buckets are carried on two belts of Sprocket Chain that pass round $\frac{7}{8}$ " Sprocket Wheels at each end of the flexible arm and also at each joint of the arm. In order to take up any slack in the chain when the arm is bent, a jockey lever is fitted inside the cab and carries two $\frac{7}{8}$ " Sprocket Wheels that are held in contact with the Chain by means of a Spring. The balance weight that slides on the inclined plane at the rear of the cab consists of a Boiler mounted on four $\frac{7}{8}$ " Flanged Wheels, and the Boiler is filled with lead to a sufficient weight to counterbalance the dredging arm. The gear-box is of a very complex nature and the motive power is provided by two Electric Motors, to which current is supplied from the mains through a Transformer. Six electric lamps are placed at various points in the model in imitation of those fitted to the actual machine to facilitate working at night.

USES FOR MECCANO PARTS

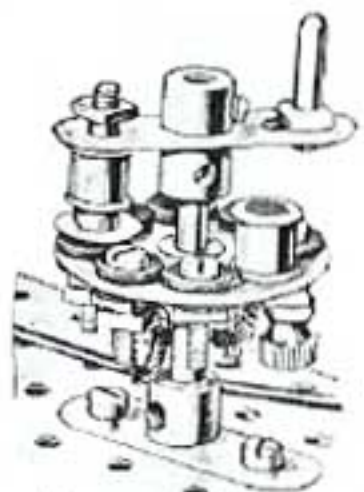

A



B



C



D

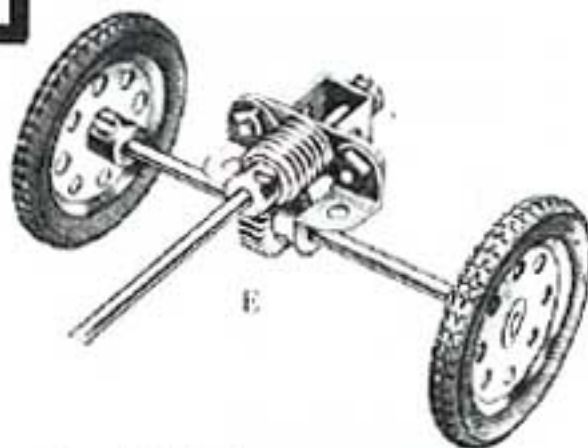

E

The models included in this book have achieved success largely through the skilful manner in which the various Meccano parts have been used. Here are a few practical suggestions for the employment of some of the more recently introduced parts. Each of these examples will probably suggest many other interesting purposes that the particular part may be made to serve.

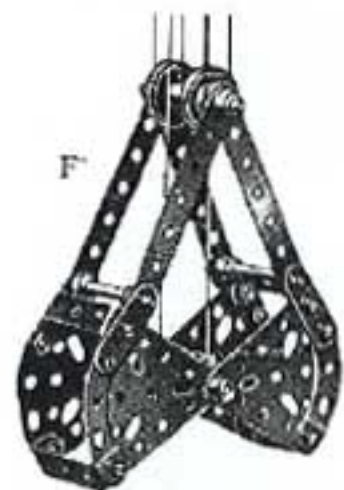

F

(A) The Meccano Spring Buffer (No. 120A) used in the movable contact arm of a Meccano Electric Motor controller. The spring keeps the buffer head in electrical contact with the switch studs of the controller.

(B) A Centre Fork (No. 65) mounted in a Coupling and used as a "striker" in the recording gear of a distance indicator. When the Centre Fork rotates once it partially turns the Sprocket Wheel.

(C) Trunnions used in the construction of a rigid base for a small swivelling structure.

(D) A Triangular Plate (1") used as a bearing for an Axle Rod.

(E) By making use of one Right-hand and one Left-hand Corner Angle Bracket (Nos. 154A and 154B) a neat worm drive stirrup may be built. Either a 1/2" or a 1" Pinion may be used with the Worm.

(F) Four 2 1/4" Triangular Plates used in the construction of an efficient "clam shell" grab bucket.

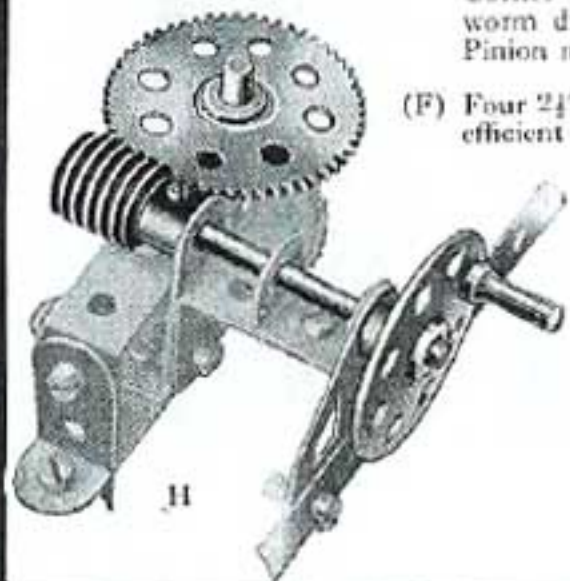

H



I



J

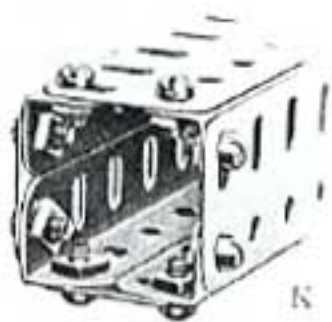

K



L

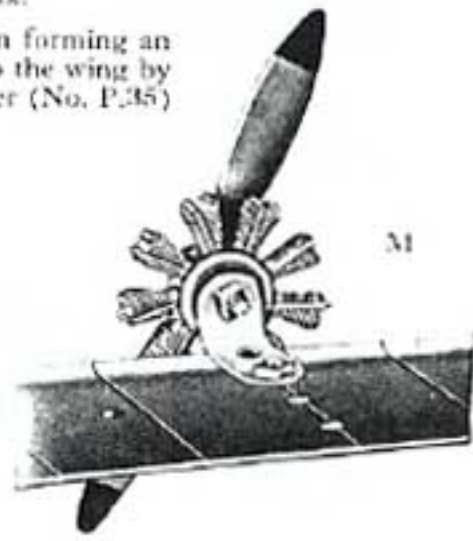

M

(G) Sleeve Pieces used in the assembly of a chimney. They are joined by a Chimney Adaptor mounted on a central Axle Rod.

(H) Worm gearing is useful when big reductions in speed are required. Here a Meccano Worm (No. 32) is meshed with a 57-teeth Gear Wheel to give a ratio of 57 : 1.

(I) Two 1/2" Flanged Wheels butted together to form an efficient belt pulley.

(J) A Socket Coupling used to couple together a 57-teeth Gear Wheel and one section of the Dog Clutch.

(K) A box section girder constructed from Flat Girders joined together by Angle Girders.

(L) A low friction bearing of the knife-edge type formed from a Pinion and a Centre Fork secured in a Crank.

(M) The small Radial Engine (No. P.43) used in forming an aeroplane power unit. The Engine is held to the wing by an Engine Bracket (No. P.61), and a Propeller (No. P.35) is secured by two locknuts.

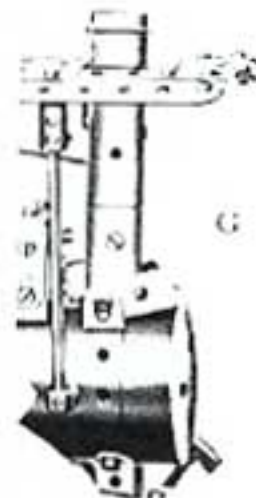

G