

MECCANO

AEROPLANE CONSTRUCTOR

SPECIAL
OUTFITS
Nos. 1 AND 2



1/6

INSTRUCTIONS

Copyright by

MECCANO LTD · LIVERPOOL · ENGLAND



MECCANO



SPECIAL AEROPLANE CONSTRUCTOR

The aeroplane is rapidly taking its place as a regular means of high speed transport, and the time is not far distant when we shall use it as readily as to-day we employ the train, the steamship and the motor car. In future we shall cross the oceans in giant flying boats that will traverse well-marked routes, and overland airways will be even more numerous than those across the sea.

Now is the time for every boy to learn how aeroplanes are designed and constructed, and to recognise at a glance the different types. The best way of doing this is for a boy to build aeroplanes for himself, and the Meccano Special Aeroplane Constructor Outfits have been designed for this purpose. This Manual shows how to construct 44 different types, and a large number of other splendid machines may be built by varying the positions of the parts. These parts are all interchangeable on the Meccano principle, and can be used in conjunction with standard Meccano parts.

The Parts of an Aeroplane.

The fun of building aeroplanes with Meccano Special Aeroplane Constructor Outfits is greatly increased if we know something of the parts of a real machine and of the manner in which aeroplanes are controlled in flight.



When the central column or "joy-stick" is vertical, the elevators are horizontal, and the machine flies parallel with the ground.



When the stick is pulled back, the elevators are raised and the machine climbs.



Pushing the stick forward causes the machine to put down its nose and dive.

The aeroplane is really a simple structure. It consists essentially of a long body or fuselage, which houses the cockpit or cabin for the pilot and passengers. At the front end of the fuselage is usually placed the engine, except in multi-engined aeroplanes in which the power units are frequently carried in nacelles, which are egg-shaped casings, secured under the wings. In a single-engined machine the wings are usually situated a short distance behind the engine. The rear of the fuselage carries the empennage or tail unit, which is made up of rudder, fin, elevators and tailplane. Below the front portion of the fuselage is the undercarriage, which may be provided with wheels for landing on an aerodrome, or with floats for alighting on water. Some machines are provided with both floats and wheels, arranged so that the wheels can be lifted above the floats when the machine is alighting on water.

How an Aeroplane is controlled.

What strikes anyone on examining an aeroplane for the first time is the simplicity of the manoeuvring mechanism, everything being done by means of three levers. The first of these, the control column or "joy-stick," is not unlike the gear lever of a motor car, and is connected to two controls, the ailerons and the elevators. The ailerons are small movable flaps arranged along the trailing or rear edge of the wings; and the elevators form one of the two main parts of the tail unit. The second lever, the rudder bar, is arranged near the floor of the cockpit, and is operated by applying the feet to its ends. This bar is connected to the rudder, which is the second main portion of the tail unit. The third lever is the throttle control, and in British machines this is always placed on the left-hand side of the cockpit, except when it is necessary for the lever to be operated from either of two seats arranged side by side in the pilot's cockpit.

The Joy-stick.

The joy-stick is the most fascinating factor in the control of an aeroplane. In order to fly level the stick is kept in a central and vertical position. If it is moved forward the elevators are depressed, and the machine promptly puts down its nose and begins to dive. To climb, the stick is pulled backward, thus raising the elevators and in turn the nose of the machine. Movement of the stick from left to right brings the ailerons into action. If it is moved to the left the ailerons on the left side are raised and those on the other side lowered, causing the left wings to go down and the right wings to rise. If the stick is moved to the right the right wings will drop. This raising and lowering of the wings is termed "banking."



When the joy-stick is vertical the machine flies on an even keel, the wings being parallel with the horizon.



When the stick is moved to the left, the ailerons on that side are raised and the left wings go down, producing left bank.



A right bank is brought about by moving the stick to the right.

If the aeroplane is veering or "yawing" to the left, right rudder is put on by moving the right



How air flows round an aeroplane wing.

instead. That is to say, rudder and bank are applied together in the direction in which it is wished to turn.

The throttle control in the cockpit is used to vary the speed of the machine. It is connected with the carburetter of the engine, and if it is pushed forward the throttle is opened and more petrol is admitted into the cylinders of the engine. Consequently the propeller turns quicker and the machine goes faster. When it is desired to slow down, the throttle control is pulled back.

When a pilot has entered the cockpit of his machine he always "warms up" his engine before taking off. At first the engine is only run at a comparatively slow speed, but when the temperature indicator on the dash-board shows that the correct temperature has been reached, it is run all out for a few seconds while the pilot watches his instruments to make sure that the engine is making its full revolutions. When this has been done satisfactorily, the pilot glances at the wind stocking, which is a canvas cone raised on a mast in some prominent part of the aerodrome, in order to discover in which direction the wind is blowing. The chocks are then removed from under the wheels, and the machine is taxied into the wind. It is kept pointing in the correct direction by means of the rudder, the stick being kept slightly forward of the point at which all controls are neutral. When flying speed is attained, the stick is eased gently back, and the machine almost imperceptibly rises up into the air.

In landing, the pilot approaches the aerodrome into the wind, shuts off his engine, and comes down in a glide or a series of gliding turns. At 15 ft. or 20 ft. above the ground the glide is eased by pulling the joy-stick slightly backward. Then, at about 2 ft. off the ground, the stick is pulled gently backward until the aeroplane is in such a position that it lands with the wheels and the tail skid touching the ground together.

Learning to Fly.

The aeroplanes used for training purposes have two cockpits, one in front of the other, the controls in each being interconnected. This arrangement enables the pupil in the

foot gently forward; similarly veering to the right is corrected by applying left rudder. The rudder must not be used alone to turn the aeroplane round, for the machine would then skid in a somewhat similar manner to a motor car racing round a bend on an unbanked road. It is impossible to bank the air, and therefore the aeroplane is banked

rear cockpit to follow all the manipulations made by the instructor in front, and also allows the instructor to correct any mistakes made by the pupil. Communication between instructor and pupil is maintained by means of earphones attached to the helmets and to tubes that can be plugged into connections in both cockpits. A safety belt is fastened round the body with a pin fastening that can be undone instantly.



What happens when an aeroplane climbs too steeply.

How an Aeroplane Flies.

So far we have dealt with piloting an aeroplane, but we have not said what actually keeps the machine in the air. Many people think that the lift obtained from the wings is due to the upward pressure of the air below them. Actually a certain amount of lift is gained in this way, but a far greater lifting effect is obtained from a vacuum that forms just above the upper surface of the planes, as may be seen from the diagram in the upper left-hand corner of this page.

There is a definite speed at which all aeroplanes must fly in order to remain in the air, speeds below this being insufficient to keep them up. This speed differs in various types, and is known as the "flying speed" of the machine.

An aeroplane will fly normally so long as it is travelling at about its flying speed, but if it is then made to climb steeply, the forward speed drops, the airstream cannot flow over the wings and flying speed is lost. The aeroplane is then said to be "stalling" and a nose dive results. A stall can easily be corrected if the machine is at a good height, by easing the stick forward so that the nose dips and flying speed is regained. A stall that occurs as the result of climbing too steeply just after taking off is dangerous, owing to the closeness of the machine to the ground.

Many schemes have been tried to overcome this difficulty, including a shrill whistle that is set up when stalling speed is approached; but the best known and the most effective safety device is the Handley Page automatic slot. This consists of a hinged flap placed on the leading edge of the planes, only the upper wings being fitted with it in the case of a biplane. When the machine is in normal flight the slots remain closed, but as the speed decreases they are forced forward by the action of the air on top of the wings. This allows a stream of air to flow through the slot and over the upper portions of the wings, thus delaying the stall. The remarkable effect of the slot is well shown in the centre illustration on this page.



How the Handley Page automatic slot works with the conditions shown in the upper right-hand drawing.

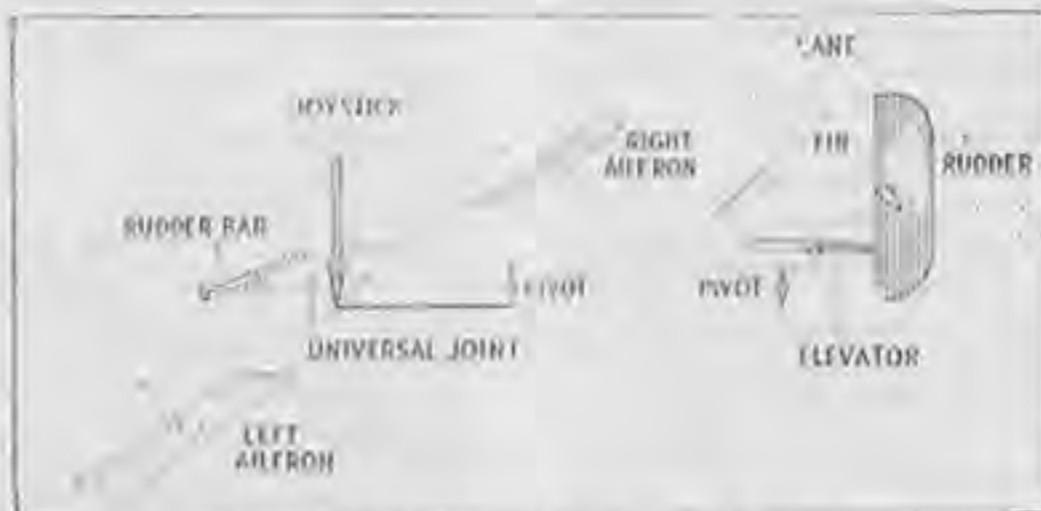

The controls of an aeroplane and their methods of operation.

How to Build Model Aeroplanes with Meccano Special Aero Parts

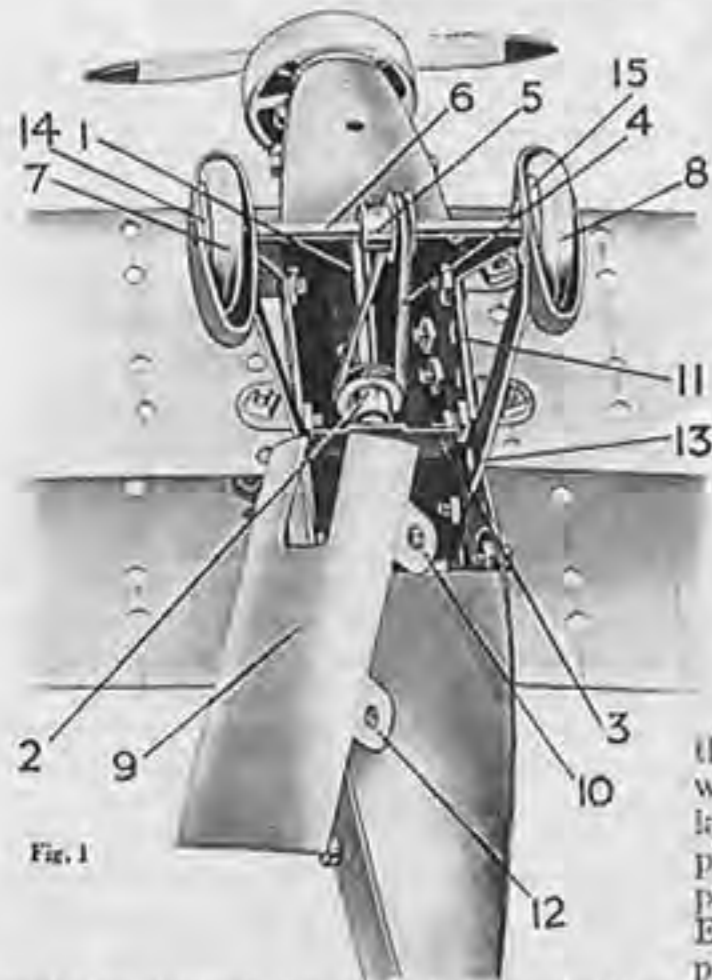

Fig. 1

The construction of any of the models shown in this Manual should be commenced by building up the fuselage. The Fuselage Front, Fuselage Top and Fuselage Sides Front are first of all assembled together. If a Radial Engine is to be mounted on the nose of the machine, it should be bolted to the Fuselage Front before this part is assembled, otherwise it will be found difficult to lock the engine securing nut in position. To attach the engine assembly, the Townsend Ring is placed against the Fuselage Front so that the smaller hole in the back of the Ring coincides with the lower hole in the Fuselage Front. The Engine is then placed in the Ring, and the projecting screwed stud on the Engine is passed through the perforation in the Townsend Ring

and also through the lower hole in the Fuselage Front.

A nut is screwed on to the Stud, and the centre holes in the Engine and Townsend Ring are lined up with the hole in the Fuselage Front by passing one end of the Drift through these parts. The nut on the Engine stud is then locked tightly, thus holding the Engine assembly securely in position.

Variations in Fuselage Design for Different Types of Aircraft

The Fuselage Front, Top Front and Sides Front having been bolted together, the Fuselage Underside Front is now placed in position and bolted to the Sides Front by means of two bolts. The Fuselage Sides Middle are placed against the flanges of the Fuselage Top Front and bolted in position. If a large cabin machine is being built, the Cabin Head (part No. P184) is fitted over the Fuselage Top, and the Fuselage Sides Middle are mounted so that the sides carrying the representations of cabin windows and door are outermost. The section bearing the door is fitted to the left-hand side of the machine, and in the case of models with an extended fuselage should be at the rear. The left-hand front section differs from the right-hand sections, and is distinguished by a letter A stamped on it. This section is placed under the rear section so that the two sets of windows come close together. Both right-hand sections are alike, and the rear should overlap the front to ensure correct placing of the windows.

In fitting the Cabin Head the holes in the side flanges of the Head can be brought into line with the top perforations in the Fuselage Sides by inserting

the tapered end of the Drift into the holes and moving it from side to side.

The plain Fuselage Top Rear is used for a single-seater machine, but for a two-seater the Fuselage Top Rear section with cockpit opening is used. Two Pilots are shown in two-seater machines, although only one is included in each Outfit. The extra one may be obtained separately if required.

The Assembly of the Undercarriage and Propeller Drive

The Undercarriage assembly and propeller drive may now be assembled, as shown in detail in Fig. 1. First of all the Propeller Bracket 3 is bolted in place between the Fuselage Sides. A Propeller is next mounted on one end of the 6½ in. Axle Rod 1, and the Rod is pushed through the centre hole in the Engine and through the hole in the nose of the Fuselage. The ¼-in. Fast Pulley 2 and the Rubber Band 4 are next placed on the Rod, and the end of the Rod is passed through the centre hole in the Bracket 3. A Collar is now pushed on to the portion of the Rod 1 projecting beyond the Bracket, and locked in position by means of its grub screw, so that the shaft 1 is free to rotate but cannot be drawn out of its bearings. The Undercarriage with Wheel Shields is now fitted in position so as to provide bearings for the Landing Wheel Axle. The Undercarriage Right-hand and Left-hand sides are bolted to the Fuselage Sides Middle sections, the lower rows of holes being used. It should be noted that in biplane and low-wing monoplane models the bolts holding the Vee Struts in position also secure the Angle Brackets to which the lower wings are bolted, and the securing bolts should therefore be passed through the round holes in the lugs of these brackets before being placed in the Fuselage section.

After bolting the Undercarriage in place, the Landing Wheels and Landing Axle are mounted in position. First, the Landing Wheels 14 and 15 fitted with Tyres 7 and 8 are placed in their respective Wheel Shields, and the 3¼ in. Axle 6 is passed through the left-hand Shield and through the centre hole in the Wheel 14. The ½ in. Fast Pulley 5 is next slipped on to the end of the Rod, and the Rubber Driving Band 4 is drawn up and passed round the groove of the Pulley. The Axle 6 is then passed through the right-hand Undercarriage and Wheel Shield into the central hole in the Landing Wheel 15.

The method of locking the Wheels to the landing Axle is illustrated in Fig. 2. The Rubber Tyre 7 is first of all rolled to one side with the fingers so that the grub screw in the Wheel can be located. When the position of the screw is found, the Tyre is stretched to one side so that the grub screw can be turned, thus locking the

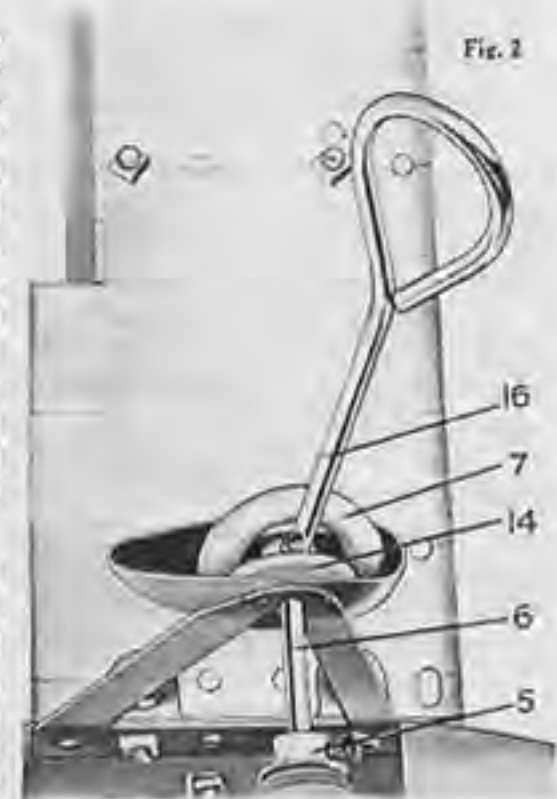

Fig. 2

Wheel to the Axle. To do this, the blade of the Screwdriver 16 is inserted between the rims of the aero Wheel 14 and placed in the slot in the end of the grub screw. It should be noted that the Screwdriver supplied with the Outfit is of suitable diameter to pass between the rims of the aero Wheel, the blade of an ordinary screwdriver being too wide for this purpose.

To complete the propeller driving assembly, the $\frac{1}{2}$ -in. Fast Pulleys 2 and 5 are locked in position on their respective shafts. In placing the Rubber Driving Band 4 around the Pulleys 2 and 5, care should be taken to see that it is arranged so that the Propeller rotates in a clockwise direction when the model is pushed forward along the ground. (For correct method, see Fig. 1).

Tail Units for Land Planes and Flying Boats

The tail unit or "empennage" of the model aeroplane should next be built up. This is shown partly assembled in Fig. 4. First, the Fin 1 is pushed into position between the Fuselage Sides Rear and the slotted end of the Fuselage Top Rear, the projection on the lower edge at the front of the Fin being inserted in the slot in the Fuselage Top Rear located at 2 in Fig. 4. The Fin is held in position by means of two bolts. Next, the Elevator Coupling Piece 3 is pushed over the inner ends of the elevators 4 and 5 attached to the right and left-hand Tail Planes. The Tail Planes complete with coupled elevators are now moved into place so that the perforated flanges slip in between the Fuselage Sides and the Top section. The Planes are then pressed down so that the holes in the lugs coincide with the holes 6 and 8 in the fuselage sides (only two of these holes can be seen in Fig. 4). The $\frac{3}{8}$ -in. Bolt 7 is then passed into the hole 6 and through the fuselage and Tail Planes. A nut is screwed on to the projecting shank of the Bolt 7, and bolts are also passed through the holes 8 and fitted with nuts so as to make everything rigid.

The construction of a braced Flying Boat Tail is shown in Fig. 3. In this case the Fin 1 is secured to the fuselage in a similar manner to that described above, and is fitted with the Rudder 9 by means of the Pin 10. The Tail Planes with Elevators are bolted to the Fin instead of the Fuselage, and braced by means of Float and Centre Section Struts 2. The bolts 3 securing the Struts to the planes each carry two washers for spacing purposes, and the $\frac{3}{8}$ -in. bolt 7 carries a washer between each Strut and the fuselage. The Struts are omitted in some models, and in all cases where this form of construction is employed for the tail unit the Elevator Coupling Piece cannot be used.

Fitting the Fuselage Underside Sections

The Fuselage Underside Rear is now placed in position and bolted to the Fuselage Sides by two bolts at the front end. The tail end of the Underside Rear is slotted, and the Tail Skid (No. P55) is placed in position in the slotted portion before the rear end of the Underside is bolted in place. A $\frac{7}{16}$ -in. Bolt 11 (see Fig. 4) is then passed through the Fuselage Sides, Underside and Tail Skid, and a nut is screwed on so that all four parts are locked together.

If a model of a civil machine is being built, the plain Rudder (No. P100) is used; while if a modern fighting plane is under construction, the military type Rudder is employed, this rudder being painted with red, white and blue bars in accordance with standard British military aircraft practice. The method of fitting either the military or civil pattern of Rudder is exactly the same. To

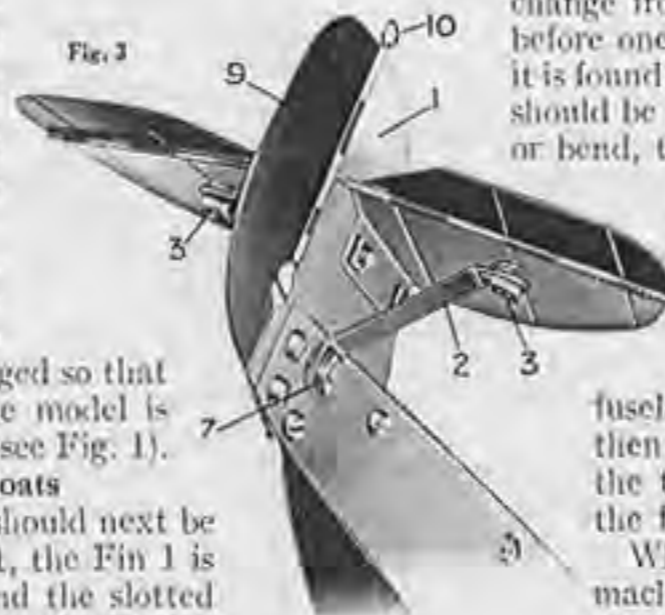

change from one to the other the Pivot Pin 10 must be withdrawn before one Rudder can be removed and the other fitted in place. If it is found that the Rudder 9 turns too easily about its pivot, the Pin 10 should be withdrawn and the straight portion given a slight "wave" or bend, the pin afterwards being reinserted in the hinge loops.

In Fig. 1 is shown the Fuselage Underside Middle section 9, which covers the centre portion of the Fuselage Underside. It is provided with four perforated lugs, the holes in the lugs being tapped so that bolts can be screwed into them. The Underside Middle section is placed in position so that the tapped hole 10 coincides with the hole 11 in the fuselage, and the hole 12 is in line with the hole 13. Bolts are then passed through the holes 11 and 13 and are screwed into the threaded holes 10 and 12. Bolts are also passed through the fuselage at the opposite side into similar threaded holes.

When an extended fuselage, such as is used in large cabin machines, is being built, the extra pair of Fuselage Sides Middle are used in conjunction with the Underside Extension piece. This part is not provided with tapped holes as is the Underside Centre, and it is therefore necessary to secure it in place by means of nuts and bolts. The Underside Extension must be bolted in position with slot placed forward before the Middle section is fitted. The slot allows the Rubber Driving Band to be used, as shown in Fig. 1, in models with an extended fuselage.

Wing Construction—Struts and their Uses

The assembly of the main planes of any of the models will be clear from the illustrations. In order to facilitate the identifying of the different Struts, each one is stamped with its part number, and before the wing construction is commenced the appropriate Struts should be selected by referring to the list of "parts required" given for the model. If a model of an unstaggered biplane is to be built, the Straight Interplane Struts (Nos. P28 and P187) are used in conjunction with Straight Centre Section Struts (P29). On the other hand, if a model of a biplane with staggered wings is under construction, the Staggered Struts (Nos. P24-5 and P185-6) are substituted for the straight pattern. Many military biplanes have very deeply staggered wings, the planes being connected to each other by "N" Struts.

In order to reproduce these features a special form of construction is employed. The "N" Strut formation is built from one Straight Strut (No. P187) and two Staggered Cross Struts (P100 or P101). The lower planes are bolted to the fuselage by Angle Brackets as in the case of a normal biplane, but the top plane is held to the fuselage by means of two "V" type Cross Struts (P188 and

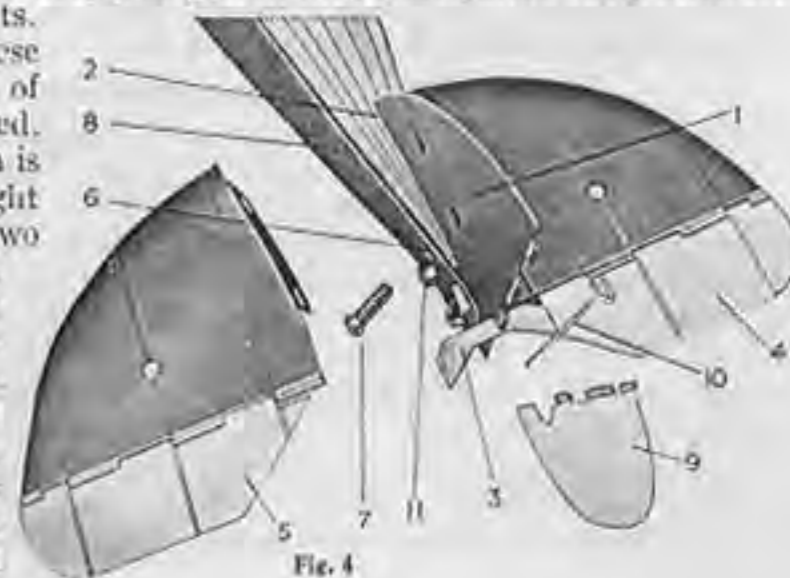

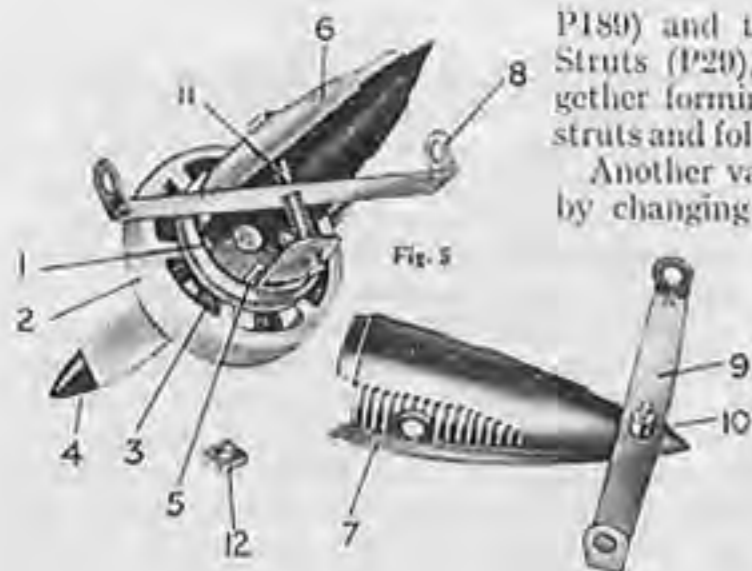

P180) and two Straight Centre Section Struts (P20), these parts when used together forming a pair of miniature "N" struts and following actual practice closely.

Another variation in wing form is made by changing the span or overall length.

For an equal span biplane the top wing may be composed of one Right-hand and one Left-hand Top Mainplane and the Centre Section or an Extension Plane, the lower wing consisting of one Right-hand and one Left-hand Lower Mainplane, the width of the fuselage making

up the required span. An equal span biplane of greater size results from the use of four Mainplanes, a Centre Section Plane and two Extension Planes, the Extension Planes being used to increase the span of the lower pair of wings. A biplane of this pattern can conveniently be built as a two "bay" machine by using two sets of Interplane Struts for each wing.

For an unequal span machine the Centre Section Plane may be used to increase the span of the top plane, or two Extension Planes bolted together serve the same purpose. In an unequal span model the planes are connected together by means of the Angled Struts (P26 and P27). The "N" type of interplane strutting can be used in an unequal span machine by using the Angled Cross Struts (P192 and P193) in conjunction with the standard Angled Interplane Struts (P26 and P27). The well-known sesquiplane or "one-and-a-half" wing type of aircraft is reproduced by using two small Mainplanes for the lower wings.

The ailerons of the Top and Bottom Large Mainplanes are coupled together by means of the Aileron Connecting Wires. The Short Aileron Connecting Wires (No. P162) are used to couple the Ailerons when the Straight Interplane Struts (No. P187) are used. The Medium length Wires (No. P161) are employed when the Staggered Struts (No. P185 and P186) are fitted, while the Long Aileron Connecting Wires (No. P163) are fitted to machines incorporating the Staggered Cross Struts (No. P190 and P191).

The Engine Units—Air-cooled and Water-cooled

There are three main types of engine used in aircraft to-day. These are multi-cylinder radial air-cooled engines, the "in line" pattern of air-cooled engine, and the water-cooled type. These three patterns are represented in the special Aero Outfits by two engine unit assemblies. The type shown in Figs. 5 and 6 represents the radial air-cooled engine and its accompanying streamlined nacelle, while the assembly shown in Fig. 7 does duty for either the cowled "in line" air-cooled engine or a water-cooled engine with cylinders set in "V" or "W" formation.

The Meccano Engine Units are designed to be fitted in various positions in a model. For instance, the radial air-cooled engine may be mounted on the Inter-

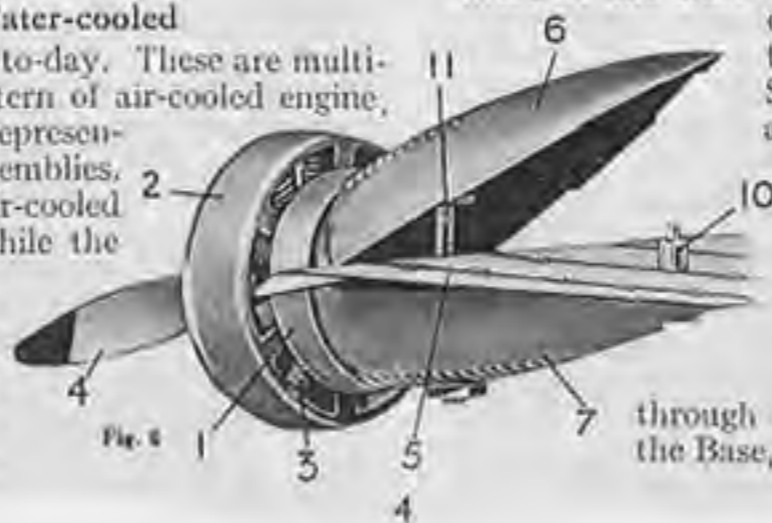

plane Struts midway between the wings of a biplane, as shown in Fig. 5, or above or below the main wing in a monoplane model. It may also be bolted directly into the "leading" or front edge of the wing, the halves of the Nacelle being placed against the top and bottom surfaces (see Fig. 6).

In Fig. 5, showing the "between wing" assembly, the Axis Pin 1 is first pushed through the Nacelle Front (Part No. P210) and the Towend Ring 2 is placed in position. This is followed by the Radial Engine 3, the screwed stud being pushed through the hole in the Towend Ring and through one of the holes in the Nacelle Front, a nut 5 being finally screwed on to the projecting end. The Propeller 4 is then mounted on the projecting end of the Axis Pin 1. The Nacelle Side 6 (Part No. P211) is pushed into position and the Screwed Rod 11 fitted with a nut is pushed through the hole in the Nacelle Side, and through the hole in the lug of the Nacelle Front. The Interplane Strut 8 is next slipped on to the Rod 11, and a similar Strut 9 is fitted over the Pin 10 of the second Nacelle Side 7 (Part No. P212). The piece 7 is then placed in position so that the end of the pin 10 fits into the small hole in the Side 6. The Screwed Rod 11 is pushed through the hole in the Nacelle Side 7 and fitted with a nut 12, that is screwed up tightly to hold the assembly together.

Wing Mounting for Radial Air-cooled Engine

When the engine assembly is to be mounted direct to the leading or front edge of the wing, the Radial Engine 3, complete with Townend Ring 2, Axis Pin and Propeller, is assembled to the Nacelle Front 1, as shown in Fig. 6. The Nacelle Side 7 is then placed underneath so that the pin 10 projects through the hole in the wing. The Screwed Rod 11 with lower nut in position is then passed through the Nacelle Side and Front sections and through the wing, and the Nacelle Side 6 is lowered into place to be secured by the second nut on the Rod 11.

The construction of the water-cooled type of cowling is shown in Fig. 7. The Propeller 2 is mounted on the Axis Pin 1 that is inserted in the bush fitted to the Base of the Cowling. To assemble the Cowling between the wings

of a model biplane, a Pierced Interplane Strut is inserted in the slot 9 in the piece 3. To do this, the perforated lug of the Strut is placed in the slot and the Strut is then turned at right angles so that it can be passed up through the slot. The Top

piece 4 is next pushed into place over the Base, and the Screwed Rod 5 is passed through the holes in the Top portion, and through the lugs in the Base piece 3 and the perforation in the Interplane Strut. The Screwed Rod is held in place by means of nuts 6 and 7 screwed on at each end. The rear Interplane Strut is pushed into the slot at the back of the casing, and a $\frac{3}{8}$ -in. Bolt is passed

through the holes 8 in the casing Top and through the lugs on the Base, so as to lock the cowling to the Strut.

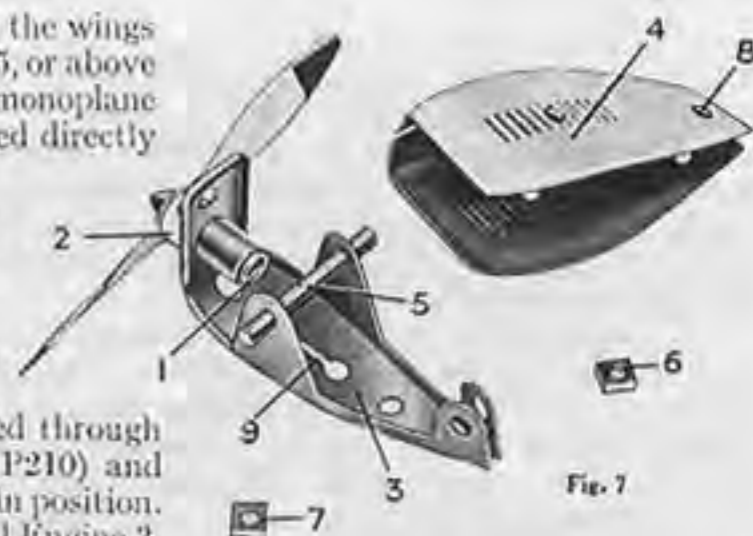

Run your Models with a Meccano Aero Clockwork Motor

To obtain the greatest amount of pleasure from the Meccano Aeroplane Constructor Outfits the models should be set in motion by means of the Aero Clockwork Motors. Two different types of Motors are available for this purpose, and are specially designed to fit inside the fuselage of a model aeroplane. The No. 1 Motor drives the Propeller at high speed and adds tremendously to the realism of the aeroplane, giving it a life-like effect. The No. 2 Motor drives the Propeller and also the Landing Wheels, so that the complete model taxis along the ground just like an actual machine. It may be made to travel in a straight line or in circles as desired, by adjusting the special Tail Wheel supplied with the Motor to replace the usual Tail Skid.

Both the No. 1 and the No. 2 Motors are supplied with a Propeller Control Rod and Extension Piece, and these should be fitted in place before either of the Motors is placed in position. The method of procedure is the same for both Motors, and Fig. 2 shows the positions occupied by the Control Rod and Extension. In this illustration the flanges of the Fuselage Top Front and Front sections are shown cut away to reveal the construction more clearly. The Propeller Control Rod 7 is inserted through the slot in the Fuselage Top Front, and its plain end is passed through the small hole in the Fuselage Front. This should be done before the two parts are bolted together, two bolts afterwards being inserted to secure the Fuselage Top Front, Sides Front and Front Sections together. The remainder of the fuselage is constructed in the usual way, but the Underside Middle and Undercarriage are omitted. The Underside Middle section cannot be fitted to models using a Clockwork Motor.

The Extension Piece 8 is fitted to the looped end of the Control Rod by means of a nut locked firmly on each side of the loop. The purpose of the Extension Piece is to facilitate control in model biplanes where the loop is inaccessible, and also in models fitted with a Cabin Head. The Extension should be attached before the Cabin Head is lowered into place, and is passed through the slot provided for it.

The Propeller Control Rod is pushed forward to prevent the Propeller from rotating while the Motor is being wound. It should not be pushed forward when the propeller is revolving.

The No. 1 Aero Motor

The No. 1 Aero Clockwork Motor, which is illustrated in Fig. 3, is supplied complete with Propeller Shaft 1, as well as with Propeller Control Rod and Extension Piece. The Collar 2 should be so placed that, when it rests against the inside of the Fuselage Front, the toothed end of the Propeller Shaft meshes

correctly with the contrate wheel 4 of the Motor. There are two different positions for the No. 1 Motor in the fuselage, and consequently the position of the Collar 2 varies accordingly. The position occupied by the Motor depends upon the type of "engine" fitted to the model, the air-cooled Radial Engine (Part No. P203) necessitating the placing of the Motor $\frac{1}{2}$ " nearer the nose of the machine than is necessary if the external engine is omitted. The end of the Propeller Shaft 1 complete with Collar is pushed through the upper hole in the Fuselage Front, and the toothed end of the Shaft is passed through the hole in the bearing lug 5 on the Motor, so that the teeth mesh with the contrate 4. The Motor is finally settled in position, and at the same time the Undercarriage V Struts are placed

on each side of the fuselage before the fixing bolts are inserted. If a Radial Engine is fitted the holes 6 should correspond with the front holes in the Fuselage Sides, and with the second holes if the Engine is omitted. The Propeller 3 is placed on the end of the Shaft 1 that projects through the Fuselage Front.

The No. 2 Aero Motor

Fig. 1 shows the No. 2 Aero Clockwork Motor in position, and Fig. 2 shows part of the nose cut away to reveal the arrangement of the various parts. Two Propeller Shafts are supplied with this Motor, the longer one being intended for use in models fitted with Radial Engines. The Shorter Shaft is shown at 2 in Fig. 2. A Landing Wheel Axle 3 provided with special pinion is also included with the Motor, in addition to the Propeller Control Rod and Extension. The method of fitting the Motor and

Propeller Shaft is similar to that described above for the No. 1 Motor, but in this case there is only one position for the Motor, the front pair of holes corresponding with the second pair in the Fuselage Sides.

The Undercarriage is fitted so that the front holes coincide with the front holes in the Motor. This position cannot be varied, and in models Nos. 2, 4, 5, 11 and 14 it is necessary to move the Undercarriage back one hole if it is desired to fit the Motor. The Motor cannot be fitted to models Nos. 20, 28, 32 and 41 owing to the position of the Undercarriage. The Shaft 3 should be inserted so that the pinion meshes with the right-hand side of the contrate 4 as shown in Fig. 2.

The Tail Wheel is shown fitted in position in Fig. 1. The lugs 10 (Fig. 2) are inserted inside the Fuselage Sides Rear and secured by the $\frac{1}{8}$ " Bolt 12. By adjusting the position of the wheel frame 11 on the toothed rack 13, the aeroplane may be made to travel in any forward direction at

the will of the operator.

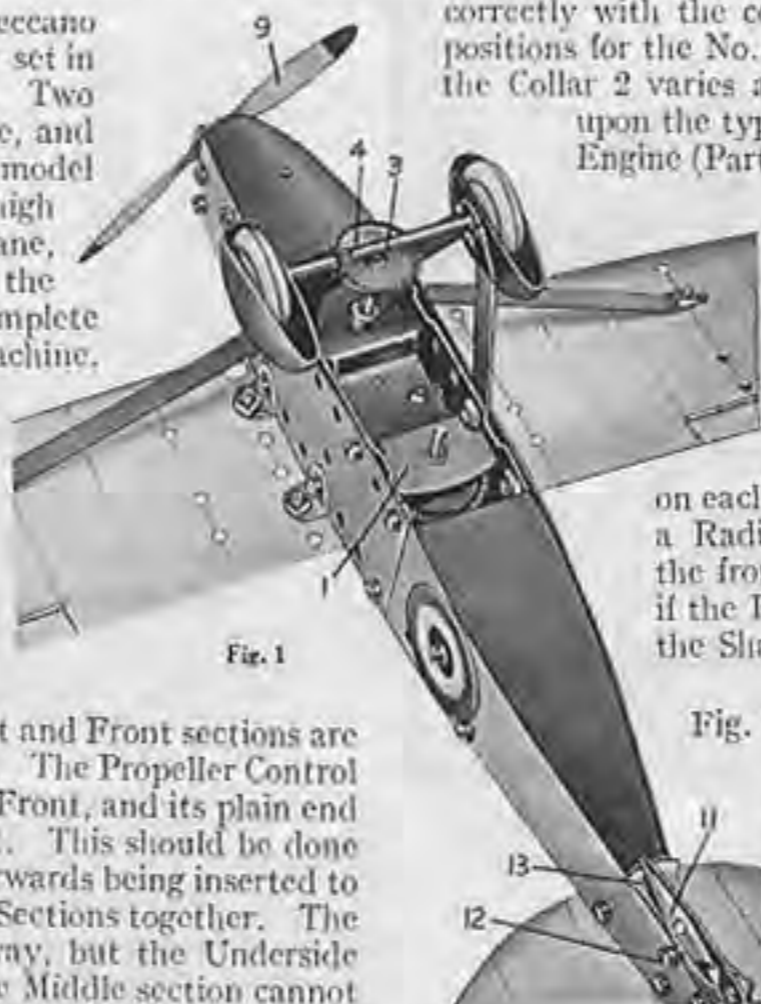

Fig. 1



Fig. 2

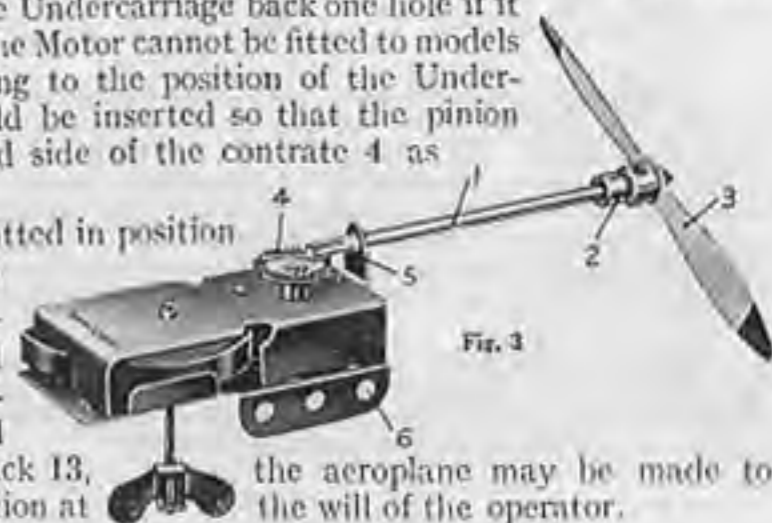
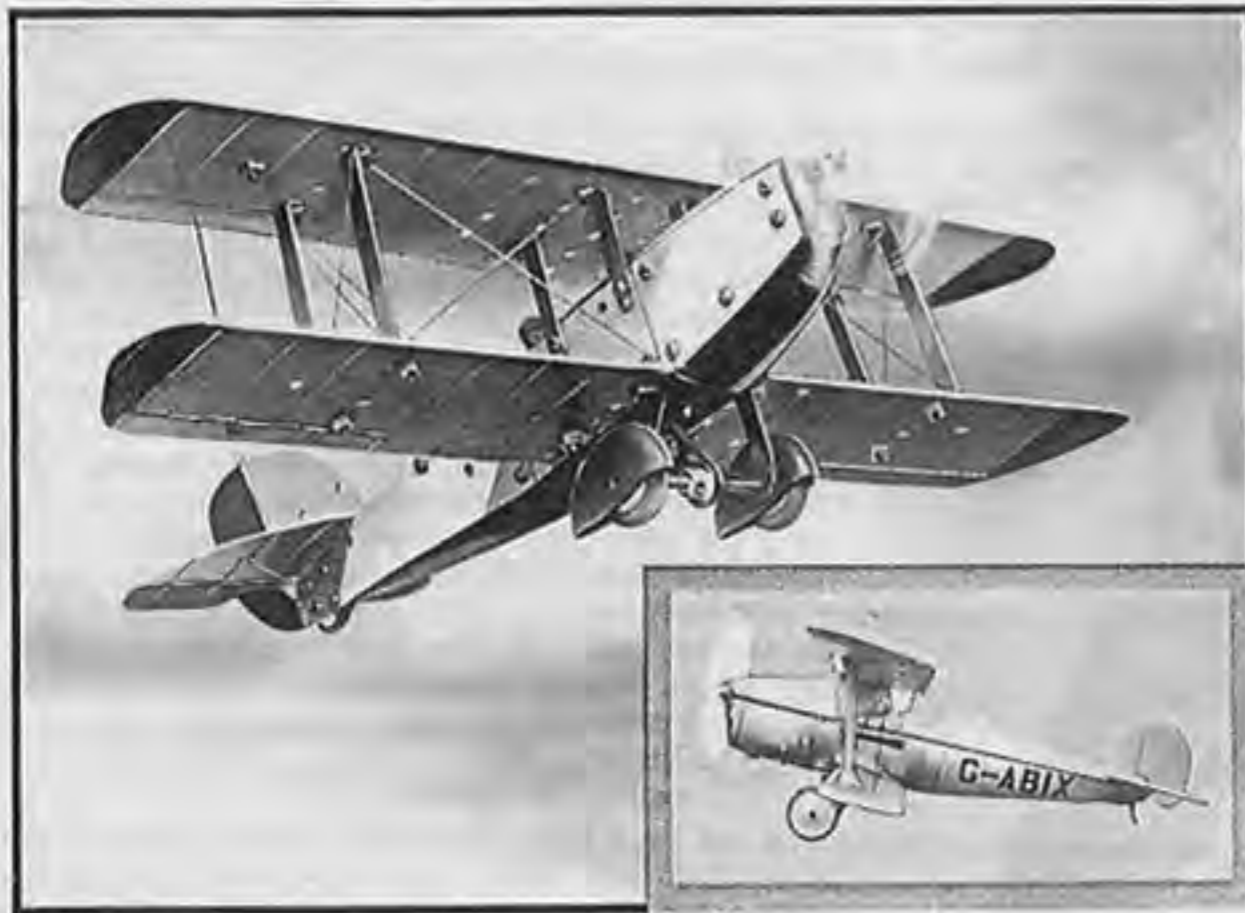

Fig. 3

Model No. S.1 Light Single-Seater Biplane



Parts required:

1 of No. P8	1 of No. P58	1 of No. P168	1 of No. P208
1 " " P15	1 " " P59	1 " " P169	1 " " P209
2 " " P18	1 " " P62	1 " " P171	4 " " 12
4 " " P28	1 " " P100	1 " " P172	1 " " 14
4 " " P29	1 " " P151	1 " " P173	2 " " 23A
2 " " P44	1 " " P152	1 " " P175	46 " " 537A
1 " " P52	1 " " P155	2 " " P176	49 " " 537B
2 " " P53	1 " " P156	1 " " P178	1 " " 540
1 " " P54	2 " " P162	1 " " P179	1 " " 611c
1 " " P55	1 " " P164	1 " " P196	
1 " " P56	1 " " P165	1 " " P198	

The single-seater aeroplane makes a popular appeal by reason of its speed and lightness, and the small amount of space in which it can be housed. It is only comparatively recently that special attention has been given to the production of aeroplanes of this type, which may be described as the motor cycles of the air, but they promise to become very numerous before long. Their price is relatively low and the cost of upkeep very small. They are capable of excellent performance, however, and are ideal machines for cross-country work.

Typical British light single-seater biplanes are the Southern "Martlet" and the Arrow "Active." A photograph of the "Active" appears on the left. This machine is equipped with a "Cirrus-Hermes 11B" engine developing between 100 and 104 h.p., and it has a maximum speed of 140 m.p.h. and a cruising speed of 125 m.p.h. It lands at 50 m.p.h., and measures 24 ft. in span, that is, from the tip of the port wing to the tip of the starboard one. It is 7 ft. 4 in. in width with the wings folded.

Model No. S.2 Cantilever Parasol Monoplane

Parts required:

1 of No. P8	1 of No. P58	1 of No. P171	1 of No. P208
1 " " P15	1 " " P59	1 " " P172	1 " " P209
2 " " P18	1 " " P62	1 " " P173	1 " " 14
4 " " P29	1 " " P100	1 " " P175	2 " " 23A
2 " " P44	1 " " P151	2 " " P176	36 " " 537A
1 " " P52	1 " " P152	1 " " P178	42 " " 537B
2 " " P53	1 " " P164	1 " " P179	1 " " 611c
1 " " P54	1 " " P165	1 " " P196	
1 " " P55	1 " " P168	1 " " P198	
1 " " P56	1 " " P169	1 " " P203	

A cantilever parasol monoplane can be distinguished from an ordinary parasol monoplane by the fact that the plane requires no struts, except of course those that connect it to the fuselage. The wings of cantilever machines are built on a similar principle to that which governs the construction of cantilever bridges. This means that the stresses on one half of the plane are not all transferred to the fuselage in the usual manner, but are mainly compensated by stresses on the other half of the plane, thus making it possible to eliminate the customary struts and bracing wires that are used to take up the strain on an ordinary parasol. Other models of machines using cantilever wings are Nos. 5 and 11.

The illustration on the right shows an interesting French cantilever parasol monoplane, the Albert A.120. This is a single-seater machine that makes use of a 40 h.p. Salmson engine, which gives it a maximum speed of 90 m.p.h. and a minimum flying speed of 48 m.p.h. It is 851 lb. in weight when fully loaded.

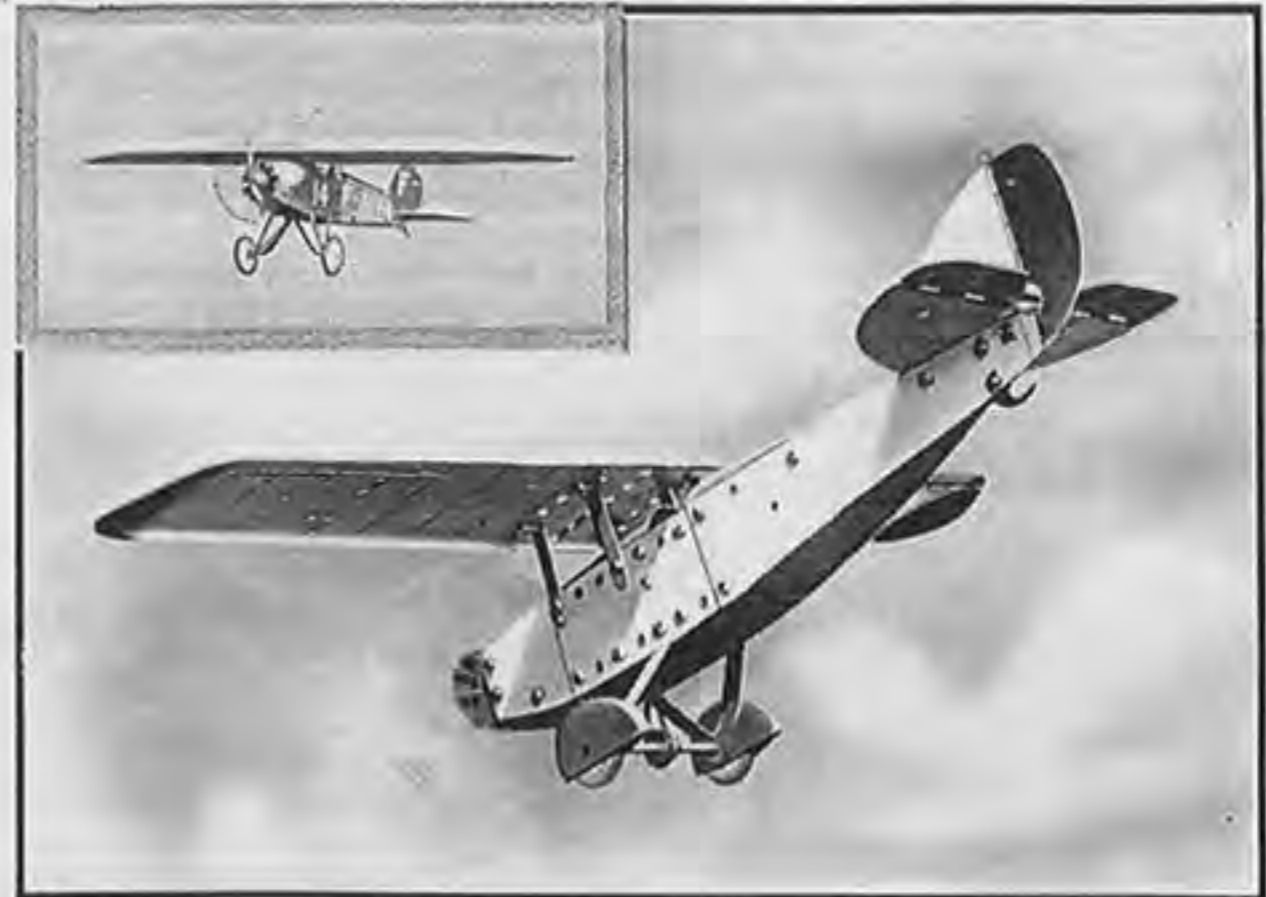

Model No. S.3 Low Wing Interceptor Fighter

Parts required:

1 of No. P15	1 of No. P62	1 of No. P169	1 of No. P198
2 " " P18	1 " " P100	1 " " P171	1 " " P201
2 " " P31	2 " " P101	1 " " P172	1 " " P203
2 " " P44	2 " " P102	1 " " P173	1 " " P208
2 " " P53	1 " " P151	1 " " P175	1 " " P209
1 " " P54	1 " " P152	2 " " P176	1 " " 14
1 " " P55	1 " " P164	1 " " P178	2 " " 23A
1 " " P56	1 " " P165	1 " " P179	42 " " 537A
1 " " P58	1 " " P168	1 " " P195	45 " " 537B
1 " " P59			

Although the Royal Air Force do not officially use low wing interceptor fighters, three machines of this type have been produced by British aircraft firms. These are the de Havilland and the Westland interceptor fighters, and the Vickers "Jockey," all of which are exceedingly fast machines. The "Jockey," for instance, which is illustrated opposite, is capable of travelling at 218 m.p.h. at an altitude of 9,840 ft., and of climbing to a height of 19,860 ft. in 11.6 min. Its initial rate of climb is 1,850 ft. per min., and its absolute ceiling, beyond which it cannot ascend, is 31,500 ft. It lands at 62 m.p.h.

The duty of the interceptor fighter is to take off from its aerodrome as soon as news is received that enemy bombers have crossed the coast, and to intercept the enemy machines before they have time to reach and drop their bombs on London or other cities.

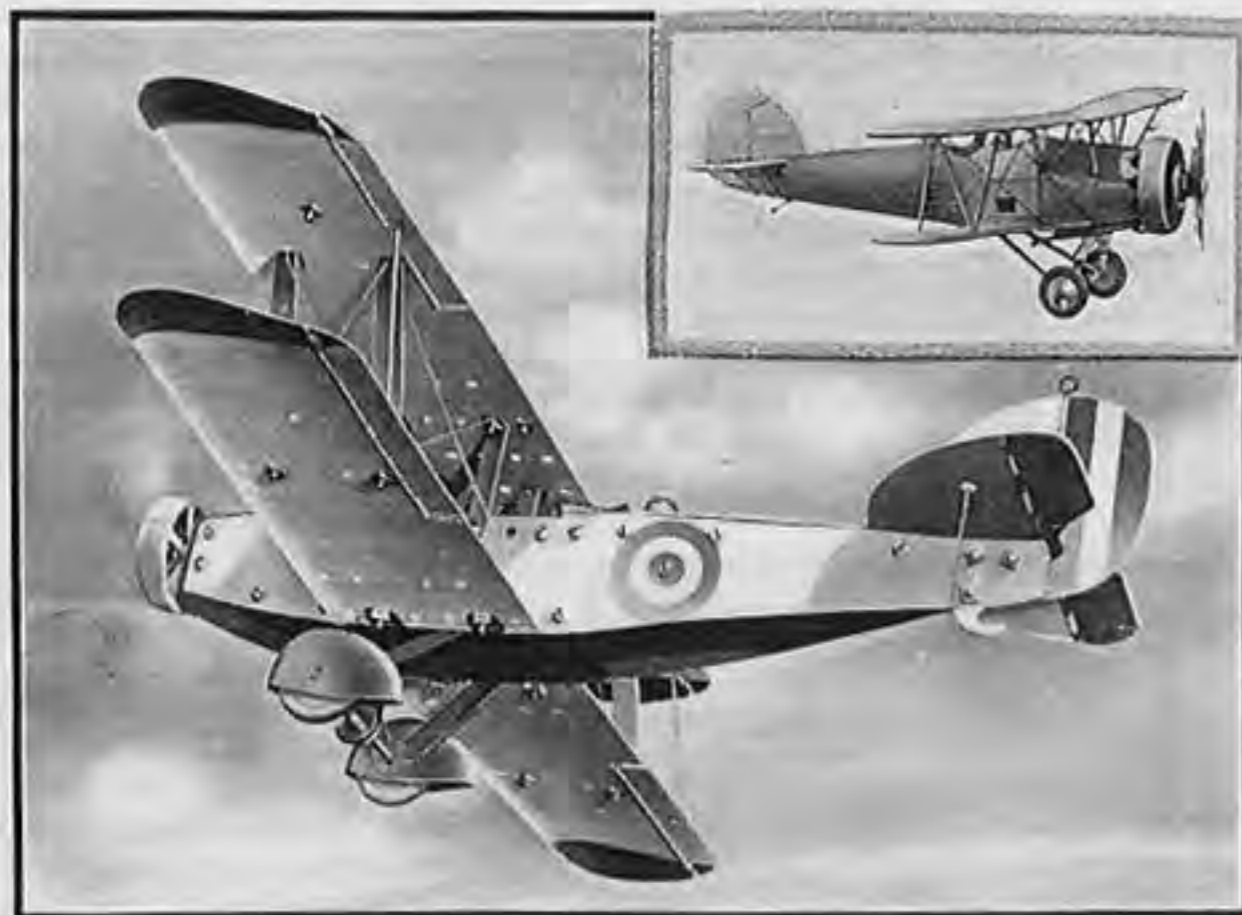
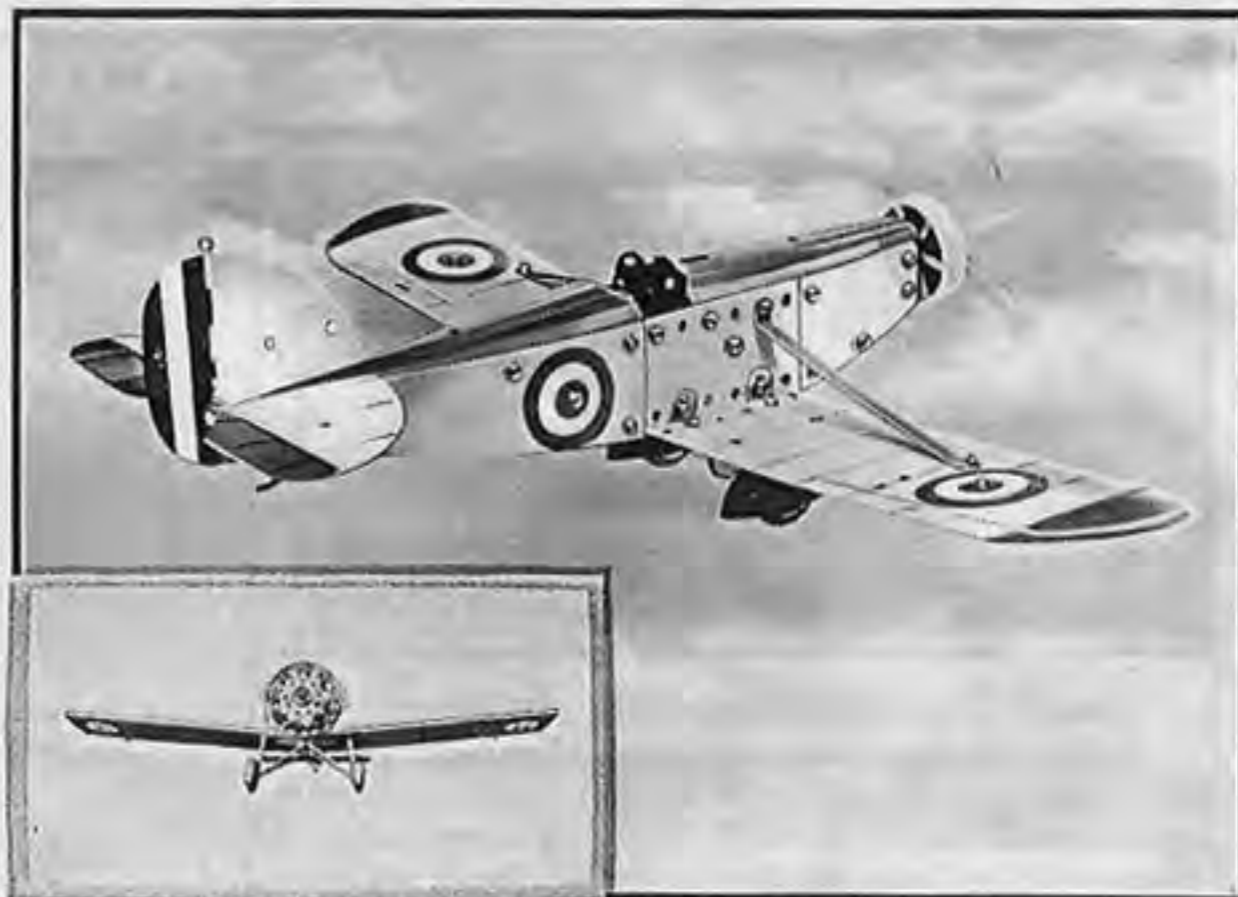

Model No. S.4 Day Bomber

Parts required:

1 of No. P8	1 of No. P59	1 of No. P168	1 of No. P201
2 " " P18	1 " " P62	1 " " P169	1 " " P203
2 " " P24	2 " " P100	1 " " P170	1 " " P208
2 " " P25	2 " " P101	1 " " P171	1 " " P209
4 " " P29	2 " " P102	1 " " P172	4 " " 12
2 " " P44	1 " " P151	1 " " P173	1 " " 14
1 " " P52	1 " " P152	1 " " P175	2 " " 23A
2 " " P53	1 " " P155	2 " " P176	58 " " 537A
1 " " P54	1 " " P156	1 " " P178	60 " " 537B
1 " " P55	2 " " P161	1 " " P179	1 " " 540
1 " " P56	1 " " P164	1 " " P195	1 " " 611c
1 " " P58	1 " " P165	1 " " P198	

Day bombers may easily be distinguished from night bombers by their much smaller size, and by the fact that they usually carry only a pilot and one gunner, whereas the crew of a night bomber may consist of four or five men. The night bomber relies upon remaining unseen by reason of its dark colour and the height at which it flies, and if discovered it trusts to its comparatively large number of machine guns to beat off attackers. The day bomber, on the other hand, obviously cannot be hidden, and depends principally upon its speed, which is often as great as that of the single-seater fighters that will endeavour to stop it. For example, the maximum speed of the Hawker "Hart," the machine illustrated on the left, is 184 m.p.h., which is approached only by very modern fighters.



Model No. S.5 Cantilever Biplane

The cantilever type of wing construction is not only suitable for use in monoplanes, but also may be employed in biplanes. Much interesting work in the development of the cantilever biplane has been carried out by the Darmstadt University Aviation Society, which is composed of a group of students from the Darmstadt Technical High School who gain their practical experience by building aeroplanes of their own design. The first machines constructed were gliders and some very famous types were built. It is interesting to note that many of these machines have had a great effect upon German sailplane design. The first powered aeroplane to be built was the "Mahomed," which was made in 1924, and which secured several prizes in a number of competitions.

The latest type built by the Society is known as the Darmstadt D.22, and is a two-seater light aeroplane in which the absence of all struts and bracing, made possible owing to the use of the cantilever wings, is particularly noticeable. The machine, which is shown on the right, is 24ft. 3in. in span, 21ft. 2in. in overall length, and fitted with an "Argus" inverted engine that develops 150 h.p. It has a maximum speed of about 149 m.p.h. and a cruising speed of 136.6 m.p.h.; its landing speed is 43.6 m.p.h. It is interesting to note that the Darmstadt D.22 is developed from the D.18 cantilever biplane. This machine, equipped with an Armstrong Siddeley "Genet" engine, set up a world's speed record for its class.



Parts required to build Model No. S.5

1 of No.	P8	1 of No.	P169
2 "	P18	1 "	P170
4 "	P29	1 "	P171
2 "	P44	1 "	P172
1 "	P52	1 "	P173
2 "	P53	1 "	P175
1 "	P54	2 "	P176
1 "	P55	1 "	P178
1 "	P56	1 "	P179
1 "	P58	1 "	P196
1 "	P59	1 "	P198
1 "	P62	1 "	P203
2 "	P100	1 "	P208
1 "	P151	1 "	P209
1 "	P152	4 "	12
1 "	P155	1 "	14
1 "	P156	2 "	23A
1 "	P164	43 "	537A
1 "	P165	44 "	537B
1 "	P168	1 "	611c

Parts required to build Model No. S.6

1 of No.	P15	1 of No.	P173
2 "	P18	1 "	P175
2 "	P31	2 "	P176
4 "	P44	1 "	P178
1 "	P52	1 "	P179
2 "	P53	1 "	P184
1 "	P54	1 "	P196
1 "	P55	1 "	P198
1 "	P56	1 "	P201
1 "	P58	1 "	P203
1 "	P59	1 "	P208
1 "	P62	1 "	P209
1 "	P151	4 "	12
1 "	P152	1 "	14
1 "	P164	2 "	23A
1 "	P165	39 "	537A
1 "	P168	41 "	537B
1 "	P169	1 "	540
1 "	P171	1 "	611c
1 "	P172		



Model No. S.6 Commercial Low Wing Monoplane

This model is similar to Model No. 7, but it represents a somewhat larger type of machine, separate cabins being provided for the pilot and passengers. In small cabin machines the passenger or passengers are generally accommodated in the same cabin as the pilot, the seats being arranged either side by side or in tandem behind that of the pilot. Some idea of the respective sizes of a light cabin machine and a large commercial monoplane may be gained from the fact that the four-seater Blackburn "Segrave" has a span of 39ft. 6in. while the Junkers G.31 twelve-passenger low wing monoplane is 99ft. 6in. in span.

The low wing monoplane is very popular with Continental aeronautical firms. An interesting French machine is the Blériot III, illustrated below, which is widely used on French air lines, and has accommodation for 10 passengers and two pilots. It is capable of travelling at 115 m.p.h. for short periods, and cruises at 105 m.p.h. The span of the wings is about 52ft. 6in., while the overall length of the machine is 35ft. 8in. and the height 10ft. 6in. When empty the machine is 2,860lb. in weight and it is capable of carrying a disposable load of 2,200 lb., making an all-up weight of 5,060lb.



A well-known German single-engined commercial low wing monoplane is the Junkers F.13L, which is a four-seater cabin monoplane equipped with a 280 h.p. Junkers engine. It has a maximum speed at sea level of 123 m.p.h. and cruises at 106 m.p.h. Its tank capacity is sufficient to enable it to travel for a distance of 620 miles without refuelling.



Model No. S.7 Light Low Wing Cabin Monoplane

One of the most striking features of modern British aeronautical design is the rapidity with which the low wing monoplane has grown in popularity, about a dozen machines of this type now being built in England. They range from small single-seaters, intended for the private owner and for racing, to single and twin-engined commercial machines, and still larger ones such as the Fairey Night Bomber, which has a span of more than 100 ft. and weighs nearly 8½ tons. In addition to its designed work of night bombing, the Fairey can be adapted for service as a troop carrier with accommodation for from 15 to 20 men.

The prototype photograph below is of a typical British light low wing monoplane, the Hendy 302. This is a two-seater cabin machine equipped with one "Cirrus Hermes" four-cylinder-in-line air-cooled engine that develops between 105 and 115 h.p. It measures 36 ft. in span and 22 ft. 10 in. in length, and has a maximum speed of 132 m.p.h., a cruising speed of 112 m.p.h., and a minimum speed of 37 m.p.h. It is capable of climbing from ground level to an altitude of 5,000 ft. in 7.1 min. Another famous machine of this type is the Percival "Gull," which is a three-seater machine equipped with a 130 h.p. Cirrus "Hermes" engine that gives it a maximum speed of 145 m.p.h. The machine was one of the most outstanding types produced in Great Britain in 1932, for it is capable of carrying nearly its own weight of disposable load. The machine cruises at a speed of 125 m.p.h. and lands at only 42 m.p.h.



Parts required to build Model No. S.7

1 of No. P15	1 of No. P172
2 " " P18	1 " " P173
2 " " P31	1 " " P175
4 " " P44	2 " " P176
1 " " P52	1 " " P178
2 " " P53	1 " " P179
1 " " P54	1 " " P184
1 " " P55	1 " " P196
1 " " P56	1 " " P198
1 " " P58	1 " " P208
1 " " P59	1 " " P209
1 " " P62	4 " " 12
1 " " P151	1 " " 14
1 " " P152	2 " " 23A
1 " " P164	39 " " 537A
1 " " P165	39 " " 537B
1 " " P168	1 " " 540
1 " " P169	1 " " 611c
1 " " P171	

Parts required to build Model No. S.8

1 of No. P8	2 of No. P161
1 " " P15	1 " " P164
1 " " P18	1 " " P165
2 " " P24	1 " " P168
2 " " P25	1 " " P169
4 " " P29	1 " " P171
1 " " P44	1 " " P172
1 " " P52	1 " " P173
2 " " P53	1 " " P175
1 " " P54	2 " " P176
1 " " P55	1 " " P178
1 " " P56	1 " " P179
1 " " P58	1 " " P195
1 " " P59	1 " " P198
1 " " P62	1 " " P208
1 " " P63	1 " " P209
1 " " P100	4 " " 12
2 " " P101	1 " " 14
2 " " P102	2 " " 23A
1 " " P151	48 " " 537A
1 " " P152	51 " " 537B
1 " " P155	1 " " 540
1 " " P156	1 " " 611c

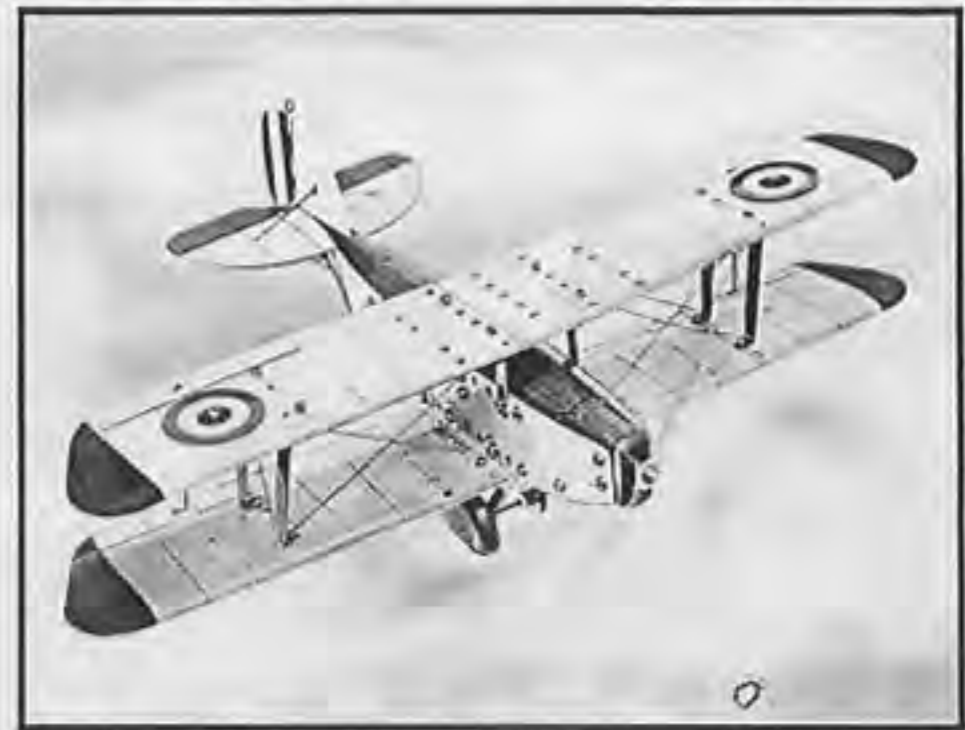

Model No. S.8 Interceptor Fighter

The interceptor fighter is a specialised development of the single-seater fighter that has been evolved in recent years. With the introduction into aerial tactics of the high-speed bomber, it became necessary to produce a very fast defensive machine, and so the interceptor fighter came into existence. It is distinguished from an ordinary single-seater fighter by the fact that in it speed and climbing powers have been gained at the expense of endurance, and by cutting down the amount of military equipment carried. The interceptor fighter is not required to take part in the patrolling of areas that is carried out by an ordinary fighter, but is sent up into the air only when definite information of the approach of enemy aircraft has been received.

The interceptor fighter that is standard equipment in the R.A.F. is the Hawker "Fury," which is illustrated below. This is capable of travelling at a speed of 207 m.p.h. when at an altitude of 10,000 ft., and at 214 m.p.h. at 13,000 ft. When it climbs to 20,000 ft. the speed falls again to 207 m.p.h. In 9 min. 40 secs. after taking off from an aerodrome at sea level, a pilot in one of these machines could reach a height of 20,000 ft. It is interesting to note that the "Fury," like

all Hawker machines, is built on a somewhat similar principle to Meccano aeroplanes. It is of all-metal construction, and the tubes used to build up the frame are flattened where they come into contact with one another, and joined together by means of flat plates and tubular rivets. This enables a great deal of the work of erection to be done by men who are only semi-skilled.



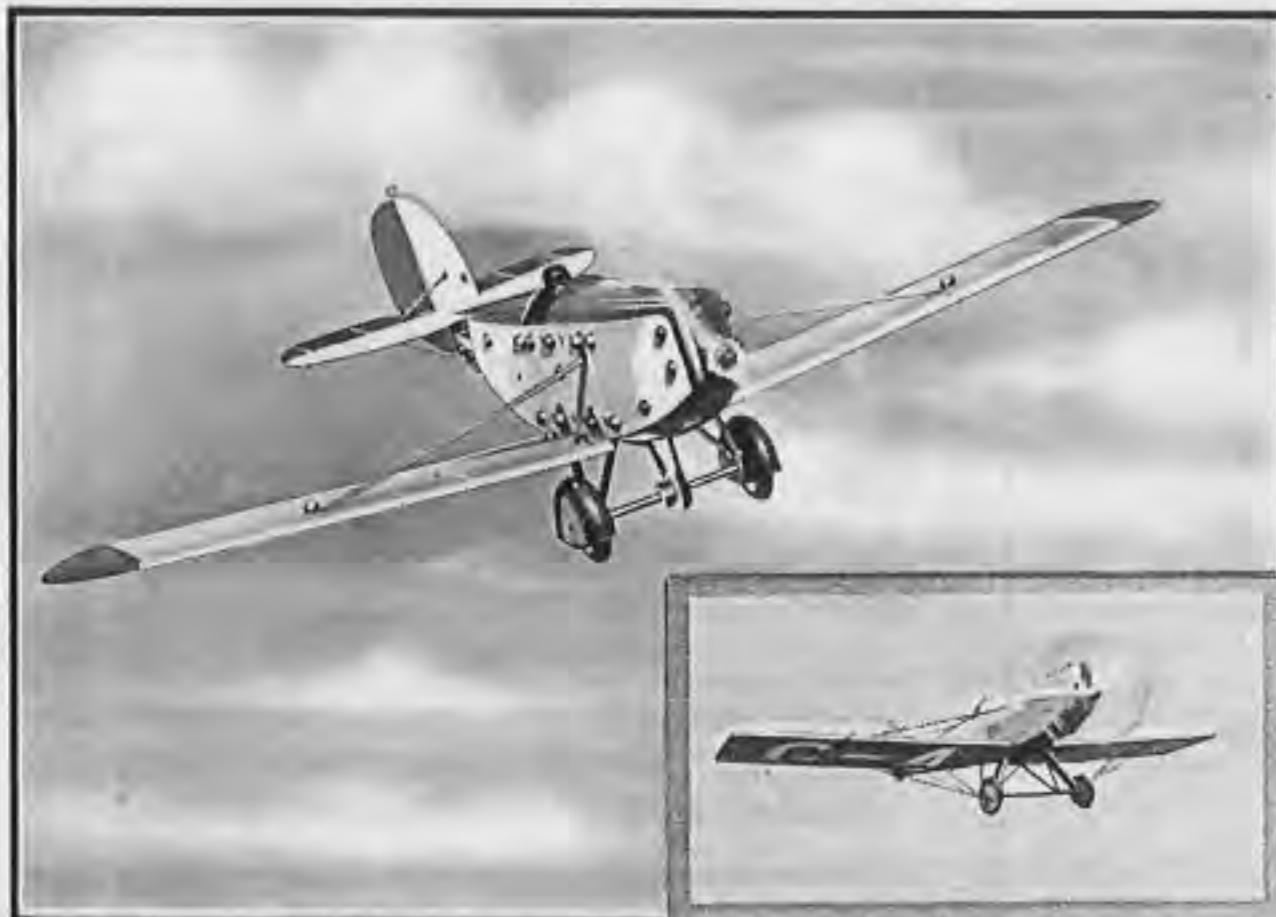

Model No. S.9 Single-Seater Low Wing Monoplane

Few single-seater low wing monoplanes are constructed in this country, as they are not so popular as machines that are capable of carrying at least one passenger in addition to the pilot. Single-seater aeroplanes are very economical in operation, however, and are therefore useful for pilots who have gained their "A" licence and are trying to obtain the flying experience necessary to make them eligible for the "B," or commercial, licence. Single-seater machines of this type, when fitted with a more powerful engine, are also useful for entry in racing events such as the King's Cup Air Race.

An interesting British low wing monoplane is the Avro "Avian Monoplane," built by the well-known firm of A. V. Roe & Co. Ltd., of Manchester. It is illustrated on the left of this article. Racing single-seater low wing monoplanes are the Comper "Streak" and the Hendy 3302. Each of these machines has a speed of about 200 m.p.h. and lands at about 60 m.p.h. They were designed for a series of international air race meetings that were to have been held in this country in 1933, but which unfortunately had to be abandoned.

Parts required :

1 of No. P15	1 of No. P59	1 of No. P171	1 of No. P208
2 " " P18	1 " " P62	1 " " P172	1 " " P209
2 " " P31	1 " " P100	1 " " P173	4 " " 12
2 " " P44	1 " " P151	1 " " P175	1 " " 14
1 " " P52	1 " " P152	2 " " P176	2 " " 23A
2 " " P53	1 " " P164	1 " " P178	42 " " 537A
1 " " P54	1 " " P165	1 " " P179	45 " " 537B
1 " " P55	1 " " P168	1 " " P196	1 " " 540
1 " " P56	1 " " P169	1 " " P198	1 " " 611c
1 " " P58			

Model No. S.10 Single-Seater Fighter

The single-seater fighter is a fast machine with good climbing powers, whose duty is to patrol certain areas to see that no enemy aircraft get through. The machines are usually provided with two fixed machine guns synchronised to fire through the airscrew, but in the Gloster S.S.19 there are six machine guns, all of which can be fired simultaneously. This makes it a particularly dangerous machine, but it is not standard equipment in the R.A.F. It can travel at a speed of 170 m.p.h. at ground level and at 193.5 m.p.h. when flying at an altitude of 10,000 ft.

The world's most famous standard machine of this type is the Bristol "Bulldog," a photograph of which appears on the right. This has a speed of 170 m.p.h. at a height of 10,000 ft., and is capable of climbing to an altitude of 20,000 ft. in 14.5 min. It measures 34 ft. in span, and 24 ft. 9 in. in length, and weighs 3,490 lb. fully loaded. It is used in the R.A.F. and the air forces of many foreign countries.

Parts required :

1 of No. P8	1 of No. P58	1 of No. P165	1 of No. P201
1 " " P15	1 " " P59	1 " " P168	1 " " P203
2 " " P18	1 " " P62	1 " " P169	1 " " P208
2 " " P24	1 " " P100	1 " " P171	1 " " P209
2 " " P25	2 " " P101	1 " " P172	4 " " 12
4 " " P29	2 " " P102	1 " " P173	1 " " 14
2 " " P44	1 " " P151	1 " " P175	2 " " 23A
1 " " P52	1 " " P152	2 " " P176	55 " " 537A
2 " " P53	1 " " P155	1 " " P178	57 " " 537B
1 " " P54	1 " " P156	1 " " P179	1 " " 540
1 " " P55	2 " " P162	1 " " P195	1 " " 611c
1 " " P56	1 " " P164	1 " " P198	

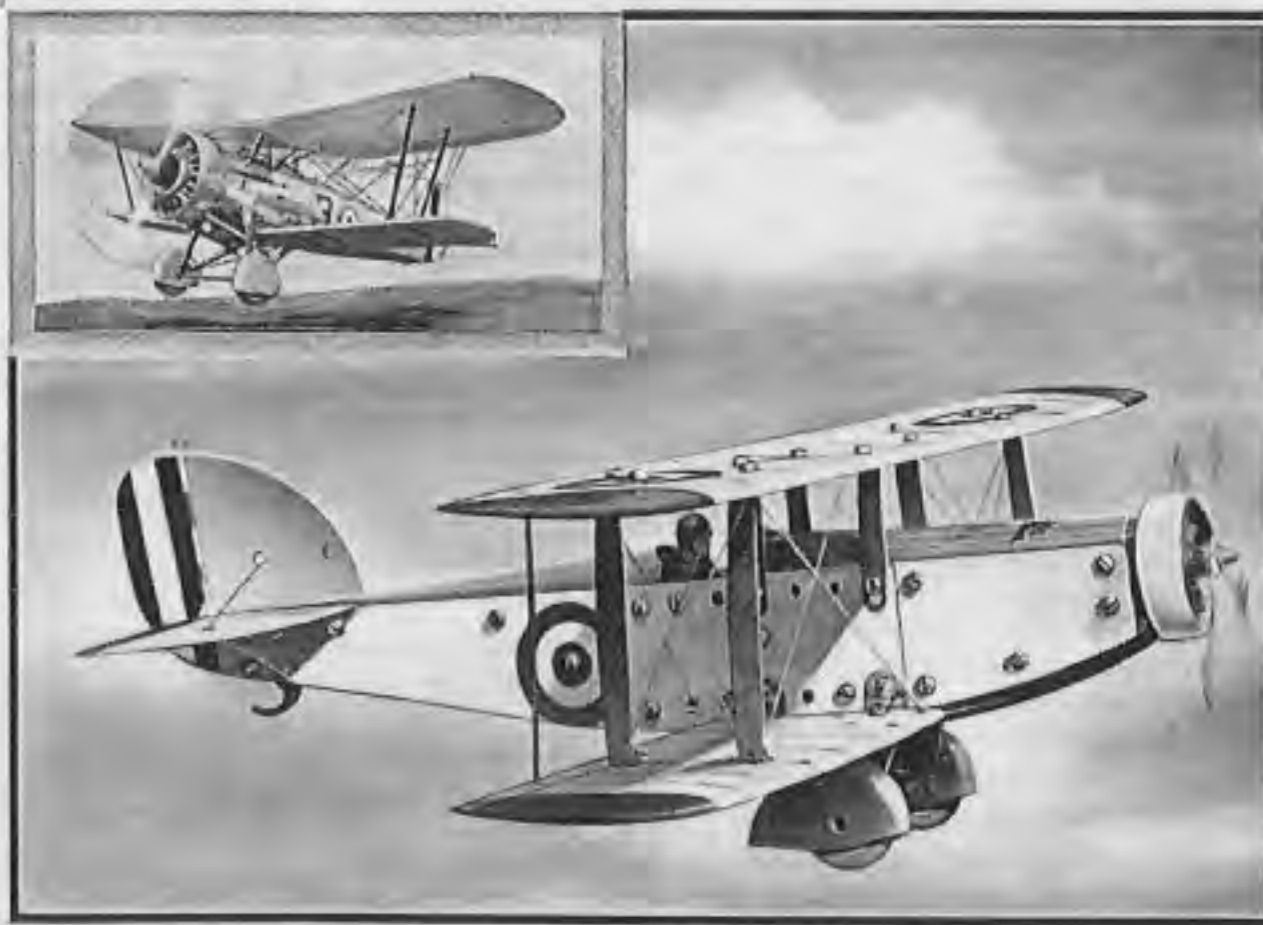

Model No. S.11 Cantilever High Wing Monoplane

The cantilever high wing monoplane is simply a high wing monoplane provided with wings built on the principle described in connection with Model No. 2. It is interesting to note that Mr. Anthony H. G. Fokker, the famous Dutch aero designer, has always had great faith in this type, and the majority of Fokker aircraft are high wing monoplanes employing cantilever wings built on the special Fokker principle. His method of wing construction consists of the use of two box spars and a number of plywood ribs, the whole being covered with plywood. Wooden wings are almost always employed on Fokkers, even when the rest of the machine is built of metal.

Our photograph on the right is of a Fokker F.VIIa cantilever monoplane with accommodation for eight passengers, and capable of travelling at a maximum speed of about 126 m.p.h., and a cruising speed of 106.8 m.p.h. The machine has a range at cruising speed of 578 miles. It may be equipped with various types of engines.

Parts required :

1 of No. P8	1 of No. P58	1 of No. P172	1 of No. P201
1 " " P15	1 " " P59	1 " " P173	1 " " P203
2 " " P18	1 " " P62	1 " " P175	1 " " P208
2 " " P29	1 " " P151	2 " " P176	1 " " P209
2 " " P44	1 " " P152	1 " " P178	1 " " 14
1 " " P52	1 " " P164	1 " " P179	2 " " 23A
2 " " P53	1 " " P165	1 " " P184	39 " " 537A
1 " " P54	1 " " P168	1 " " P196	41 " " 537B
1 " " P55	1 " " P169	1 " " P198	1 " " 611c
1 " " P56	1 " " P171		

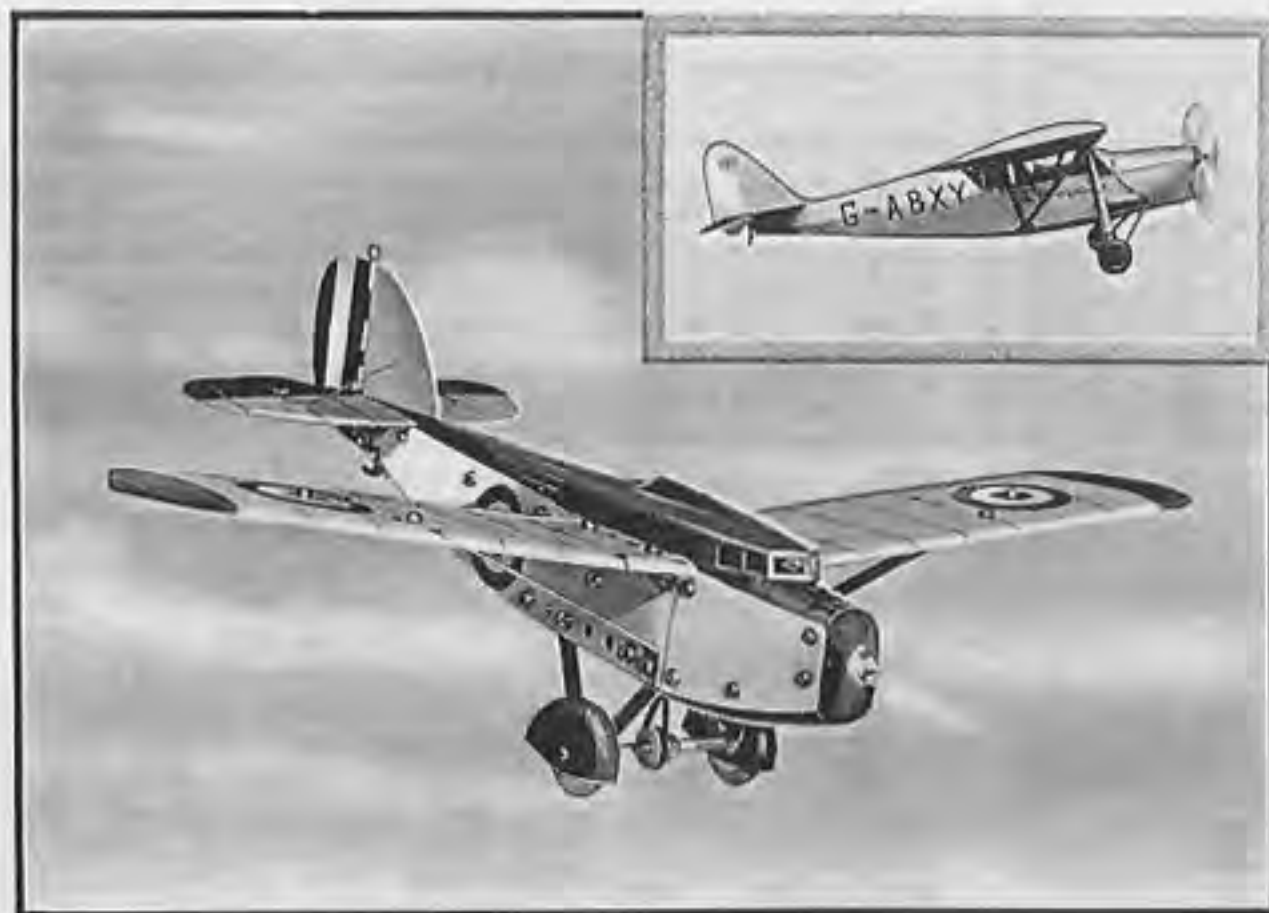
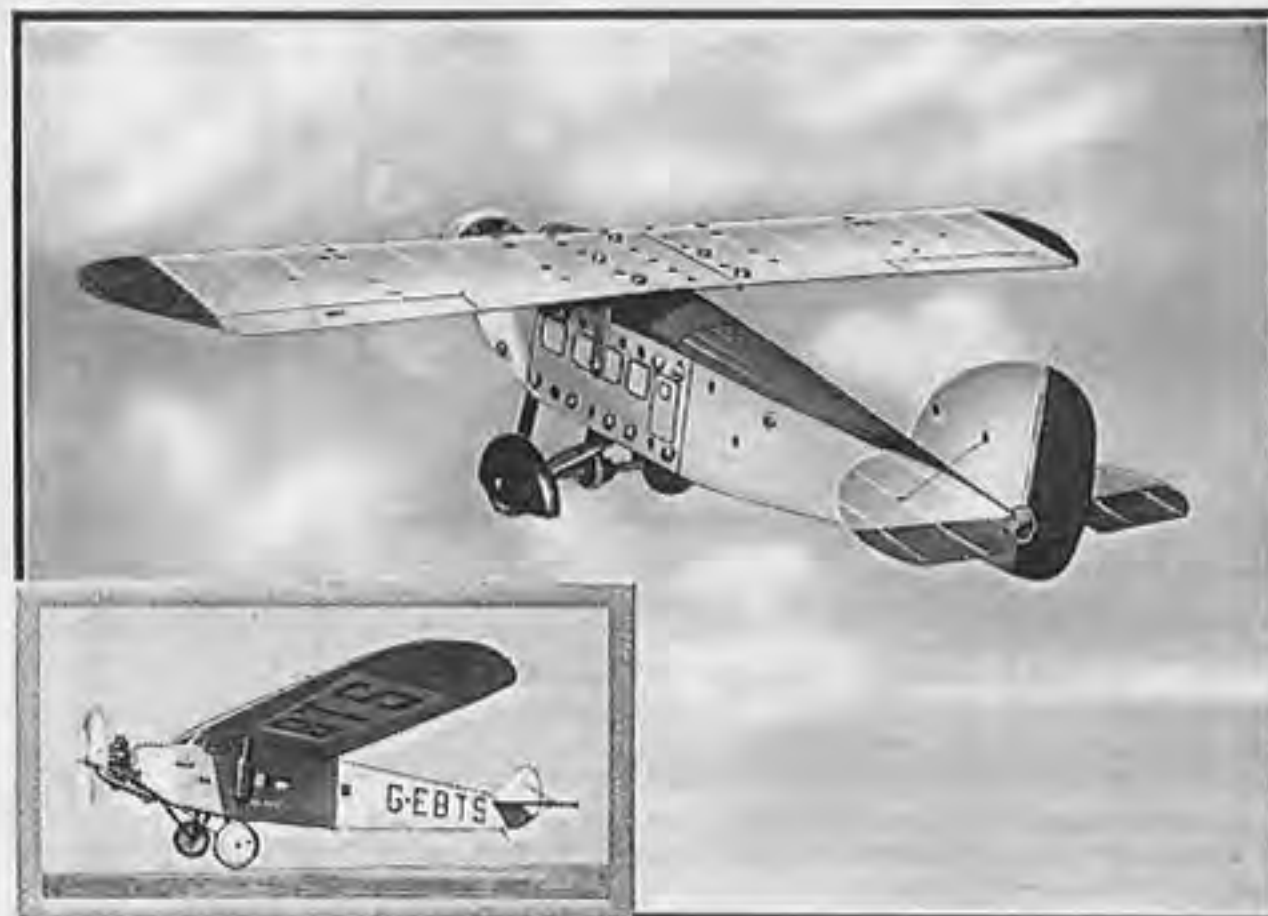

Model No. S.12 Light High Wing Cabin Monoplane

The light high wing cabin monoplane is a product of comparatively recent years. The type was designed to give rather more comfort than can be obtained in the usual open two-seater light biplane. It is, of course, more expensive both in initial and operating costs, but it is very popular with private owners, for it is not necessary to wear goggles or any extra clothing when flying a machine of this kind. This is a particularly valuable feature for those who have a private aeroplane for use on business journeys, as it enables them to keep clean instead of arriving at their destinations dirty and dishevelled.

Many famous flights have been made in light cabin high wing monoplanes. The late Mr. Bert Hinkler made the first non-stop east to west crossing of the south Atlantic in a light cabin machine, a D.H. "Puss Moth." This machine was also selected by Mr. J. A. Mollison for flights over both the North and the South Atlantic. An illustration of Mr. Mollison's "Puss Moth," the "Heart's Content," appears on the left.

Parts required :

1 of No. P15	1 of No. P59	1 of No. P171	1 of No. P208
2 " " P18	1 " " P62	1 " " P172	1 " " P209
2 " " P31	2 " " P101	1 " " P173	4 " " 12
2 " " P44	2 " " P102	1 " " P175	1 " " 14
1 " " P52	1 " " P151	2 " " P176	2 " " 23A
2 " " P53	1 " " P152	1 " " P178	44 " " 537A
1 " " P54	1 " " P164	1 " " P179	43 " " 537B
1 " " P55	1 " " P165	1 " " P184	1 " " 540
1 " " P56	1 " " P168	1 " " P195	1 " " 611c
1 " " P58	1 " " P169	1 " " P198	



Model No. S.13 Single-Engined Commercial Biplane

Immediately after the Great War, most of the aeroplanes employed for commercial purposes were military machines in which slight modifications had been made. For this reason, and also because the loads that had to be carried were for the most part light, as compared with those of to-day, single-engined machines were almost exclusively employed, even for flights that involved crossing over water, such as journeys across the English Channel. Nowadays, of course, multi-engined aeroplanes are always employed by air traffic companies for flights of this nature, single-engined machines being used only on lines that operate entirely over land. Even for this purpose, however, aircraft with more than one engine are used whenever possible, and actually no single-engined commercial biplane of any size is at present built in this country. Below is a photograph of a D.H. "Giant Moth," a machine that was very popular a few years ago, and has seen extensive service in various parts of the world. The machine was actually designed for Colonial use, and is equipped with a Bristol "Jupiter 1X" engine developing between 450 and 500 h.p. It has a span of 52 ft. and a folded span of 17 ft. 6 in., and is 38 ft. 10 in. in length. When empty it weighs 3,726 lb. and is 7,000 lb. in weight when fully loaded.

The machine has a maximum speed of 132 m.p.h. and a speed at 5,000 ft. of 127 m.p.h., while at 10,000 ft. this is only reduced to 120 m.p.h. The cruising speed is 110 m.p.h. and the stalling speed 54 m.p.h. It is capable of climbing to an altitude of 5,000 ft. in 6½ min., and has an absolute ceiling of 18,000 ft. and a range of 430 miles.



Parts required to build Model No. S.13

1 of No.	P8	1 of No.	P169
1	P15	1	P171
2	P18	1	P172
2	P24	1	P173
2	P25	1	P175
4	P29	2	P176
2	P44	1	P178
1	P52	1	P179
2	P53	1	P184
1	P54	1	P196
1	P55	1	P198
1	P56	1	P201
1	P58	1	P203
1	P59	1	P208
1	P62	1	P209
1	P151	4	12
1	P152	1	14
1	P155	2	23A
1	P156	47	537A
2	P161	49	537B
1	P164	1	540
1	P165	1	611c
1	P168		

Parts required to build Model No. S.14

1 of No.	P8	1 of No.	P168
2	P18	1	P169
4	P28	1	P170
4	P29	1	P171
2	P44	1	P172
1	P52	1	P173
2	P53	1	P175
1	P54	2	P176
1	P55	1	P178
1	P56	1	P179
1	P58	1	P196
1	P59	1	P198
1	P62	1	P208
2	P100	1	P209
1	P151	4	12
1	P152	1	14
1	P155	2	23A
1	P156	52	537A
2	P162	55	537B
1	P164	1	540
1	P165	1	611c



Model No. S.14 Light Biplane

Machines of the light biplane type have been specialised in by British aircraft designers and British light aeroplanes are the best in the world. The most widely known is the D.H. "Moth," while other very popular two-seaters are the Avro "Avian," the Blackburn "Bluebird," and the Robinson "Redwing."

Light biplanes are intended primarily for pleasure flying and training work at aero clubs, but they are used for many other purposes, some even being adapted for work in air forces. The average span of a light machine is about 30 ft., or approximately half as long as a cricket pitch, and the length is about 24 ft. The D.H. "Gipsy Moth," illustrated below, corresponds almost exactly with these measurements, and it is capable of travelling at a maximum speed of 100 m.p.h. and of cruising for long periods at 95 m.p.h.

Another interesting machine is the Avro "Avian," which is 28 ft. in span and 24 ft. 3 in. in length. It weighs 1,019 lb. when empty and is capable of carrying a disposable load of 563 lb. It has a maximum speed of 108 m.p.h. and cruises and lands at speeds of 96 m.p.h. and 40 m.p.h. respectively. The initial rate of climb on taking off from ground level is 650 ft. per minute.

Many excellent long-distance flights have been made in light biplanes, the first and most famous being the late Mr. Bert Hinkler's flight to Australia in 1927. This was made in an Avro "Avian," and was the first long-distance flight ever to be made in a light aeroplane. Since then many journeys from England to Australia and back have been made in different types of light aeroplanes.





Model No. S.15 Cabin Biplane

The question as to whether biplane design is better than monoplane design will probably never be answered to the satisfaction of everyone. The Blackburn Aeroplane and Motor Co. Ltd., makers of the famous Blackburn "Bluebird" light aeroplane in which the pilot and passenger sit side by side, have recently produced two aeroplanes that are similar in all respects except for the fact that one is a biplane and the other a monoplane. The flying record of each of these machines will be carefully kept, and it should thus be possible for interesting and useful comparisons to be made when the records are available.

The Blackburn Civil Biplane, which is illustrated below, is capable of carrying 10 passengers at a maximum speed of 123 m.p.h. It is provided with two Armstrong Siddeley "Jaguar" engines, each of which develops 400 h.p. The machine is 64 ft. in span and measures 54 ft. 8 in. in overall length and 15 ft. 7 in. in height. When empty it has a weight of 8,100 lb. and when fully loaded this is increased to 12,145 lb. When cruising at sea level and at a speed of 110 m.p.h., the machine has a range of about 350 miles. It lands at 60 m.p.h. and climbs at a speed of 630 ft. per minute immediately on taking off.



Parts required to build Model No. S.15

1 of No.	P8	1 of No.	P165
1	P15	1	P168
2	P18	1	P169
2	P24	1	P171
2	P25	1	P172
4	P28	1	P173
4	P29	1	P175
2	P44	2	P176
1	P52	1	P178
2	P53	1	P179
1	P54	1	P184
1	P55	1	P196
1	P56	1	P198
1	P58	1	P208
1	P59	1	P209
1	P62	4	12
1	P151	1	14
1	P152	2	23A
1	P155	44	537A
1	P156	47	537B
2	P162	1	540
1	P164	1	611c

Parts required to build Model No. S.16

1 of No.	P8	1 of No.	P168
1	P15	1	P169
2	P18	1	P171
2	P29	1	P172
2	P31	1	P173
2	P44	1	P175
2	P52	2	P176
2	P53	1	P178
1	P54	1	P179
1	P55	1	P195
1	P56	1	P198
1	P58	1	P201
1	P59	1	P203
1	P62	1	P208
1	P100	1	P209
2	P101	1	14
2	P102	2	23A
1	P151	39	537A
1	P152	43	537B
1	P164	1	540
1	P165	1	611c



Model No. S.16 Light Parasol Monoplane

Light parasol monoplanes fall into the category of high wing machines but, as their name implies, the wing is held above the fuselage like a parasol, instead of being fixed to the upper longerons. The type is not particularly popular, especially in England.

One of the most interesting parasol monoplanes produced is the Parnall "Parasol" research machine. This was built by George Parnall and Co. Ltd., for the Air Ministry, by whom it is used for experimental and research work in connection with the effect of different types of wings upon the control of a machine. For this purpose it is arranged so that wings with different aerofoil sections can be employed on it, dynamometers being provided to enable the lift and drag of the plane to be accurately measured.

The "Parasol" is equipped with an Armstrong Siddeley "Lynx" engine that develops 226 h.p. at an altitude of 14,430 ft. This is of the supercharged type in order to give the machine a fast rate of climb

so that it may quickly reach an altitude of 8,000 ft., at which height it is recommended that the aeroplane be operated while tests are being carried out. At sea level the maximum speed is 110 m.p.h. and the stalling speed 50 m.p.h.

Another interesting parasol machine is the Westland "Widgeon." This is not now in regular production, but many "Widgeons" are still in use, and a photograph of one appears on the left.



Model No. S.17 Low Wing Cabin Monoplane

Several low wing cabin monoplanes have been built in this country during recent years, but most of them have had accommodation for only a few passengers. For instance, the Percival "Gull" is a three-seater machine, while the Spartan "Cruiser" has enclosed accommodation for six. Low wing monoplanes are very popular on the Continent, and many larger machines of this type have been built in Germany and France. We accompany this model with a photograph of the Junkers F-24K built in Germany. This is a low wing commercial monoplane with a cabin to hold nine passengers. An interesting feature of the machine is that it is equipped with an engine of the Junkers "Jumo 4" type, which is a water-cooled heavy oil engine that develops between 600 and 720 h.p. The F-24K, shown on the left, is 80 ft. 6 in. in span and 50 ft. in length. It has a maximum speed of 122 m.p.h., and cruises at 102.5 m.p.h. The initial rate of climb is 735ft. per min. and the machine takes 20.5 min. to climb to 9,840ft. The absolute ceiling, or the greatest height it can reach, is 19,680ft.,

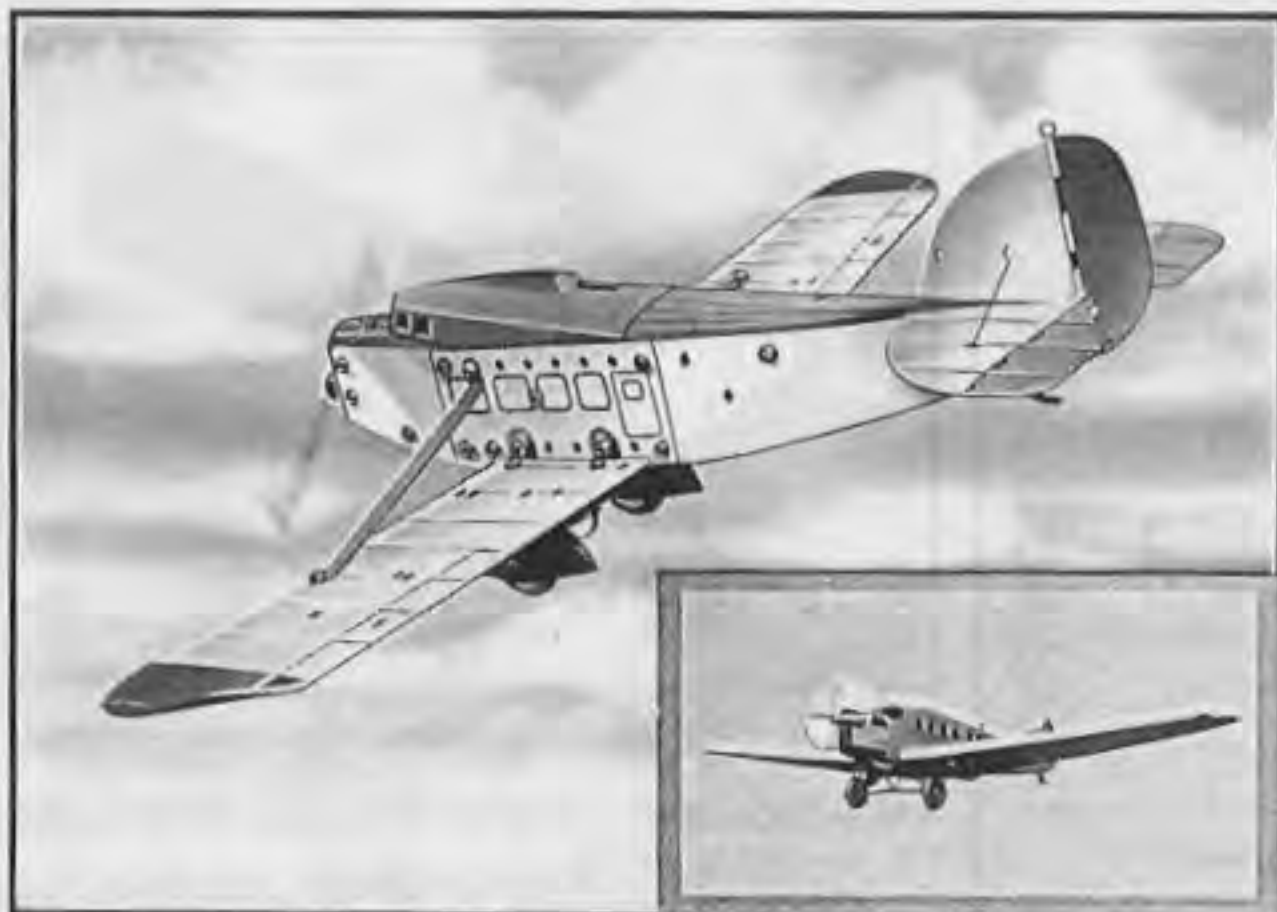

Parts required :

1 of No. P15	1 of No. P59	1 of No. P173	4 of No. 12
2 " " P18	1 " " P62	1 " " P175	1 " " 14
2 " " P31	1 " " P151	2 " " P176	2 " " 23A
2 " " P44	1 " " P152	1 " " P178	34 " " 537A
1 " " P52	1 " " P164	1 " " P179	37 " " 537B
2 " " P53	1 " " P165	1 " " P184	1 " " 540
1 " " P54	1 " " P168	1 " " P196	1 " " 611c
1 " " P55	1 " " P169	1 " " P198	
1 " " P56	1 " " P171	1 " " P208	
1 " " P58	1 " " P172	1 " " P209	

Model No. S.18 Commercial High Wing Monoplane

High wing monoplanes have become very popular in recent years, and this type of machine is now to be seen all over the world. Many interesting examples are built in this country, ranging from small light single-seater machines such as the Comper "Swift," to powerful single-engined aeroplanes like the Fairey Long Range Monoplane, and big multi-engined air liners, of which the Armstrong Whitworth "Atalantas" are the latest examples. The photograph on the right of this page shows the Vickers "Viasra." This machine is interesting because of the fact that it can be obtained in one, two or three-engined versions, and also because the Prince of Wales has recently bought one for his personal use. The machine is of the two-engined type, and is fitted with two Bristol "Pegasus" engines similar to those used in the Vickers "Vespa" when the world's altitude record was set up in 1932. It is fitted out very luxuriously, and has a cruising speed of 130 h.p. Its identification letters are G—ACCC.

Parts required :

1 of No. P15	1 of No. P59	1 of No. P173	1 of No. P208
2 " " P18	1 " " P62	1 " " P175	1 " " P209
2 " " P31	1 " " P151	2 " " P176	4 " " 12
2 " " P44	1 " " P152	1 " " P178	1 " " 14
1 " " P52	1 " " P164	1 " " P179	2 " " 23A
2 " " P53	1 " " P165	1 " " P184	37 " " 537A
1 " " P54	1 " " P168	1 " " P196	39 " " 537B
1 " " P55	1 " " P169	1 " " P198	1 " " 540
1 " " P56	1 " " P171	1 " " P201	1 " " 611c
1 " " P58	1 " " P172	1 " " P203	

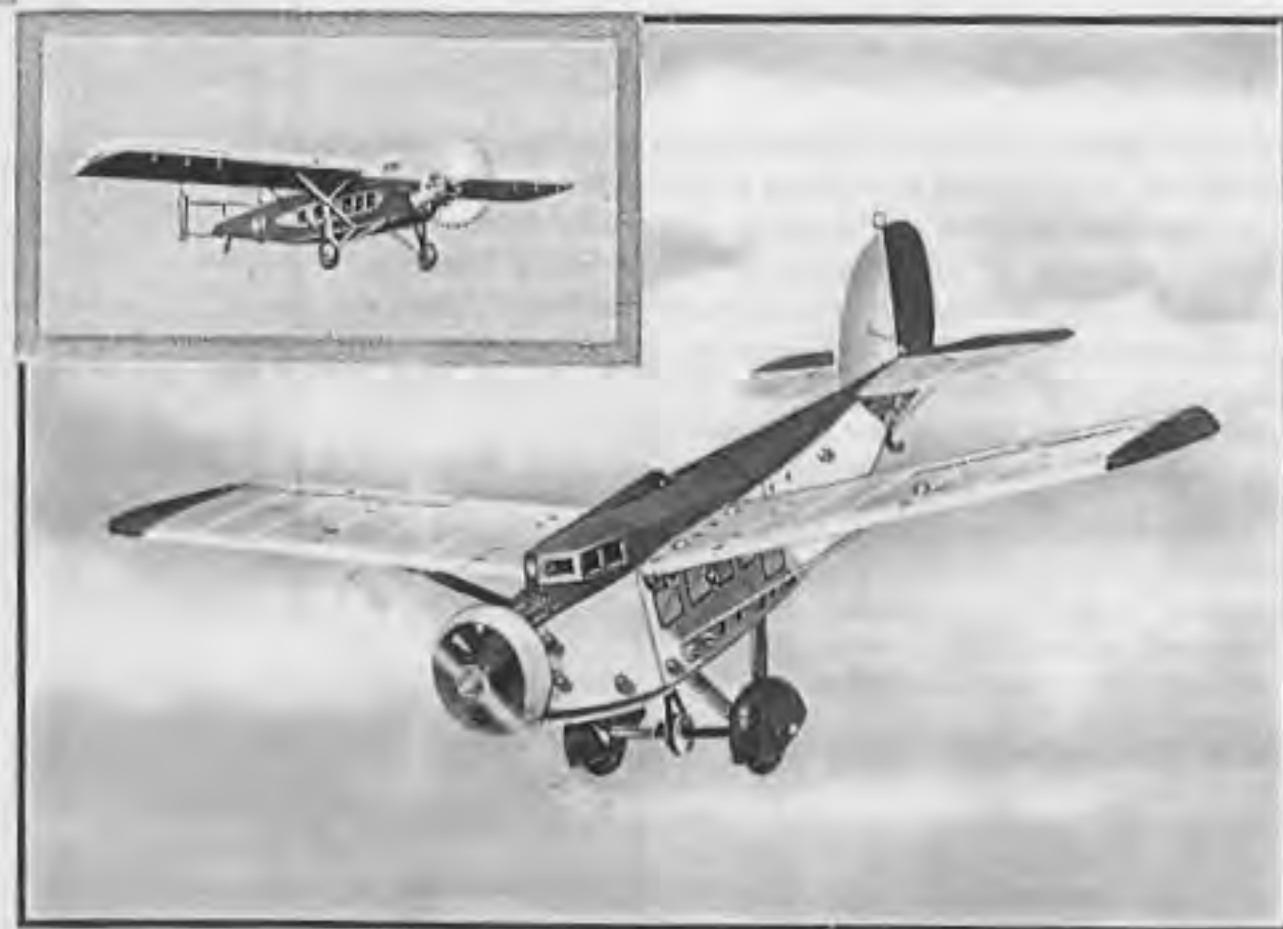

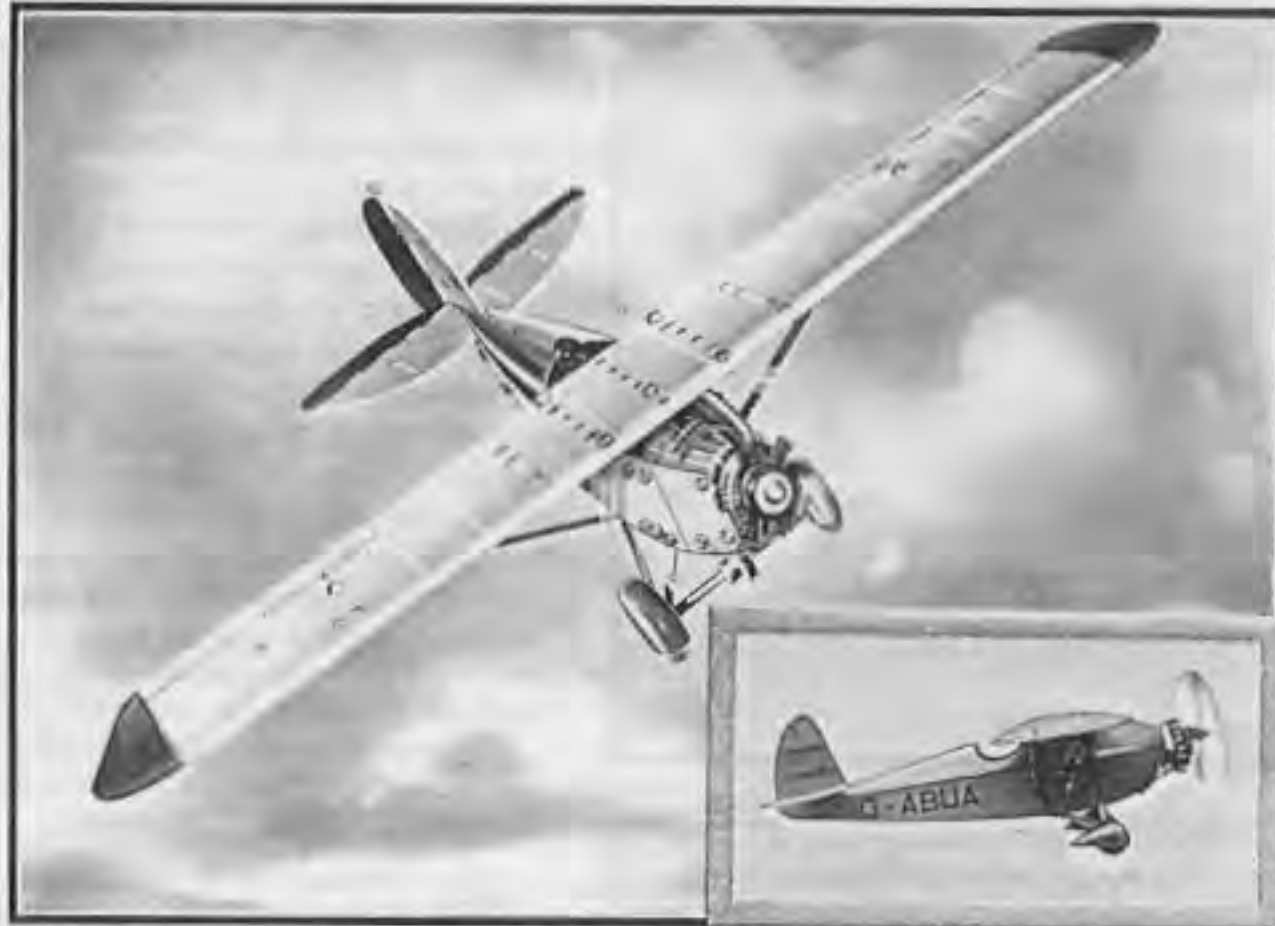

Model No. S.19 Single-Seater High Wing Monoplane

Many people think that light single-seater high wing monoplanes are only suitable for short cross-country flights and comparatively short racing events. This is not so, however, for while these machines are very economical in operation, they are also very reliable, an instance of this being the fact that an excellent flight from England to Australia was made in the machine we show, the Comper "Swift" light single-seater monoplane. The pilot of the machine was Mr. C. A. Butler. A "Swift" also secured second place in the King's Cup Air Race in 1932 with an average speed of 155.75 m.p.h. The "Swift" is claimed to be both the smallest and the fastest standard light aeroplane in the world. It is only 24 ft. in wing span, and it can be folded to a width of 8ft. 1 1/2 in. for garaging. Its maximum speed is 165 m.p.h. when fitted with a D.H. "Gipsy III" engine. The cruising speed is between 135 and 140 m.p.h., and the landing speed 50 m.p.h. The standard model, a photograph of which is on the left, employs a "Pobjoy R" engine which has a rated output of 75 b.h.p. at 3,000 r.p.m. With this engine the maximum speed is 130 m.p.h., the cruising speed 120 m.p.h., and the landing speed 40 m.p.h.

Parts required :

1 of No. P8	1 of No. P58	1 of No. P171	1 of No. P208
1 " " P15	1 " " P59	1 " " P172	1 " " P209
2 " " P18	1 " " P62	1 " " P173	1 " " 14
2 " " P31	1 " " P100	1 " " P175	2 " " 23A
2 " " P44	1 " " P151	2 " " P176	35 " " 537A
1 " " P52	1 " " P152	1 " " P178	37 " " 537B
2 " " P53	1 " " P164	1 " " P179	1 " " 611C
1 " " P54	1 " " P165	1 " " P196	
1 " " P55	1 " " P168	1 " " P198	
1 " " P56	1 " " P169	1 " " P203	

Model No. S.20 High Wing Cabin Monoplane

This model is another example of the popular high wing cabin monoplane. It represents a fairly large commercial cabin machine of the single-engined type, such as the French Latécoère 28-1, an illustration of which is given on the right of this article. These machines are used for a variety of purposes, but particularly for the transport of mails and for passenger air traffic work. This Latécoère machine is 60 ft. in span and 44 ft. 3 in. in length, and it has a maximum speed of 149 m.p.h., and a cruising speed of 133.5 m.p.h. A 500 or 650 h.p. Hispano-Suiza 12-cylinder engine is usually employed in it.

The Latécoère machine is available in both land and sea forms and it holds 19 world's records, 14 of which were gained by the seaplane version and the remaining five when the aeroplane was fitted with a wheeled undercarriage. A Latécoère 28 machine also made the first commercial crossing of the South Atlantic. This was in May, 1930, and was in connection with the Compagnie Générale Aéropostale mail service between France and South America. This is the longest air line in the world.

Parts required :

1 of No. P15	1 of No. P59	1 of No. P173	4 of No. 12
2 " " P18	1 " " P62	1 " " P175	1 " " 14
2 " " P31	1 " " P151	2 " " P176	2 " " 23A
2 " " P44	1 " " P152	1 " " P178	38 " " 537A
1 " " P52	1 " " P164	1 " " P179	39 " " 537B
2 " " P53	1 " " P165	1 " " P184	1 " " 540
1 " " P54	1 " " P168	1 " " P196	1 " " 611C
1 " " P55	1 " " P169	1 " " P198	
1 " " P56	1 " " P171	1 " " P208	
1 " " P58	1 " " P172	1 " " P209	

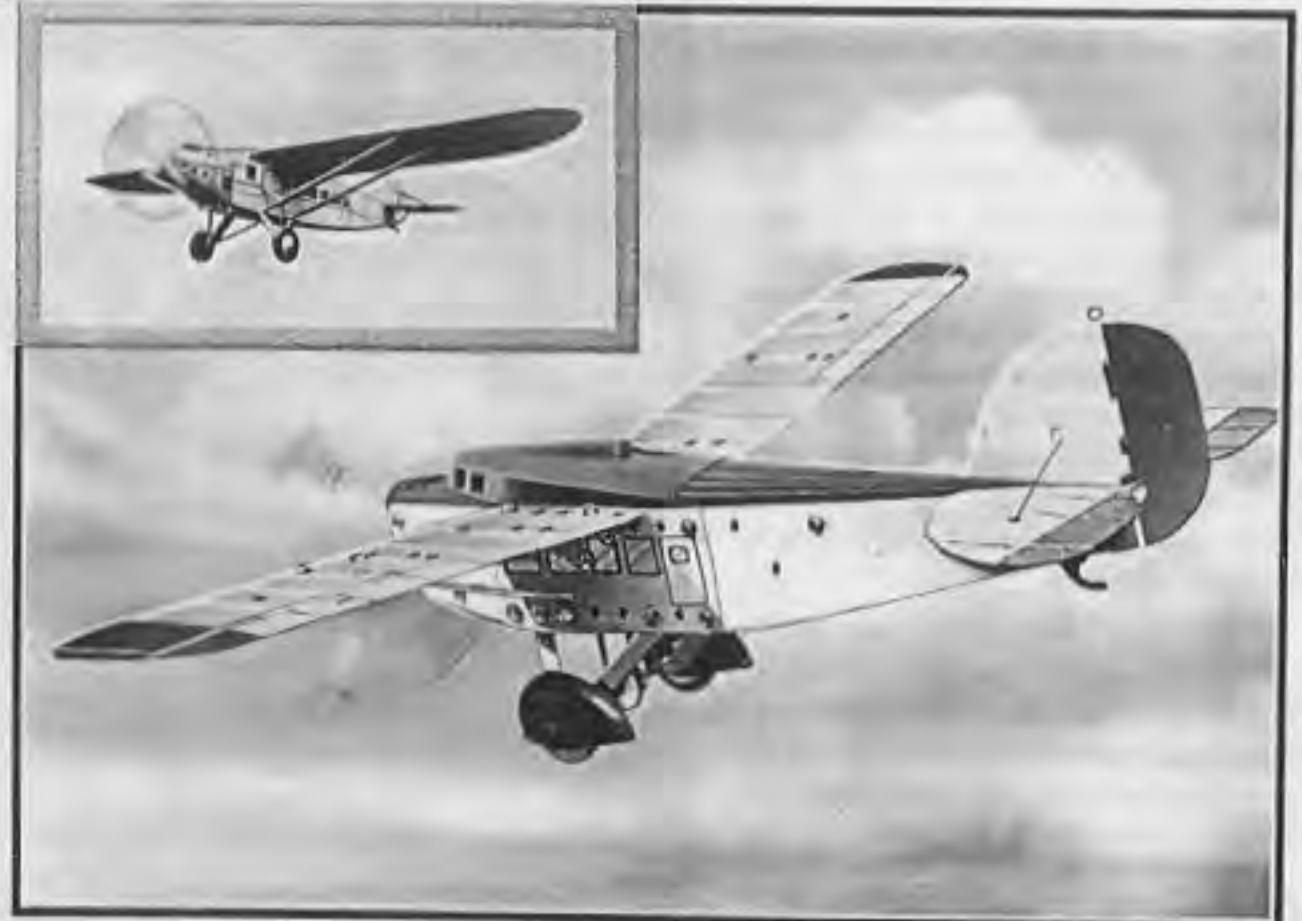



Model No. S.21
Air Liner

Parts required:			
1 of No.	P7	2 of No.	P162
20 "	P8	1 "	P164
1 "	P14	1 "	P165
1 "	P15	1 "	P168
2 "	P18	1 "	P169
4 "	P28	1 "	P171
4 "	P30	1 "	P172
2 "	P44	1 "	P173
2 "	P53	1 "	P174
1 "	P55	1 "	P175
1 "	P58	2 "	P176
1 "	P59	1 "	P177
1 "	P60	1 "	P178
1 "	P151	2 "	P179
1 "	P152	1 "	P181
1 "	P155	4 "	P187
1 "	P156	1 "	P199
10 "		10 "	P201
10 "		10 "	P202
10 "		10 "	P203
10 "		10 "	P207
1 "		1 "	P208
1 "		1 "	P209
2 "		2 "	P210
2 "		2 "	P211
2 "		2 "	P212
4 "		4 "	12
66 "		66 "	537A
63 "		63 "	537B
1 "		1 "	549
1 "		1 "	611c

This model is similar to the Airspeed "Ferry," a photograph of which appears above, except that it is a twin-engined machine while the "Ferry" is equipped with three engines. A unique feature of the "Ferry" is the disposition of its engines, for these are not arranged in the normal manner, that is, one in the nose and the other two on each side of the fuselage in the gap between the wings. Instead, one is mounted on the top wing directly above the fuselage, and the other two are on the lower wing. This enables the engines, and particularly the centre one, to work more efficiently.

The "Ferry" has been designed mainly for joy-riding, and for use on "feeder" air lines where the volume of traffic is not great. It has a maximum speed of 108 m.p.h. at sea level and cruises at between 85 and 90 m.p.h. The stalling speed is 49 m.p.h., and in still air the machine requires a run of about 200 yds. in order to take off.



Model No. S.22 Single-Float Amphibian

Most of the float seaplanes seen in England are provided with twin duralumin floats, but there is also a single-float type, such as the Short "Mussel" illustrated below. In this the float is really an amphibian under-carriage made of duralumin and secured below the fuselage by thin tubular struts, all the fittings and wiring lugs for the cross bracing being of stainless steel in order to prevent corrosion. The landing wheels are carried on special rubber-sprung legs mounted on an axle that rotates in bearings fitted inside the main float, and arranged so that they can be raised or lowered from the pilot's seat. A small water rudder is provided at the rear of the float connected to the rudder bar, so that it is operated automatically by the pilot. It serves as a steering tailskid when the machine is on land.

The "Mussel" is the only machine of its type in England, and is about 37 ft. 4 in. in span and 25 ft. in length. It can be equipped with either a Cirrus or a D.H. "Gipsy" engine and it has a maximum speed of 102 m.p.h., and a landing speed of 48 m.p.h. Its range is four hours.

Parts required:			
2 of No.	P8	1 of No.	P164
20 "	P15	1 "	P165
6 "	P30	1 "	P168
2 "	P31	1 "	P169
1 "	P42	1 "	P170
2 "	P44	1 "	P171
1 "	P52	1 "	P172
20 "	P53	1 "	P175
1 "	P55	2 "	P176
1 "	P60	1 "	P178
2 "	P100	1 "	P179
1 "	P151	2 "	P187
1 "	P152	1 "	P199
10 "		10 "	P205
10 "		10 "	P206
10 "		10 "	P207
1 "		1 "	P208
1 "		1 "	P209
4 "		4 "	12
1 "		1 "	13
57 "		57 "	537A
53 "		53 "	537B
3 "		3 "	611c





Model No. S.24 Light Fighter

The light fighter differs from the ordinary single-seater fighter in being less heavy and carrying less military equipment. It is an admirable machine for training single-seated fighter pilots, as the engine employed does not need to be so powerful as that used in the standard fighter, and is thus more economical. One of the most interesting light fighters produced is the Blackburn "Lincoln" shown below. This is single-bay staggered biplane built on somewhat similar lines to the Blackburn "Bluebird," particularly in regard to the wings, which are of all-metal construction and have spars and ribs of the same type as the "Bluebird." In order to increase the manoeuvrability of the machine, ailerons are fitted on all four planes, whereas in light civil machines, such as the D.H. "Moth," ailerons are usually fitted only on the upper or lower planes. The fuselage is of all-metal construction, although parts at the rear are covered with fabric.

When employing a "Lynx-Major" engine that develops 250 h.p., the machine has a speed of 162 m.p.h. at an altitude of 3,000 ft., and this only drops to 156 m.p.h. when it climbs to 10,000 ft. The machine lands at 60 m.p.h. and has a service ceiling of 20,000 ft. It measures 24 ft. 6 in. in span and 19 ft. 6 in. in length.

Parts required:			
1 of No.	P8	1 of No.	P100
1	P4	1	P171
1	P8	1	P172
1	P15	1	P173
1	P18	1	P175
1	P20	2	P176
4	P30	1	P178
1	P44	1	P179
1	P52	1	P184
1	P53	2	P187
1	P60	1	P190
1	P151	2	P199
1	P152	2	P201
1		2	P202
1		2	P203
1		1	P208
1		1	P209
1		2	P210
1		2	P211
1		2	P212
1		8	38
1		44	537A
1		39	537B
1		3	611c

Model No. S.23 Tail-First Machine

Tail-first machines, sometimes known as "duck"-type aeroplanes, fly with the small tailplane in front and the large main plane at the rear, and thus when in the air they seem to be flying backward. Their most important feature is that the design makes it impossible to get into a spin or a nose dive. This is due to the small plane carrying the elevators that is fitted in front and is set at an angle to the main wing so that when the machine is climbing, the small front wing reaches the stalling point earlier than the main wing. It then loses all its lift and consequently all its powers as an elevator, making it impossible for the nose to be raised higher, and thus preventing the stall.

The most outstanding work in the development of this type has been carried out by the German firm of Focke-Wulf Flugzeugbau, and the latest tail-first machine produced by the company is the "Ente," shown above. This is a twin-engined commercial monoplane that has an overall length of about 34 ft. 6 in. and an overall span of 32 ft. 10 in. Its maximum speed is 88 m.p.h. and it cruises at 80 m.p.h. and lands at 52 m.p.h. The engines employed are of the Siemens and Halske S.H. 14 type, each developing 110 h.p., and they are carried in nacelles on each side of the fuselage.



Parts required:			
1 of No.	P8	1 of No.	P162
1	P4	1	P164
1	P8	1	P165
1	P18	1	P168
1	P20	1	P169
1	P44	1	P170
1	P52	1	P171
1	P53	1	P172
1	P55	1	P173
1	P58	1	P175
1	P59	2	P176
1	P62	1	P178
1	P100	1	P179
1	P101	2	P187
1	P151	1	P188
2		2	P180
2		2	P181
1		1	P195
1		1	P198
1		1	P201
1		1	P202
1		1	P208
1		1	P209
1		2	12
1		1	16A
1		43	537A
1		43	537B
1		1	540
1		1	611c





Model No. S.25 Twin-Engine Light Low Wing Monoplane

The low wing cabin type of aeroplane is becoming increasingly popular in this country. The twin-engine type is to be preferred to the single-engine type, for there is less danger of a forced landing being caused by engine failure.

One of the most interesting modern British aeroplanes is the General "Monospar" shown on the right, which is a twin-engine light low wing cabin monoplane, provided with a wing built up on what is known as the "Monospar" system of wing construction. This is exceptionally strong and also enables a great saving in weight to be made.

The latest model of the "Monospar" has a span of 40 ft. 2 in. and is 26 ft. 4 in. in length. The machine has a maximum speed at sea level of 132 m.p.h. and a cruising speed of between 112 and 115 m.p.h.



Parts required:

No.	of	No.	Part	No.	Part	No.	of	No.	Part
1	"	P14	1	"	P165	20	"	"	P201
1	"	P15	1	"	P168	20	"	"	P202
1	"	P16	1	"	P169	20	"	"	P203
1	"	P17	1	"	P171	20	"	"	P207
1	"	P18	1	"	P172	20	"	"	P208
1	"	P19	1	"	P173	20	"	"	P209
1	"	P20	1	"	P175	20	"	"	P210
1	"	P21	2	"	P176	20	"	"	P211
1	"	P22	1	"	P178	20	"	"	P212
1	"	P23	1	"	P179	4	"	"	12
1	"	P24	1	"	P184	38	"	"	537A
1	"	P25	1	"	P196	35	"	"	537B
1	"	P26	2	"	P199	1	"	"	611C
1	"	P27							

Model No. S.26 Twin-Engine Passenger Biplane

Twin-engine biplanes are really suitable for use only on air lines on which it is not necessary to make crossings of wide stretches of water, because if one of the engines breaks down, the work of the other one is greatly increased and consequently this may fail also. A forced landing with a large machine may be very difficult when the aeroplane is travelling over land, but when flying over water the results are almost certain to be serious unless there are ships in the neighbourhood. It is for this reason that only three- or four-engine aeroplanes are used by Imperial Airways for the operation of their cross-Channel service. Actually narrow stretches of water can be flown by twin or single-engine machines for they are made to climb so high that in the event of engine trouble they can glide to land without any danger of having to descend upon the water.

An interesting twin-engine passenger biplane is the Blackburn Civil Biplane, which is illustrated on the left. This, as mentioned on page 13, has been designed to the order of the Air Ministry for use as an experimental machine.

Parts required:					
1 of No.	P17	1 of No.	P152	1 of No.	P181
2 "	P18	1 "	P155	4 "	P187
1 "	P14	1 "	P156	1 "	P190
1 "	P15	2 "	P162	1 "	P199
2 "	P18	1 "	P164	2 "	P202
4 "	P28	1 "	P165	2 "	P205
4 "	P29	1 "	P168	2 "	P206
2 "	P44	1 "	P169	2 "	P207
1 "	P52	1 "	P171	1 "	P208
2 "	P53	1 "	P172	1 "	P209
1 "	P54	1 "	P173	4 "	12
1 "	P55	1 "	P174	2 "	23A
1 "	P56	1 "	P175	76 "	537A
1 "	P58	2 "	P176	75 "	537B
1 "	P59	1 "	P177	1 "	540
1 "	P62	1 "	P178	3 "	611C
1 "	P151	2 "	P179		

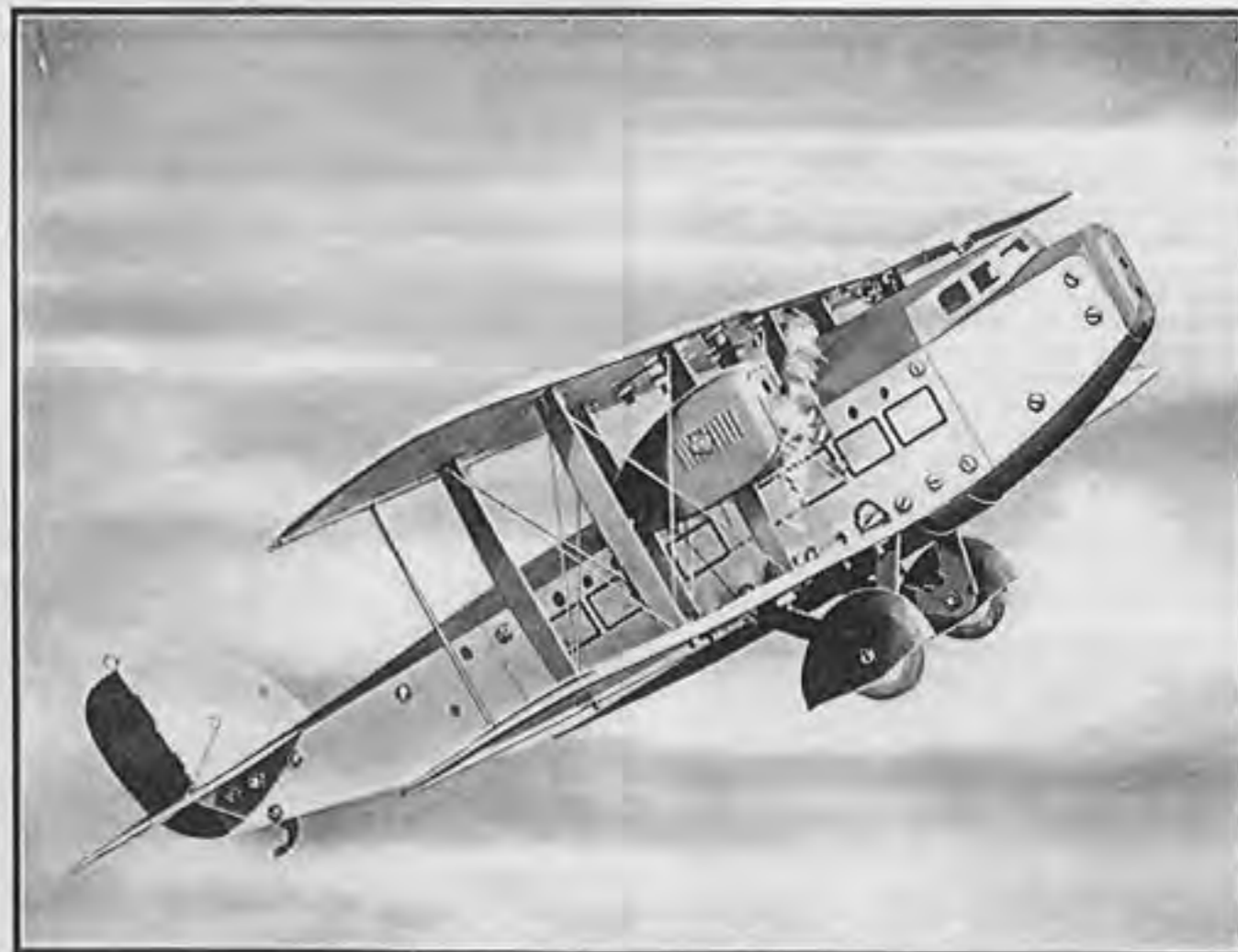

Model No. S.27 Racing Monoplane



Parts required:		
2 of No. P14	1 of No. P165	1 of No. P198
2 " " P44	1 " " P168	1 " " P201
1 " " P52	1 " " P169	1 " " P203
2 " " P53	1 " " P170	1 " " P208
1 " " P55	1 " " P171	1 " " P209
1 " " P58	1 " " P172	4 " " 12
1 " " P59	1 " " P173	1 " " 36A
2 " " P60	1 " " P175	20 " " 537A
1 " " P100	2 " " P176	31 " " 537B
1 " " P161	1 " " P178	1 " " 540
1 " " P172	1 " " P179	1 " " 611c
1 " " P164	1 " " P199	

Low wing monoplanes appear to have become definitely the machines for speed. The Vickers-Supermarine Rolls-Royce seaplanes that were built for the Schneider Trophy race in 1931, and the Italian machine that gained from England the world's speed record, were of this type, while the world's speed record for landplanes is also held by a low wing monoplane, the Gee-Bee "Super-Sportster." As will be seen from the photograph on the left the "Super-Sportster" is a very remarkable looking machine, for it is very fat and short, the pilot being accommodated in a cockpit right at the rear. The pilot's seat has been placed in this position in order to offset the weight of the huge Pratt & Whitney "Wasp" supercharged engine, which develops about 800 h.p. at 2,350 r.p.m.

The world's speed record for landplanes was put up at Cleveland on 3rd September 1932, by Mr. James Doolittle,

the well-known American pilot, who flew at a speed of 294.2 m.p.h. The Gee-Bee "Super-Sportster" is 25 ft. in span and 17ft. 9in. in length.

There is a less powerful version of the Gee-Bee "Super-Sportster," and this measures 23 ft. 6 in. in span and 15 ft. 1 in. in length. It has a maximum speed of 270 m.p.h. and is capable of cruising at 230 m.p.h. The landing speed is 80 m.p.h.



Model No. S.28 Single-Engined Commercial Biplane

An interesting feature of the D.H. "Fox Moth," illustrated below, is that the pilot is accommodated in a cockpit behind and above the cabin for the passengers. The aeroplane was produced primarily as a "family conveyance," and another important feature is that as it is composed for the most part of units that are used in other machines in the de Havilland range, no difficulty should be experienced in obtaining spares in any part of the world. The wings of the machine are those designed for use on the "Tiger Moth"; the tail unit or empennage is made up of parts from the "Puss Moth" and the "Gipsy Moth"; and the nose is similar to that used on the "Puss Moth."

The machine is a three or four-seater and may be equipped with either one 120 h.p. "Gipsy 111" engine or one "Gipsy Major" engine developing 135 h.p. It measures 30 ft. 10½ in. in span but when the wings are folded back the overall width is only 9 ft. 10½ in. When equipped with a "Gipsy Major" engine the maximum speed at sea level is 111.5 m.p.h.

Parts required:		
1 of No. P7	1 of No. P162	1 of No. P177
1 " " P8	1 " " P155	1 " " P178
1 " " P11	1 " " P156	2 " " P179
1 " " P18	2 " " P162	4 " " P187
4 " " P29	1 " " P161	1 " " P196
1 " " P41	1 " " P165	1 " " P198
1 " " P52	1 " " P168	1 " " P208
10 " " P53	1 " " P169	1 " " P209
1 " " P55	1 " " P170	4 " " 12
1 " " P56	1 " " P171	1 " " 14
1 " " P58	1 " " P172	70 " " 537A
1 " " P59	1 " " P173	73 " " 537B
10 " " P60	1 " " P174	1 " " 540
1 " " P100	1 " " P175	1 " " 611c
1 " " P151	2 " " P176	



Model No. S.29 Pusher-Engined Monoplane Amphibian



Parts required:

1 of No. P8	1 of No. P165	1 of No. P202
1 " " P15	1 " " P160	1 " " P203
2 " " P18	1 " " P171	1 " " P207
3 " " P20	1 " " P172	1 " " P208
4 " " P30	1 " " P173	1 " " P209
2 " " P31	1 " " P175	1 " " P210
2 " " P44	2 " " P176	1 " " P211
2 " " P53	1 " " P178	1 " " P212
1 " " P55	1 " " P179	6 " " 38
2 " " P60	1 " " P184	44 " " 537A
1 " " P151	1 " " P190	42 " " 537B
1 " " P152	1 " " P199	1 " " 611c
1 " " P164	1 " " P201	

Small single-engined flying boats and amphibians are not very popular in this country, although several are constructed abroad. One of the pioneer firms for machines of this type is the French company known as Hydravions Shreck F.B.A. This firm was making flying boats before the Great War, and although other types were constructed during the War, on its termination flying boats were again built and now a long series has been produced.

Most of the flying boats constructed have been of the single-engined* type, an interesting example of which is the F.B.A. 310, the latest product of the firm, which is illustrated on the left of the inset. This light amphibian is a high wing braced monoplane, almost entirely of wood construction, that has accommodation for two in a totally enclosed cabin and is provided with a retractable undercarriage that can be operated from the pilot's seat. If the boat is used without the amphibian gear it can be made into a three-seater. It has a maximum speed of 93.15 m.p.h., and is capable of climbing to an altitude of about 9,840 ft. in 28 min. 40 sec. The boat is nearly 39 ft. in length, and in the amphibian type weighs 1,430 lb. when empty, and 1,980 lb. fully loaded. A Lorraine air-cooled radial engine developing 120 h.p. is employed in the amphibian, and is carried in a nacelle mounted above the wing. It drives a pusher airscrew. The petrol is carried in the hull.



Model No. S.30 Training Biplane

Machines used for elementary flying training are nearly always of the biplane type, as these are more stable than monoplanes, and therefore are usually easier to fly. The most famous training machine is the Avro 504K. The first edition of this appeared early in 1913, and the many types that have followed are only modified and slightly improved in various ways, all the essential aerodynamic features being maintained. Even the main dimensions of the original machine are still adhered to in the standard Avro trainer. It is claimed that more pilots have been trained on Avro 504's than on any other type of aeroplane, and it is interesting to note that the latest instructional aircraft used in the R.A.F. are Avro machines.

A training machine must possess certain definite qualities. It must, for instance, be easy to fly, and yet must not be too stable, or the student will not develop a sufficiently sensitive touch for more delicate types such as high speed single-seater fighters. The machine must not possess any "vicious" characteristics, as these would be particularly dangerous during the first few solo flights made by a pupil, when he is apt to be extremely nervous and not to fly as well as he is really able. The trainer shown on the right of the inset is the de Havilland "Tiger Moth." The machine is equipped with a D.H. "Gipsy Major" engine and has a maximum speed of 109 m.p.h.

Parts required:

1 of No. P3	2 of No. P102	2 of No. P185
1 " " P4	1 " " P131	2 " " P186
1 " " P8	1 " " P162	1 " " P195
2 " " P18	1 " " P161	1 " " P198
4 " " P29	1 " " P163	1 " " P201
2 " " P44	1 " " P168	1 " " P203
1 " " P52	1 " " P169	1 " " P208
2 " " P53	1 " " P170	1 " " P209
1 " " P54	1 " " P171	4 " " 12
1 " " P55	1 " " P172	1 " " 14
1 " " P56	1 " " P173	2 " " 33A
1 " " P58	1 " " P175	53 " " 537A
1 " " P59	2 " " P176	55 " " 537B
1 " " P62	1 " " P178	1 " " 549
2 " " P100	1 " " P179	1 " " 611c
2 " " P101		

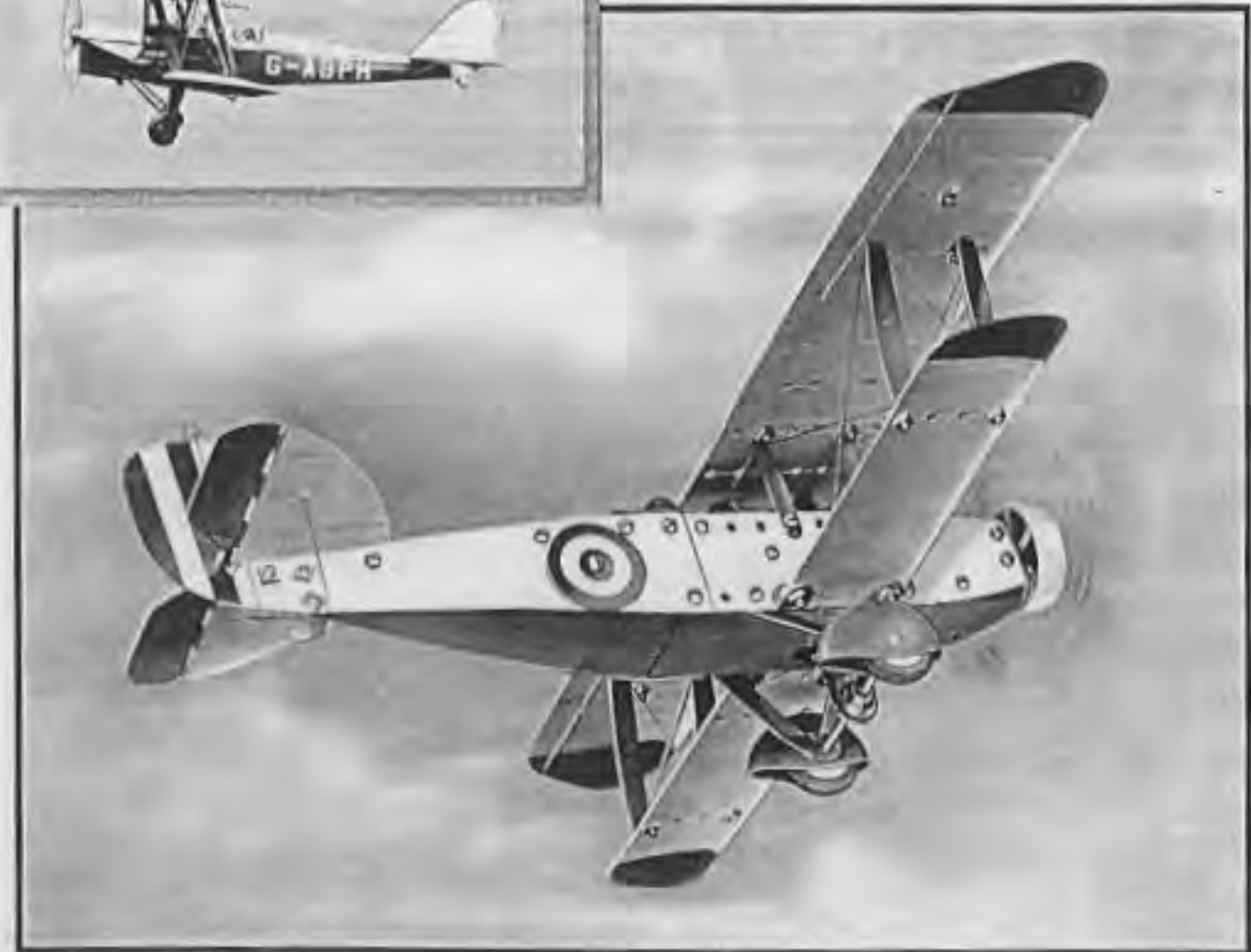

Model No. S.31 Torpedoplane

Aeroplanes intended to carry torpedoes may be fitted with undercarriages of either the wheel or the float type. Their duty is to travel on aircraft carriers or other vessels of the Fleet, and to attack enemy shipping with torpedoes.

One of the latest aeroplanes in use in the R.A.F. for this purpose is the Vickers "Vildebeest" illustrated on the right of the inset. This is a single-engined biplane of all-metal construction, with wings equal in span and unstaggered. The undercarriage is of the divided type, a very necessary feature, as any axles or cross bracing would prevent the torpedo that is carried immediately below the fuselage from dropping straight down into the water.

The machine is equipped with a 550 h.p. Bristol "Pegasus" radial air-cooled engine, although a 595 h.p. Hispano-Suiza 12 Lbr. water-cooled engine may be employed if desired. The "Vildebeest" has a span of 49 ft. and is 36 ft. 8 in. in length. The seaplane version illustrated has a speed of 132.5 m.p.h. at ground level and is capable of travelling at 107 m.p.h. at 9,840 ft. The absolute ceiling is 11,000 ft., the cruising range at 4,000 ft. is 600 miles, and the landing speed 59.5 m.p.h. When equipped with a land undercarriage the "Vildebeest" has a speed at ground level of 136.5 m.p.h. and of 120 m.p.h. at 9,840 ft. The landing speed is 58 m.p.h.

Machines of the "Vildebeest" type are used in the Royal Air Force and by the Spanish Ministry of Marine.

Parts required:			
1 of No.	P7	2 of No. P101	1 of No. P150
2 "	P8	1 " "	P104
2 "	P18	1 " "	P105
2 "	P20	1 " "	P108
4 "	P30	1 " "	P109
2 "	P42	1 " "	P170
1 "	P52	1 " "	P171
1 "	P58	1 " "	P172
2 "	P100	1 " "	P173
2 "	P101	1 " "	P175
2 "	P102	2 "	P176
1 "	P151	1 "	P178
1 "	P152	1 "	P179
1 "	P165	4 "	P187
1 "	P150	1 "	P188
4 "			P190
4 "			P191
1 "			P195
1 "			P198
1 "			P201
1 "			P203
1 "			P208
1 "			P209
			12
			14
		80 "	537A
		75 "	537B
		1 "	540
		1 "	611c

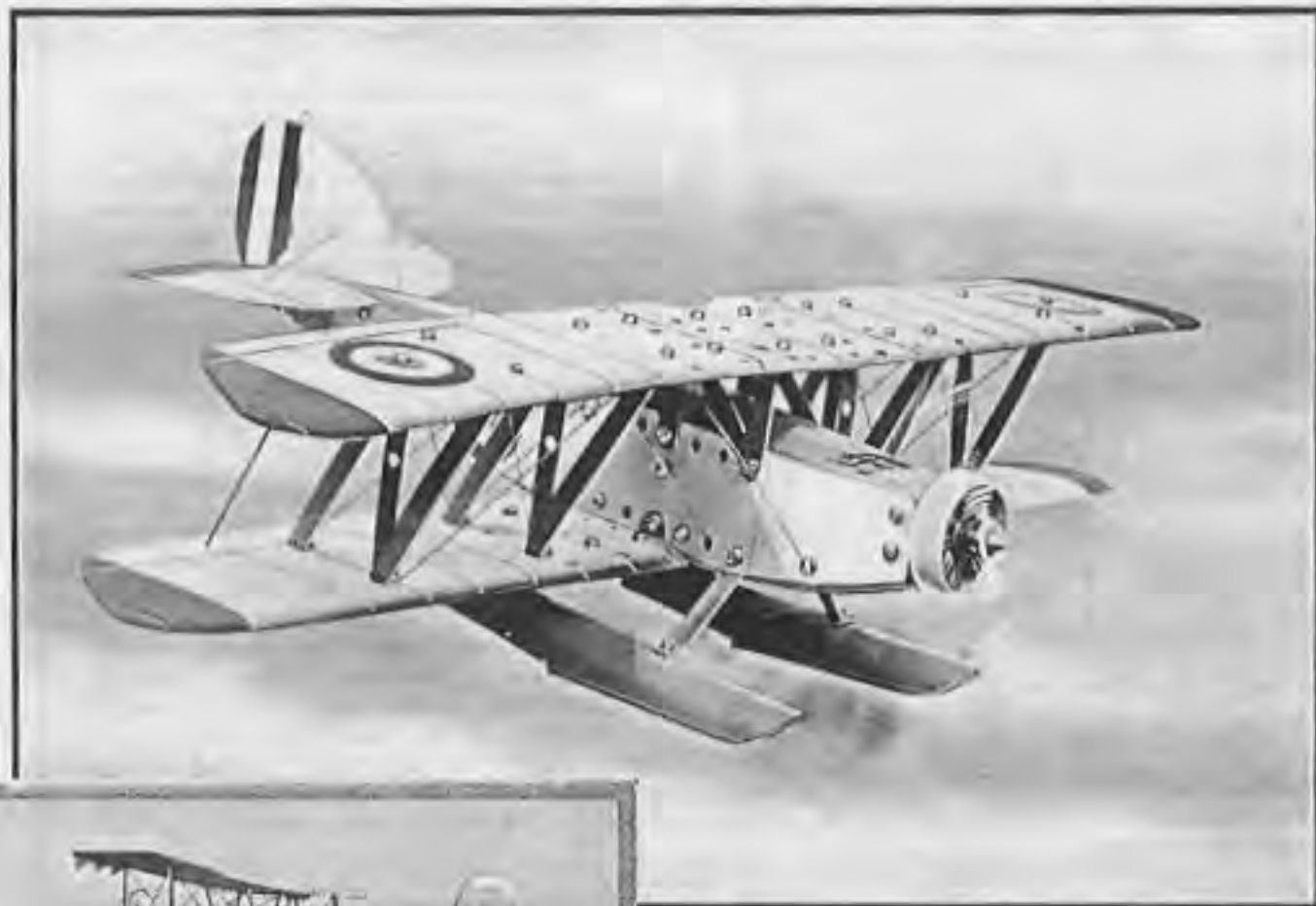

Model No. S.32 Breguet Sesquiplane

Apart from such machines as the Cierva "Autogiro" and various "Pterodactyl" types, most aeroplanes are very similar in general external appearance. An interesting type that has been designed by the French Breguet Company, however, differs from other aircraft by the fact that the fuselage stops short at a point about three-quarters of the total length of the machine, a metal girder then protruding from the bottom to carry the tail unit. This type of construction has been evolved in an endeavour to reduce the drag, or resistance of the machine, by eliminating all external wires, and as far as possible, all struts. It is particularly suitable for military aircraft as it gives the occupant of the rear cockpit an excellent view.

Three machines are now built on this principle. They are of all-metal construction, hollow rivets being used to join the sheets together instead of welding or nuts and bolts, and one of them, a twin-engined multi-seater fighter, is illustrated on the left of the inset. When equipped with two 650 h.p. Hispano Suiza engines this machine has an empty weight of 7,230 lb. and a loaded weight of 12,760 lb. The speed at 4,920 ft. is about 170.7 m.p.h. and this increases to about 208 m.p.h. at an altitude of 14,760 ft.

Parts required:			
1 of No.	P3	2 of No. P102	1 of No. P184
1 "	P4	1 " "	P188
1 "	P7	1 " "	P189
2 "	P8	1 " "	P192
1 "	P14	1 " "	P193
2 "	P18	1 " "	P195
1 "	P26	1 " "	P199
1 "	P27	1 " "	P202
2 "	P28	1 " "	P205
2 "	P44	1 " "	P206
2 "	P53	1 " "	P207
1 "	P55	1 " "	P208
1 "	P58	1 " "	P209
1 "	P59	2 "	12
2 "	P60	1 "	72 "
1 "	P100	1 "	80 "
2 "	P101	2 "	3 "
			537A
			537B
			611c

Model No. S.33 Twin-Engined Amphibian



An amphibian flying boat is a machine capable of taking off from, or alighting on, either land or water, the landing gear for use when alighting on an aerodrome being arranged so that it can be raised or lowered while the aeroplane is in flight. This type of machine is really of more value than the seaplane, for it is able to take advantage of any existing aerodrome or level stretch of ground, while if none is available it can alight on a lake or stream in a similar manner to a seaplane.

Very few amphibians are constructed in England, but three types are built by Saunders-Roe, Ltd. These are the Saro "Cutty Sark," "Windhover" and "Cloud" which are capable of seating four, six and eight respectively. The "Cutty Sark" and the "Cloud" are both similar to the "Windhover" illustrated above except in the matter of size. The "Cutty Sark," the smallest of the Saro range, is 45 ft. in span. The "Windhover" is 53.3 ft. in

Parts required:

1 of No.	P7	1 of No.	P152	1 of No.	P190
1	P8	1	P164	1	P199
1	P14	1	P165	1	P202
1	P15	1	P169	1	P205
1	P18	1	P171	1	P206
4	P29	1	P172	1	P207
5	P30	1	P173	1	P208
5	P31	1	P174	1	P209
5	P34	1	P175	2	38
5	P33	1	P176	62	537A
5	P35	1	P177	53	537B
5	P36	1	P178	5	611c
1	P60	1	P179		
1	P151	1	P184		

span, has a maximum speed of 110 m.p.h., and cruises at 90 m.p.h. The "Cloud" has a span of 64 ft., a maximum speed of 120 m.p.h., a cruising speed of 98 m.p.h. and a range at normal speed of four hours.



Model No. S.34 Raised Fuselage Biplane

In most biplanes the lower wings are secured to the fuselage, but some machines are built with the fuselage either in between the wings or connected to the upper plane. Typical British examples of this method of construction are the Handley Page "Heyford" night bomber, the Vickers "Vellore" freight carrier, and the Vickers "Vespa" army co-operation machine. There are various reasons for adopting this method of construction. There is less likelihood of the fuselage being damaged when landing in rough and unknown country, and the angle that the fuselage presents to the ground gives it a greater wind resistance when taxiing, and this acts as a sort of air brake.

One of the best known of the aeroplanes mentioned above is the Vickers "Vespa" shown on the right, for in this aeroplane Flt. Lt. C. F. Uwins put up a new world's altitude record of 43,976 ft. on 21st September, 1932. It is interesting to note that the "Vespa" in which the successful attempt was made is a standard machine, and that it was marooned for some time at Nanking aerodrome, in China, with water up to its wings!

Parts required:

1 of No.	P7	1 of No.	P152	2 of No.	P186
1	P8	1	P155	1	P195
1	P14	1	P156	2	P199
1	P15	2	P161	1	P201
1	P18	1	P164	1	P202
1	P24	1	P165	1	P203
1	P25	1	P168	1	P207
4	P30	1	P169	1	P208
5	P31	1	P171	1	P209
5	P34	1	P172	1	P210
5	P33	1	P173	1	P211
5	P35	1	P174	1	P212
5	P36	1	P175	4	12
1	P60	2	P176	70	537A
1	P60	1	P177	67	537B
1	P101	1	P178	1	540
1	P102	1	P179	1	611c
1	P151	2	P185		

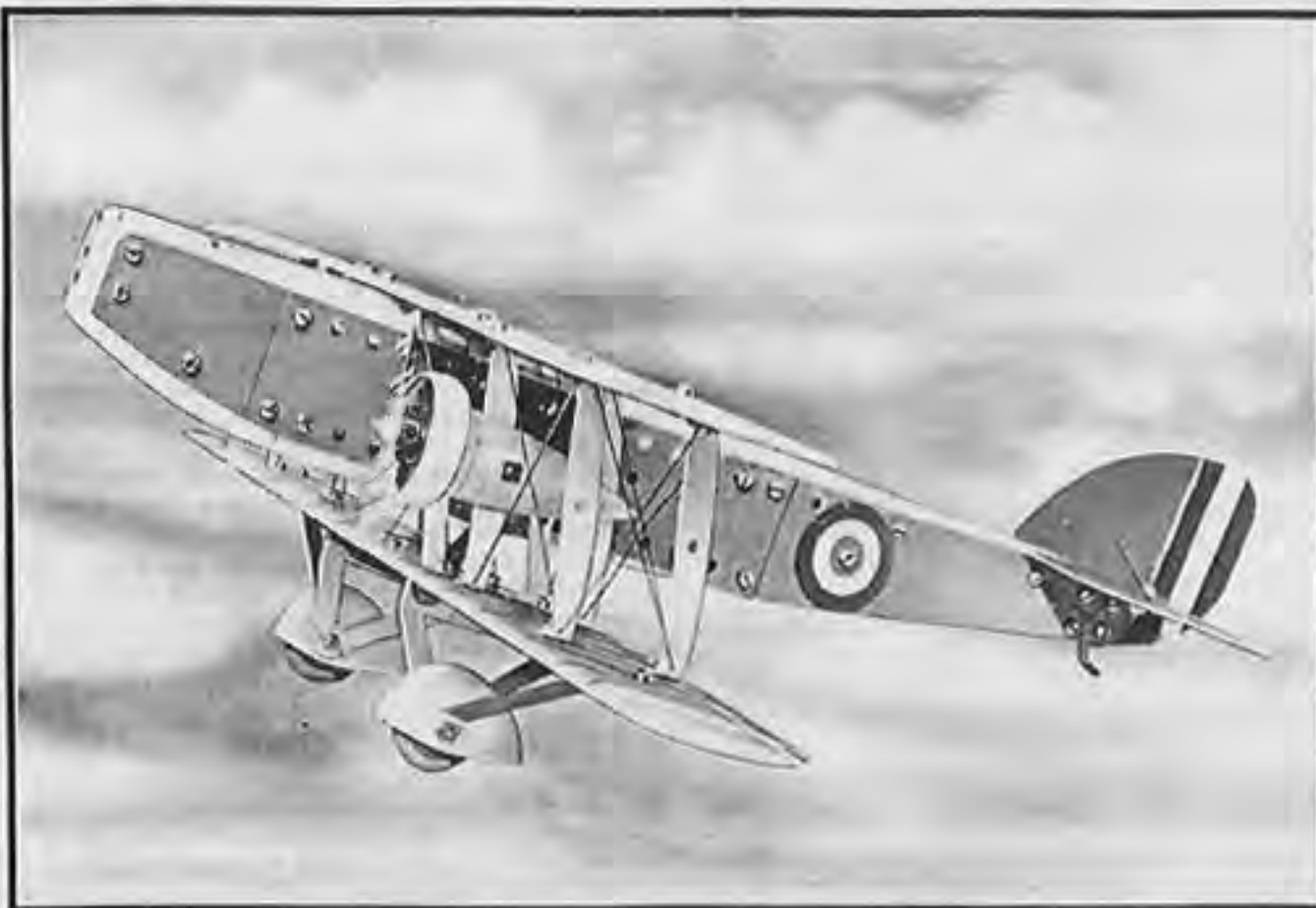



Model No.S.35 Civil Seaplane

Practically all the smaller civil aeroplanes can be obtained either as landplanes or fitted with floats for operation from water. The fitting of floats to an aeroplane very slightly reduces its speed and makes it more difficult to fly. The floats are usually made of duralumin, an aluminium alloy that is exceedingly light and does not readily corrode.

The prototype illustration on the right shows a low wing monoplane seaplane that is very popular in Germany, the Junkers "Junior," on a special catapult used for launching aeroplanes from ships. The "Junior" is a cantilever machine of standard Junkers type, which measures about 32 ft. 10 in. in span and 23 ft. 6 in. in height. It has a maximum speed of 109 m.p.h., a cruising speed of 87 m.p.h., and a landing speed of 46 m.p.h., and with standard petrol tanks it has an endurance of four hours, during which time a distance of about 350 miles can be covered.



Parts required:		
2 of No. P18	1 of No. P168	1 of No. P201
4 " " P36	1 " " P169	1 " " P203
2 " " P31	1 " " P170	1 " " P208
2 " " P42	1 " " P171	1 " " P209
1 " " P52	1 " " P172	4 " " 12
1 " " P56	1 " " P173	1 " " 11
1 " " P57	1 " " P174	45 " " 537A
2 " " P100	2 " " P178	51 " " 537B
1 " " P151	1 " " P178	1 " " 540
1 " " P152	1 " " P179	1 " " 611C
1 " " P161	1 " " P196	
1 " " P165	1 " " P198	

The machine illustrated is on a catapult on the "Bremen" and was used to fly mails to land wher. the liner was still some 600 miles out at sea—an operation that enabled a great saving of time in the distribution of mails to be gained. It is still carried out on both outward and return voyages and, by linking up with other existing air services, the actual time saved on the outward journey amounts to between 24 and 36 hours; while about 48 hours are saved by mails sent from America to Berlin. Junkers "Junior" machines are not usually now employed for the purpose, special seaplanes having been developed for the work.

Model No.S.36 Commercial Flying Boat

The flying boat differs from the seaplane in the fact that the fuselage itself forms the hull or float, while in a seaplane smaller floats are held below the fuselage on an undercarriage. In addition, flying boats are usually much larger than float seaplanes.

Parts required:		
1 of No. P7	1 of No. P171	2 of No. P202
1 " " P15	1 " " P172	2 " " P203
2 " " P18	1 " " P173	2 " " P207
2 " " P26	1 " " P175	1 " " P208
2 " " P27	2 " " P176	1 " " P209
1 " " P151	1 " " P178	2 " " P210
1 " " P152	1 " " P179	2 " " P211
1 " " P155	1 " " P184	2 " " P212
1 " " P156	4 " " P187	4 " " 12
1 " " P161	1 " " P196	52 " " 537A
1 " " P165	2 " " P199	50 " " 537B
1 " " P199	2 " " P201	1 " " 540

Modern flying boats are capable of weathering quite severe storms, although a really fierce gale would be likely to wreck practically any type yet constructed, because of the unsteady effect of the wings. For this reason all commercial flying boats are of the multi-engined type in order to decrease the chances of a forced landing due to engine failure. The engines may be arranged in various ways. They may, for instance, be like those on the Short "Calcutta," which has two engines carried in nacelles mounted between the wings; or like those on the Short "Singapore Mark II," which has four engines. On the Supermarine "Southampton Mark IV" there are three engines, all situated abreast in the gap between the planes.

On the left is an illustration of one of the most modern British commercial flying boats, the Short "Scipio," originally known as the "Kent." This is used on the Mediterranean sections of Imperial Airways services. It is 113 ft. in span across the top wings and 78 ft. 6 in. in overall length, and has a maximum speed of 137 m.p.h.

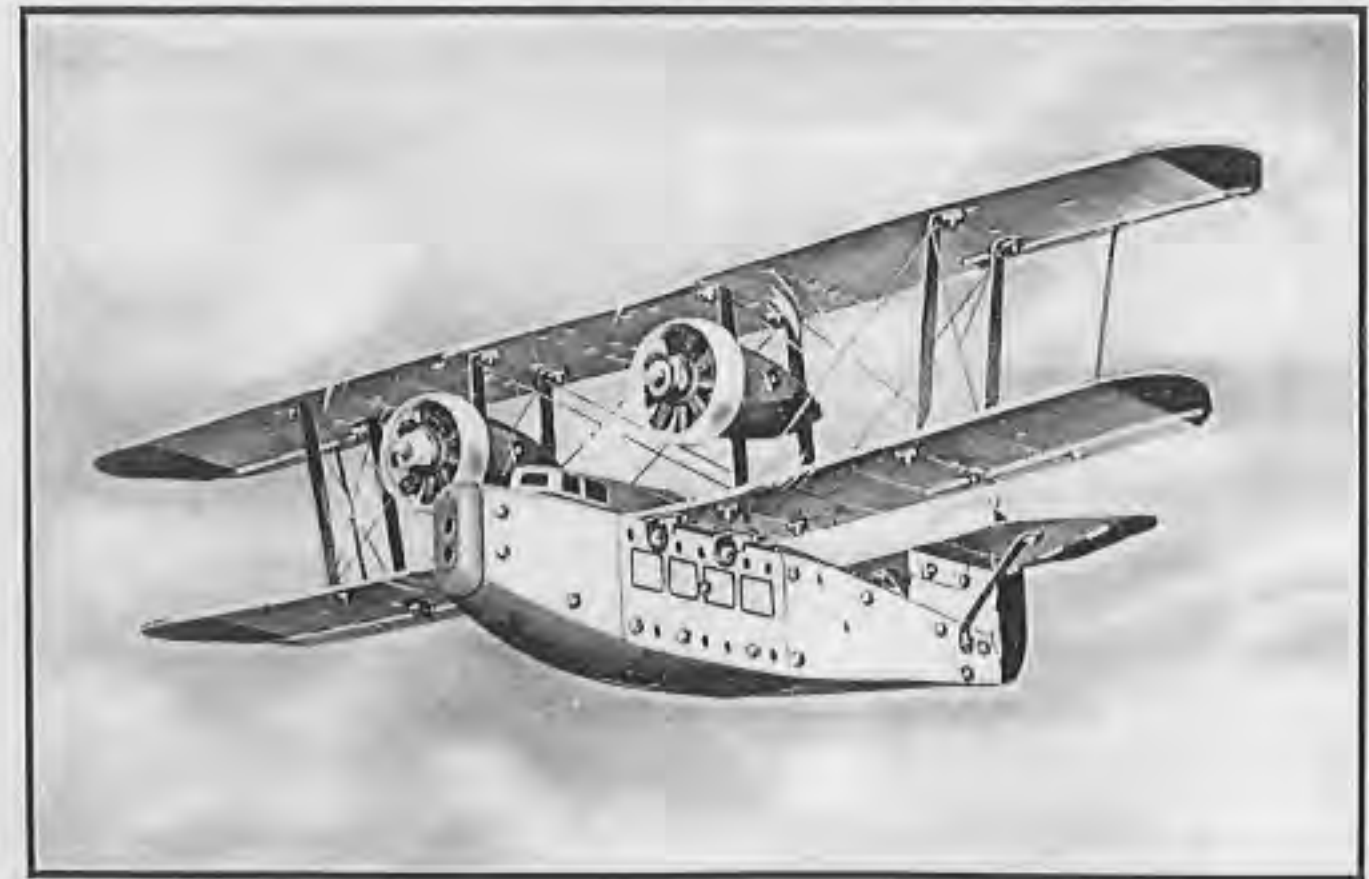

Model No. S.37 Dornier Flying Boat

Everyone has heard of the "Dornier" "Do.X.", the largest flying boat in the world, which has flown with as many as 169 passengers aboard. The Dornier Company build a number of other flying boats, including an interesting machine known as the Dornier "Wal," illustrated below, which is a commercial machine for ten passengers. Most Dornier flying boats may easily be recognised by the fact that they have short wing roots sticking out on each side of the hull. These are known as sponsons, and their main purpose is to assist in stabilising the boat when it is on the water.

The 1932 version of the Dornier "Wal" is provided with two engines arranged in tandem and accommodated in a nacelle placed on top, and in the centre, of the wing. The wing measures about 76 ft in span, and the boat is about 59 ft. 6 in. in length. When equipped with two 500 h.p. B.M.W. VI engines its maximum speed is about 137 m.p.h., and its cruising speed 118 m.p.h.



On the left is a photograph of the Dornier "Wal," while the illustration on the right shows a Fokker "Super-Universal" high wing cabin seaplane.

Another Dornier machine somewhat similar to the "Wal" is the "Super-Wal." This is simply a larger version, being equipped with four 500 h.p. "Jupiter" engines and provided with two cabins for the passengers, with a total of 19 seats. The "Super-Wal" is 93 ft. 6 in. in span and 77 ft. 6 in. in length. It has a maximum speed of 136 m.p.h. and cruises at 112 m.p.h.

Parts required:

1 of No. P7	1 of No. P173	2 of No. P207
2 " " P8	1 " " P175	1 " " P208
1 " " P15	3 " " P176	1 " " P209
2 " " P18	1 " " P178	2 " " P210
4 " " P30	1 " " P179	2 " " P211
1 " " P151	1 " " P184	2 " " P212
1 " " P152	4 " " P194	4 " " 12
1 " " P164	1 " " P196	6 " " 38
1 " " P165	2 " " P199	55 " " 537A
1 " " P169	2 " " P201	50 " " 537B
1 " " P171	2 " " P202	1 " " 611c
1 " " P172	2 " " P203	

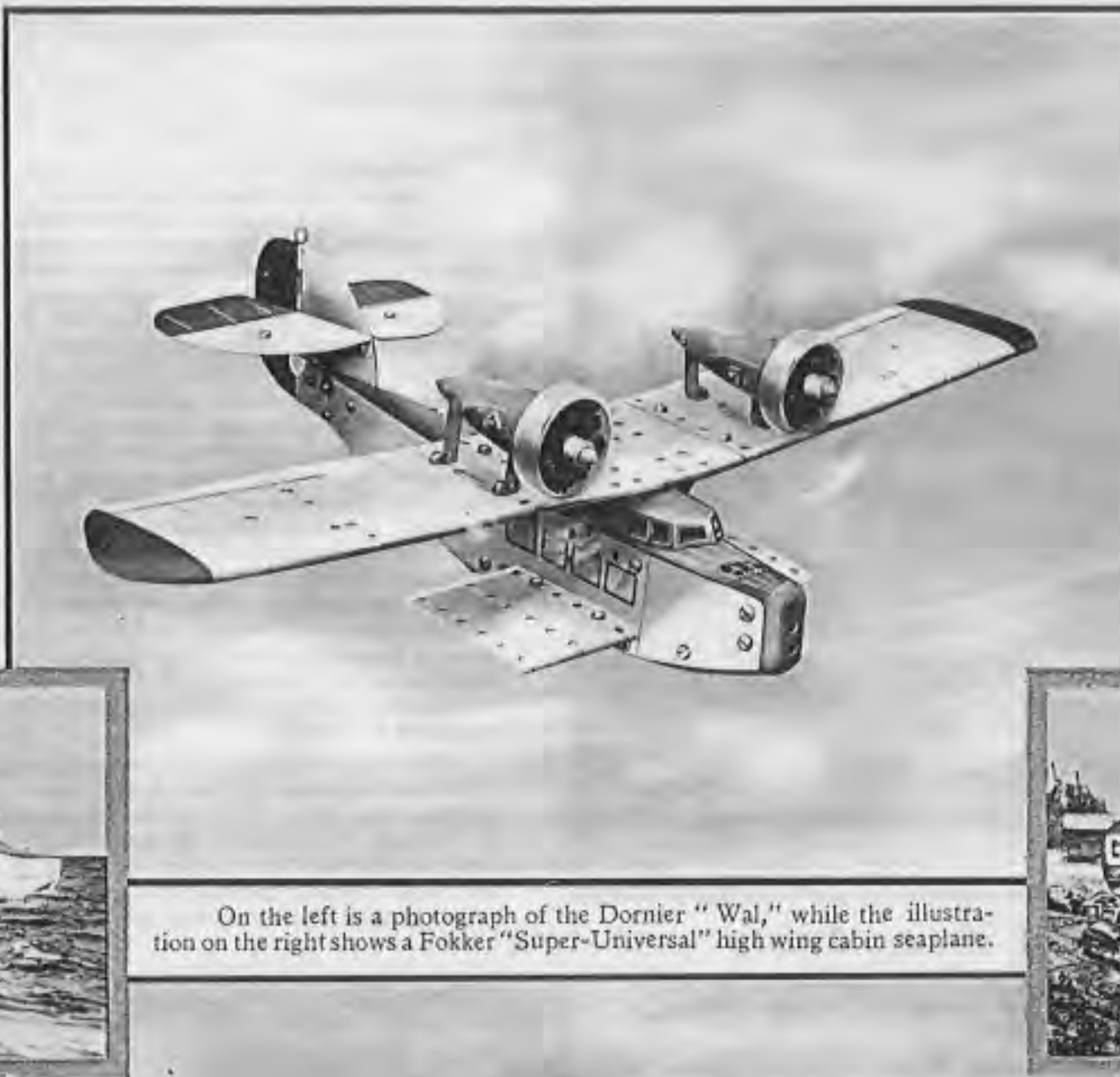

Model No. S.38 High Wing Seaplane

The essential difference between a seaplane and a landplane is that one is fitted with floats to enable it to alight on water, while the other employs a wheeled undercarriage so that it can land on solid ground. Seaplanes are of two types, the float seaplane that makes use of one or two floats carried on struts below the fuselage, and the hull seaplane, usually known as the flying boat, in which the whole of the fuselage is turned into one big float.

In England there are far fewer float seaplanes than landplanes, but in Canada, and some other countries, machines of this type and flying boats are the most common aeroplanes, because these countries are well provided with lakes and rivers on which seaplanes can alight with safety. In the winter when the ground is covered with snow and these lakes and streams are frozen over, the floats are removed from the seaplanes and replaced with skis so that pilots may land with safety on the level surfaces of the frozen lakes.



The illustration above shows a Fokker "Super-Universal" high wing cabin seaplane owned by Canadian Airways Ltd., one of the most important air traffic companies in Canada. The photograph was taken when the machine was at Gold Pines, a lonely lake in the north of the country.

Parts required:

1 of No. P15	1 of No. P168	1 of No. P201
2 " " P18	1 " " P169	1 " " P203
4 " " P30	1 " " P171	1 " " P208
2 " " P31	1 " " P172	1 " " P209
2 " " P42	1 " " P173	4 " " 12
1 " " P52	1 " " P175	1 " " 14
1 " " P56	2 " " P176	43 " " 537A
2 " " P57	1 " " P178	49 " " 537B
1 " " P151	1 " " P179	1 " " 549
1 " " P152	1 " " P184	1 " " 611c
1 " " P164	1 " " P196	
1 " " P165	1 " " P196	

Model No. S.39 Single-Engined Biplane Amphibian

Single-engined biplane flying boats and amphibians are constructed in Canada, the United States, France and Italy, but in this country there is not a great deal of attention paid to them, British designers of marine aircraft having more faith in the multi-engined type. A British single-engined amphibian was built as early as 1912, however, and since then many similar machines have been produced. The Supermarine "Seagull," "Sea Eagle" and "Scarab," and the Canadian Vickers "Vedette," are all of this type, and the Schneider Trophy was won in a single-engined Supermarine "Sea Lion" flying boat in 1922.

Most single-engined flying boats employ pusher airscrews, and are usually constructed so that they can be easily adapted for use either as flying boats or amphibians. An interesting French machine of this type is the Blériot 290, an illustration of which appears below. This



is a three-seater cabin sesquiplane that is equipped with one 230 h.p. Salmson 9 Ab. engine. It is about 48 ft. in span and 31 ft. 9 in. in length, and has a maximum speed of about 115 m.p.h. In still air it has a range of 325 miles.

Parts required:

1 of No.	P3	1 of No.	P164	1 of No.	P202
1 "	P4	1 "	P165	1 "	P203
1 "	P8	1 "	P166	1 "	P207
1 "	P15	1 "	P171	1 "	P208
1 "	P18	1 "	P172	1 "	P209
1 "	P20	1 "	P173	1 "	P210
1 "	P27	1 "	P175	1 "	P211
1 "	P30	2 "	P176	1 "	P212
1 "	P44	1 "	P178	4 "	12
1 "	P53	1 "	P179	6 "	38
1 "	P55	1 "	P184	51 "	537A
1 "	P56	4 "	P187	51 "	537B
1 "	P60	1 "	P196	1 "	540
1 "	P161	1 "	P199	1 "	611c
1 "	P162	1 "	P201		



The photograph on the left shows the Blériot 290, while on the right is an illustration of the Spartan "Cruiser" triple-engined low wing monoplane. This has accommodation for six.

Model No. S.40 Triple-Engined Low Wing Monoplane

Low wing monoplanes have become comparatively popular among aircraft designers in this country during the last few years. Those built include single-engined racers, two and three-seater cabin machines, fast interceptor fighters, and medium-sized machines equipped with twin engines. The only three-engined low wing monoplane built in this country is the Spartan "Cruiser," illustrated below. This machine, which was at first known as the Spartan "Mailplane," has accommodation for six in a totally enclosed cabin, and is equipped with three D.H. "Gipsy" engines of the inverted type, each of which develops 120 h.p.

The "Cruiser" is 54 ft. in span and about 39 ft. in length, and can be obtained either as a passenger carrier or for service as a freighter. The passenger machine weighs 3,400 lb. when empty, and 5,500 lb. when fully loaded; the freight machine is 3,320 lb. empty and 5,500 lb. fully loaded. The maximum speed is 135



m.p.h. and the cruising speed 110 m.p.h.

An interesting French triple-engined low wing monoplane is the Couzinet monoplane, which also is fitted with three D.H. "Gipsy" inverted engines. This machine has been designed for long distance flights, and, when carrying a crew of three, has petrol tanks that give it a range of 3,000 miles.

Parts required:

2 of No.	P8	1 of No.	P152	1 of No.	P196
1 "	P16	1 "	P164	3 "	P199
2 "	P18	1 "	P165	2 "	P202
2 "	P31	1 "	P168	2 "	P205
2 "	P44	1 "	P169	2 "	P206
1 "	P52	1 "	P171	2 "	P207
2 "	P59	1 "	P172	1 "	P208
1 "	P55	1 "	P173	1 "	P209
1 "	P56	1 "	P175	4 "	12
1 "	P58	2 "	P176	1 "	14
1 "	P59	1 "	P178	48 "	537A
2 "	P60	1 "	P179	47 "	537B
1 "	P151	1 "	P184	3 "	611c

Model No. S.41 High Wing Air Liner.

The high wing monoplane is rapidly gaining in favour with air line companies, and it is possible that ultimately it will completely oust the biplane. The latest machines used by Imperial Airways, the Armstrong Whitworth "Atalantas," are four-engined high wing monoplanes. These huge machines are 90 ft. in span and are capable of travelling at a speed of 156 m.p.h.

Although water-cooled engines are employed occasionally in machines of this type, an example being the French Bordelaise D.B.70, they are usually fitted with radial air-cooled engines. An example of a high wing air liner equipped with three air-cooled engines is the Westland "Wessex" illustrated on the right of the inset. This machine, normally a six-seater, can be made to carry seven to eight people by reducing the petrol capacity. It is 57 ft. 6 in. in span and has a maximum speed of 118 m.p.h. and a cruising speed of 100 m.p.h. Flight can be maintained with any one engine stopped, in which condition the machine has a maximum speed of 98 m.p.h. and is able to maintain an altitude of 6,000 ft. With three engines working normally, it has a range of 420 miles.

Parts required:		
1 of No. P7	1 of No. P152	3 of No. P109
2 " " P8	1 " " P164	3 " " P201
1 " " P14	1 " " P165	2 " " P202
1 " " P15	1 " " P168	3 " " P203
2 " " P18	1 " " P169	2 " " P207
4 " " P30	1 " " P171	1 " " P208
2 " " P31	1 " " P172	4 " " P209
2 " " P44	1 " " P173	2 " " P210
1 " " P52	1 " " P174	2 " " P211
2 " " P53	1 " " P175	2 " " P212
1 " " P55	2 " " P176	1 " " 16A
2 " " P56	1 " " P177	51 " " 537A
1 " " P58	1 " " P178	47 " " 537B
1 " " P59	2 " " P179	1 " " 611c
2 " " P60	1 " " P184	
1 " " P151	1 " " P196	

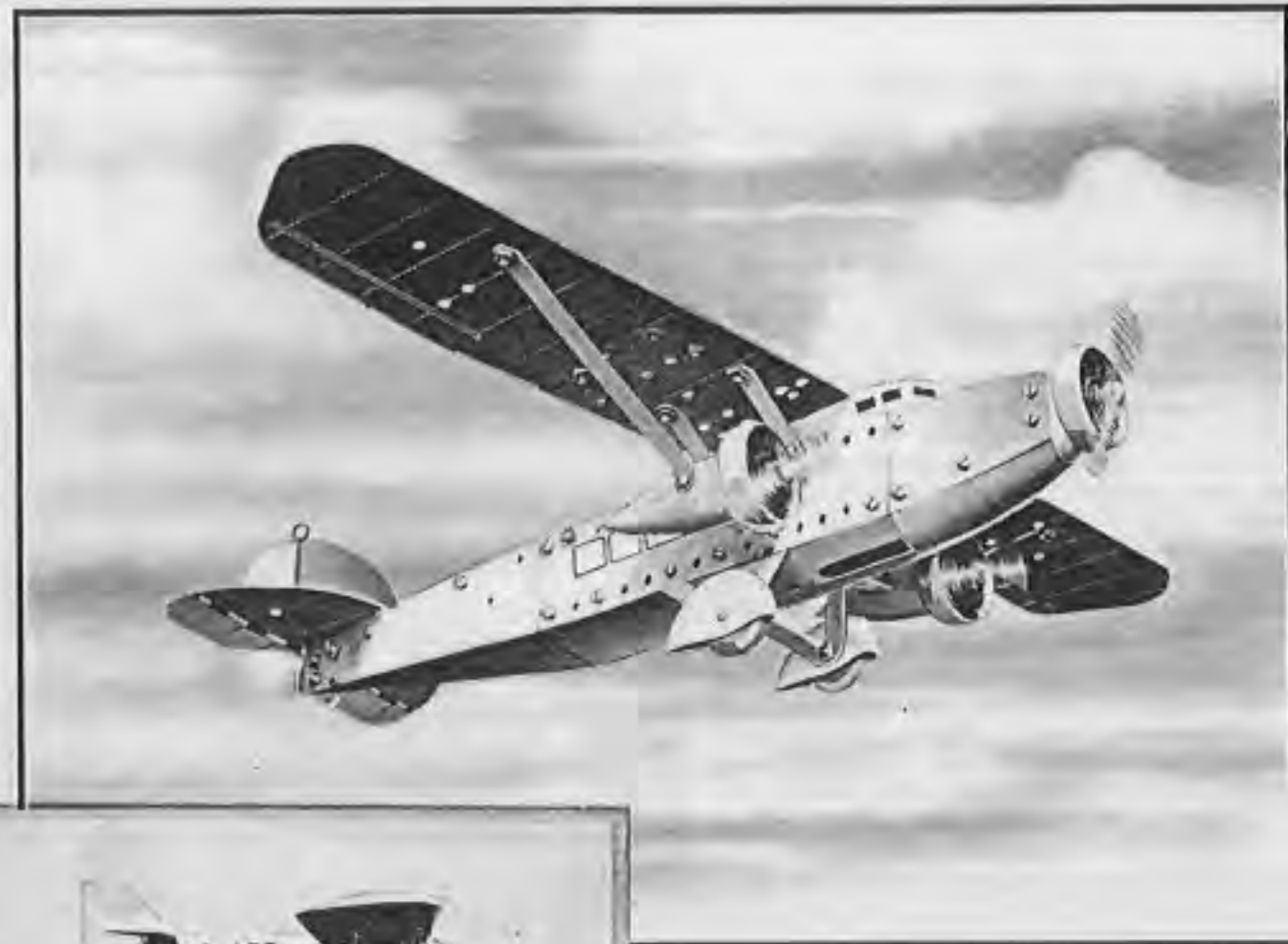

Model No. S.42 Fleet Seaplane

Parts required:		
1 of No. P7	1 of No. P155	1 of No. P189
2 " " P18	1 " " P156	2 " " P192
1 " " P26	1 " " P164	2 " " P193
1 " " P27	1 " " P165	1 " " P195
2 " " P29	1 " " P168	1 " " P198
4 " " P30	1 " " P169	1 " " P208
2 " " P42	1 " " P170	1 " " P209
1 " " P52	1 " " P171	4 " " 12
1 " " P56	1 " " P172	1 " " 14
2 " " P57	1 " " P173	60 " " 537A
2 " " P100	1 " " P175	67 " " 537B
2 " " P101	2 " " P176	1 " " 540
2 " " P102	1 " " P178	1 " " 611c
1 " " P151	1 " " P179	
1 " " P152	1 " " P188	

Aeroplanes that are used for service with the Royal Navy may be operated from either warships or aircraft carriers. The types employed may be similar to those used from the ordinary aerodromes of the R.A.F., but they will be called upon to meet certain requirements that are peculiar to fleet work. They must, for instance, be provided with wings that can be folded back in order to facilitate storage in the limited space available on board ship, and they must be specially strengthened to enable them to withstand the stresses set up when being launched into the air by means of catapults. In addition it must be possible for the wheel undercarriage to be removed and replaced by floats without any difficulty.

Such a machine is the Hawker "Osprey," shown on the left of the inset, which is the naval version of the Hawker "Hart" day bomber illustrated on page 7 and which may be used both for naval reconnaissance work and for fighting. It is a two-seater built entirely of metal except for a fabric covering and is equipped with the Rolls-Royce "Kestrel" engine that gives it a maximum speed of about 175 m.p.h. and a landing speed of 68 m.p.h.



Model No. S.43 Triple-Engine Monoplane

Parts required:

2 of No. P8	1 of No. P165	2 of No. P202
1 " " P14	1 " " P168	3 " " P203
1 " " P15	1 " " P169	1 " " P205
2 " " P18	1 " " P171	1 " " P206
3 " " P20	1 " " P172	3 " " P207
2 " " P30	1 " " P173	1 " " P208
2 " " P44	1 " " P174	1 " " P209
1 " " P52	1 " " P175	2 " " P210
2 " " P53	2 " " P176	2 " " P211
1 " " P55	1 " " P177	2 " " P212
1 " " P58	1 " " P178	1 " " 16A
1 " " P59	2 " " P179	8 " " 38
2 " " P60	1 " " P181	54 " " 537A
1 " " P151	1 " " P156	45 " " 537B
1 " " P152	3 " " P199	4 " " 611c
1 " " P164	3 " " P201	

In connection with Model No. 21 we described the Aircspeed "Ferry," a machine that is unusual because of the disposition of its engines, one being carried above the wing instead of in the nose. Similar methods of arranging the engines are becoming increasingly popular, being employed in such machines as the Boulton and Paul P.32 bomber and in the four-engined Handley-Page "Hannibal." An interesting high wing monoplane in which the engines are arranged in this manner is the Dornier "Do.Y." a bombing machine built by the Swiss branch of the well-known German Dornier Company, and illustrated on the left of the inset.

The Dornier "Do.Y." is a four-seater bomber. Its wings are of the cantilever type, with a span of 91 ft. 10 in., and are of typical Dornier construction, tapering in chord and thickness. The fuselage is rectangular in cross section and carries a tail unit of the normal monoplane type. The undercarriage is of the divided type, and is arranged so that the machine is very low on the ground when taxiing or at rest. The machine is piloted from a two-seat open cockpit immediately in front of the leading edge of the wing, and there are two other cockpits, one in the nose and one behind the wing.

Three Bristol "Jupiter" radial air-cooled engines are fitted, and these give the machine a maximum speed at ground level of about 151.5 m.p.h. and a cruising speed of about 130.5 m.p.h.



Model No. S.44 General Purpose Military Biplane

General purpose machines, as their name implies, are aeroplanes that have been specially designed to enable them to be used for various military purposes with a very small amount of alteration. Thus they can be used for training, bombing, army co-operation, and reconnaissance and many other purposes. The two most popular general purpose machines used in the R.A.F. are the Fairey 111F and the Westland "Wapiti." These machines are used by various squadrons, the "Wapiti" being employed extensively by those stationed in the East, where it has seen much war service.

Probably the most famous general purpose aeroplane is the Westland "Wallace," illustrated on the right of the inset, for it was in two slightly modified machines of this type that the famous photographic expedition over Mount Everest and other mountains in the neighbourhood was made.

The "Wallace" has been developed from the "Wapiti," and in its construction great attention has been paid to streamlining and strength. Its wings have a spread or span of about 46 ft. 6 in., and in the landplane form it is about 34 ft. in length and 11 ft. 6 in. in height. A Bristol "Pegasus" engine is employed.

Parts required:

1 of No. P7	2 of No. P102	1 of No. P178
2 " " P8	1 " " P151	1 " " P179
2 " " P18	1 " " P152	4 " " P187
4 " " P28	1 " " P155	1 " " P185
4 " " P29	1 " " P154	1 " " P188
2 " " P31	2 " " P162	1 " " P201
2 " " P44	1 " " P164	1 " " P203
1 " " P52	1 " " P165	1 " " P208
2 " " P53	1 " " P168	1 " " P209
1 " " P55	1 " " P169	4 " " 12
1 " " P56	1 " " P170	1 " " 14
1 " " P58	1 " " P171	69 " " 537A
1 " " P59	1 " " P172	71 " " 537B
2 " " P60	1 " " P173	1 " " 540
2 " " P100	1 " " P175	1 " " 611c
2 " " P191	2 " " P176	

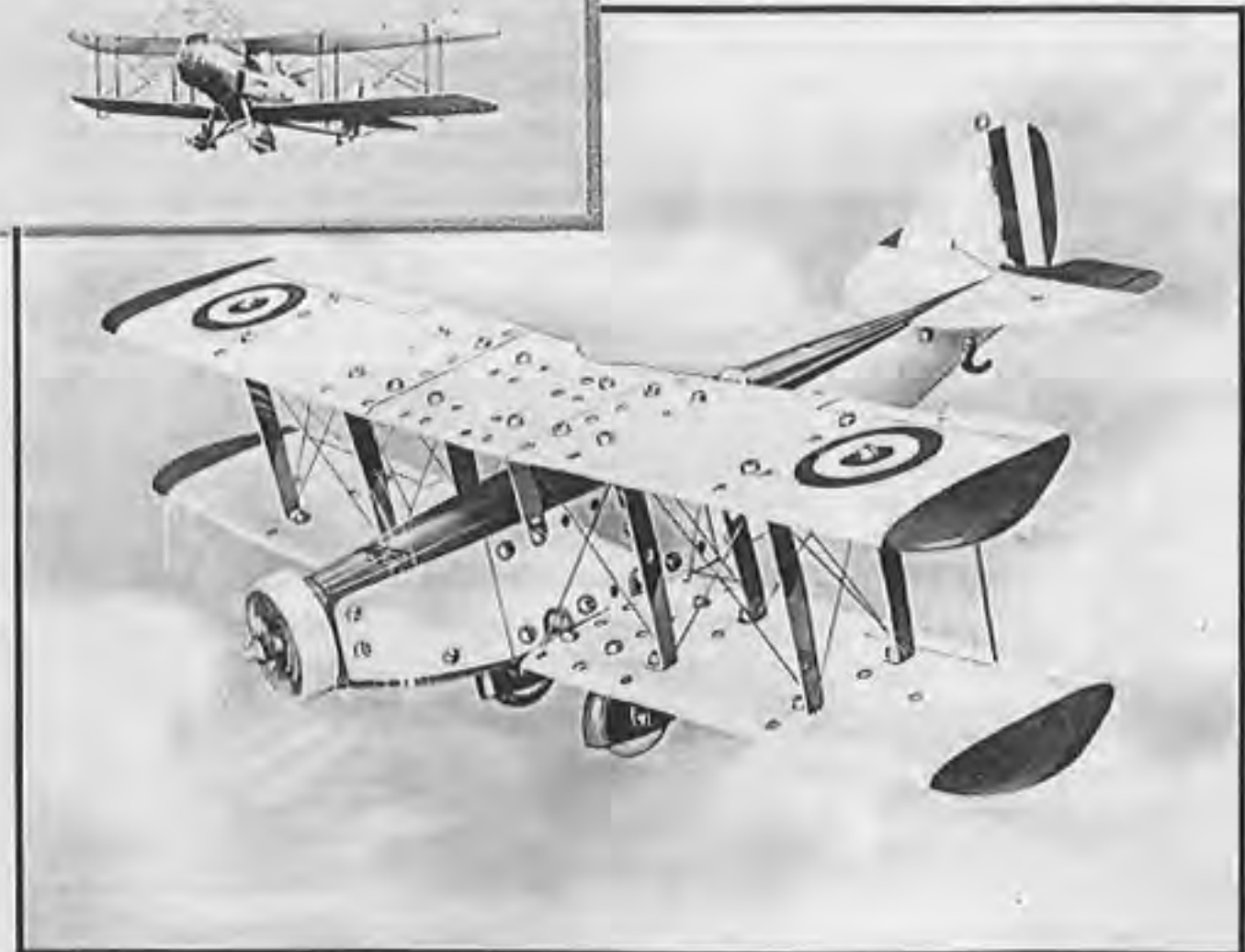

ADVANCED FLYING AND AEROBATICS

At the beginning of this Manual we described how an aeroplane is controlled, and what keeps it in the air. We now propose to take our readers for an imaginary flight, during which we shall perform some of the most common "aerobatics," as stunts in the air are called. We will assume that we are not fortunate enough to own a machine, but that we are members of an aero club, and therefore shall make our flight in a club machine. These machines are usually two-seater light aeroplanes used primarily for instruction purposes, but also for hiring out to members of the club who have obtained an "A" licence, which entitles them to pilot a machine for pleasure, as distinct from commercial gain. A paragraph dealing with the test for the "A" licence appears on page III of cover.

When the day arrives we travel by car to the aerodrome, which is almost certain to be some distance out in the country. Most aerodromes are just large flat fields, usually with a surface of specially-prepared turf, and situated in as flat country as can be found in the neighbourhood. At the aerodrome is the club house and the hangars or sheds in which the aeroplanes are housed and where the mechanics overhaul the machines and keep them in repair.

Going Up for the First Time

After parking the car and donning suitable flying clothes we walk out on to the "apron," or concrete surface in front of the hangar, where the machine we have booked is awaiting us. When we have taken our places in the machine, the engine is started, probably by swinging the propeller, and after running it for a short time to make certain that everything is operating satisfactorily, we head into the wind, the direction of which has been noted from the wind cone.

On taking off we fly straight for some time, admiring the view, and finding how different everything looks when seen from the air. The first trip in an aeroplane is often disappointing, for most people expect flying to be one of the most thrilling things imaginable, and are secretly sorry to find that this is not the case, except of course when a machine is stunting. When this takes place, however, those who are not accustomed to it are apt to experience far more thrills than they care for at the time!

Aerobatics, or the art of performing intricate evolutions in the air, developed in the Great War, when pilots were forced to use their ingenuity to discover new methods of manoeuvring an aeroplane to outwit an enemy, or to get away with their lives when caught in a tight corner. At first there were many accidents, for the early War aeroplanes were by no means strong, and were liable to break up in the air when any

extra stresses were thrown upon them. Gradually the art of aerobatics progressed, however, and nowadays fatal accidents very rarely occur through stunting, and exhibitions of advanced aerobatics are given regularly at flying displays. Aerobatics are performed not only by individual machines, but also by several machines flying in formation. At the annual Royal Air Force Display it is a regular event for a number of flights of machines to take off and to perform intricate manoeuvres in the air while linked together by elastic cords.

It is often stated that stunt flying is of value only to military pilots and test pilots employed by aeroplane manufacturers. This is a mistake, however, for such flying is of great importance to the ordinary civil pilot. When a pilot is capable of putting his machine into any position in the air he feels perfectly at home in it, and thus is able to keep his head in any emergency that may arise.

The Value of Aerobatics

The tests that must be passed before the "A" licence can be secured are comparatively simple and do not involve any knowledge of aerobatics; and a pilot who has just secured his licence is still only at the very beginning of his flying career. He is capable of flying an aeroplane in good weather, but if he were to be caught in a storm or among clouds he would soon be in difficulties. When flying among clouds even an experienced pilot may easily lose all sense of position and direction, and on emerging from them he may find that he is flying upside down. In such a predicament a pilot who had had even a little training in aerobatics would quickly recover himself, but one who was quite inexperienced would be in a serious position.

Aerobatics form also a very valuable means of publicity for flying. The exhibitions of stunt flying that have been given in many parts of the country have attracted large numbers of spectators, many of whom have been tempted to try the experience of a "joy flight," and in this manner have taken the first step towards making use of air transport. In almost every instance, the only complaint of people who have been up for a first flight is that it was too soon over, and they are eager to go up again at the first opportunity.

Nearly all small machines can be put through many forms of aerobatics, and displays are given regularly in ordinary civil light aeroplanes such as the D.H.

"Moth." Large commercial machines, such as the Handley-Page "Hannibal" and the Armstrong Whitworth "Atalanta," are not used for aerobatics, for obviously they are too big for such a purpose. This does not mean that all big aeroplanes cannot be stunted if necessary. They can, but, not being built for such work, are slow on the controls.

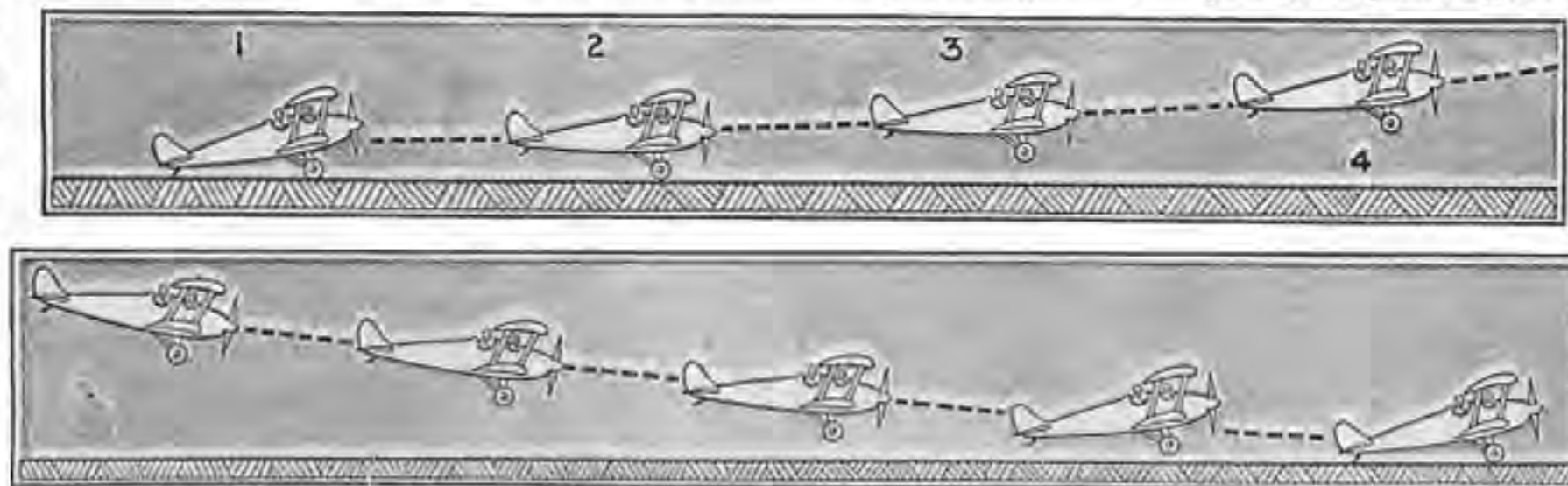

The upper series of illustrations shows how an aeroplane takes off, and the lower series, how an aeroplane lands.

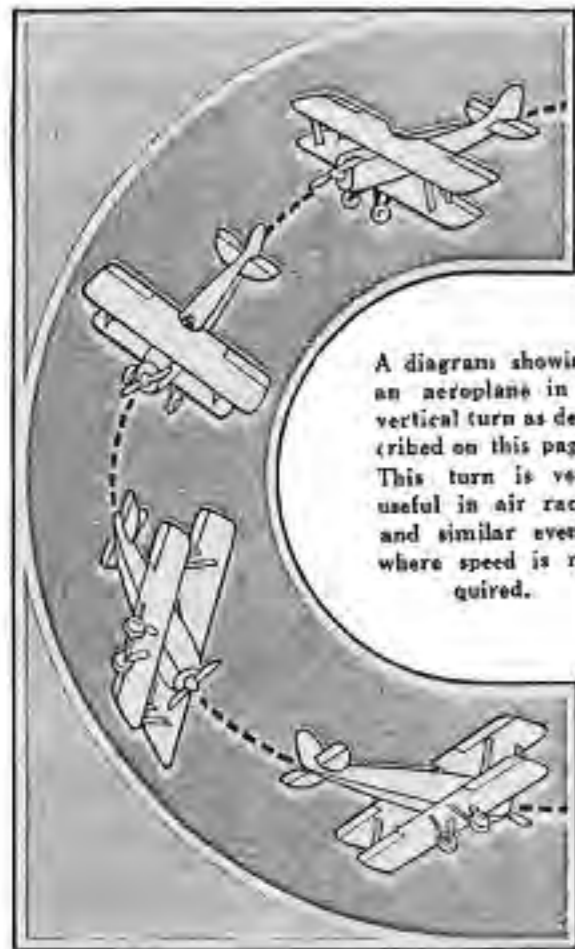

A diagram showing an aeroplane in a vertical turn as described on this page. This turn is very useful in air races and similar events where speed is required.

turns over on to its back we pull the stick hard back and push the rudder control as far over as it will go in the direction in which we wish to turn. This causes us to make a half roll, and just as this is being completed we gently ease the stick forward and, by judicious use of the rudder and ailerons, prevent the machine from rolling any further. If we look now at the altitude indicator on the dashboard of the machine we shall find that we have gained several hundred feet in a few seconds in addition to having turned completely round.

Vertical Turn for Racing

When a pilot is taking part in an air race he may gain or lose a considerable amount of time by the way in which he takes corners, or races round the pylons that mark the limits of the course. An ordinary turn as described on page 1 would be quite unsuitable for use at high speed, and what is known as a vertical turn is usually employed. The method of doing this is made clear from the illustration above. As we are flying at our maximum speed we make a vertical bank. In this position the elevators may be regarded as assuming the duties of the rudder, as they are now vertical, and consequently we turn the machine round by moving them and not the rudder. The vertical turn is very similar to what is known as the climbing turn. In this the aeroplane banks almost vertically, and as it turns the nose is kept above the horizon so that the aeroplane climbs. The vertical turn is often done at air displays, as it is very effective and can be carried out near the ground, enabling photographers to secure good records for publication in the press.

We described on page 1 how an aeroplane makes a normal turn. This, of course, is a simple everyday manoeuvre, although beginners do not always find it so! In the War various other and more elaborate methods of turning were developed with the object of enabling a pilot to attain a position of advantage for attacking an enemy machine, or of extricating himself from a difficult position. The most famous of these war-time turns is that originated by the German pilot Max Franz Immelmann. The great feature of this turn is that the pilot not only faces his aeroplane about, but at the same time gains height rapidly.

In this manoeuvre we start with a short power dive—that is, a dive with the engine on—in order to gain the necessary speed. When we are travelling fast enough, the exact moment being determined by experience and by the type of machine we are flying, we pull back the control stick. The aeroplane climbs steeply, and just as it

Another useful turn employed to head the aeroplane in the opposite direction without losing speed is the "Split-S" turn. This is done at the normal cruising speed by pulling the stick hard back and at the same time applying full rudder. The aeroplane naturally stalls and falls off on the side directed by the rudder, and we straighten out facing in the opposite direction. The manoeuvre must not be carried out near the ground, for a considerable amount of height is lost during its execution. This turn is very attractive to watch.

A Useful Turn in a Forced Landing

The "Wing-over" is similar to the "Split-S" turn, the most important differences being that the aeroplane is completely under control throughout the manoeuvre, and that little altitude or flying speed is lost. Starting from a level flying position, we gradually pull back the stick, thus pulling up the nose of the machine; and at the same time we commence a slight bank, gradually increasing this until the aeroplane is in a moderately steep vertical turn. The machine is now at right-angles to its original course, with its nose well above the horizon. By applying the necessary rudder the aeroplane goes over into a vertical spiral, from which we recover by pulling up the nose and applying aileron and rudder, and afterwards levelling off.

Still another type of turn is the "S" or "Figure 8" turn. This is made during a glide to land, and the manoeuvre consists of a series of "8"s. It is of great value when forced landings are being made, as it enables height to be lost while the machine keeps over a small area. The "Figure 8" also allows the pilot to keep in sight the portion of ground he has selected for landing, during the whole of the time that he is losing height.

The climbing turn off the ground is a stunt that combines two normal manoeuvres. In this the pilot takes off and turns at the same time, a feat that requires a good deal of skill but looks very simple. It is sometimes very useful when taking off in a race, and can also be used to avoid obstructions, such as trees or hangars.

The Immelmann turn, developed by a famous German pilot during the Great War. It enables a pilot to face his aeroplane about and at the same time gain several hundred feet of altitude.

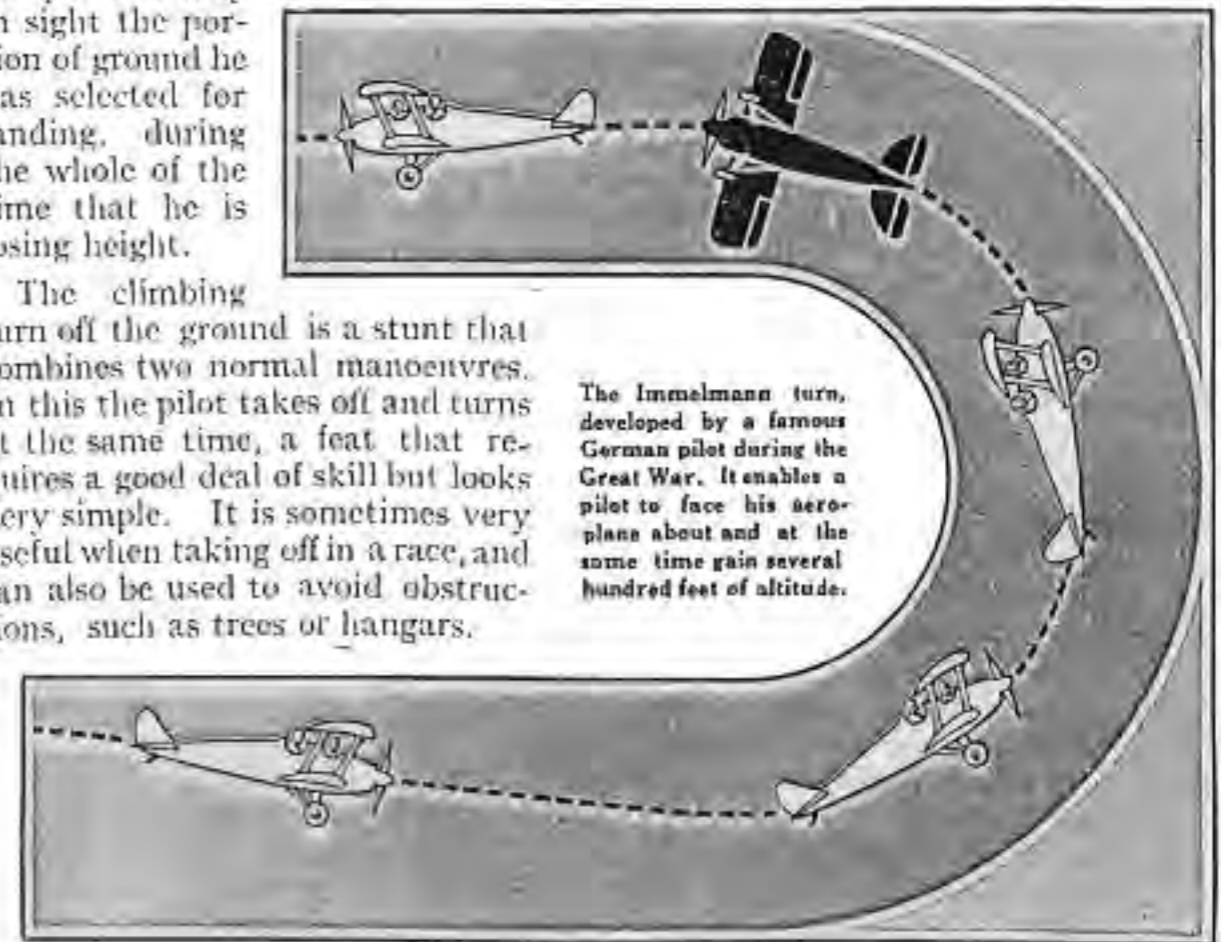

Rolling consists of making the aeroplane roll round with its fuselage as the axis, and it is a very spectacular manoeuvre when carried out properly. There are two distinct types of roll, the slow and the "flick," and we will begin with the former. To do this we dive slightly with the engine partly off, and when

we have gained enough speed we push the stick over to the right and bring the rudder into action as necessary, which causes the machine to bank and eventually to roll slowly over on to its back. In this position we are higher than when we entered the roll, and when we have completed it, and are right side up once more, we have climbed still further. The slow roll is usually carried out at a fairly good height, although it can be done quite close to the ground. Experienced pilots can even roll immediately upon taking off from the aerodrome and complete the manoeuvre without rising higher than the tops of the hangars.

The flick roll is similar to the slow roll except that the machine rolls much more quickly. To begin with we fly at a speed some 30 or 40 m.p.h. less than our maximum. We now apply aileron in the direction of the roll and, increasing our speed, pull the stick back as far as possible and at the same time push the rudder bar hard over, causing the machine to roll very quickly. The roll is checked by centralising the stick and the rudder bar. It is difficult to make some aeroplanes perform this manoeuvre, as they try to fly round instead of rolling. Any difficulty of this kind can usually be overcome by moving the stick and the rudder bar quickly into their proper positions for the manoeuvre. Other aeroplanes will only do the roll properly in one direction.

The Half Roll and the Squadron Roll

The nature of the half roll is easily realised from its name. It is used by a pilot who wishes to fly upside down, for he flattens out when an ordinary roll is half completed. It is useful also when a half loop has been made, as it enables the machine to regain its proper flying position. This is described in the next column, in dealing with looping the loop.

The latest manoeuvre to be developed consists of a roll made by a number of machines flying in formation. This means that the complete flight, or squadron, as the case may be, rolls as one unit. The feat was first accomplished by pilots of the Royal Air Force and has been brought to great perfection. It is undoubtedly one of the most spectacular stunts that can be performed, and it has only been made possible by the production of such machines as the Hawker "Fury," and such engines as the Rolls-Royce "Kestrel" with which they are equipped. Striking exhibitions of the "squadron roll" are now usually given by the Royal Air Force at displays in which they take part.



This sketch illustrates the various positions into which an aeroplane goes in course of one complete roll.

Looping the loop is one of the most frequently performed aeroplane stunts, but although it appears very spectacular from the ground, it is in reality simple. It is generally stated that the manoeuvre was first executed by Pégoud, the famous French pioneer who was killed during the Great War, but it is sometimes

claimed that the first person to loop was a Russian officer named Westoroff, who performed the feat in a Nieuport machine. It was certainly Pégoud who popularised the manoeuvre, however,

and he gave exhibitions of it in this country on many occasions.

There are several kinds of loops, but we will start with what is known as a slow loop, probably the most graceful of all. First we glance at the altitude indicator to make sure that we have sufficient height, for as the speed of the machine during the manoeuvre is at times only a little above stalling point, engine failure might have serious results if we were not high enough to have room to regain control.

A Popular Manoeuvre—Looping the Loop

Before commencing the loop we fly level for a short time and then dive slightly, pushing the stick forward and keeping the rudder in the central position. We then slowly pull the stick backward, keeping the engine on until our machine has climbed on to its back and we can see the ground apparently above our heads, when we throttle back and ease the stick forward slightly as we come down in a steep dive. We must take care not to pull out of the dive too quickly for this imposes high stresses on the wings of the machine.

In the early days of flying many fatal accidents were caused in this way, aeroplanes then not being as strong as modern machines.

During the manoeuvre the rudder must be applied to keep the machine straight, particularly when upside down at the top of the loop, for in this position there is a great tendency for the machine to fall to one side. When a pilot makes his first loop it is a common occurrence for him to forget to check his position by the horizon, the ground and the clouds, and then he may find himself coming out in a direction totally opposite to that which he expected. Another elementary mistake, caused by the slow speed at which the manoeuvre is executed, is to hang on top of the loop too long, causing the machine to stall. Many accidents have occurred through loose articles falling

and striking the pilot when the machine was upside down.

Having recovered from the effects of our first stunt we will proceed to climb to gain height for an inverted or "outside" loop, which, as its name implies, is the reverse of the loop we have just described. We begin by flying more or less

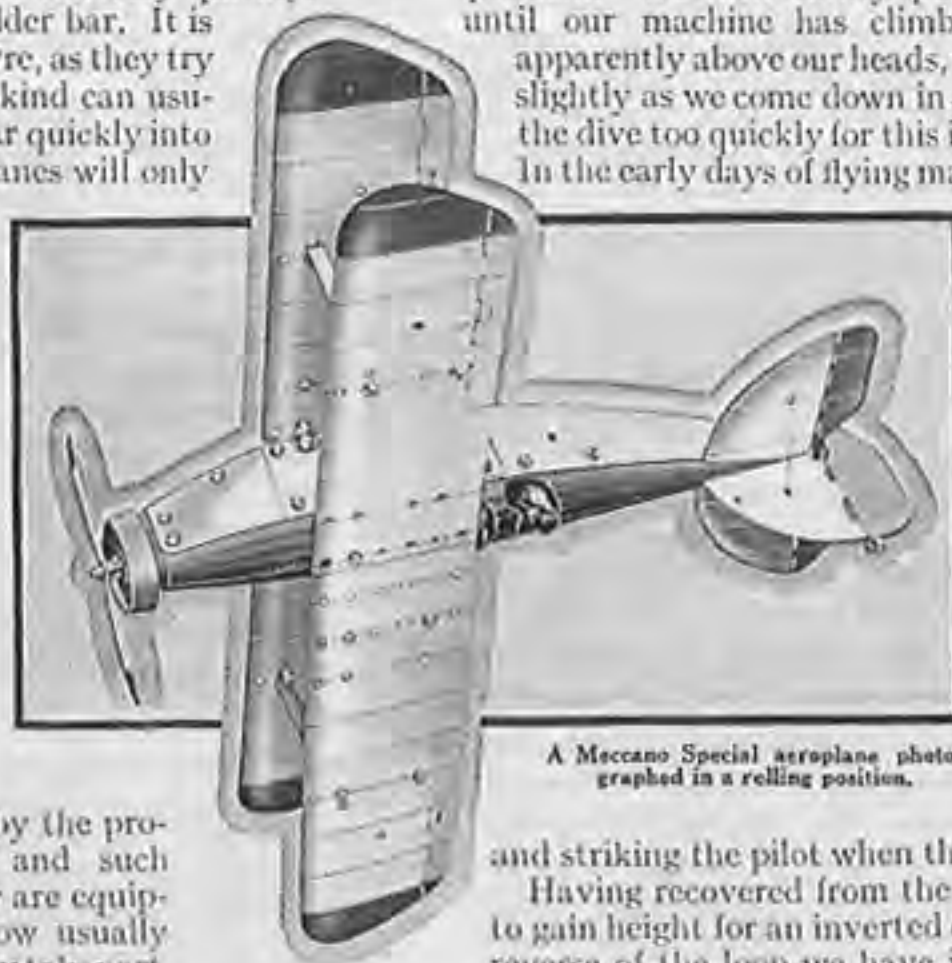

A Meccano Special aeroplane photographed in a rolling position.

level, and then we put the nose of the machine down and dive instead of climbing as in the ordinary loop, climbing back to our original position with the engine on. This type of loop imposes a great strain on the wings of an aeroplane, and although it is not particularly difficult to perform it is not often done. We will next make a rocket loop, or a "zoom followed by a flick loop," as the manoeuvre is sometimes termed. This is used when a pilot wishes to gain height rapidly and to continue flying in the same direction. We start with the engine on, the stick pushed forward, and the rudder in the central position. After diving slightly to gain speed we pull the stick back sharply and rocket vertically up. We are now at the top of our climb, and pushing the throttle wide open we pull the stick hard back in order to make the machine turn over. As we come down in a dive we close the throttle and push the stick forward, gradually pulling out into level flight. This manoeuvre is frequently carried out at displays by high-powered military machines that dive to within a few feet of the ground and then zoom upward.

Another variation of the loop is a half loop followed by a half roll. This is employed by pilots who wish to gain altitude rapidly and also to reverse their direction of travel. The first part of the manoeuvre is the same as if we were doing an ordinary loop, but when we are hanging upside down on the top of the loop we roll, or twist over, so that the machine flies right way up, and proceeds in the opposite direction. A half outside loop followed by a half roll can also be done.

Diving and the Spinning Nose Dive

After flying normally for a short time to get over the effect of our rolls, we will try a few dives and spins. It is, of course, perfectly easy to dive. All we have to do is to switch the engine off and put the stick forward, and down we go; and the further forward we push the stick the steeper will be the dive. While doing this we must keep the rudder bar in the neutral position in order to keep the dive straight. To pull out of a dive we gently but firmly ease the stick backward, when the aeroplane will flatten out. Great care must be taken not to pull out too sharply, as the strain on the aeroplane is great. The machine should still be fairly high up when it is pulled out of the dive.

Diving is usually carried out as a preliminary to some other stunt, such as looping or zooming, in order to attain a higher speed than the normal maximum of the machine. A dive with the engine running is termed a "power dive," and when aeroplanes are being tested they are sometimes dived in this manner until what is known as the "terminal velocity" is reached. This means that the aeroplane has reached the highest speed of which it is capable, and no matter how long it may continue diving, this speed will not be exceeded owing to the tremendous air resistance that is set up.

The spin is a steep dive during which the aeroplane is turning rapidly round and round, with very unpleasant effects on the equilibrium of inexperienced occupants. It is probable that more serious aeroplane accidents have been caused by spinning than by anything else. In the early days of flying a spin was one of the most dreaded things that could happen, and a pilot who succeeded in recovering safely from one was looked upon as a brilliant airman. A spin is dangerous if it occurs at a low altitude, as for instance, after a stall caused by the engine cutting out directly after taking off. Even at a height sufficient to allow of recovery by an experienced airman, a beginner is liable to become confused by the continual whirling round of his machine. The result is often that, if he succeeds in bringing his machine into a straight dive, the slowing-up of the spinning motion produces the sensation of another spin in the opposite direction.

In order to get out of this apparent spin he throws the machine once more into a spin in the original direction, and is in a worse position than he was before. Nowadays no experienced pilot is afraid of a spin so long as he has enough height. Modern machines,

indeed, are so inherently stable that it is often difficult to make them go into a spin, and even when this has been done the machine will normally recover automatically and go into a straight dive as soon as all the controls are put in the neutral position. The spinning aeroplane may lose from 300 to 600 ft. in one turn, and therefore it is absolutely essential that we should have an altitude of at least 2,000 ft. before commencing this stunt. At this height there is no danger at all.

How to Get Out of a Spin

Having climbed to a sufficient height we will commence our spin. To begin with we reduce the throttle until the air speed indicator shows that we are approaching stalling speed, and then we pull back the stick, thus causing the nose to rise and the machine to stall, as explained at the beginning of this Manual. Then, in order to put the machine into a spin, we put on either right or left rudder, according to the direction in which we wish to turn. Having produced the

spin and passed through a few turns we neutralise the controls and the machine goes into a normal straight dive, from which we pull it out gradually. The first spin is usually both alarming and uncomfortable, but after a few experiences the unpleasant sensations pass off and we do not think much about it.

The reverse of spinning is the upward spin, which consists of making the aeroplane "corkscrew" as it climbs vertically. Having gained sufficient altitude we dive steeply with the engine running and then pull the stick back until the aeroplane is climbing almost vertically. The aeroplane is then rolled and when we have climbed high enough, we straighten out. This is a good method of gaining altitude, although in order to carry out the manoeuvre really effectively a very powerful engine is required.

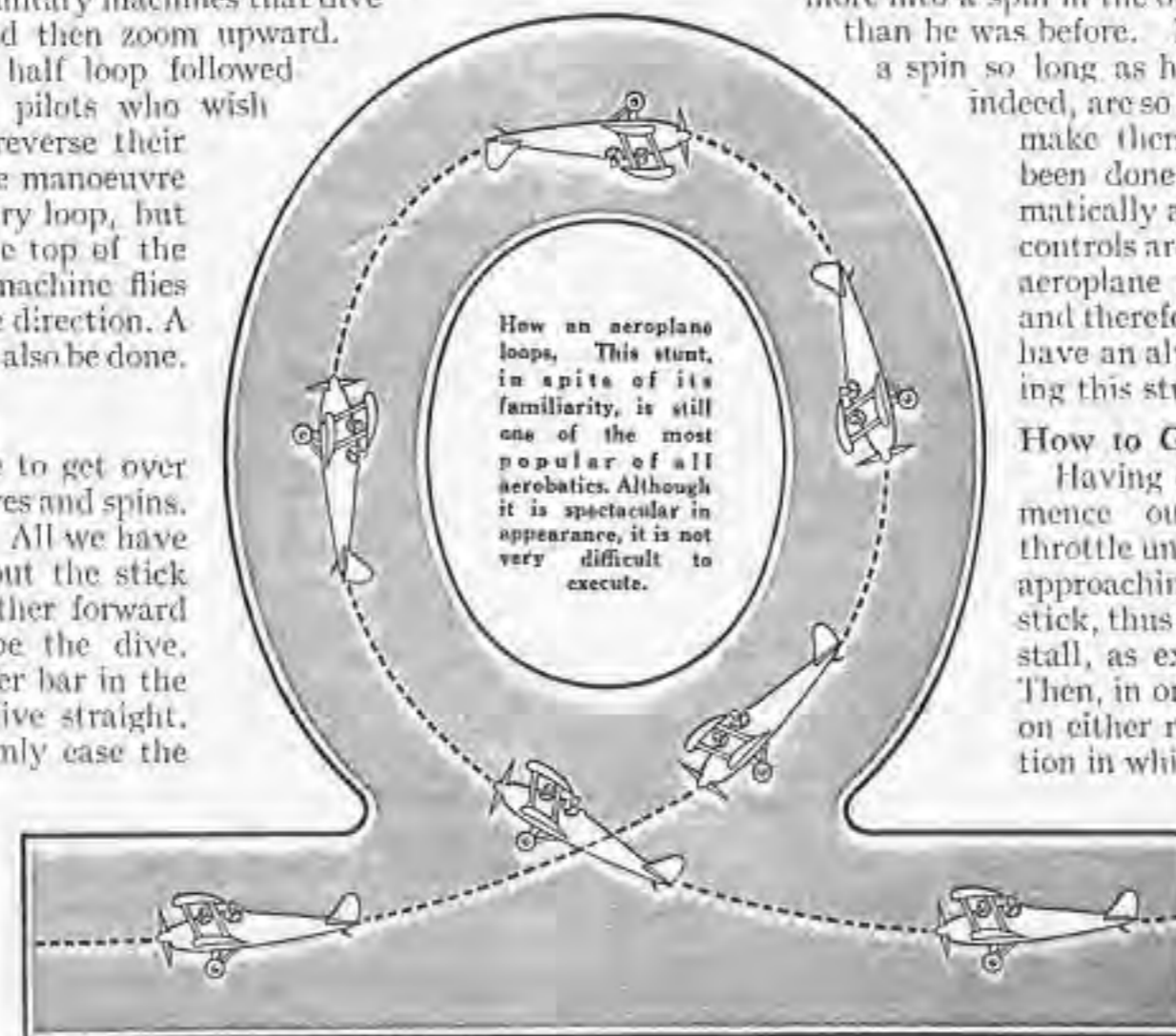

It is a remarkable fact that the most spectacular aerial stunts are often the simplest to perform, and the "falling leaf" is a good example of this. For some reason or other the manoeuvre is not very frequently executed, although it never fails to impress those who witness it for the first time and have no idea as to how the pilot throws his machine about. It is illustrated on the next page.

The Spectacular "Falling Leaf"

Height is lost rapidly in doing the falling leaf, and so it is necessary to be fairly high up before we start. Pulling the stick back and opening up the throttle, we climb to the desired height, when we fly level once more and shut off the engine. Back goes the stick and the aeroplane stalls; and at this point we tip it over to one side with the ailerons, and then immediately apply aileron and rudder in the opposite direction. We continue in our original direction until the machine is just a little past vertical, when it begins to swing back to the side against which the controls are held. Immediately we move the controls over to the opposite side and repeat the sequence of operations. At each bank the aeroplane is really just on the point of spinning, but at the critical moment the spin is checked, principally by the rudder.

It is an interesting fact that the best machine for general purpose flying is not the best in which to carry out this manoeuvre. The reason for this is that aeroplanes used for ordinary flying are very stable and under normal conditions are capable of flying for long periods when the pilot has hands and feet off the controls. In other words they are slow on the controls and the falling leaf is best carried out on a machine with very sensitive controls, such as a single-seater fighter.

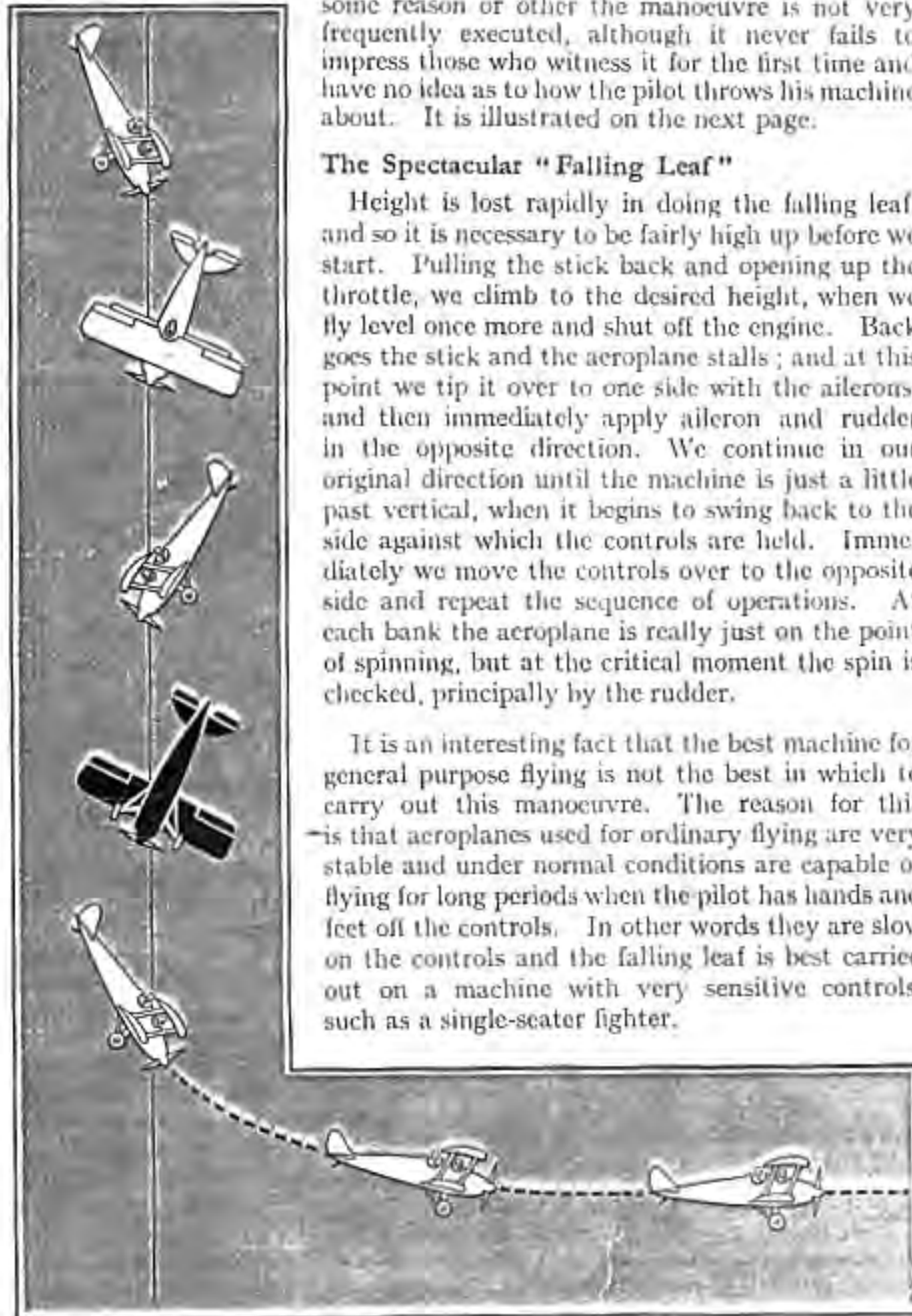
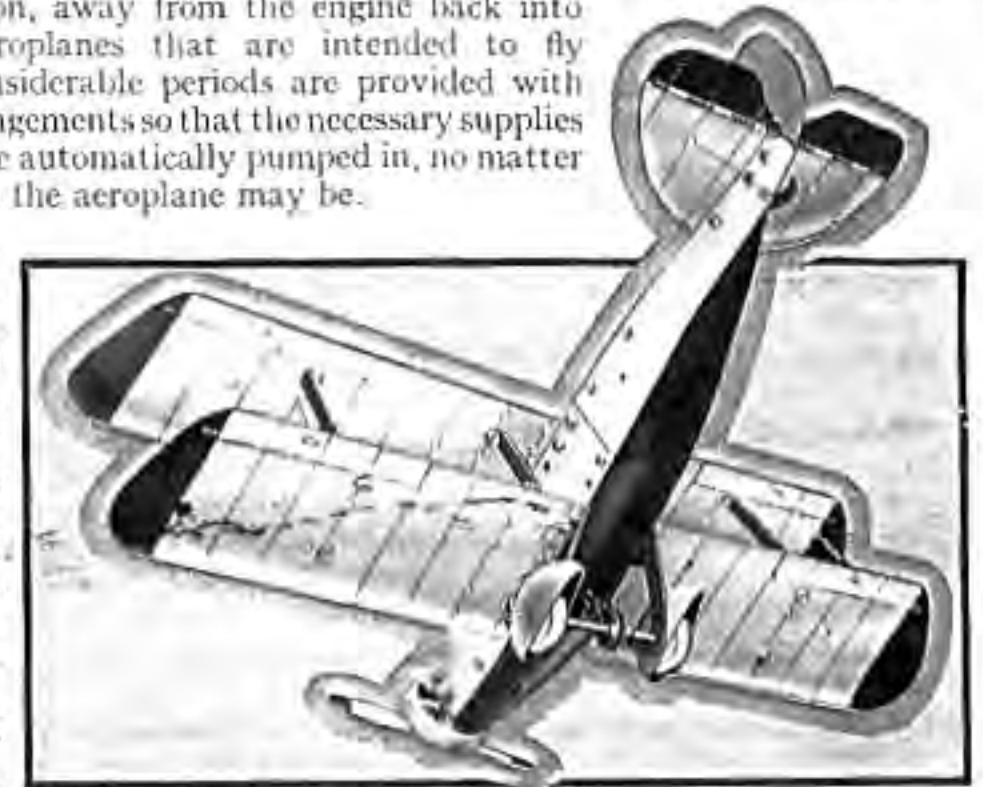

Diagram showing a spinning aeroplane (1) (2) (3) (4) (5) levelled into straight flight after coming out of the spin.

To finish our short display of aerobatics we will do a little inverted flying. We have, of course, already experienced the sensation of being upside down in an aeroplane, when we were rolling, and also when we were half-way through the loop. In order to get into position for flying upside down we make a half roll. When in this position, strangely enough, we do not feel that we are upside down, but rather that the earth has changed places with the sky and is above our heads! If we wish to fly inverted for any length of time the engine must be provided with special lubricating and fuel systems or it will very quickly "seize up." The reason for this is that the oil and petrol are usually fed to the engine by gravity, and consequently when the aeroplane is upside down they drain in the opposite direction, away from the engine back into the tanks. Aeroplanes that are intended to fly inverted for considerable periods are provided with special feed arrangements so that the necessary supplies of fuel and oil are automatically pumped in, no matter in what position the aeroplane may be.

It is necessary to be an expert pilot, to be in the best of training, and to be securely strapped in the aeroplane, in order to fly upside down for long. The ordinary safety belt is of no use, and proper shoulder straps must be used.



A Meccano Special aeroplane in a spinning position.

These straps are secured to the longerons, or the main longitudinal "girders" of the machine, and are fixed on to the shoulders and thighs as tightly as possible, so that when they are in position the airman cannot lift from his seat or slide his hips forward. The world's best exhibition of inverted flying is probably that given every year at the Royal Air Force Display at Hendon, and everyone who is at all interested in aviation should see this pageant at least once, for it is a unique display of flying. For instance, five machines flown by pilots from the Central Flying School fly upside down in perfect formation. Four then half roll to normal positions and the flight proceeds with the leading machine upside down.

Formation Flying in the Royal Air Force

The Display includes also wonderful demonstrations of formation flying, which plays an extremely important part in the training carried out in the R.A.F. The simplest formation is known as a "Flight." This may consist of three, four or five machines, although usually the number is five except in the case of bomber squadrons, when there are normally three aeroplanes. The machines



The upward spin, which is the reverse of the manoeuvre illustrated on the previous page.

of a Flight arrange themselves in the form of an inverted "V" with the leader of the Flight at the head. His machine can be distinguished from the others by the fact that it has a short streamer attached to the rudder. There are normally three Flights to every Squadron and it is customary for these to fly in what is known as Squadron Formation, which means that two Flights, each of five machines as just described, are situated behind and one on each side of the first Flight. The aeroplane in the very front of the Squadron is flown by the Squadron Leader, whose machine can always be picked out because streamers are attached to the tail and also to the wing tips.

More Interesting Formations

At times it is desirable for machines flying in this formation to break it and adopt another. The most common formation is known as the Squadron "V" or "Vic", when the whole fifteen machines form one big "V", still with the Squadron Leader in the front. In this position they are all out of each other's slipstreams, but each has a good all round view. Other formations are Line Abreast, which means that all the aeroplanes arrange themselves side by side; and Line Astern, when they are one behind the other. When these are carried out with the aeroplanes rising in steps, they are known as "echelon" formations.

It is now time to make our way back to the aerodrome, and we will do this by identifying landmarks that we pick out on the map. Navigation is not quite so simple as this in bad weather, however, and a special course of training, known as the Blind Flying Course, has been developed to enable pilots to fly with safety in fog or clouds. As we approach the aerodrome we may possibly see a machine in which blind flying training is being carried out. It will be easily distinguishable owing to the fact that a hood will be erected over the rear cockpit. This hood is made so that a faint light can penetrate it as it is found that this reproduces more closely the normal effect of fog or cloud than if the pilot sits in complete darkness, but for illuminated instruments.

When flying under normal conditions the pilot of an aeroplane does not usually pay a great deal of attention to his instrument board, although of course he glances at intervals at his airspeed indicator, revolution indicator, and altimeter. When a flight is being made blind, however, all the pilot's normal flying senses are completely at fault, and therefore he has to rely entirely on his instruments. In addition to those just mentioned there are others of special importance. The turn and bank indicator shows when the machine is turning and banking, and the latest type of this instrument indicates also when it is side-slipping; and the pitch indicator shows if the nose of the machine is pointing upward or downward. At first a pilot finds it difficult to ignore his instincts and trust entirely to the indications of the instruments, but in a short time he does this automatically.

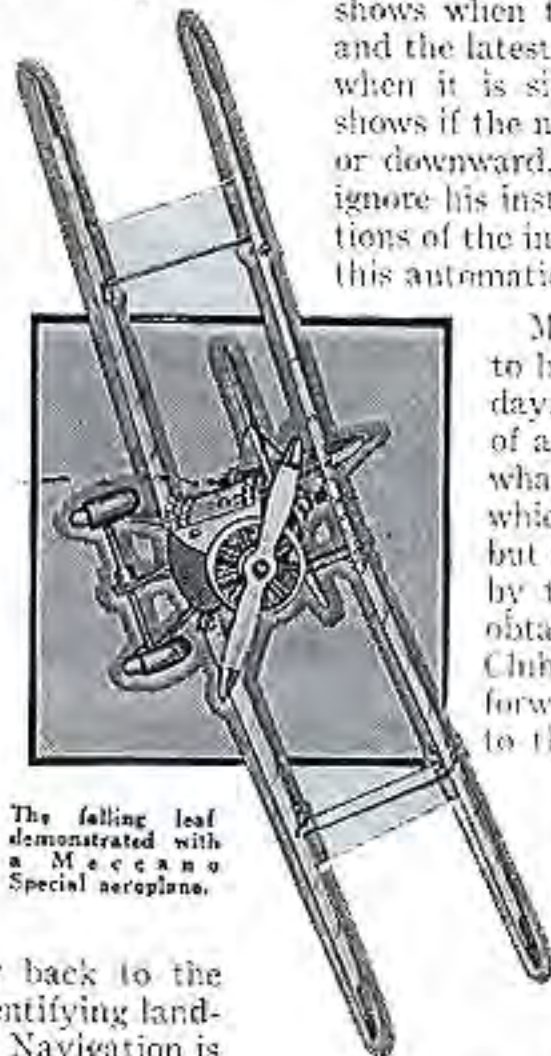

The falling leaf demonstrated with a Meccano Special aeroplane.

Many readers of this Manual will hope to become qualified aeroplane pilots some day. In order to be allowed to take charge of an aeroplane it is necessary to obtain what is known as the "A" Pilots' Licence, which allows holders to fly for pleasure, but not for profit. The licence is issued by the Air Ministry, and the method of obtaining it is first to take the Royal Aero Club Aviator's Certificate, and then to forward this, together with an application, to the Air Ministry. In order to secure the R.A.C. Certificate it is necessary to be at least 17 years of age, to have flown solo for a minimum of three hours, and to answer satisfactorily about 60 questions dealing with international rules regulating air traffic. In addition, a number of elementary flying tests must be passed.

These include a flight during which a height of 6,000 ft. must be attained, followed by a glide to land, and a flight around two marks, making a series of five figure-of-eight turns at a height of not more than 600 ft.

The End of Our Flight

On arrival over the aerodrome we first ascertain, by means of the wind stocking, the direction of the wind, as this may have changed, and then, with the nose of the machine pointing straight on, the wind, glide down and make a three-pointing. So on the way down.



The falling leaf, shown in this diagram, is a very spectacular manoeuvre.

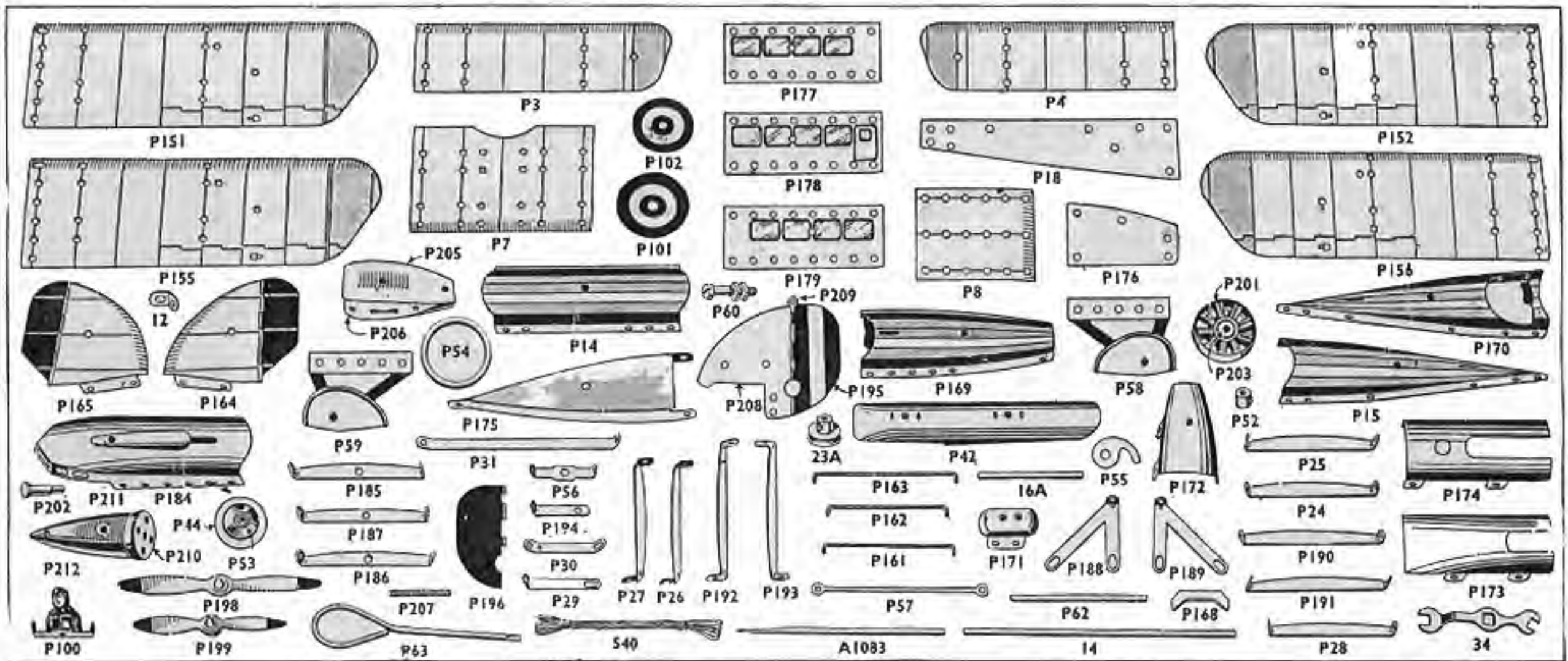

LIST OF PARTS FOR SPECIAL AEROPLANE OUTFITS

No.	Description.	Outfit Contents.		
		IS	IAS	25
P3	Mainplane—small, R.H.	1	1	1
P4	“ “ “ “ L.H.	1	1	1
P7	Centre Section Plane	1	1	1
P8	Extension Plane	1	1	1
P14	Fuselage Top, Middle	1	1	1
P15	“ “ “ “ Rear	1	1	1
P18	“ “ “ “ Side	1	1	1
P21	Interplane Strut, Staggered, R.H.	1	1	1
P25	“ “ “ “ L.H.	1	1	1
P28	“ “ “ “ Angled, R.H.	1	1	1
P27	“ “ “ “ L.H.	1	1	1
P24	“ “ “ “ Straight	4	4	4
P29	Centre Section Strut	4	4	4
P30	Float and Centre Section Strut	4	4	4
P31	Wing Stay	4	4	4
P42	Float—Complete	1	1	1
P44	Tyre	1	1	1
P52	Collar	1	1	1
P53	Wheel (Disc Type)	1	1	1
P54	Driving Band	1	1	1
P55	Tail Skid—Fixed Type	1	1	1
P56	Rear Bracket for Propeller Shaft	1	1	1
P57	Tie-Rod for Float	1	1	1
P58	Undercarriage and Wheel Shield, R.H.	1	1	1
P59	“ “ “ “ L.H.	1	1	1
P90	Pivot Bolt with 2 Nuts	1	1	1
P62	Axle Rod— $\frac{3}{4}$ " long	1	1	1
P63	Screwdriver	1	1	1
P100	Pilot	1	1	1
P101	Identification Disc, large	1	1	1

No.	Description.	Outfit Contents.		
		IS	IAS	25
P102	Identification Disc, small	1	1	1
P151	Mainplane—R.H., Top	1	1	1
P152	“ “ “ “ L.H., Top	1	1	1
P155	“ “ “ “ R.H., Bottom	1	1	1
P156	“ “ “ “ L.H., Bottom	1	1	1
P161	Alloyon Connecting Wire, medium	2	2	2
P162	“ “ “ “ short	2	2	2
P163	“ “ “ “ long	2	2	2
P164	Tail Plane and Elevator, R.H.	1	1	1
P165	“ “ “ “ L.H.	1	1	1
P168	Elevator Coupling Piece	1	1	1
P169	Fuselage Top, Front	1	1	1
P170	“ “ “ “ Rear, with Cockpit	1	1	1
P171	“ “ “ “ Front	1	1	1
P172	“ “ “ “ Underside—Front	1	1	1
P173	“ “ “ “ Middle	1	1	1
P174	“ “ “ “ Extension	1	1	1
P175	“ “ “ “ Rear End	1	1	1
P176	“ “ “ “ Side—Front	2	2	2
P177	“ “ “ “ Middle, L.H., Front	1	1	1
P178	“ “ “ “ L.H., Rear	1	1	1
P179	“ “ “ “ R.H.	1	1	1
P184	Cabin Head	1	1	1
P185	Interplane Strut—Staggered, R.H., Pierced	1	1	1
P186	“ “ “ “ L.H.	1	1	1
P187	“ “ “ “ Straight, Pierced	1	1	1
P188	“ V ” Type Cross Strut—R.H.	1	1	1
P189	“ “ “ “ L.H.	1	1	1
P190	Cross Strut—R.H., Staggered	4	4	4
P191	“ “ “ “ L.H.	4	4	4

No.	Description.	Outfit Contents.		
		IS	IAS	25
P192	Cross Strut—R.H., Angled	1	1	1
P193	“ “ “ “ L.H.	1	1	1
P194	Strut for Nacelle	1	1	1
P195	Rudder, Military	1	1	1
P196	“ “ “ “ Commercial	1	1	1
P198	Large Air-Screw	1	1	1
P199	Small	1	1	1
P201	Townard Ring	1	1	1
P202	Axis Pin for Propeller and Radial Engine	1	1	1
P203	Radial Engine, small	1	1	1
P205	Engine Casing Top	1	1	1
P206	Engine Casing Base	1	1	1
P207	Screwed Rod— $\frac{1}{4}$ " long	1	1	1
P208	Pin	1	1	1
P209	Rudder Pin	1	1	1
P210	Nacelle Front	1	1	1
P211	“ “ Side	1	1	1
P212	“ “ “ “ with Pin	1	1	1
P225	Manual of Instructions	1	1	1
A1083	Drift	1	1	1
12	Angle Bracket— $1 \times \frac{1}{4}$ "	4	4	4
14	Axle Rod— $\frac{3}{4}$ " long	1	1	1
16A	“ “ “ “ $\frac{1}{4}$ "	1	1	1
28A	Fast Pulley— $\frac{1}{4}$ " diam.	2	2	2
34	Spanner	1	1	1
38	Washers	4	4	4
587A	Nuts	40	40	40
587B	Bolts— $\frac{1}{4}$ " long	40	40	40
540	Hank of Cord	1	1	1
611C	Bolt, $\frac{1}{4}$ "	2	2	2

MECCANO LIMITED

BINNS ROAD

LIVERPOOL 13