

MECCANO

TRADE MARKS 296321, 501113, 76, 12633, 10274, 55/13476, 569/13, 884/25, 2913, 80, 124, 336, 4174, 91637, 83171, 157149, 32822, 200639, 209733, 214061, 214062, 12892, 29094, 33316, 1818, 16737, 333/13, 5848, 50204, 10/12258, 22826, 13932, 20063/925, 9048, 5549, 2139, 16900, 72286, 2339, 41812, 5403, 7315, 13086 139420, 494933-4-5-6, 29041, 28377, 6595, 404713, 410379, 55096, 12240 41234, 8223, 1855.

HORNBY'S ORIGINAL SYSTEM—FIRST PATENTED 1901

INSTRUCTIONS

FOR OUTFIT

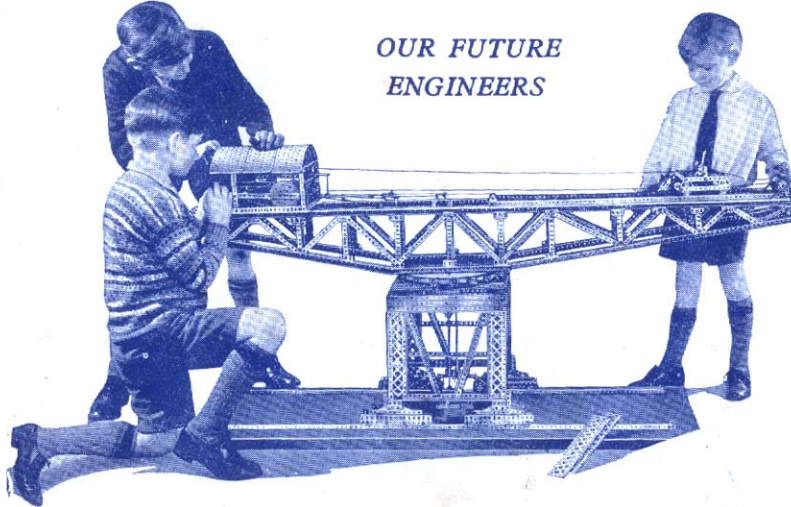
No. 00

Copyright by MECCANO LIMITED, LIVERPOOL, ENGLAND

No. 35.00

AUS./Ex.

OUR FUTURE
ENGINEERS



A TALK WITH NEW MECCANO BOYS

The Meccano No. 000 and 00 Outfits are the first steps in the Meccano system. After you have made all the models shown in this Manual you will want to build bigger models and you can do this by adding new parts to your Outfit or, by purchasing a No. 00a Accessory Outfit, you can convert your No. 00 into a No. 0 Outfit. You will then be able to build many more models, including larger and better Cranes, Bridges, Wagons, Trucks, Windmills, etc.

HOW TO BUILD WITH MECCANO

First build the models exactly as they are illustrated in the Manual, and then take each model and try to improve on our design. Every one can be made in a dozen different ways. Screw up all the nuts and bolts tightly to ensure that your models will be strong and firm when they are completed

MECCANO ACCESSORY OUTFITS

It is important to remember that each Outfit (with the exception of Outfit No. 000) may be converted into the one next higher by means of an Accessory Outfit. Your No. 00 Outfit is converted into a No. 0 Outfit by adding to it a No. 00a. A No. 0a will then convert it into a No. 1 and so on. As you progress in Meccano you obtain a greater variety of perfectly-made engineering parts—Gear Wheels, Pulley Wheels, Worm Wheels, Couplings, Cranks, and many others. These enable you to construct complicated mechanical movements without any difficulty. The most wonderful feature about Meccano is that it is *real engineering*: it is a fascinating and delightful hobby, and yet so simple that even an inexperienced boy may join in the fun without first having to study or learn anything.

THE LIFE OF A MECCANO BOY

A Meccano boy is the happiest boy in the world. He builds models from the Meccano Instruction books; invents new models; enters the Competitions that are always being held in connection with the hobby; joins the Meccano Guild and a Meccano Club, and by wearing the Guild badge proclaims himself to be the friend of millions of other Meccano boys all over the world. Time never hangs heavily on his hands and he is too busy and too happy to grumble. He reads the "Meccano Magazine" regularly and corresponds with his friend the Editor when he feels like it.

If you are not already a reader of the "Meccano Magazine," write to the Editor, Binns Road, Liverpool 13, England, for full particulars of the current subscription rates. If you prefer to do so, you may order the Magazine from your Meccano dealer or from any newsagent or bookstall.

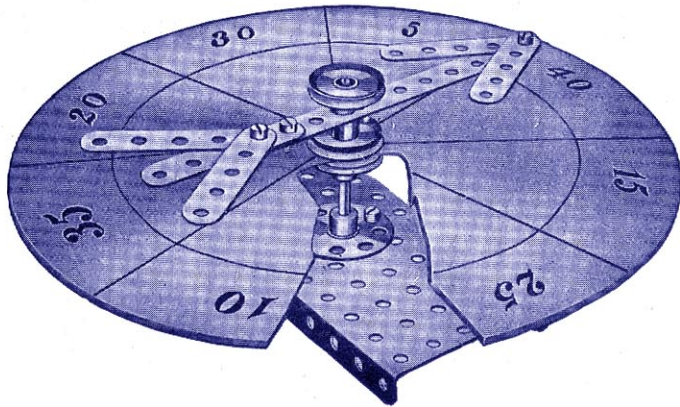
MECCANO SERVICE

The service of Meccano does not end with selling an Outfit and an Instruction Manual. When you want to know something more about engineering than is now shown in our books, or when you strike a tough problem of any kind, write to us. We receive over 200 letters from boys every day all the year round. Some write to us because they are in difficulty, others because they want advice on their work or pleasures, or about their choice of a career. Others, again, write to us just because they like to do so, and we are glad to know that they regard us as their friends.

Although all kinds of queries are put to us on all manner of subjects, the main interest is, of course, engineering. No one has such a wonderful knowledge of engineering matters as that possessed by our staff of experts. This vast store of knowledge, gained only by hard-earned experience, is at your service.

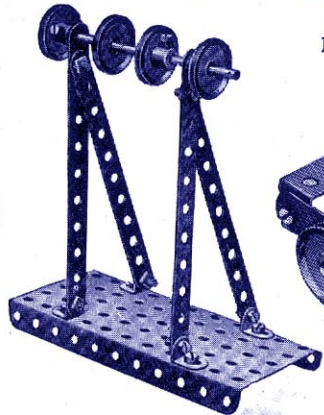
All these Models can be built with MECCANO Outfit No. 00

Model No.00.6 Roulette Wheel

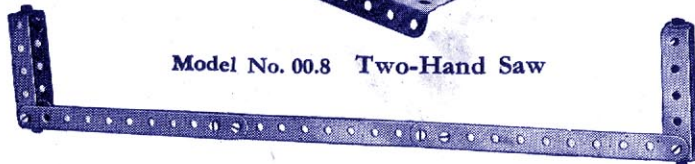


Cut out a circular piece of cardboard, and mark as shown to form scoring board. This is clamped between two 1" Pulley Wheels. The pointer revolves freely on the upright spindle and is held in position by another 1" Pulley Wheel.

Model No. 00.7 Pulley Shafting



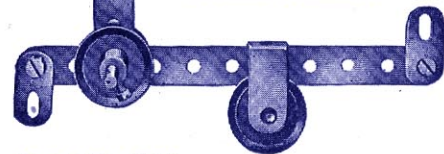
Model No. 00.8 Two-Hand Saw



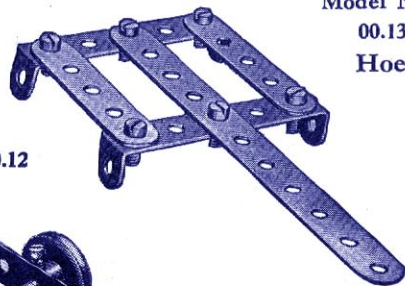
Model No. 00.9 Coat Hanger



Model No. 00.10 Roman Balance



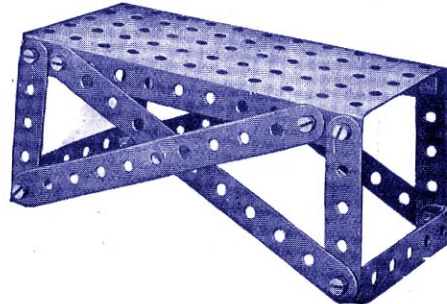
Model No. 00.11 Grill



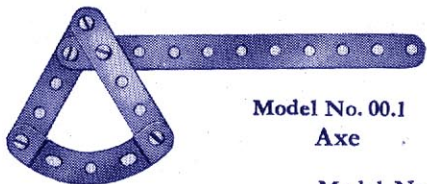
Model No. 00.13 Hoe



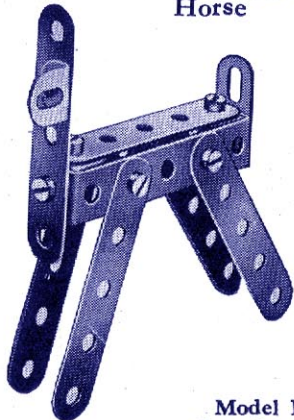
Model No. 00.14 Planing Bench



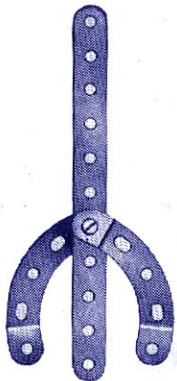
Model No. 00.1 Axe



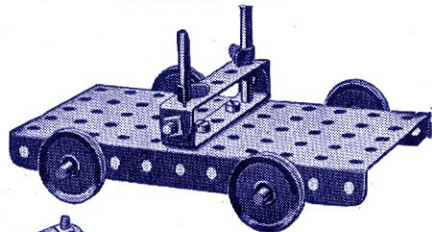
Model No. 00.3 Horse



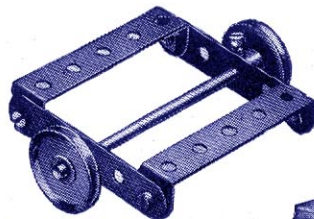
Model No. 00.2 Fork



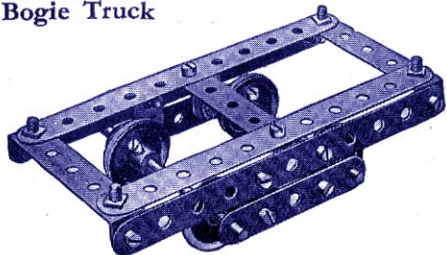
Model No. 00.5 Lumber Truck



Model No. 00.12 Trolley

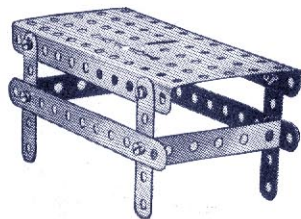


Model No. 00.4 Bogie Truck



All these Models can be built with MECCANO Outfit No. 00

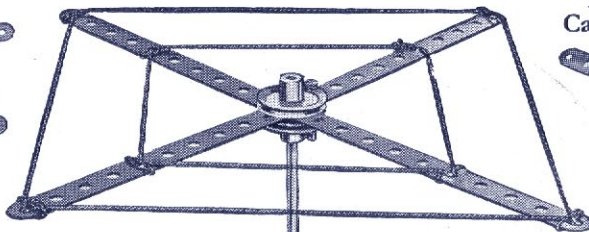
Model No. 00.15
Table



Model, No. 00.17
Dividers



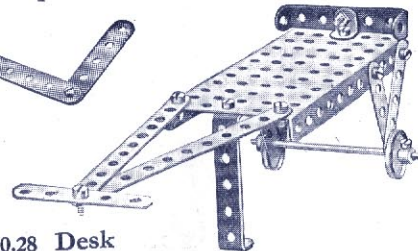
Model No. 00.22 Clothes Hanger



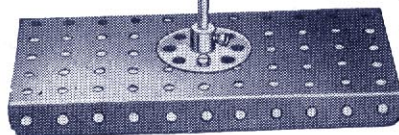
Model No. 00.26
Carpenter's Square



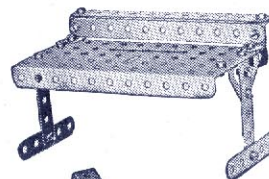
Model No. 00.27
Shipyard Bogie



Model No. 00.18
Bench



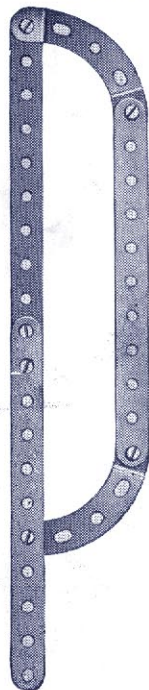
Model No. 00.28 Desk



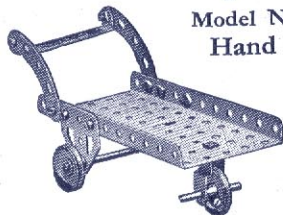
Model No. 00.29
Farm Sight



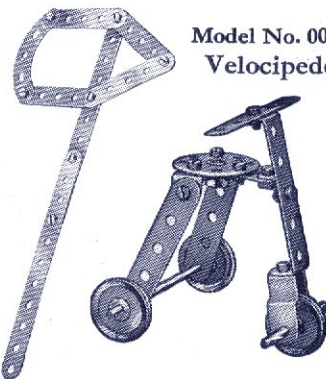
Model No. 00.16
Meat Saw



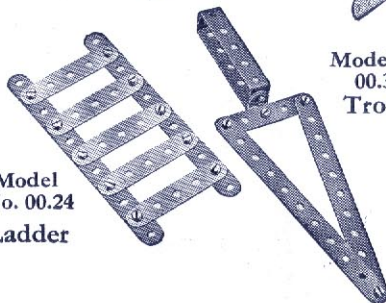
Model No. 00.19
Hand Cart



Model No. 00.23
Velocipede



Model No. 00.30
Trowel



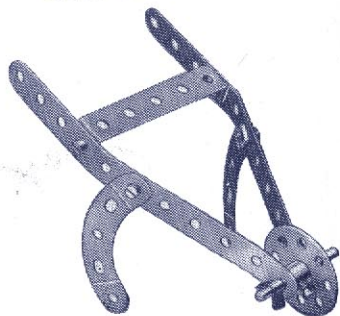
Model
No. 00.21
Fire-Axe



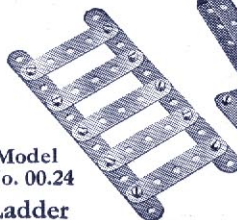
Model No. 00.32
Rifle with
Bayonet



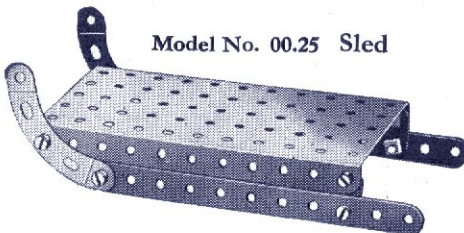
Model No. 00.20
Scarifier



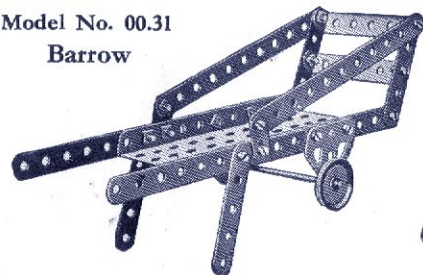
Model
No. 00.24
Ladder



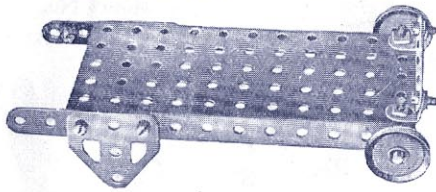
Model No. 00.25 Sled



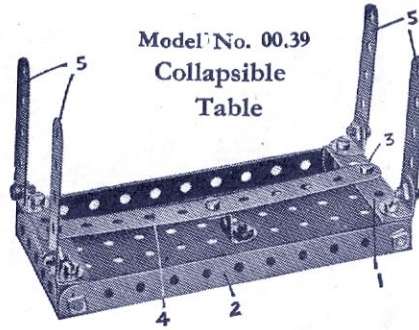
Model No. 00.31
Barrow



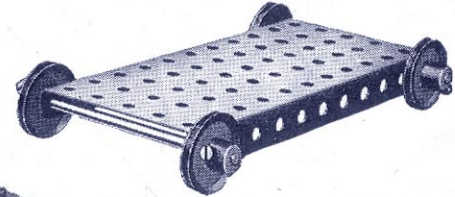
Model No. 00.33 Flat Truck



Model No. 00.39 Collapsible Table



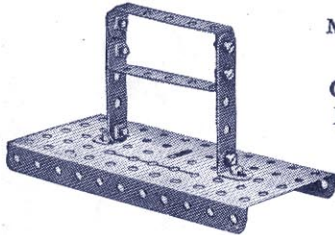
Model No. 00.41 Trolley



Model No. 00.34 Spade

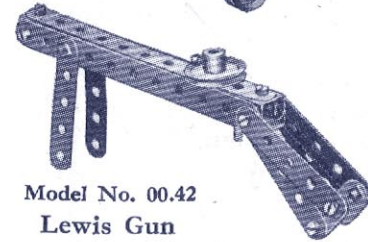


Model No. 00.35 Cement Marker



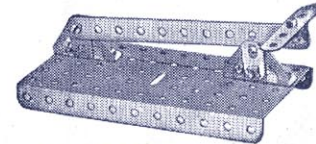
The Double Angle Strips 1 are attached to the Flanged Plate 2 by lock-nutted Bolts. The Bolts 3 are secured to the 5 1/2 Strip 4 and their shanks engage with the centre holes in the 2 1/2 x 1/2 Double Angle Strips 1, thus maintaining the legs 5 in an upright position. When it is desired to fold up the legs 5, it is only necessary to raise the ends of the Strip 4, thus freeing the Double Angle Strips 1. The table is shown in the folded position in Fig. 00.39A.

Model No. 00.46 Potato Chopper



Model No. 00.42 Lewis Gun

Model No. 00.43 Switch

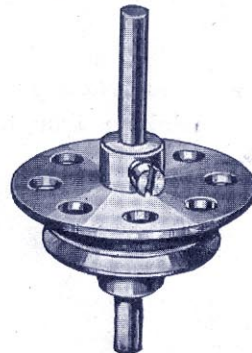


Model No. 00.36 Motor Boat

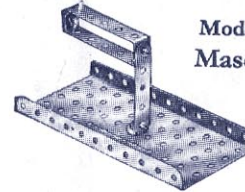


FIG. 00.39A

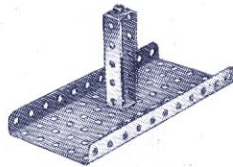
Model No. 00.40 Spinning Top



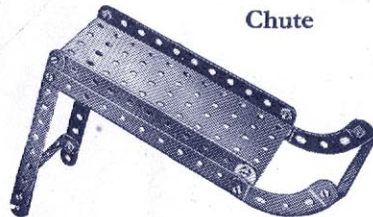
Model No. 00.44 Mason's Trowel



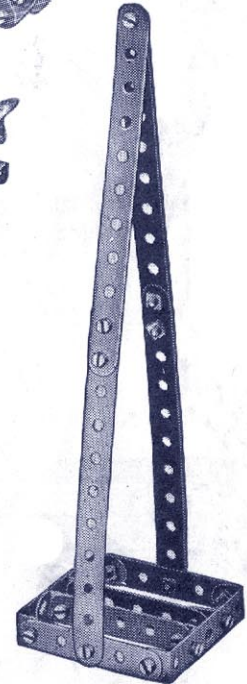
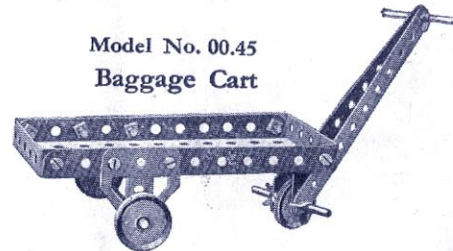
Model No. 00.37 Plasterer's Hawk



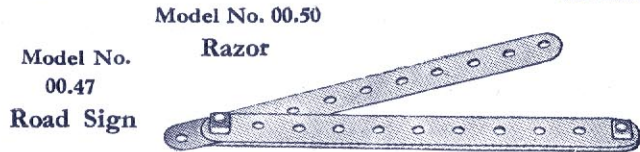
Model No. 00.38 Chute



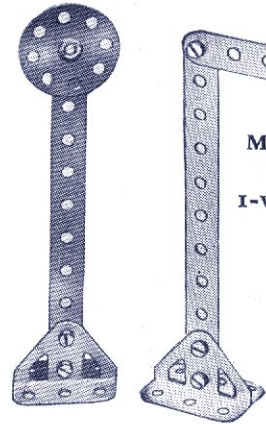
Model No. 00.45 Baggage Cart



All these Models can be built with MECCANO Outfit No. 00



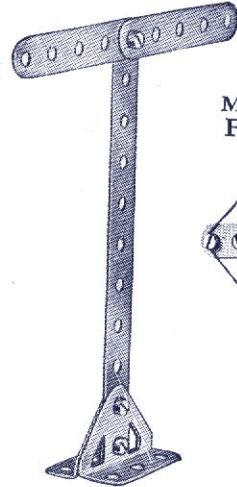
Model No. 00.47
Road Sign



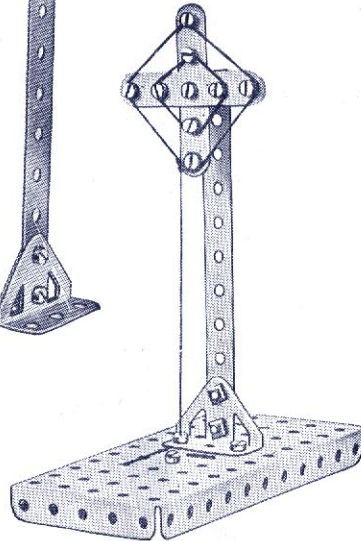
Model No. 00.52
2-way Sign Post



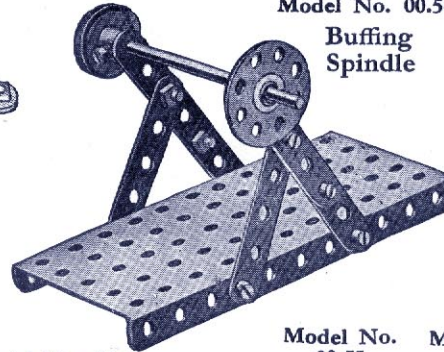
Model No. 00.51
1-way Sign Post



Model No. 00.53
Frame Aerial



Model No. 00.54
Buffing Spindle



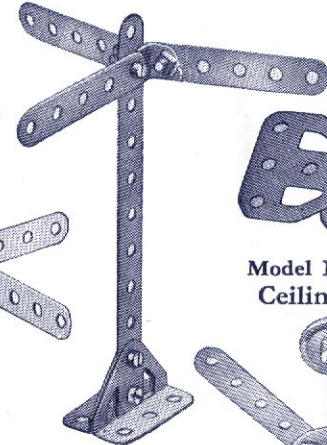
Model No. 00.58 Tweezers



Model No. 00.60
Battle Axe



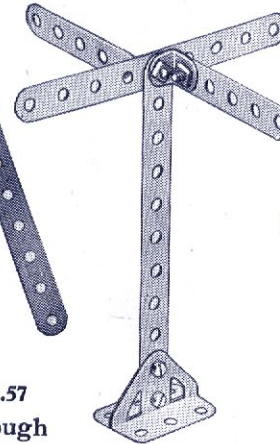
Model No. 00.59
3-way Road Sign



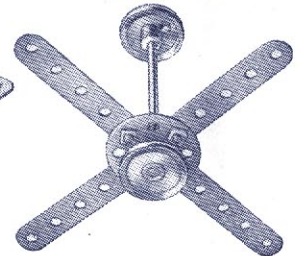
Model No. 00.55
Dividers



Model No. 00.56
4-way Road Sign



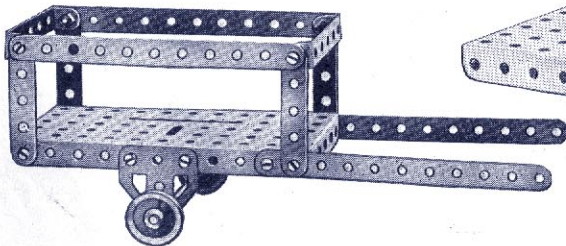
Model No. 00.61
Ceiling Fan



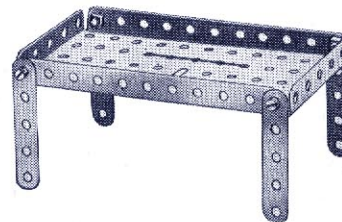
Model No. 00.48
Glider



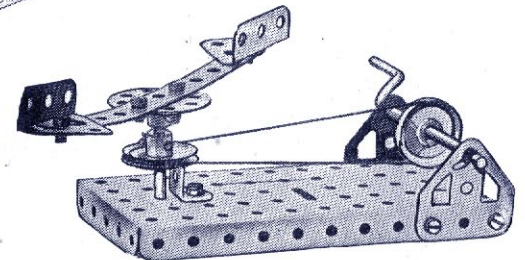
Model No. 00.49
Cart



Model No. 00.57
Drinking Trough



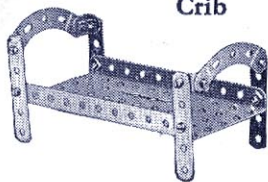
Model No. 00.62
Roundabout



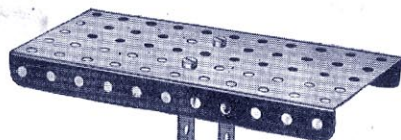
Model No. 00.63
Grandfather's Clock



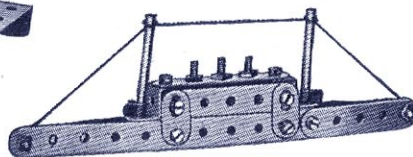
Model No. 00.66
Crib



Model No. 00.70 Table



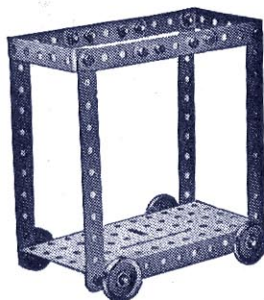
Model No. 00.72
Liner



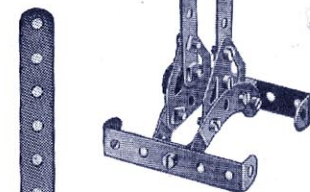
Model No. 00.75
Mail Bag
Hanger



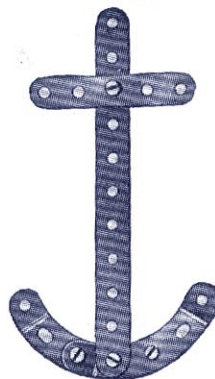
Model No. 00.67
Refreshment Wagon



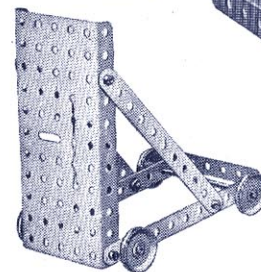
Model
No. 00.68
Rake



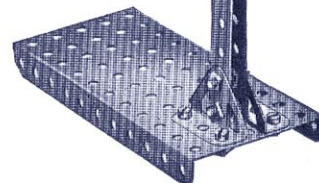
Model No. 00.73
Anchor



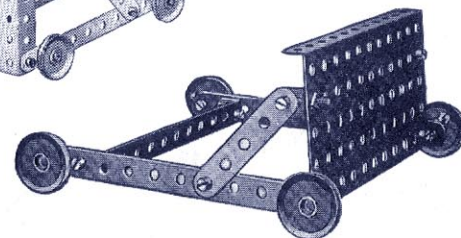
Model No. 00.74
Gravel Sifter



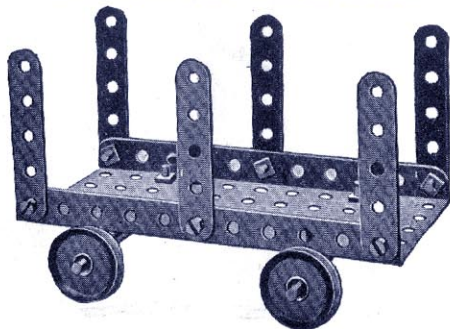
Model No. 00.76
Devil Wall



Model No. 00.64
Tin Opener



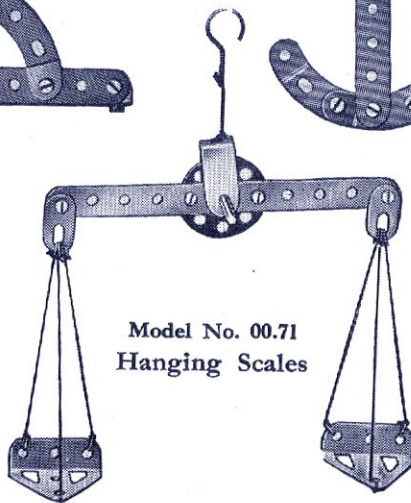
Model No. 00.65 Timber Truck



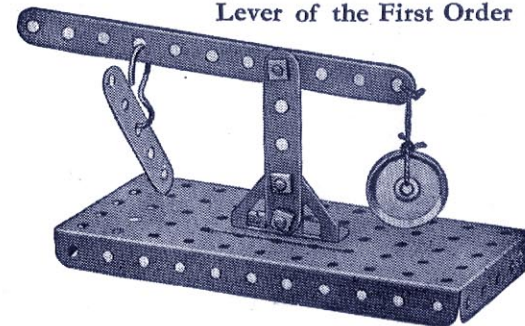
Model
No. 00.69
Stool



Model No. 00.71
Hanging Scales

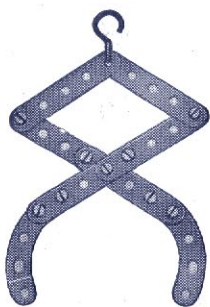


Model No. 00.77
Lever of the First Order

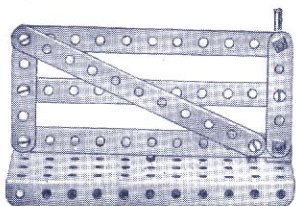


All these Models can be built with MECCANO Outfit No. 00

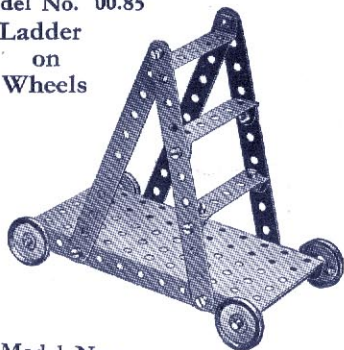
Model No. 00.78
Friction Grip
Tongs



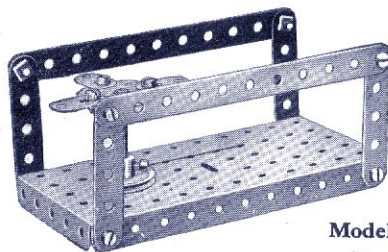
Model No. 00.80 Gate



Model No. 00.85
Ladder
on
Wheels



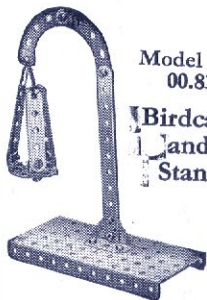
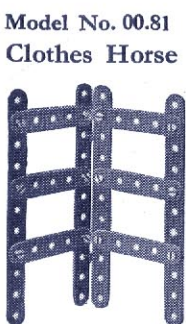
Model No. 00.87 Turnstile



Model No. 00.92 Violin

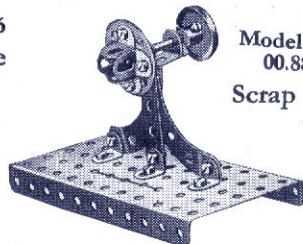
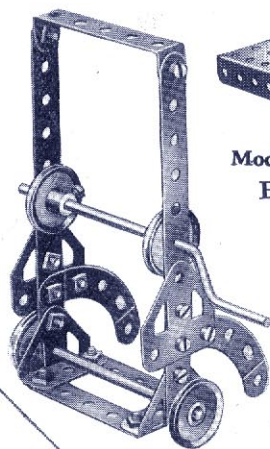


Model No. 00.81
Clothes Horse



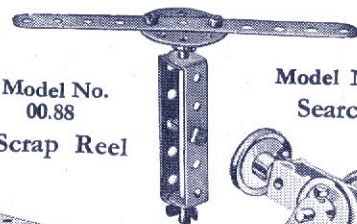
Model No.
00.83
Birdcage
Stand

Model No. 00.86
Garden Hose
Reel

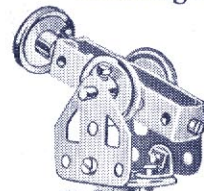


Model No.
00.88
Scrap Reel

Model No. 00.89
Propeller



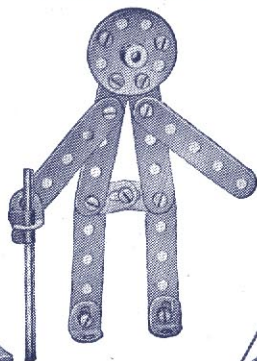
Model No. 00.93
Searchlight



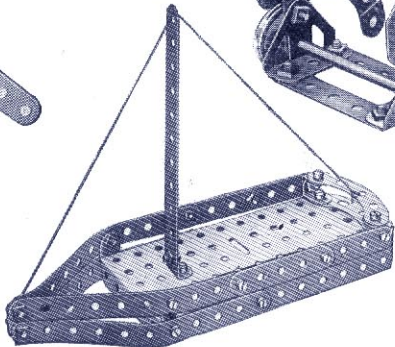
Model No. 00.79
Telegraph Pole



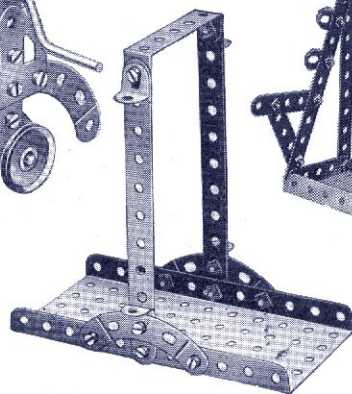
Model No. 00.82
Meccano Man



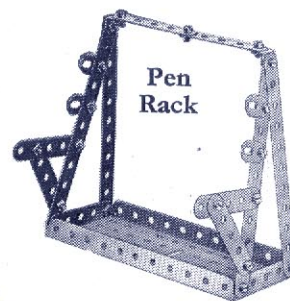
Model No.
00.84
Barge



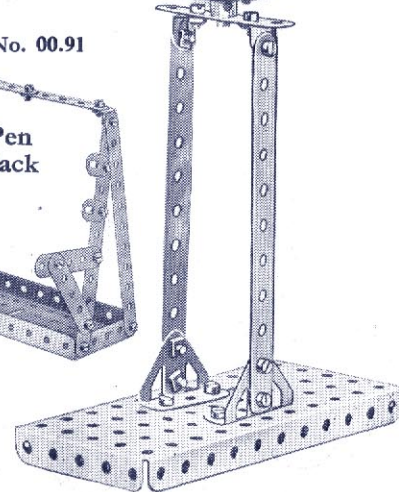
Model No. 00.90
Elevator
Car



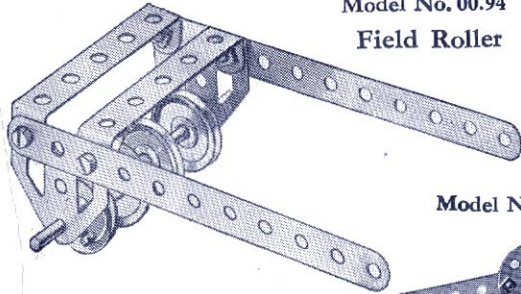
Model No. 00.91



Pen
Rack



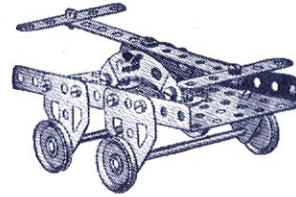
Model No. 00.94
Field Roller



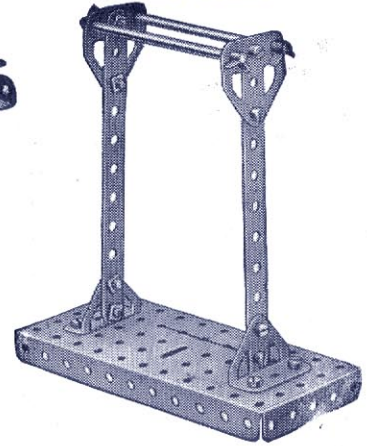
Model No. 00.100 Magic Plate

The cord is wound once round a 2" Axle Rod that is journalled in a Flat Bracket and a 1/2" Reversed Angle Bracket, which are bolted to the Plate. If the cord is held loosely the plate will drop, but as soon as the cord is tightened the plate becomes immovable.

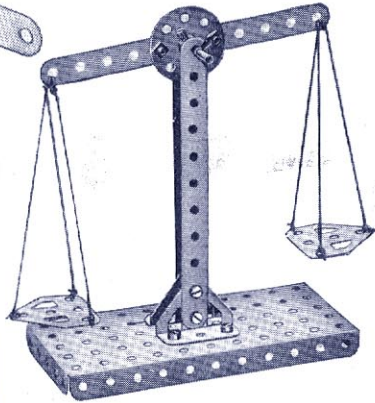
Model No. 00.101
Hand Car



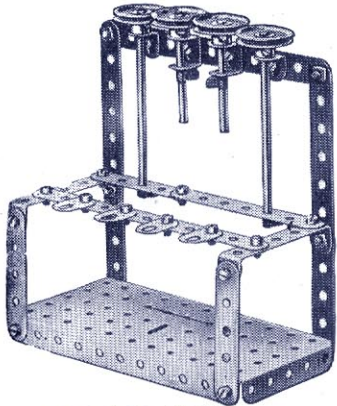
Model No. 00.104
Towel Horse



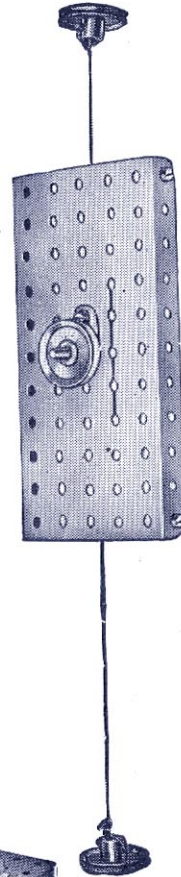
Model No. 00.97 Scales



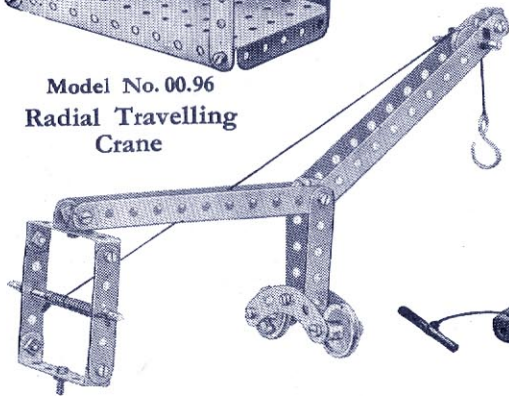
Model No. 00.95
Organ



Model No. 00.98
Book End



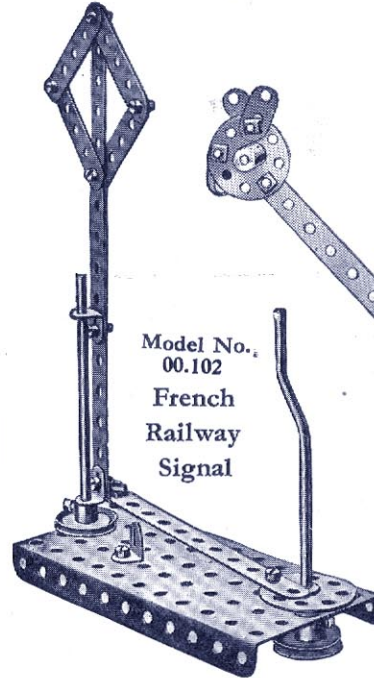
Model No. 00.96
Radial Travelling
Crane



Model No. 00.99
Cheese Cutter



Model No. 00.102
French
Railway
Signal



Model No. 00.105,
Prehistoric Bird

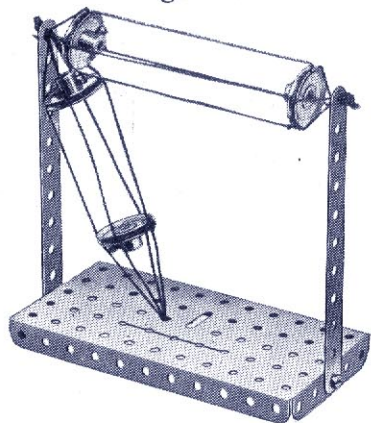


Model No. 00.103 Cannon

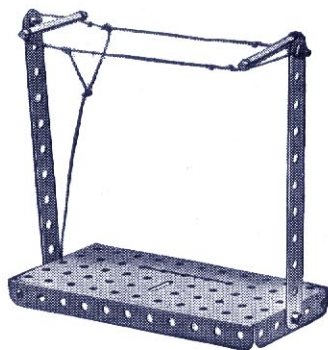


All these Models can be built with MECCANO Outfit No. 00

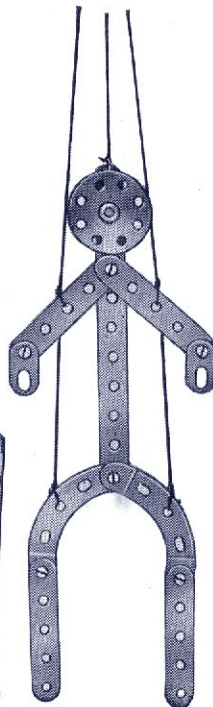
Model No. 00.106
Cage Aerial



Model No. 00.108
Double Wire L Aerial



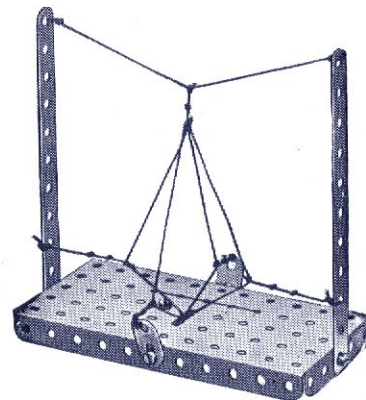
Model No. 00.110
Jumping Jack



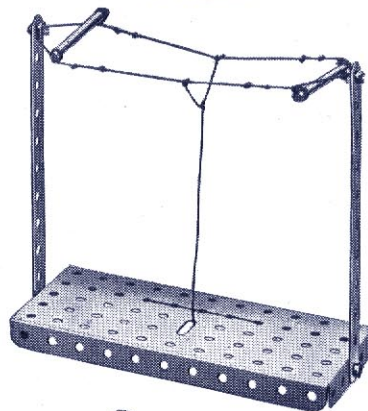
Model No. 00.112
Single Wire
T Aerial



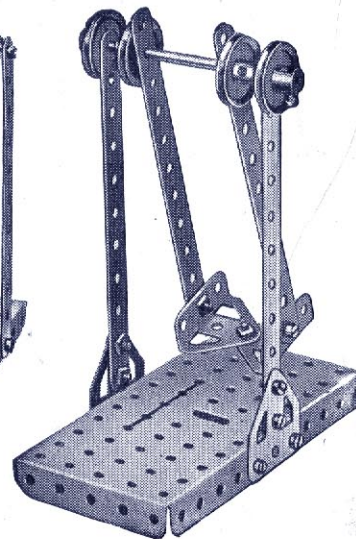
Model No. 00.114
Direction Aerial



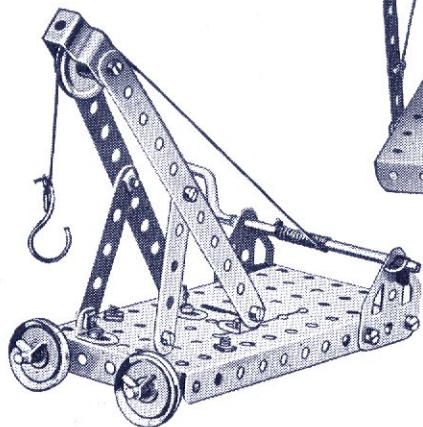
Model No. 00.113
Double Wire
T Aerial



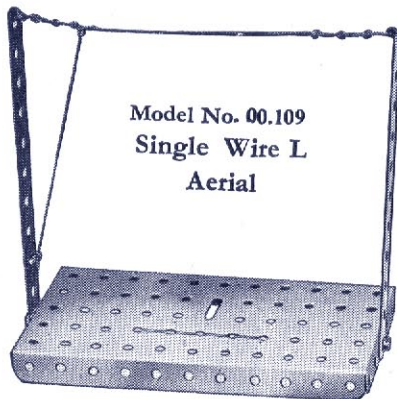
Model No. 00.115
Swing



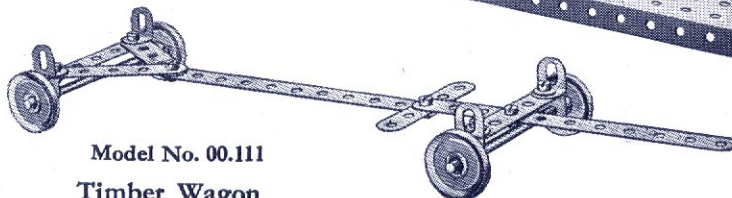
Model No. 00.107
Revolving Crane

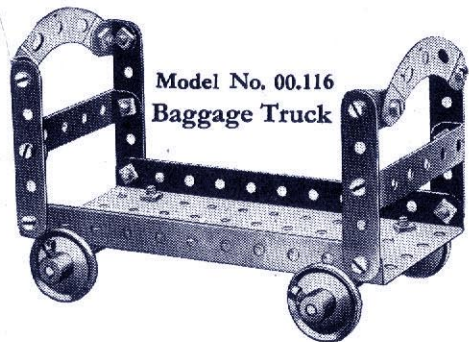


Model No. 00.109
Single Wire L
Aerial



Model No. 00.111
Timber Wagon



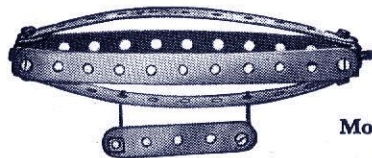


Model No. 00.116
Baggage Truck

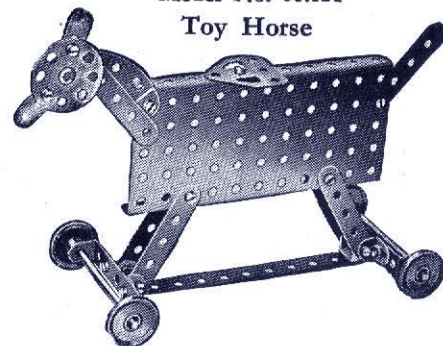
Model No. 00.119
Road Sign



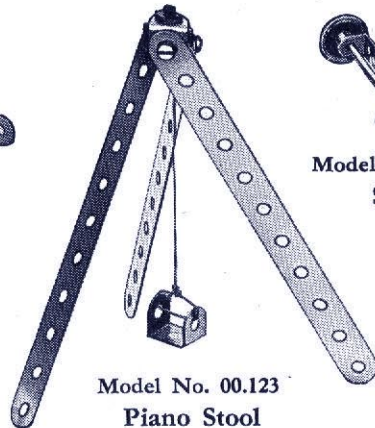
Model No. 00.120 Airship



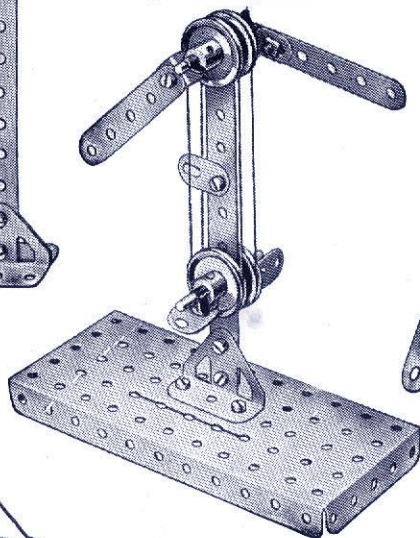
Model No. 00.124
Toy Horse



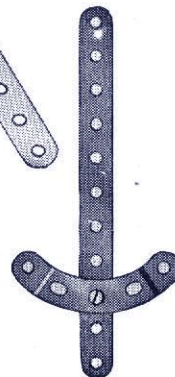
Model No. 00.122
Tripod



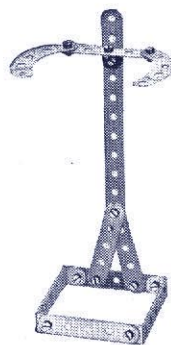
Model No. 00.121
Semaphore



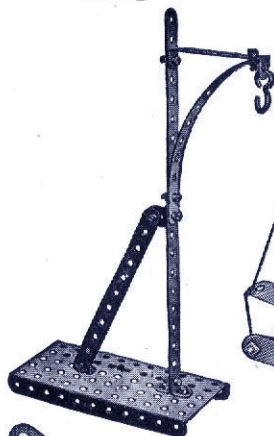
Model No. 00.125
Sword



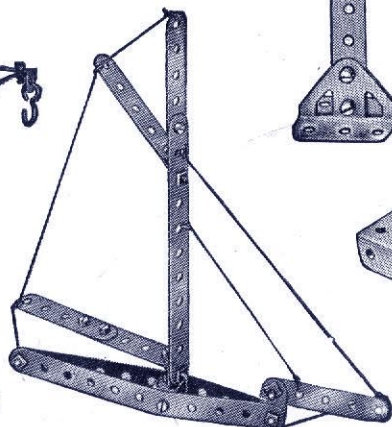
Model No. 00.126
Umbrella Stand



Model No. 00.117
Mail Bag
Hanger



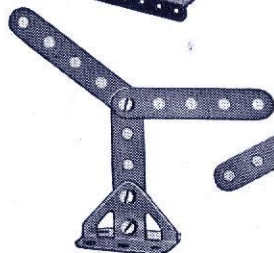
Model No. 00.118
Yacht



Model No. 00.123
Piano Stool



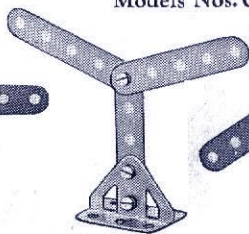
Models Nos. 00.127—00.134 Gradient Indicators



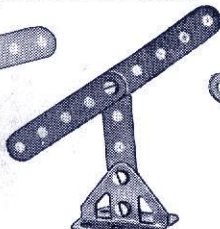
00.127



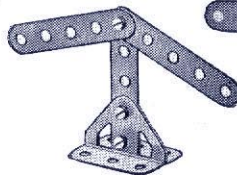
00.128



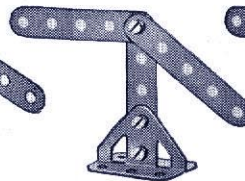
00.129



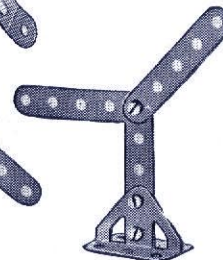
00.130



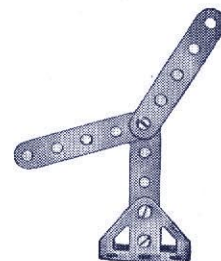
00.131



00.132



00.133

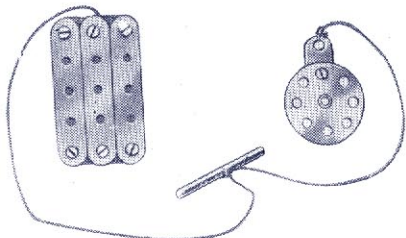


00.134

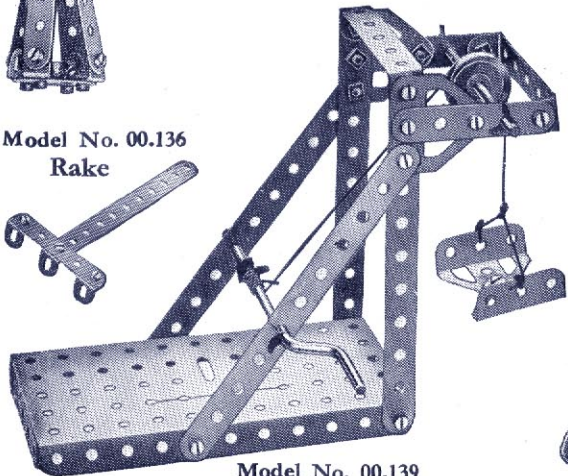
Model No. 00.135 Street Lamp



Model No. 00.137 Watch and Chain



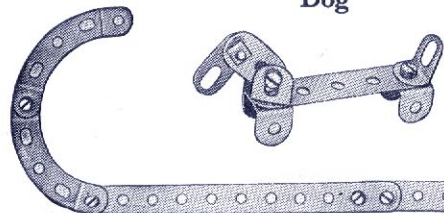
Model No. 00.138 Pit-Head Gear



Model No. 00.136 Rake



Model No. 00.139 Dog



All these Models can be built with MECCANO Outfit No. 00

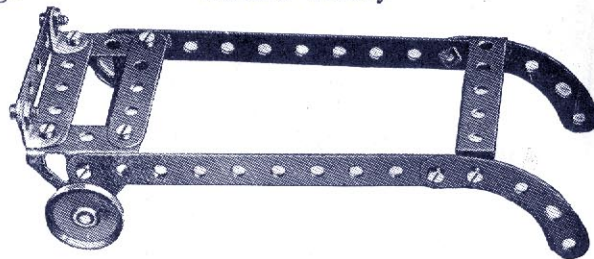
Model No. 00.142 Track Gauge



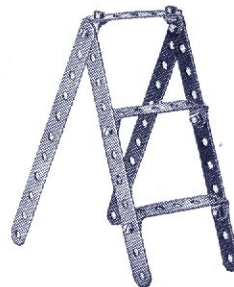
Model No. 00.143 Print Trimmer



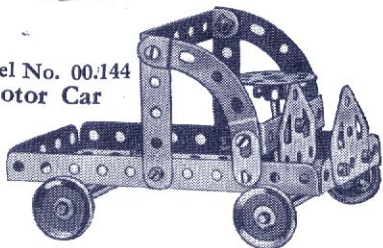
Model No. 00.146 Porter's Trolley



Model No. 00.148 Step Ladder



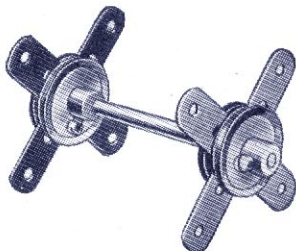
Model No. 00.144 Motor Car



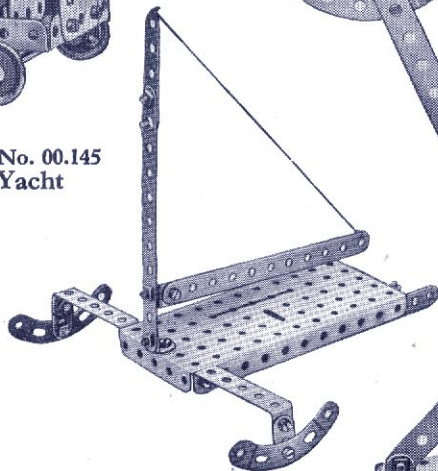
Model No. 00.147 Ostrich



Model No. 00.140 Cutlery Rest



Model No. 00.145 Ice Yacht

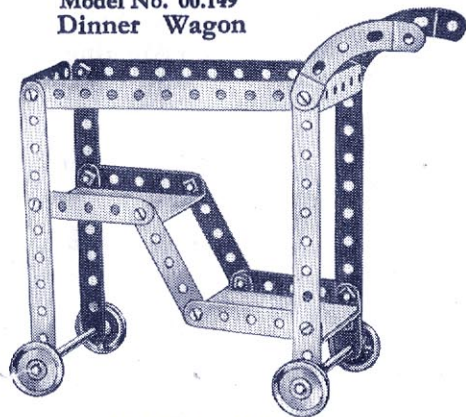


Model No. 00.141 Walking Stick

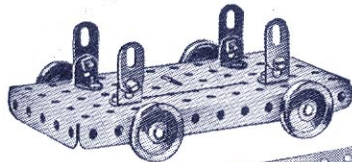


All these Models can be built with MECCANO Outfit No. 00

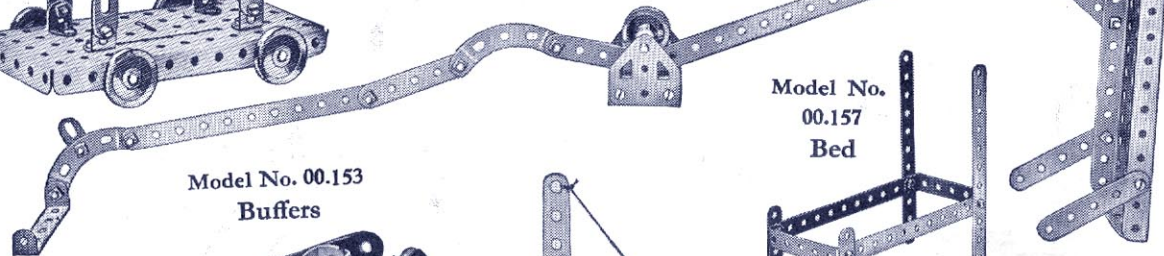
Model No. 00.149
Dinner Wagon



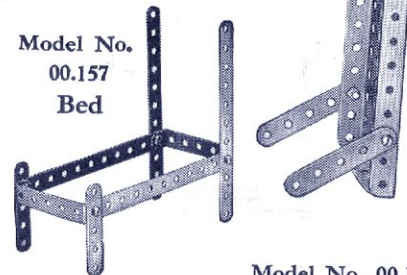
Model No. 00.152
Lumber Truck



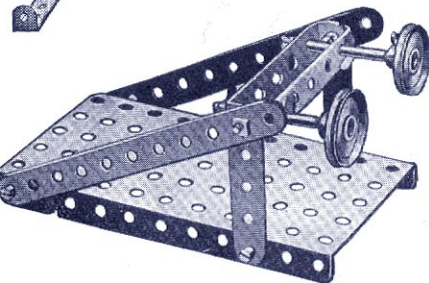
Model No. 00.156
Mono Rail



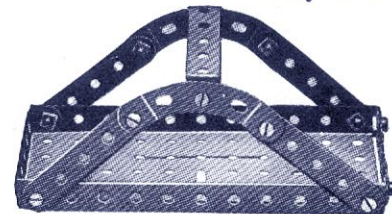
Model No. 00.157
Bed



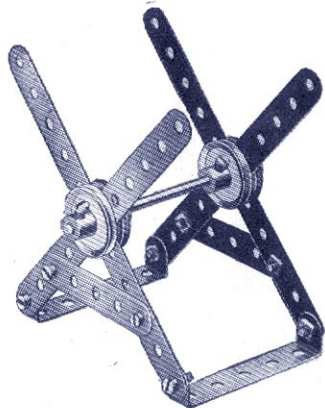
Model No. 00.153
Buffers



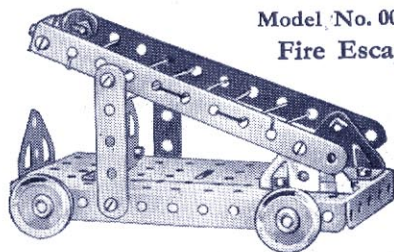
Model No. 00.158
Cutlery Basket



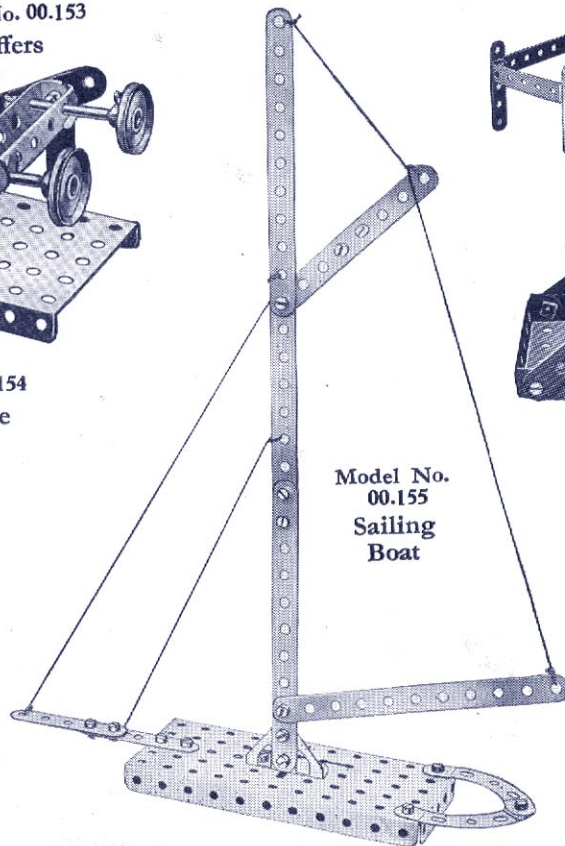
Model No. 00.150
Sawing Horse



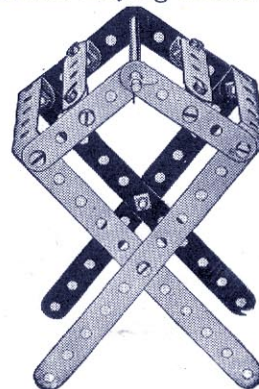
Model No. 00.154
Fire Escape



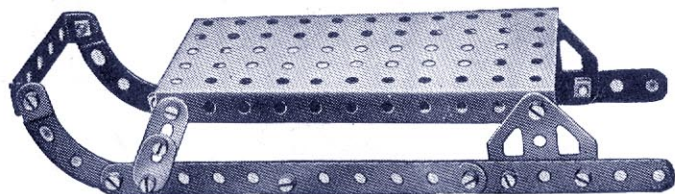
Model No. 00.155
Sailing Boat



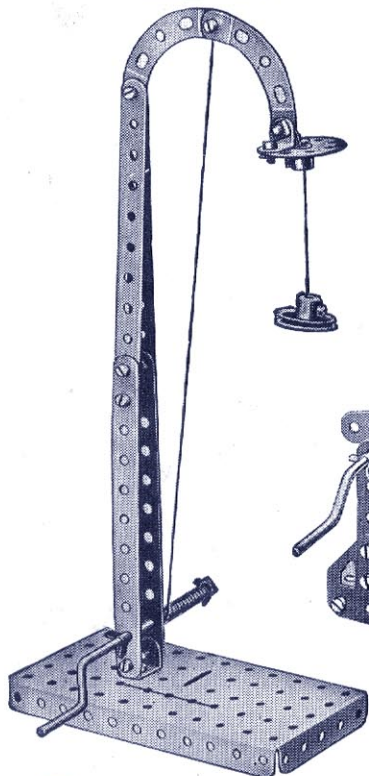
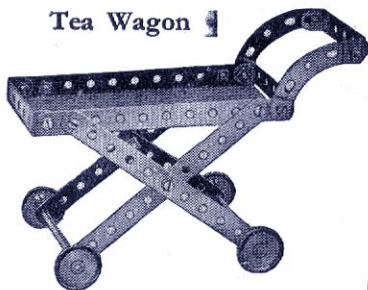
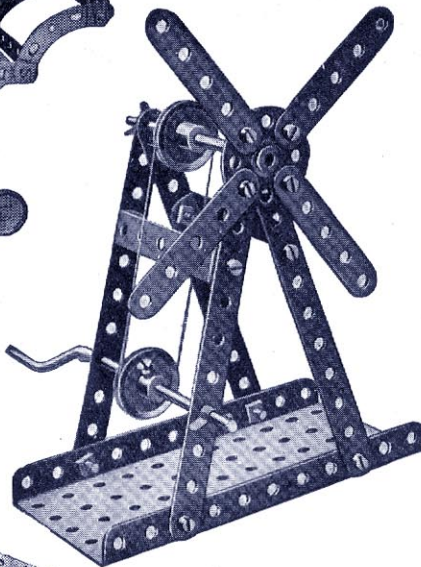
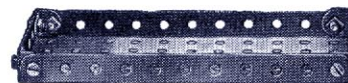
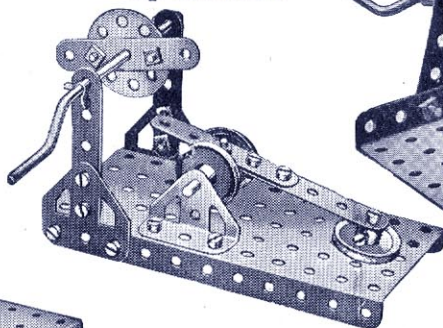
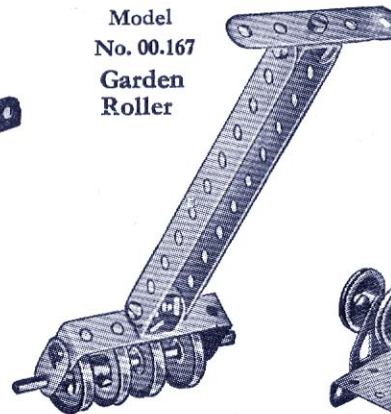
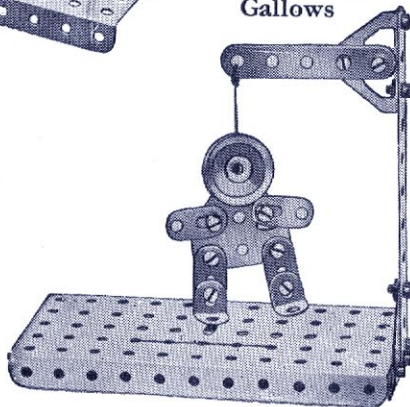
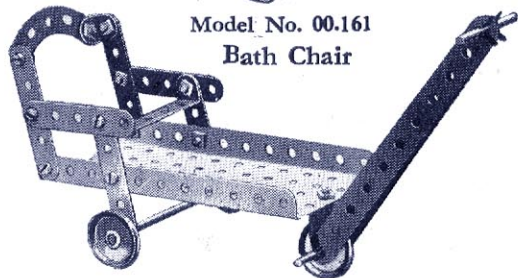
Model No. 00.159
Clothes Drying Frame



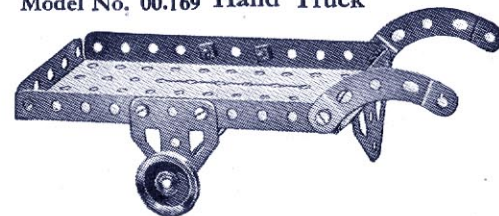
Model No. 00.151 Sledge



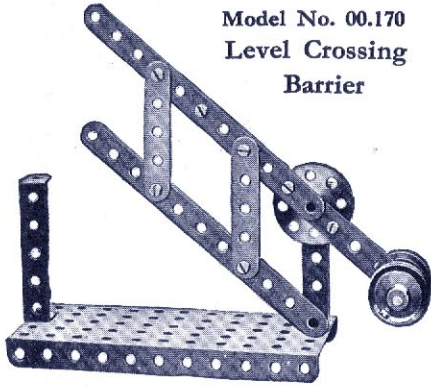
All these Models can be built with MECCANO Outfit No. 00

Model No. 00.160
Arc LampModel No. 00.162
Tea WagonModel No. 00.164
WindmillModel No. 00.168
Airship Mooring
MastModel No. 00.166
Bed TableModel No. 00.163
Trip HammerModel
No. 00.167
Garden
RollerModel No. 00.165
GallowsModel No. 00.161
Bath Chair

Model No. 00.169 Hand Truck



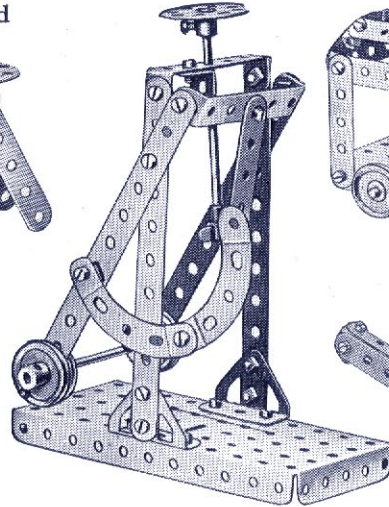
Model No. 00.170
Level Crossing
Barrier



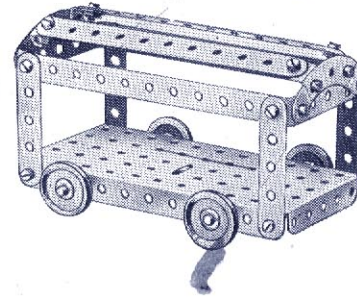
Model No. 00.172
Flower Pot
Stand



Model No. 00.174
Letter Balance

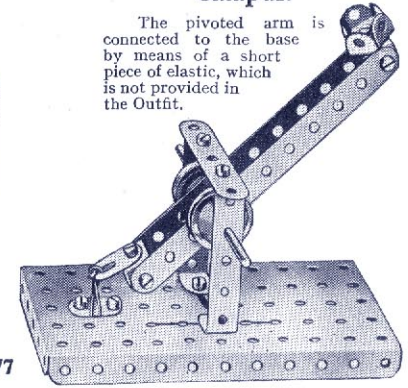


Model No. 00.176
Pullman Car

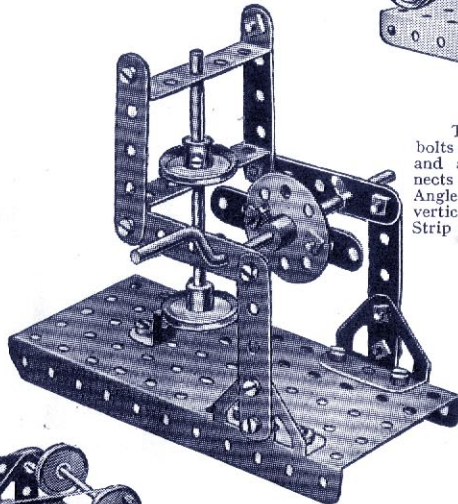


Model No. 00.178
Catapult

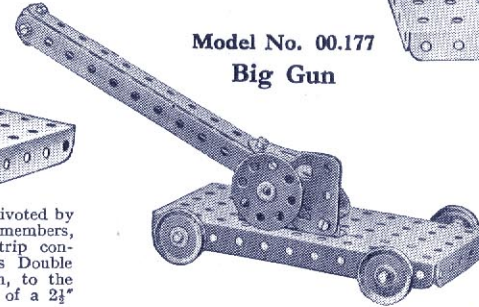
The pivoted arm is connected to the base by means of a short piece of elastic, which is not provided in the Outfit.



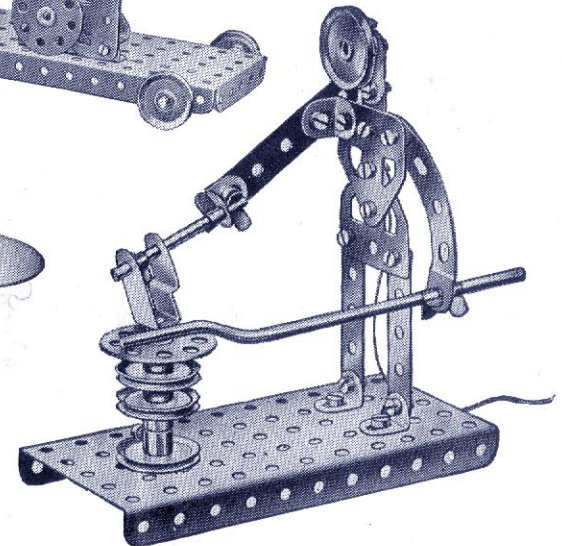
Model No. 00.173
Ore Crusher



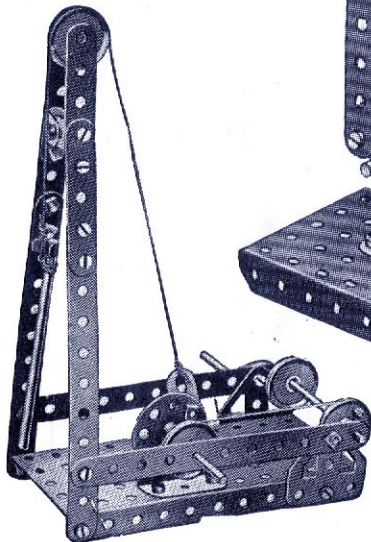
Model No. 00.177
Big Gun



Model No. 00.179
Blacksmith

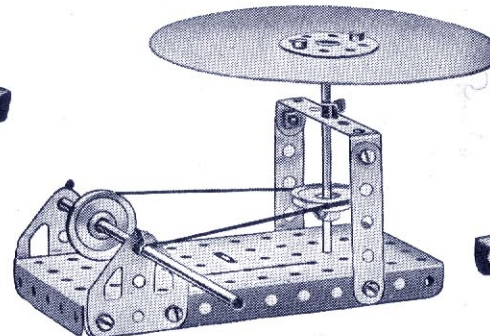


Model No. 00.171
Well Driller



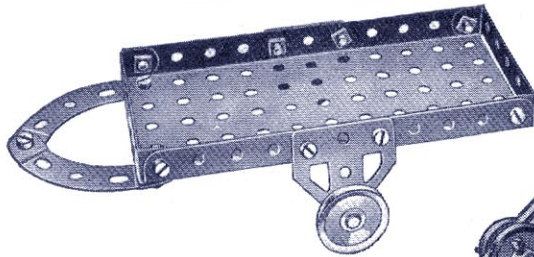
The weighted $5\frac{1}{2}$ " Strips are pivoted by bolts and locknuts to the vertical members, and a $2\frac{1}{2}$ " \times $\frac{1}{2}$ " Double Angle Strip connects their upper ends. This Double Angle Strip is connected, in turn, to the vertical $3\frac{1}{2}$ " Axle Rod by means of a $2\frac{1}{2}$ " Strip and an Angle Bracket.

Model No. 00.175 Joy Wheel



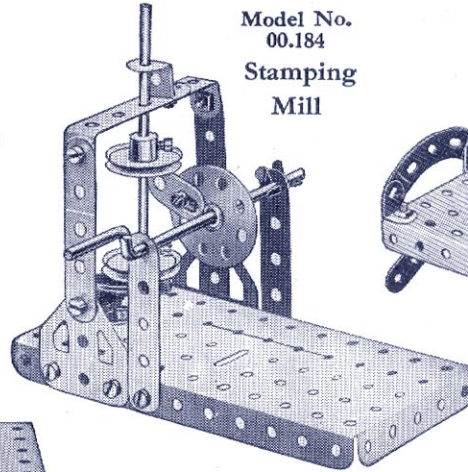
All these Models can be built with MECCANO Outfit No. 00

Model No. 00.180 Hand Truck

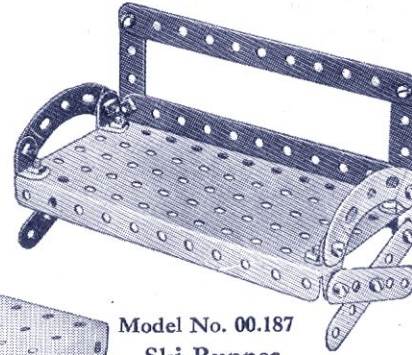


Model No. 00.184

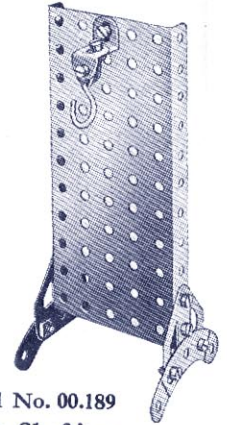
Stamping Mill



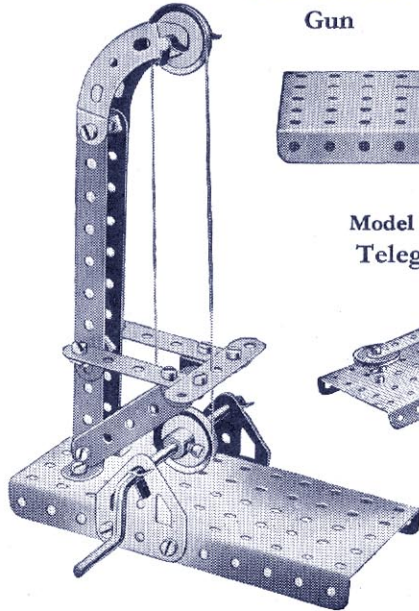
Model No. 00.186
Garden Seat



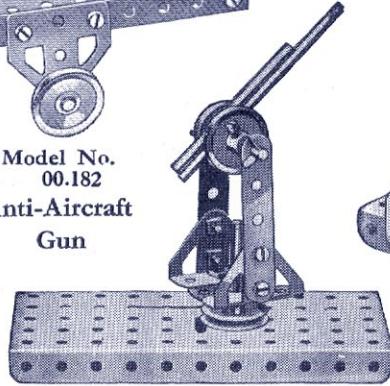
Model No. 00.188
Watch Stand



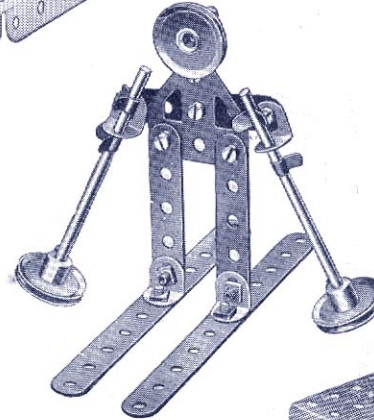
Model No. 00.181
Band Saw



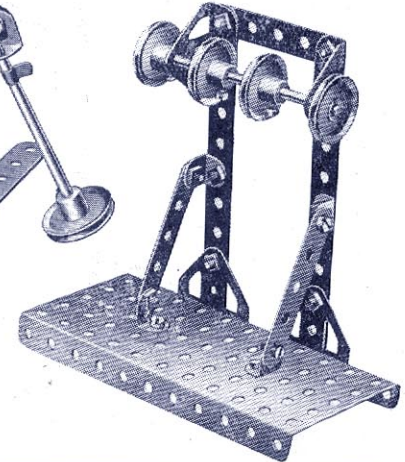
Model No. 00.182
Anti-Aircraft
Gun



Model No. 00.187
Ski-Runner



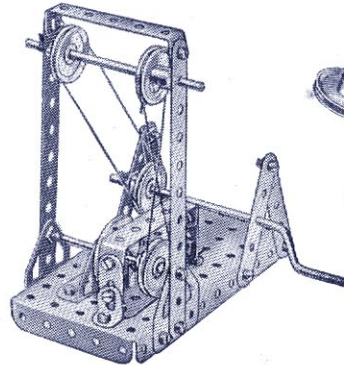
Model No. 00.189
Pulley Shafting



Model No. 00.183
Telegraph Key

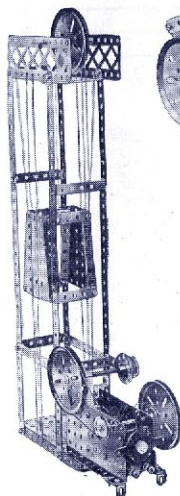


Model No. 00.185
Circular Saw

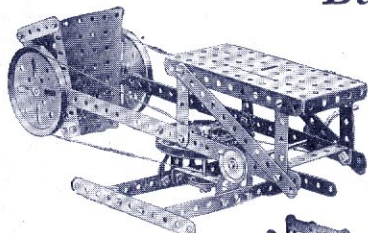


HOW TO CONTINUE

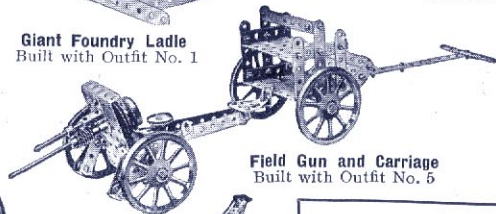
This completes our examples of models that may be made with MECCANO Outfit No. 00. The next models are a little more advanced, requiring a number of extra parts to construct them. The necessary parts are all contained in a No. 00A Accessory Outfit, which can be obtained from any Meccano dealer.



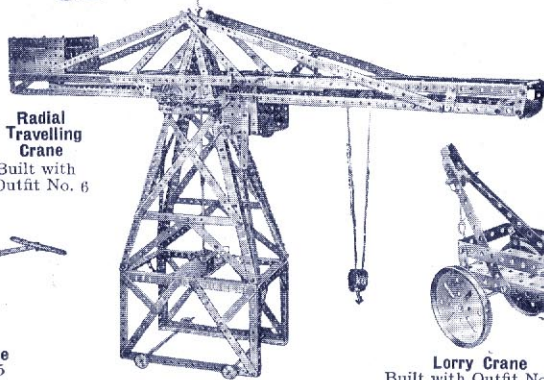
Electric Elevator
Built with Outfit No. 1



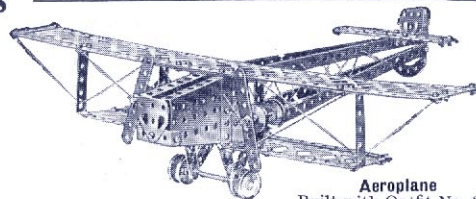
Giant Foundry Ladle
Built with Outfit No. 1



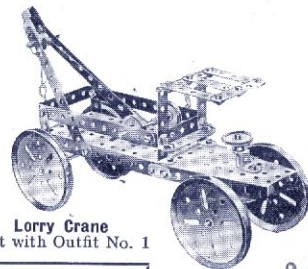
Field Gun and Carriage
Built with Outfit No. 5



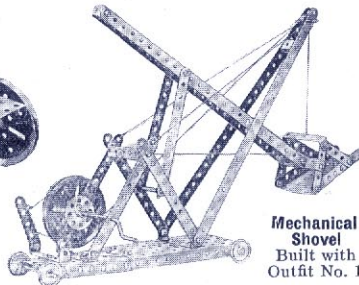
Radial Travelling Crane
Built with Outfit No. 6



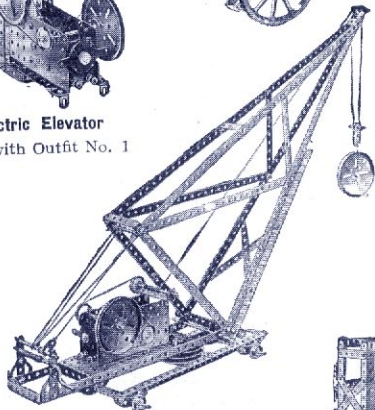
Aeroplane
Built with Outfit No. 2



Lorry Crane
Built with Outfit No. 1



Mechanical Shovel
Built with Outfit No. 1



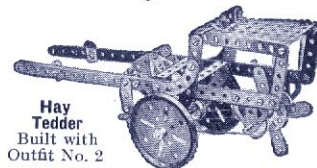
Travelling Jib Crane
Built with Outfit No. 2

Keep Adding to Your Outfit

The more Meccano parts you have, the bigger and better the models you are able to build. Keen and enthusiastic model-builders keep adding to their Outfits, until they are able to build all the wonderful models shown in the Meccano Manuals. As your equipment grows bigger and bigger, so will the fun and enjoyment increase.

The model-building possibilities of the Meccano System are limitless. All the fine models illustrated on this page are examples of the types you will be able to build as your Outfit develops.

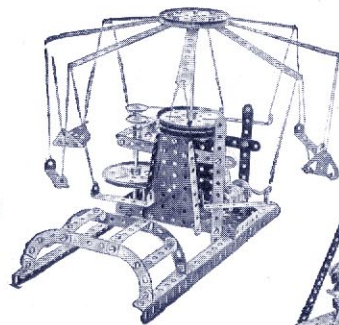
You can purchase separate Meccano parts as you require them, or, if you prefer, you can purchase Accessory Outfits that connect all the main Outfits. Ask your dealer for complete illustrated price lists of Meccano Parts and Accessory Outfits, and keep these by you for reference.



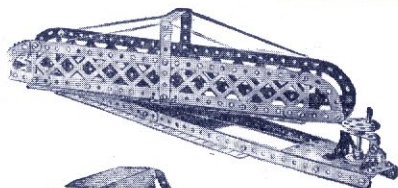
Hay Tedder
Built with Outfit No. 2



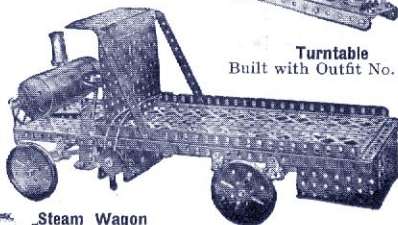
Pit-Head Gear
Built with Outfit No. 2



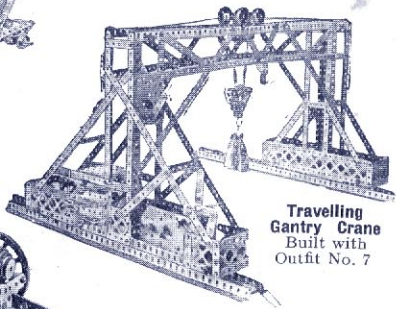
Roundabout
Built with Outfit No. 2



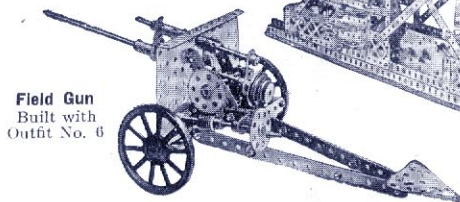
Turntable
Built with Outfit No. 2



Steam Wagon
Built with Outfit No. 3



Travelling Gantry Crane
Built with Outfit No. 7



Field Gun
Built with Outfit No. 6

MECCANO

POWER UNITS FOR DRIVING MODELS

In order to obtain the greatest possible enjoyment from the Meccano hobby, the models must be set to work by means of one of the Meccano power units. Each of these units has side plates and base pierced with the Standard Meccano equidistant holes.

MECCANO CLOCKWORK MOTORS

All Meccano Clockwork Motors are strongly built and are fitted with powerful spring mechanisms that ensure a long steady run on each winding.

X Series Clockwork Motor. This non-reversing motor is specially designed to drive models made with Meccano X Series parts.

Meccano Magic Motor. Non-Reversing

No. 1 Clockwork Motor. Non-Reversing.

No. 1A Clockwork Motor. Reversing.

No. 2 Clockwork Motor. Reversing.

MECCANO ELECTRIC MOTORS

There are four Electric Motors in the series—two 6-volt and two 20-volt. Each is a highly efficient power unit and, with ordinary care, will give long and excellent service. It is important to note that these Electric Motors cannot be run satisfactorily from dry cells.

No. E1 Electric Motor (6 volt). Non-reversing.

No. E6 Electric Motor (6 volt). Reversing.

No. E1/20 Electric Motor (20-volt). Non-reversing.

No. E20B Electric Motor (20-Volt). Reversing.

MECCANO RESISTANCE CONTROLLER

This Controller enables the speed of Meccano 6-volt Electric Motors to be regulated as desired.

MECCANO TRANSFORMERS

A Meccano Transformer provides a convenient and safe means of driving a Meccano Electric Motor from the mains supply where this is alternating current.

There are six Transformers in the series, all of which are available for all standard alternating current supply mains from 100 to 250 volts, at all standard frequencies. All the Transformers can be supplied for frequencies lower than 50 cycles. When ordering any of the Transformers the voltage and frequency of the supply must always be stated.

No. T6 Transformer (Output 25 V.A.) for 6-volt Electric Motors. Fitted with speed regulator.

No. T6M Transformer (Output 25 V.A.) for 6-volt Electric Motors. This is similar to No. T6, but is not fitted with a speed regulator.

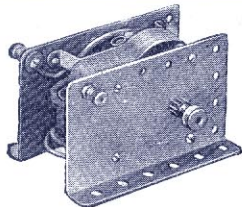
No. T6A Transformer (Output 40 V.A.) for 6-volt Electric Motors. Similar to No. T6, but provides three circuits, one at 9 volts controlled by a 5-stud speed regulator, and two at 9 volts and 3½ volts respectively, unaffected by the regulator.

No. T20 Transformer (Output 20 V.A.) for 20-volt Electric Motors. Fitted with 5-stud speed regulator.

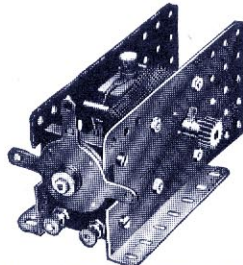
No. T20M Transformer (Output 25 V.A.) for 20-volt Electric Motors. This is similar to No. T20, but is not fitted with speed regulator.

No. T20A Transformer (Output 35 V.A.) for 20-volt Electric Motors. Similar to T20, but provides three circuits—one at 20 volts controlled by 5-stud speed regulator, and two at 20 volts and 3½ volts respectively, unaffected by the regulator.

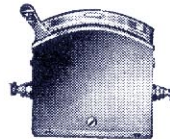
ASK YOUR DEALER FOR A COMPLETE PRICE LIST



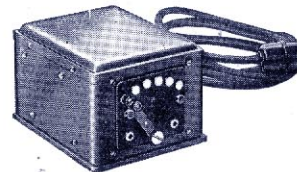
Meccano
Electric Motor
No. E1



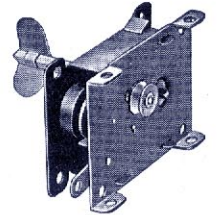
Meccano Electric Motor No. E6



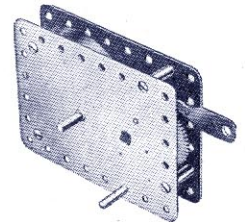
Resistance
Controller



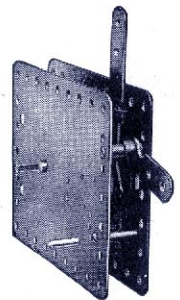
Transformer No. T20



Meccano X Series
Clockwork Motor



Meccano Clockwork
Motor No. 1



Meccano Clockwork
Motor No. 2

Patents and Designs
Great Britain

250,378	369,337
253,236	671,484
323,234	671,485
356,567	671,534
365,701	671,790
366,921	680,416
368,975	682,208
682,209	

MECCANO

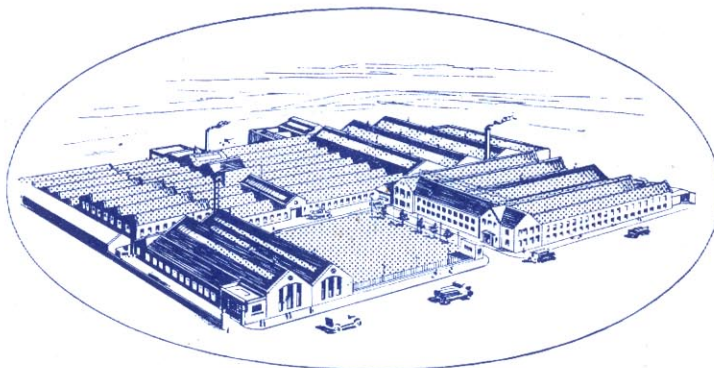
THE TOY THAT MADE ENGINEERING FAMOUS

Millions of Boys in every country throughout the world play with Meccano.
These are the Meccano Factories and distributing centres.

Patents and Designs
Great Britain

682,934	733,541
683,011	733,542
698,054	740,413
718,404	740,723
718,731	767,865
777,900	

Canadian Office and Warehouse:
Meccano Ltd.,
187-189, Church Street, Toronto.



Head Office and Factory :
BINNS ROAD, LIVERPOOL 13.

Meccano G.m.b.H.,
Düsseldorf, Kasernenstr. 18



London Office and Warehouse:
Meccano Ltd.,
Walnut Tree Walk,
Kennington Road, London, S.E.11

Meccano Agencies :

Amsterdam
Asuncion
Auckland
Barcelona
Basle
Batavia
Bogota
Bombay

Brussels
Buenos Aires
Calcutta
Cape Town
Caracas
Colombo
Durban
Genoa
Guayaquil

Helsingfors
Hong Kong
Iquitos
Istanbul
Jerusalem
Johannesburg
Karachi
Mexico
Monte Video

Oslo
Rio de Janeiro
Santiago
Sao Paulo
Shanghai
Stockholm
Sydney
Trinidad
Vienna



Paris Office :
Meccano (France) Ltd.,
78-80, Rue Rébeval,
Paris. XIXe.
Factory : Bobigny (Seine).