

MECCANO



INSTRUCTIONS for OUTFIT No. 3

COPYRIGHT BY MECCANO LIMITED
BINNS ROAD, LIVERPOOL 13, ENGLAND

50.3

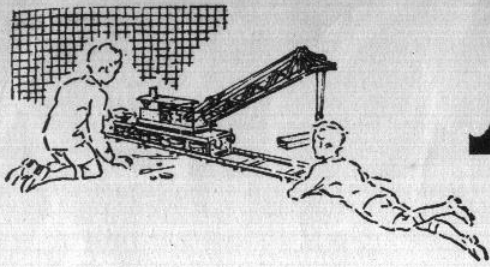

MECCANO

Real Engineering in Miniature

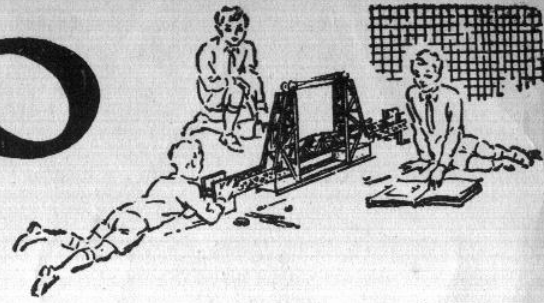

MODEL-BUILDING WITH MECCANO

There is no limit to the number of models that can be built with Meccano—Cranes, Clocks, Motor Cars, Aeroplanes, Machine Tools, Locomotives—in fact everything that interests boys. A screwdriver and a spanner, both of which are provided in each Outfit, are the only tools necessary.

When you have built all the models illustrated in the Books of Instructions the fun is not over, it is just beginning. Now comes the chance to make use of your own ideas. First of all, re-build some of the models with small changes in construction that may occur to you; then try building models entirely of your own design. In doing this you will feel the real thrill of the engineer and the inventor.

HOW TO BUILD UP YOUR OUTFIT

Meccano is sold in 11 different Outfits, ranging from No. 0 to No. 10. Each Outfit can be converted into the next larger by the purchase of an Accessory Outfit. Thus Meccano No. 0 Outfit can be converted into No. 1 Outfit by adding to it a No. 0a Accessory Outfit. No. 1a Outfit would then convert it into a No. 2 and so on. In this way, no matter with which Outfit you begin, you can build it up by degrees until you have a No. 10 Outfit.

All Meccano parts are of the same high quality and finish, but the larger Outfits contain

THE "MECCANO MAGAZINE"

The "Meccano Magazine" is published specially for Meccano boys. Every month it describes and illustrates new Meccano models for Outfits of all sizes, and deals with suggestions from readers for new Meccano parts and for new methods of using the existing parts.

There are model-building competitions specially planned to give an equal chance to the owners of small and large Outfits. In addition, there are splendid articles on such subjects as Railways, Famous Engineers and Inventors, Electricity, Bridges, Cranes and Aeroplanes, and special sections dealing with the latest Engineering, Aviation, Motoring

and Shipping News. Other pages deal with Stamp Collecting, and Books of interest to boys; and a feature of outstanding popularity is the section devoted to short articles from readers.

If you are not already a reader write to the Editor for particulars. Supplies of the Magazine are very limited owing to the paper shortage.

THE MECCANO GUILD

Every owner of a Meccano Outfit should join the Meccano Guild. This is a world-wide organisation, started at the request of Meccano boys. Its primary object is to bring boys together and to make them feel that they are all members of a great brotherhood, each trying to help others to get the very best out of life. Its members are in constant touch with Headquarters, giving news of their activities and being guided in their hobbies and interests. Write for full particulars and an application form to the Secretary, Meccano Guild, Binns Road, Liverpool 13.

Clubs founded and established under the guidance of the Guild Secretary provide Meccano boys with opportunities of enjoying to the utmost the fun of model-building. Each has its Leader, Secretary, Treasurer and other officials. With the exception of the Leader, all the officials are boys, and as far as possible the proceedings of the clubs are conducted by boys.

MECCANO SERVICE

The service of Meccano does not end with selling an Outfit and a Book of Instructions. If ever you are in any difficulty with your models, or if you want advice on anything connected with this great hobby, write to us. We receive hundreds of interesting letters from boys in all parts of the world, and each of these is answered personally by one of our staff of experienced experts.

Whatever your problem may be, write to us about it. Do not hesitate. We shall be delighted to help you in any way possible.

HOW TO BEGIN THE FUN

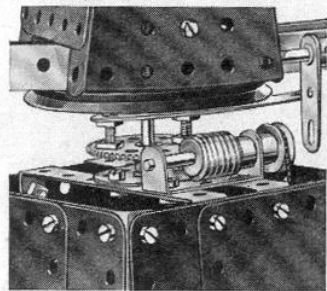

A Worm and a 57-teeth Gear give a useful drive ratio for many models

THE MOST FASCINATING OF ALL HOBBIES

Meccano model-building is the most fascinating of all hobbies, because it never becomes dull. There is always something new to be done. First of all there is the fun of building a new model, and watching it take shape as part after part is added. Then, when the model is complete, comes the thrill of setting it to work just like the real structure it represents, by means of a Meccano Motor.

A FEW USEFUL HINTS

Beginners sometimes wonder which section of a model should be built first. There cannot be any

definite rule for this, as it depends on the design of the model. In stationary models the base usually should be built first. In most of the smaller models a $5\frac{1}{2}'' \times 2\frac{1}{2}''$ Flanged Plate forms an important part of the structure, and often the best plan is to start building by bolting parts to this Plate. For other models a good general rule is that the sections that form supports for a number of other parts should be built first.

Flexible Plates are sometimes used for forming curved surfaces in models, but they are not intended to be bent at right angles. With careful handling a Plate can be bent to the required curve and after use straightened again.

All Outfits from No. 2 upward include a Cord Anchoring Spring, Part No. 176. This part provides a neat and positive method of fastening a length of Cord to a Rod. When pushing the Spring on to a Rod or Crank Handle, turn left so that its coils tend to unwind; turn it in the same direction when pulling it off the Rod.

THE IMPORTANCE OF "LOCK-NUTTING"

In some models it is necessary to join certain parts together so that, although they cannot come apart, they are free to pivot or move in relation to one another. To do this the parts are bolted together as usual but the nut is not screwed up tightly, so that the parts are not gripped. Then, to prevent the nut from unscrewing, a second nut is screwed up tightly against it, the first nut being held with a spanner. This method of using a second nut is known as **Lock-nutting**.

A Rod is usually mounted in a support or bearing, such as a hole in a strip, so that it is free to revolve. The Rod is then said to be **journalled** in the Strip.

During the construction of a model it is best to screw up the nuts with the fingers, followed by just a light turn with the screwdriver, leaving the final tightening with spanner and screwdriver until all the parts are connected up.

DRIVING YOUR MODELS

Models can be driven by means of either clockwork or electric motors.

Small and light models may be driven direct from the driving pulley of the motor or through a belt running over two pulleys of the same size, giving what is known as a 1 : 1 (one-to-one) ratio. For large models it is necessary to take the drive from a small pulley on the motor shaft to a larger pulley on the driving shaft of the model. In most cases a 1" Pulley on the motor shaft and a 3" Pulley on the model shaft will be found satisfactory. This provides a reduction ratio of approximately 3 : 1.

Rubber bands are very convenient for driving belts. Sometimes, however, a rubber band of the right length is not available, and then Meccano Cord or thin string is used. To tie the Cord to form an endless belt, use the familiar reef knot.

With the larger Outfits, belt drive can be replaced with advantage by gearing. To operate a slow-moving model demanding great power, such as a traction engine, gears that will provide a considerable reduction must be used. For example, a Worm meshed with a $\frac{1}{2}''$ Pinion will give a 19 : 1 reduction; a Worm meshed with a 57-teeth Gear will give a 57 : 1 reduction.

All the models in this Book were built up and tested in our model-building department. Some of them are shown fitted with a motor, and provided that they are properly constructed the motor will drive them satisfactorily.

If the motor is to operate successfully however, there must be no excessive friction in the mechanism of the model. This can be caused by shafts and their bearings being slightly out of line, or by a belt or Cord drive being too tight. Before condemning the motor therefore, first make sure that every revolving shaft moves quite freely in its bearings, and that the bearings are in line with one another. The bearings can be brought into line by pushing through them a Drift (Part No. 36c) or a Rod, before the bolts holding the various parts are tightened up. To make the running perfectly smooth, apply a little light machine oil to every bearing or pivot on which moving parts are mounted.

The models included in this Book give a good idea of the various types of Meccano construction, and provide a guide to the building of a large number of other models with this outfit. If any difficulty should arise in planning a new model, write to Meccano Limited, Binns Road, Liverpool 13, and every possible assistance will be given.

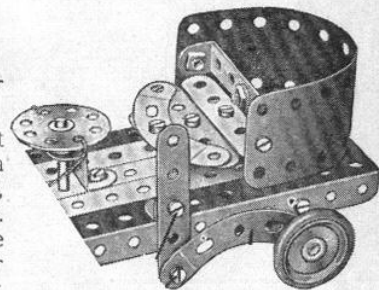

A Flexible Plate used to form a curved surface.

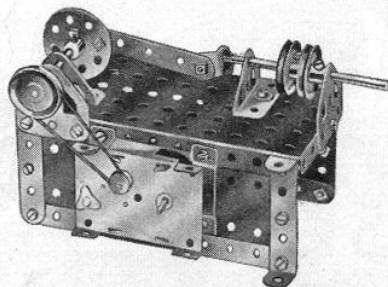

A Magic Motor fitted to drive a Steam Engine.

O.1 GARDEN SEAT

Parts required
 4 of No. 2
 2 " " 5
 10 " " 37*
 2 " " 48a
 1 " " 52

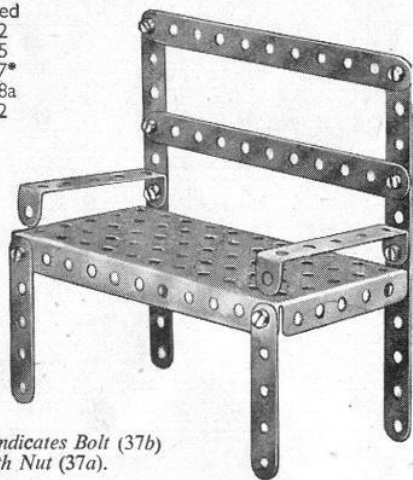

*No. 37 indicates Bolt (37b)
 fitted with Nut (37a).

O.2 FLAT TRUCK

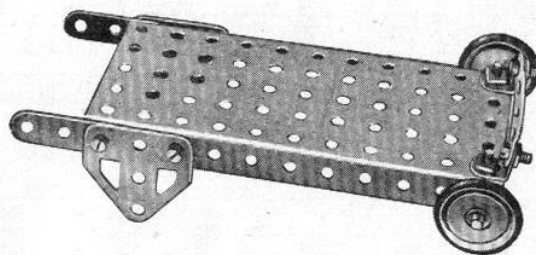

Parts required
 2 of No. 5 | 2 of No. 22 | 1 of No. 90a
 2 " " 12 | 8 " " 37 | 2 " " 126a
 1 " " 16 | 1 " " 52 | 2 " " 155

O.5 SCALES

Parts required
 3 of No. 2 | 2 of No. 35 | 2 of No. 126
 1 " " 17 | 10 " " 37 | 2 " " 126a
 1 " " 24 | 1 " " 52

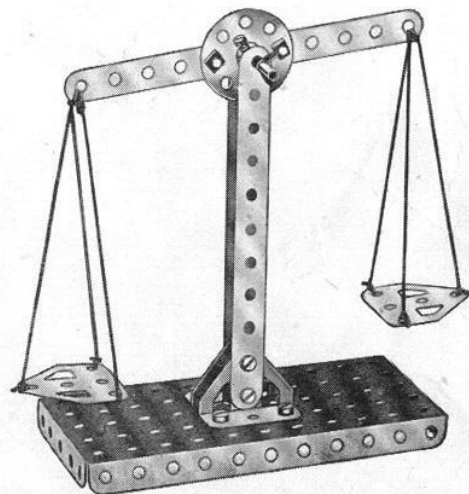

O.4 COUNTER SCALES

Parts required
 1 of No. 2 | 2 of No. 22 | 1 of No. 52
 2 " " 10 | 1 " " 24 | 2 " " 126
 4 " " 12 | 9 " " 37 | 2 " " 126a
 1 " " 17 | 2 " " 38

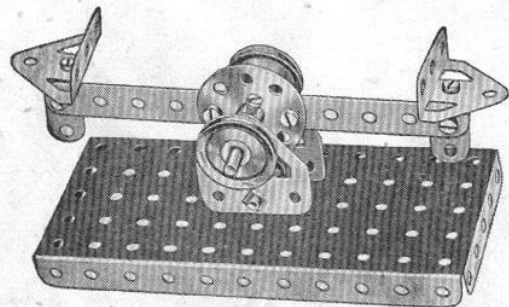

O.3 SWING BOAT

Parts required
 4 of No. 2
 2 " " 5
 4 " " 12
 1 " " 16
 1 " " 19s
 2 " " 22
 1 " " 24
 3 " " 35
 18 " " 37
 1 " " 52
 2 " " 90a
 2 " " 126
 2 " " 126a

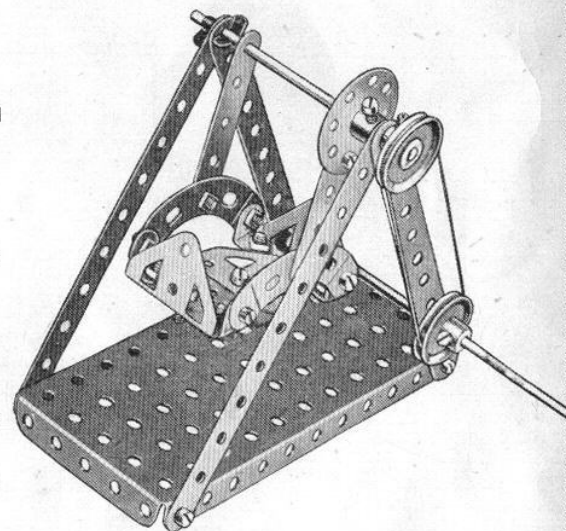

O.6 COSTER'S BARROW

Parts required
 4 of No. 2 | 2 of No. 22 | 2 of No. 90a
 2 " " 5 | 16 " " 37 | 2 " " 126
 2 " " 10 | 2 " " 48a | 2 " " 126a
 1 " " 16 | 1 " " 52 | 2 " " 155

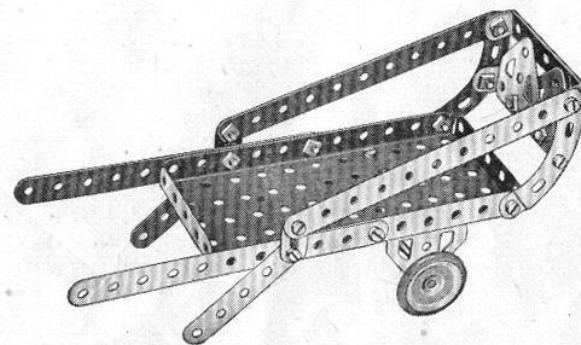

1.1 FLYING BOATS

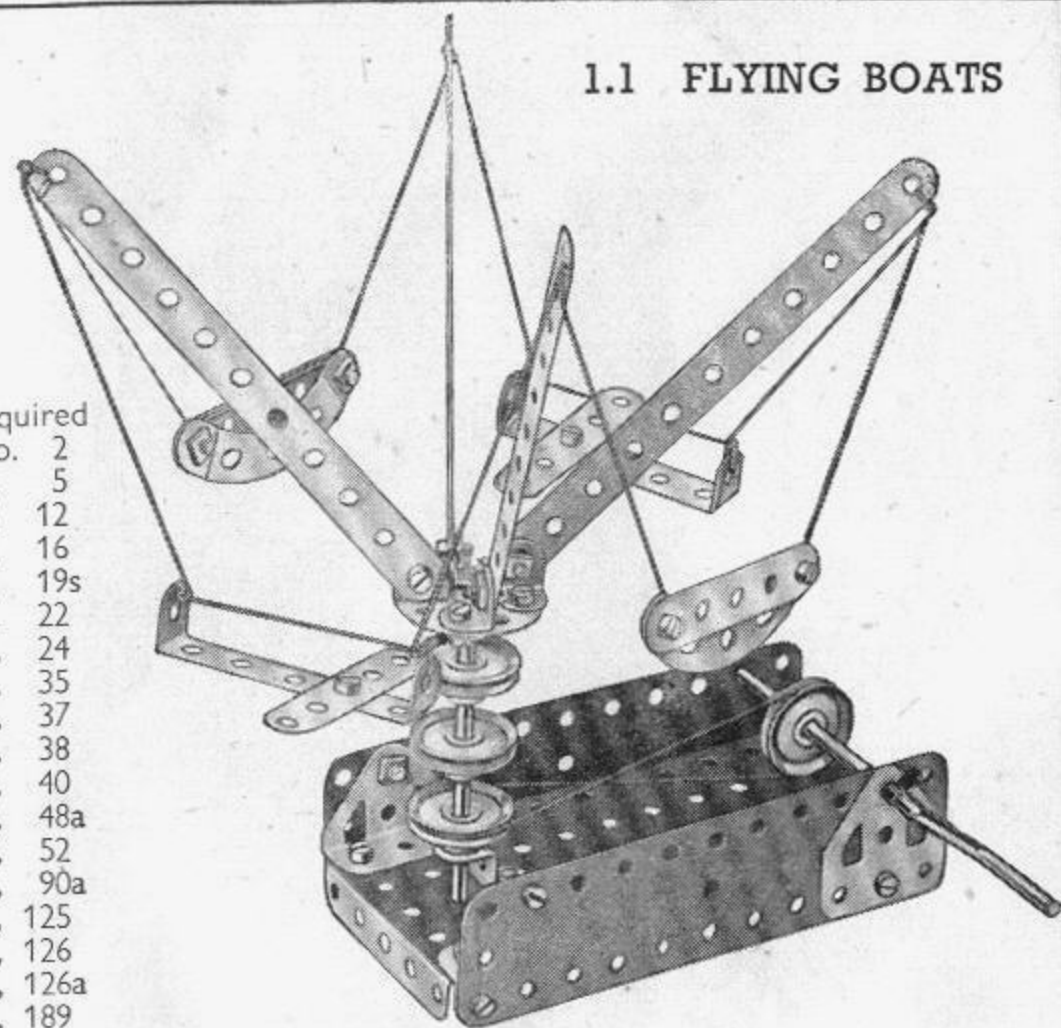

Parts required

4 of No.	2
4 " "	5
4 " "	12
1 " "	16
1 " "	19s
4 " "	22
1 " "	24
3 " "	35
24 " "	37
1 " "	38
1 " "	40
2 " "	48a
1 " "	52
2 " "	90a
1 " "	125
2 " "	126
2 " "	126a
2 " "	189

1.2 DRILL

Parts required

4 of No.	2	4 of No.	35
3 " "	5	20 " "	37
8 " "	12	4 " "	38
1 " "	16	1 " "	40
1 " "	17	1 " "	52
1 " "	19s	2 " "	126
4 " "	22	2 " "	126a

The drill table is made by bolting together two Flat Trunnions.

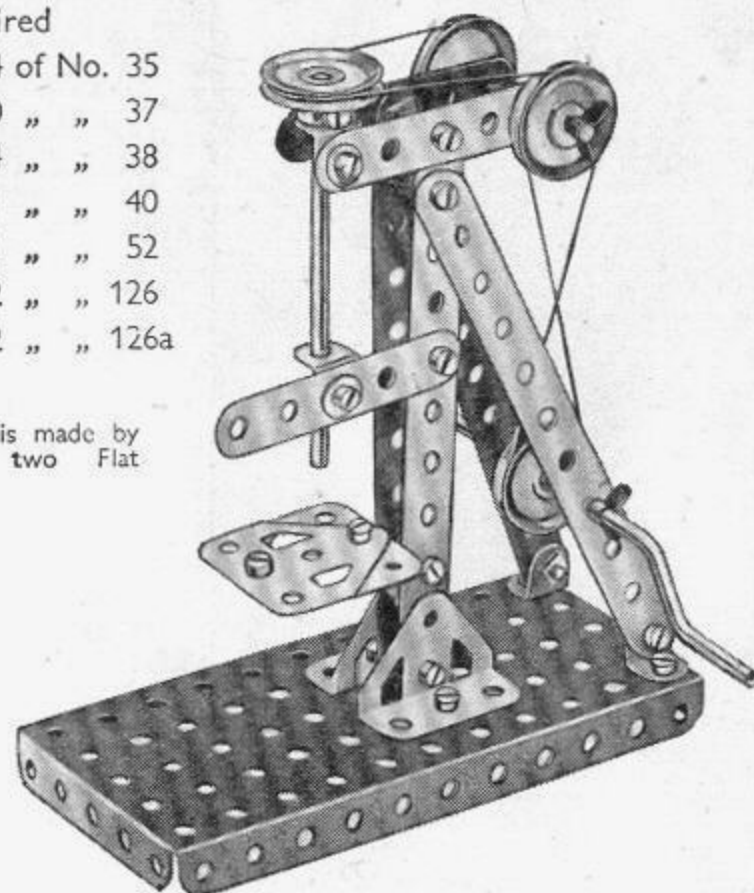

1.3 SCALES

Parts required

4 of No.	2
2 " "	5
2 " "	17
2 " "	22
1 " "	24
19 " "	37
1 " "	38
1 " "	40
2 " "	48a
1 " "	52
2 " "	90a
1 " "	111c
2 " "	126
2 " "	126a
1 " "	155
2 " "	189

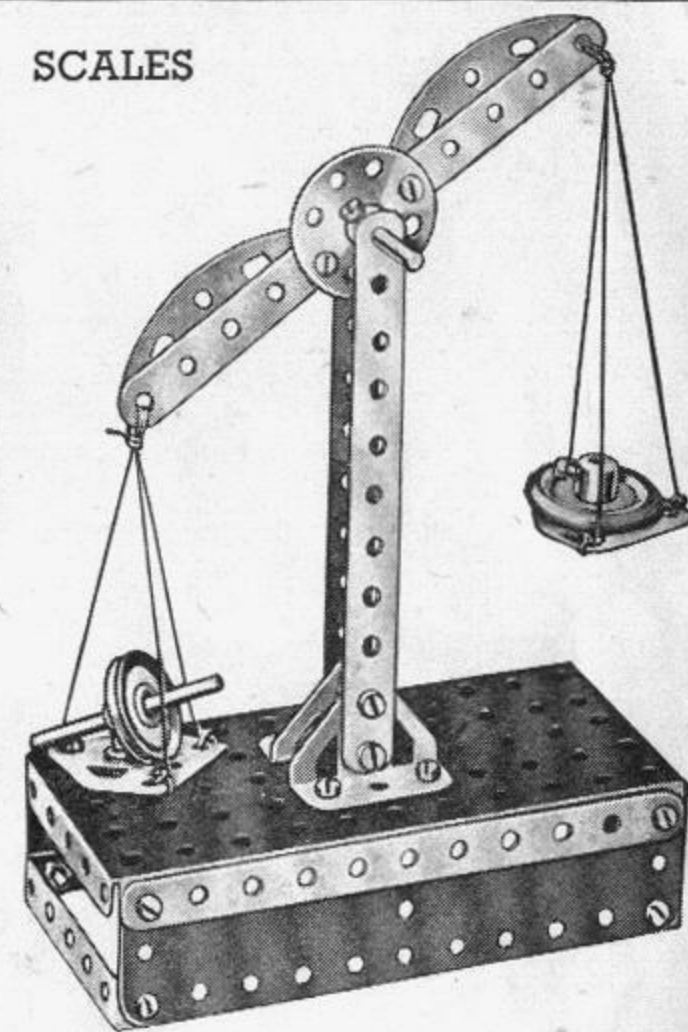

1.4 MOTOR LORRY

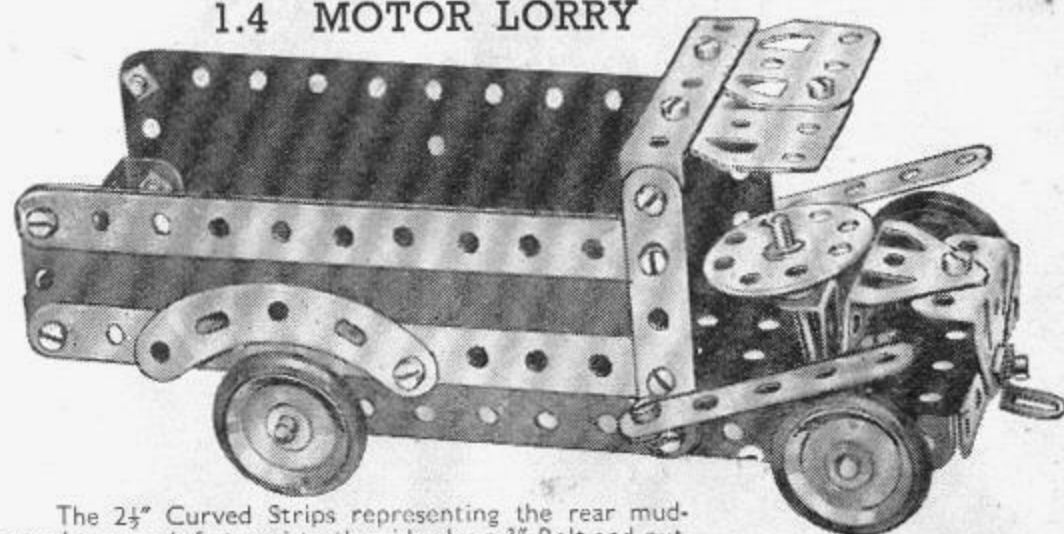

The 2½" Curved Strips representing the rear mudguards are each fastened to the sides by a 3/8" Bolt and nut, with a Spring Clip between the mudguards and the 5½" Strip to form a distance piece.

Parts required

4 of No.	2	1 of No.	17	19 of No.	37	2 of No.	90a	2 of No.	126a
4 " "	5	4 " "	22	4 " "	37a	3 " "	111c	4 " "	155
3 " "	12	1 " "	24	2 " "	48a	1 " "	125	2 " "	189
2 " "	16	2 " "	35	1 " "	52	2 " "	126		

1.5 RACING SEAPLANE

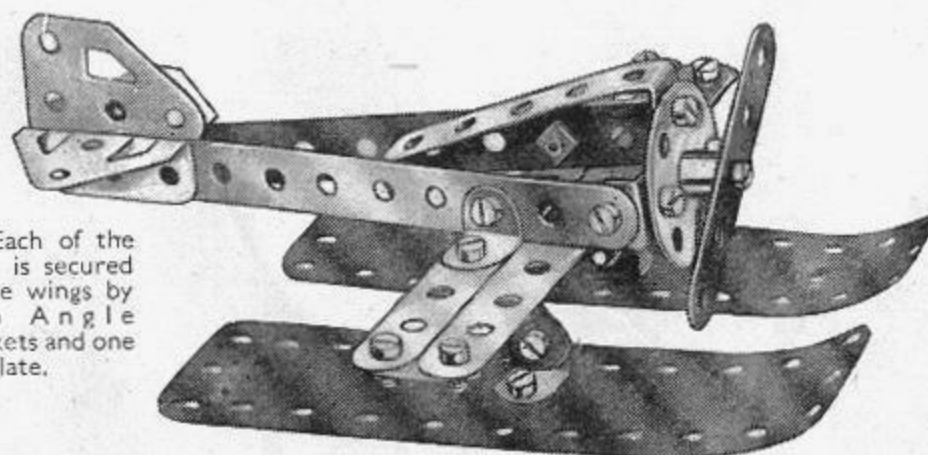

Each of the floats is secured to the wings by two Angle Brackets and one Fishplate.

Parts required

3 of No.	2	1 of No.	24	2 of No.	111c
3 " "	3	19 " "	37	2 " "	126
4 " "	10	1 " "	37a	1 " "	126a
8 " "	12	1 " "	48a	2 " "	189

1.6 KIDDIE CAR

Parts required

4 of No.	2
4 " "	5
3 " "	10
7 " "	12
2 " "	16
1 " "	17
4 " "	22
1 " "	24
1 " "	35
24 " "	37
3 " "	37a
2 " "	48a
1 " "	52
2 " "	90a
2 " "	111c
1 " "	125
2 " "	126
1 " "	126a
4 " "	155
2 " "	189

Two Trunnions overlapped one hole, and fastened to the Flanged Plate by an Angle Bracket form the seat.

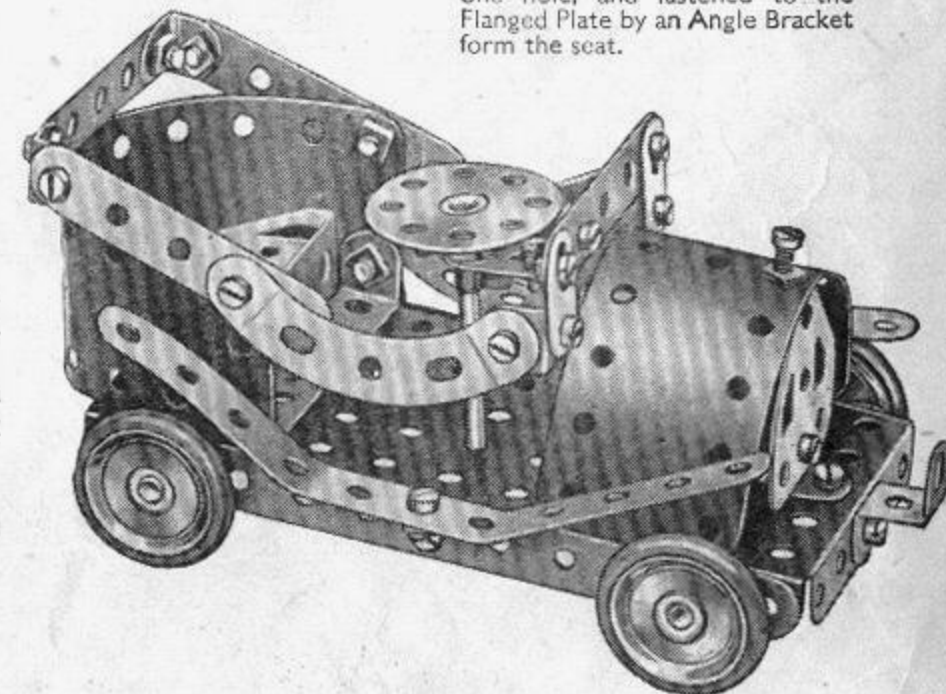

1.7 SIDE TIPPING WAGON

Parts required

3 of No. 2	3 of No. 38
4 " " 5	2 " " 48a
4 " " 10	1 " " 52
7 " " 12	2 " " 90a
2 " " 16	4 " " 111c
1 " " 17	1 " " 125
4 " " 22	2 " " 126
1 " " 24	2 " " 126a
24 " " 37	4 " " 155
4 " " 37a	2 " " 189
	1 Magic Motor

(Not included in Outfit)

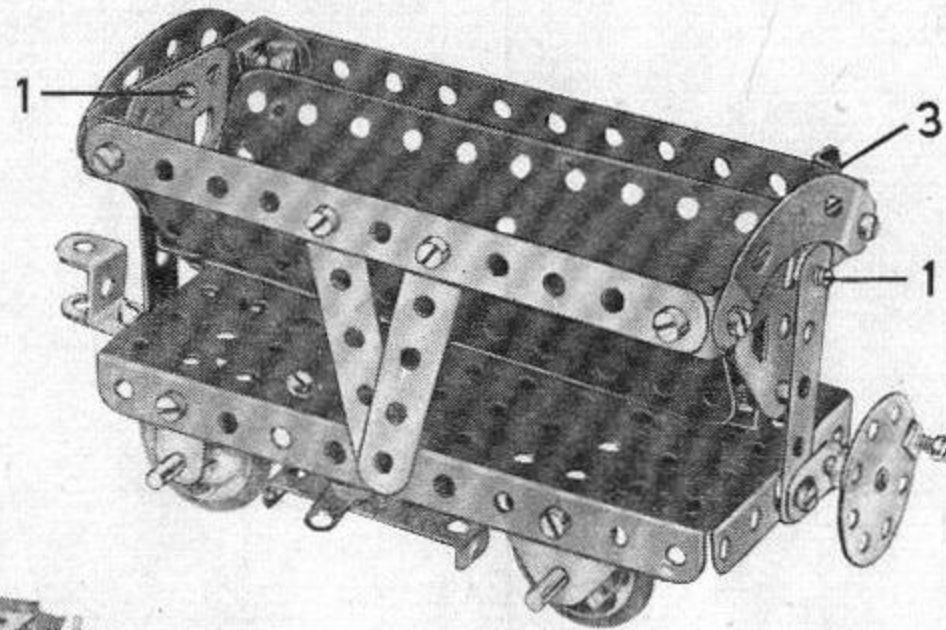

Each of the Bolts 1 is lock-nutted. A piece of Cord is fastened to the Rod 2 (Fig. 1.7a) wrapped round it two or three times, and then is taken through the hole in the Flanged Plate above the Rod and secured to the Angle Bracket 3.

By turning the Bush Wheel the container is tipped sideways.

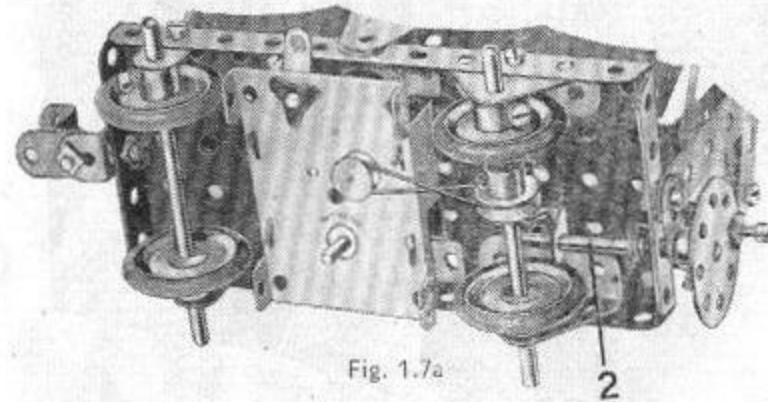

Fig. 1.7a

1.8 STAMPING MILL

The anvil 1 is made up of two Trunnions bolted together. When the Crank Handle is rotated, the Fishplates bolted to the Bush Wheel strike the centre 1" Pulley on the hammer shaft and cause it to rise and fall.

Parts required

4 of No. 2	3 of No. 37a
5 " " 5	2 " " 38
4 " " 10	2 " " 48a
4 " " 12	1 " " 52
1 " " 16	1 " " 90a
1 " " 19s	4 " " 111c
4 " " 22	1 " " 125
1 " " 24	2 " " 126
2 " " 35	2 " " 126a
24 " " 37	2 " " 189

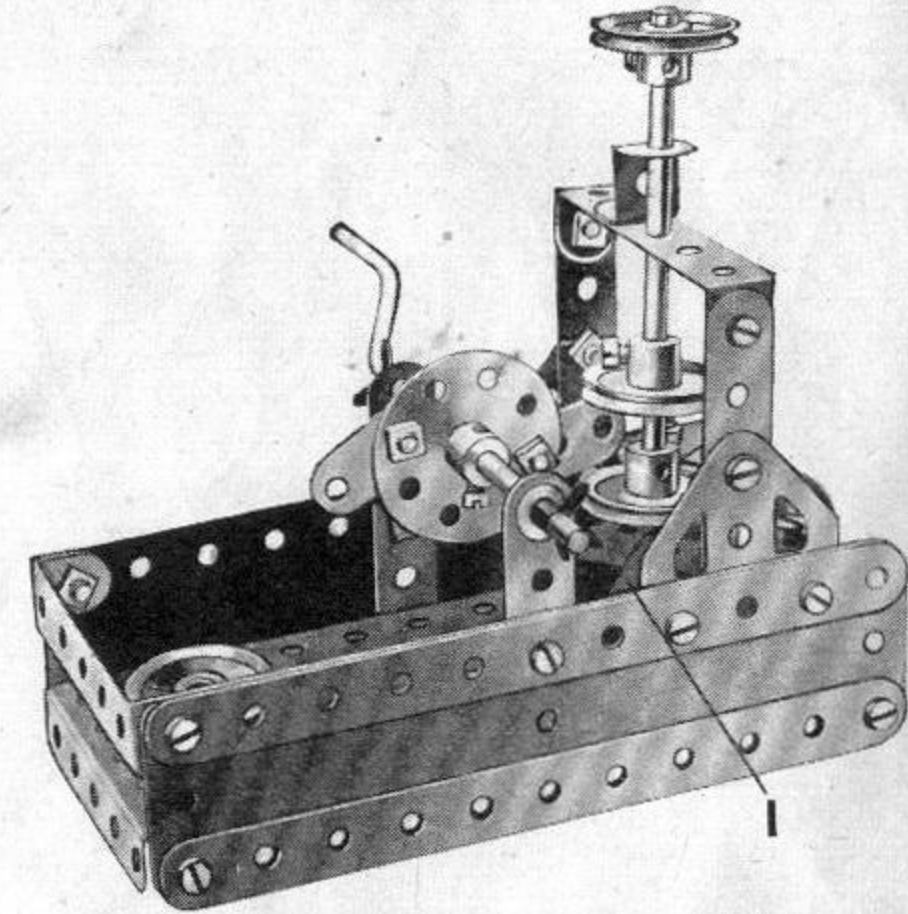

1.9 LETTER BALANCE

Parts required

4 of No. 2
4 " " 5
4 " " 10
2 " " 12
1 " " 16
2 " " 17
4 " " 22
1 " " 24
4 " " 35
24 " " 37
4 " " 37a
4 " " 38
2 " " 48a
1 " " 52
1 " " 57c
1 " " 90a
4 " " 111c
1 " " 125
2 " " 126
2 " " 126a
4 " " 155
2 " " 189

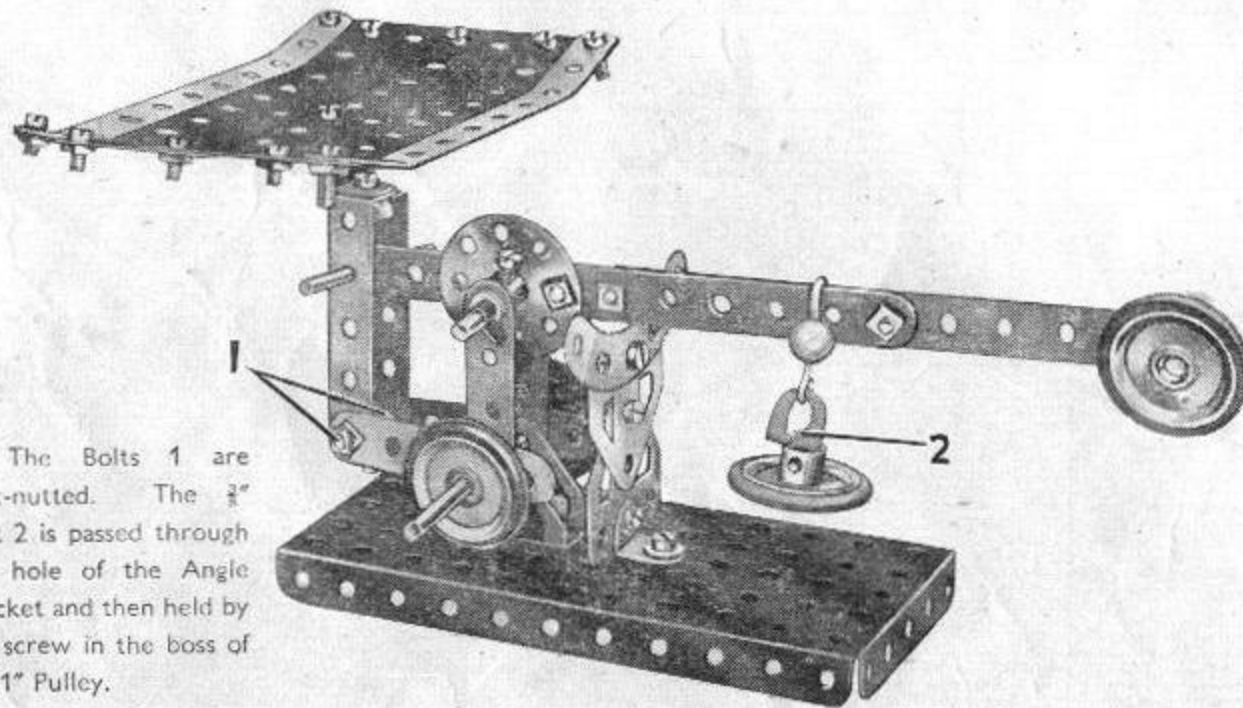

The Bolts 1 are lock-nutted. The $\frac{3}{8}$ " Bolt 2 is passed through the hole of the Angle Bracket and then held by the screw in the boss of the 1" Pulley.

1.10 RAILWAY BREAKDOWN CRANE

Parts required

4 of No. 2	4 of No. 22	1 of No. 40	1 of No. 125
4 " " 5	1 " " 24	2 " " 48a	2 " " 126
1 " " 16	2 " " 35	1 " " 52	2 " " 126a
4 " " 12	20 " " 37	1 " " 57c	4 " " 155
2 " " 16	4 " " 37a	2 " " 90a	2 " " 189
1 " " 19s	2 " " 38	4 " " 111c	

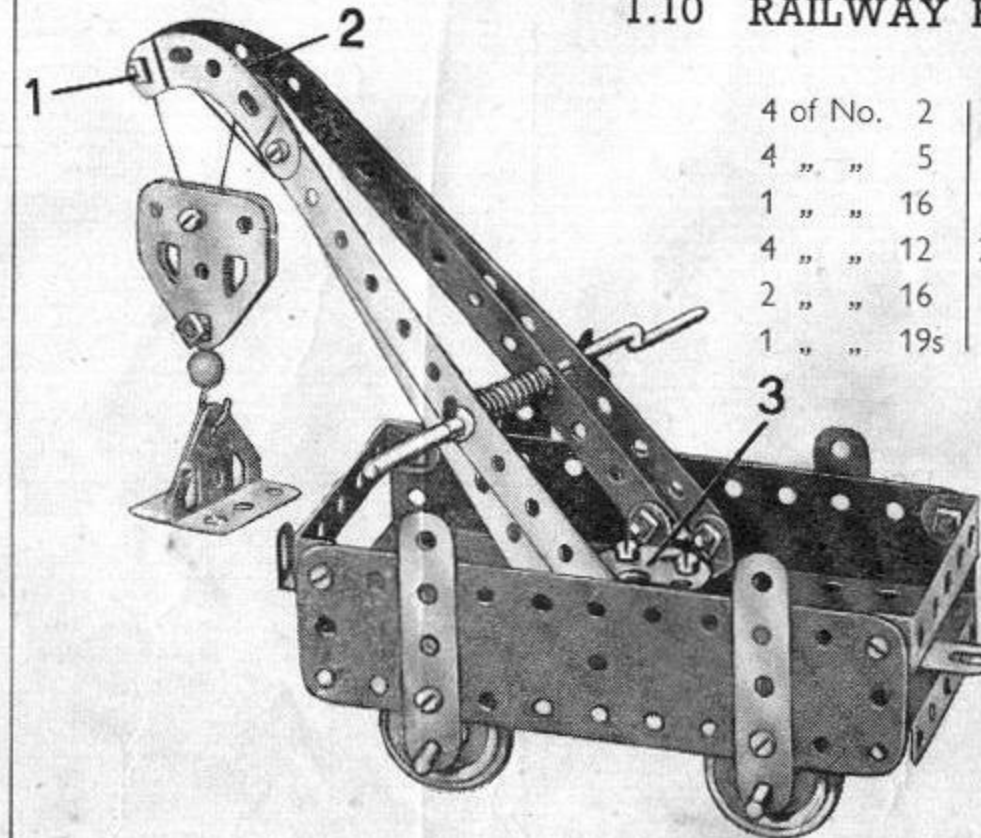

The hoisting cord is secured to the Crank Handle, and then led over the $\frac{3}{8}$ " Bolt 1. It is then passed through the pulley block and fastened to the jib at 2. The jib is attached to the Bush Wheel 3 by means of Angle Brackets and the complete unit is pivoted as follows. A $\frac{3}{8}$ " Bolt is passed through the $5\frac{1}{2}$ " x $2\frac{1}{2}$ " Flanged Plate from the underside, and is secured in the boss of the Bush Wheel by its set screw.

2.1 MOTOR VAN

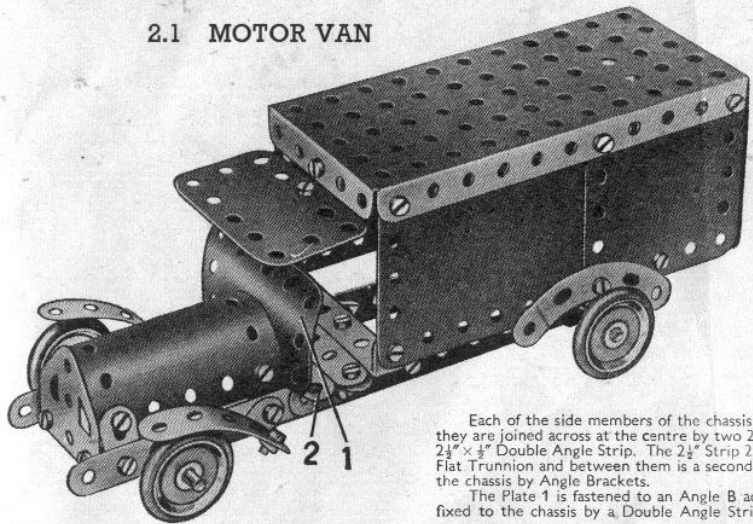

Parts required

4 of No.	2	1 of No.	25
4 " "	5	2 " "	90a
4 " "	10	1 " "	126
8 " "	12	2 " "	126a
2 " "	16	4 " "	155
4 " "	22	2 " "	188
4 " "	35	2 " "	189
40 " "	37	2 " "	190
4 " "	38	1 " "	191
2 " "	48a	1 " "	199

Each of the side members of the chassis consists of two $5\frac{1}{2}$ " Strips overlapped, and they are joined across at the centre by two $2\frac{1}{2}$ " Strips, one of which is shown at 2, and a $2\frac{1}{2}$ " x $\frac{1}{2}$ " Double Angle Strip. The $2\frac{1}{2}$ " Strip 2 and the Double Angle Strip are bolted to a Flat Trunnion and between them is a second $2\frac{1}{2}$ " Strip, which is fastened at each end to the chassis by Angle Brackets.
The Plate 1 is fastened to an Angle Bracket that is bolted to Strip 2. The body is fixed to the chassis by a Double Angle Strip and an Angle Bracket.

2.2 SPEED CAR

A $5\frac{1}{2}$ " x $2\frac{1}{2}$ " Flanged Plate, extended at the front by a $1\frac{1}{8}$ " radius Curved Plate and at the rear by two $2\frac{1}{2}$ " x $2\frac{1}{2}$ " Flexible Plates, forms the top of the car. The rear part of each side is formed by two $5\frac{1}{2}$ " Strips and a $2\frac{1}{2}$ " Strip, the former being connected together at the tail by Angle Brackets. Bolts 1 on each side hold a $2\frac{1}{2}$ " x $\frac{1}{2}$ " Double Angle Strip that carries the $1\frac{1}{8}$ " radius Curved Plate forming the underside of the front cowling.

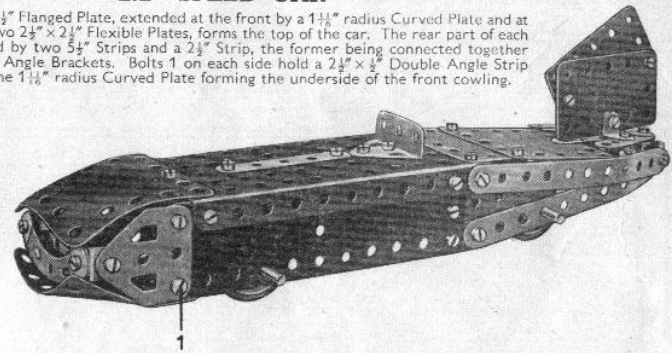

Parts required

4 of No.	2	4 of No.	22	1 of No.	52	2 of No.	188
6 " "	5	38 " "	37	2 " "	90a	2 " "	189
2 " "	10	1 " "	37a	1 " "	126	2 " "	190
4 " "	12	4 " "	38	2 " "	126a	2 " "	200
2 " "	16	2 " "	48a	4 " "	155		

Parts required

4 of No.	2
6 " "	5
4 " "	10
6 " "	12
1 " "	16
1 " "	19g
4 " "	22
1 " "	24

2.3 CANAL BRIDGE

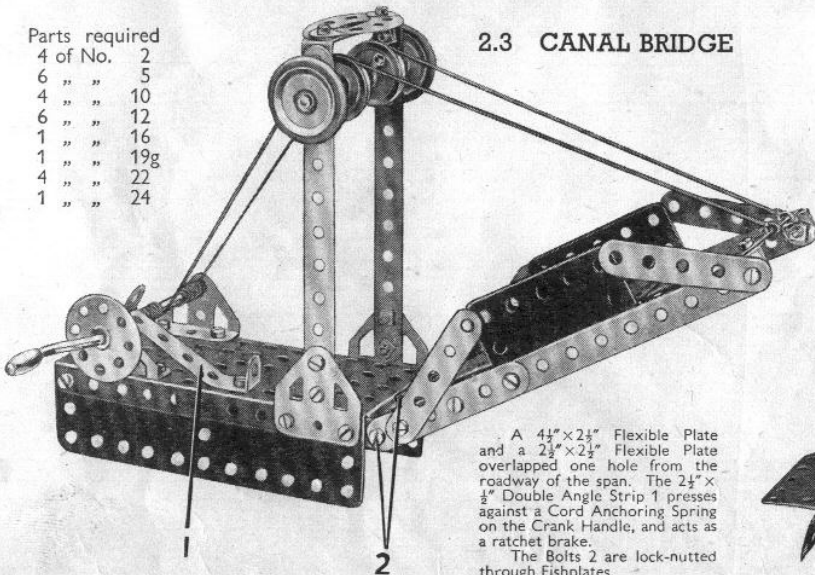

A $4\frac{1}{2}$ " x $2\frac{1}{2}$ " Flexible Plate and a $2\frac{1}{2}$ " x $2\frac{1}{2}$ " Flexible Plate overlapped one hole from the roadway of the span. The $2\frac{1}{2}$ " x $\frac{1}{2}$ " Double Angle Strip 1 presses against a Cord Anchoring Spring on the Crank Handle, and acts as a ratchet brake.
The Bolts 2 are lock-nutted through Fishplates.

Parts required (continued)

39 of No.	37
2 " "	37a
2 " "	38
2 " "	48a
1 " "	52
2 " "	90a
2 " "	126
2 " "	126a
2 " "	155
1 " "	176
2 " "	188
2 " "	189
2 " "	190
1 " "	191
1 " "	199
1 " "	200



2.4 DRILLING MACHINE

The horizontal $2\frac{1}{2}$ " Strips at the top of the drill are joined together, and also to the vertical $2\frac{1}{2}$ " Strips, by means of Angle Brackets. The lower bearings 1 are two Angle Brackets bolted to a $2\frac{1}{2}$ " Strip, and the Rod forming the drill is journaled in these, and in a Fishplate at its upper end. A $2\frac{1}{2}$ " x $2\frac{1}{2}$ " Flexible Plate is supported by a Double Angle Strip 2, and represents the table.

The drive is taken from the Motor to the 1" Pulley on the lower shaft. A second Driving Band passes round the $\frac{1}{2}$ " fixed Pulley supplied with the Motor, which is also fixed on the lower shaft, round the two Pulleys at 3, and finally round the 1" Pulley fastened on the vertical drill shaft.

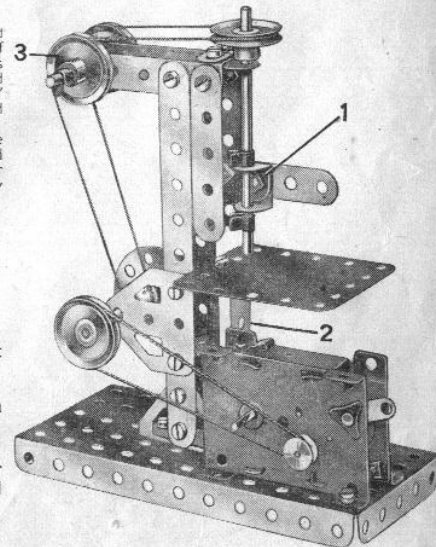

Parts required

2 of No.	2	1 of No.	24	1 of No.	111c
5 " "	5	4 " "	35	2 " "	126
1 " "	10	22 " "	37	2 " "	126a
5 " "	12	2 " "	37a	1 " "	190
1 " "	16	1 " "	40		
2 " "	17	1 " "	48a		
4 " "	22	1 " "	52		

1 Magic Motor (Not included in Outfit)

2.5 RAILWAY BREAKDOWN CRANE

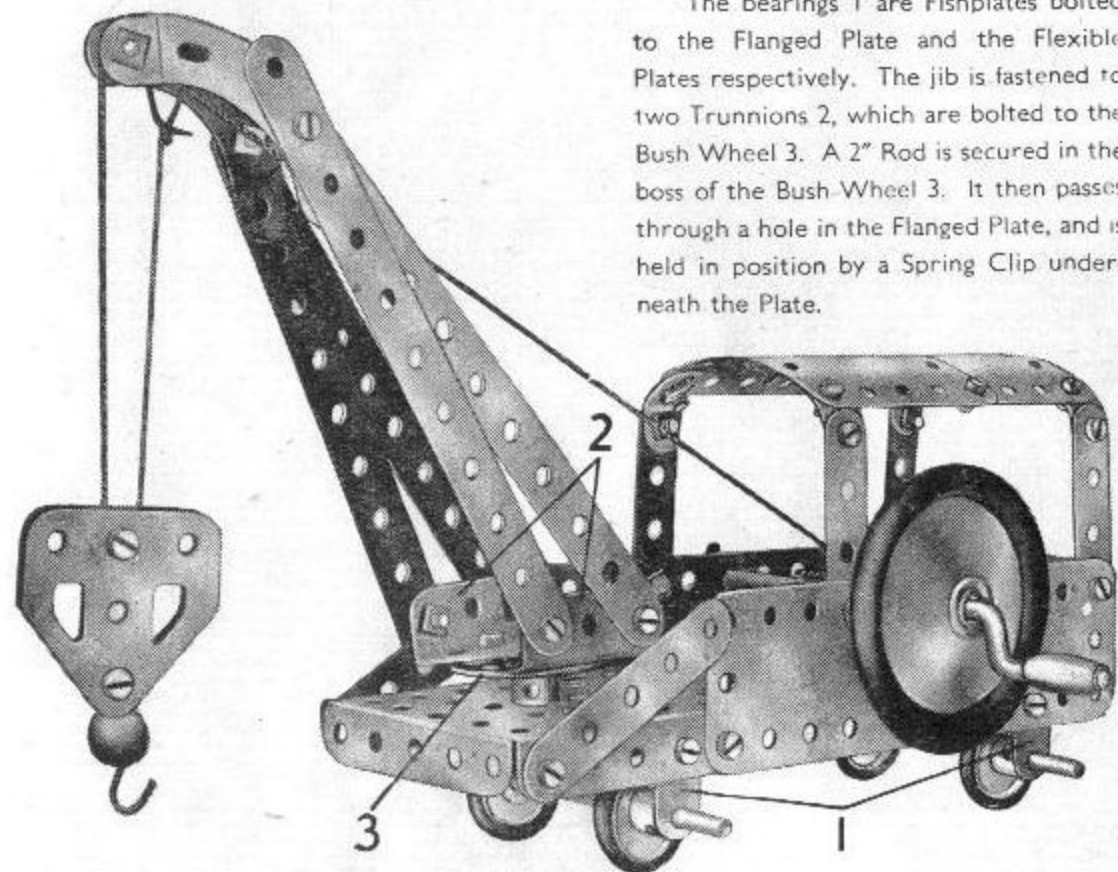

The bearings 1 are Fishplates bolted to the Flanged Plate and the Flexible Plates respectively. The jib is fastened to two Trunnions 2, which are bolted to the Bush Wheel 3. A 2" Rod is secured in the boss of the Bush Wheel 3. It then passes through a hole in the Flanged Plate, and is held in position by a Spring Clip underneath the Plate.

Parts required	
4 of No.	2
6 " "	5
4 " "	10
3 " "	12
2 " "	16
1 " "	17
1 " "	19g
4 " "	22
1 " "	24
2 " "	35
39 " "	37
3 " "	37a
3 " "	38
1 " "	40
2 " "	48a
1 " "	52
1 " "	57c
2 " "	90a
3 " "	111c
2 " "	126
2 " "	126a
1 " "	155
1 " "	176
1 " "	187
1 " "	188
2 " "	189
1 " "	190
2 " "	200

2.6 FLOATING CRANE

The jib consists of 5½" Strips and 2½" Strips. At its upper end these are joined by Angle Brackets, and at its lower end by Trunnions. Each side of the lower part of the crane consists of 2½" Strips and a small radius Curved Strip, the two sides being connected by a 2½" × ½" Double Angle Strip. The jib is pivoted to this structure by means of a 3½" Rod, which carries at each end a 1" Pulley. The Cord 1 fitted with a Loaded Hook, is passed over a 2" Rod held in place in the jib by means of Spring Clips and is then wound around the Crank Handle.

The Cord 2 passes over a Rod held in the jib by a Cord Anchoring Spring, and is then wound around the Rod that forms the pivot for the jib. A third Cord is tied to a Bolt fastened in the two Trunnions at the base of the jib, and is wound round Rod 3. This Cord controls the luffing motion of the crane. A ⅜" Bolt passes through the Flanged Plate and is held by a set screw in the boss of the Bush Wheel to which the jib is fastened. The Bush Wheel is bolted to the Double Angle Strip below the Rod 3. The roof of the cabin is bolted to a ½" Reversed Angle Bracket fixed to the Flanged Plate.

Parts required			
4 of No.	2	2 of No.	48a
6 " "	5	1 " "	52
3 " "	10	1 " "	57c
8 " "	12	2 " "	90a
2 " "	16	4 " "	111c
2 " "	17	1 " "	125
1 " "	19g	2 " "	126
4 " "	22	1 " "	126a
1 " "	24	1 " "	176
4 " "	35	2 " "	188
29 " "	37	2 " "	189
4 " "	37a	1 " "	199
4 " "	38	1 " "	200
1 " "	40		

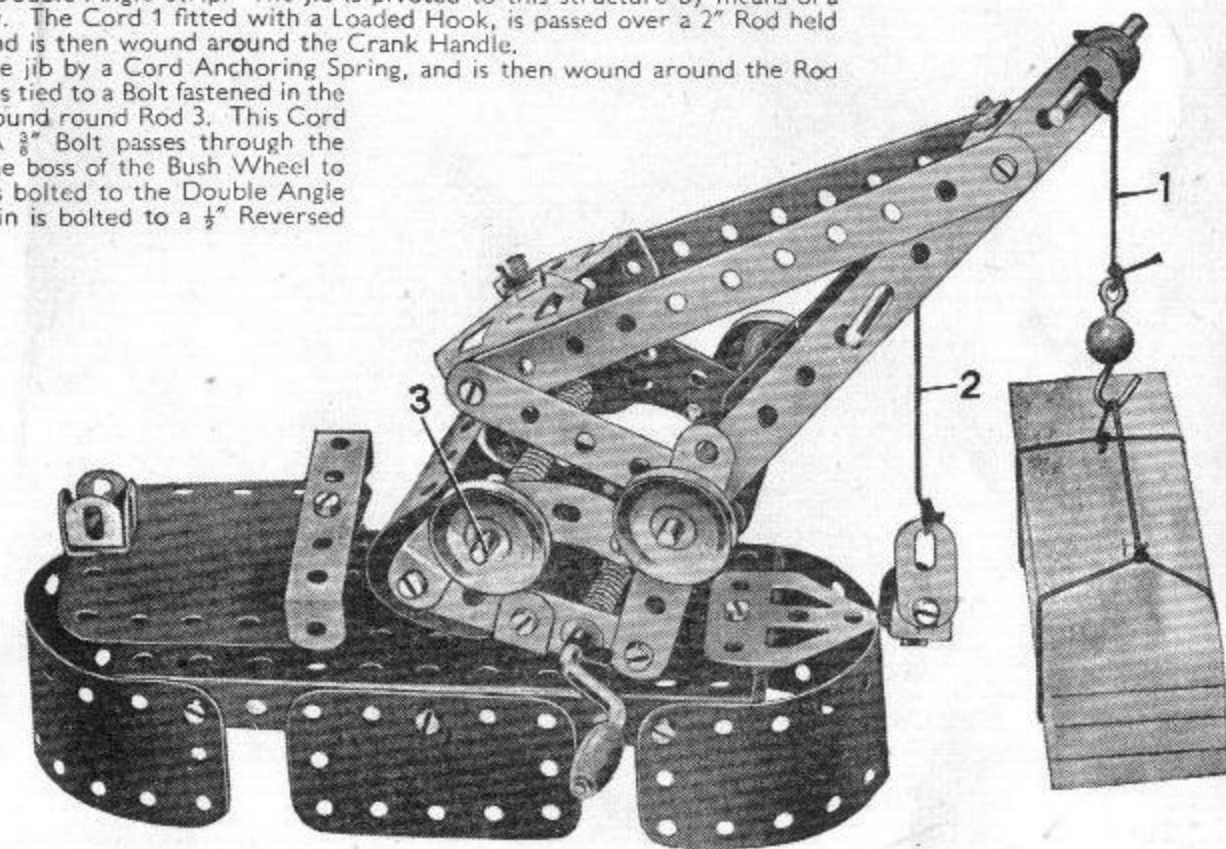

2.7 RACING CAR

Parts required					
4 of No.	2	1 of No.	19g	2 of No.	38
5 " "	5	4 " "	22	1 " "	48a
4 " "	10	4 " "	35	2 " "	90a
8 " "	12	30 " "	37	1 " "	125
2 " "	16	1 " "	37a	1 " "	126
1 of No.	126a	4 " "	155	1 " "	199
		1 " "	200		

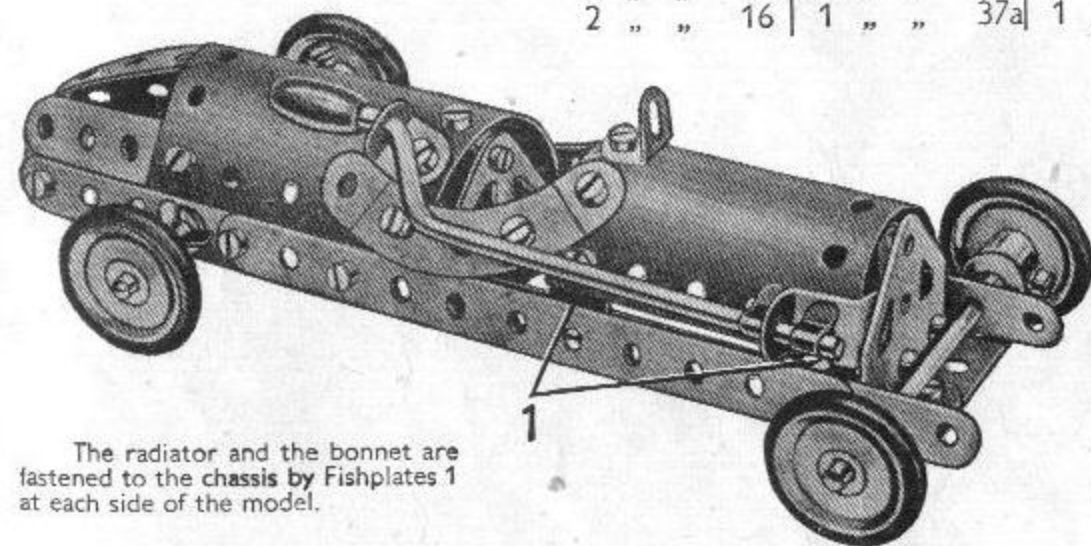

The radiator and the bonnet are fastened to the chassis by Fishplates 1 at each side of the model.

Parts required	
3 of No.	2
6 " "	5
1 " "	10
8 " "	12
1 " "	16
1 " "	17
1 " "	19g
4 " "	22
1 " "	24
2 " "	35
36 " "	37
4 " "	37a
3 " "	38
1 " "	40
2 " "	48a
1 " "	52
2 " "	90a
1 " "	125
2 " "	126a
1 " "	187
2 " "	188
2 " "	189
2 " "	190

2.8 BACON SLICER

The base of the model consists of a Flanged Plate fitted with four 2½" Strips for legs. Two 5½" × 1½" and two 2½" × 1½" Flexible Plates are bolted to the flanges of the Plate.

The guides for the sliding carriage 4 are formed by two 5½" Strips attached to the Flanged Plate by Angle Brackets. The carriage consists of a 2½" × 2½" Flexible Plate 4 and is guided along the Strips by the Reversed Angle Bracket 1 and two Angle Brackets on the opposite side. The Angle Brackets are held in place by Bolts 5.

The cutting blade is represented by a Road Wheel fixed on a 3½" Rod journalled in two Flat Trunnions. A Pulley on this Rod is connected by a belt of Cord to a second Pulley on the Crank Handle.

The carriage is moved backwards and forwards by a crank consisting of a Bush Wheel 6 fixed on a 2" Rod. This Rod is journalled in the Flanged Plate and in the centre hole of a Double Angle Strip fixed across the interior of the base by the Bolt 2 and another in a similar position on the opposite side. A 1" Pulley on the 2" Rod is connected by a crossed belt of Cord to a further 1" Pulley secured to the Crank Handle between the 5½" Flexible Plates.

A guard for the rotating blade is provided by two Curved Strips attached to a 5½" Strip 3. This Strip is fastened at one end to the Flanged Plate by a 2½" Strip and a Fishplate 7, and at its other end it is attached to a 2½" × 2½" Flexible Plate bolted horizontally to the Flanged Plate.

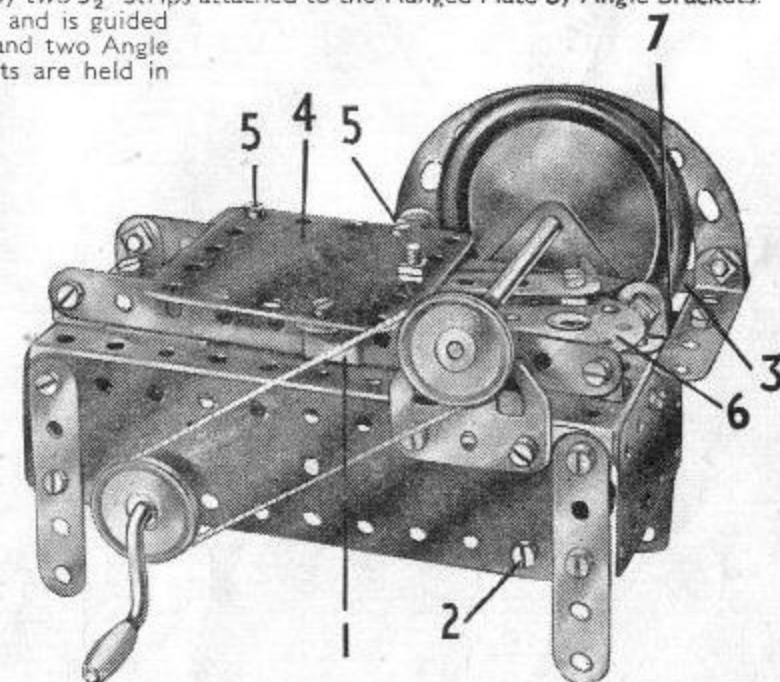

2.9 TRAMCAR

Parts required	
4 of No. 2	4 of No. 38
6 " " 5	1 " " 40
2 " " 10	2 " " 48a
4 " " 12	1 " " 52
2 " " 16	2 " " 90a
1 " " 19g	4 " " 111c
4 " " 22	1 " " 125
2 " " 35	2 " " 126
40 " " 37	2 " " 126a
6 " " 37a	

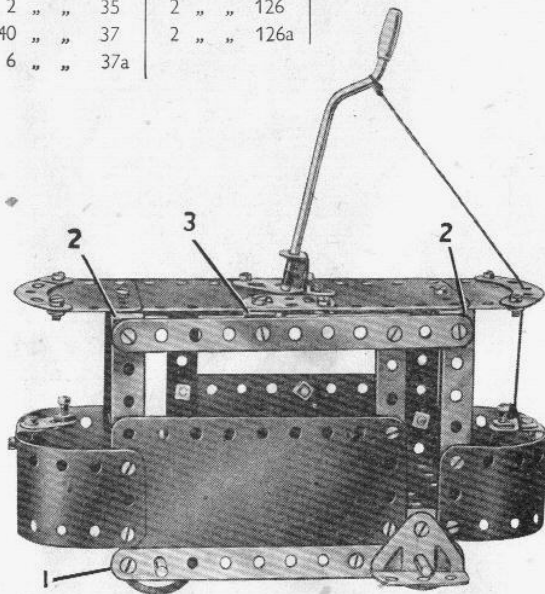

Two $5\frac{1}{2} \times 1\frac{1}{2}$ Flexible Plates are curved and bolted across the ends of a Flanged Plate to form the driving compartments at each end, and a $4\frac{1}{2} \times 2\frac{1}{2}$ Flexible Plate is used for one side of the model. This also is bolted to the Flanged Plate. The other side consists of two $1\frac{1}{2}$ radius Curved Plates, flattened and bolted in position. Both sides are strengthened by a $5\frac{1}{2}$ Strip, one of which is seen at 1.

The roof is supported on each side by three $2\frac{1}{2}$ Strips, connected at their upper ends by a $5\frac{1}{2}$ Strip. The roof is in halves, each half consisting of a $2\frac{1}{2} \times 1\frac{1}{2}$ and a $2\frac{1}{2} \times 2\frac{1}{2}$ Flexible Plate. The halves are joined at the centre by two Flat Trunnions, and the roof is secured to the Double Angle Strips 2 and Angle Brackets 3 on each side. A Crank Handle is used to reorient the trolley pole and it is held in the Flat Trunnions and a Reversed Angle Bracket by Spring Clips.

The wheels are 1" Pulleys fixed on $3\frac{1}{2}$ Rods that run in holes in the sides of the model.

2.10 PETROL-ENGINED STATION TRACTOR

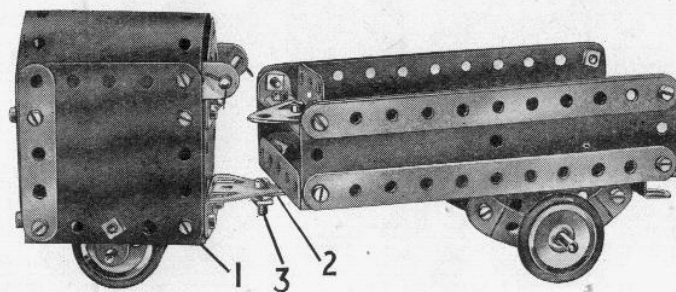

Each side of the tractor unit consists of a $2\frac{1}{2} \times 2\frac{1}{2}$ Flexible Plate bolted to a Double Angle Strip 1. A $4\frac{1}{2} \times 2\frac{1}{2}$ Flexible Plate is curved and attached to each side to form the top. The front and rear of the unit are each filled by a $2\frac{1}{2} \times 1\frac{1}{2}$ Flexible Plate and a Flat Trunnion. The front axle is mounted in two Fishplates.

The load carrier is made by bolting $5\frac{1}{2} \times 1\frac{1}{2}$ Flexible Plates to the sides of a Flanged Plate. The rear axle is carried in two Curved Strips, which are attached to $2\frac{1}{2}$ Strips and secured to the Flanged Plate by Angle Brackets.

The tractor unit and the load carrier are connected by a Trunnion bolted to the tractor and a $2\frac{1}{2}$ Strip 2 secured to the base of the load carrier. The $\frac{3}{8}$ " Bolt 3 is passed through holes in these parts and is fitted with lock-nuts.

Parts required	
4 of No. 2	2
6 " " 5	5
4 " " 10	10
8 " " 12	12
1 " " 16	16
2 " " 17	17
4 " " 22	22
2 " " 35	35
40 " " 37	37
4 " " 37a	37a
4 " " 38	38
2 " " 48a	48a
1 " " 52	52
2 " " 90a	90a
3 " " 111c	111c
1 " " 125	125
2 " " 126	126
2 " " 126a	126a
4 " " 155	155
2 " " 188	188
2 " " 189	189
2 " " 190	190
1 " " 191	191

2.11 MECHANICAL HACKSAW

The base consists of Flexible Plates bolted to a Flanged Plate. One side is formed by a $4\frac{1}{2} \times 2\frac{1}{2}$ and a $2\frac{1}{2} \times 1\frac{1}{2}$ Flexible Plate, and the other by two $5\frac{1}{2} \times 1\frac{1}{2}$ Plates. A $2\frac{1}{2} \times 2\frac{1}{2}$ Flexible Plate is bolted to each end. The base is strengthened at each end by Double Angle Strips 1 and a $5\frac{1}{2}$ Strip on each side.

The saw is actuated by a crank formed from a Bush Wheel fixed to a $3\frac{1}{2}$ Rod. The Rod rotates in a Trunnion and a Flat Trunnion. The Trunnion is raised from the Flanged Plate by two Washers. The Rod carries a 1" Pulley 2 and a Road Wheel. The Pulley 2 is connected by a belt of Cord to a similar Pulley fixed on the Crank Handle.

The material to be sawn is clamped to the base by means of two $2\frac{1}{2}$ Strips, one of which is shown at 3.

Parts required	
3 of No. 2	1 of No. 40
6 " " 5	2 " " 48a
2 " " 12	1 " " 52
2 " " 16	4 " " 111c
1 " " 19g	1 " " 126
3 " " 22	1 " " 126a
1 " " 24	1 " " 187
30 " " 37	1 " " 188
8 " " 37a	2 " " 189
4 " " 38	2 " " 190
	1 of No. 191

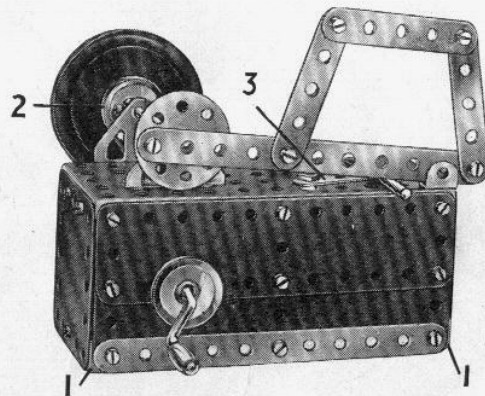

2.12 BEAM ENGINE

Parts required		
4 of No. 2	1 of No. 16	3 of No. 38
4 " " 5	2 " " 17	1 " " 40
7 " " 12	1 " " 19g	1 " " 52
	3 " " 22	2 " " 90a
	1 " " 24	2 " " 111c
	4 " " 35	1 " " 126
	32 " " 37	1 " " 126a
	5 " " 37a	1 " " 176
		1 " " 187
		2 " " 188
		2 " " 189
		1 Magic Motor
		(Not included in Outfit)

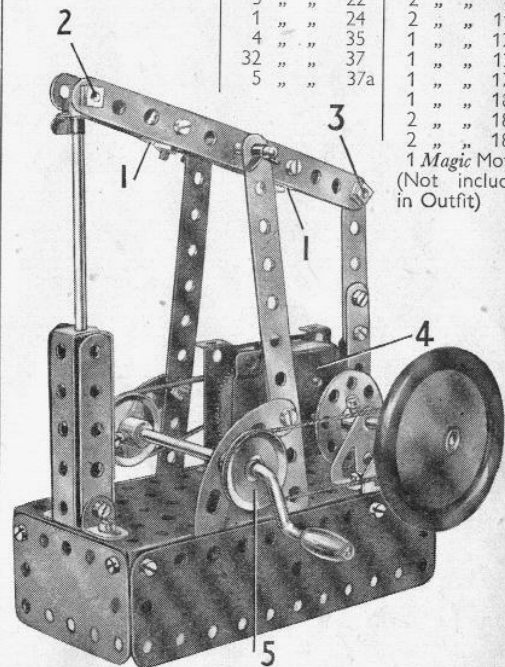

The engine bed or base consists of two $5\frac{1}{2} \times 1\frac{1}{2}$ and two $2\frac{1}{2} \times 1\frac{1}{2}$ Flexible Plates bolted to the sides of a Flanged Plate. Two $5\frac{1}{2}$ Strips form the supports for the beam, which pivots on a 2 " Rod held in position by Spring Clips.

The beam is made from two $5\frac{1}{2}$ Strips held together by four Angle Brackets 1, which are bolted in pairs to form two U-shaped pieces.

The cylinder consists of two $2\frac{1}{2} \times \frac{1}{2}$ Double Angle Strips and two $2\frac{1}{2}$ Strips. The piston rod is a $3\frac{1}{2}$ Rod attached to the beam by an Angle Bracket, the Bolt 2 that holds the Bracket being lock-nutted. The Rod is pivoted on the Angle Bracket by Spring Clips. The connecting rod is pivoted on a bolt lock-nutted to a Bush Wheel held on a 2 " Rod journaled in a Trunnion and a Flat Trunnion. This Rod also carries a 1" Pulley and a Road Wheel. At its upper end the connecting rod is attached to the beam by the lock-nutted bolt 3.

The Magic Motor 4 is bolted to the base by its flanges, and its pulley is connected by a Driving Band to a 1" Pulley on the Crank Handle. A further 1" Pulley 5 on the Crank Handle is connected by a belt of Cord to the Pulley on the 2 " Rod.

2.13 TRAVELLING CRANE

A 2" Rod is secured in the boss of the Bush Wheel 3. It then passes through the Road Wheel and through the centre of a 2½" x ½" Double Angle Strip bolted between the two Trunnions 1. A Washer and a Cord Anchoring Spring are pushed on to the Rod to hold it in position. The crane jib is attached to the Bush Wheel by the Angle Brackets 2.

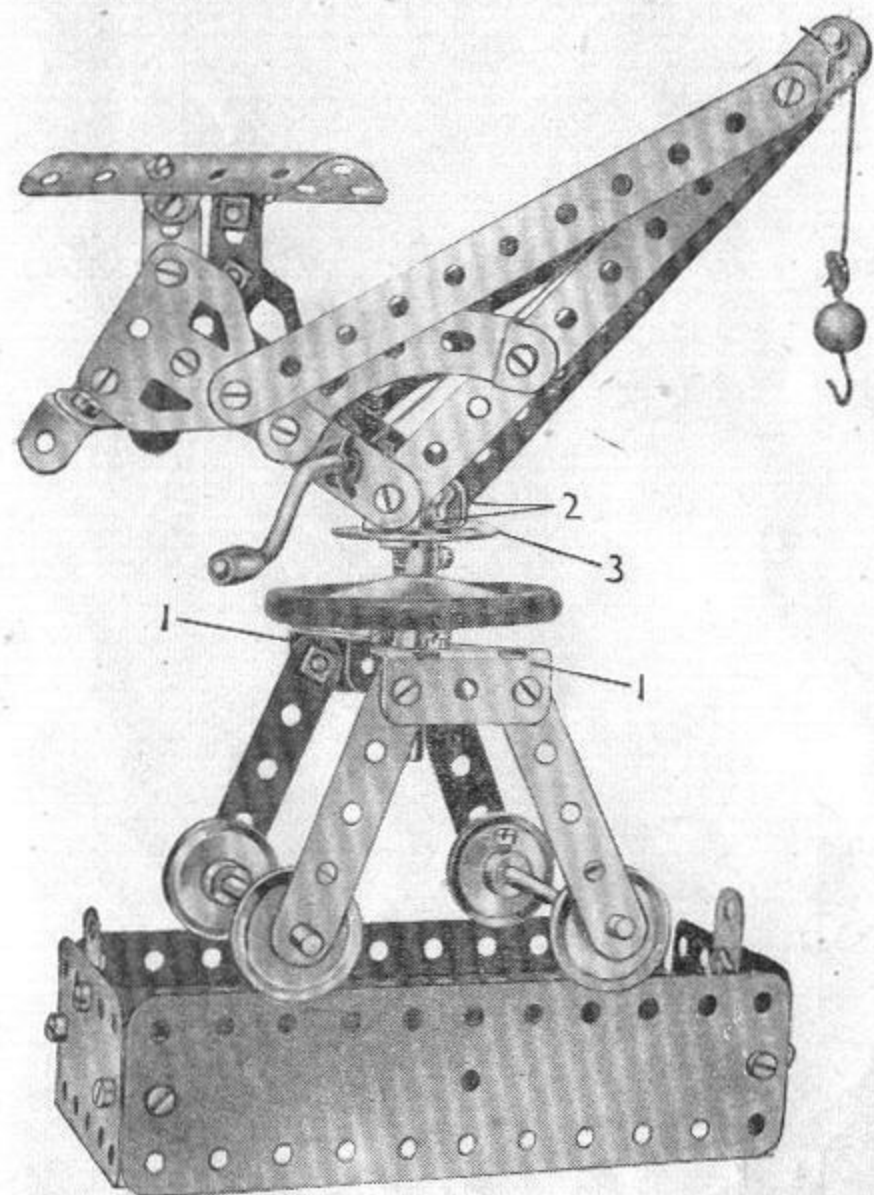

Parts required

4 of No. 2	4 of No. 22	2 of No. 48a	1 of No. 176
6 " " 5	1 " " 24	1 " " 52	1 " " 187
4 " " 10	4 " " 35	1 " " 57c	2 " " 188
6 " " 12	38 " " 37	2 " " 90a	2 " " 189
2 " " 16	2 " " 37a	2 " " 111c	1 " " 200
2 " " 17	3 " " 38	2 " " 126	
1 " " 19g	1 " " 40	2 " " 126a	

2.14 LAWN MOWER

The "cutter" is made by bolting an Angle Bracket at each end of a Reversed Angle Bracket 1 and then sliding an Axle Rod through the free holes of the Brackets. The two Pulleys 2 are fixed to the Rod and pushed tightly against the "cutter" to make it rotate with the Rod as the wheels revolve. The wheels are 1" Pulleys fitted with Rubber Rings.

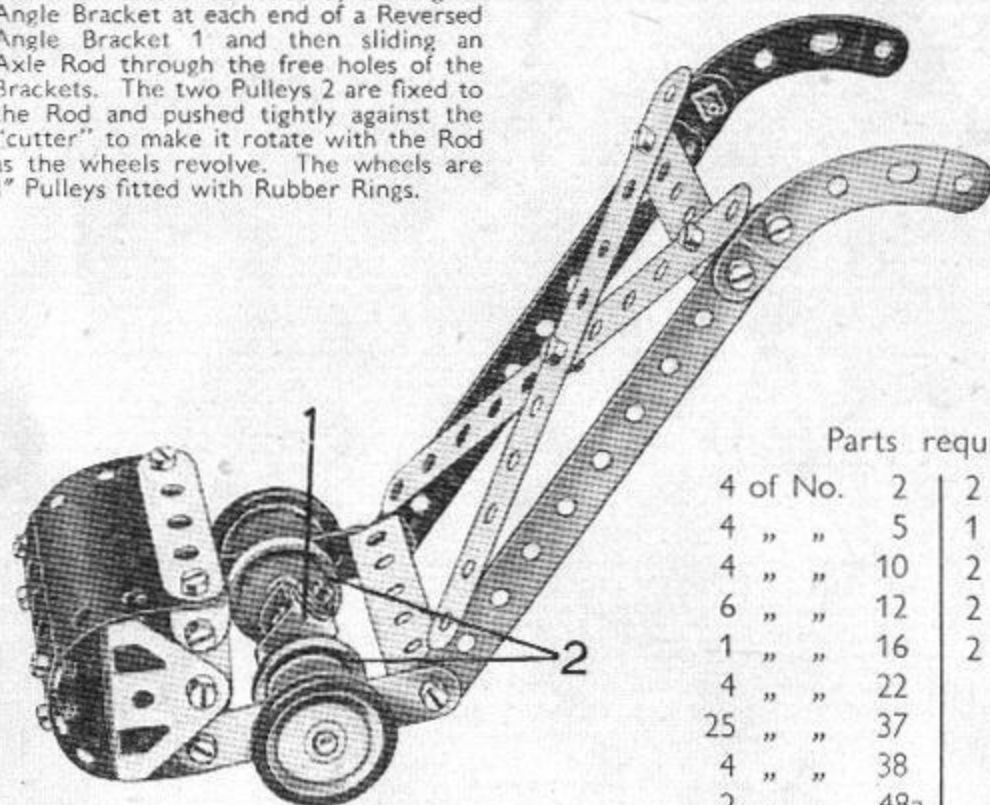

Parts required

4 of No. 2	2 of No. 90a
4 " " 5	1 " " 125
4 " " 10	2 " " 126
6 " " 12	2 " " 155
1 " " 16	2 " " 200
4 " " 22	
25 " " 37	
4 " " 38	
2 " " 48a	

2.15 LUMBER TRUCK AND HORSE

A Magic Motor is mounted beneath the cart, and the Driving Band is taken from the pulley on the Motor to a ½" fixed Pulley (supplied with the Motor) fastened on the 3½" Rod that forms the front axle.

The forelegs of the horse are held together by means of two Angle Brackets bolted in the positions shown. This construction is duplicated at 1 for the hind-legs. The forelegs of the horse are held clear of the ground by the reins.

Parts required

4 of No. 2	4 of No. 35	2 of No. 126a
5 " " 5	23 " " 37	4 " " 155
3 " " 10	4 " " 37a	1 " " 199
6 " " 12	2 " " 48a	1 Magic Motor
2 " " 16	1 " " 52	(Not included
2 " " 17	2 " " 90a	in Outfit)
4 " " 22	4 " " 111c	
1 " " 24	2 " " 126	

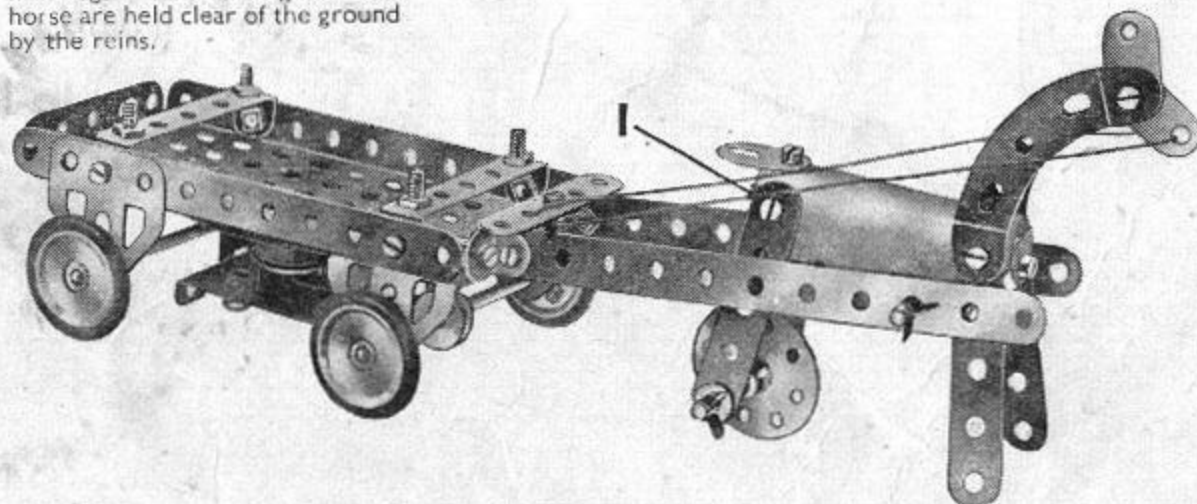

2.16 PUNCHING MACHINE

Parts required

4 of No. 2
6 " " 5
2 " " 10
8 " " 12
1 " " 16
2 " " 17
4 " " 22
1 " " 24
4 " " 35
40 " " 37
4 " " 37a
3 " " 38
2 " " 48a
1 " " 52
2 " " 90a
3 " " 111c
2 " " 126
2 " " 126a
4 " " 155
1 " " 176
2 " " 188
2 " " 189
1 " " 199

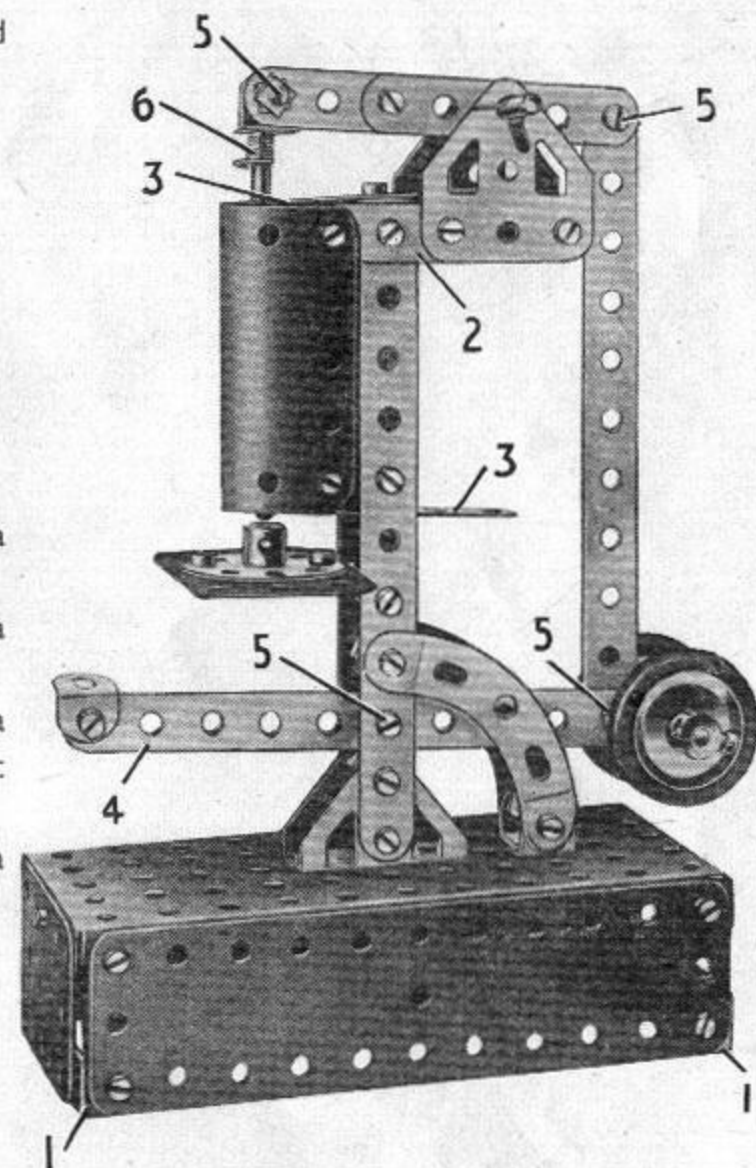

The base consists of a Flanged Plate, which is edged with two 5½" x 1½" and one 2½" x 1½" Flexible Plates. The 5½" x 1½" Plates are braced together by the Double Angle Strips 1 at each end.

An upright column is formed from two 5½" Strips fastened to two Trunnions attached to the base. They are joined at their upper ends by two Angle Brackets fixed together to form a U-shaped piece. A ½" radius Curved Plate is attached to the column at the top by a 2½" Strip 2 and at its lower end by two Fishplates. The punch rod passes through holes in 2½" guide Strips 3.

Strips 2, one at each side of the machine, provide supports for two Flat Trunnions that carry a rocker arm. This is formed by two 2½" Strips overlapped three holes, and it is pivoted on a 2" Rod held in the Flat Trunnions. One end of the arm is connected by an Angle Bracket to a 3½" Rod representing the punching tool. The Rod is held in a hole of the Angle Bracket by means of a Spring Clip and a Cord Anchoring Spring 6. The rear end of the arm is connected to the foot-operated lever 4 by a 5½" Strip. The lever is weighted by four 1" Pulleys fixed on a 2" Rod.

The Bolts 5 seen at different points of the model are each lock-nutted.

The punching table is formed by a Bush Wheel bolted to a 2½" x 1½" Flexible Plate attached to the column by a Fishplate and Angle Bracket.

3.1 TOWER WAGON

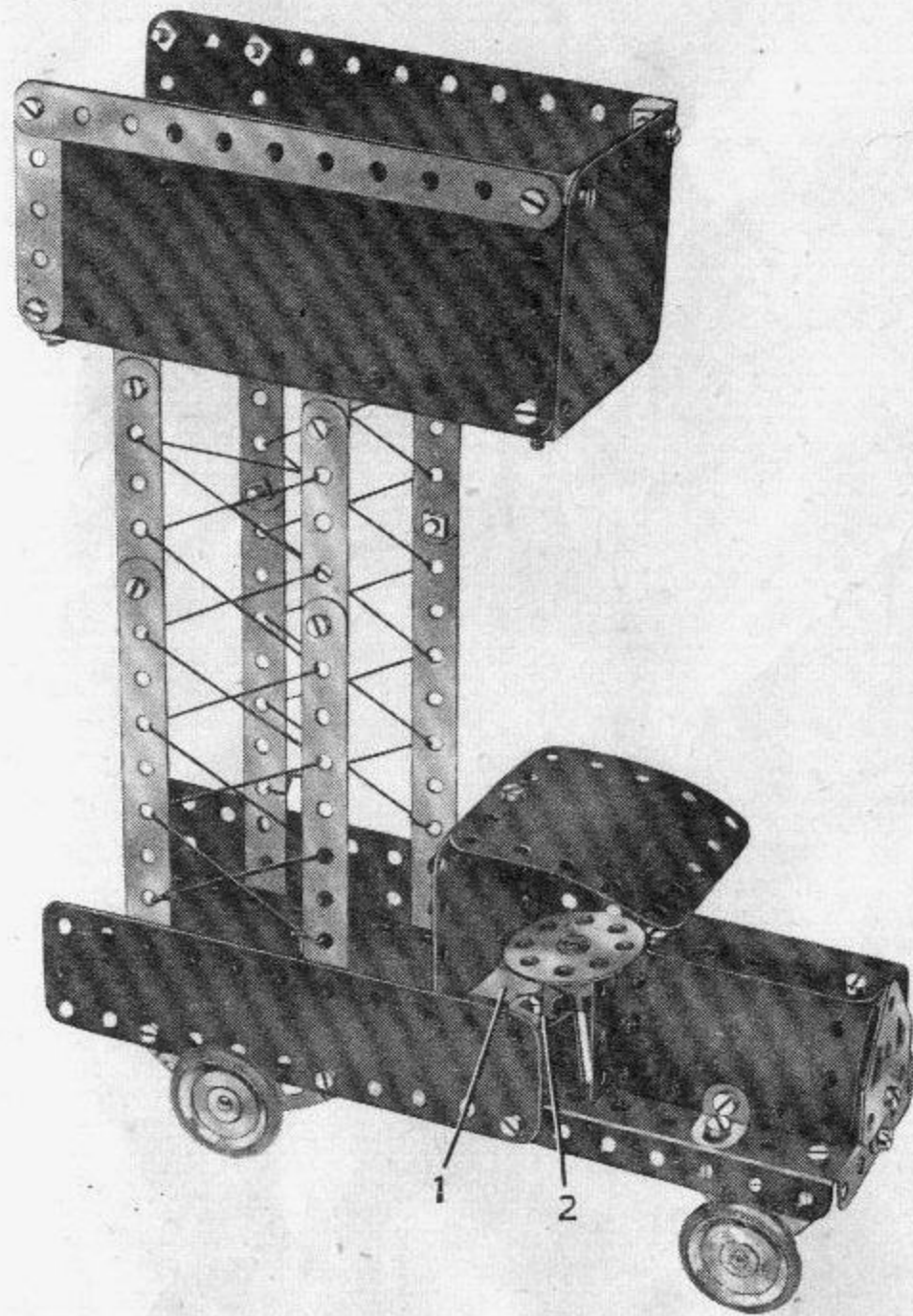

A Stepped Bent Strip 1 is bolted in a horizontal position in the centre of the Flanged Plate, and a $2\frac{1}{2}$ " Curved Strip is bolted on top of it by the centre hole, to form a seat. A Reversed Angle Bracket 2 is then bolted in one of the elongated holes of the Curved Strip to form a bearing for the Rod carrying the Bush Wheel.

3.2 TANK

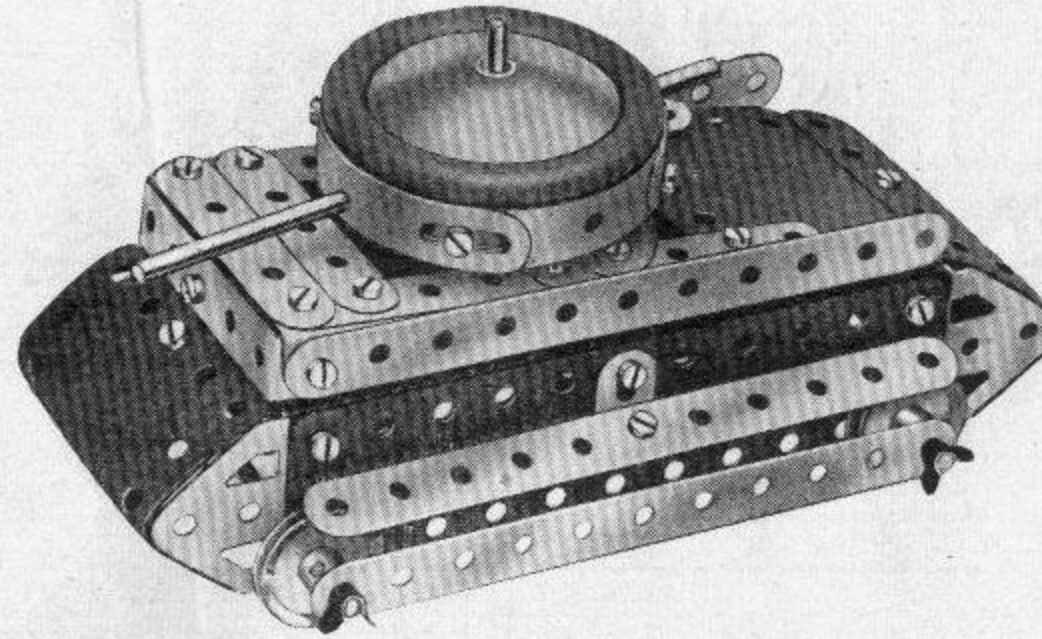

Construction of the gun turret is commenced by bolting a $2\frac{1}{2}$ " Strip across a Bush Wheel. Four 3" Formed Slotted Strips are bolted together to form a circle and fastened to the $2\frac{1}{2}$ " Strip by means of Angle Brackets. Next two Angle Brackets are bolted to the Bush Wheel in the positions shown in Fig. 3.2a. Two Rods are pushed through holes in the Formed Slotted Strips and through the free holes of the Angle Brackets, and are fastened in position by means of Spring Clips. The turret is held in place by a $3\frac{1}{2}$ " Rod that is locked in the boss of the Bush Wheel and then passed through the $5\frac{1}{2} \times 2\frac{1}{2}$ " Flanged Plate and through a hole in a Reversed Angle Bracket. A Cord Anchoring Spring is then screwed on to it to hold it in position. To complete the turret a Road Wheel is fastened on the upper end of the $3\frac{1}{2}$ " Rod. The Reversed Angle Bracket is bolted to the $5\frac{1}{2} \times 2\frac{1}{2}$ " Flanged Plate.

The *Magic Motor* is bolted to the Flanged Plate, and the drive is taken to the back axle by means of a Driving Band.

Note: The Motor used in this model is not included in the Outfit.

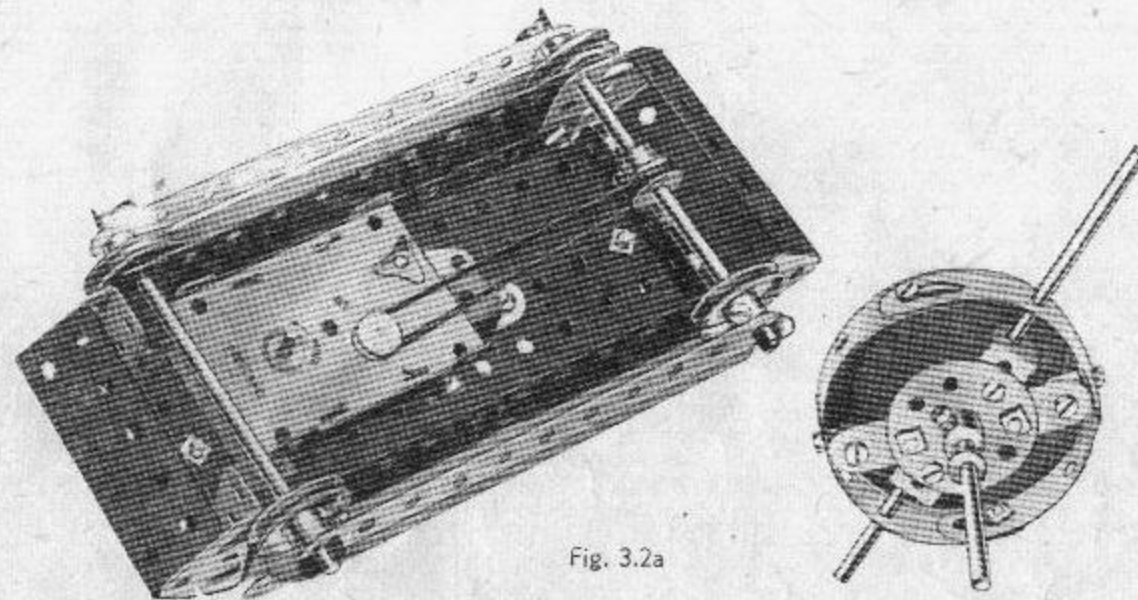

Fig. 3.2a

3.3 PORTABLE GARAGE CRANE

A Flanged Plate 1 is extended on each side by $5\frac{1}{2}$ " Strips 2. The Road Wheels are locked on a $3\frac{1}{2}$ " Rod supported in $2\frac{1}{2}$ " Curved Strips 3 on each side of the model. The 1" Pulleys rotate on $\frac{3}{8}$ " Bolts passed through Flat Trunnions.

The jib is built up from two $12\frac{1}{2}$ " Strips bolted to the sides of the Flanged Plate and extended at their upper ends by Curved Strips. It is held rigid by $5\frac{1}{2}$ " Strips fixed to the Flanged Plate and also to Semi-Circular Plates fastened to the $12\frac{1}{2}$ " Strips.

The handle used for hauling and manoeuvring the crane truck is represented by the $3\frac{1}{2}$ " Rod 4, fitted with a Bush Wheel to which a $2\frac{1}{2}$ " Strip is bolted. The other end of the rod carries a Rod and Strip Connector that pivots on a Bolt between two Trunnions bolted to the Double Angle Strip 5.

The hoisting Cord is tied to a Cord Anchoring Spring on the Crank Handle and then passed over a 1" Pulley at the jib head. It passes around a $\frac{1}{2}$ " Pulley in the pulley block and is then tied to one of the Curved Strips. The pulley block consists of a $\frac{1}{2}$ " Pulley held between two Fishplates on a $\frac{3}{8}$ " Bolt fitted with lock-nuts.

The brake is a belt of Cord, which is passed around a 1" Pulley on the Crank Handle and then fastened to a weighted compound strip 6. This strip is made up from two $2\frac{1}{2}$ " Strips bolted together, and to its outer end two Wheel Discs are attached. The other end of the Strip is pivoted on a $\frac{3}{8}$ " Bolt 7. The Bolt is fitted with lock-nuts.

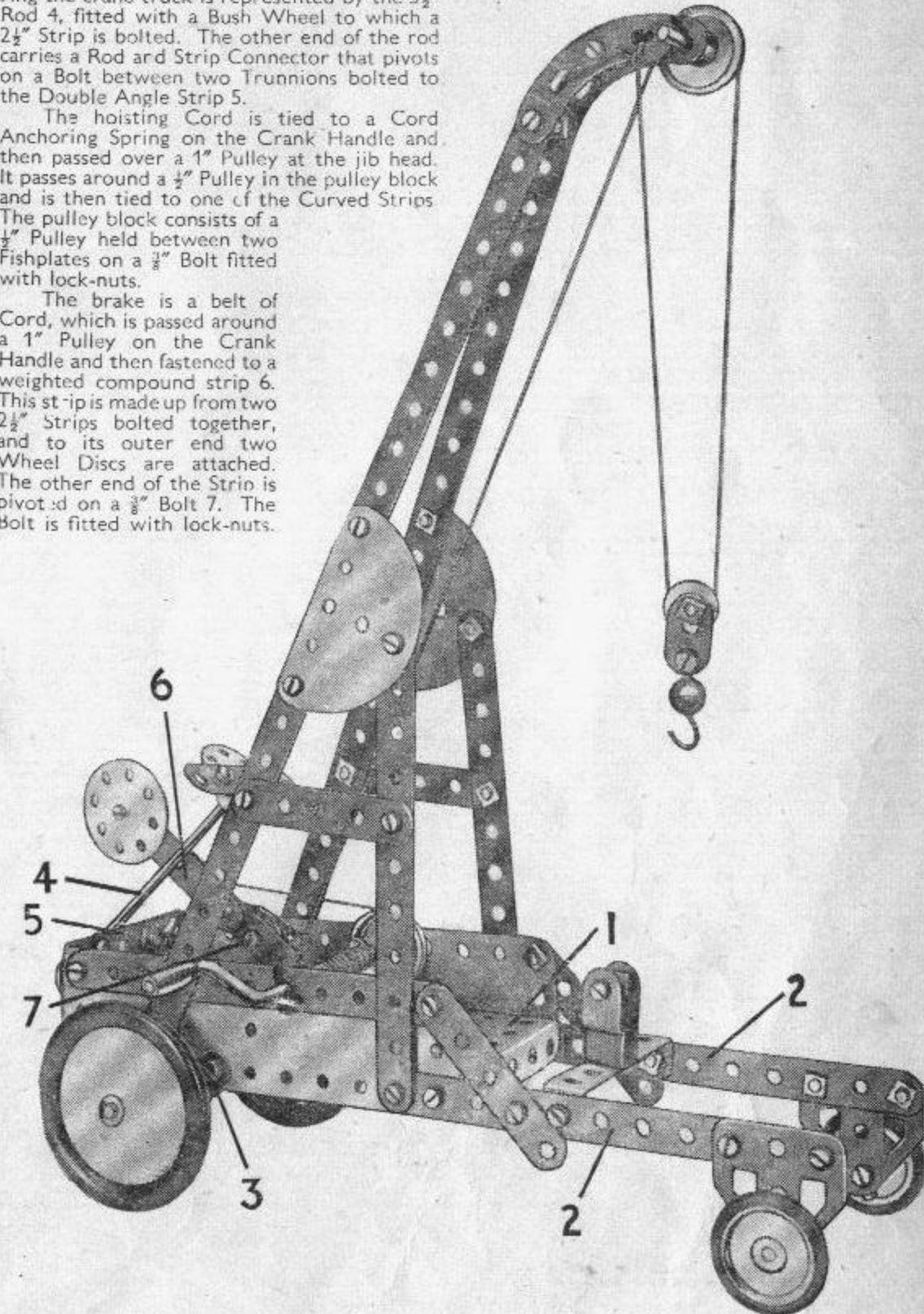

3.4 HORSE AND CART

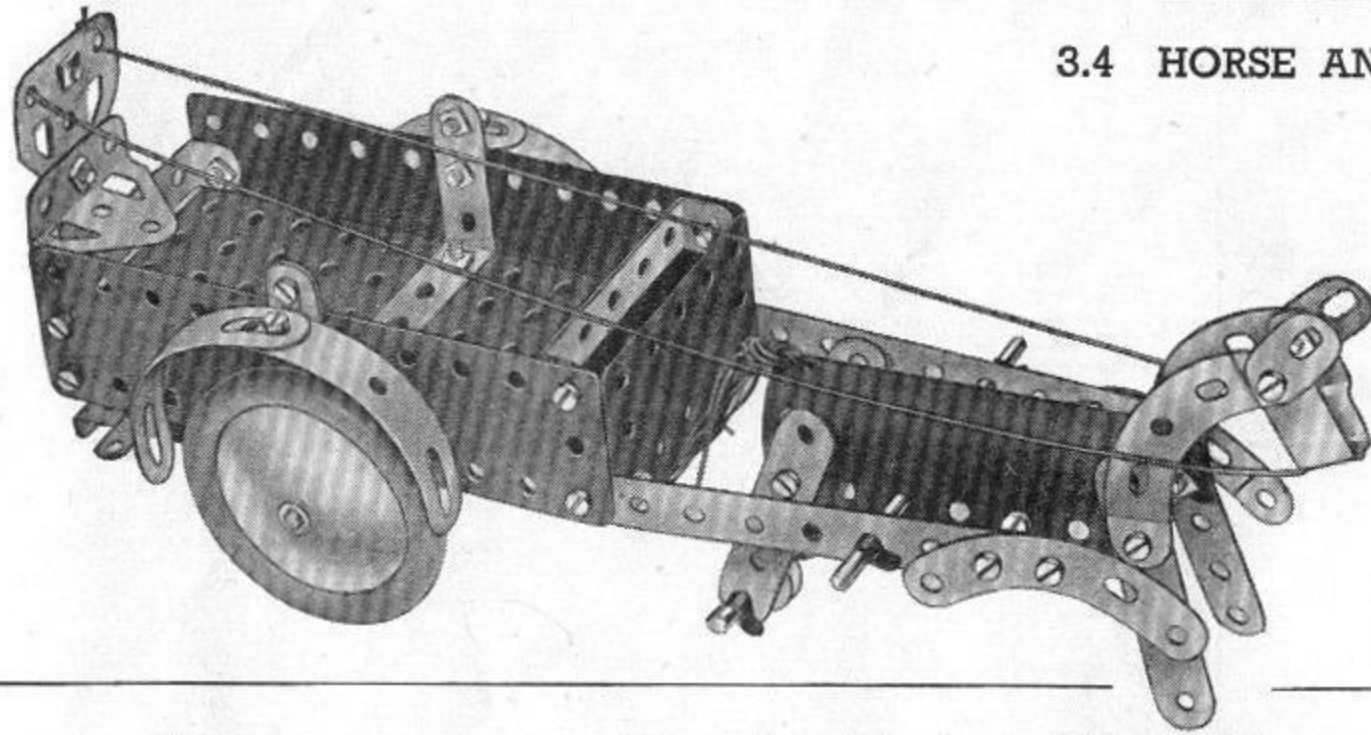

The model is driven by a *Magic* Motor fastened underneath the $5\frac{1}{2} \times 2\frac{1}{2}$ Flanged Plate that forms the bottom of the cart. The drive is taken by a Driving Band from the pulley of the Motor to a $\frac{1}{4}$ fast Pulley on the back axle. A $\frac{1}{4}$ loose Pulley is fitted on a 2" Rod journalled in the bottom holes of the Strips forming the hind-legs of the horse, so that the model will travel smoothly along the ground.

Note: The Motor used in this model is not included in the Outfit.

3.5
BLOCK-SETTING
CRANE

The travelling bogie 1 consists of two Fishplates bolted together by their elongated holes, and at each end of it Double Brackets are fastened by $\frac{3}{8}$ " Bolts. Two 2" Rods are pushed through the Double Brackets and carry 1" fast Pulleys spaced so that their grooves fit on the two $12\frac{1}{2}$ " Strips that form the top of the jib. The Trunnions 2 at the base of the jib are secured to a Bush Wheel mounted on a Rod held in the bosses

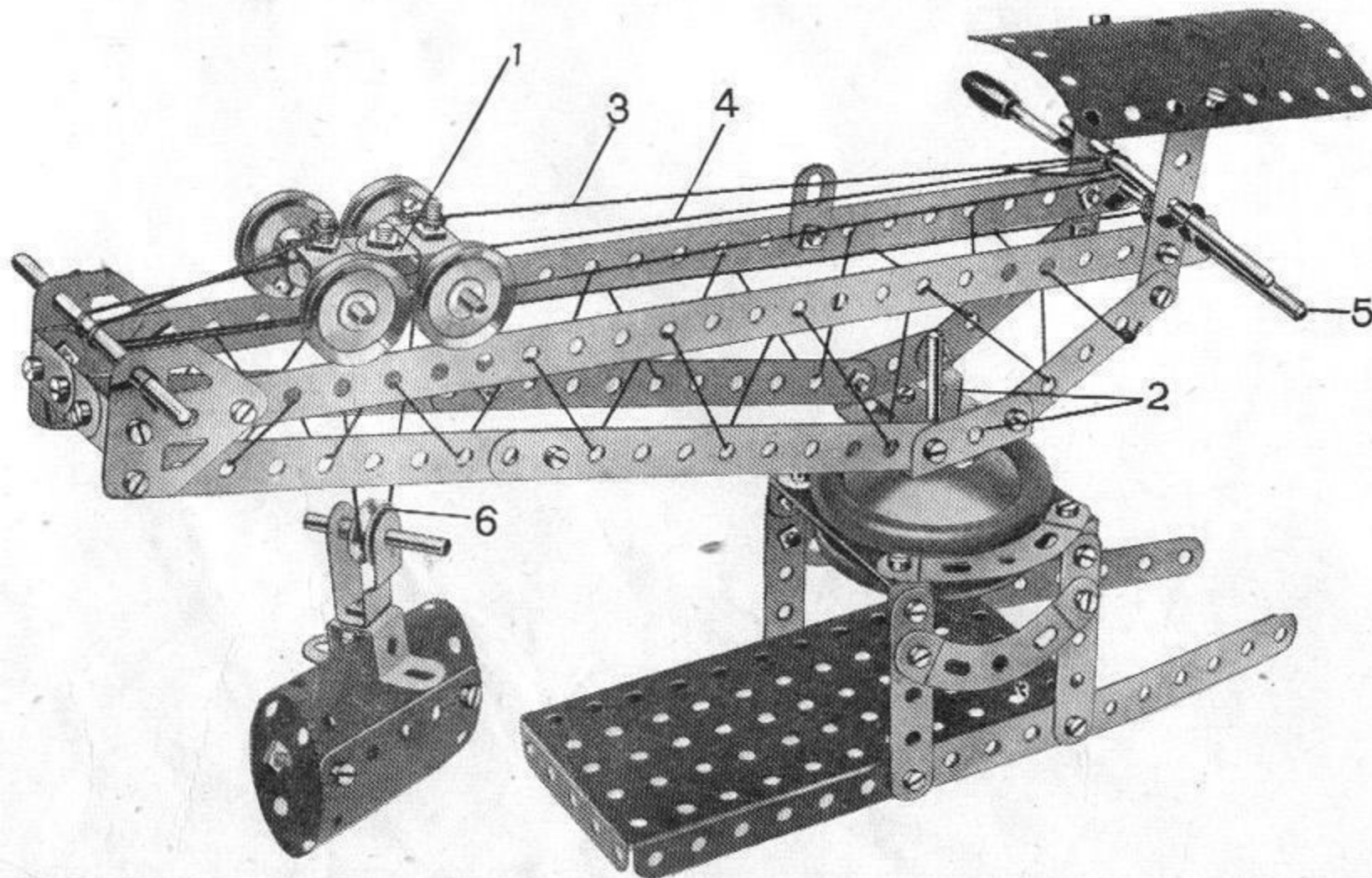

of two Road Wheels. The Road Wheels are placed one above and one below the $2\frac{1}{2} \times 1\frac{1}{2}$ Flexible Plates that form the top of the tower.

Cord 3 is first fastened to the $\frac{3}{8}$ " Bolt at the rear end of the travelling bogie, and then wound three times around the Crank Handle. It is then led around the Rod journalled in the Flat Trunnions at the front end of the jib and brought back and tied to another $\frac{3}{8}$ " Bolt at the front of the bogie.

Cord 4 is first fastened to Rod 5, which is passed through the end holes of the $12\frac{1}{2}$ " Strips, and then over the rear axle of the bogie. It is then passed around the $\frac{1}{2}$ " Pulley 6, led over the front axle of the bogie, around the Rod at the front end of the jib, and finally tied to the bogie. The $\frac{1}{2}$ " Loose Pulley 6 and its Rod are held in the Stepped Bent Strip by a Cord Anchoring Spring.

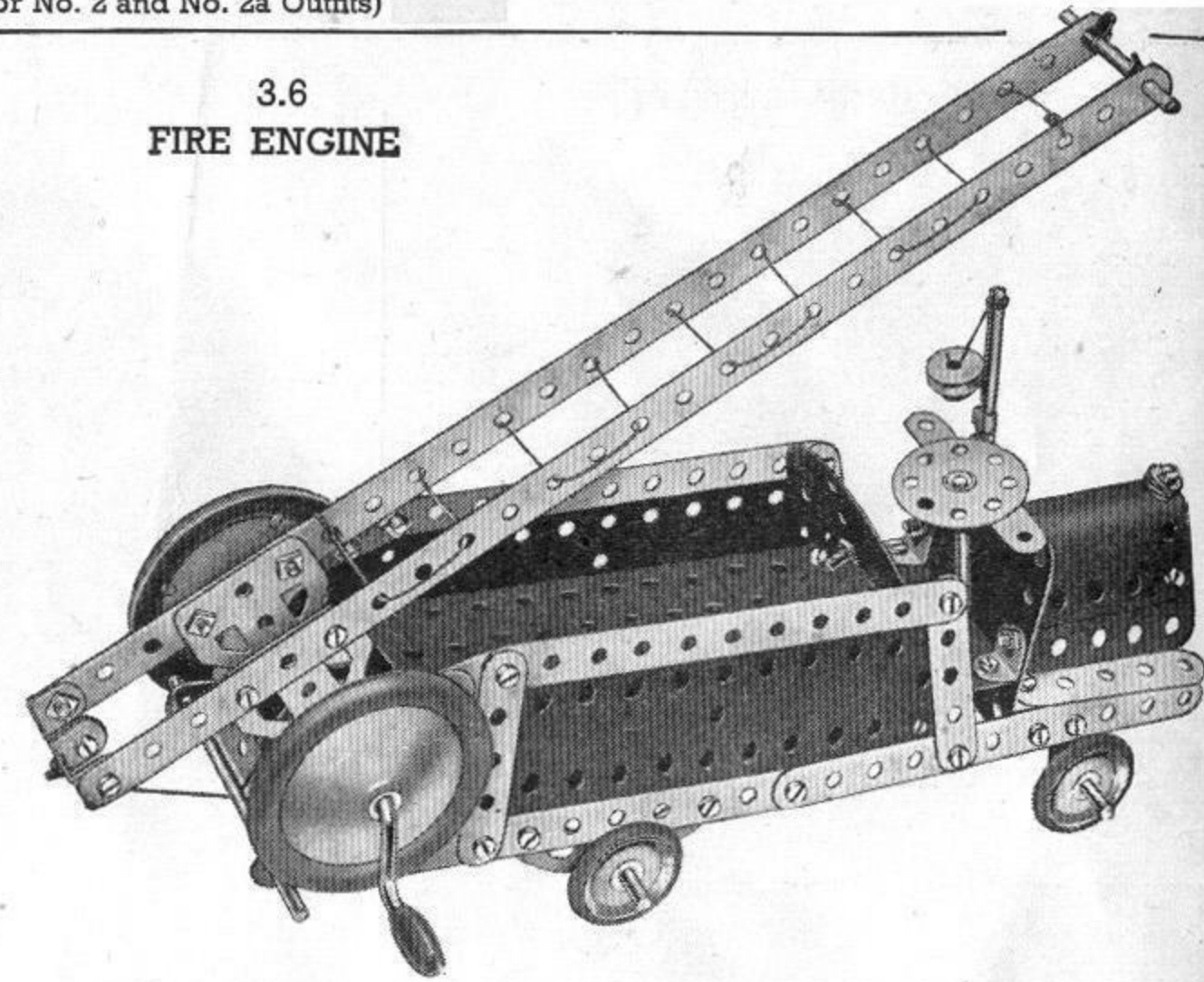
3.6
FIRE ENGINE

Two Flat Trunnions are bolted to the bottom of the ladder, and the shaft of the Crank Handle shown in Fig. 3.6a passes through the holes at their narrow ends. The bonnet, which is formed from a U-Section Curved Plate and two $2\frac{1}{2} \times 1\frac{1}{2}$ Flexible Plates, is fastened to the frame by Reversed Angle Brackets. These latter also support the $2\frac{1}{2}$ " Strips at the sides of the bonnet.

The $3\frac{1}{2}$ " Rod representing the steering column passes through the free hole of a Fishplate bolted to the dashboard, then through a hole in the Flexible Plate at the bottom of the cab. It is fastened in position by a Cord Anchoring Spring.

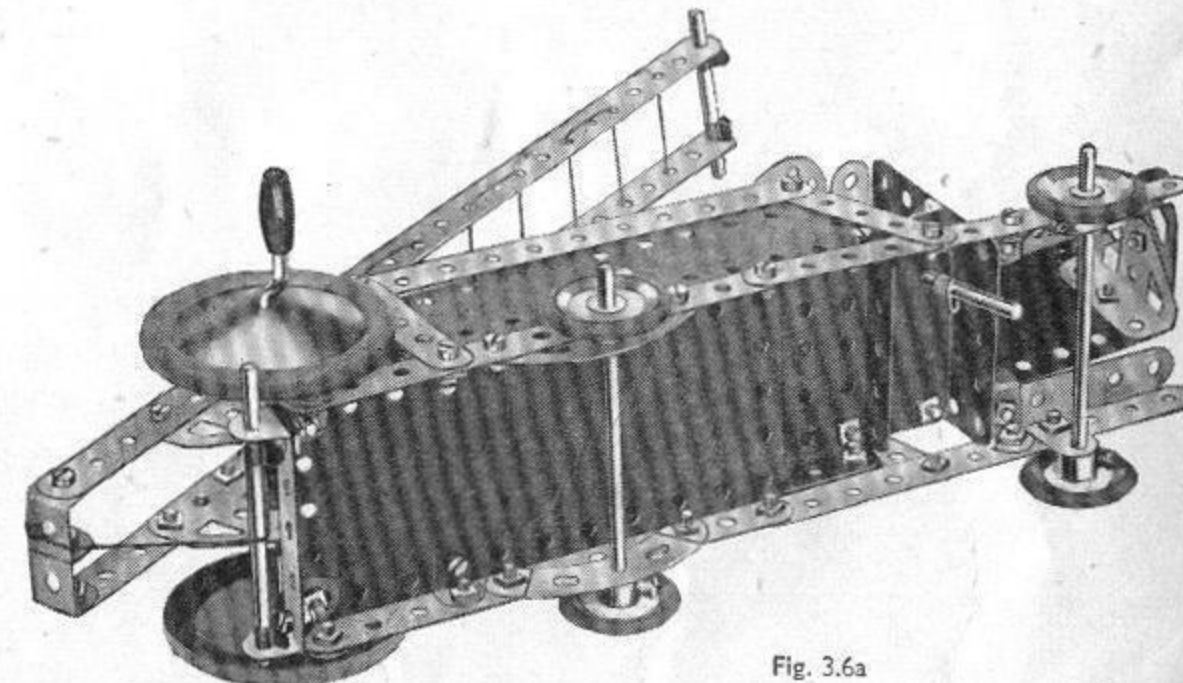

Fig. 3.6a

3.7 SIMPLE HAND LOOM

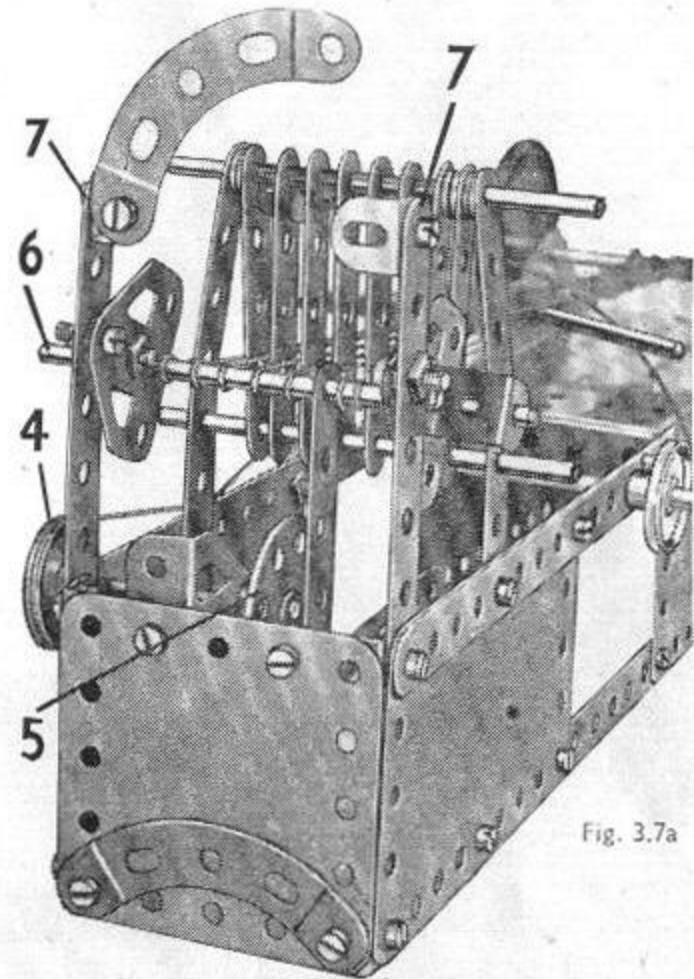
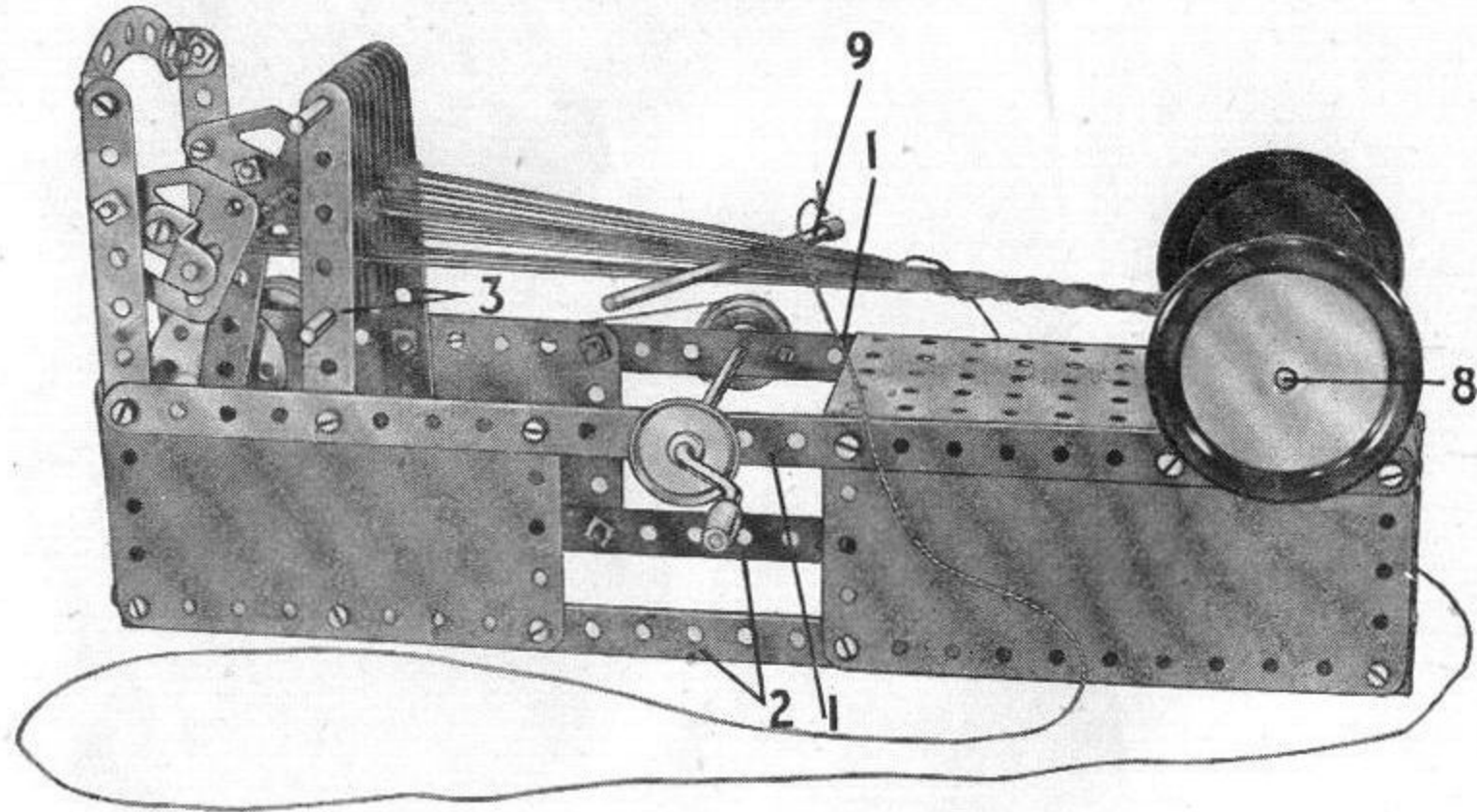

Fig. 3.7a

This interesting model is designed to demonstrate the principles of hand weaving. The base is formed by two $12\frac{1}{2}$ " Strips 1 bolted to a Flanged Plate at one end and joined by a $2\frac{1}{2}$ " x $\frac{1}{2}$ " Double Angle Strip at the other. Two $5\frac{1}{2}$ " x $2\frac{1}{2}$ " and two $4\frac{1}{2}$ " x $2\frac{1}{2}$ " Flexible Plates are bolted to the Strips and joined at their lower edges by the $5\frac{1}{2}$ " Strips 2.

The $5\frac{1}{2}$ " Strips 3 form a support for the heald frame, which consists of eight $2\frac{1}{2}$ " Strips held by two $3\frac{1}{2}$ " rods. The Strips are separated by Spring Clips and Washers as shown, these parts being placed between the Strips on the upper Rod.

The warp separating movement is operated from a Crank Handle. A 1" Pulley on this is connected by a belt of Cord to a similar Pulley 4, which is locked on a 2" Rod that carries also the Bush Wheel 5. A $2\frac{1}{2}$ " Strip lock-nutted to the Bush Wheel links it with the Rod 6. This Rod is mounted in two Flat Trunnions, each fitted with a Reversed Angle Bracket. The Trunnions are free to turn on the shanks of $\frac{3}{8}$ " Bolts fastened in the Strips 7.

A 4" Rod 8 fitted with two Road Wheels passes through two Semi-Circular Plates bolted to the sides of the Flanged Plates.

A length of Cord taken from each of the $2\frac{1}{2}$ " Strips forming the healds is tied to the Rod 8. A second set of similar Cords is taken from the Rod 8. Each of these Cords passes between the healds and is fastened to Rod 6.

To operate the model the two sets of warp threads are separated by turning the Crank Handle slightly. A length of Cord is then passed between the layers by means of the $3\frac{1}{2}$ " Rod 9. The Crank Handle is then again turned slightly, thus changing the positions of the warp layers, and the Rod 9 is again passed through.

Cord is used in the illustrations to show the positions of the threads more clearly, but in actual operation it is better to use wool as this will give a closer and finer texture to the woven material.

3.8 MARINE ENGINE

Bolts 1 are lock-nutted. The Bolts 3 are $\frac{3}{8}$ " long and are lock-nutted twice as shown. The $2\frac{1}{2}$ " Strips 4 must be quite free to move when the crankshaft is rotated.

The piston rod is held by two Spring Clips, one at each side of the Angle Bracket pivotally fastened by one of the Bolts 1. Inside the cylinder the Rods slide through holes in a $2\frac{1}{2}$ " Strip and a Trunnion 2. In order to show the construction clearly, part of the cylinder has been cut away in the illustration.

The rod carrying two 1" Pulleys passes through the centre hole in the outer Wheel Disc. A $\frac{1}{2}$ " x $\frac{1}{2}$ " Angle Bracket is bolted to the Disc in such a position that when the Disc is turned the Angle Bracket engages with a Spring Clip on the Rod. It is important that all nuts and bolts are made quite secure with the spanner and screw-driver.

The cylinder consists of two U-Section Curved Plates, and two $1\frac{1}{2}$ " radius Curved Plates, the latter overlapping the U-Section Curved Plates by two holes at each side. The complete cylinder is attached to the Trunnion 2 by a $\frac{3}{8}$ " Bolt, but is spaced from it by four Washers placed on the shank of the Bolt. Bearings for the Rod forming the left-hand end of the crankshaft are provided by a Flat Trunnion and a Trunnion, and the right-hand end is supported in two $2\frac{1}{2}$ " Strips. The Rod forming the propeller shaft is joined to the crankshaft by a Rod Connector.

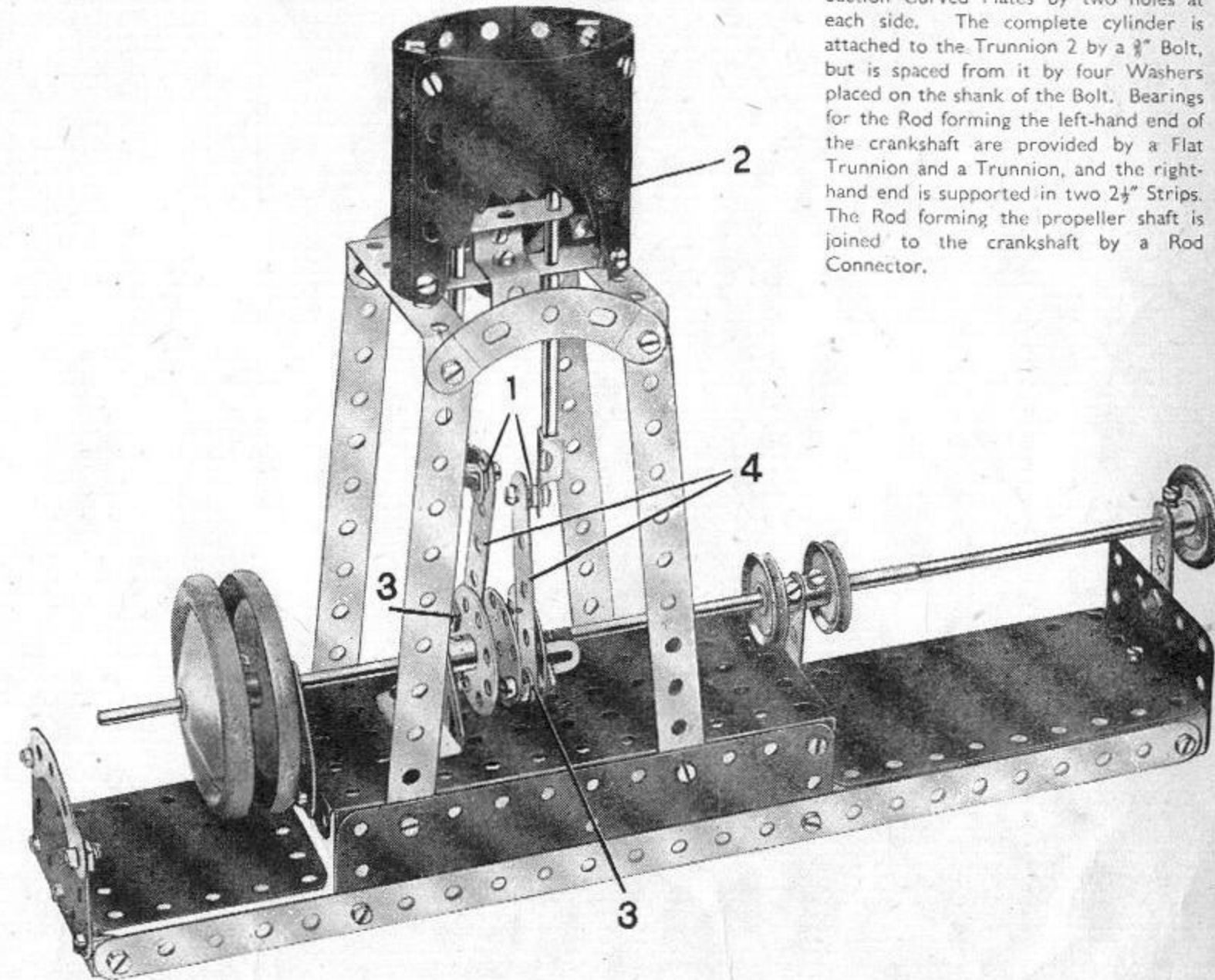

3.9 SWIVELLING JIB CRANE

A 1" fast Pulley 1 is fastened to the lower end of a 2" Rod, which passes into and is held in the boss of the Bush Wheel. The Pulley rests on the tyre of Pulley 2, which is fastened on Rod 3. When the Rod 3 is rotated the jib is caused to swivel. Supports for Rod 3 are formed by Fishplates, which are bolted through their elongated holes to the 2½" Strips shown in the illustration. The roof of the cab is fastened by means of Angle Brackets to two Flat Trunnions, and these in turn are bolted to the compound strips bracing the jib.

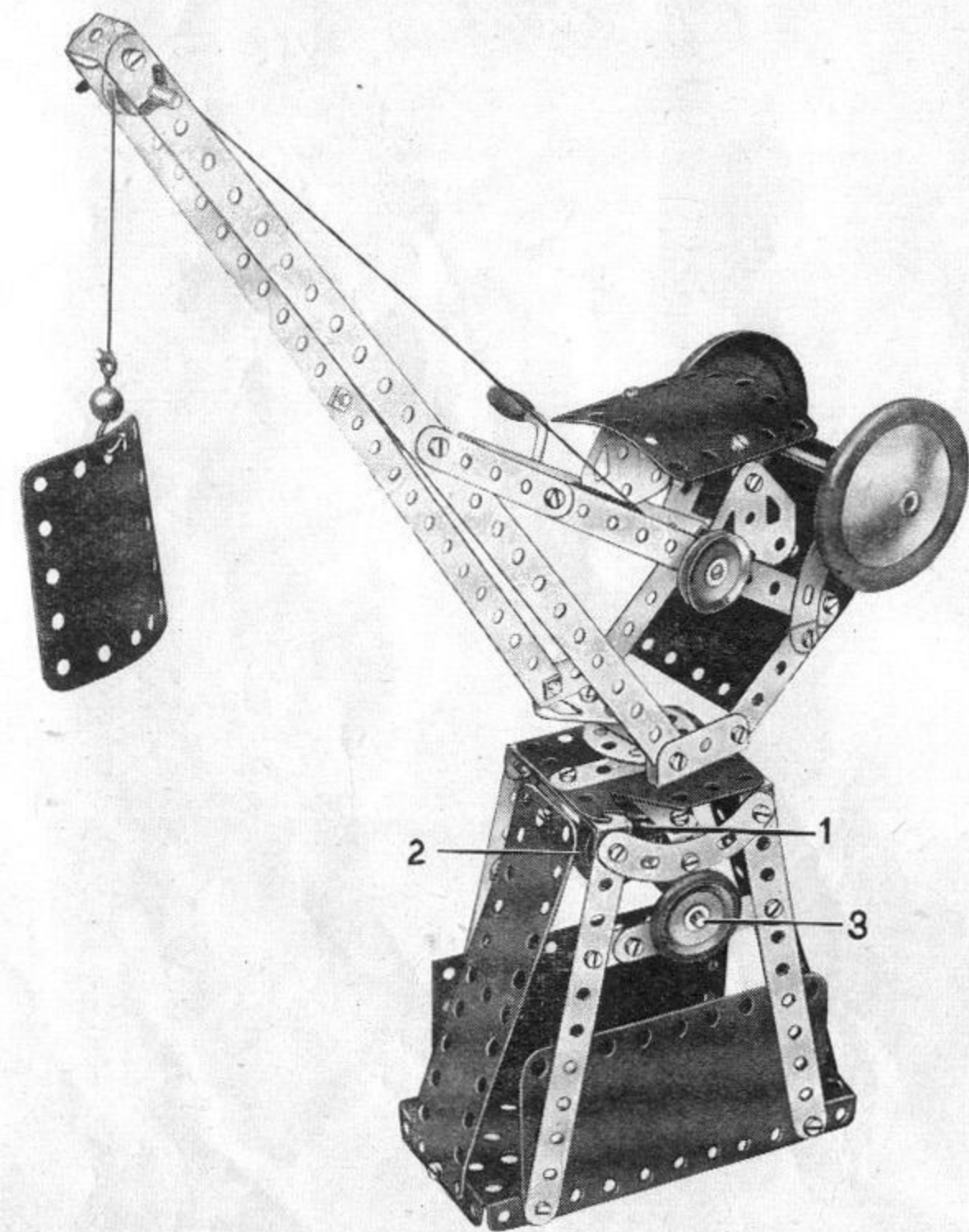

3.10 GIANT LORRY

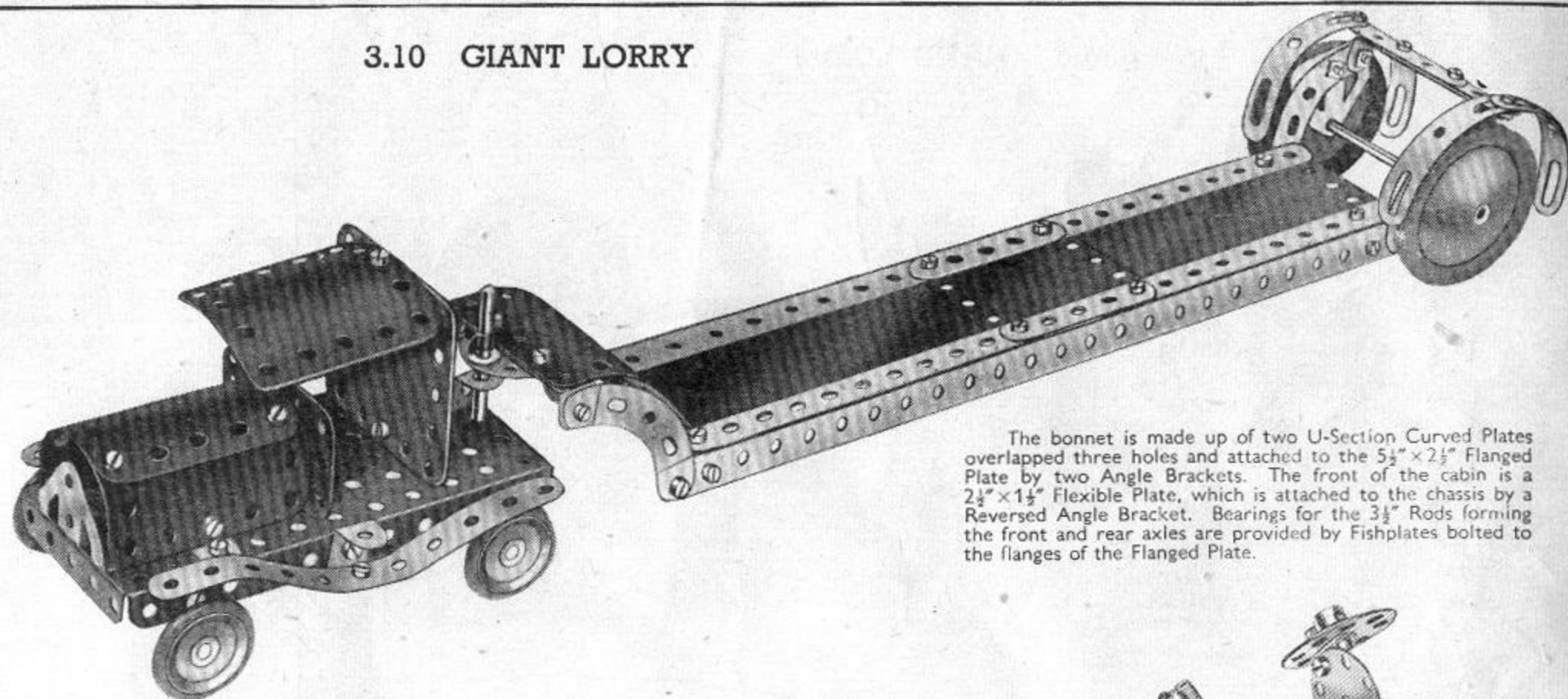

The bonnet is made up of two U-Section Curved Plates overlapped three holes and attached to the 5½" x 2½" Flanged Plate by two Angle Brackets. The front of the cabin is a 2½" x 1½" Flexible Plate, which is attached to the chassis by a Reversed Angle Bracket. Bearings for the 3½" Rods forming the front and rear axles are provided by Fishplates bolted to the flanges of the Flanged Plate.

3.11 TROTTING CAR

The seat of the car consists of two 2½" x 1½" Flexible Plates, overlapped two holes, and it carries at each end a Trunnion. The 3" Formed Slotted Strips that form the mudguards are supported by Reversed Angle Brackets 2, which are spaced from the Flexible Plates by three Washers. The axle consists of two 2" Rods joined by a Rod Connector, and is journalled in the Trunnions.

Each of the horses is built up as follows. Four 2½" Strips are bolted to a U-Section Curved Plate in the positions shown to form the legs, and two 2½" small radius Curved Strips represent the neck. A rod is pushed through the centre holes of the U-Section Curved Plates and is supported in the end holes of the shafts. Two 3½" Rods carrying 1" Pulleys at each of their ends are journalled in the end holes of two of the forelegs and two of the hindlegs of the horses, as shown.

The drivers body is made from two Flat Trunnions, which are bolted together and then fitted with 2½" x ½" Double Angle Strips to represent legs. The Bolt that fixes the Stepped Bent Strip to the body holds also a Fishplate that supports a Wheel Disc representing the head. An Angle Bracket bolted to the Disc secured a Bush Wheel that has a ½" Bolt fixed in its boss by its screw.

The whip is a 1½" Rod held by Spring Clips in a Double Bracket, and the lash is attached to it by a Cord Anchoring Spring. The reins are fastened to the Fishplates that form the horses heads, and also to the Double Bracket to which the whip is fixed. Short lengths of Cord fastened to the U-Section Curved Plates represent the horses' tails.

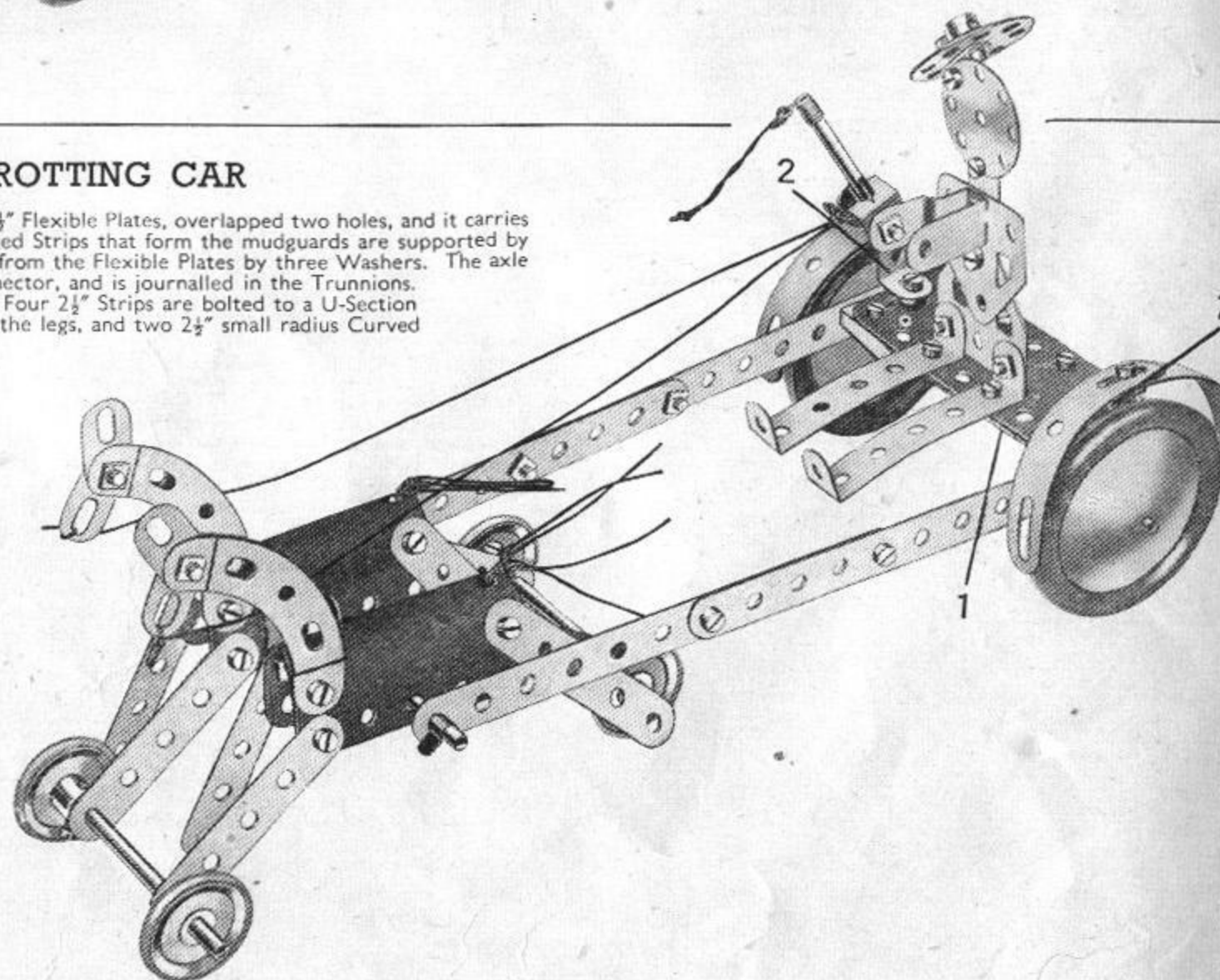

3.12 ICE CREAM VENDOR AND VAN

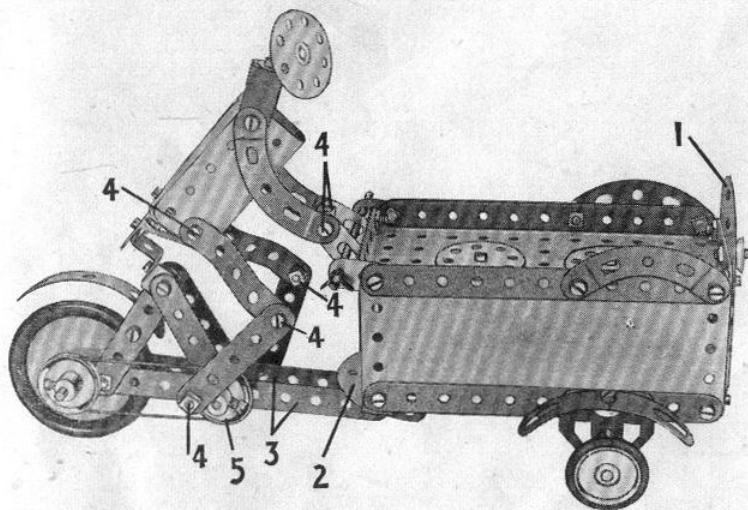

The carrier box of the tricycle is made by bolting two $5\frac{1}{2}'' \times 2\frac{1}{2}''$ and two $2\frac{1}{2}'' \times 2\frac{1}{2}''$ Flexible Plates to a Flanged Plate. The wheels are made fast to a $3\frac{1}{2}''$ Rod that rotates in Flat Trunnions. A Semi-Circular Plate 1 is attached to the front of the carrier, and a similar part 2 is bolted to a Double Angle Strip that spans the sides of the carrier.

The $5\frac{1}{2}''$ Strips 3 are secured to a Double Bracket pivotally attached to the Semi-Circular Plate 2. The supports for the saddle consist of four $2\frac{1}{2}''$ Strips, and a Trunnion is attached to these by a Reversed Angle Bracket and an Angle Bracket.

The body of the rider is formed by two U-Section Curved Plates, and is attached to the Trunnion by an Angle Bracket. His legs are made from four $2\frac{1}{2}''$ Strips. It is important to note that all the Bolts numbered 4 are lock-nutted so that the parts they hold are free to pivot.

The rear wheel is fixed on a 2" Rod fitted with a 1" Pulley. This Pulley is connected by a belt of Cord to a second Pulley 5 on a $1\frac{1}{2}''$ Rod. An Angle Bracket is bolted to the boss of Pulley 5 and attached to one of the rider's legs, see Fig. 3.12a. The other leg is attached to a Reversed Angle Bracket. The slotted hole of the Bracket is fitted with a nut and bolt, and is then pushed on to the $1\frac{1}{2}''$ Rod. The effect of this is that the nut presses against the Rod and locks the Bracket firmly so that it rotates with the Rod.

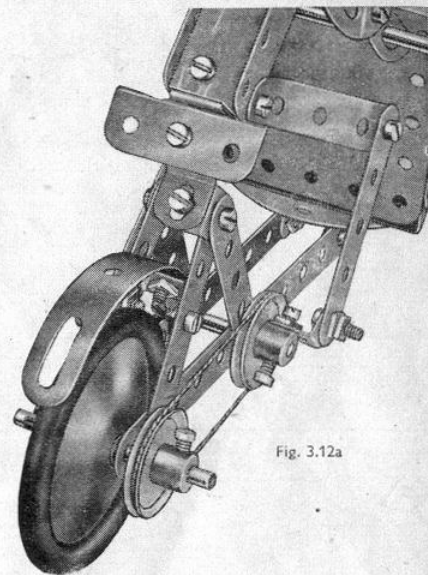
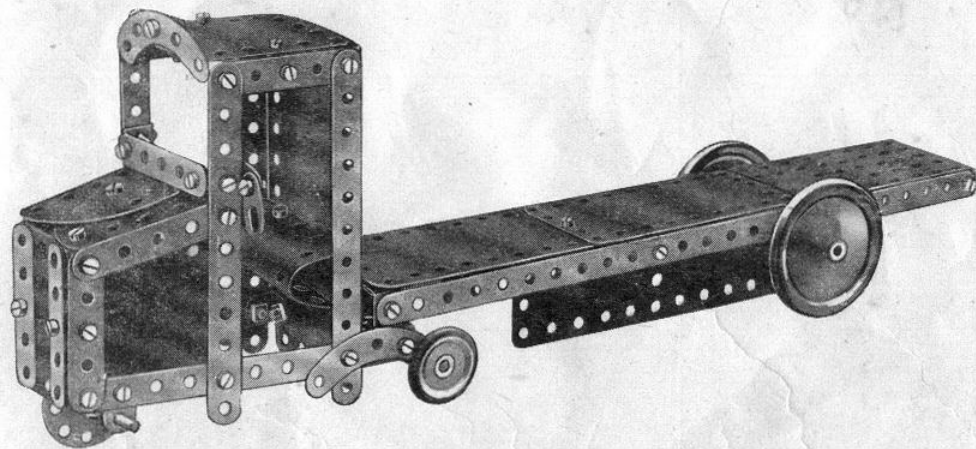

Fig. 3.12a

3.13 MECHANICAL HORSE AND TRAILER



The chassis of the mechanical horse is built up on two $5\frac{1}{2}''$ Strips extended at the rear by $2\frac{1}{2}''$ Curved Strips that provide bearings for the rear axle. The method of building up the bonnet and cab is clear from the illustration. The rear ends of the $5\frac{1}{2}''$ Strips are joined by a Curved Strip and two Double Brackets. At the centre of the Curved Strip is bolted a Wheel Disc, through which passes a $1\frac{1}{2}''$ Rod 1. This Rod engages in the centre hole of the plate at the front of the trailer, and is retained in place by a Spring Clip and a Cord Anchoring Spring. A 1" Pulley and two Washers space the end of the trailer from the Wheel Disc. Bearings for the rear axle are provided by Flat Trunnions.

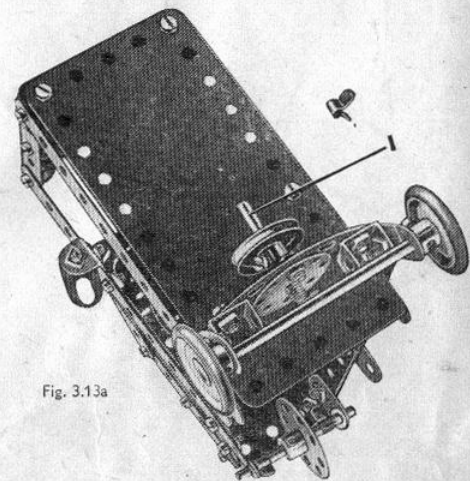
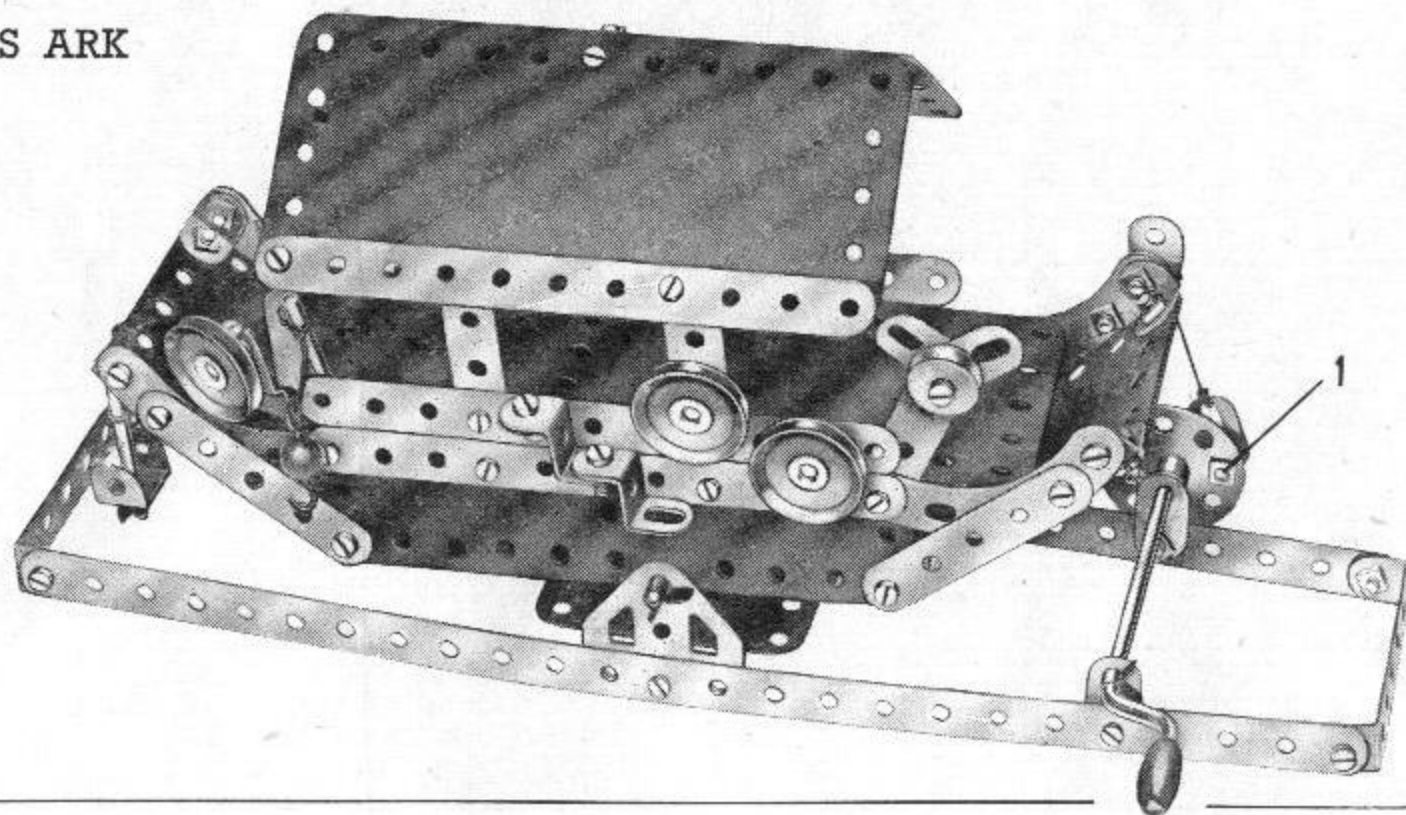

Fig. 3.13a

3.14 NOAH'S ARK

A $5\frac{1}{2}'' \times 2\frac{1}{2}''$ Flanged Plate is used for the bottom of the ark and $5\frac{1}{2}'' \times 1\frac{1}{2}''$ Flexible Plates and $5\frac{1}{2}''$ Strips form the sides. The deck is fastened to the sides by $\frac{1}{2}'' \times \frac{1}{2}''$ Angle Brackets.

The ark is pivoted on a $3\frac{1}{2}''$ Rod journalled in Flat Trunnions, the Rod passing through the flanges of the baseplate at the fifth hole from the end near the Crank Handle. The Crank Handle carries a Bush Wheel, and to this a Fishplate is lock-nutted at 1. A length of Cord is attached to the free hole of the Fishplate and is then tied to a Double Bracket bolted to the side of the ark. When the Crank Handle is rotated, the downward motion of the Fishplate causes one end of the ark to be pulled down, but as the Fishplate rises again, the ark returns to its original position.



3.15 ELECTRIC CRANE TRUCK

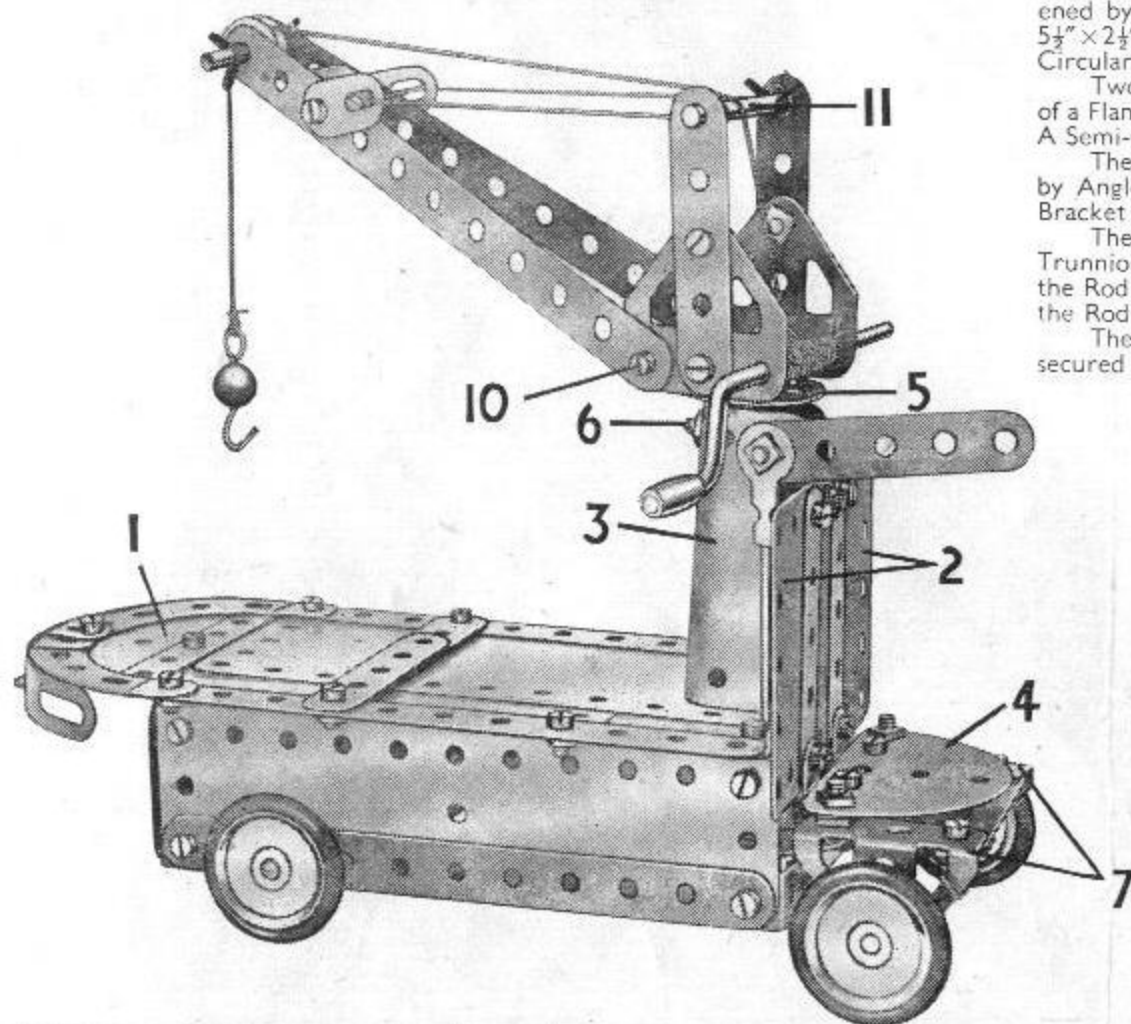

The electric truck is built up first by bolting a $2\frac{1}{2}'' \times 1\frac{1}{2}''$ and two $5\frac{1}{2}'' \times 1\frac{1}{2}''$ Flexible Plates to the flanges of a Flanged Plate. At their lower edges the Flexible Plates are strengthened by $5\frac{1}{2}''$ strips and two $2\frac{1}{2}'' \times \frac{1}{2}''$ Double Angle Strips. The platform consists of two $5\frac{1}{2}'' \times 2\frac{1}{2}''$ and two $4\frac{1}{2}'' \times 2\frac{1}{2}''$ Flexible Plates overlapped, and these are extended by a Semi-Circular Plate 1.

Two $2\frac{1}{2}'' \times 2\frac{1}{2}''$ Flexible Plates 2, overlapped three holes, are bolted to the front end of a Flanged Plate, and a U-Section Curved Plate 3 is attached to these by a Double Bracket. A Semi-Circular Plate 4 is attached to the Flanged Plate by Angle Brackets.

The crane jib is supported by Flat Trunnions, which are attached to a Wheel Disc 5 by Angle Brackets. The Wheel Disc is lock-nutted through its centre hole to an Angle Bracket held by the Bolt 6.

The $5\frac{1}{2}''$ Strips forming the jib pivot on a 2" Rod 10 passed through holes in the flat Trunnions, and the jib is held at the required angle by a length of Cord. This Cord is tied to the Rod 11 and then passed through the fishplates at the jib head, finally being tied again to the Rod 11.

The Trunnions 7, which form part of the steering device, are free to turn on $\frac{3}{8}''$ Bolts secured to the Semi-Circular Plate 4, and they carry $\frac{3}{8}''$ Bolts that form stub axles for the 1" Pulleys. The $2\frac{1}{2}''$ Strip 8, seen in the underneath view of the model, is bolted to a Bush Wheel, and is connected to each Trunnion by Cord as shown. The Bush Wheel is fixed on a $3\frac{1}{2}''$ Rod passed through the Flanged Plate and an Angle Bracket 9.

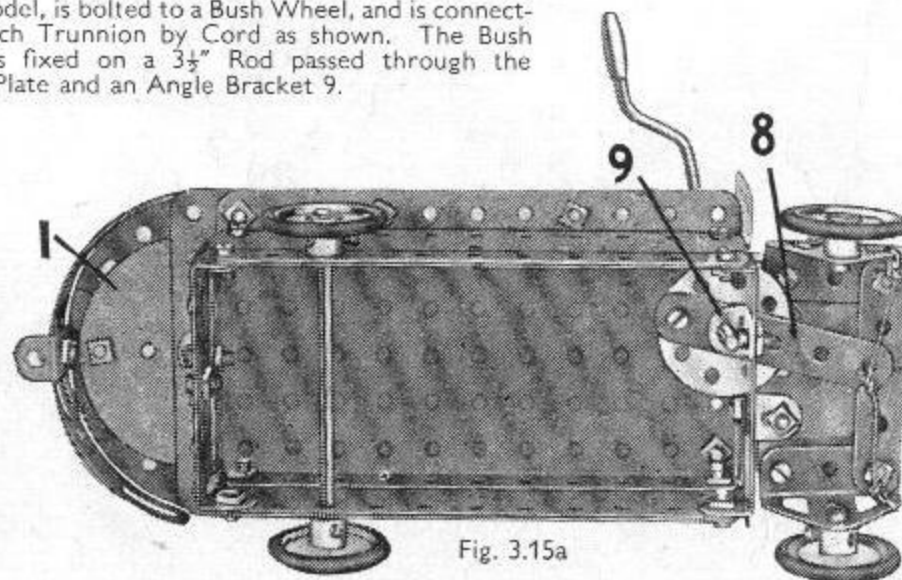

Fig. 3.15a

3.16 PITHEAD GEAR

A $3\frac{1}{2}''$ Rod is journalled in the top holes of the $12\frac{1}{2}''$ Strips. Between the two Road Wheels on this Rod is a 1" fast Pulley, over which the Cord controlling the cage passes. A Cord Anchoring Spring is pushed on one end of the rod, and a Bush Wheel is fixed to the other end. The cage is built up from Trunnions and Flat Trunnions, and the $2\frac{1}{2}'' \times 1\frac{1}{2}''$ Flexible Plates that form its sides are fastened to the Flat Trunnions by Angle Brackets.

A $\frac{3}{8}''$ Bolt is passed through the holes of Reversed Angle Brackets bolted to the top of the cage, and Washers are placed on its shank for spacing purposes.

The guides 1 for the cage consist of a piece of Cord, which is passed over two Rods as shown and then led downward and through two holes in the Flanged Plate that forms the base. Washers are tied to each end of the Cord, underneath the Plate, to maintain it in tension.

The Cord used for elevating the cage is wound round the Crank Handle, and one end is passed over the $3\frac{1}{2}''$ Rod and tied to the top of the cage. The other end of the Cord is passed through a hole in the Flanged Plate and tied to the underneath of the cage.

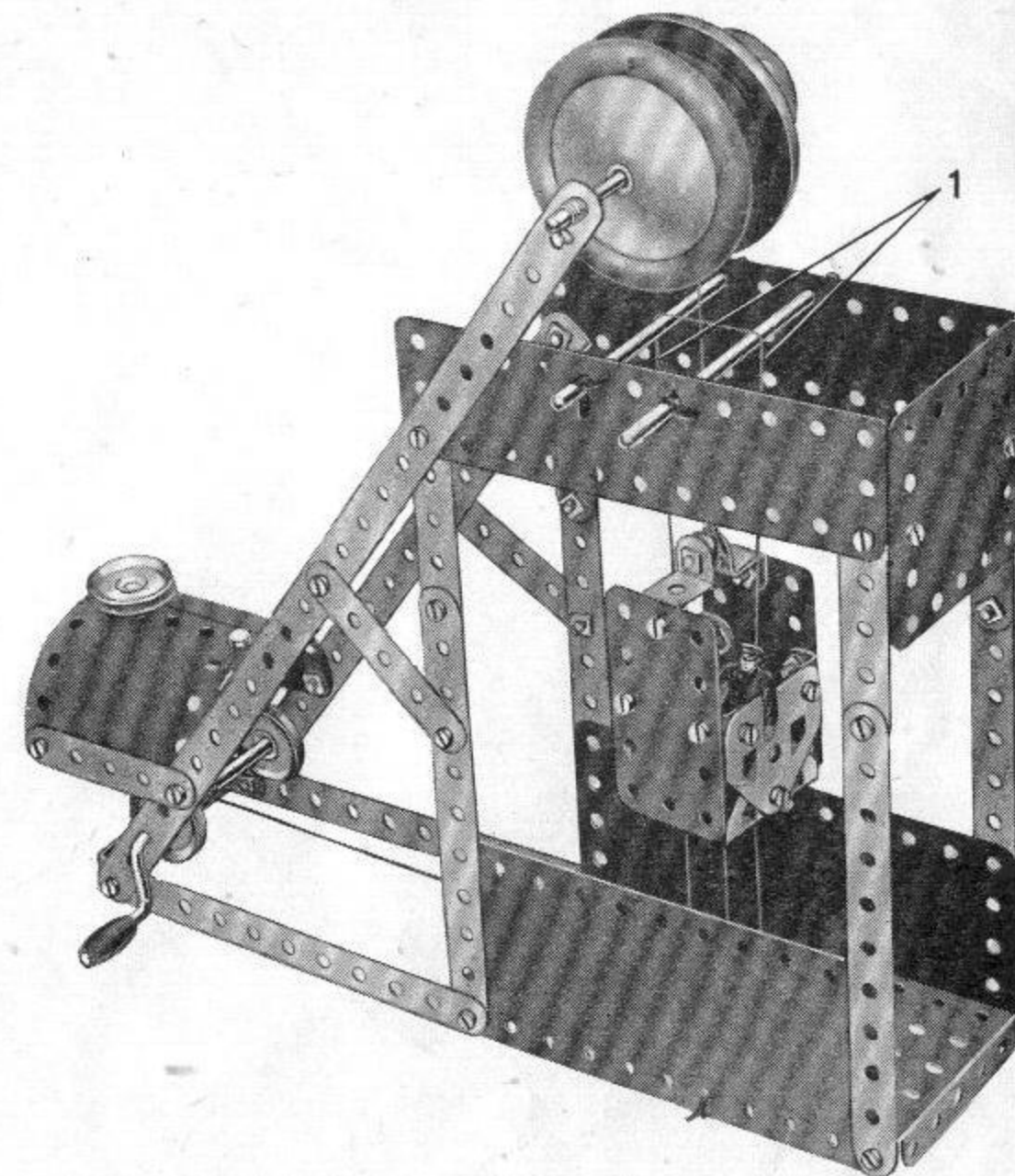

3.17 MILL ENGINE

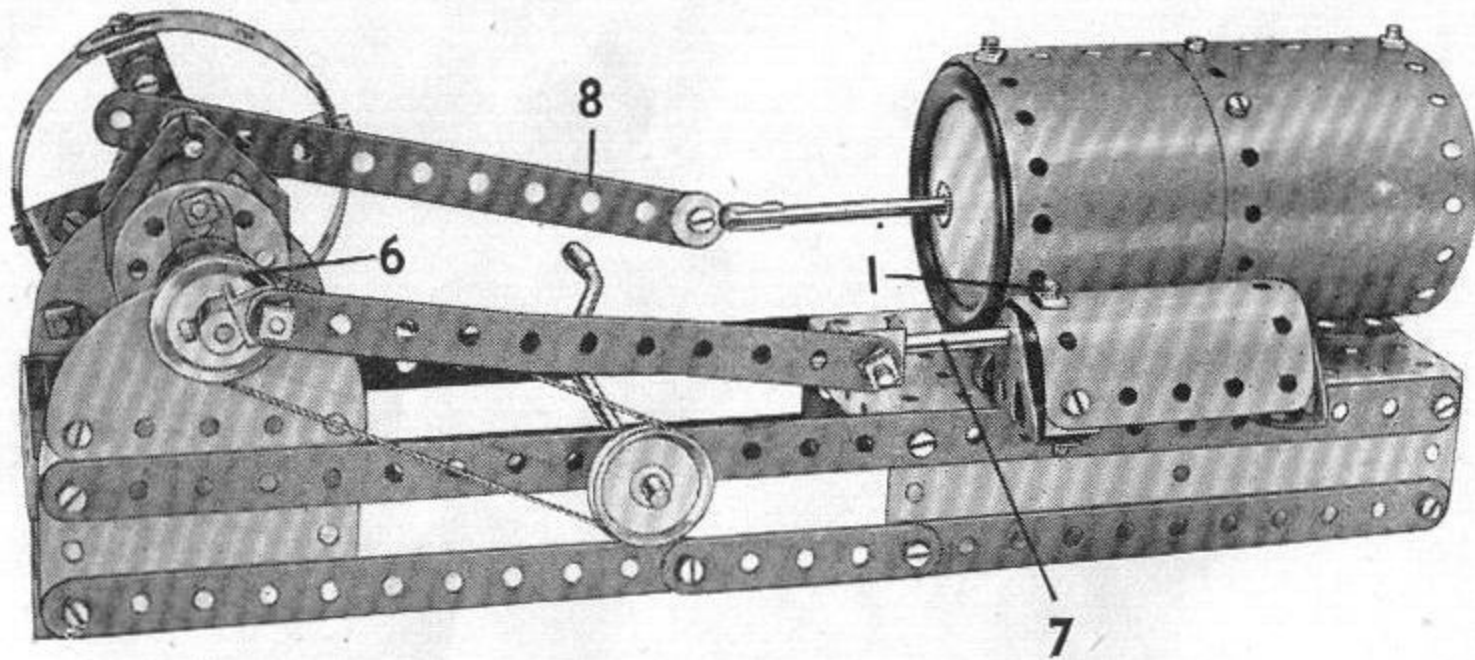

The bed of the engine is built first. For this two $12\frac{1}{2}$ " Strips are bolted one to each side of a Flanged Plate. A $5\frac{1}{2}$ " \times $1\frac{1}{2}$ " Flexible Plate also is attached to each side of the Flanged Plate, and to the lower edges of the Flexible Plates are bolted built-up strips, each consisting of two $5\frac{1}{2}$ " and one $2\frac{1}{2}$ " Strip. At the front end of the model the $12\frac{1}{2}$ " Strips are connected by a $2\frac{1}{2}$ " \times $\frac{1}{2}$ " Double Angle Strip, and a similar part is used to connect the ends of the built-up strips. At the front end of the bed a $2\frac{1}{2}$ " \times $1\frac{1}{2}$ " Flexible Plate is bolted to each side. A Semi-Circular Plate is attached to each Flexible Plate by a Fishplate. The Semi-Circular Plates provide the bearings for the crankshaft.

The cylinder is made from two $5\frac{1}{2}$ " \times $2\frac{1}{2}$ " and two $4\frac{1}{2}$ " \times $2\frac{1}{2}$ " Flexible Plates bolted together and curved around the rims of two Road Wheels. The cylinder is bolted to the Flanged Plate.

The valve chamber is represented by a U-Section Curved Plate and two Trunnions. The Curved Plate is attached to one of the Trunnions by an Angle Bracket, and a second Angle Bracket held by the Bolt 1 provides a guide for the valve rod.

The crankshaft is built up from two 2" Rods, one of which is fitted with a Bush Wheel 2 and two 1" Pulleys. These Pulleys grip the flywheel, which is built up from four Formed Slotted Strips attached to $2\frac{1}{2}$ " Strips by Angle Brackets. A Flat Trunnion is bolted to the Bush Wheel as shown. The other 2" Rod carries a Wheel Disc 3, similarly fitted with a Flat Trunnion and also an Angle Bracket 4 held by the same bolt. A Spring Clip is placed on the Rod so that its lugs press against the Angle Bracket 4, thus locking the Wheel Disc to the Rod.

The connecting rod is a $5\frac{1}{2}$ " Strip which is free to turn on a $1\frac{1}{2}$ " Rod 5 held by Spring Clips in the Flat Trunnions.

The valve gear is operated by an Angle Bracket bolted to the boss of a 1" Pulley 6. A $5\frac{1}{2}$ " Strip is attached loosely by a lock-nutted bolt to this Angle Bracket, and also to a Double Bracket on the Rod 7. A Cord Anchoring Spring is placed on this Rod inside the Double Bracket.

The connecting rod 8 is lock-nutted to a Rod and Strip Connector on a 4" Rod representing the piston rod.

The engine is set in motion by a belt of Cord running around a 1" Pulley on the Crank Handle and the Pulley 6.

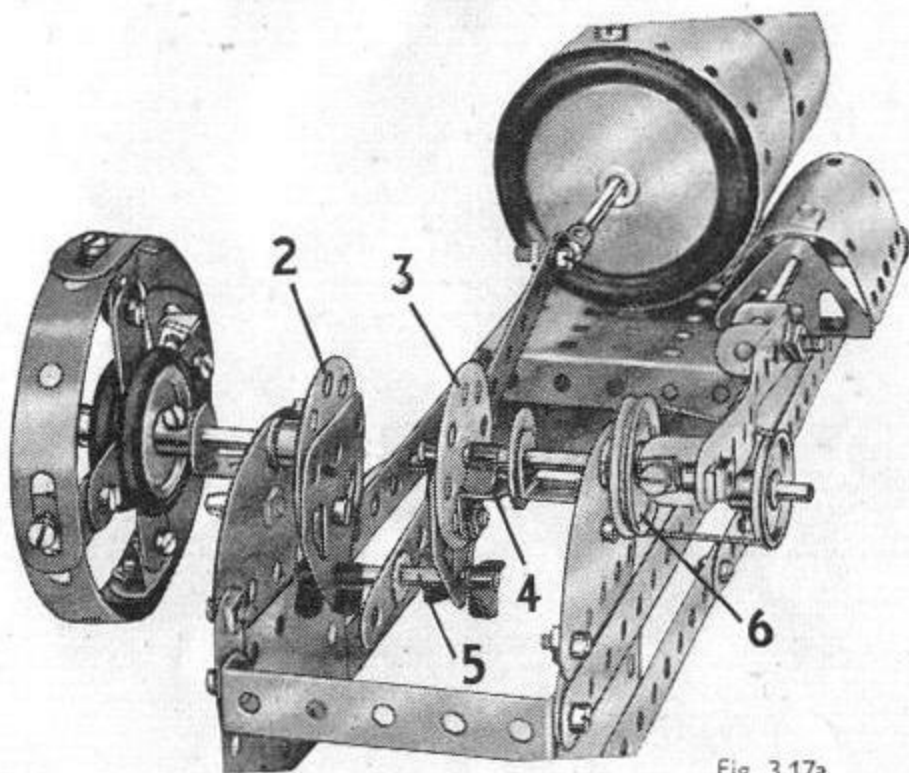

Fig. 3.17a

3.18 SHOVEL EXCAVATOR

The tractor unit is made by bolting two $5\frac{1}{2}$ " \times $1\frac{1}{2}$ " and two $2\frac{1}{2}$ " \times $1\frac{1}{2}$ " Flexible Plates to the sides of a $5\frac{1}{2}$ " \times $2\frac{1}{2}$ " Flanged Plate. It is fitted with wheels consisting of 1" Pulleys fixed on $3\frac{1}{2}$ " Rods, and a belt of cord is passed around each pair of these to represent creeper tracks.

The cab sides consist of two $5\frac{1}{2}$ " \times $2\frac{1}{2}$ " Flexible Plates edged with $5\frac{1}{2}$ " Strips. These are joined by a Double Angle Strip 1 and a similar Double Angle Strip held by a Bolt 2 on each side of the cab. A $\frac{3}{8}$ " Bolt passed through this Double Angle Strip is used to attach the cab to the tractor unit, two Wheel Discs being used for spacing purposes. The $\frac{3}{8}$ " Bolt is lock-nutted. The back of the cab is a $2\frac{1}{2}$ " \times $2\frac{1}{2}$ " Flexible Plate bolted to the Double Angle Strip 1.

The roof is made from two $4\frac{1}{2}$ " \times $2\frac{1}{2}$ " Flexible Plates, and is attached at each end to a Curved Strip by an Angle Bracket. The Curved Strips are connected by Angle Brackets to four $2\frac{1}{2}$ " Strips that support the roof.

The jib consists of two $12\frac{1}{2}$ " Strips joined by Double Brackets. It pivots about a $3\frac{1}{2}$ " Rod 3, and is luffed by two Cords extending from a Rod 4 to the Fishplates bolted to the $12\frac{1}{2}$ " Strips. This Rod is fitted with a Bush Wheel and can be prevented from rotating by engaging a $\frac{3}{8}$ " Bolt 5 in one of the holes in the Bush Wheel. By this means it is possible to maintain the jib at any desired angle.

Two $5\frac{1}{2}$ " Strips lock-nutted to the jib form the arm that carries the shovel. The shovel consists of a U-Section Curved Plate, and the $5\frac{1}{2}$ " Strips are attached to it by two Reversed Angle Brackets, one of which can be seen at 6. The sides of the shovel are formed by two Trunnions.

The shovel arm is raised or lowered by a length of Cord, which extends from the Loaded Hook attached to the shovel, over a $\frac{1}{2}$ " Pulley at the jib and is then fastened to the Crank Handle.

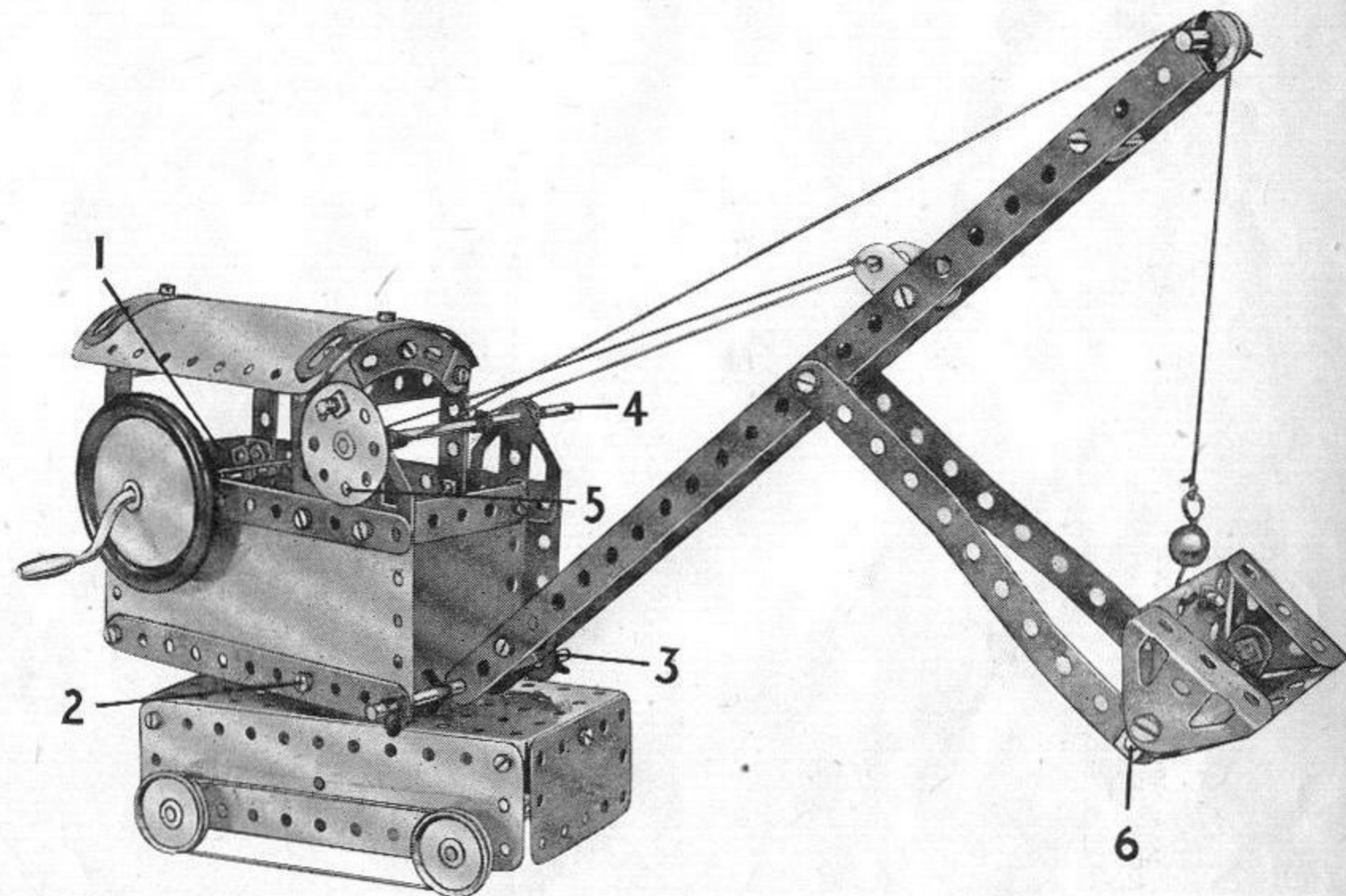

3.19 SWING BOAT

The base of the model is formed by a Flanged Plate, and the upright supports are bolted to it. Two of the uprights are $12\frac{1}{2}$ " Strips, and the others are each built up from two $5\frac{1}{2}$ " and one $2\frac{1}{2}$ " Strip. Each pair of supports is joined at the top to a Flat Trunnion. The two Trunnions are then connected by Double Angle Strip 1.

The swing boat is made from two $2\frac{1}{2}$ " x $1\frac{1}{2}$ " Flexible Plates, strengthened by Formed Slotted Strips. The seats are represented by Trunnions, and the Curved Strips are attached by Angle Brackets.

The swing is suspended from a compound strip consisting of two $5\frac{1}{2}$ " Strips overlapped four holes. The upper end of this strip is clamped firmly between two 1" Pulleys 2 fitted with Rubber Rings and a Wheel Disc. The Pulleys are locked on a 4" Rod 3. A $2\frac{1}{2}$ " Strip is bolted to a Bush Wheel 4 also locked on this Rod, and is connected to the Crank Handle by a lever made from a $3\frac{1}{2}$ " and a 4" Rod joined by a Rod Connector. The $2\frac{1}{2}$ " Strip 5 is clamped between two 1" Pulleys on the Crank Handle and is attached to the lever by a Reversed Angle Bracket. All Bolts numbered 6 are lock-nutted.

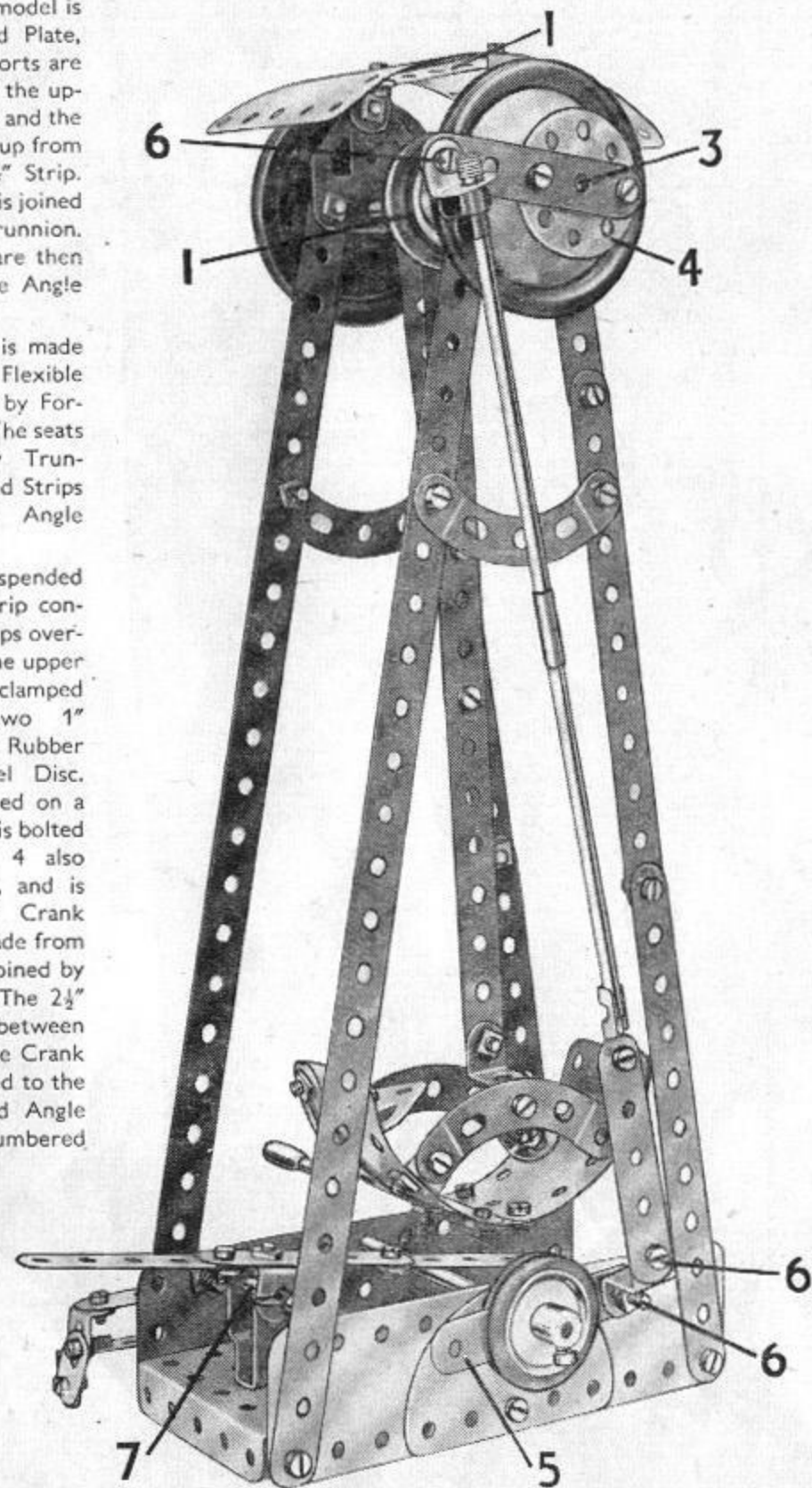
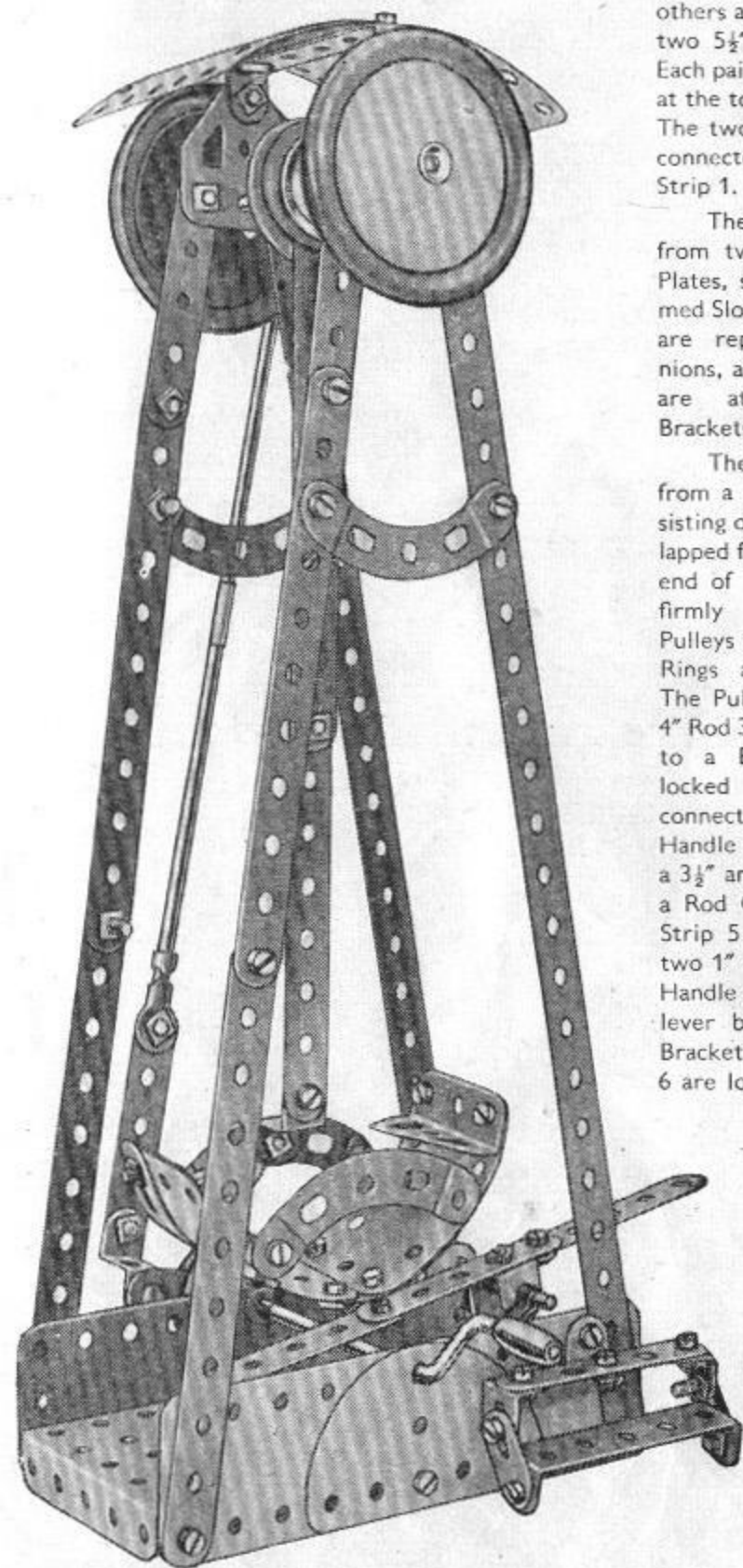

The brake for bringing the boat to rest is formed by three $2\frac{1}{2}$ " Strips joined together, and is bolted to a Double Bracket held by the Rod 7.

3.20 ROUNDABOUT

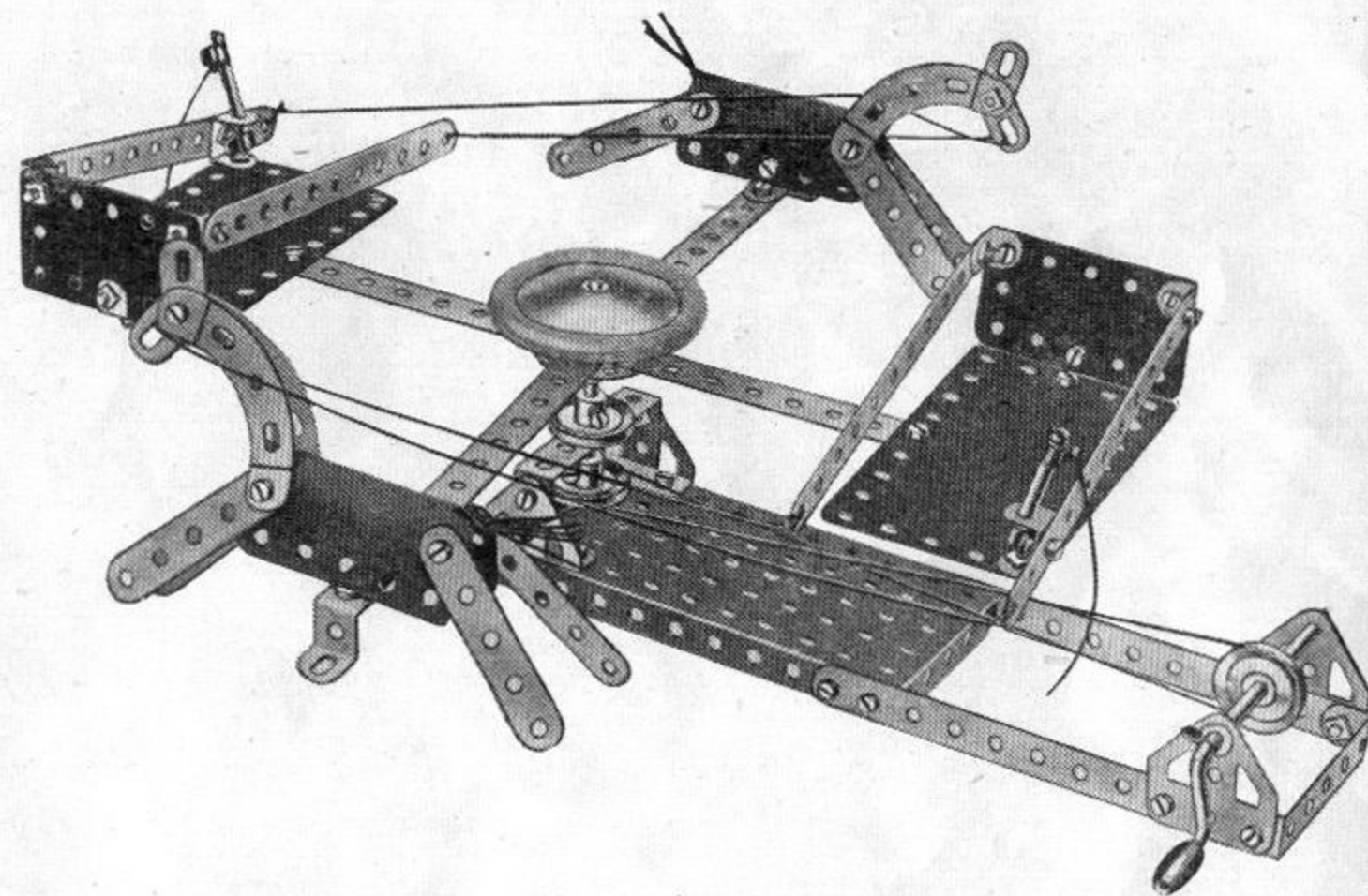

The two horses and the two cars are each fixed to $12\frac{1}{2}$ " Strips bolted at right angles to each other to a Bush Wheel that is fixed on a vertical $3\frac{1}{2}$ " Rod. The Rod is passed through a $2\frac{1}{2}$ " x $\frac{1}{2}$ " Double Angle Strip and a hole in the Flanged Plate forming the base.

The model is driven by a belt of Cord passed around a 1" Pulley fixed on a Crank Handle supported in two Flat Trunnions bolted to the base and also around a further 1" Pulley fixed on the centre Rod of the roundabout.

Fig.3.20a shows how the model roundabout can be fitted with a *Magic* Motor if this is available. The Motor is bolted to the $5\frac{1}{2}$ " Strips of the base, and the drive is taken to a second 1" Pulley fastened on the Crank Handle and spaced from the Flat Trunnion by a Spring Clip and a Washer. This Pulley is removed from the end of the pivot rod of the roundabout underneath the $5\frac{1}{2}$ " x $2\frac{1}{2}$ " Flanged Plate.

Note: The Motor used in this model is not included in the Outfit.

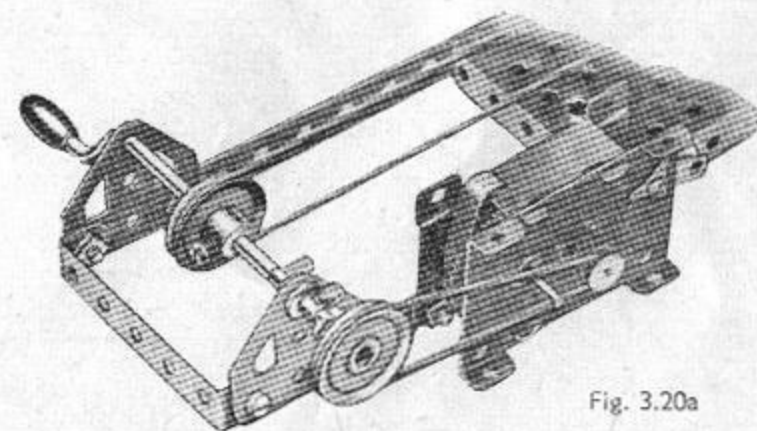
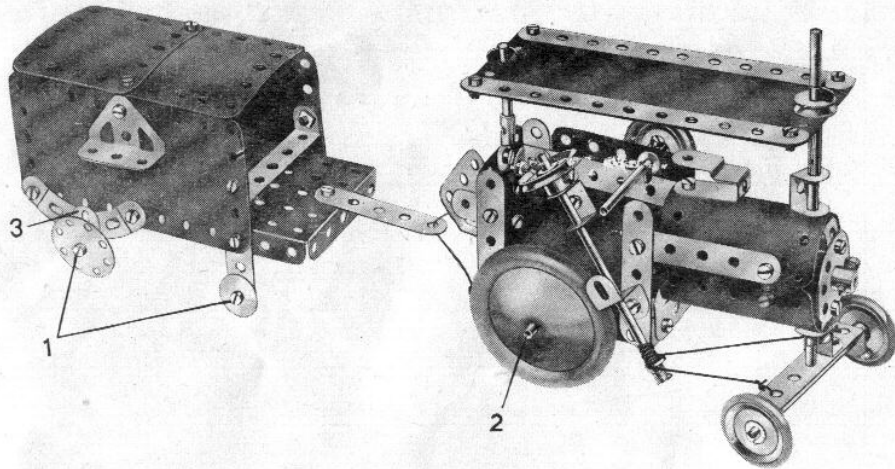

Fig. 3.20a

3.21 STEAM TRACTOR AND TRAILER



The steering column, a $3\frac{1}{2}$ " Rod, is supported in the holes of a Double Bracket and a Reversed Angle Bracket bolted to the side of the cab. Cord is wound round the lower part of the Rod and its ends are tied to the $2\frac{1}{2}$ " \times $\frac{1}{2}$ " Double Angle Strip that carries the front axle. Care must be taken that the Cord is wound tightly round the Rod, or it will slip when the steering wheel is rotated. The Rod 2 is supported in holes in the Flexible Plates that form the sides of the cab.

The Bush Wheel that forms the front of the Boiler has two Angle Brackets bolted to it and a Rod passes through the free holes of these Brackets to hold the Bush Wheel in position. This Rod is joined by a Rod Connector to a 2" Rod that forms the chimney. The roof of the cab consists of a $5\frac{1}{2}$ " \times $2\frac{1}{2}$ " Flexible Plate, and is held in position by Spring Clips placed on the two rods that pass through it. The Fishplates 3 are bolted in the centre holes of the $2\frac{1}{2}$ " Curved Strips on each side of the model. The Bolts 1 are lock-nutted in position and the Wheel Discs and $\frac{3}{8}$ " Washers turn freely on them.

3.22 RACING CAR

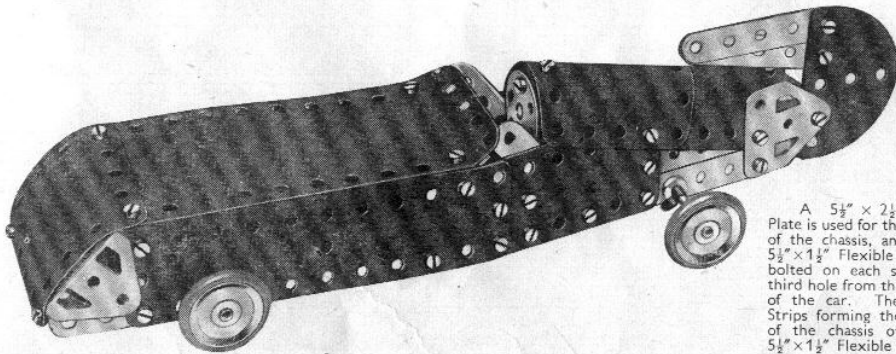

A $5\frac{1}{2}$ " \times $2\frac{1}{2}$ " Flanged Plate is used for the front end of the chassis, and the two $5\frac{1}{2}$ " \times $1\frac{1}{2}$ " Flexible Plates are bolted on each side in the third hole from the front end of the car. The two $5\frac{1}{2}$ " Strips forming the rear end of the chassis overlap the $5\frac{1}{2}$ " \times $1\frac{1}{2}$ " Flexible Plates one hole.

3.23 TRACTOR AND HARROW

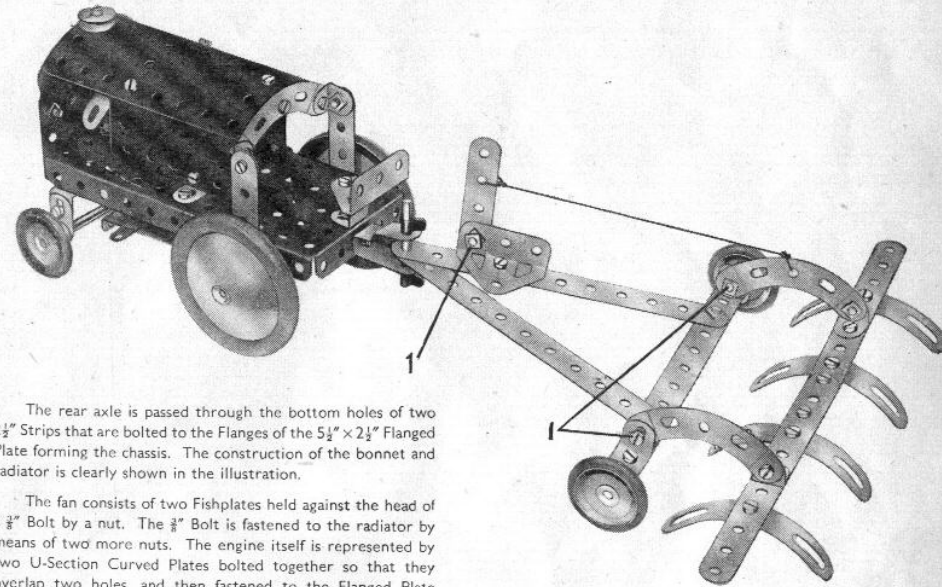

The rear axle is passed through the bottom holes of two $2\frac{1}{2}$ " Strips that are bolted to the Flanges of the $5\frac{1}{2}$ " \times $2\frac{1}{2}$ " Flanged Plate forming the chassis. The construction of the bonnet and radiator is clearly shown in the illustration.

The fan consists of two Fishplates held against the head of a $\frac{3}{8}$ " Bolt by a nut. The $\frac{3}{8}$ " Bolt is fastened to the radiator by means of two more nuts. The engine itself is represented by two U-Section Curved Plates bolted together so that they overlap two holes, and then fastened to the Flanged Plate by two Angle Brackets.

The wheels of the harrow are held by $\frac{3}{8}$ " Bolts in Reversed Angle Brackets at each end of a $5\frac{1}{2}$ " Strip. Small radius Curved Strips are fastened to the Reversed Angle Brackets by lock-nutted bolts, and Cord is attached to the centre holes of one of these and also to the operating lever, which is held by lock-nuts to a Trunnion. By moving the lever forward the harrow may be raised from the ground when not in use.

The Bolts 1 shown in both illustrations are lock-nutted.

Note: The Motor used in this model is not included in the Outfit.

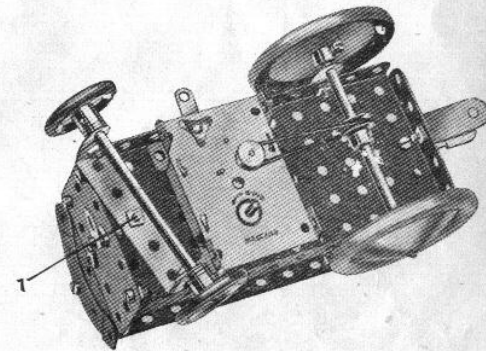

Fig. 3.23a

3.24 WINDMILL PUMP

Up and down motion of the pumping shaft is obtained from a crank fastened to the end of the Crank Handle. The crank is formed by securing an Angle Bracket to the boss of a 1" Pulley, two Washers being used between the Bracket and the boss. A 2½" Strip is pivoted to the Crank and the pumping beam, the other end of which is pivotally attached to a Double Bracket on the pump rod. The Bolts 1 are lock-nutted.

The 1" Pulley on the Crank Handle is connected by a belt of Cord to the shaft carrying the sails. The *Magic Motor* is bolted by its flanges to the baseplate, and the drive is taken from the pulley of the Motor to a ½" Pulley fixed on the shaft of the Crank Handle.

If a Motor is not available the model may be operated by hand.

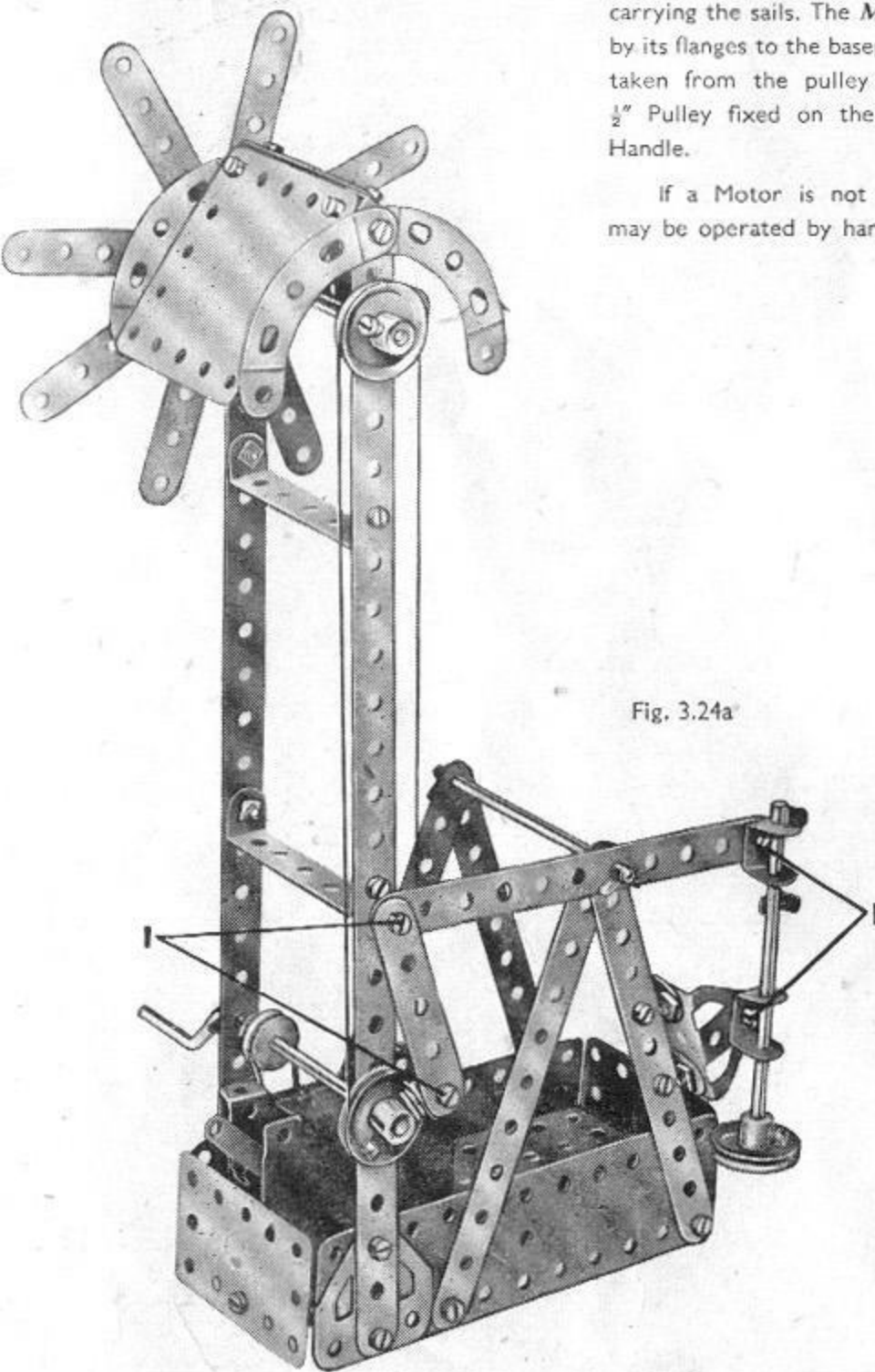
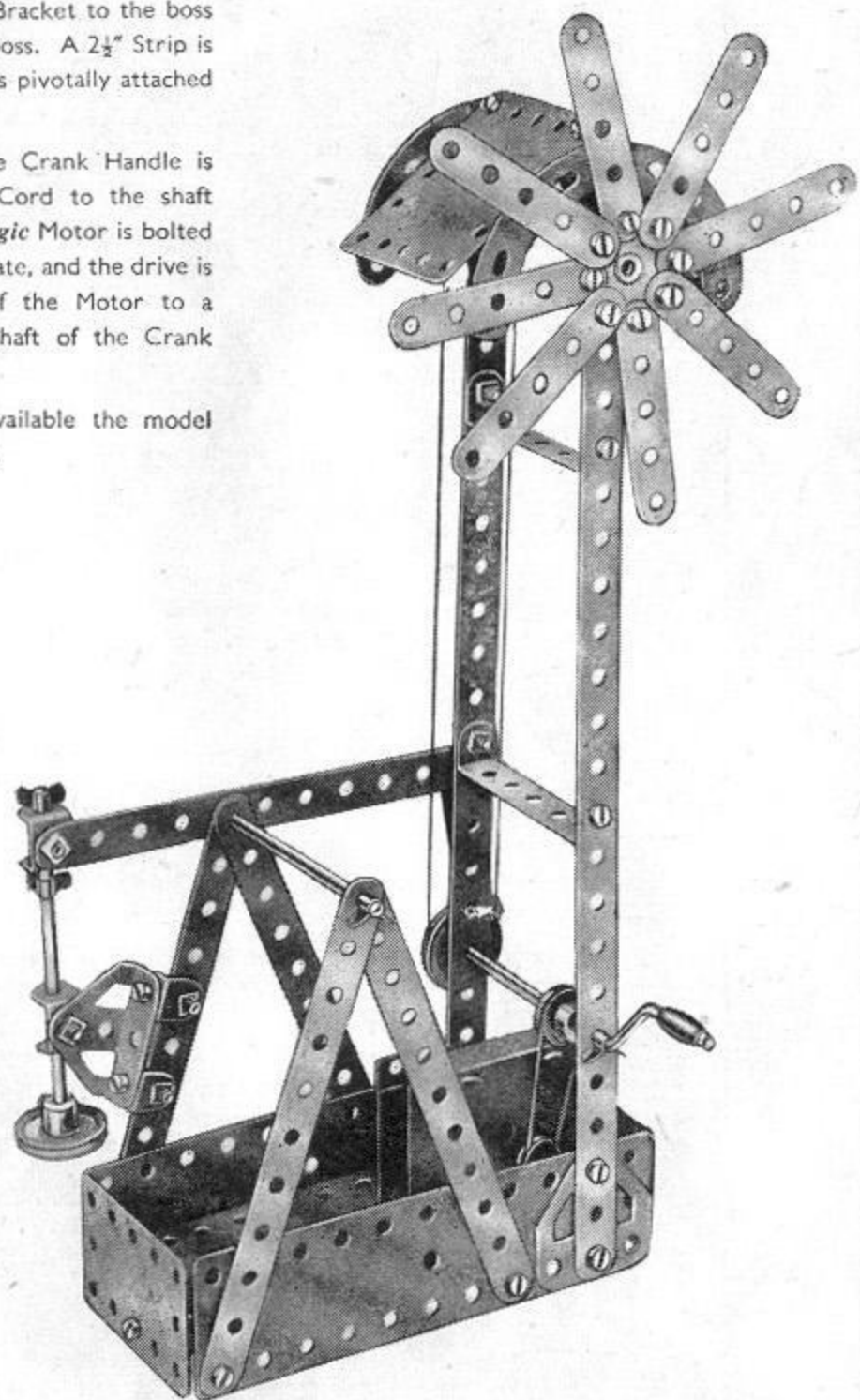

Fig. 3.24a



Note: The Motor used in this model is not included in the Outfit.

3.25 BALANCE

One of the 12½" Strips that form the beam of the balance is bolted across a Bush Wheel 2. The 3½" Rod 3 that is locked in the boss of the Bush Wheel rests on the two Curved Strips 4.

The Rod 1, by which the balance is adjusted, is pushed through the two holes of a Stepped Bent Strip fastened to the Bush Wheel 2 by a Reversed Angle Bracket. The 5½" Strips from which the scale pans are suspended are pivoted at their upper ends on 2" Rods, which are passed through holes in the 12½" Strips of the beam.

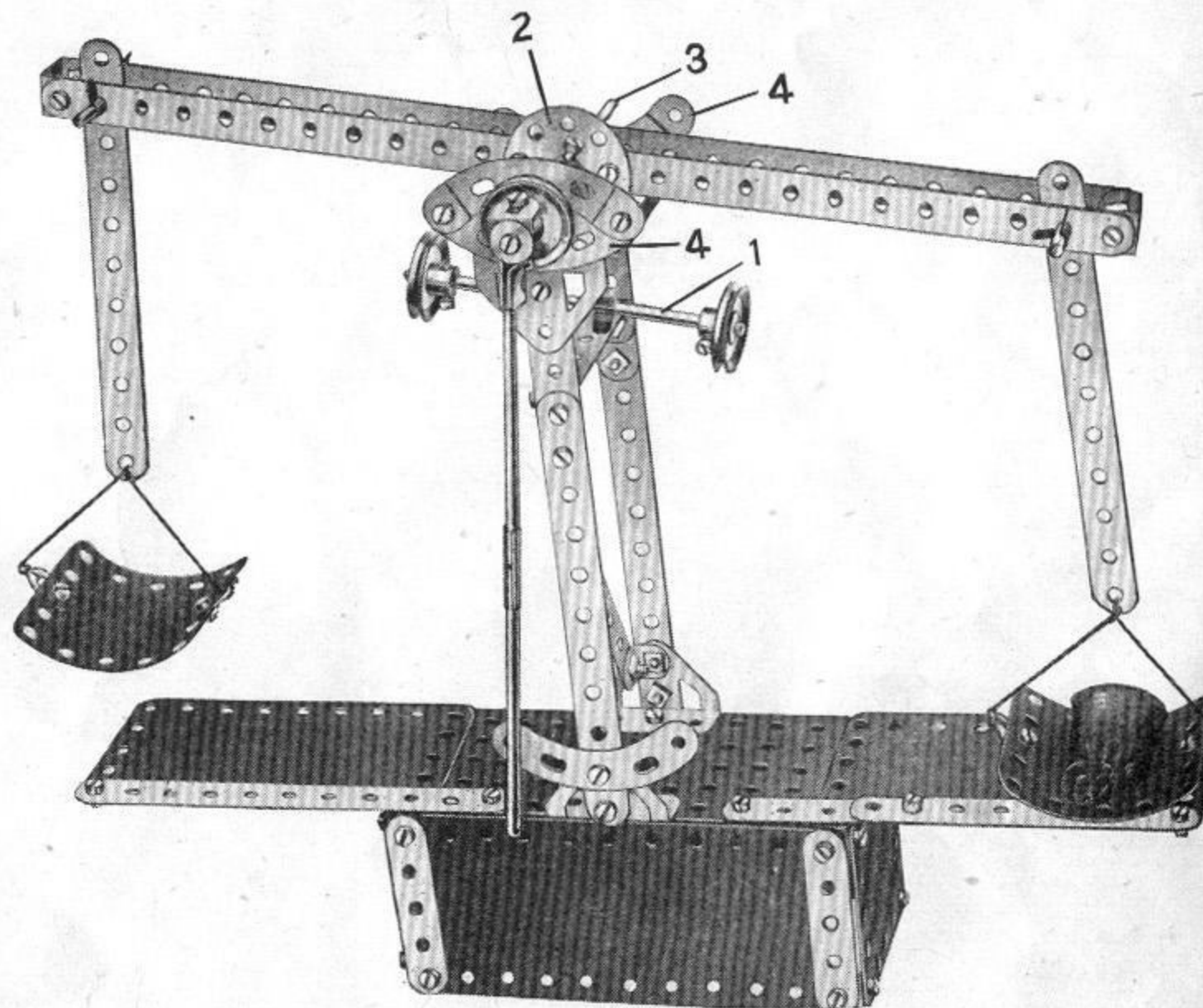

BUILD BIGGER AND BETTER MODELS

When you have built all the models shown in this Book of Instructions, you will be keen to build bigger and more elaborate models. Your next step is to purchase a Meccano No. 3a Accessory Outfit containing all the parts required to convert your No. 3 into a No. 4 Outfit. You will then be able to build the full range of No. 4 Outfit models, a selection of which is illustrated on this page.

If you prefer to do so, you can build up and develop your Outfit quite easily by adding various parts to it from time to time. The model-building possibilities of the Meccano System are unlimited, and the more Meccano parts you have the bigger and better the models you will be able to build.

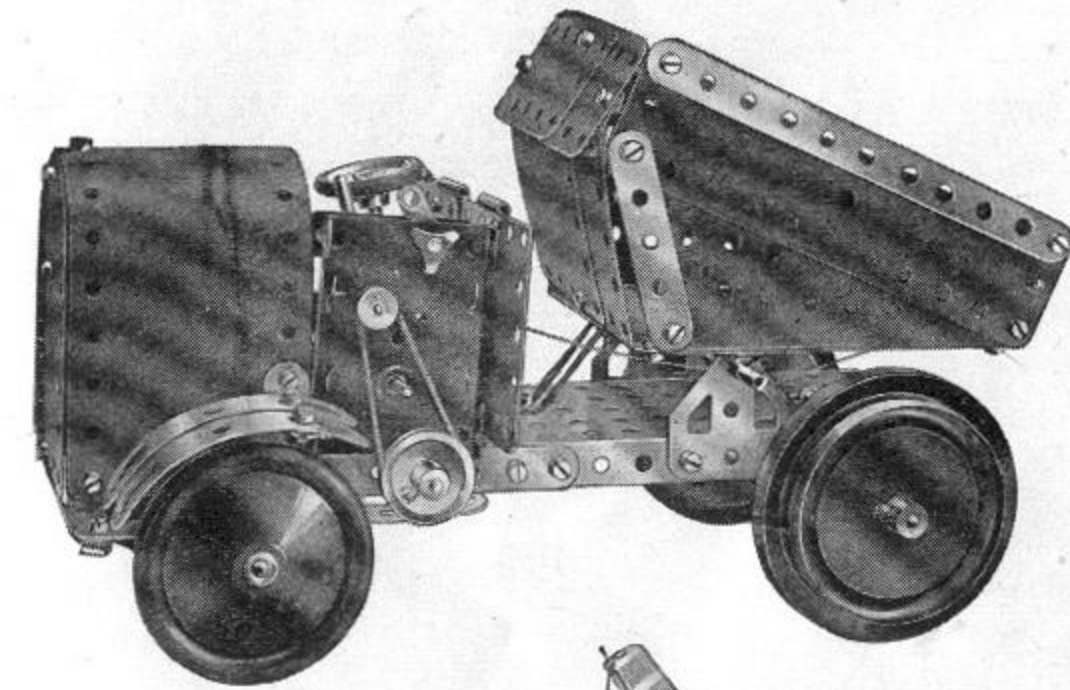

*Dumper
Truck*

(The Motor is not included
in the Outfit)

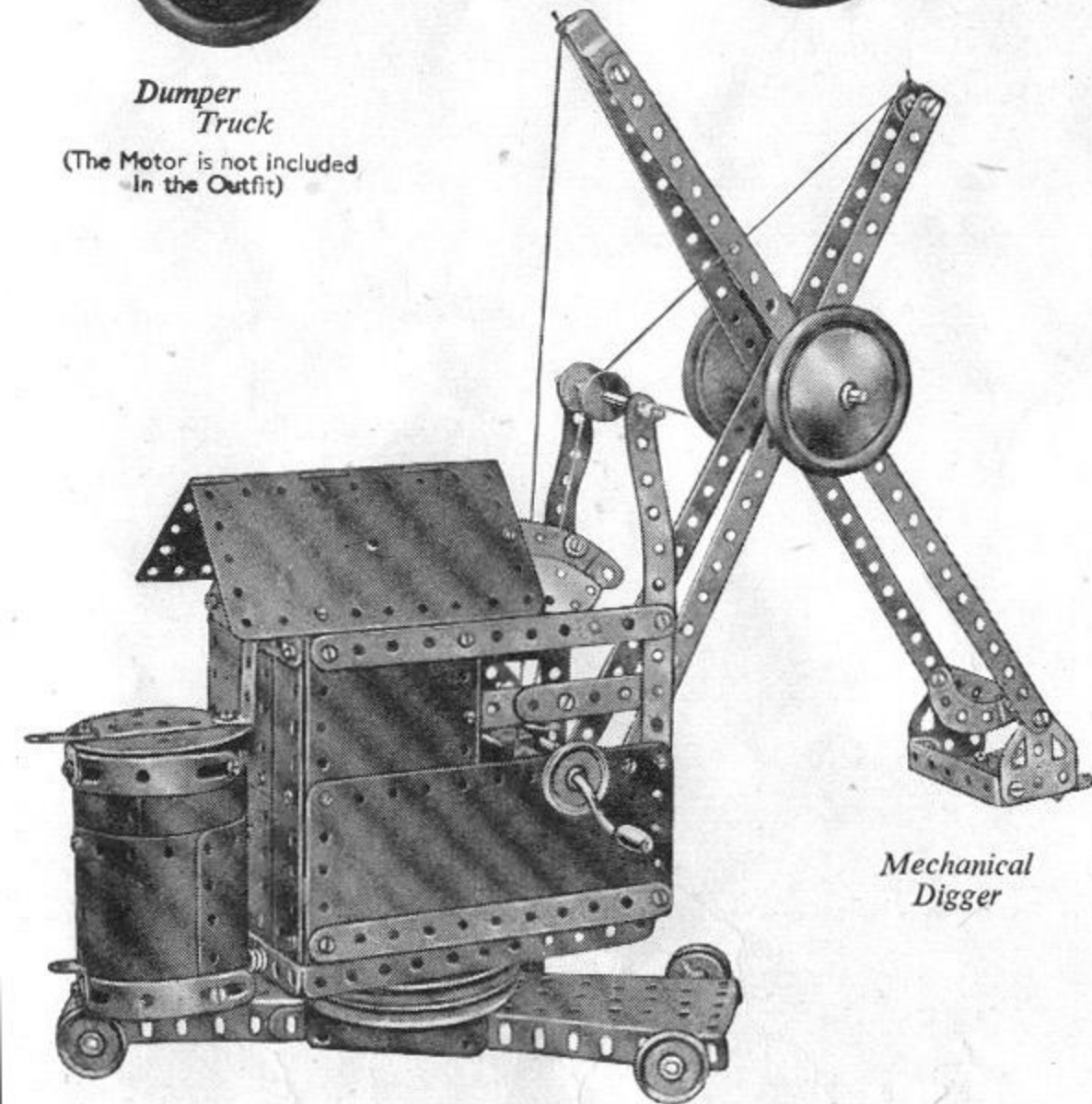

*Mechanical
Digger*

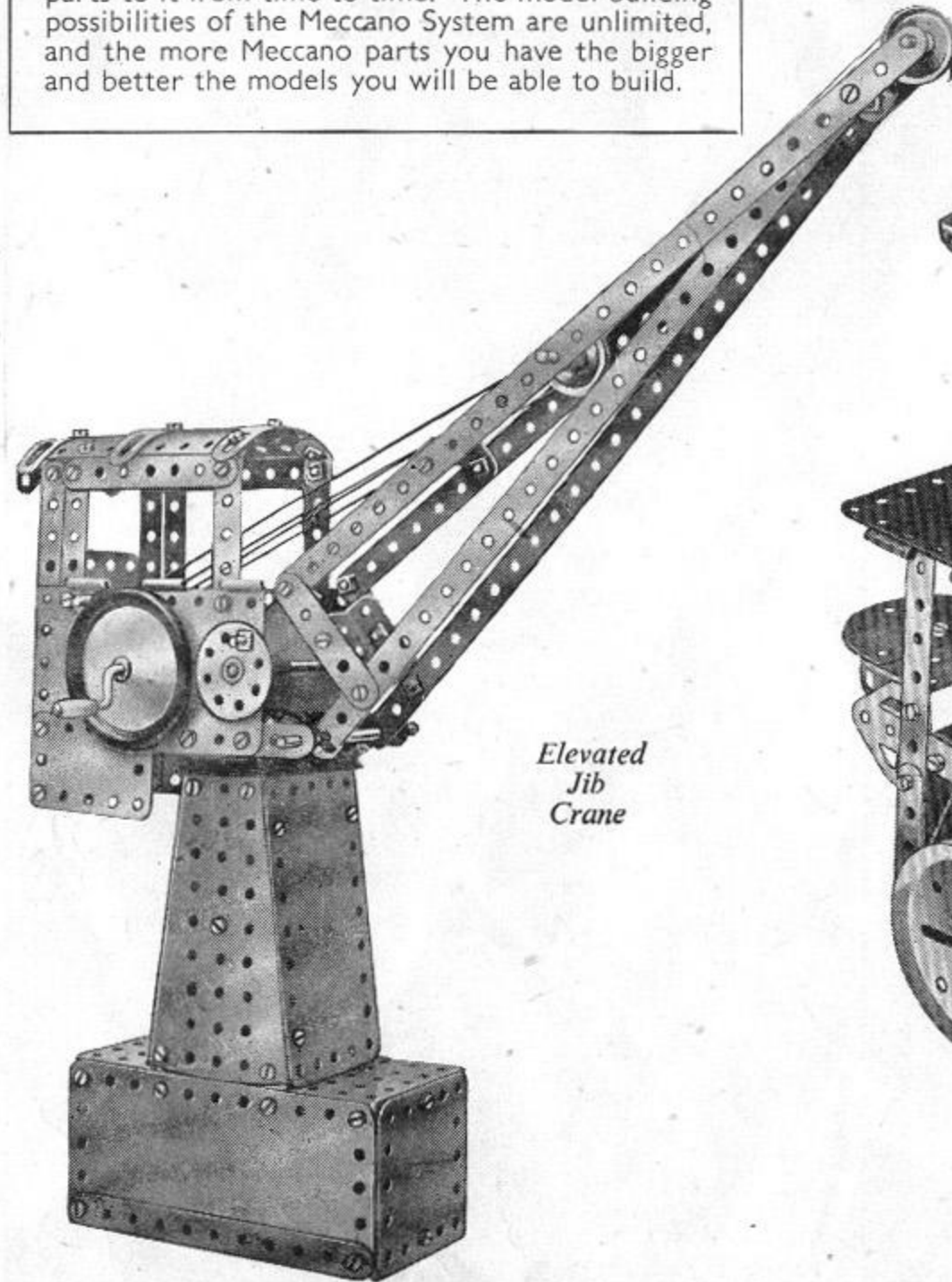

*Elevated
Jib
Crane*

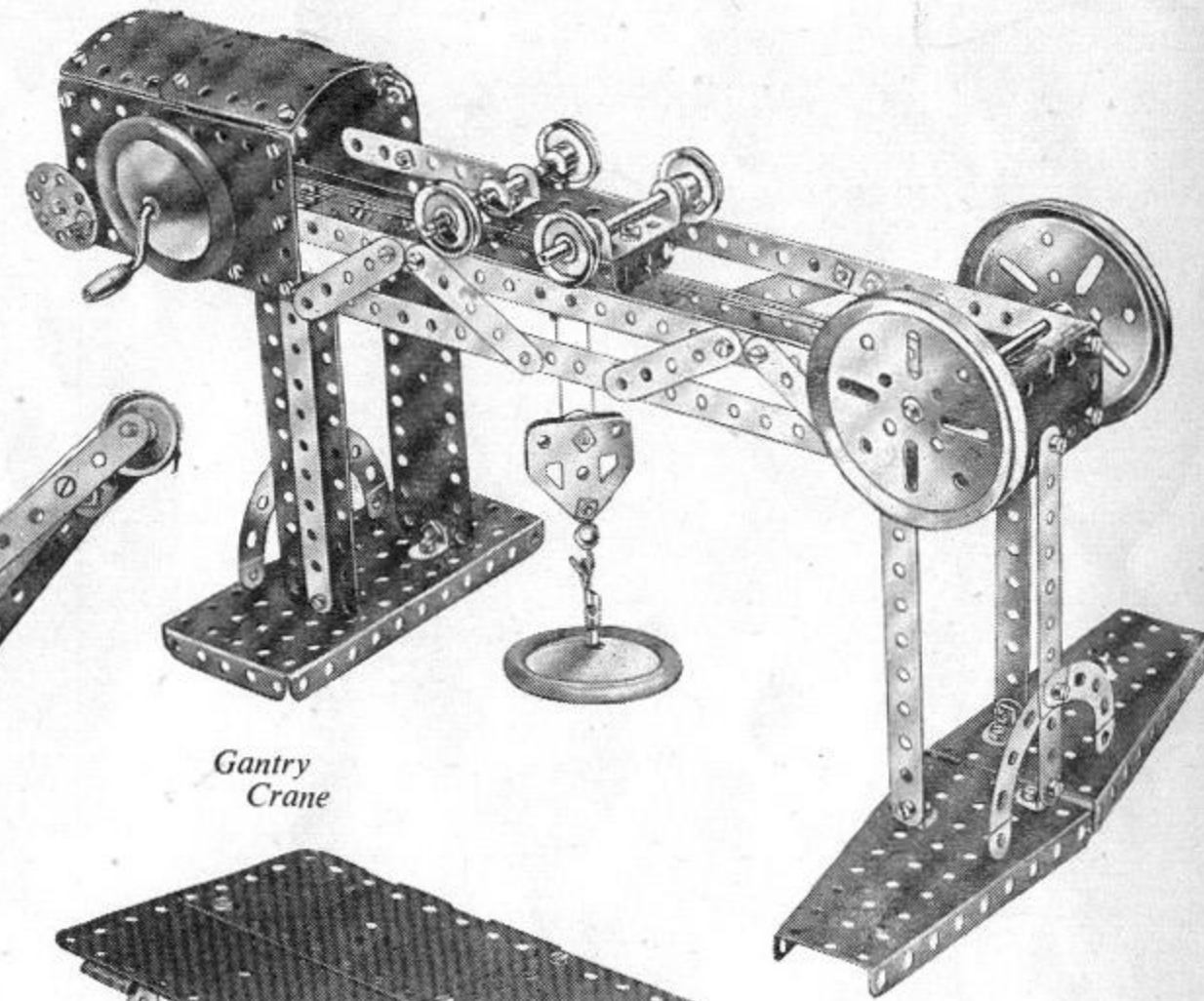

*Gantry
Crane*

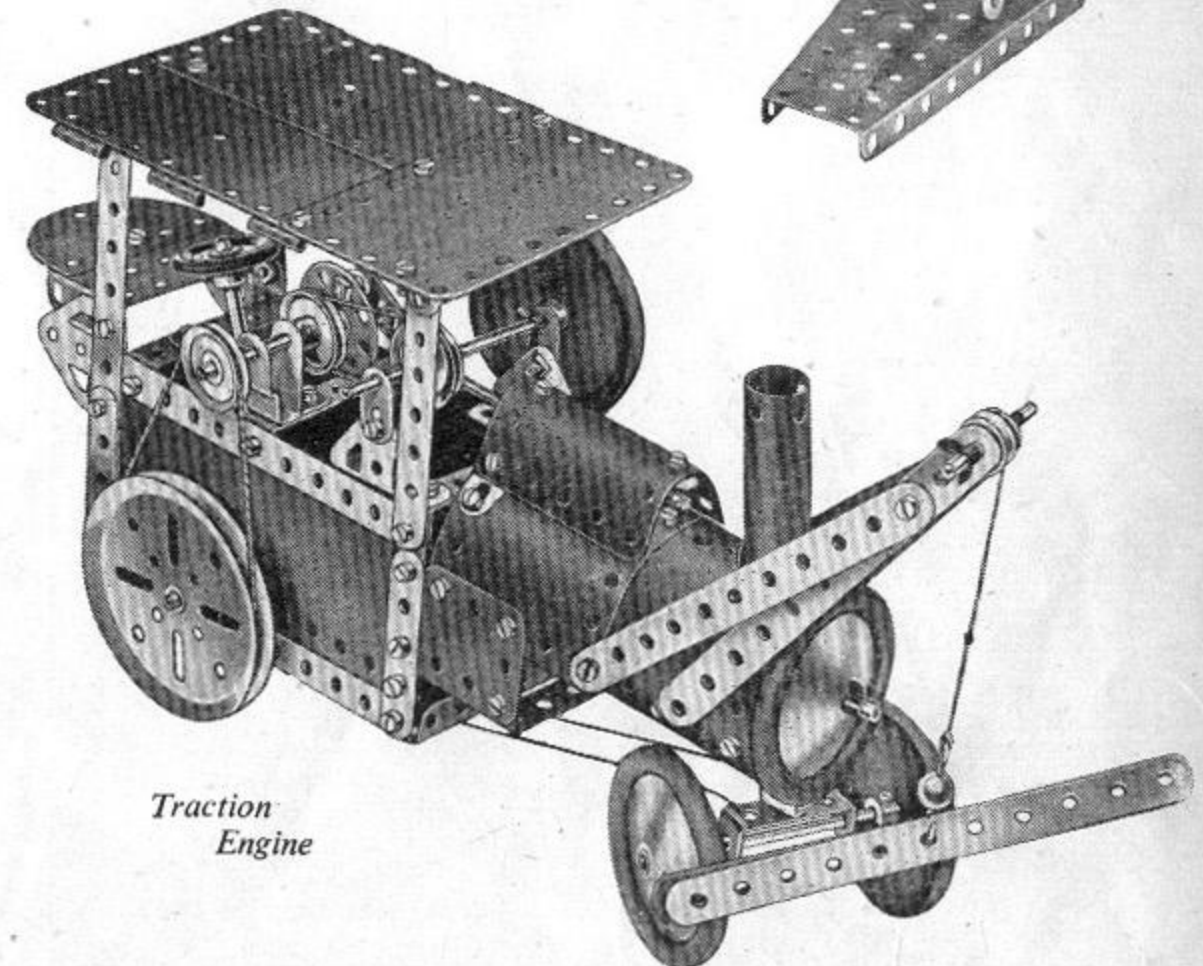

*Traction
Engine*

Here are a few simple and interesting movements showing how easily real mechanisms can be reproduced with Meccano.

USEFUL BAND BRAKE

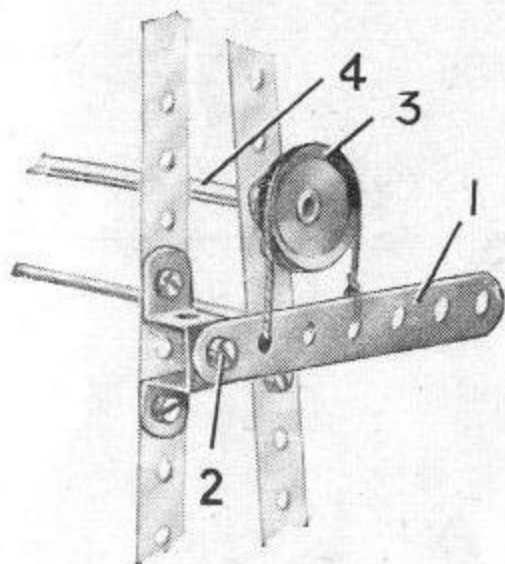

S.M.111. The brake lever consists of a $3\frac{1}{2}$ " Strip 1, pivotally attached at a suitable point on the frame of the model, to be fitted, by means of a lock-nutted $\frac{3}{8}$ " Bolt 2. The driven shaft 4 is fitted at one end with a 1" fast Pulley 3 round which a short length of cord is passed. The two ends of this Cord are secured to the brake lever at the points shown in the illustration.

If increased braking effect is desired a larger Pulley may be used in place of the 1" fast Pulley 3, the brake later 1 being attached in a lower position if necessary. Alternatively a weight can be hung from the end of the brake lever.

SIMPLE STEERING GEAR

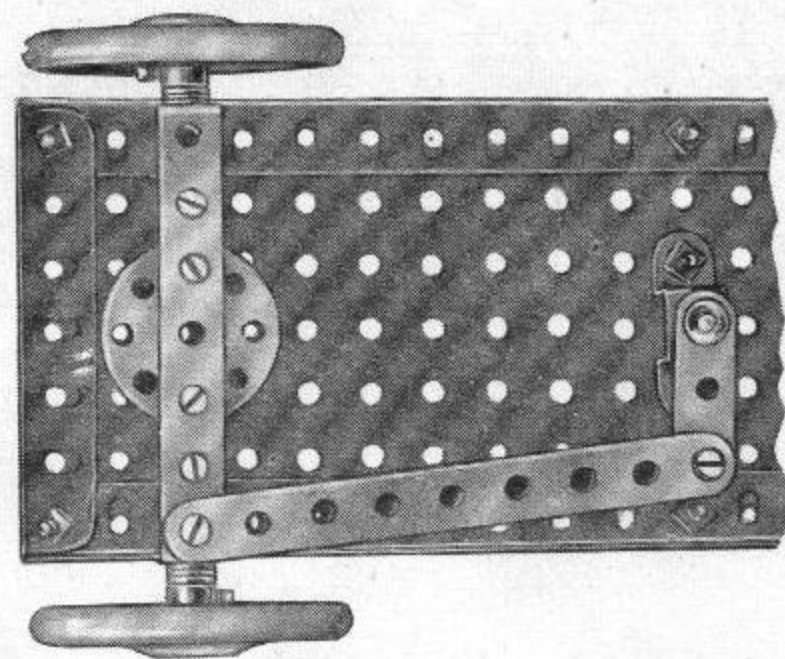

S.M.162. The simple steering gear will be found suitable for most small model vehicles.

In this example the two front wheels are mounted on separate stub axles that are secured to each end of a rigid front axle. The base of the chassis consists of two long Angle Girders connected together at the front end by a $3\frac{1}{2}$ " Angle Girder and filled in along their length by means of $5\frac{1}{2}$ " x $3\frac{1}{2}$ " Flat Plates.

The front axle, a $3\frac{1}{2}$ " x $\frac{1}{2}$ " Double Angle Strip, is pivotally mounted at its centre on a Bush Wheel and short Rod. It is fitted, $\frac{1}{2}$ " from each end, with a $\frac{1}{2}$ " x $\frac{1}{2}$ " Angle Bracket, this forming the inner bearing for its respective stub axle. The outer bearing for the axle consists of the upturned lug of the Double Angle Strip. One end of this latter part is fitted with a pivotally attached $4\frac{1}{2}$ " Strip, by means of which the front axle is linked up to a Crank fixed to the steering column.

SAFETY CATCH FOR CRANE WINDING GEAR

S.M.125. The Compression Spring 3 is mounted on the Crank Handle 1 between the Collar 4 and a Washer, and normally holds the Collar 2 against the inner side of the plate. The Collar 2 is fitted with a $\frac{3}{8}$ " Bolt, and if the Crank Handle commences to rotate, the head of this Bolt strikes against the stop 5 and prevents further movement.

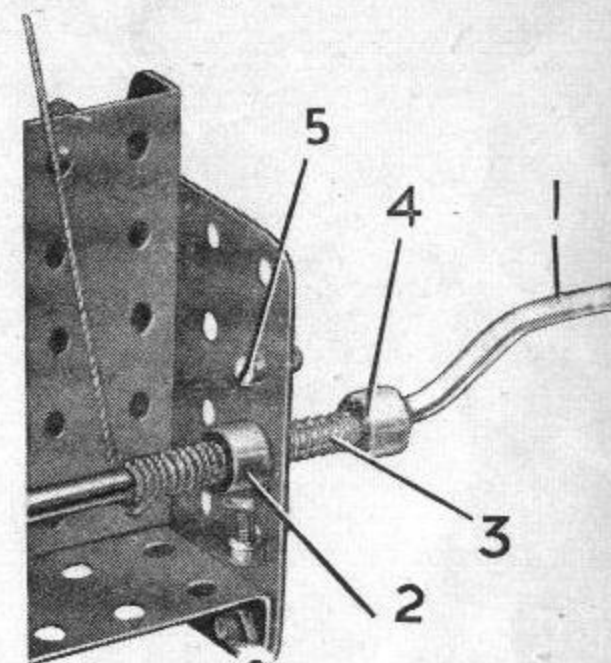

BUILT UP ROLLER BEARING

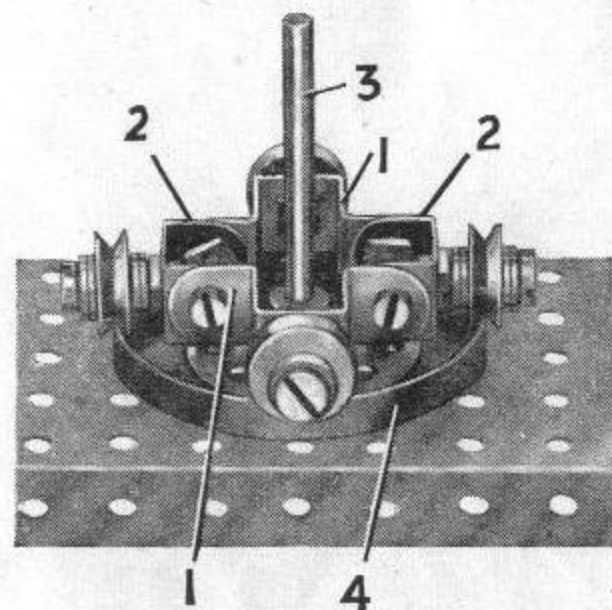

S.M.136. The spider frame is built up from Double Bent Strips 1 connected together by two Double Brackets 2. The four wheels used are represented by $\frac{1}{2}$ " loose Pulleys 4 journalled on Pivot Bolts secured to the outer ends of the four arms of the frame. Four Washers, two on each side of the Pulleys are passed on to the shank of each of the Pivot Bolts that are attached to the Double Brackets 2. In the case of the other two Pivot Bolts, two Washers are placed against the external side only of the Pulley.

BRAKE LEVER and QUADRANT

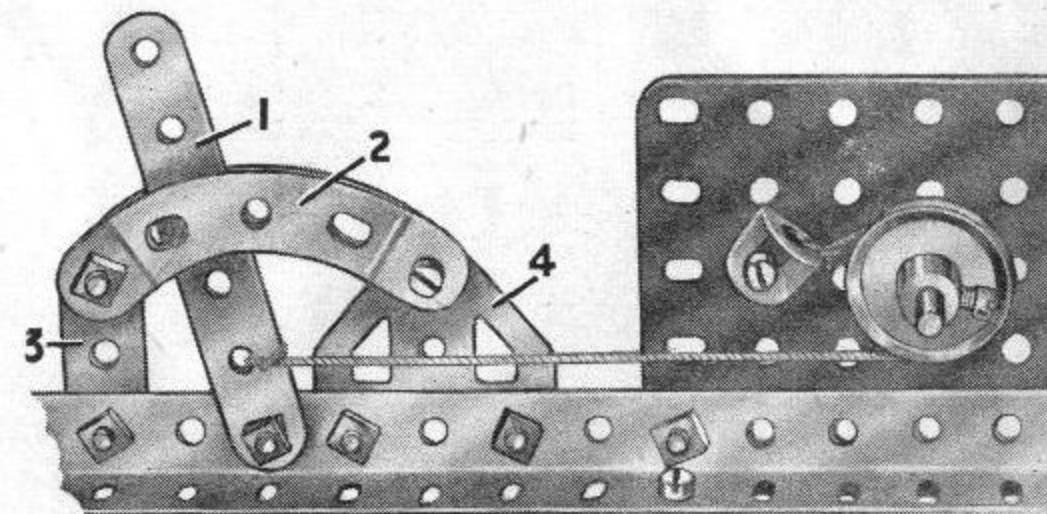

S.M.112. This mechanism is a form of band brake in which the lever 1 can be held in any position by means of the quadrant 2. In this way varying pressures can be applied to the Pulley forming the brake drum.

One end of the brake Cord is attached to a $\frac{1}{2}$ " x $\frac{1}{2}$ " Angle Bracket bolted in a suitable position on the model. After passing round the 1" fast Pulley forming the brake drum the Cord is secured at the next to bottom hole of a 3" Strip 1. This Strip forms the brake lever, and it is secured to the frame of the model by a lock-nutted Bolt.

MECCANO PARTS

3 Perforated Strips

No.	12 1/2"	No.	3.	3 1/2"
1a.	9 1/2"	4.	3 1/2"	
1b.	7 1/2"	5.	2 1/2"	
2.	5 1/2"	6.	2 1/2"	
2a.	4 1/2"	6a.	1 1/2"	

9^a Angle Girders

7.	24 1/2"	9a.	4 1/2"
7a.	18 1/2"	9b.	3 1/2"
8.	12 1/2"	9c.	3 1/2"
8a.	9 1/2"	9d.	2 1/2"
8b.	7 1/2"	9e.	2 1/2"
9.	5 1/2"	9f.	1 1/2"

10 Fishplate
11 Double Bracket
12 Angle Bracket, 1/2" x 1/2"
12a. " " 1" x 1"
12b. " " 1" x 1/2"
12c. Obtuse Angle Bracket, 1/2" x 1/2"

17 Axle Rods

13.	11 1/2"	16.	3 1/2"
13a.	8"	16a.	2 1/2"
14.	6 1/2"	16b.	3 1/2"
15.	5 1/2"	17.	2"
15a.	4 1/2"	18a.	1 1/2"
15b.	4"	18b.	1"

19h Crank Handle, 3 1/2" Shaft with grip
19h. " " 5" " " without grip
19s. " " 3 1/2" " " without grip

19a. Spoked Wheel, 3" diam.
20. Flanged Wheel, 1 1/2" diam.
20b. " " " " " "

19^c Pulleys

19b.	3" diam.	with boss and screw
19c.	6" " "	" " " "
20a.	2" " "	" " " "
21.	1 1/2" " "	" " " "
22.	1" " "	" " " "
22a.	1" " "	without " " " "
23.	1 1/2" " "	" " " "
23a.	1/2" " "	with " " " "

No. **24** Bush Wheel, 1 1/2" diam.
24a. Wheel Disc, 1 1/2" diam., without bush

26 Pinion, 1/2" diam., 25 teeth
25a. " " " " " 25 " "
25b. " " " " " 19 " "
26. " " " " " 19 " "
26a. " " " " " 19 " "
26b. " " " " " 19 " "

27 Gear Wheels
27a. 1 1/2" diam., 50 teeth,
27b. 3 1/2" " " 133 " "
27c. 2 1/2" " " 95 " "

28 Contrate Wheel, 1 1/2" diam., 50 teeth
29. " " " " 25 " "

30 Bevel Gear, 3/8" diam., 26 teeth (for use in pairs)
30a. " " 1 1/2" " 16 " } Can only be
30c. " " 1 1/2" " 48 " } used together

31 Gear Wheel, 1" diam., 1/2" face, 38 teeth
32. Worm, 1/2" diam.

34 Spanner
34b. Box Spanner

35 Spring Clip
36. Screwdriver
36a. " " " " " "
36c. Drift (for levering bolt holes into line)
37. Nut and Bolt, 3/8"
37a. Nut
37b. Bolt, 3/8"
38. Washer
38d. " " 1/2"

40. Hank of Cord

No. **41** Propeller Blade

43 Tension Spring, 2" long

44 Bent Strip, stepped
45. Double Bent Strip
46. Double Angle Strip, 2 1/2" x 1"
47. " " " " 2 1/2" x 1"
47a. " " " " 3 1/2" x 1 1/2"
48. " " " " 1 1/2" x 1 1/2"
48a. " " " " 2 1/2" x 1 1/2"
48b. " " " " 3 1/2" x 1 1/2"
48c. " " " " 4 1/2" x 1 1/2"
48d. " " " " 5 1/2" x 1 1/2"

50 Slide Piece

51. Flanged Plate, 2 1/2" x 1"
52. " " 5 1/2" x 2 1/2"
52a. Flat Plate, " " 5 1/2" x 3 1/2"
53. Flanged Plate, 3 1/2" x 2 1/2"
53a. Flat Plate, 4 1/2" x 2 1/2"

54. Flanged Sector Plate, 4 1/2" long

55. Perforated Strip, slotted, 5 1/2" long
55a. " " " " 2" "

57b. Hook, Loaded, Large
57c. " " Small

58. Spring Cord, 40" Length
58a. Coupling Screw for Spring Cord
58b. Hook for Spring Cord

59. Collar, with screw

No. **61** Windmill Sail

62. Crank
62a. Threaded Crank
62b. Double Arm Crank

63. Coupling
63b. Strip Coupling
63c. Threaded Coupling

64. Threaded Boss
65. Centre Fork
69. Set Screw, 1/8"
69a. Grub Screw, 7/32"
69b. " " 7/32"
69c. " " 7/32"

70. Flat Plate, 5 1/2" x 2 1/2"
72. " " 2 1/2" x 2 1/2"
73. " " 3" x 1 1/2"
76. Triangular Plate, 2 1/2" " 1"
77. " " " " " "

80^a Screwed Rods

78.	11 1/2"	80b.	4 1/2"
79.	8"	80c.	3 1/2"
79a.	6"	81.	2"
80.	5 1/2"	82.	1"
80a.	3 1/2"		

89. Curved Strip, 5 1/2", 10" radius
89a. " " stepped, 3", 1 1/2" radius,
89b. Curved Strip, stepped, 4", 4 1/2" radius,
90. Curved Strip, 2 1/2", 2 3/4" radius
90a. " " stepped, 2 1/2", 1 3/8" radius,

94. Sprocket Chain, 40" length
95. " Wheel, 2" diam. 36 teeth,
95a. " " 1 1/2" " 28 " "
95b. " " 3" " 56 " "
96. " " 1" " 18 " "
96a. " " 3/4" " 14 " "

No. **99** Braced Girders

97.	3 1/2" long	99a.	9 1/2" long
97a.	3" " "	99b.	7 1/2" " "
98.	2 1/2" " "	100.	5 1/2" " "
99.	12 1/2" " "	100a.	4 1/2" " "

101. Heald, for looms
102. Single Bent Strip

103. Flat Girders

103.	5 1/2" long	103e.	3" long
103a.	9 1/2" " "	103f.	2 1/2" " "
103b.	12 1/2" " "	103g.	2" " "
103c.	4 1/2" " "	103h.	1 1/2" " "
103d.	3 1/2" " "	103k.	7 1/2" " "

104. Shuttle, for looms
105. Reed Hook, for looms

106. Wood Roller
106a. Sand Roller

108. Corner Gusset
109. Face Plate, 2 1/2" diam.

110. Rack Strip, 3 1/2" long
110a. " " 6 1/2" " "

111. Bolt, 3/8" " " " **111c.** Bolt, 3/8" " " " **111d.** " " 1 1/2" " "

113. Girder Frame

114. Hinge
115. Threaded Pin
116. Fork Piece, Large
116a. " " Small
117. Steel Ball, 3/8" diam.

118. Hub Disc, 5 1/2" diam.

MECCANO PARTS

No. 120b. Compression Spring, $\frac{1}{8}$ " long



122. Miniature Loaded Sack



123. Cone Pulley, $1\frac{1}{2}$ ", 1" and $\frac{3}{4}$ " diam.
124. Reversed Angle Bracket, 1"
125. " " " " $\frac{1}{2}$ "



126. Trunnion 126a. Flat Trunnion



127. Bell Crank
128. Bell Crank, with Boss



129. Toothed Segment, $1\frac{1}{2}$ " radius

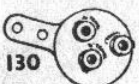

130. Eccentric, Triple Throw, $\frac{1}{2}$ ", $\frac{3}{8}$ " and $\frac{1}{4}$ "
130a. Eccentric, Single Throw, $\frac{1}{2}$ "



131. Dredger Bucket
132. Flywheel, $2\frac{1}{2}$ " diam.



133. Corner Bracket, $1\frac{1}{2}$ "
133a. " " " " 1"



No. 134. Crank Shaft, 1" stroke



136. Handrail Support
136a. Handrail Coupling
137. Wheel Flange



138a. Ship Funnel



139. Flanged Bracket (right)
139a. " " (left)



140. Universal Coupling



142. Rubber Ring (to fit 3" diam. rim)
142a. Motor Tyre (to fit 2" diam. rim)
142b. " " " " 3" " "
142c. " " " " 1" " "
142d. " " " " $1\frac{1}{2}$ " " "



143. Circular Girder, $5\frac{1}{2}$ " diam.



No. 144. Dog Clutch

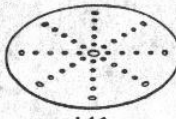

145. Circular Strip, $7\frac{1}{2}$ " diam. overall
146. " " Plate 6" " 4"



147. Pawl, with Pivot Bolt and Nuts
147a. Pawl
147b. Pivot Bolts with 2 Nuts
147c. Pawl without boss
148. Ratchet Wheel



151. Pulley Block, Single Sheave
152. " " Two " "
153. " " Three " "



154a. Corner Angle Bracket, $\frac{1}{2}$ " (right-hand)
154b. Corner Angle Bracket, $\frac{3}{8}$ " (left-hand)
155. Rubber Ring (for 1" Pulleys)



157. Fan, 2" diam.



160. Channel Bearing, $1\frac{1}{2}$ " x 1" x $\frac{1}{2}$ "
161. Girder Bracket, 2" x 1" x $\frac{1}{2}$ "

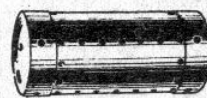

163. Boiler, complete, 5" long x $2\frac{1}{2}$ " diam.
162. " " Ends, $2\frac{1}{2}$ " diam. x $\frac{1}{2}$ "
162b. " " without ends, $4\frac{1}{2}$ " long x $2\frac{1}{2}$ " diam.
163. Sleeve Piece, $1\frac{1}{2}$ " long x $\frac{1}{2}$ " diam.
164. Chimney Adaptor, $\frac{3}{8}$ " diam. x $\frac{1}{2}$ " high



165. Swivel Bearing
166. End " " Flanged Ring, $9\frac{3}{8}$ " diam.
167b. Flanged Ring, $9\frac{3}{8}$ " diam.

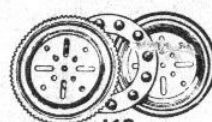

168. Ball Bearing, 4" diam.
168a. " Race, flanged disc, $3\frac{3}{8}$ " diam.
168b. " " toothed " " 4" diam.
168c. " Cage, $3\frac{3}{8}$ " diam., complete with balls.



171. Socket Coupling



175. Flexible Coupling Unit



176. Anchoring Spring for Cord

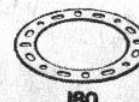

179. Rod Socket
180. Gear Ring, $3\frac{1}{2}$ " diam. (133 ext. teeth, 95 int.)



No. 185. Steering Wheel, $1\frac{1}{2}$ " diam.
186. Driving Band, $2\frac{1}{2}$ " (Light)
186a. " " " " 6"
186b. " " " " 10"
186c. " " " " 10" (Heavy)
186d. " " " " 15"
186e. " " " " 20"
187. Road Wheel, $2\frac{1}{2}$ " diam.
187a. Conical Disc, $1\frac{1}{2}$ " diam.

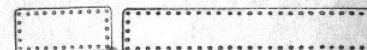

192. Flexible Plates.
188. $2\frac{1}{2}$ " x $1\frac{1}{2}$ " | 190a. $3\frac{1}{2}$ " x $2\frac{1}{2}$ "
189. $5\frac{1}{2}$ " x $1\frac{1}{2}$ " | 191. $4\frac{1}{2}$ " x $2\frac{1}{2}$ "
190. $2\frac{1}{2}$ " x $2\frac{1}{2}$ " | 192. $5\frac{1}{2}$ " x $2\frac{1}{2}$ "
Strip Plates.
196. $9\frac{3}{8}$ " x $2\frac{1}{2}$ " | 197. $12\frac{1}{2}$ " x $2\frac{1}{2}$ "

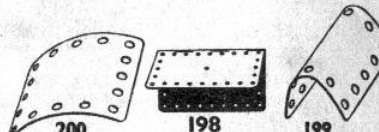

198. Hinged Flat Plate, $4\frac{1}{2}$ " x $2\frac{1}{2}$ "
199. Curved Plate, U-Section
200. " " $2\frac{1}{2}$ " x $2\frac{1}{2}$ " x $\frac{1}{8}$ " radius
" " $2\frac{1}{2}$ " x $2\frac{1}{2}$ " x $1\frac{1}{8}$ " radius



211a & 211b. Helical Gear, $1\frac{1}{2}$ "
Can only be used together



212. Rod and Strip Connector
213. Rod Connector



214. Semi-Circular Plate, $2\frac{1}{2}$ "
215. Formed Slotted Strip, 3"



216. Cylinder, $2\frac{1}{2}$ " long, $1\frac{1}{4}$ " diam.