

# MECCANO®

# 3

## BOOK OF MODELS

Voorbeeldenboek  
Livre des modèles  
Libro dei modelli  
Modellbuch  
Modellbok  
Libro de modelos

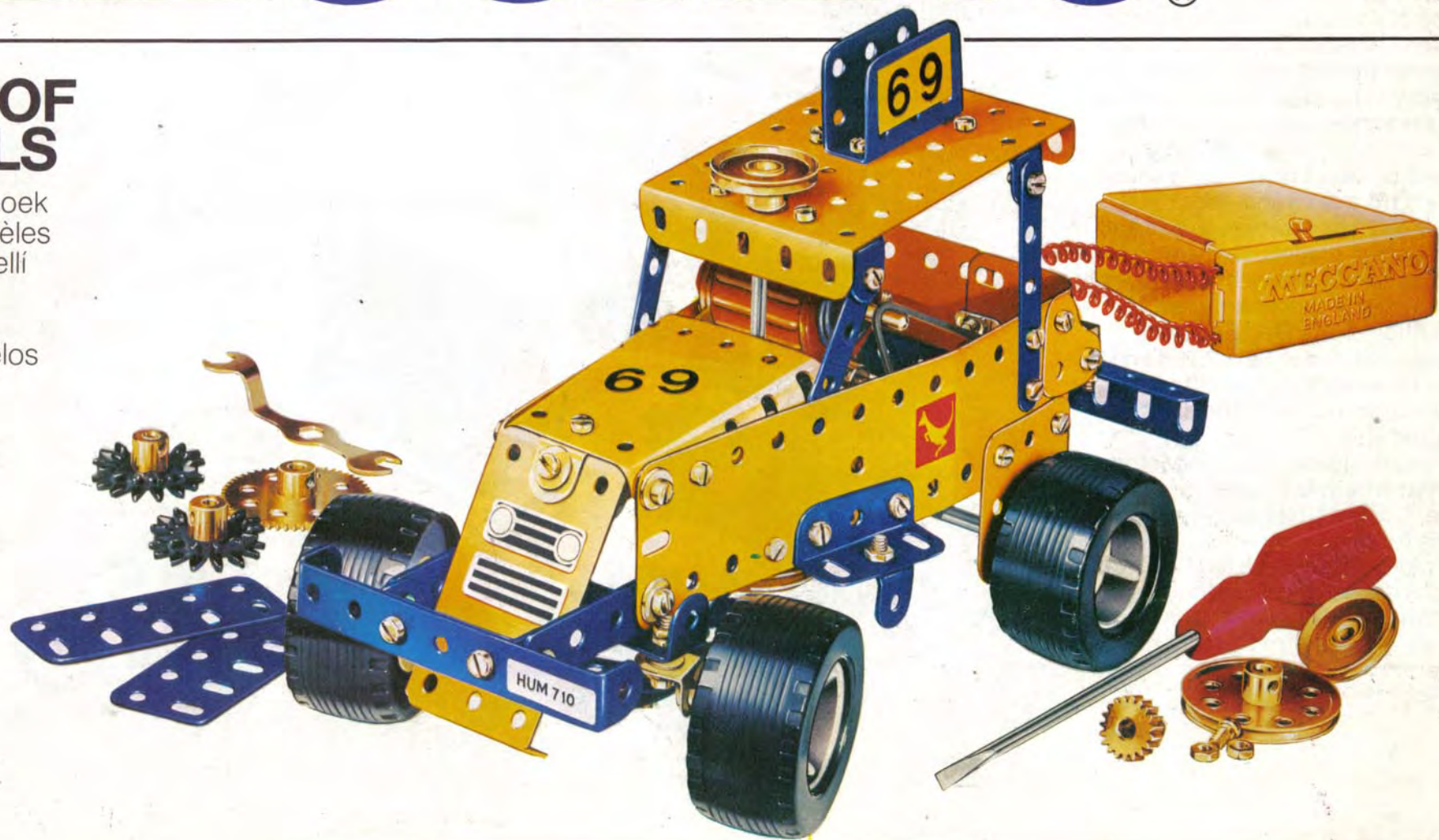

# The next step forward

When you have built all the models in this book, you will want to expand the scope of your Meccano set even further. There are lots of useful add-on extras that are specially designed to help you build even better models. Two extension packs are available. The addition of pack S will enable owners of Sets 1 or 2 to build all the models from set 3 and Pack L will enable Set 3 or 4 owners to build all the No. 5 set models. Owners of set 1 will also need a Meccano Power Pack to motorise their No. 3 models. In addition to the Electric Motor already included in Sets 2, 3, 4 and 5, there's a whole range of different power units to drive models of every type and size. Clockwork Motors, Electric Motors (one has a built-in 6 speed gearbox) Power Control Units and even a real Steam Engine! Don't forget that there are hundreds of different parts in the Meccano System—they are detailed in Book 1, and are available from most Meccano dealers.

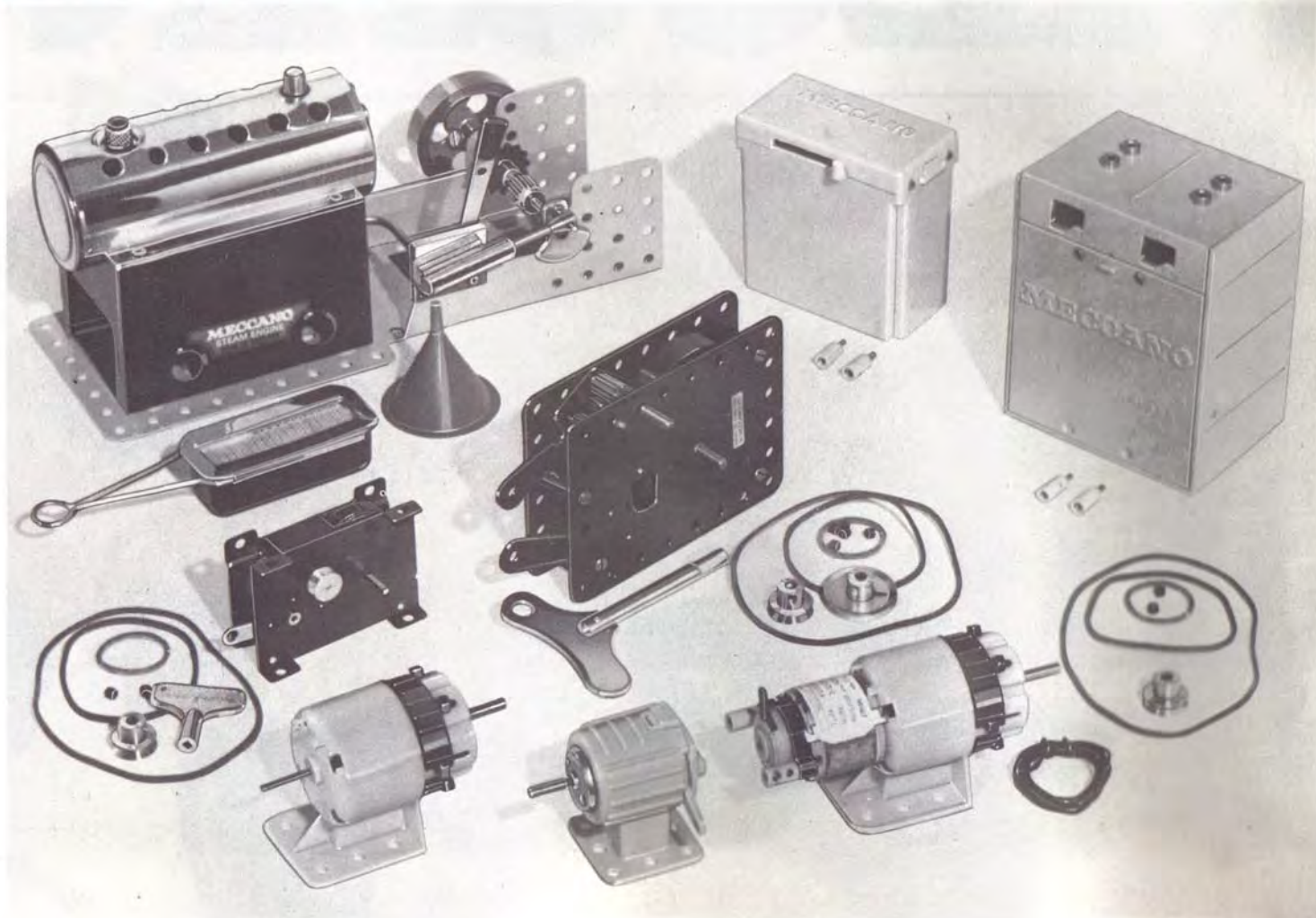

**GB**

This Meccano set includes a 1½-4½ volt DC motor (A), a forward and reverse motor control unit (B), a coil of connecting wire (C), and four plugs (D).

You will need to obtain two HP2 batteries or their equivalent.

**1.** Remove lid from control unit by squeezing the sides. **2.** Insert the batteries the correct way round as shown on the base, and refit the lid. **3.** Cut the wire into two equal lengths and remove about 1 cm of insulation from each end. **4.** Slide the plug body downwards to expose pin, thread bared end of wire through the eye, about 5 mm, slide body upwards to trap the wire. **5.** Insert the plugs from each wire into the motor end plate and the other plugs into one side only of control unit. **6.** To start motor, switch 'on' at both control unit and motor. Moving either switch in the opposite direction will reverse the drive.

**F**

Ce jeu de Mécano comprend un Moteur DC de 1,5-4,5 volts (A), un groupe de commande avant et arrière (B), une bobine de fil de connexion (C) et quatre fiches (D).

Vous aurez besoin de deux piles HP2 ou équivalentes.

**1.** Enlever le couvercle du groupe de commande en appuyant sur les côtés. **2.** Placer les piles, la position correcte est illustrée sur le fond, et replacer le couvercle. **3.** Couper le fil en deux longueurs égales et enlever environ 1 cm d'isolant à chaque bout. **4.** Glisser le corps de la fiche vers le bas pour faire

sortir la pointe, passer le fil nu dans le trou, environ 5 mm, retirer le corps vers le haut pour coincer le fil. **5.** Introduire les fiches provenant de chaque fil dans la plaque du moteur et les autres fiches sur un seul côté du groupe de commande. **6.** Pour mettre le moteur en marche, placer le switch sur 'on' au groupe de commande ainsi que sur le moteur. Le déplacement du switch dans la direction opposée renversera la transmission.

**N**

Dette Meccano-settet inneholder en 1½-4½ volt likestrømsmotor (A), en kontrollenhet (B) som regulerer motorens rotasjonsretning, en spole med ledning (C) og fire plugger (D).

Du trenger to HP2 batterier eller tilsvarende for å drive motoren.

**1.** Ta lokket av kontrollenheten ved å trykke sidene sammen. **2.** Legg batteriene på plass, pass på at de ligger riktig vei, se skissen på bunnen av enheten, legg lokket tilbake. **3.** Del ledningen opp i to like store lengder og skrap ca. 1 cm av isolasjonen av hver ende. **4.** Skyv pluggen ned slik at selve pinnen blir blottlagt, stikk den uisolerte enden av ledningen gjennom øyet, ca. 5 mm, skyv selve pluggen opp slik at ledningen holdes fast. **5.** Før pluggene fra hver ledning inn i motorens endeplate og de andre pluggene bare inn i den ene siden av kontrollenheten. **6.** For å starte motoren slår du både kontrollenheten og motoren på. Om du nå vrir på en av bryterne vil motoren dreie i motsatt retning.

**D**

Dieser Meccanosatz schliesst einen 1½-4½ Volt Gleichstrommotor (A), eine Vorwärts- und Rückwärtskontrolleinheit (B), eine Spule Verbindungsdraht (C), und vier Stecker (D), ein. Sie müssen zwei HP 2 Batterien oder ihr Äquivalent verschaffen.

**1.** Entfernen Sie den Deckel der Kontrolleinheit durch Drücken der Seiten. **2.** Setzen Sie die Batterien ein; die genaue Lage ist auf der Basis angegeben, und schliessen Sie den Deckel wieder. **3.** Schneiden Sie den Draht in zwei gleichmässige Längen und entfernen Sie ungefähr 1 cm der Isolierung von jedem Ende. **4.** Lassen Sie den Steckerkörper heruntergleiten, um die Nadel frei werden zu lassen, fädeln Sie das blosse Drahtende durch das Öhr, ungefähr 5 mm, schieben Sie den Körper nach oben, um den Draht festzuhalten. **5.** Setzen Sie die Stecker jedes Drahtes in die Motorkopfplatte ein und die anderen Stecker in nur eine Seite der Kontrolleinheit. **6.** Um den Motor zu starten, stellen Sie auf "an", sowohl bei der Kontrolleinheit, wie beim Motor. Wenn einer der beiden Schalter in entgegengesetzter Richtung bewegt wird, wird die Antriebsrichtung umgekehrt.

**E**

Este equipo de Meccano incluye un Motor DC de 1½-4½ voltios (A), una unidad de control hacia adelante y hacia atrás (B), un rollo de alambre de conexión (C), y cuatro enchufes (D).

Necesitas dos HP2 Pilas o su equivalente.

**1.** Quita la tapa de control de unidad, presionando los lados. **2.** Coloca las pilas, la forma correcta la encuentras en la base, y vuelve a colocar la tapa. **3.** Corta el alambre en dos partes iguales y quita cerca de 1 cm del forro del alambre de cada extremo. **4.** Tira hacia atrás el cuerpo del enchufe dejando descubierto la parte interior. Pasa el alambre pelado por el ojo, más o menos 5 mm. Tira hacia adelante el cuerpo del enchufe para atrapar el alambre. **5.** Inserta los enchufes de cada alambre al final de la plataforma del motor y los otros enchufes en solamente un lado de la unidad de control. **6.** Para hacer funcionar el motor, enciende ambas unidades, la de control y la de motor. Moviendo cualquiera de los encendedores en dirección contraria cambiará la dirección de conducir.

**I**

Questa collezione del Meccano include un motore con voltaggio DC 1½-4½ (A), un motore reparto controllo avanti e indietro (B), una bobina di filo d'induzione (C), e quattro spine (D). È necessario che tu ti provveda di due pile HP2, o equivalenti ad esse.

**1.** Rimuovi il coperchio dal reparto controllo premendo i lati. **2.** Inserisci le pile, la maniera corretta è mostrata sulla base, e rimetti il coperchio. **3.** Taglia il filo elettrico in due lunghezze eguali e rimuovi circa cm 1 d'isolante da ogni estremità. **4.** Tira in giù la cassetta della spina per esporre lo spillo, infila nell'occhio l'estremità scoperta del filo di circa 5 mm, tira in su la cassetta per tenere in trappola il filo. **5.** Inserisci le spine di ogni filo nell'estremità della piastra del motore, e le altre spine in un lato solo del reparto controllo. **6.** Per accendere il motore, accendi tutti e due il reparto controllo e il motore. Muovendo sia l'una che l'altra chiavetta nella direzione opposta si invertirà l'energia.

**NL**

Deze Meccano set bevat een 1½-4½ volt gelijkstroom motor (A), een motorregelapparaat vooruit/achteruit (B), een spoel aansluitingsdraad (C) en vier stekertjes (D).

Je moet twee HP2 of soortgelijke batterijtjes erbij kopen.

**1.** Verwijder het dekseltje van het regelapparaat door de zijkanten in te drukken. **2.** Zet de batterijtjes in de juiste stand zoals op het voetstuk is aangegeven 'er in en zet het dekseltje weer terug. **3.** Knip het draad op twee stukken van gelijke lengte en verwijder ca. 1 cm isolatie van elk der einden. **4.** Schuif de huls van de stekker omlaag zodat de pen wordt blootgesteld, steek het blote draadeind ongeveer 5 mm door de oog, schuif de huls omhoog zodat de draad wordt vastgeklemd. **5.** Steek de stekkers aan beide draadstukken in de achterplaat van de motor en de stekkers aan de andere einden in slechts één zijde van het regelapparaat. **6.** Om de motor aan te zetten, moet zowel het regelapparaat als de motor worden ingeschakeld. Door een der beide schakelaars om te schakelen, loopt de motor in de andere richting.

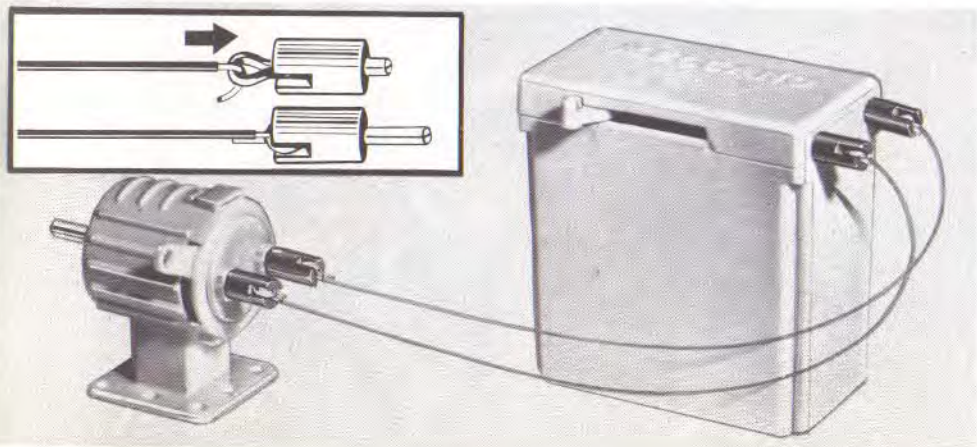

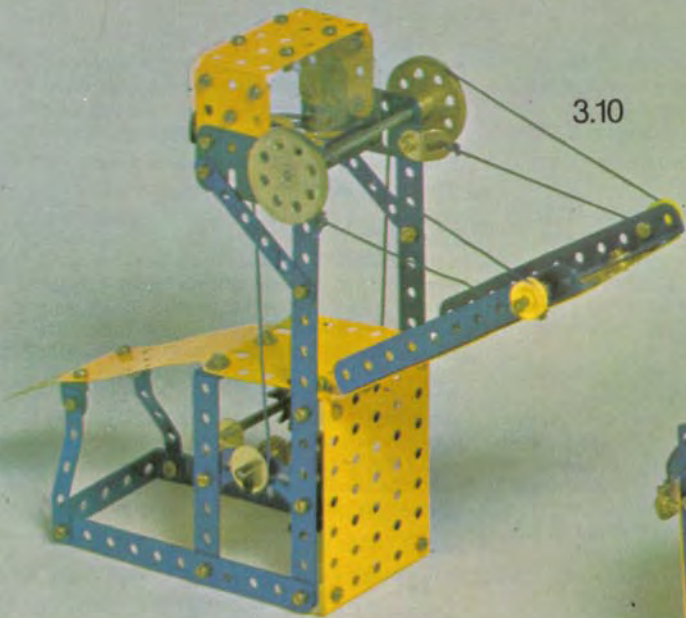

3.10

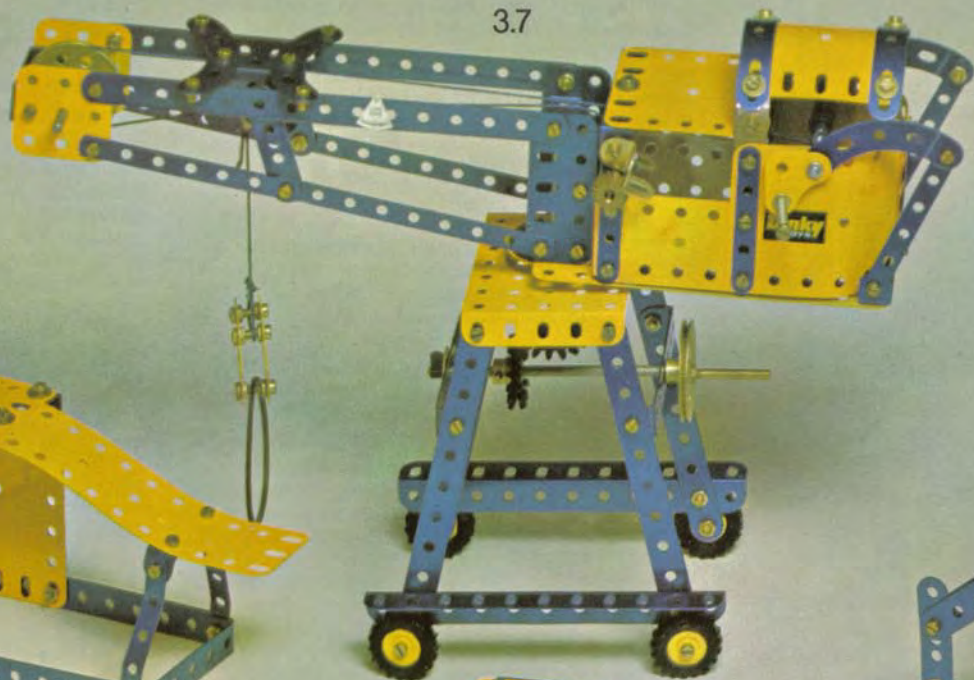

3.7

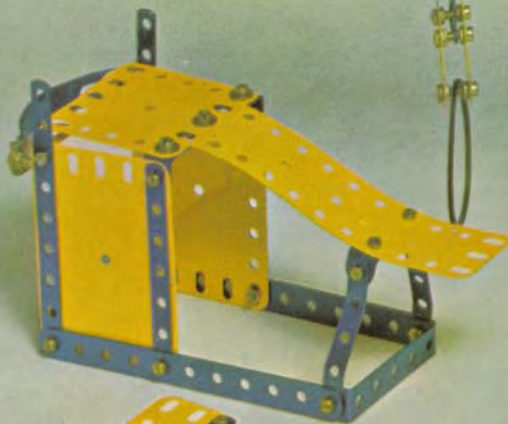

3.5

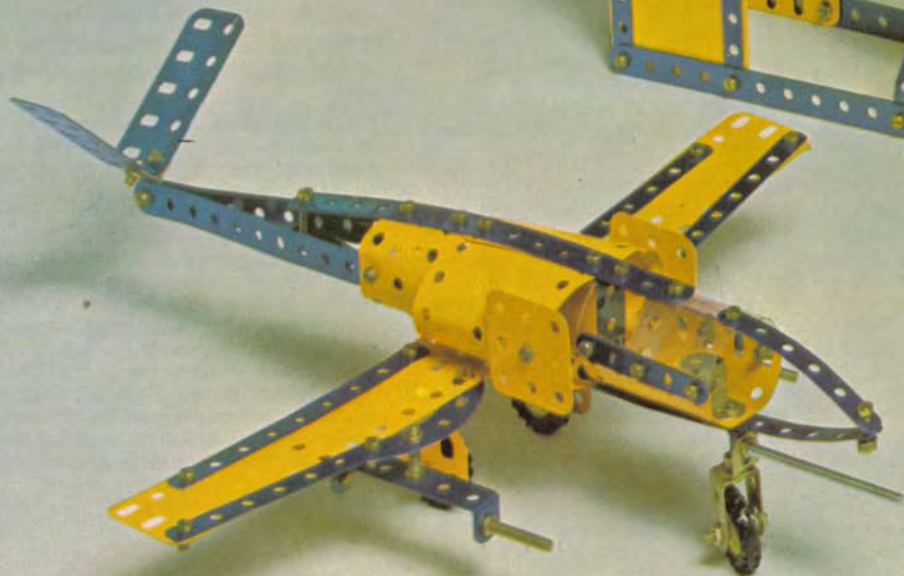

3.3



3.9



3.8

3.6

90

DANGER!

9

3.1

3.2

3.4

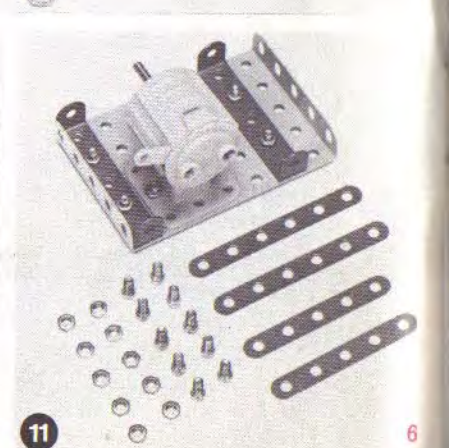
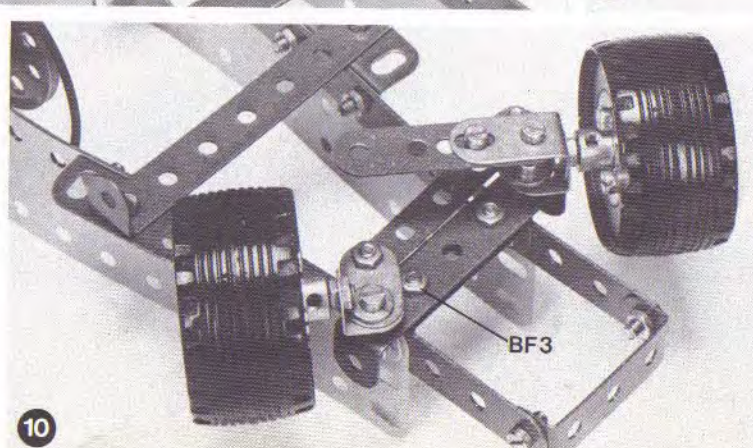
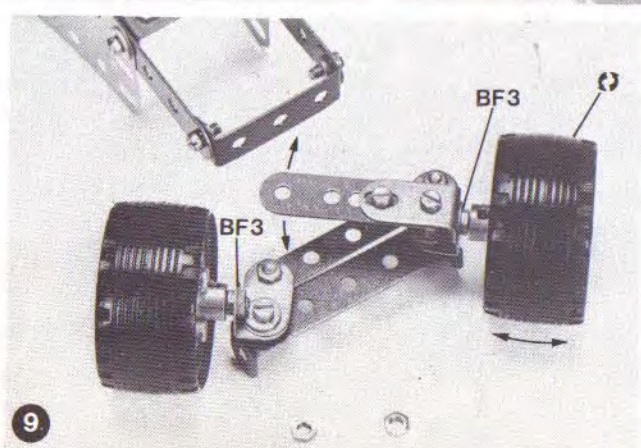
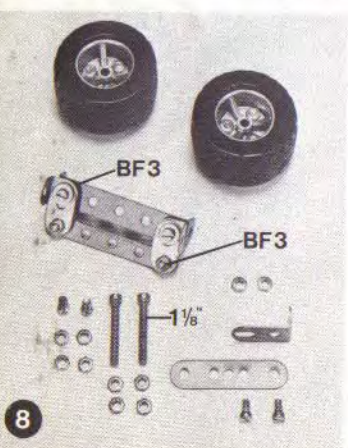
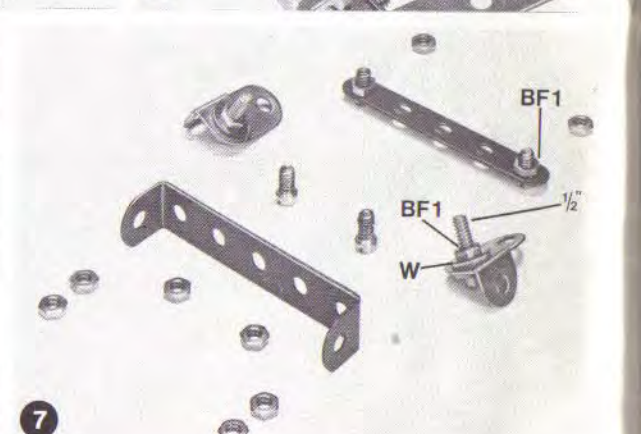
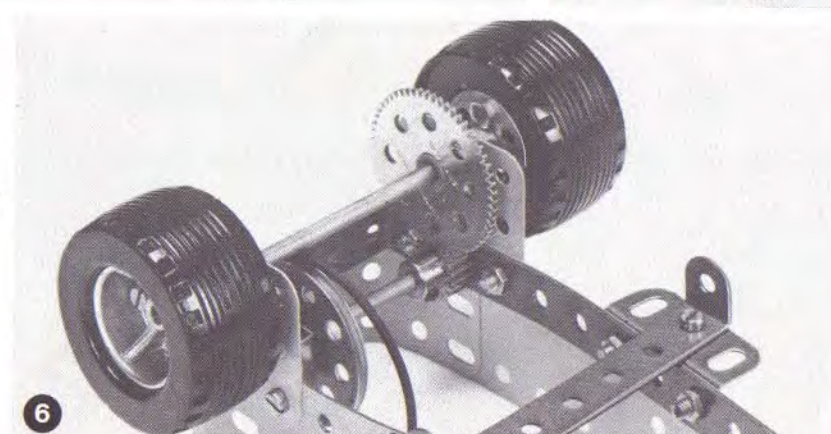
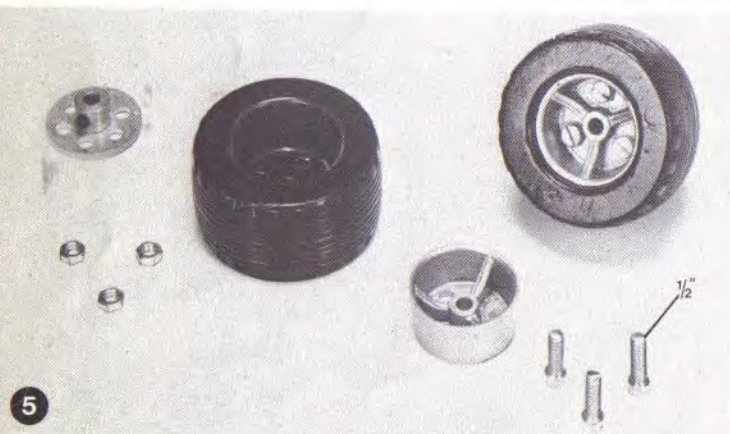
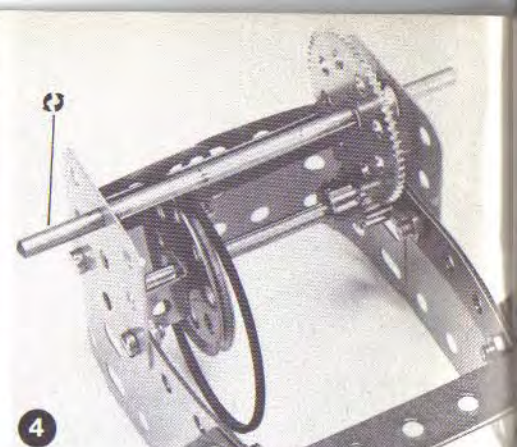
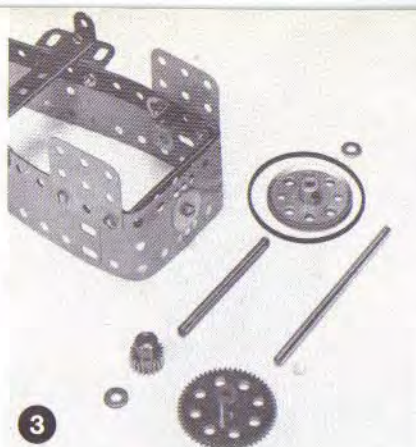
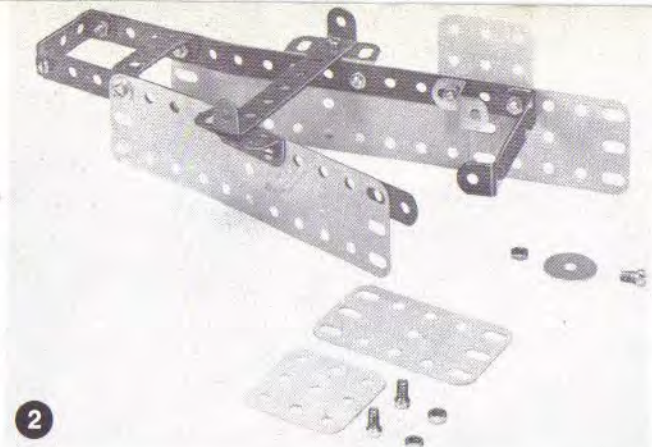
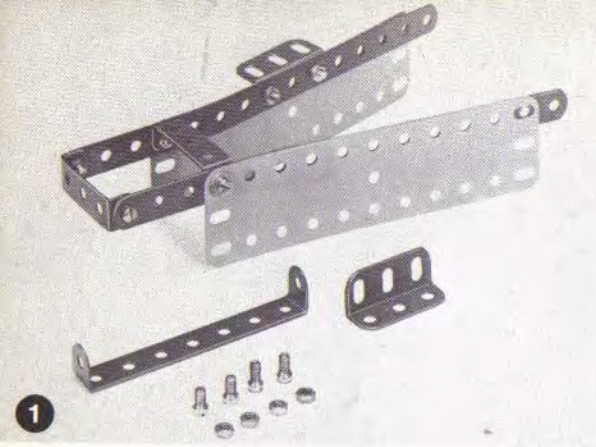

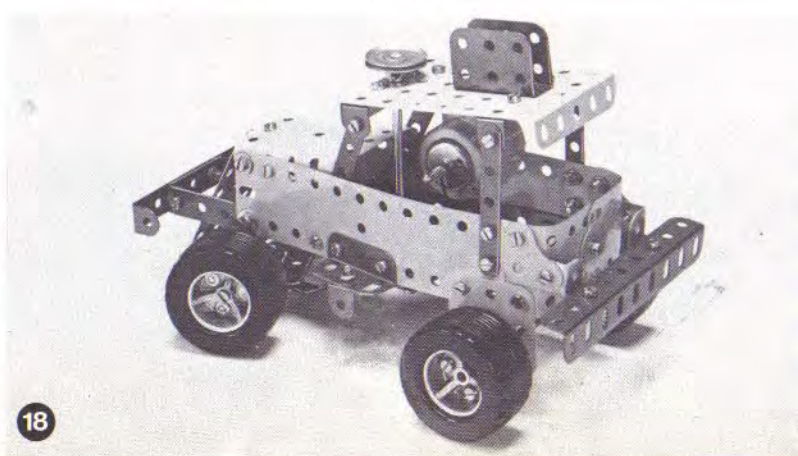
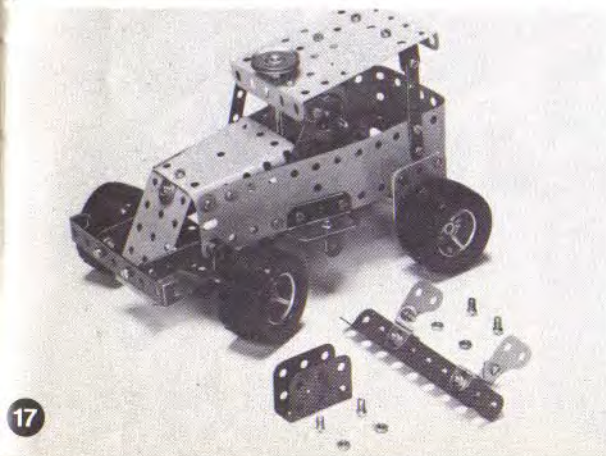
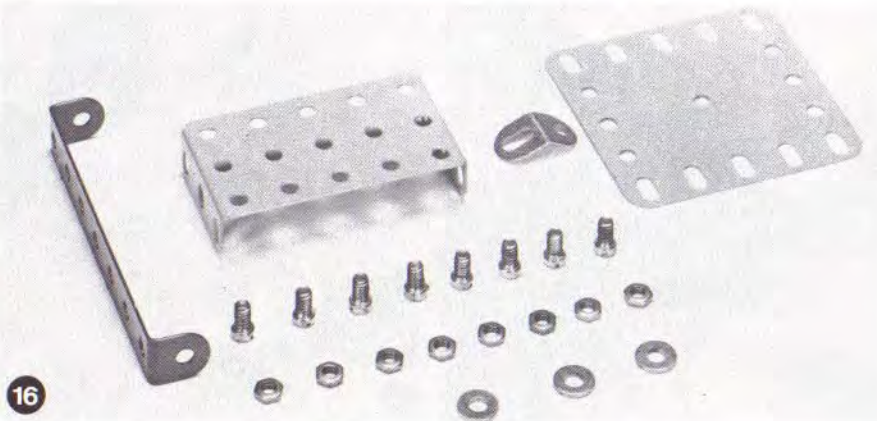
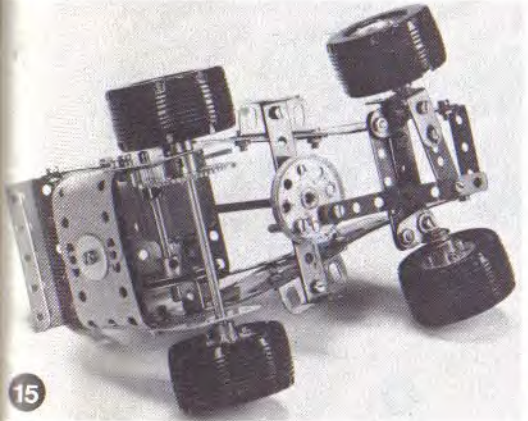
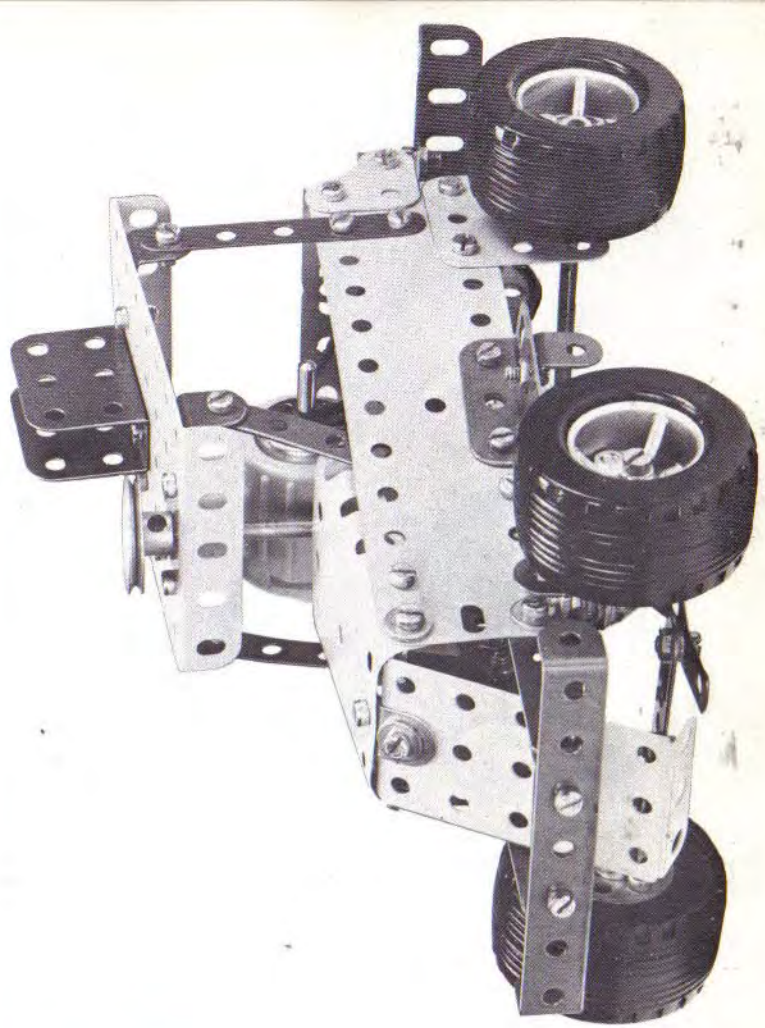
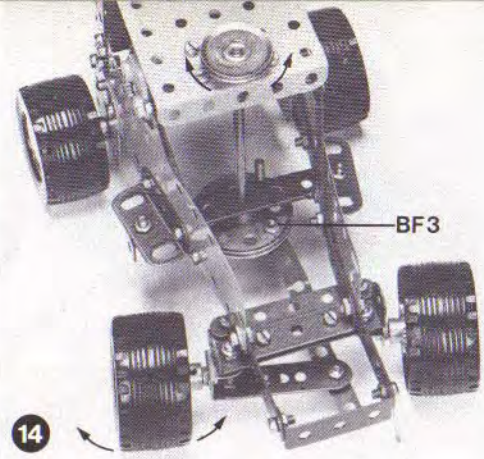
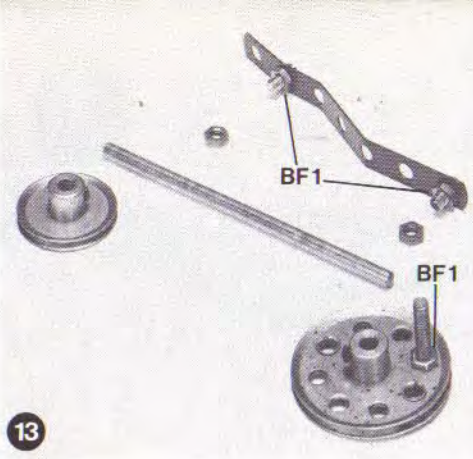
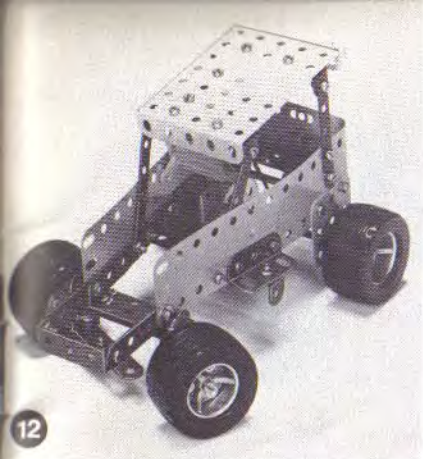

Stock Car  
Stock Car  
stock car  
Stockcar  
Racerbil  
Stock Car  
Stock-Car (Auto d'acrobazia)

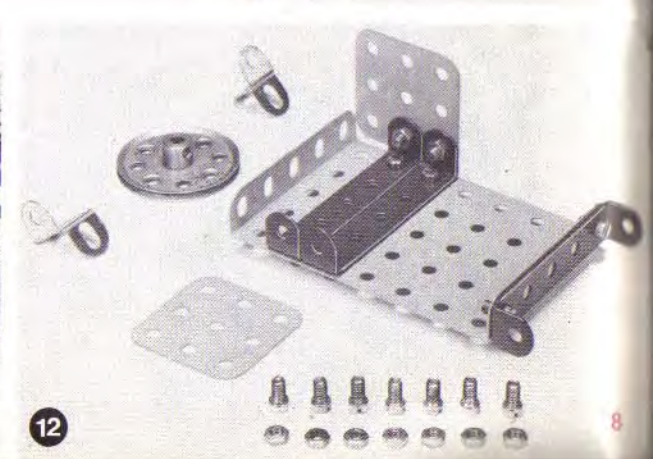
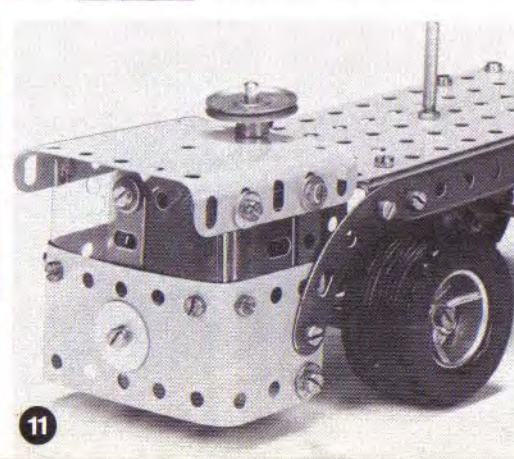
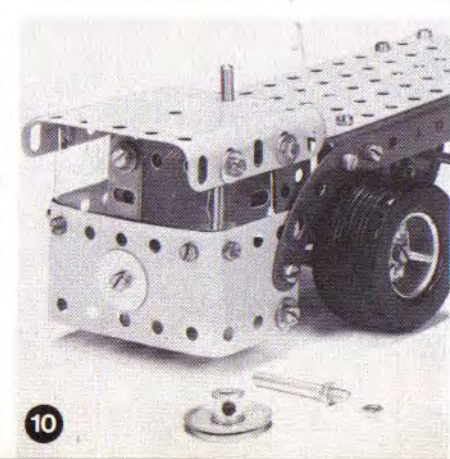
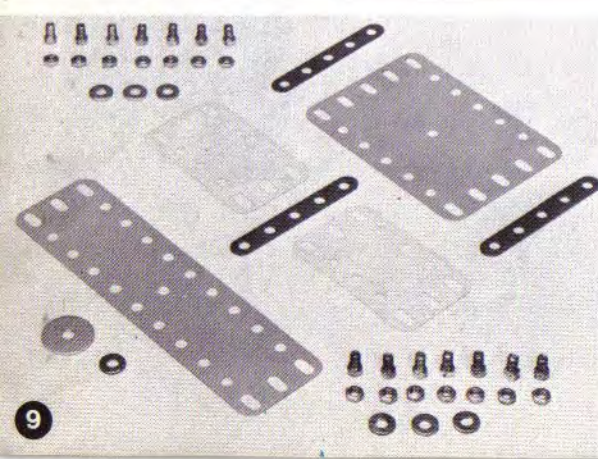
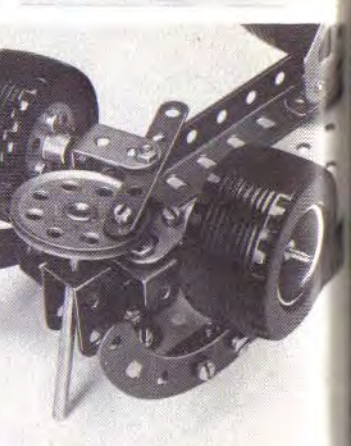
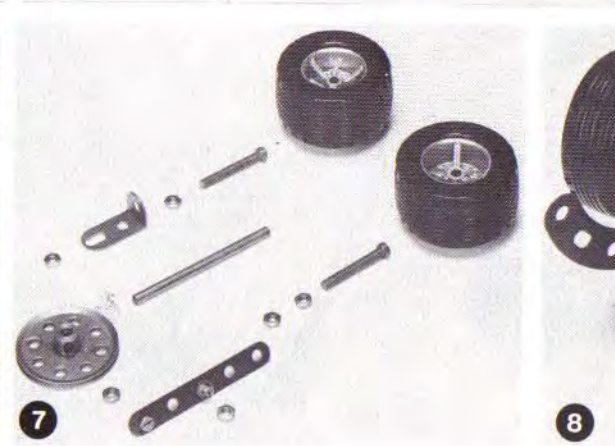
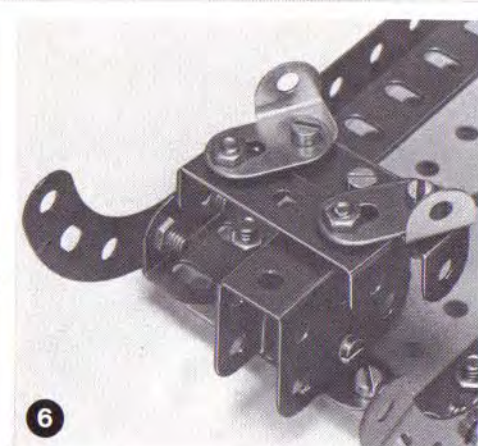
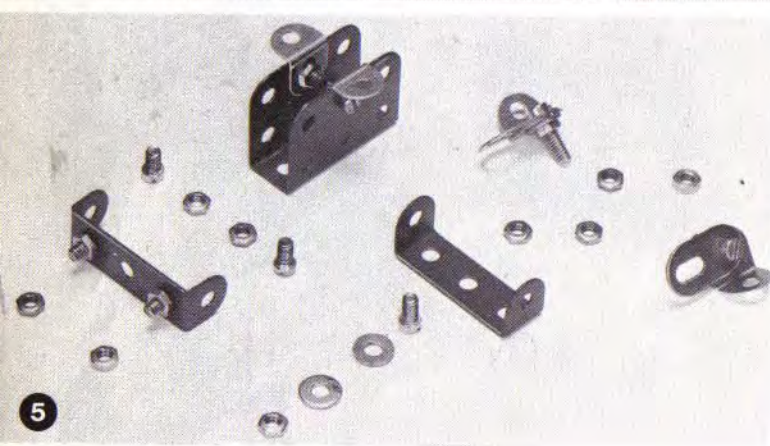
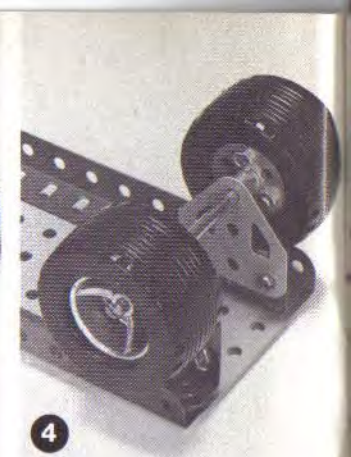
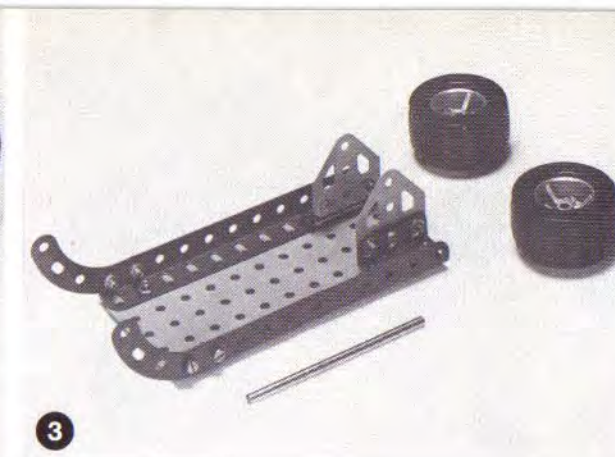
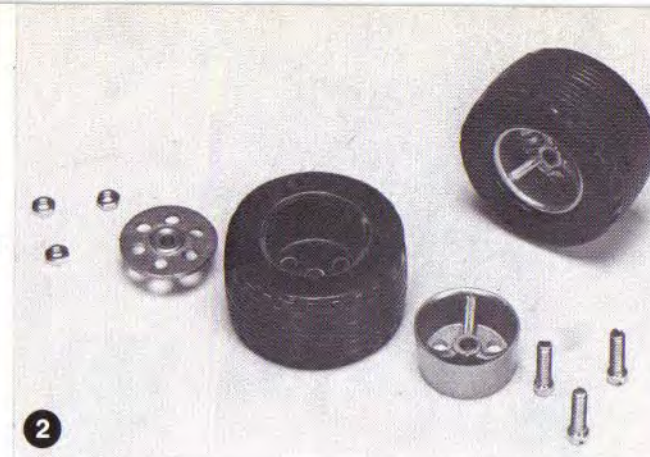
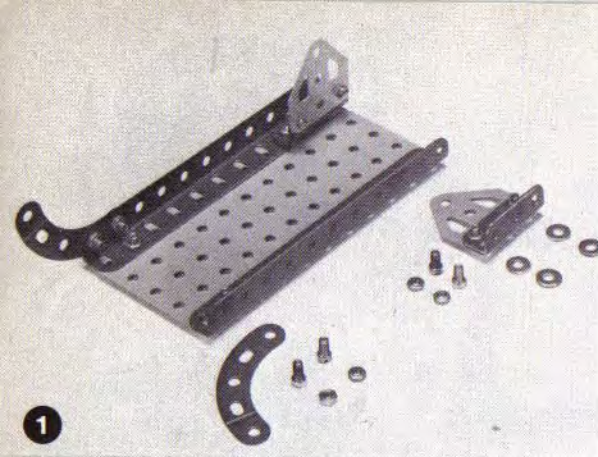



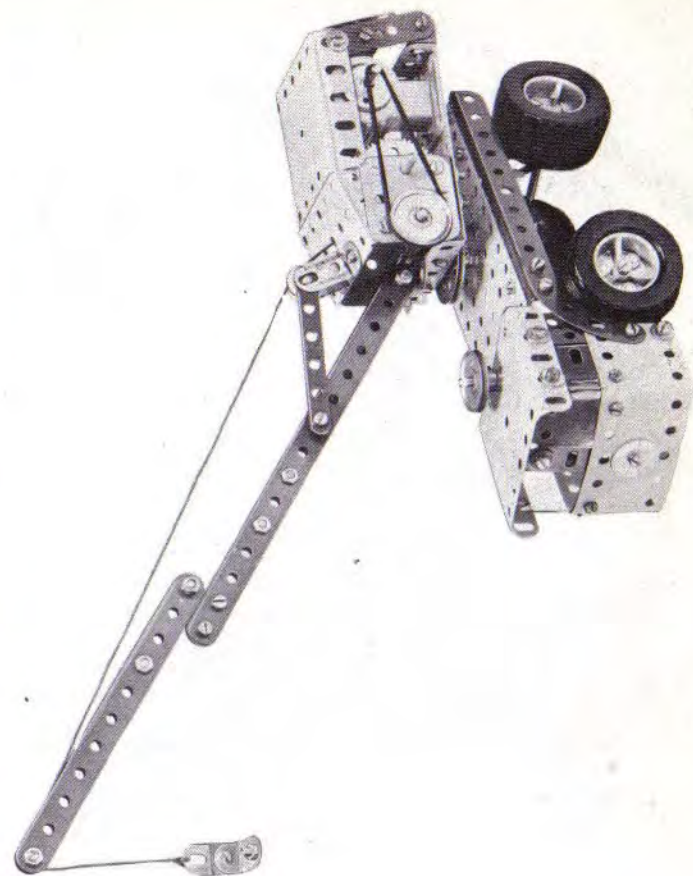
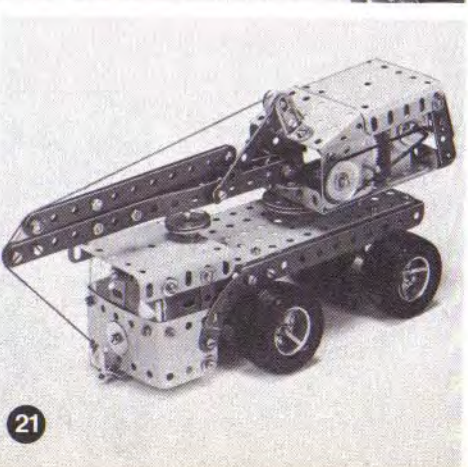
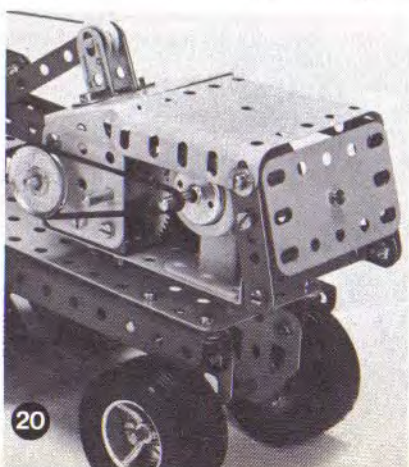
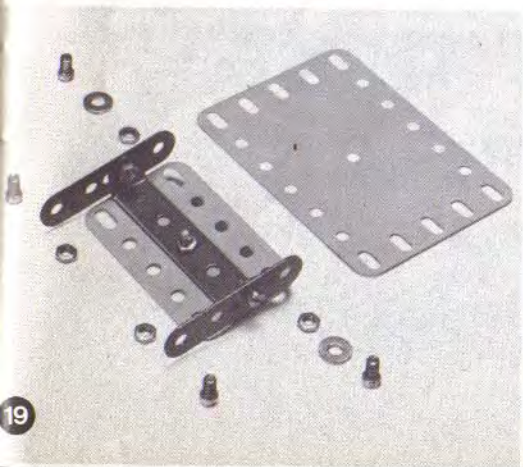
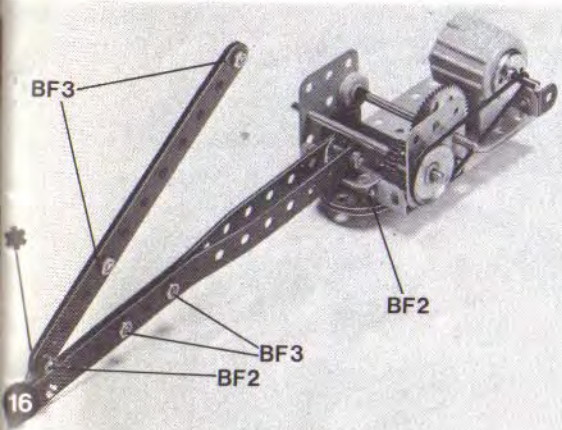
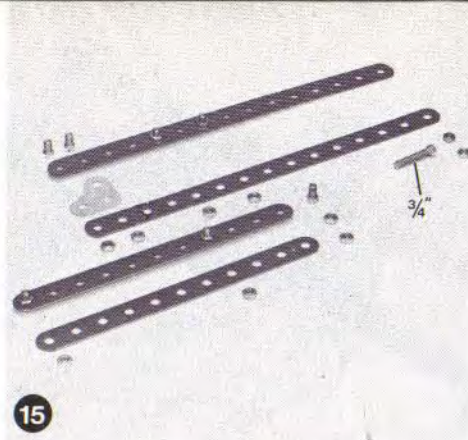
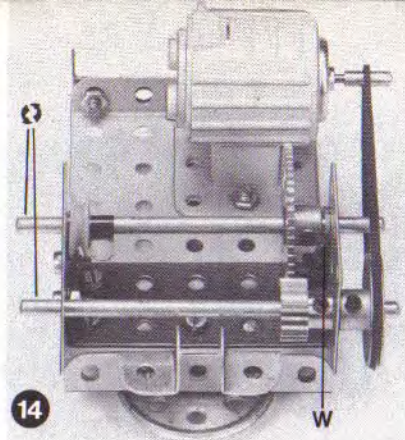
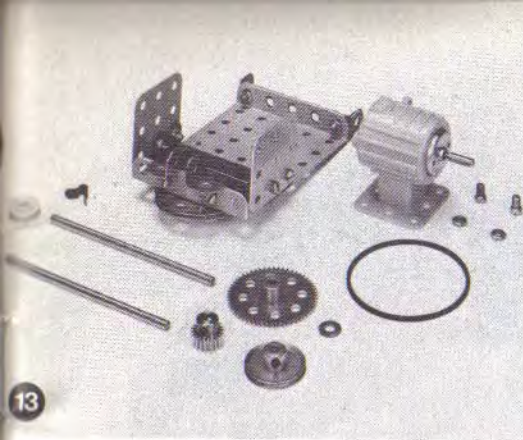

**Mobile Crane**  
 Grue mobile  
 verplaatsbare kraan  
 Kran-LKW  
 Mobil Heisekran  
 Grúa movil  
 Gru mobile

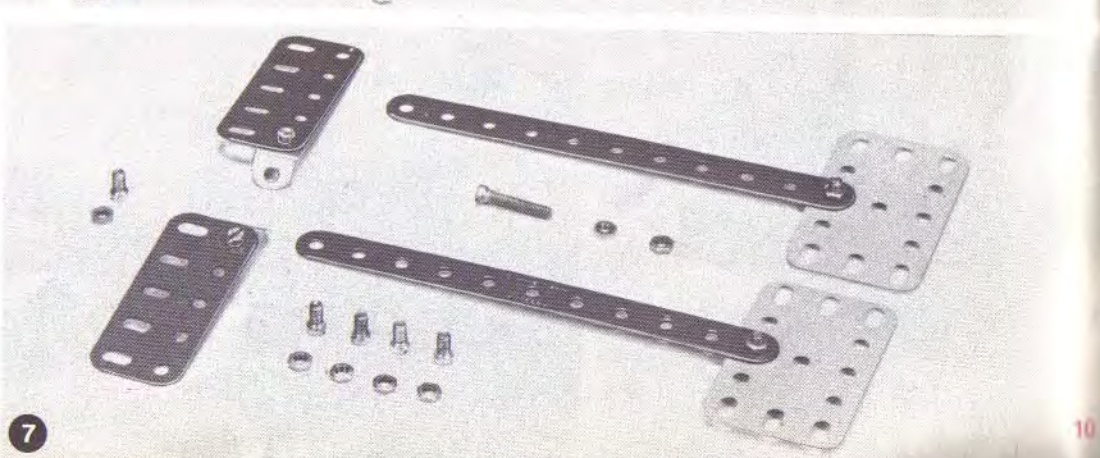
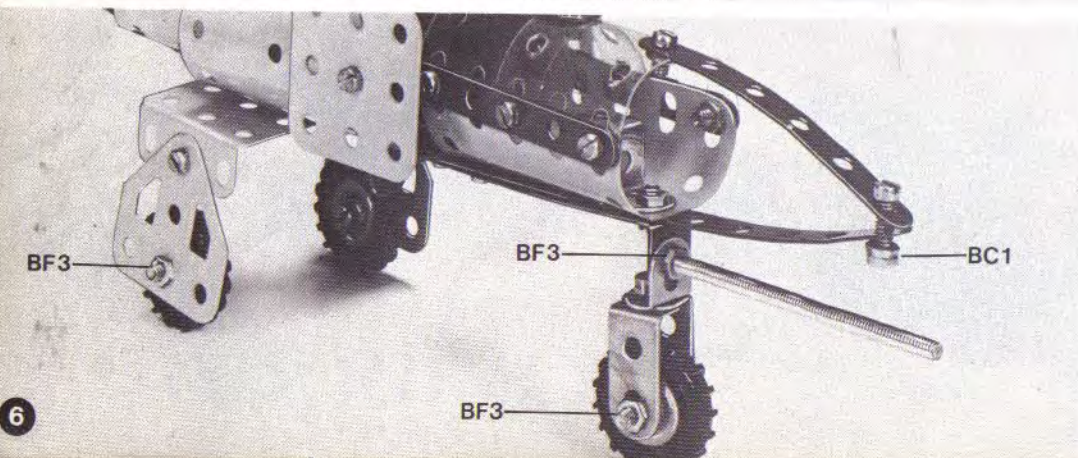
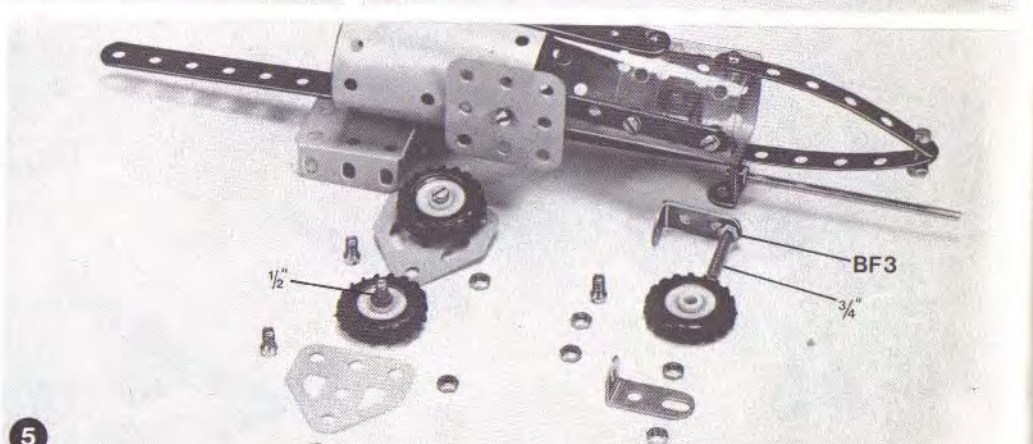
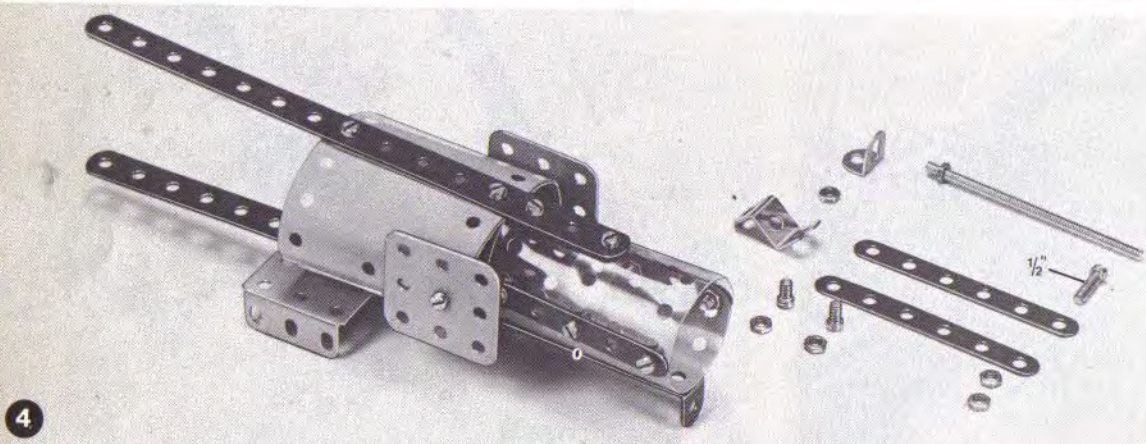
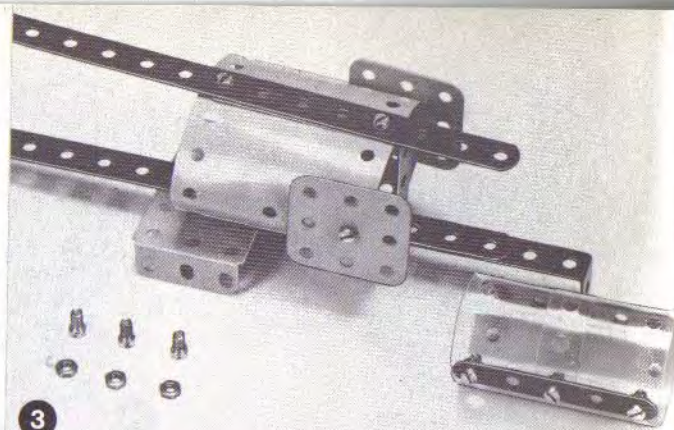
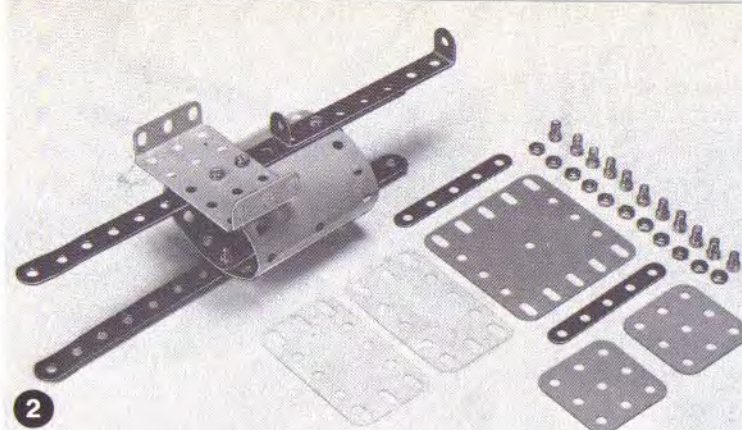
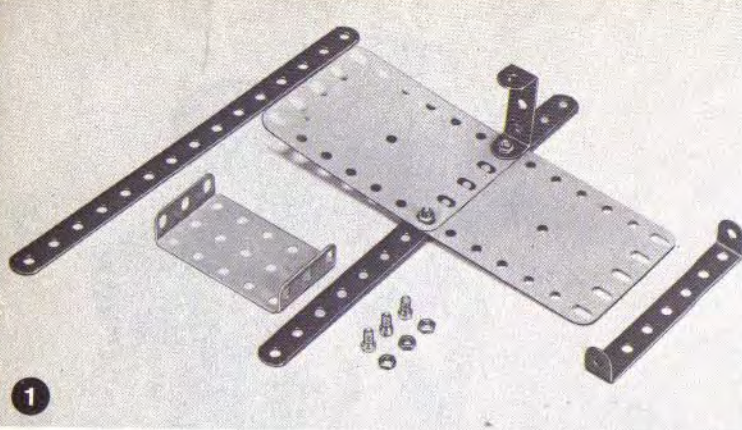

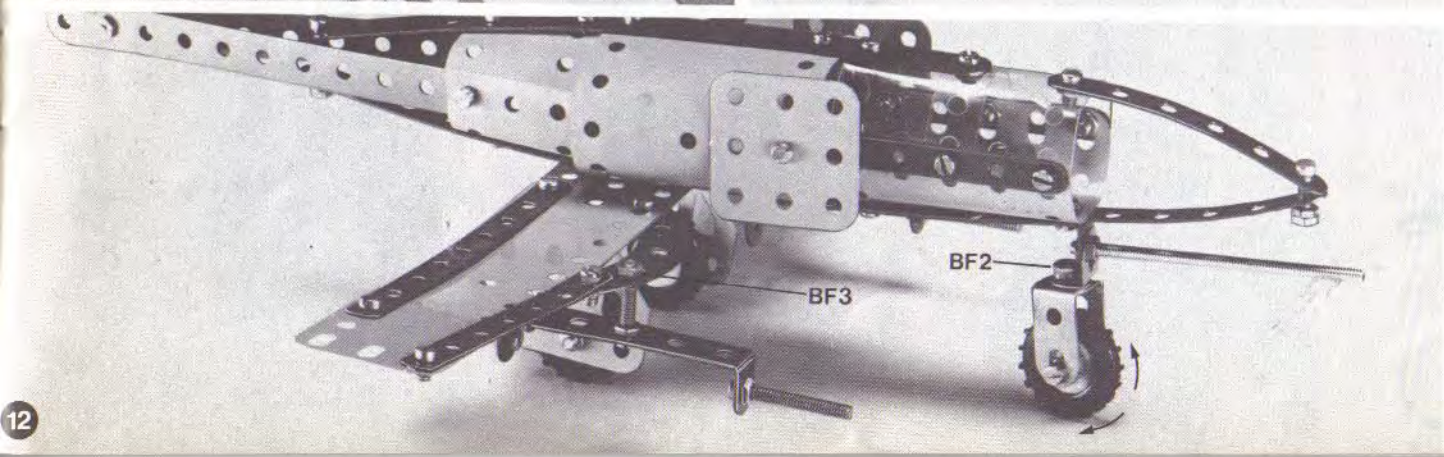
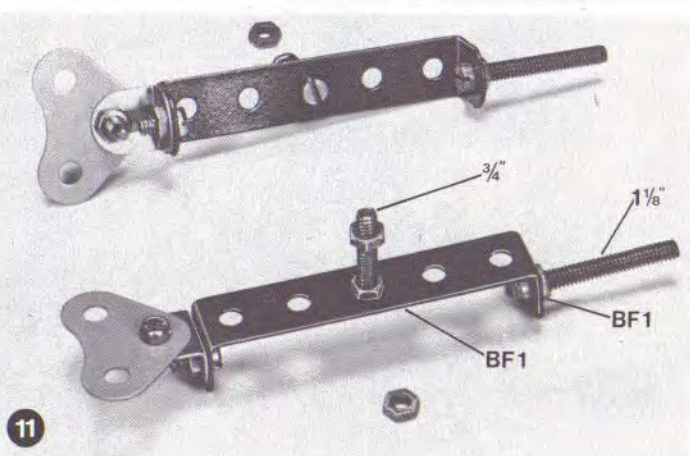
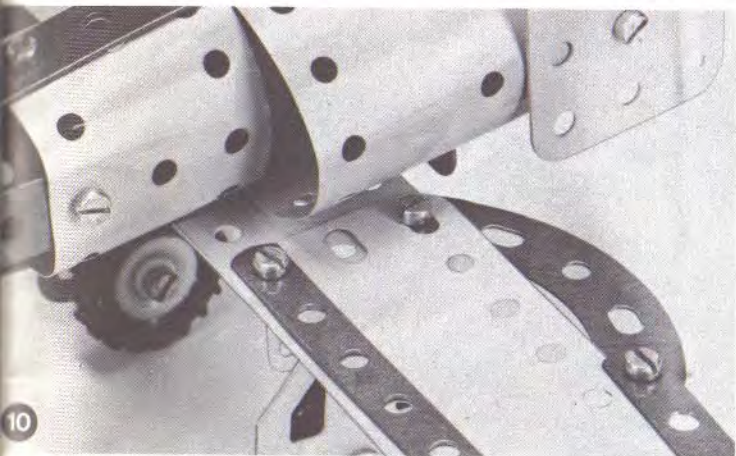
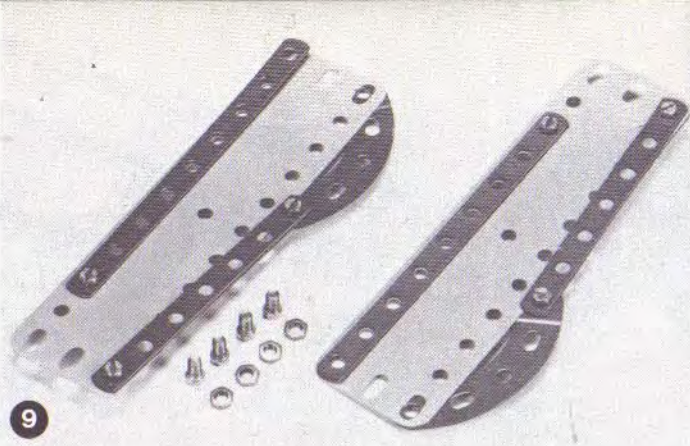
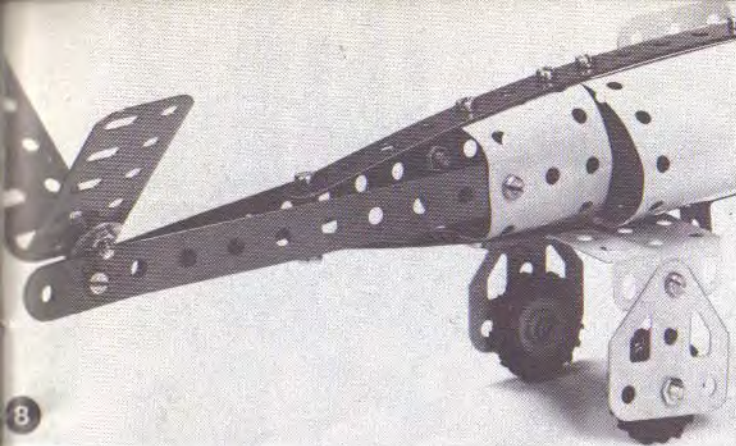

**Jet Fighter**

Avion à réaction

straaljager

Düsenjäger

Jetfly

Avion a Chorro de Guerra

Aereo a reazione da combattimento

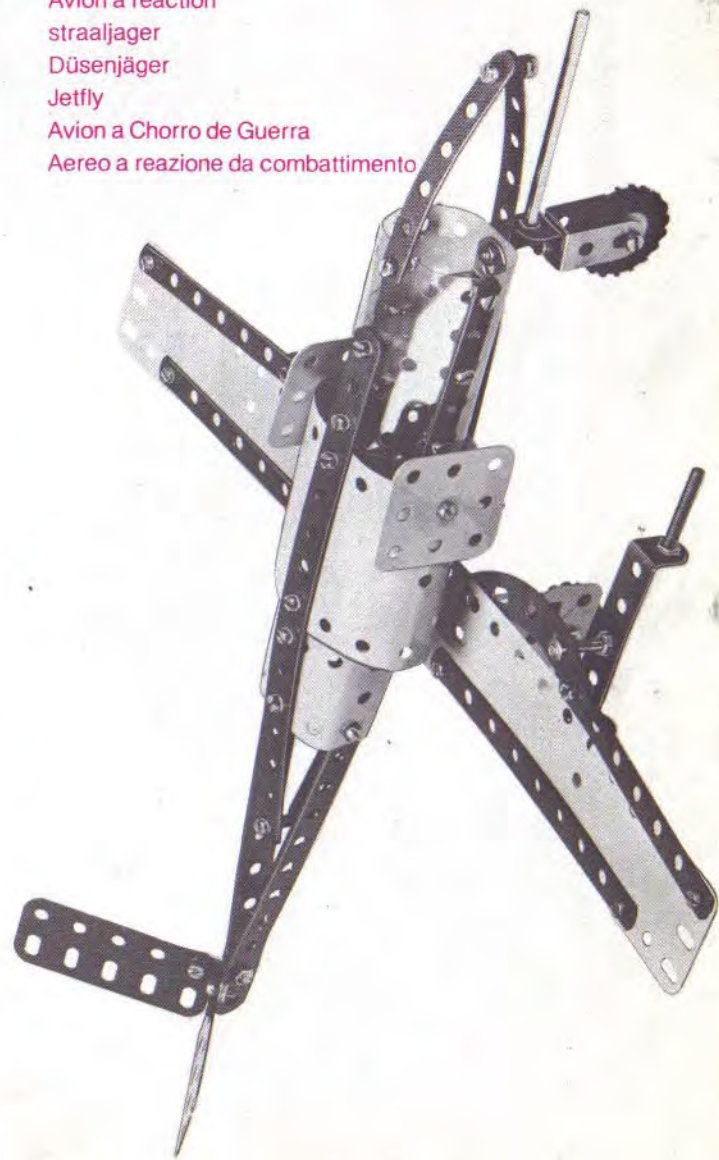

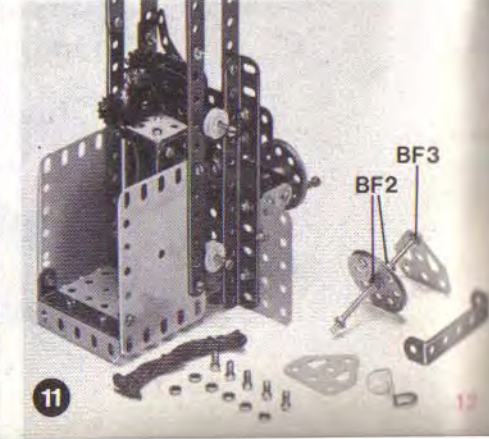
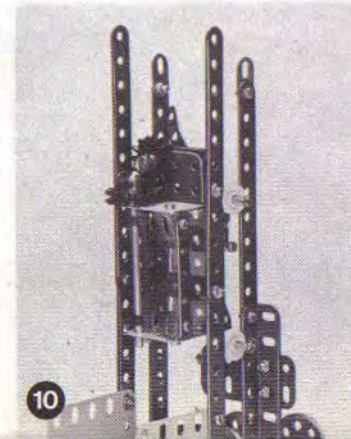
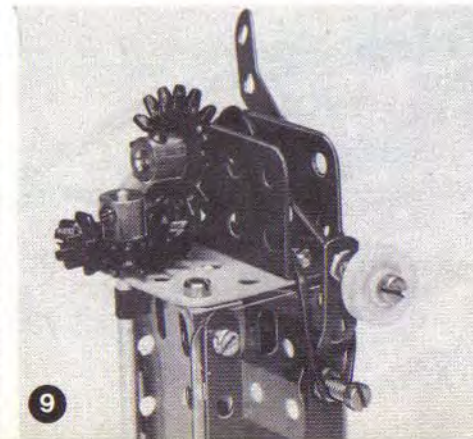
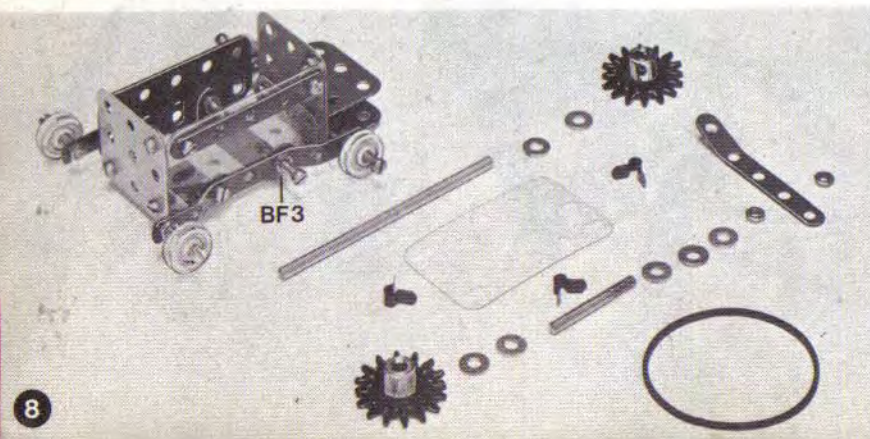
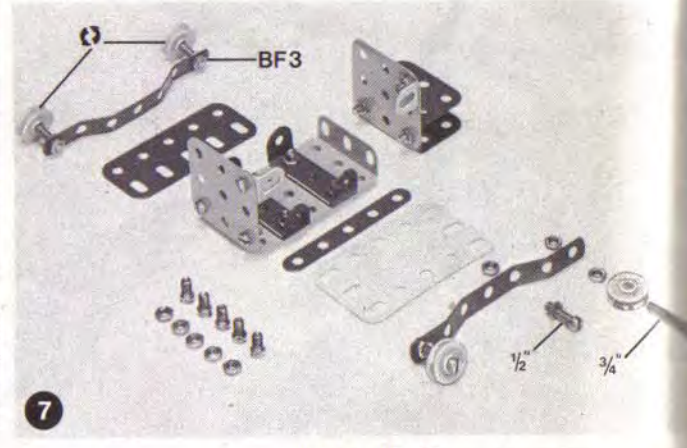
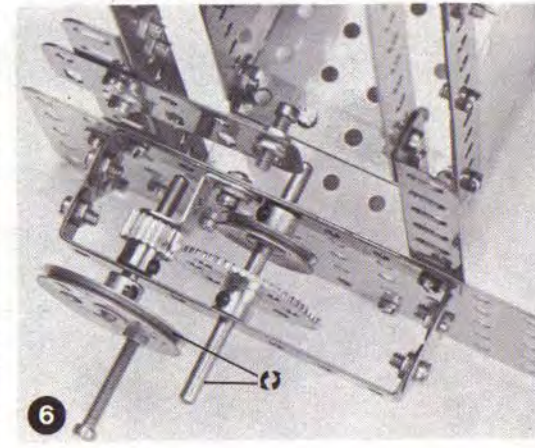
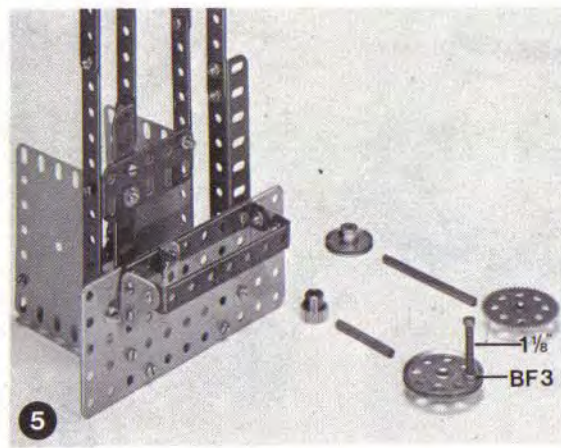
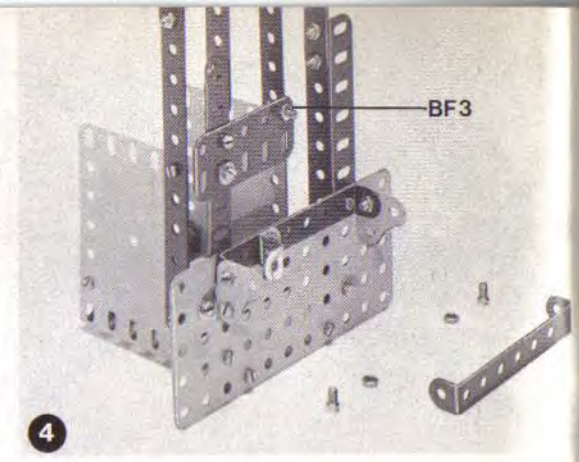
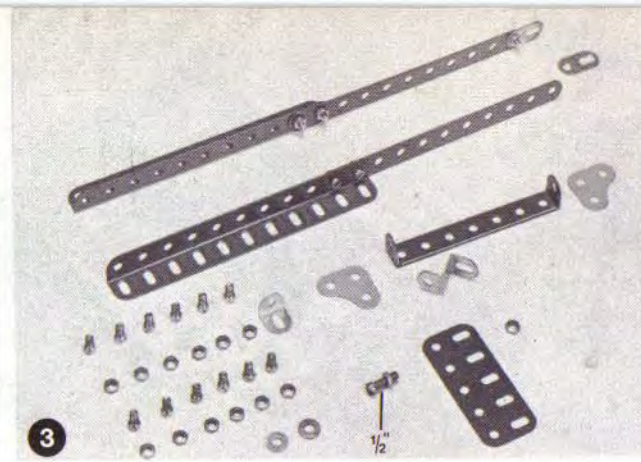
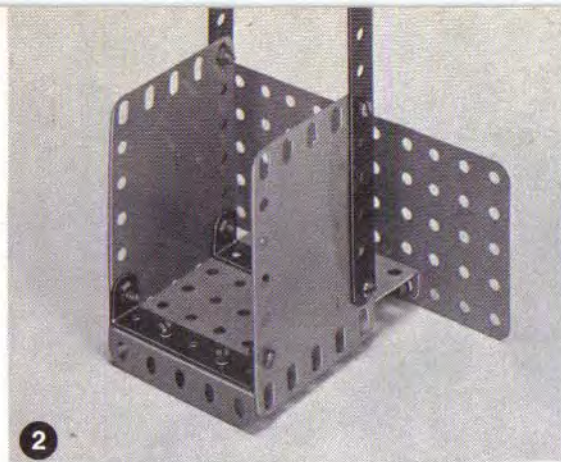
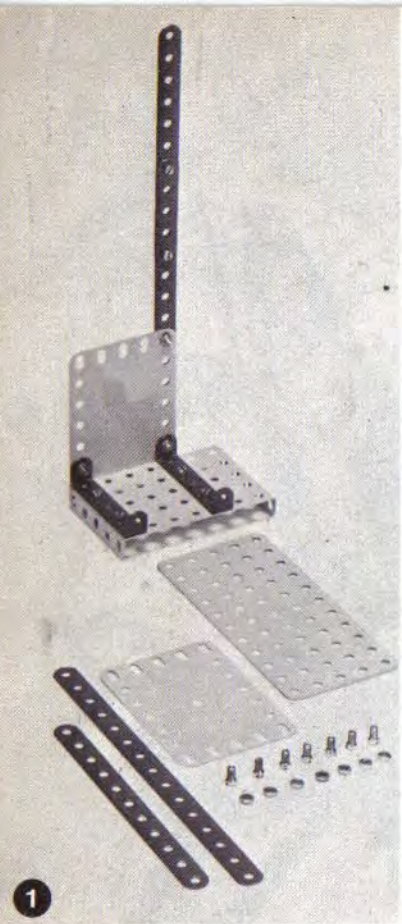

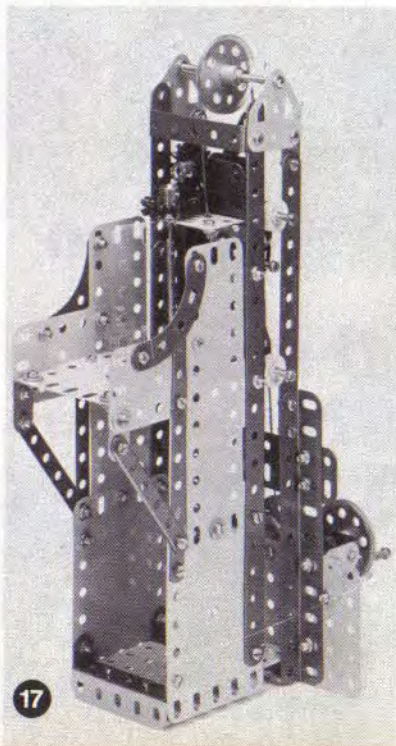
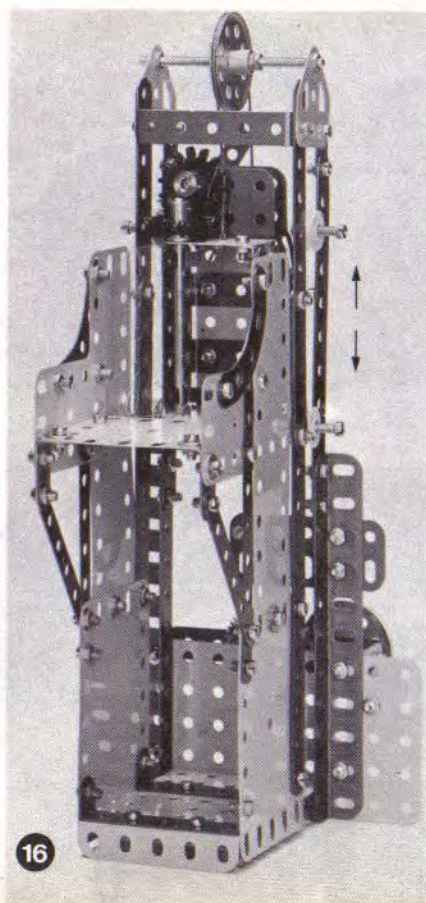
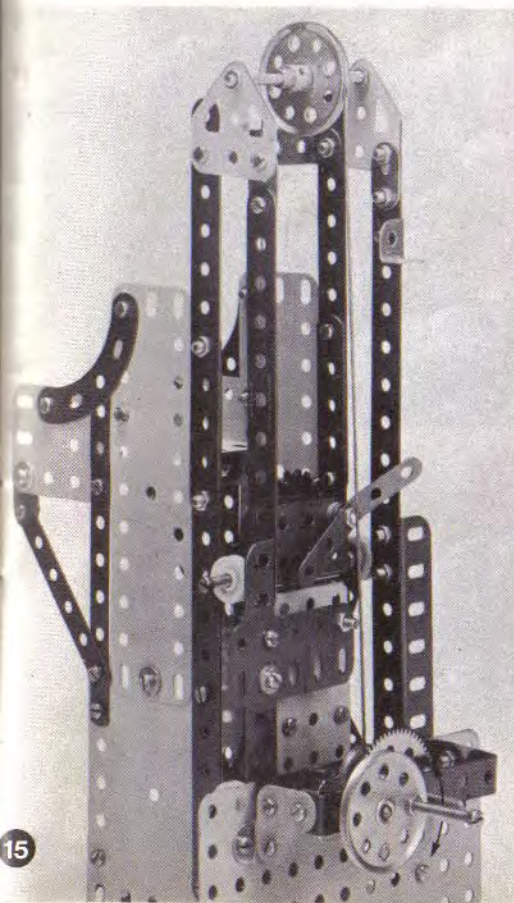
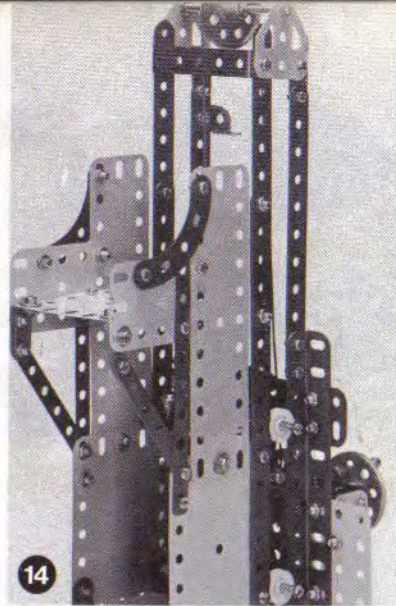
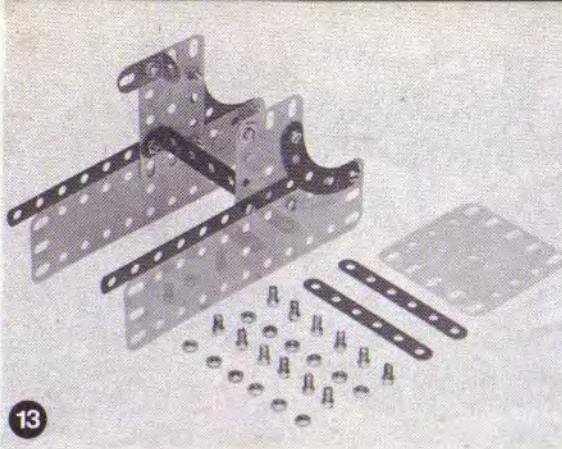
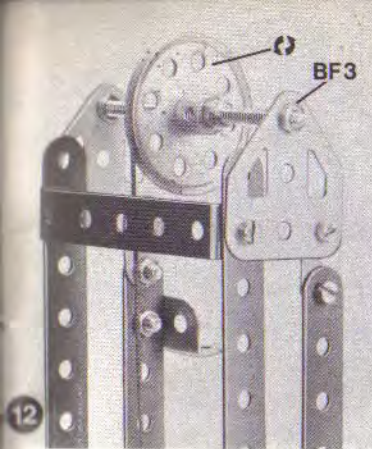

**Elevator**  
 Ascenseur  
 lift  
 Sauger  
 Heis  
 Noria (elevador) (ascensor)  
 Elevatore

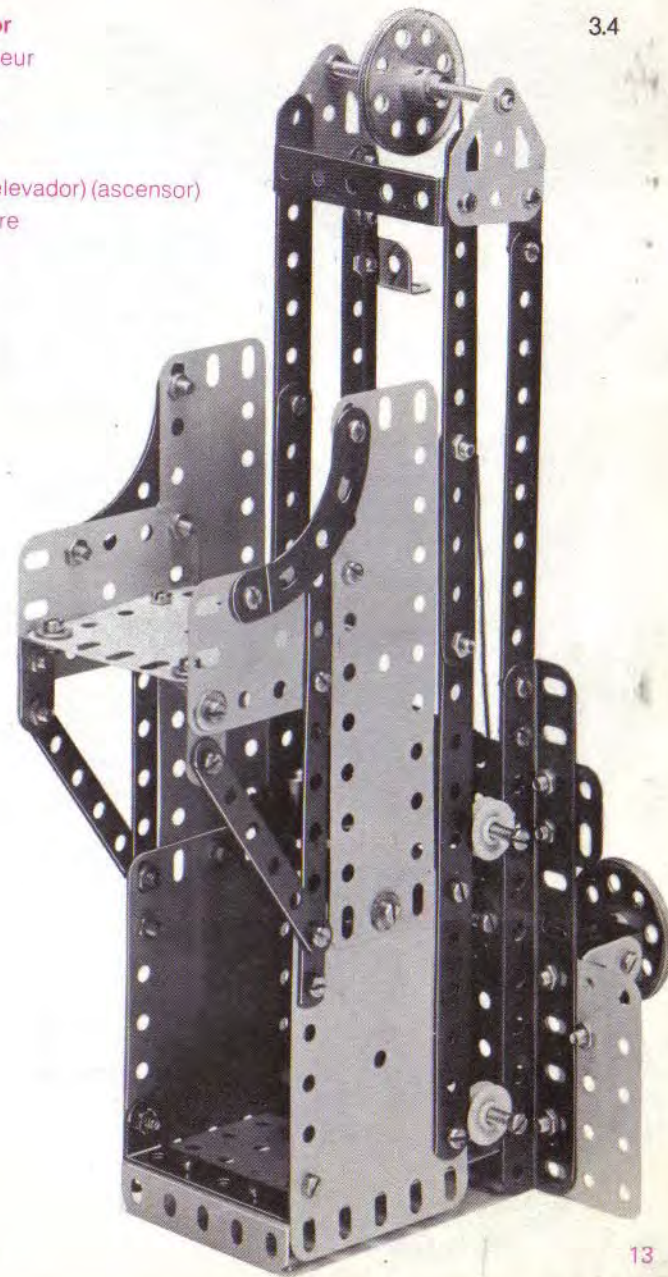

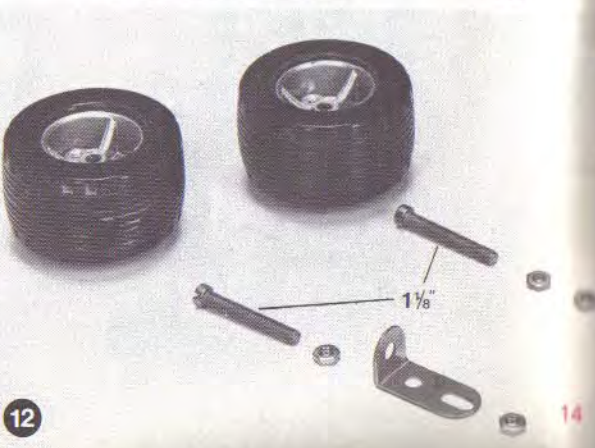
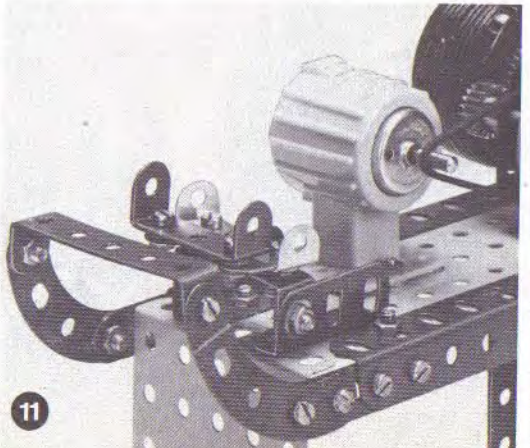
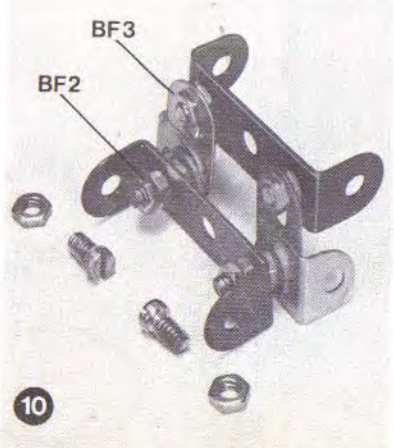
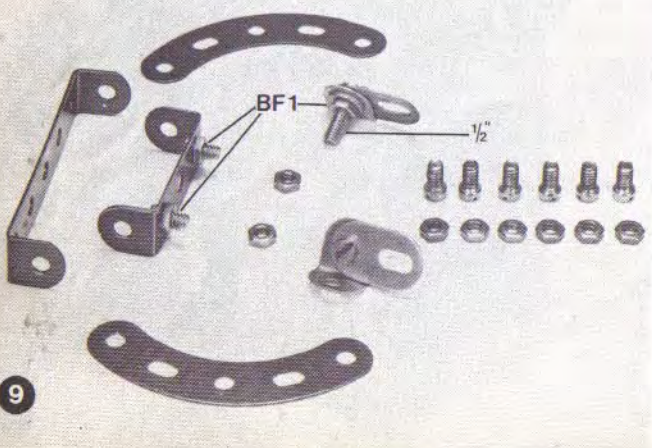
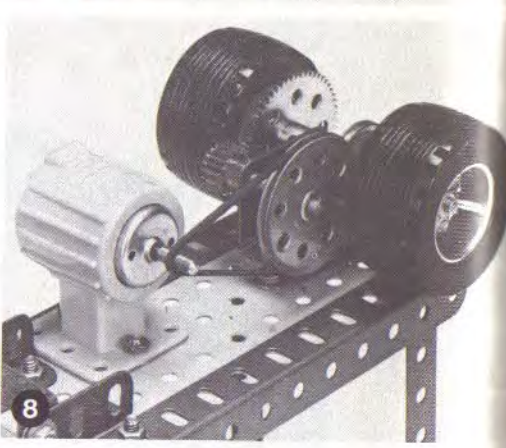
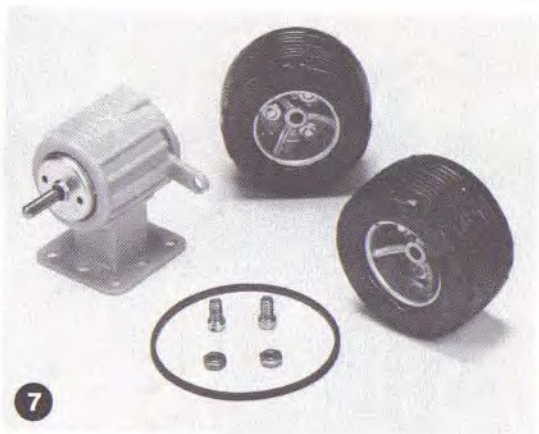
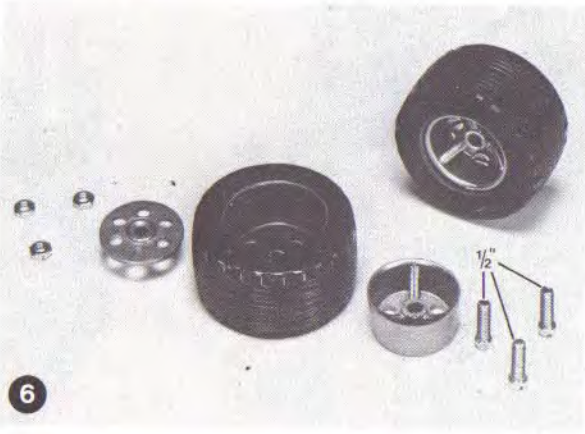
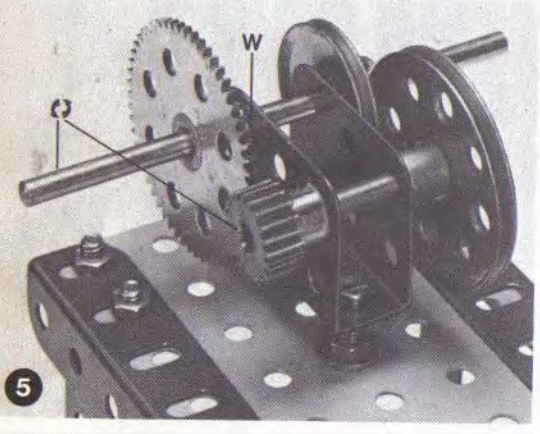
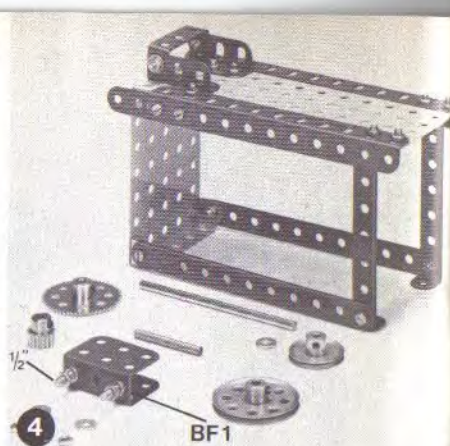
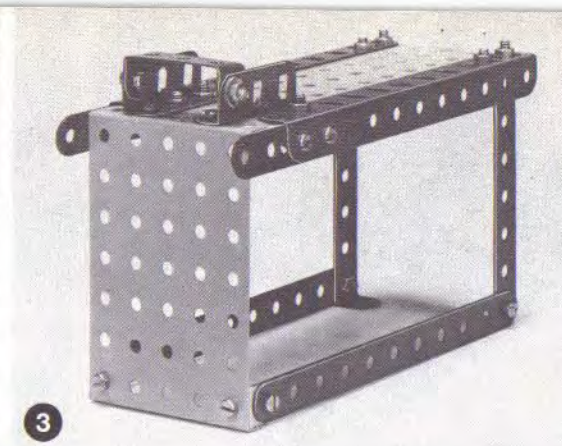
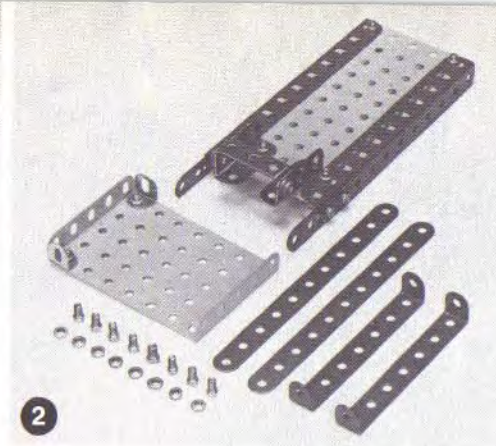
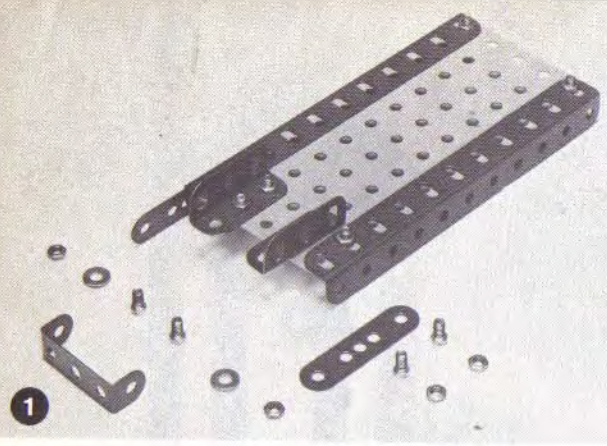

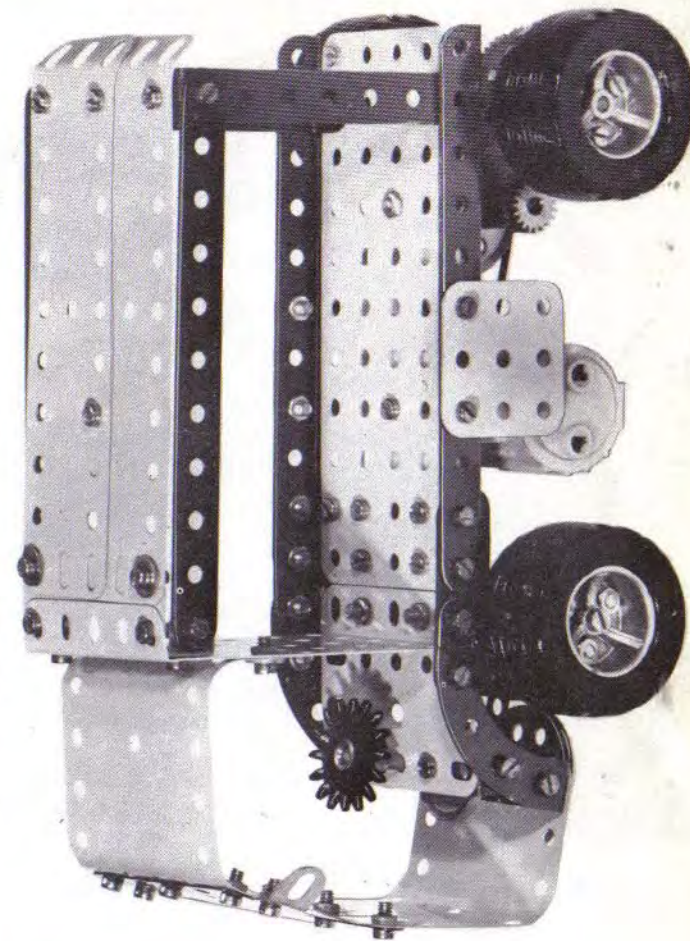
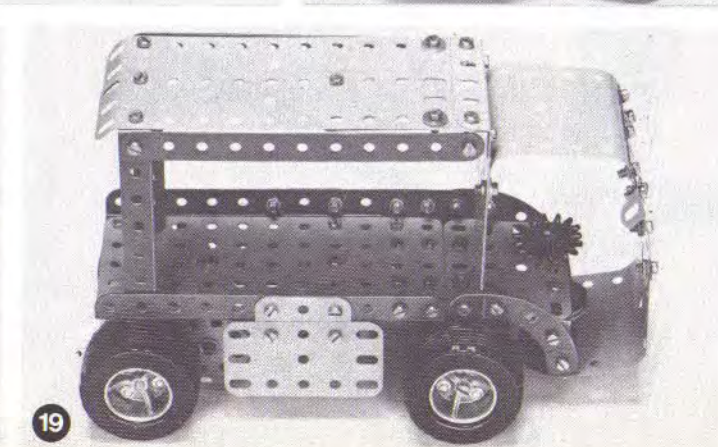
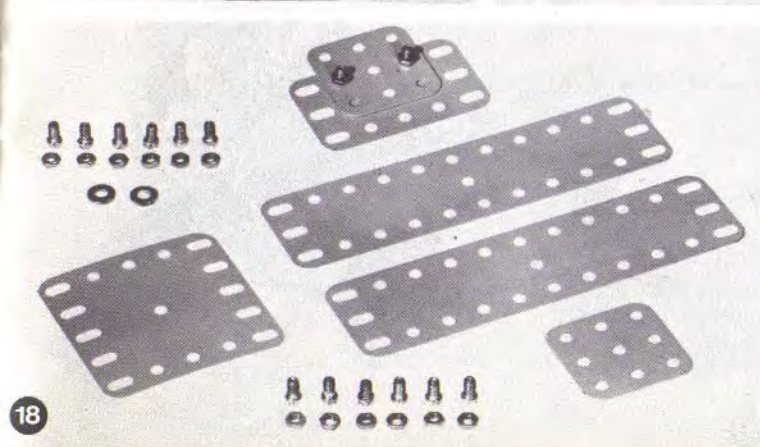
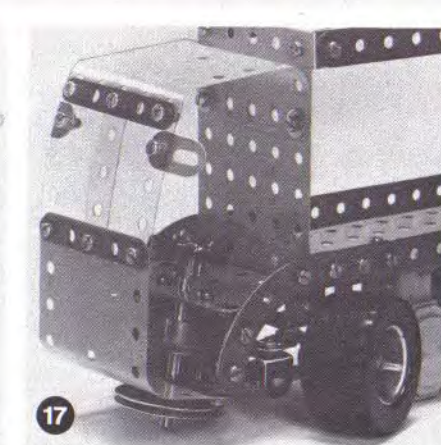
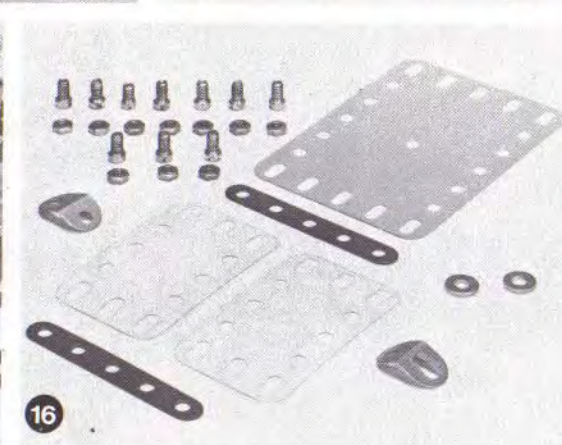
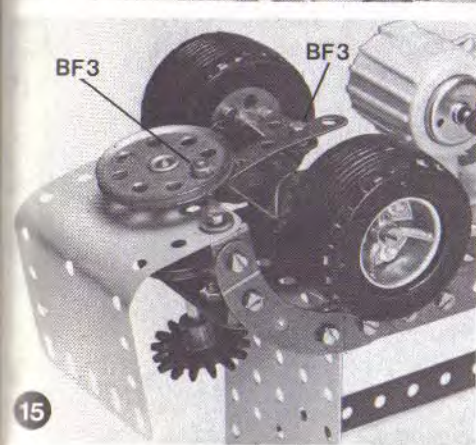
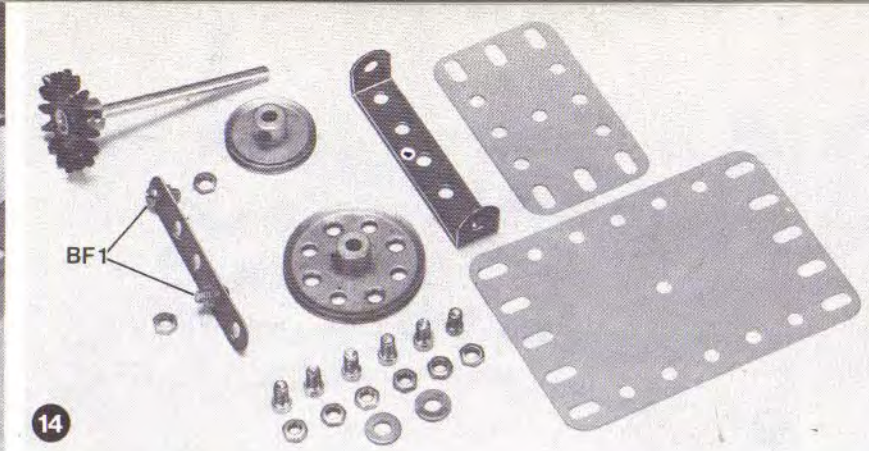
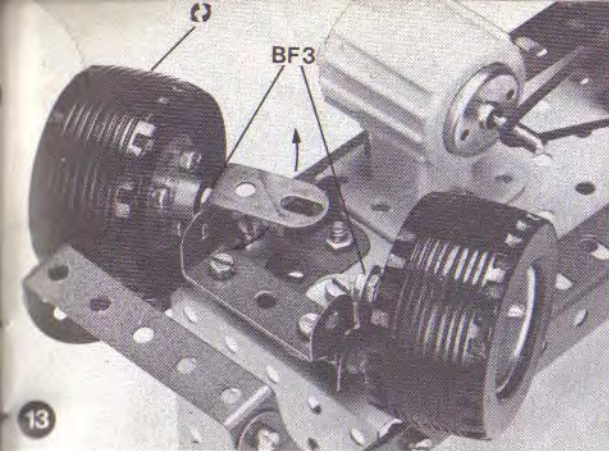

**Electric Truck**

Camion électrique  
 elektrische vrachtwagen  
 LKW mit Elektro-Motor  
 Elektrisk Truck  
 Camión eléctrico  
 Autocarro elettrico

**1**

Diagram 1 shows the initial assembly of the base frame. It consists of two long perforated metal strips connected by two shorter strips at one end. A flat square plate is shown separately, along with a collection of small hardware including screws, nuts, and washers.

**2**

Diagram 2 shows the side rails being attached to the base frame. Two long perforated strips are being positioned to connect the ends of the base frame. A collection of hardware is shown above the strips.

**3**

Diagram 3 shows the base frame being completed. The side rails are now fully attached to the base frame. A collection of hardware is shown above the frame.

**4**

Diagram 4 shows the top rail being attached to the base frame. A long perforated strip is being positioned to connect the ends of the base frame. A collection of hardware is shown above the strip.

**5**

Diagram 5 shows the support brackets being attached to the base frame. Two L-shaped brackets are being positioned to support the top rail. A collection of hardware is shown above the brackets.

**6**

Diagram 6 shows the gears being attached to the base frame. Two gears are being positioned to mesh with each other. A collection of hardware is shown above the gears.

**7**

Diagram 7 shows the final assembly of the base frame. The gears are now fully attached to the base frame. A collection of hardware is shown above the frame.

**8**

Diagram 8 shows the top rail being attached to the base frame. A long perforated strip is being positioned to connect the ends of the base frame. A collection of hardware is shown above the strip.

**9**

Diagram 9 shows the side rails being attached to the base frame. Two long perforated strips are being positioned to connect the ends of the base frame. A collection of hardware is shown above the strips.

**10**

Diagram 10 shows the final assembly of the base frame. The side rails are now fully attached to the base frame. A collection of hardware is shown above the frame.

16

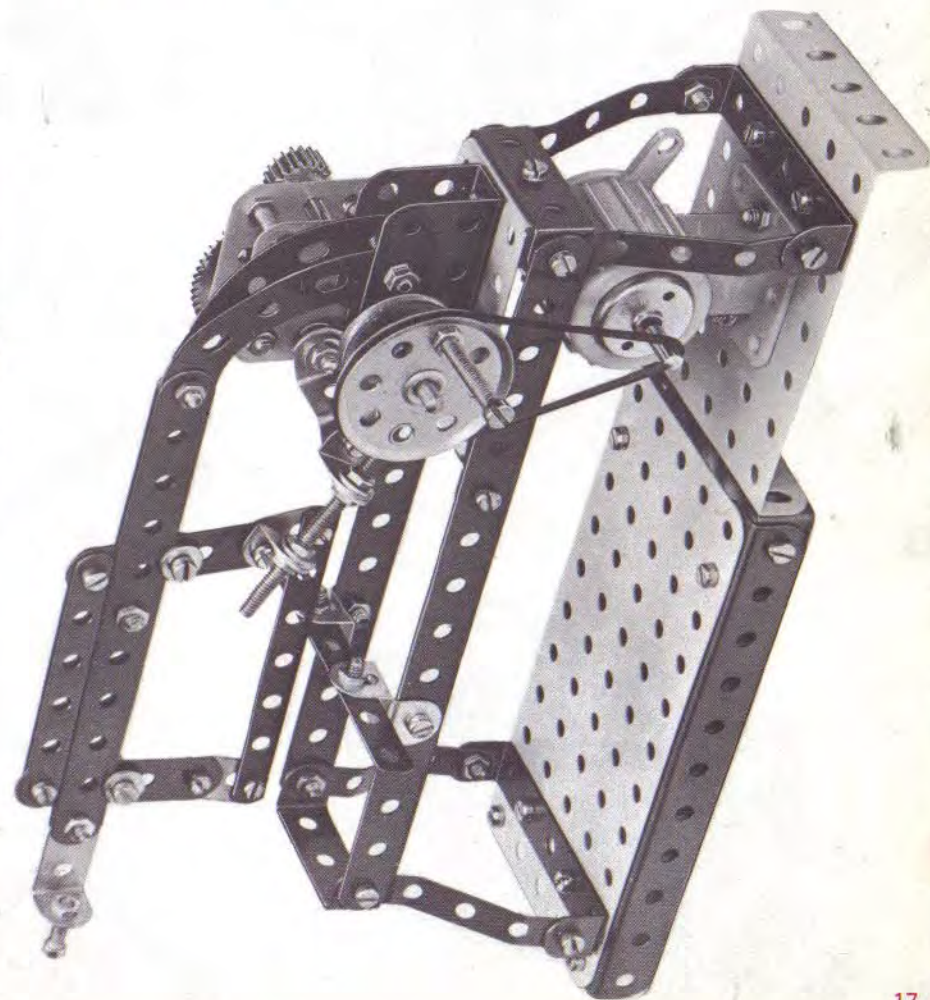
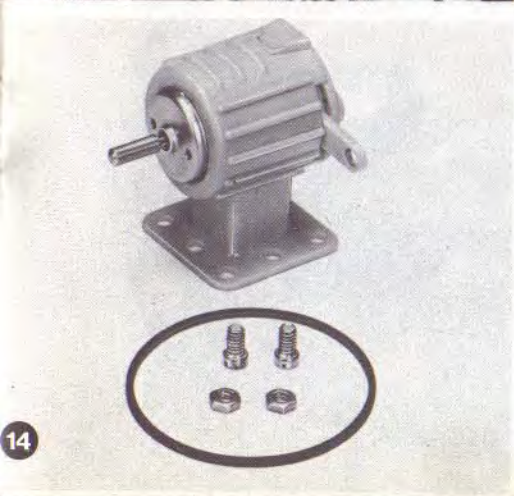
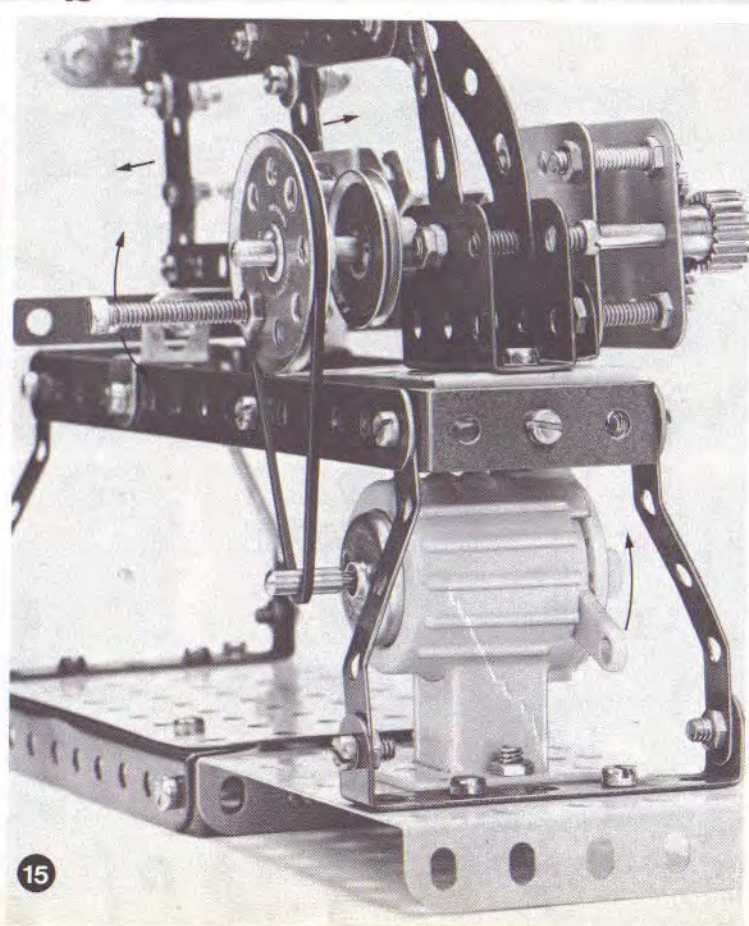
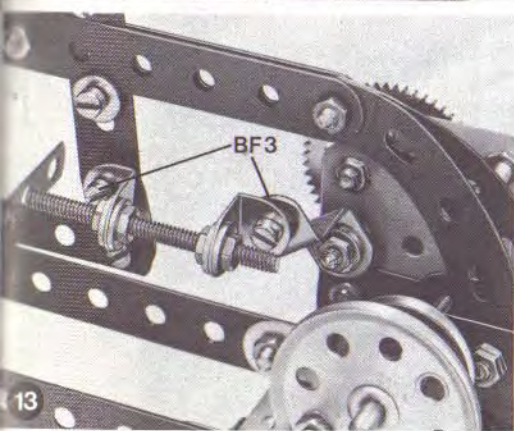
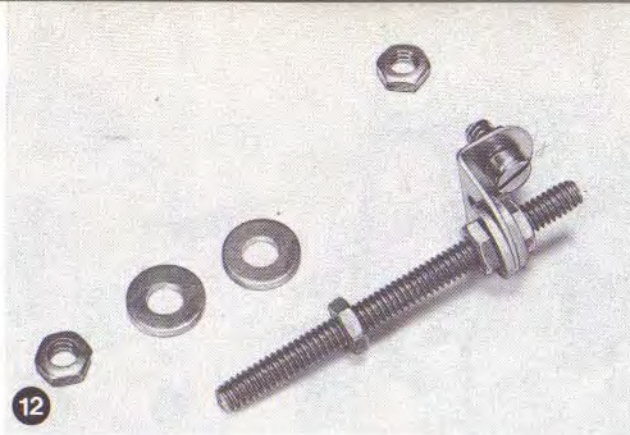
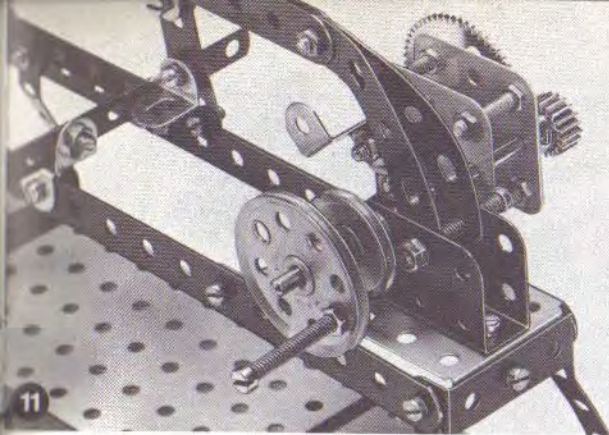

**Power Saw**

Scie mecanique

kracht zaag

Sägegatter

Sag

Serrucho con Motor

Sega a motore

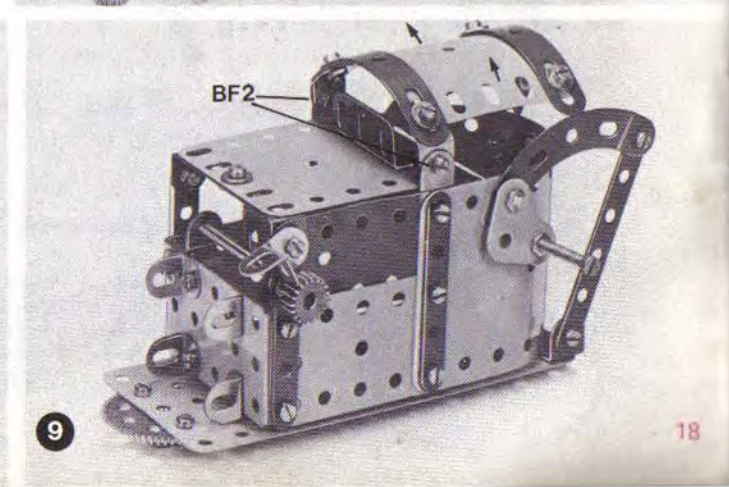
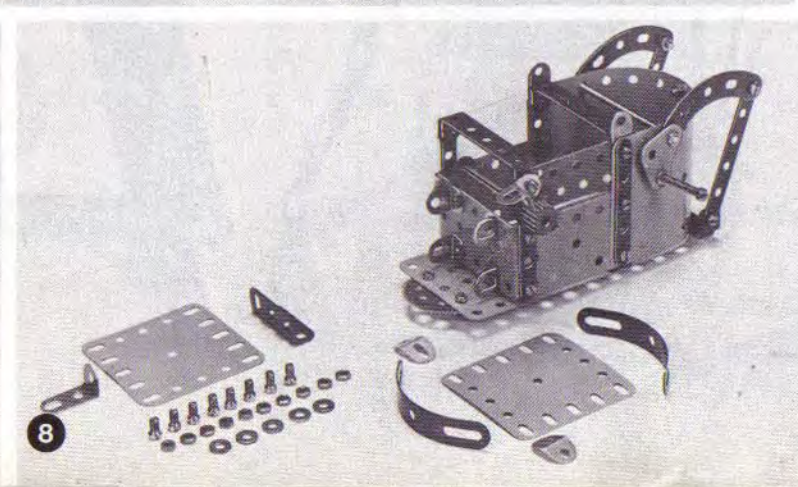
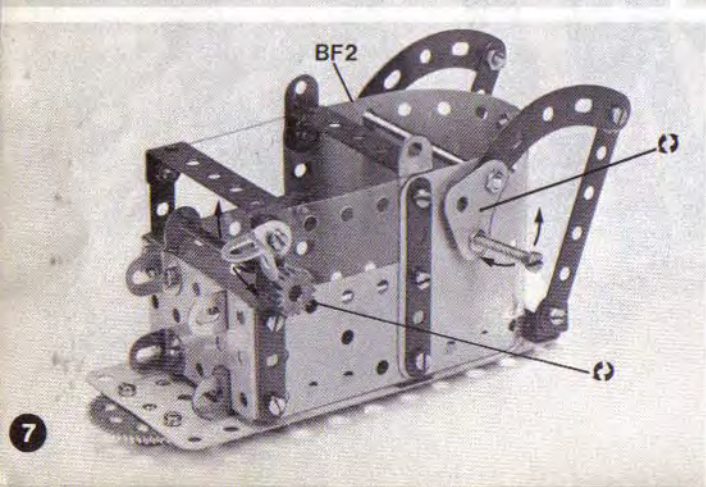
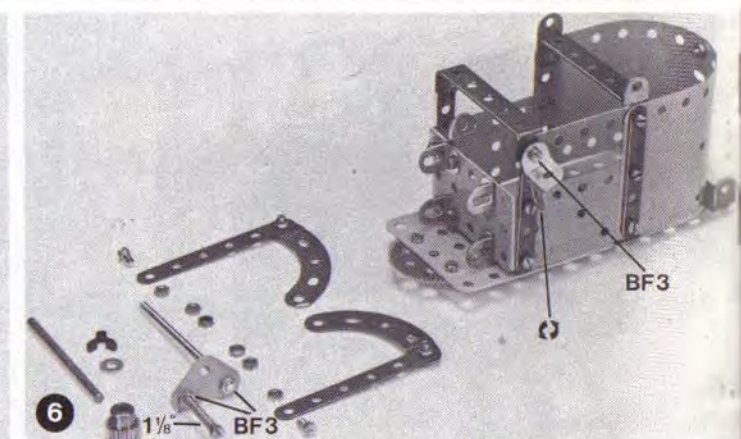
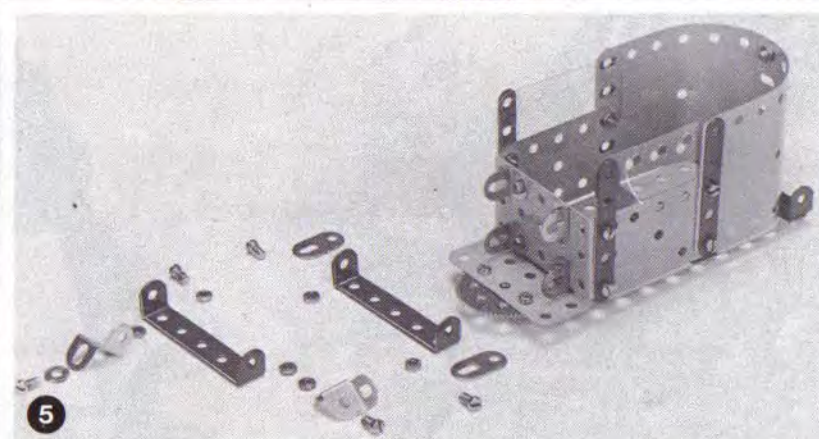
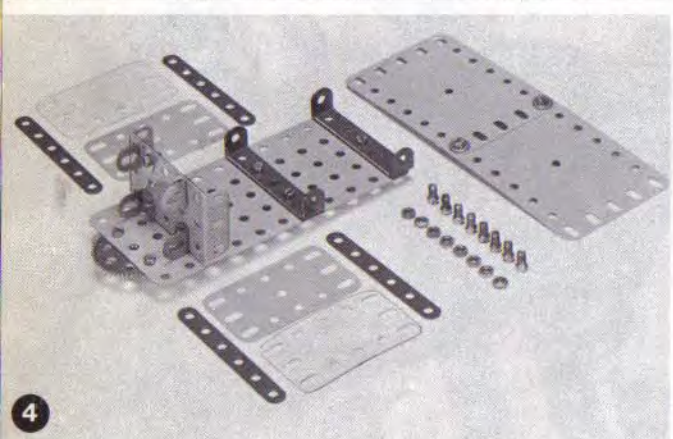
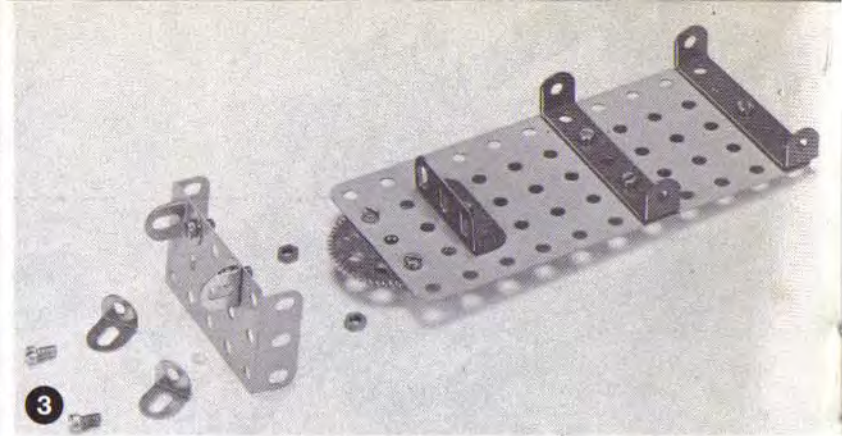
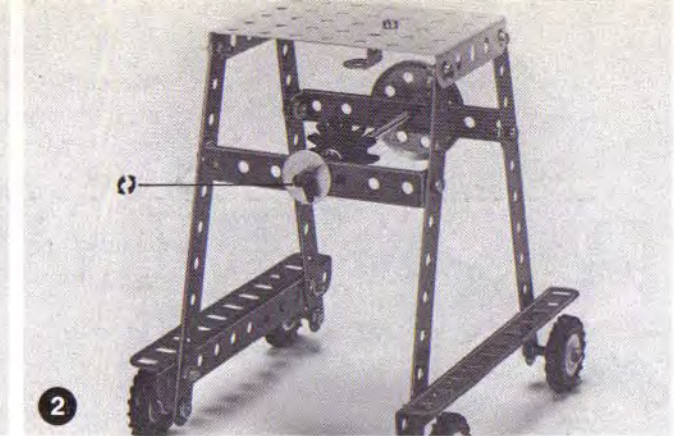
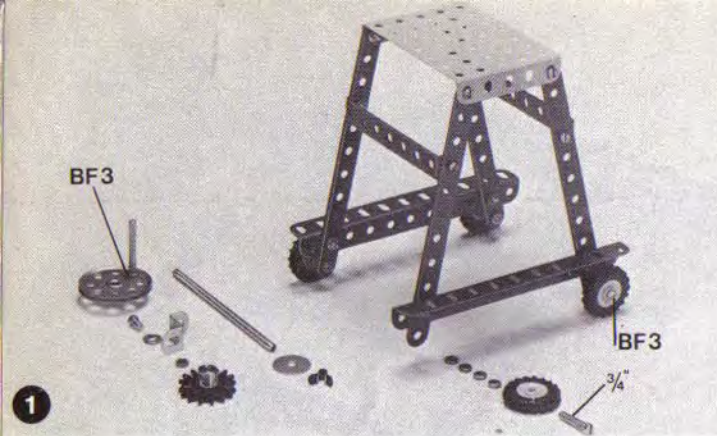

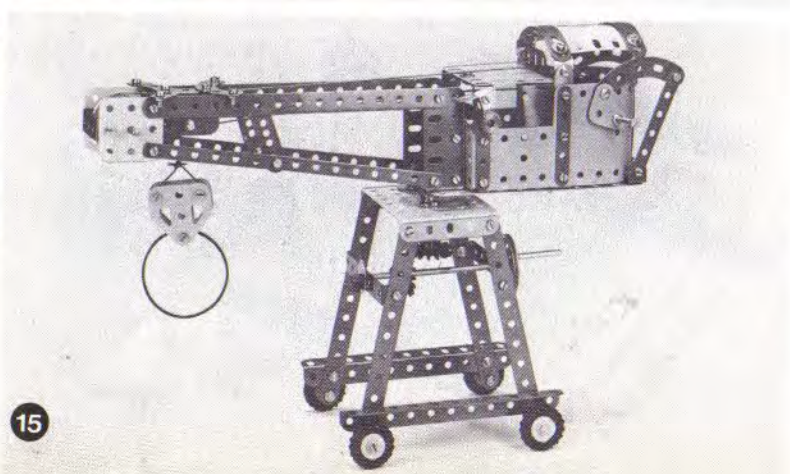
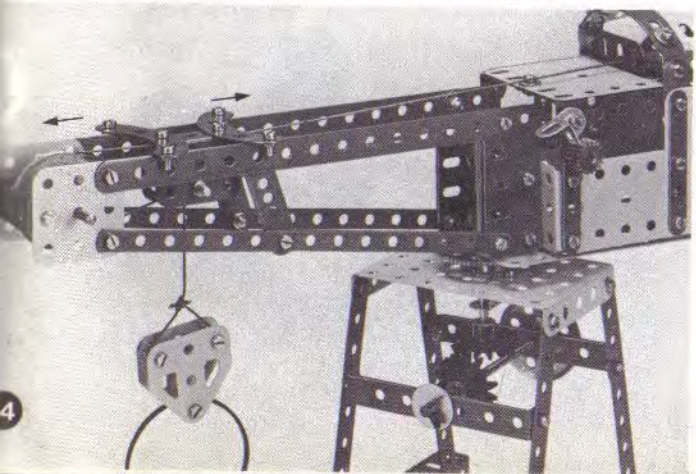
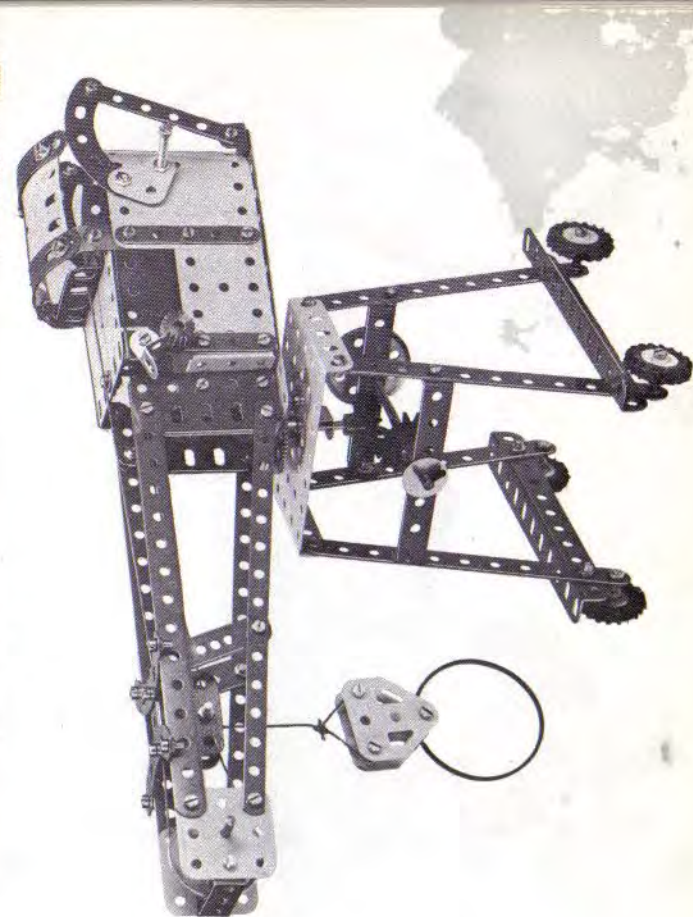
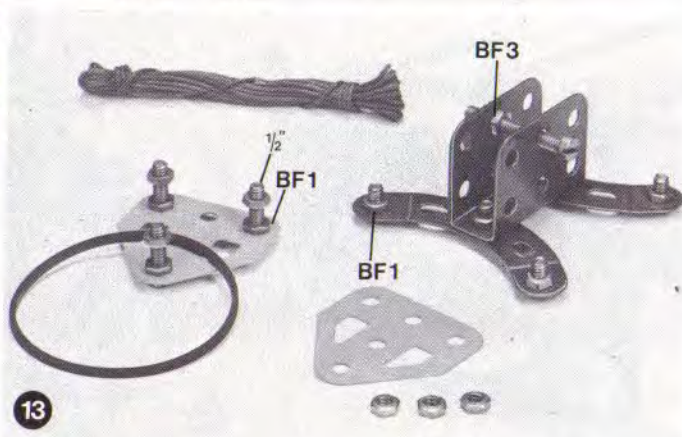
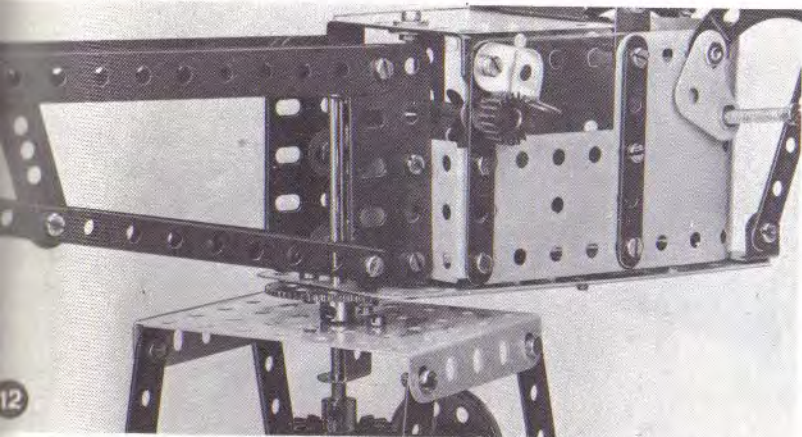
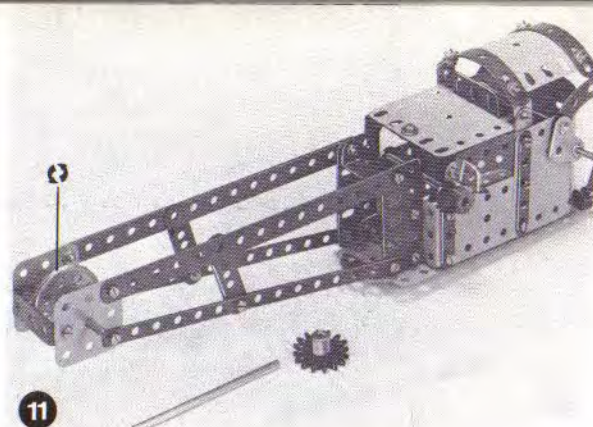
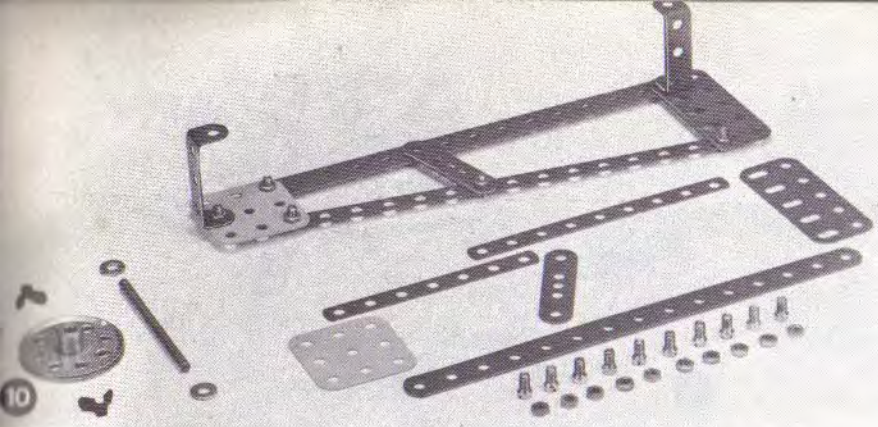

Crane  
 Grue  
 kraan  
 Kran  
 Kran  
 Grúa  
 Gru

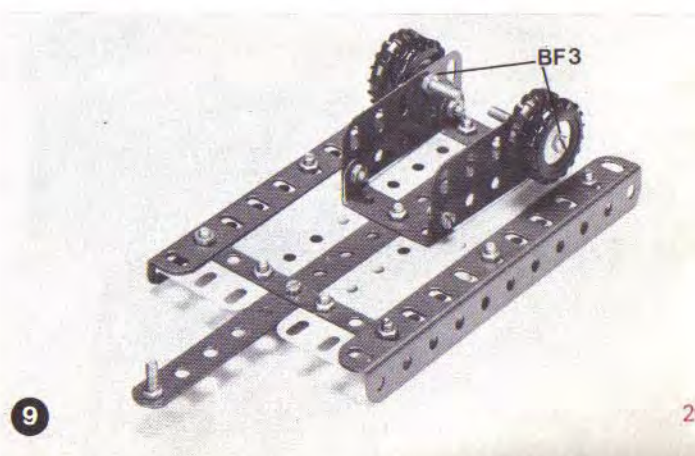
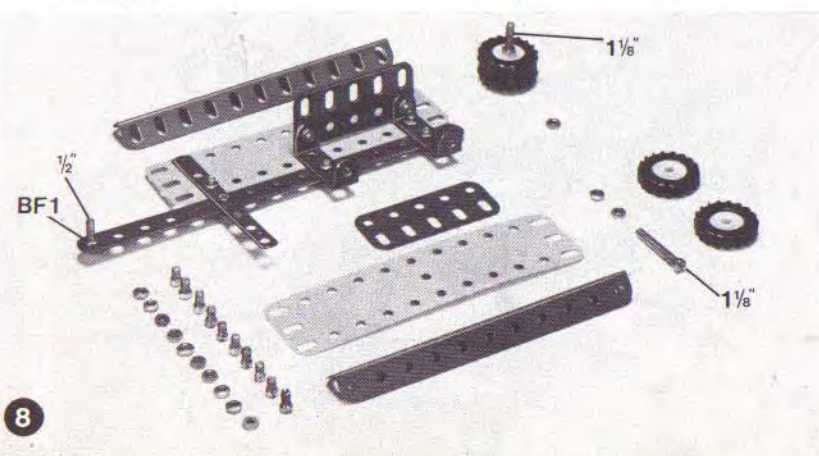
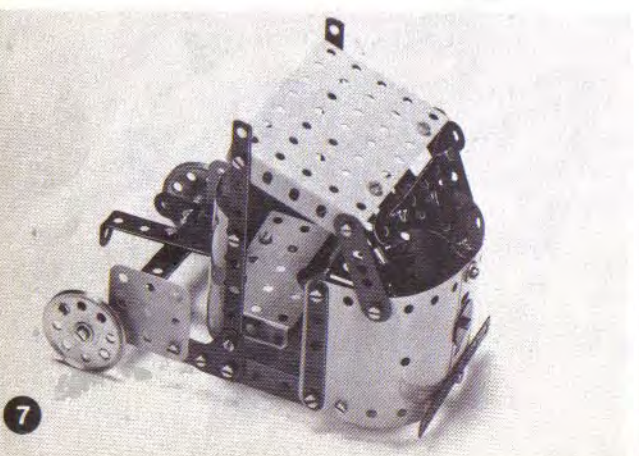
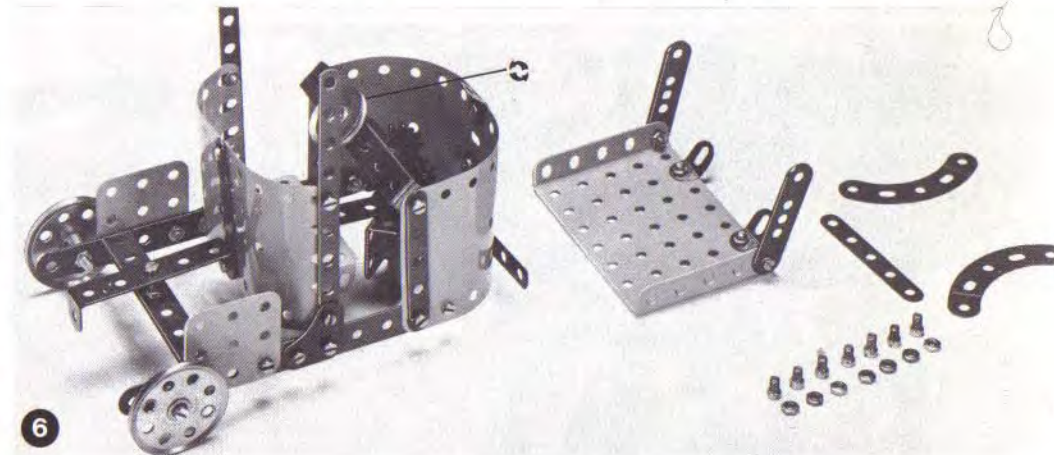
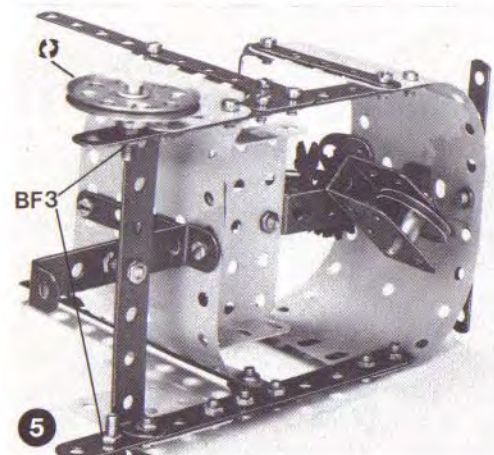
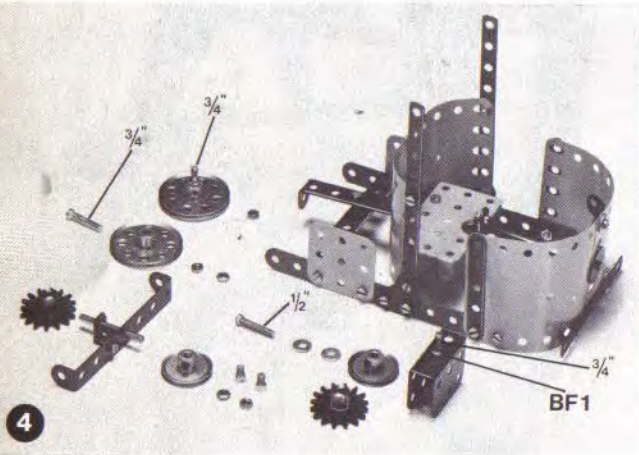
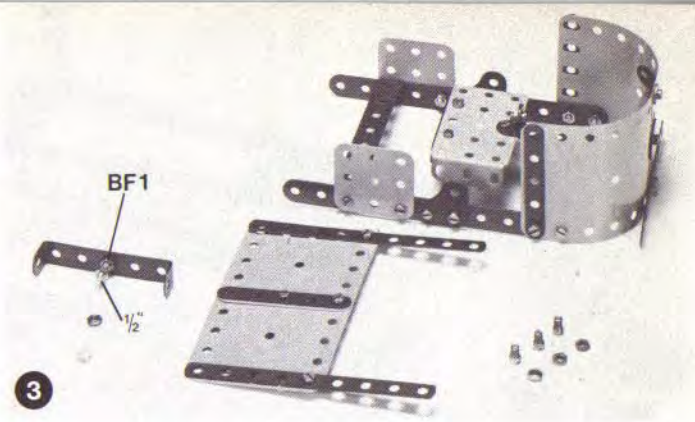
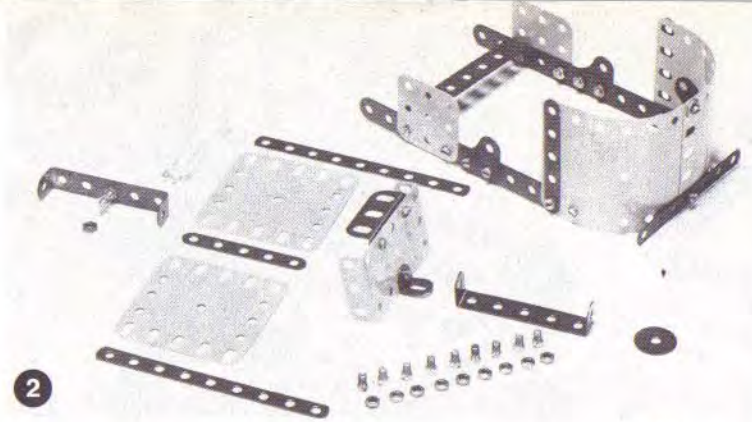
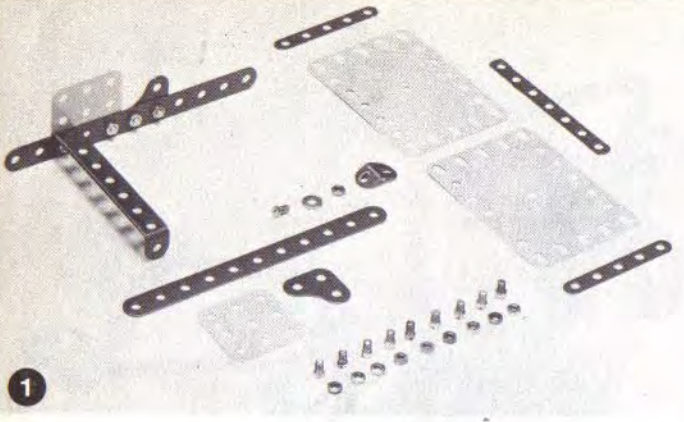

## Truck and Trailer

Camion et remorque

vrachtwagen met aanhangwen

LKW mit Anhänger

Truck og trailer

Camion y Trailer

Autocarro con rimorchio

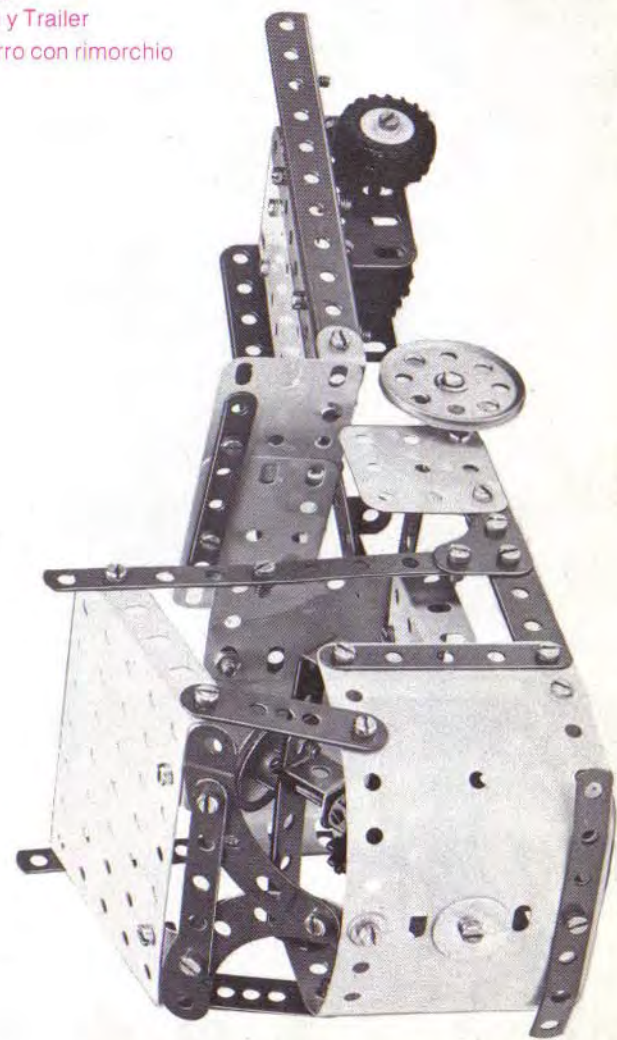
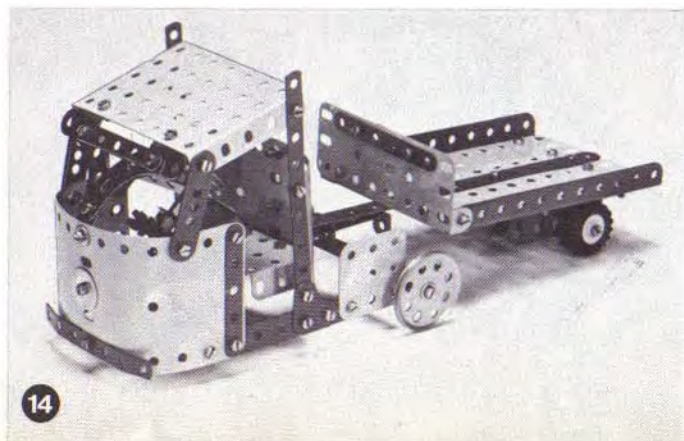
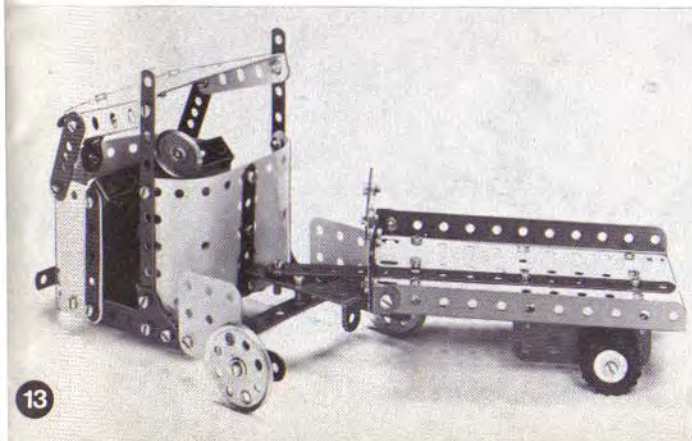
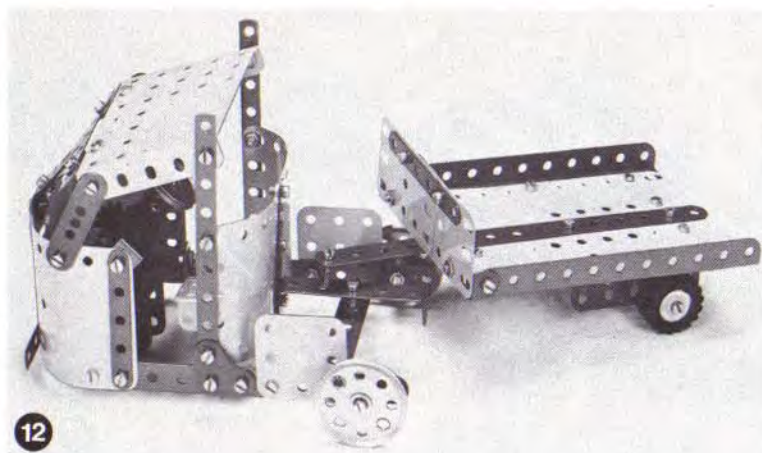
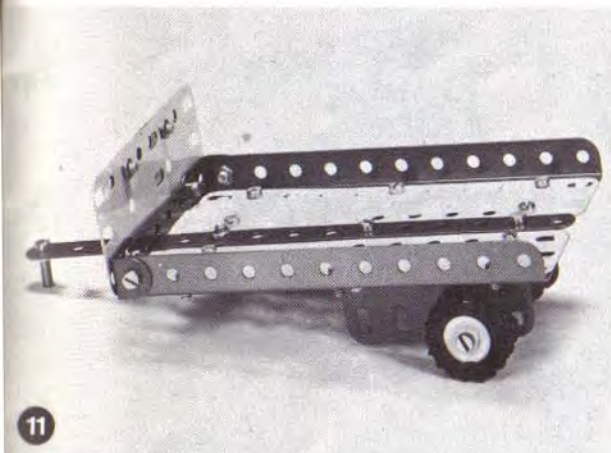
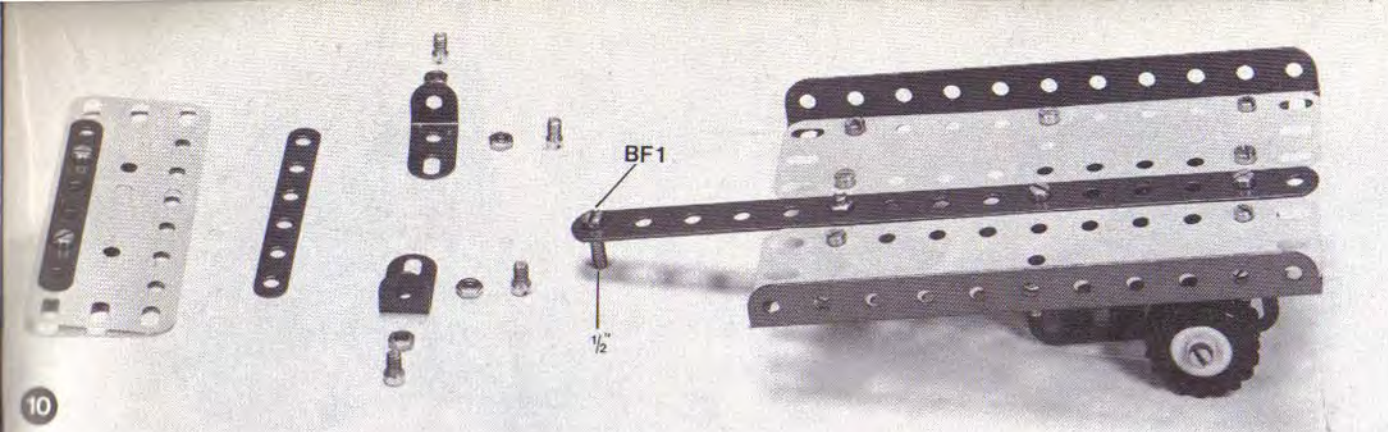

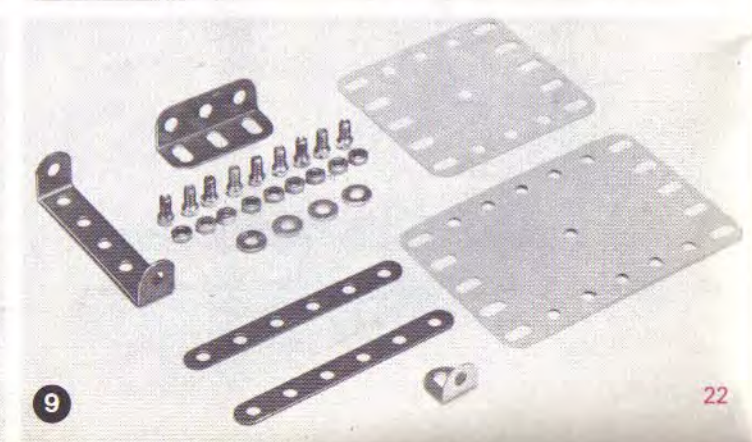
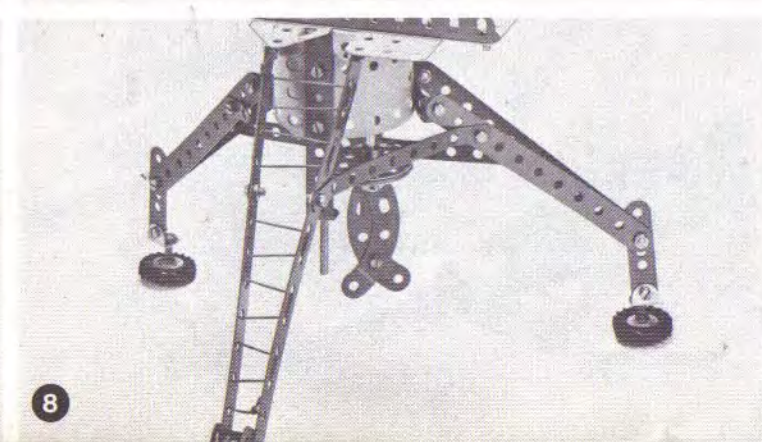
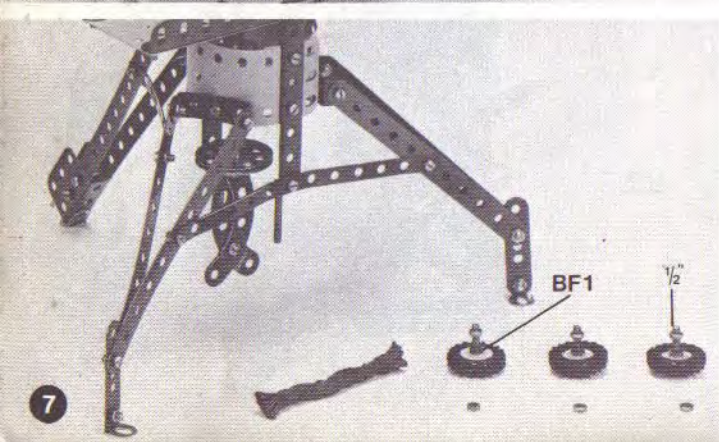
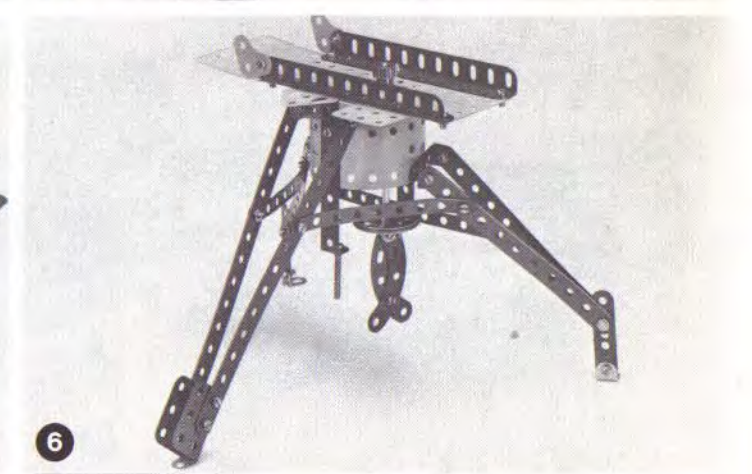
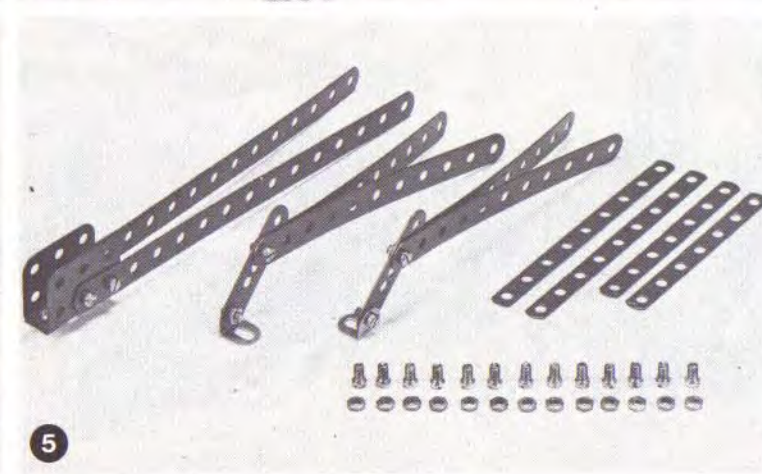
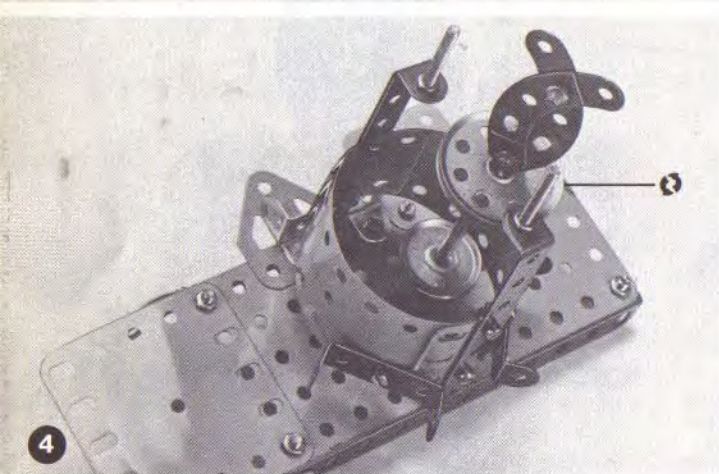
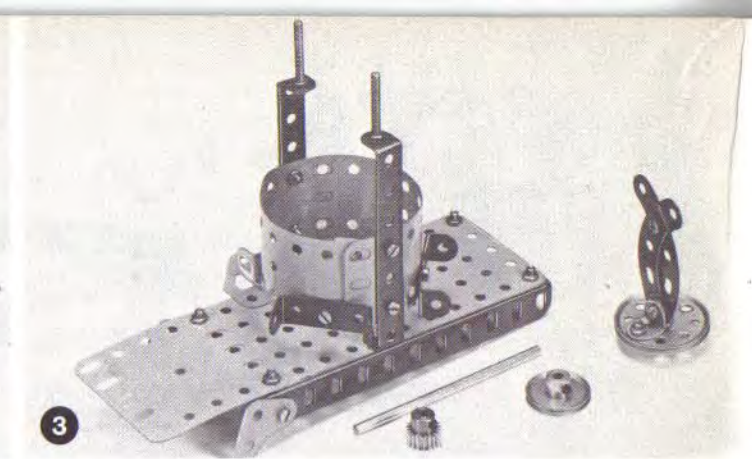
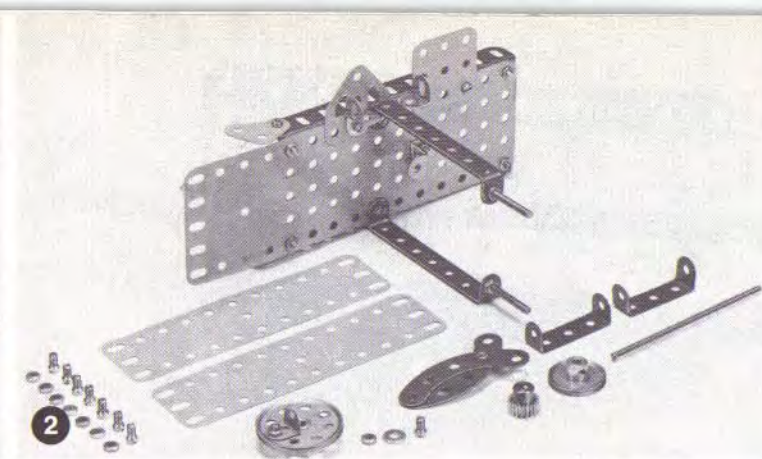
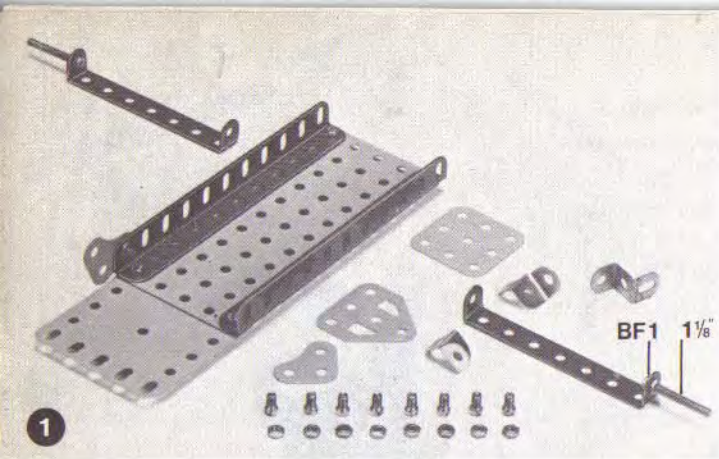

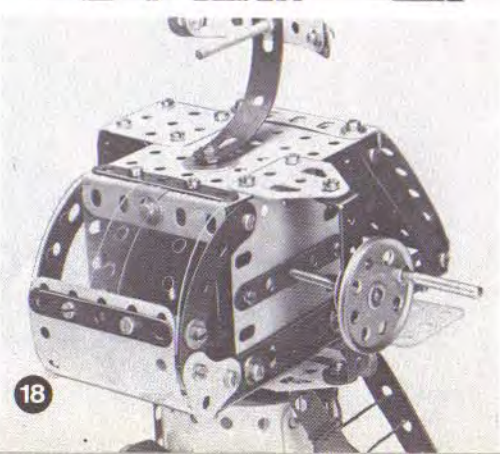
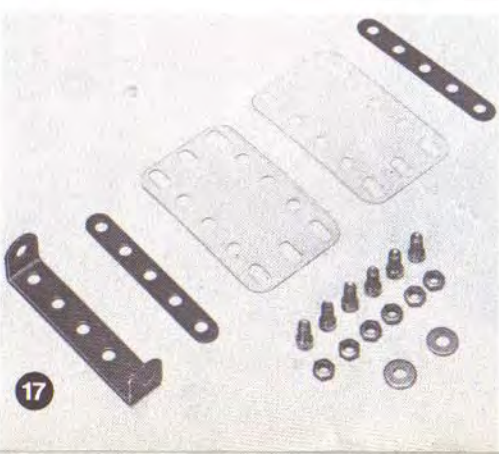
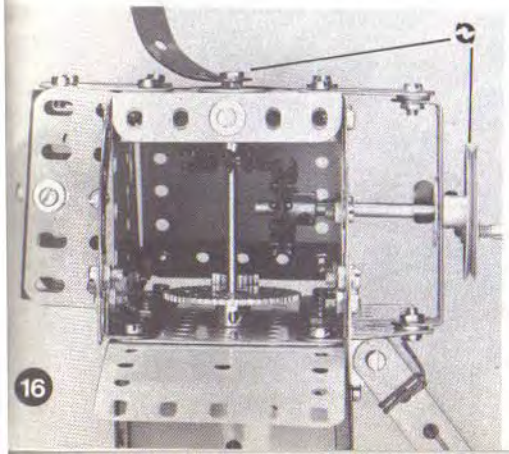
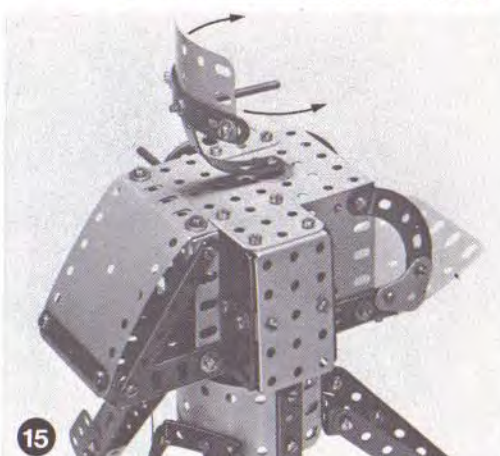
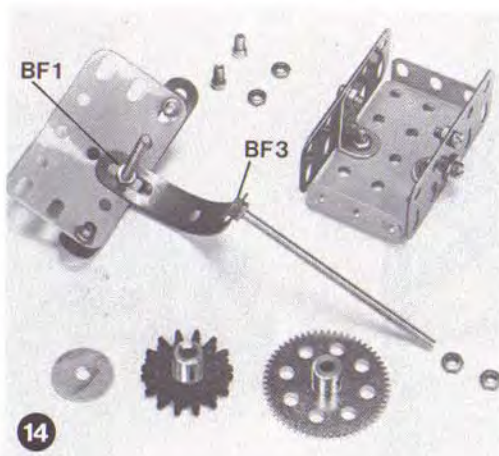
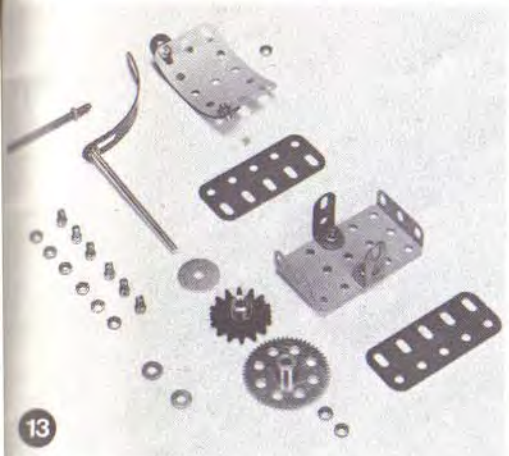
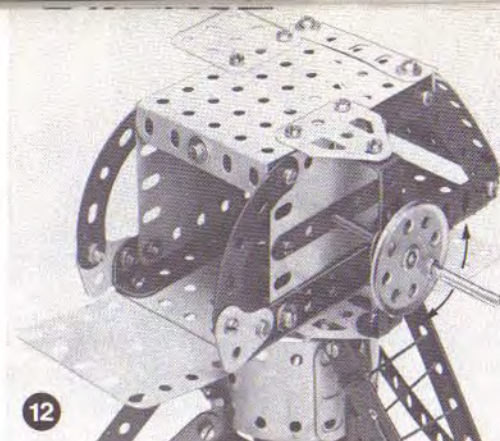
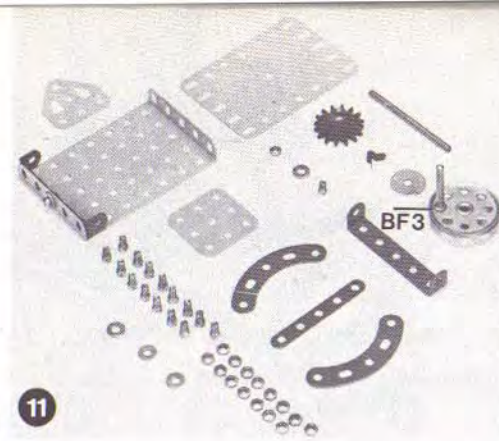
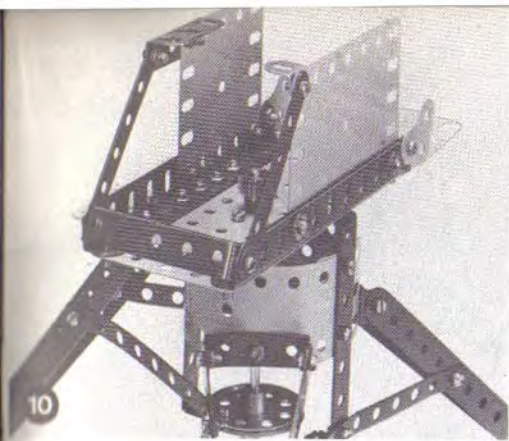

**Lunar Lander**  
 Module lunaire  
 maanlander  
 Mondfahrzeug  
 Romskip  
 Cuerpo de Alunizaje  
 Veicolo lunare

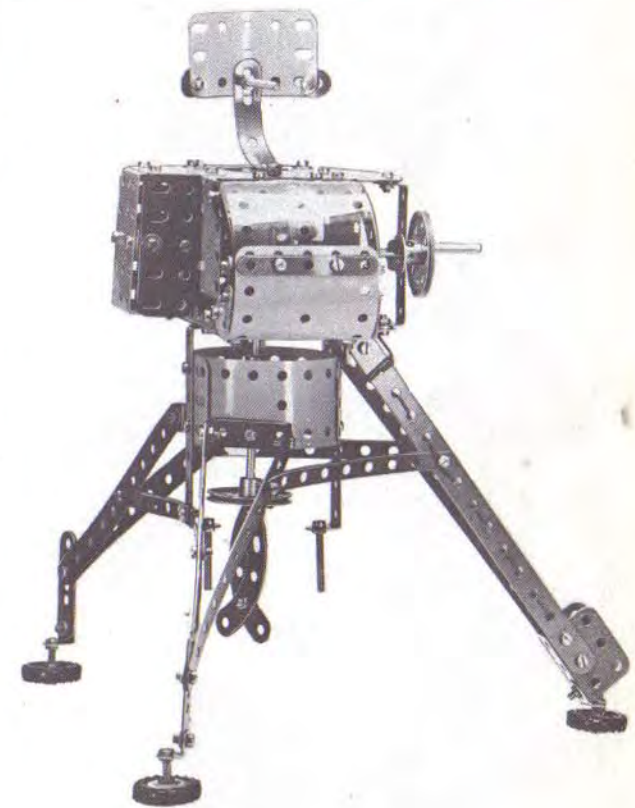

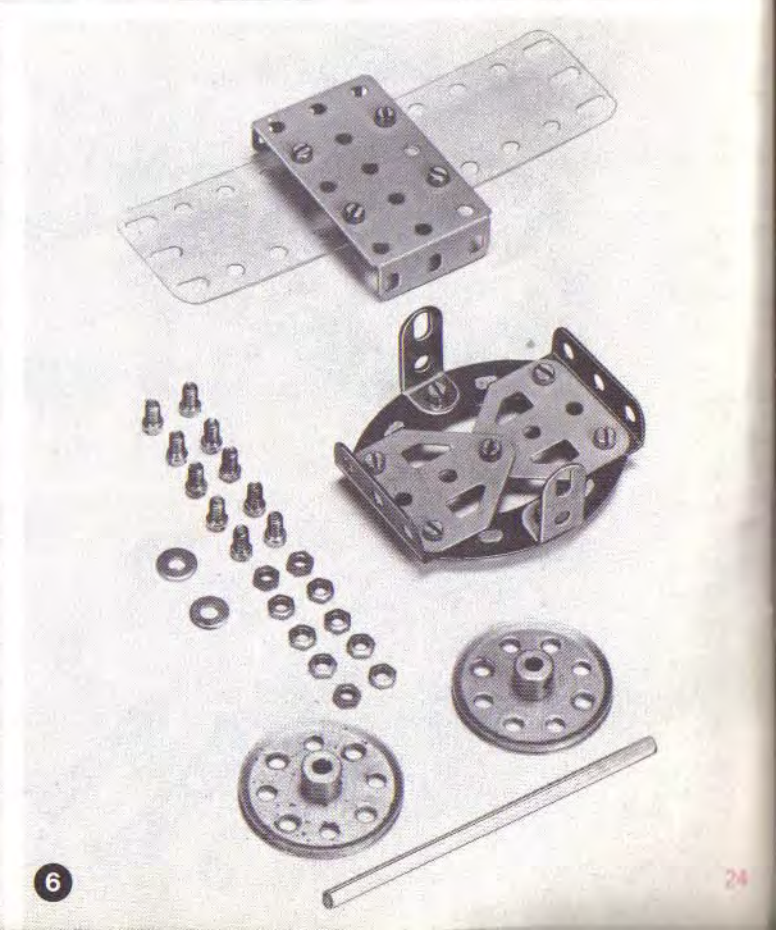
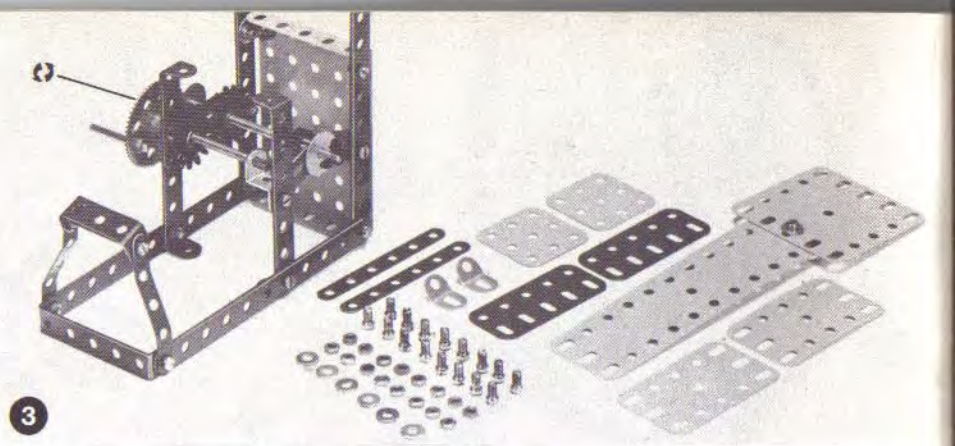
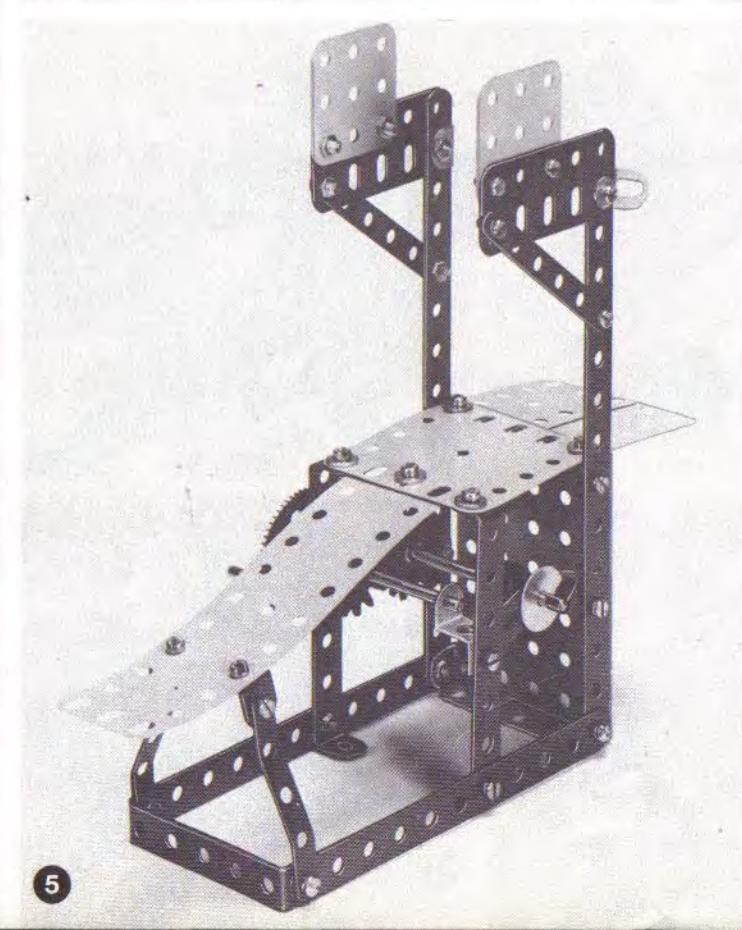
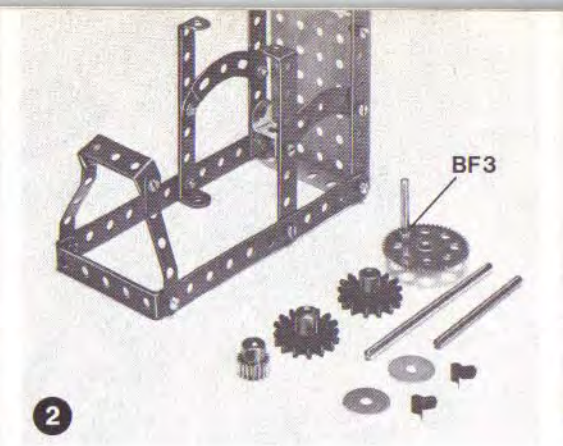
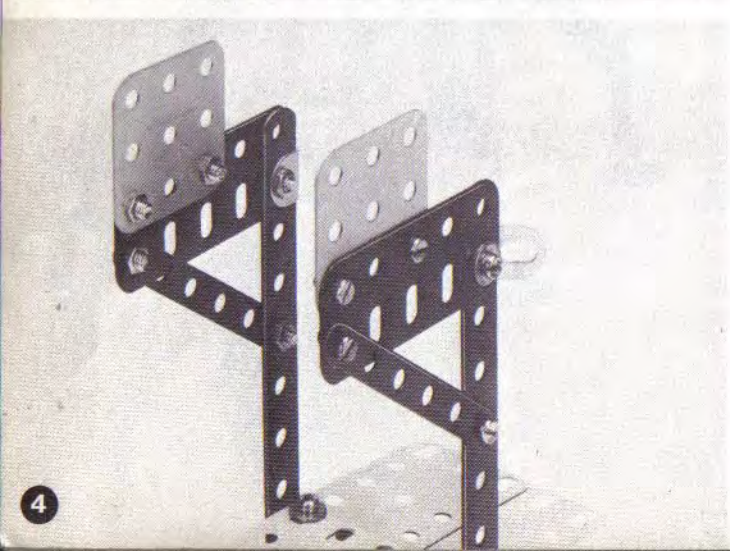
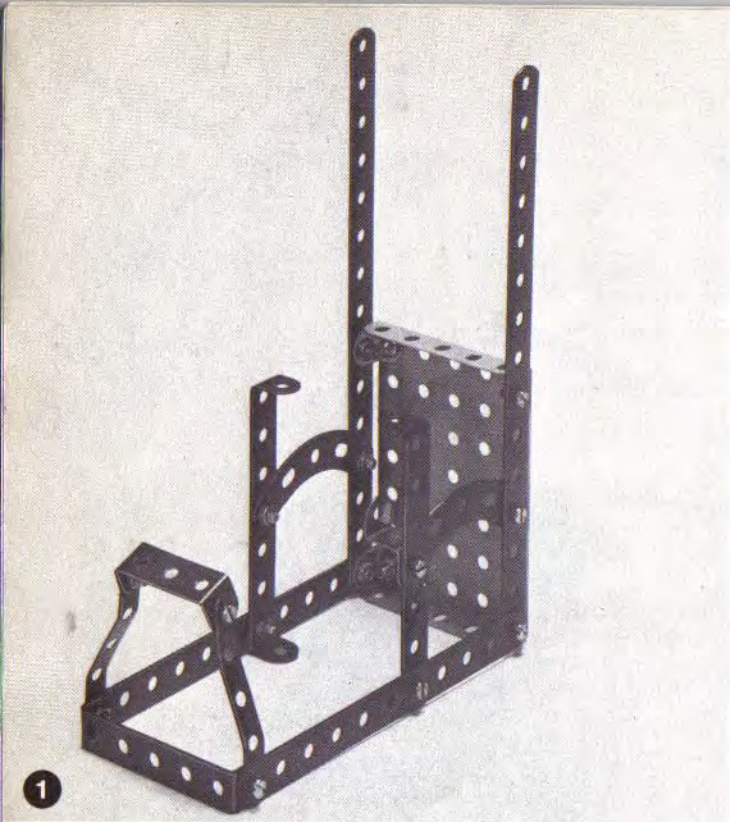



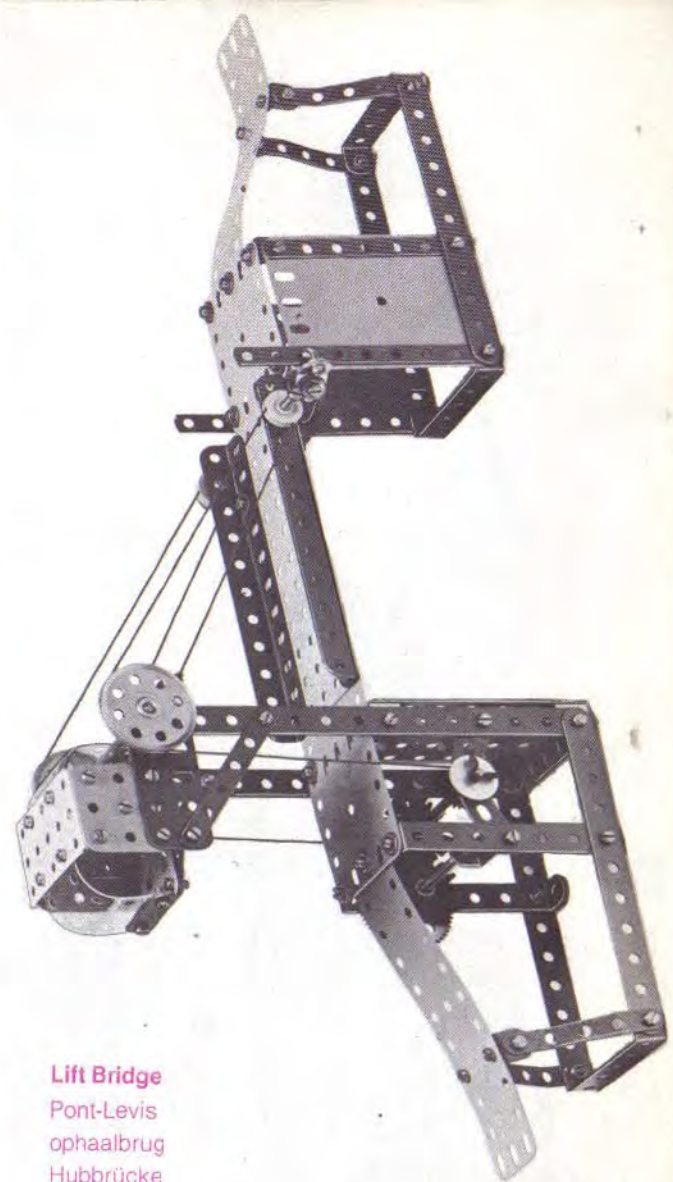
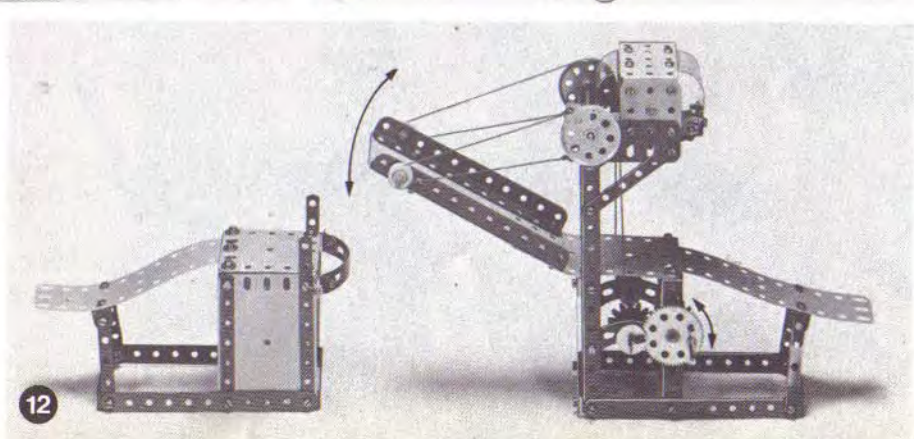
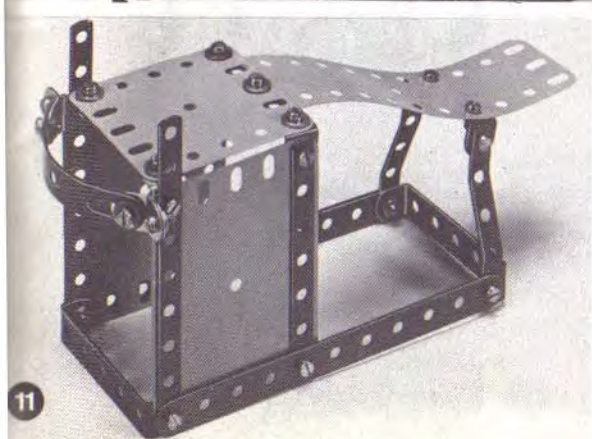
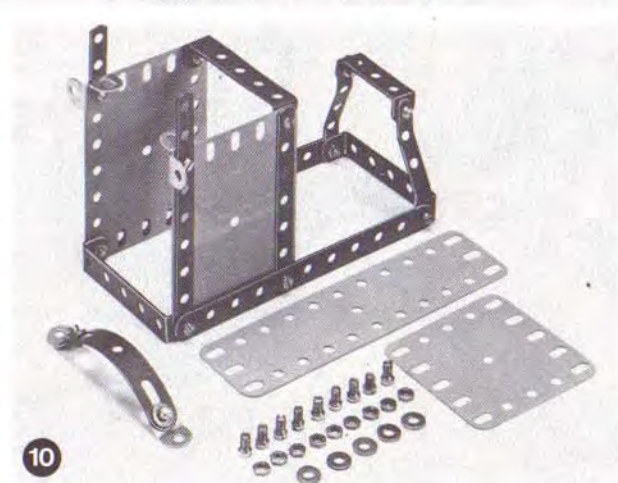
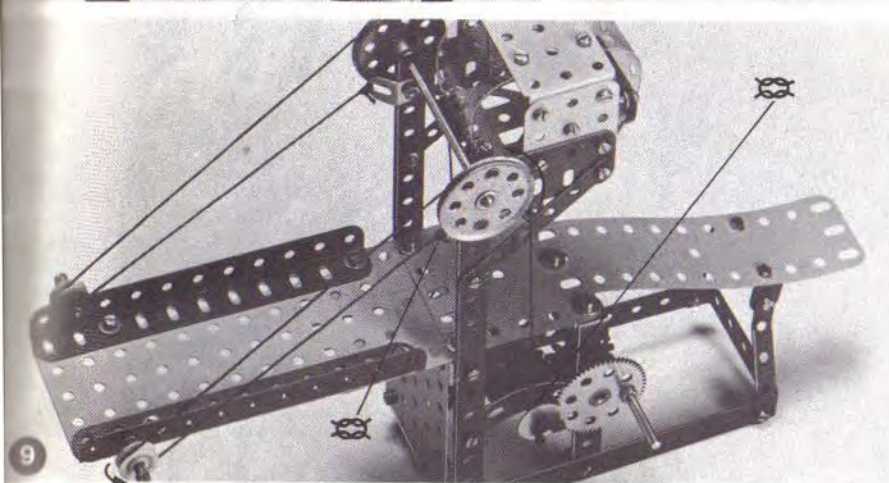
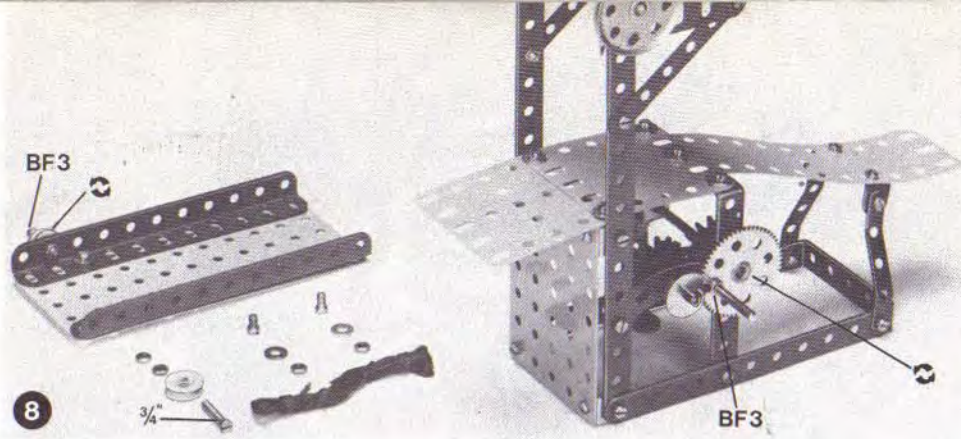
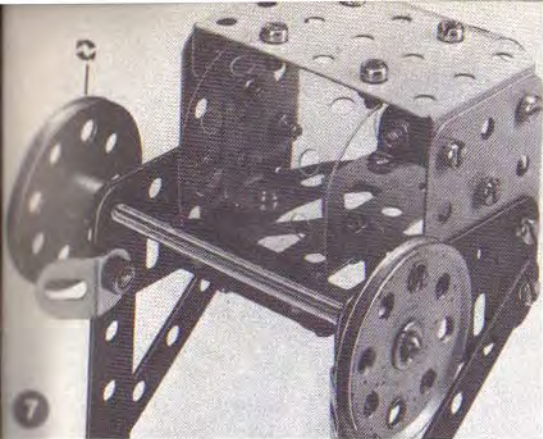

**Lift Bridge**  
 Pont-Levis  
 ophaalbrug  
 Hubbrücke  
 Løftbar Bro  
 Puente elevador  
 Ponte levatoio

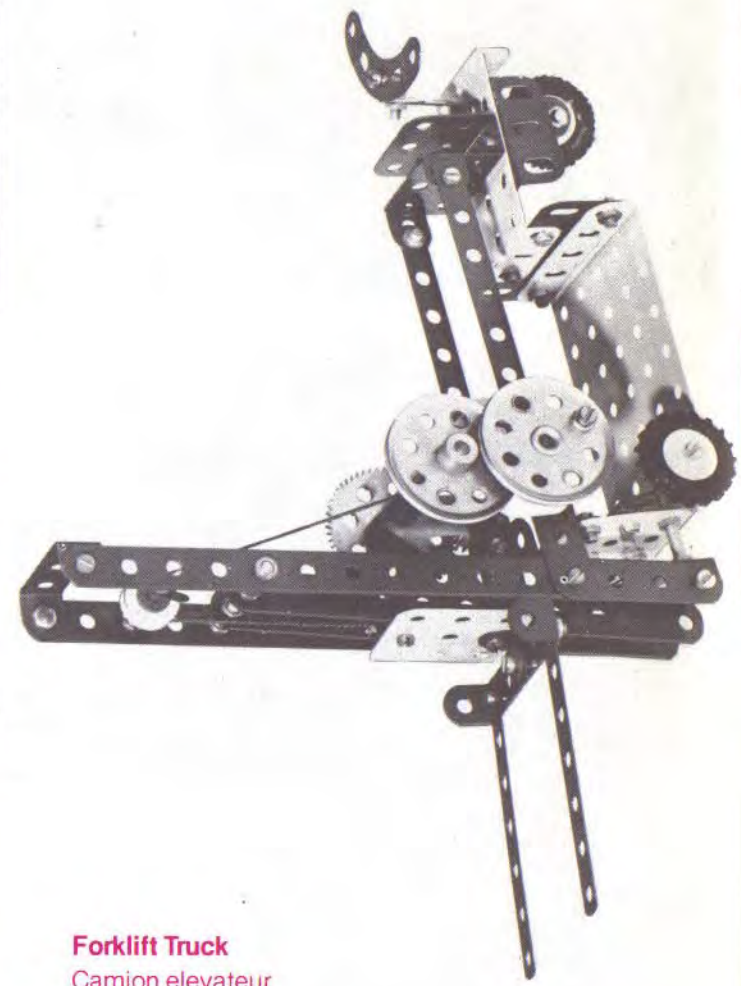
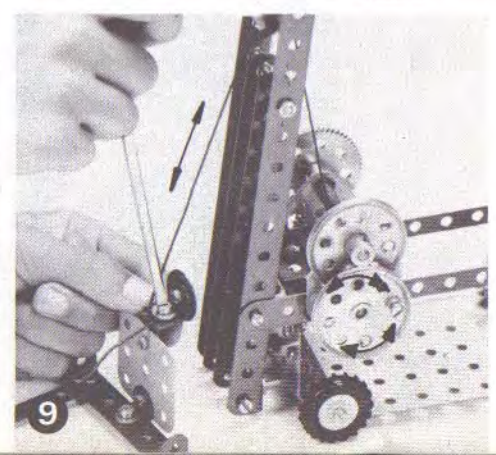
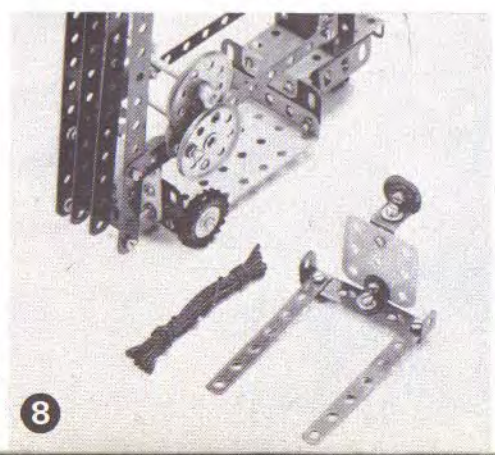
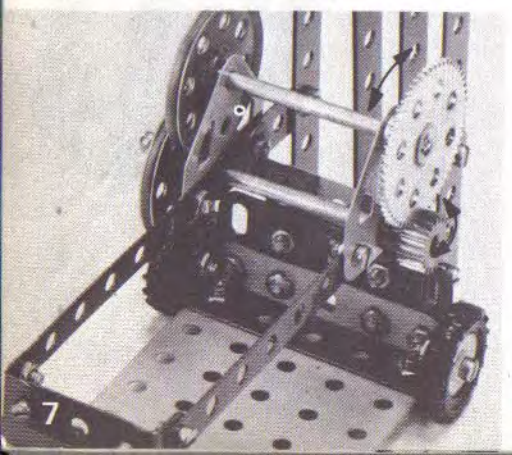
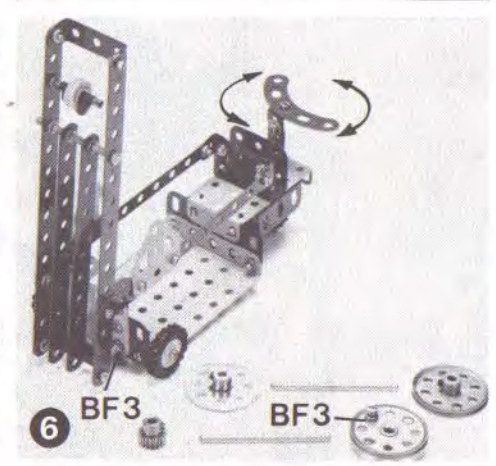
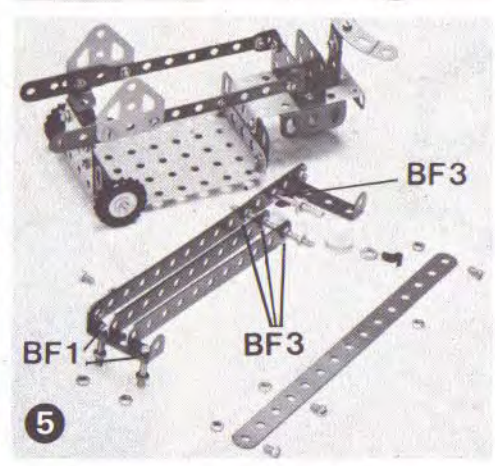
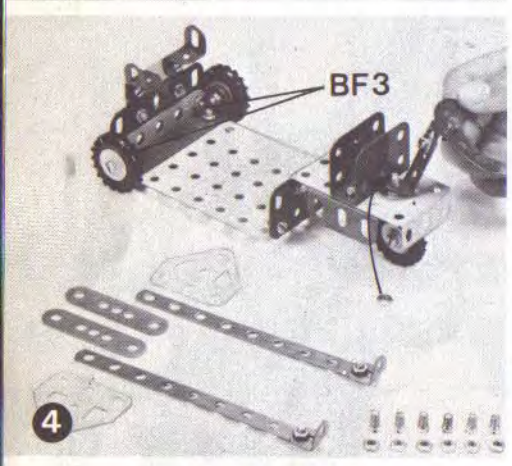
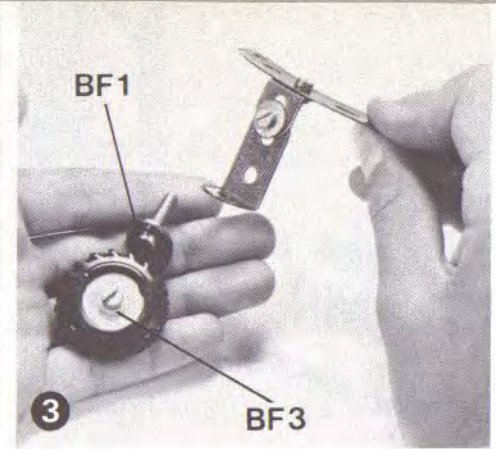
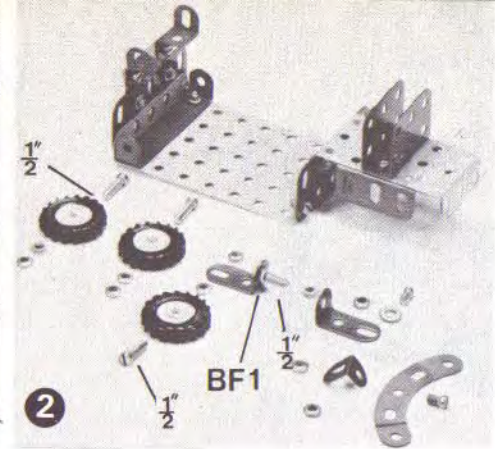
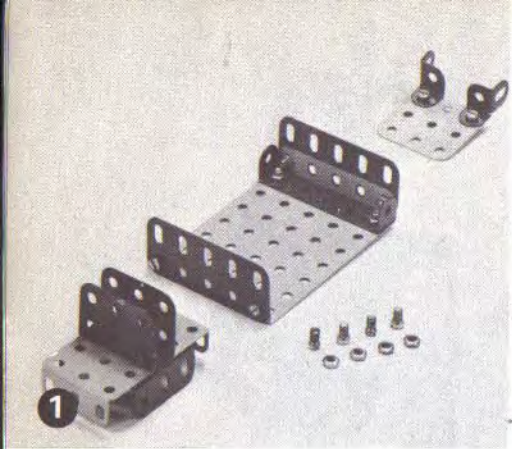

**Forklift Truck**  
 Camion elevateur  
 vorkhef-truck  
 Gabelstaber  
 Gaffeltruck  
 Carretilla elevadora  
 Carrello elevatore a forza

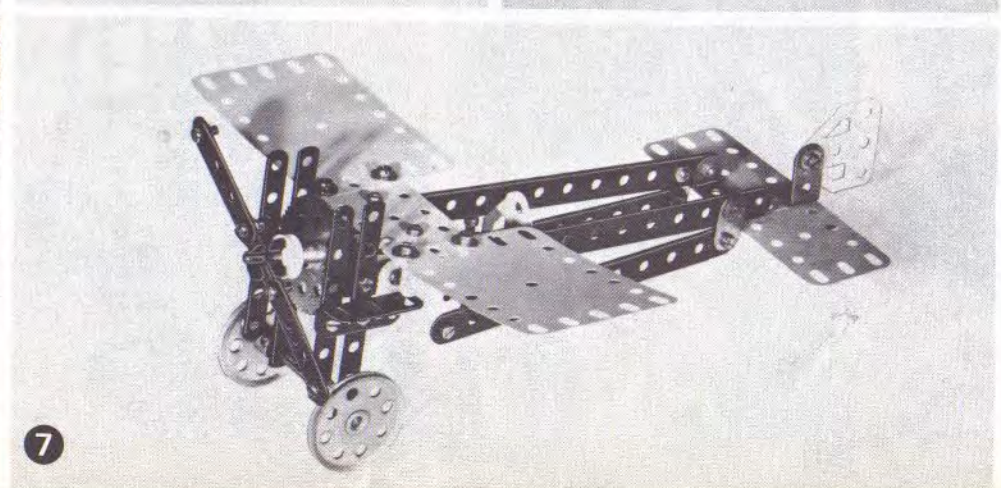
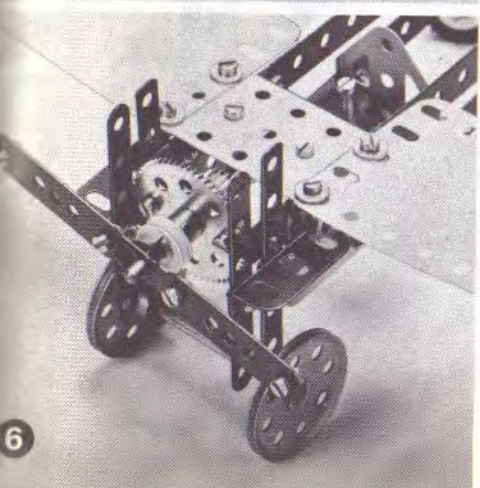
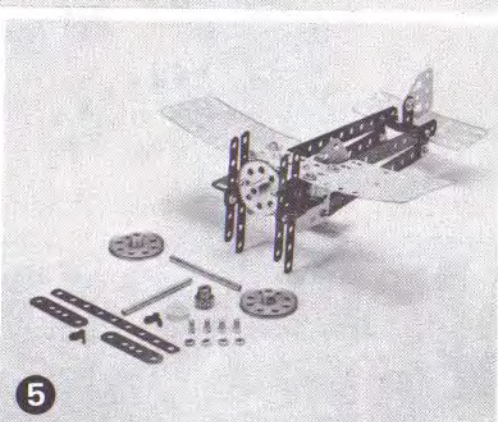
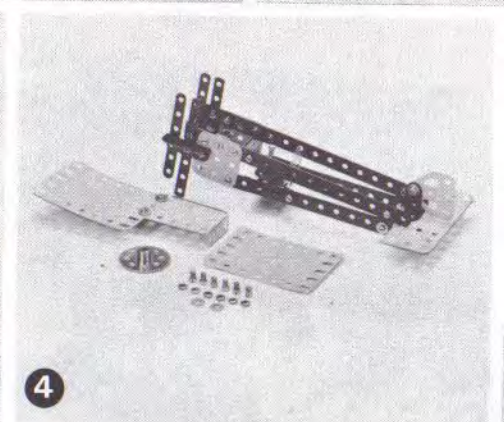
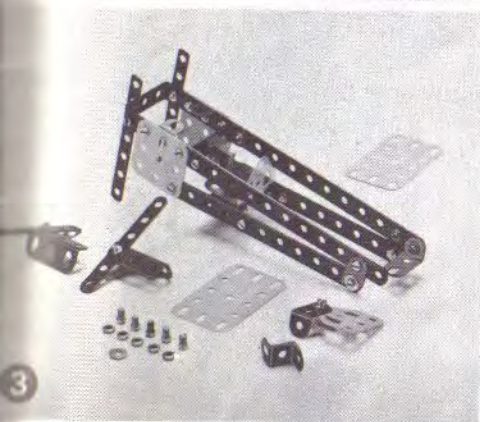
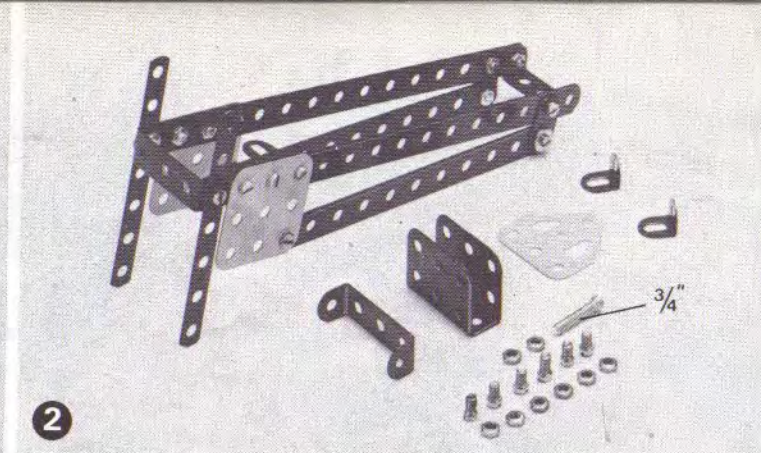
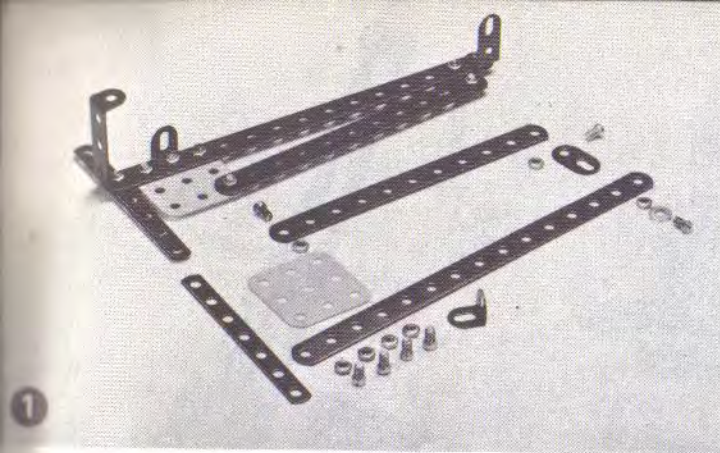

## Vintage Aeroplane

Avion d'origine  
historische vliegtuigen  
Flugzeugveteran  
veteranfly  
Avion Antiquo  
Aereoplano antico

2.2

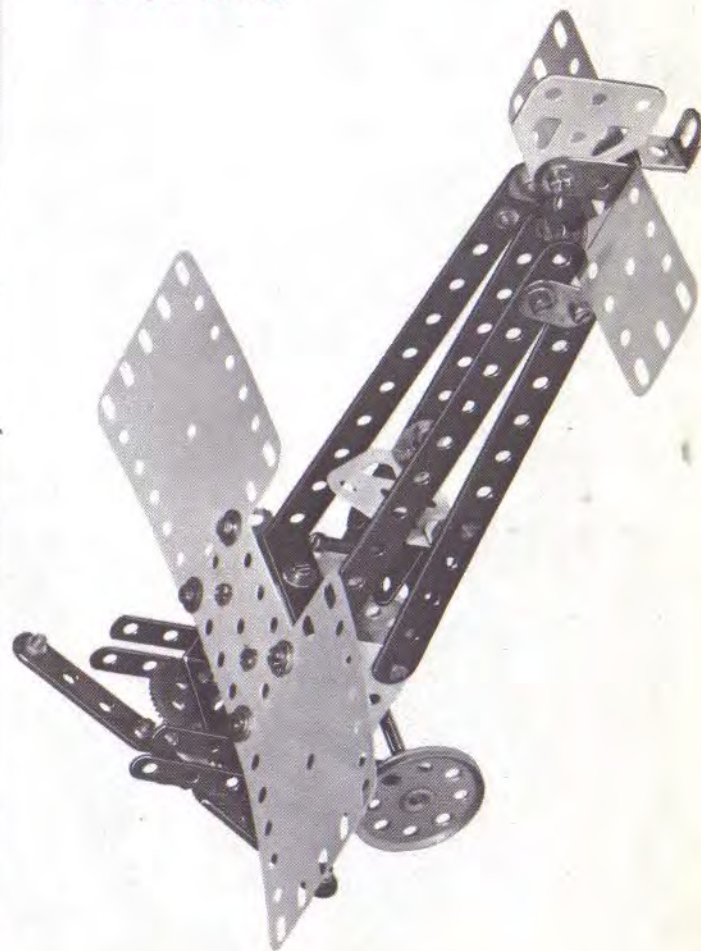

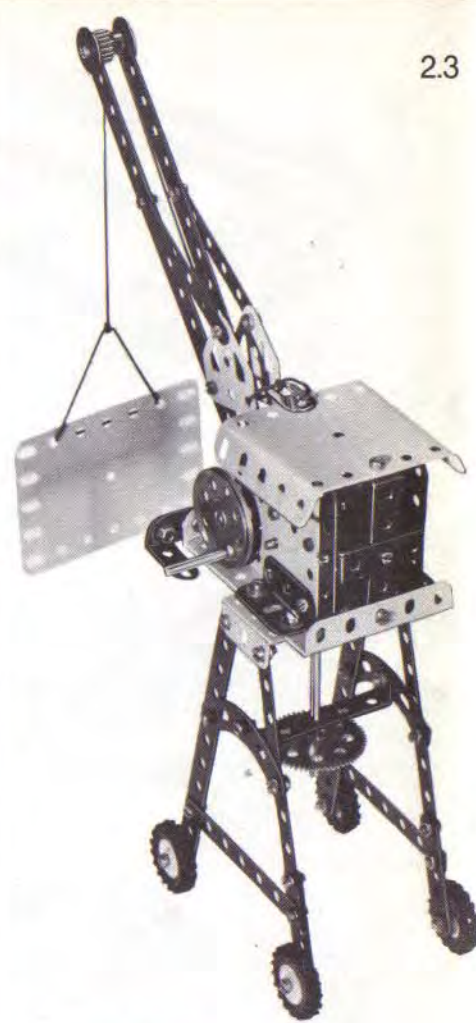
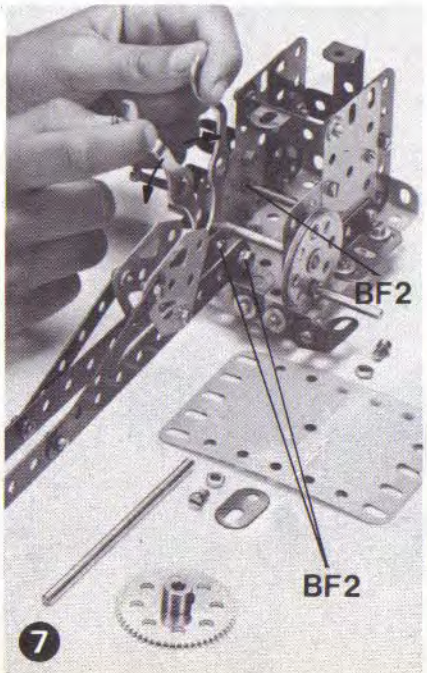
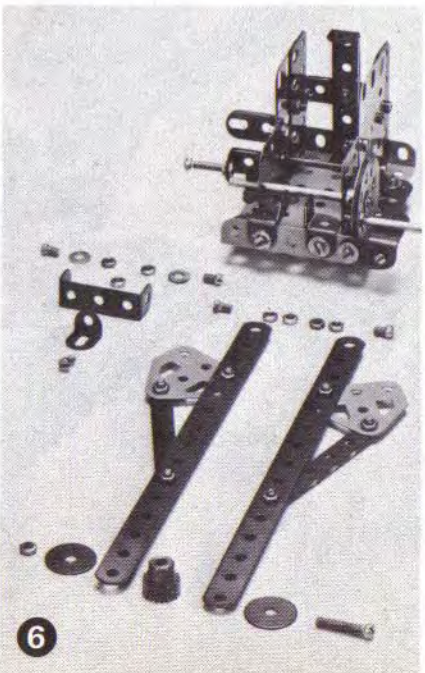
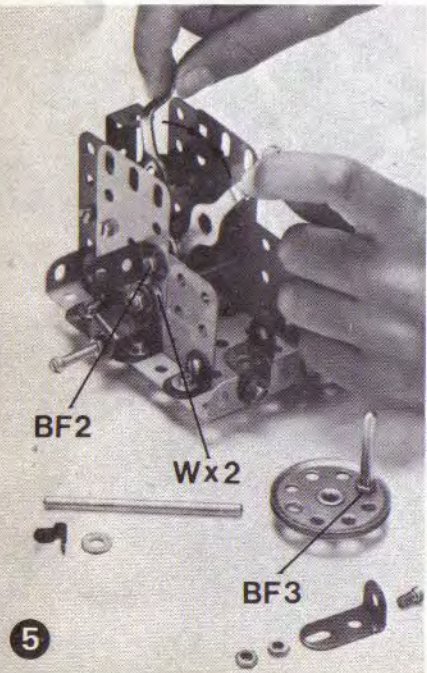
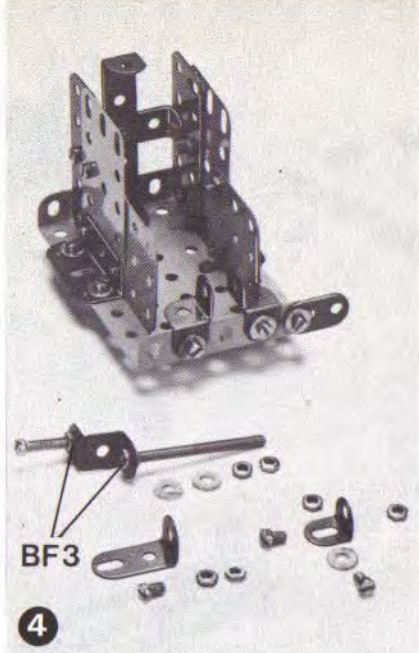
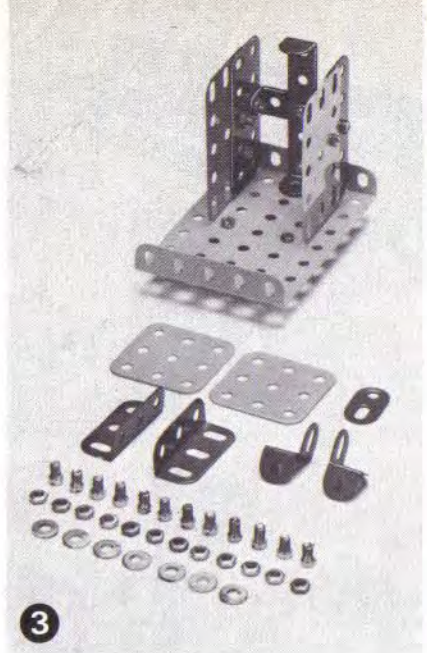
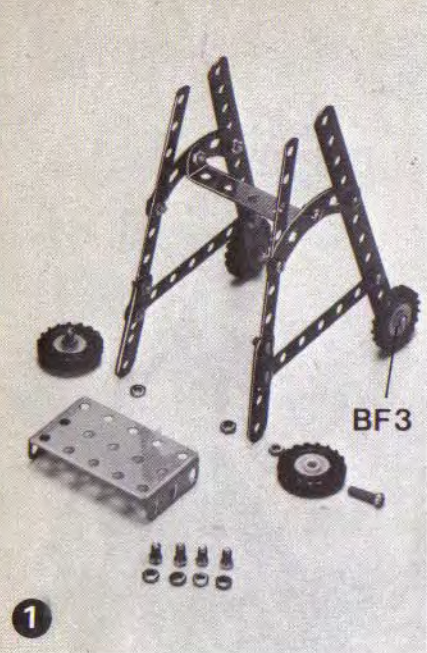

**Dock Crane**  
 Grue de dock  
 hijskraan  
 Hafenkran  
 Heisekran  
 Grúa de Muëlle  
 Gru portuale

Lathe  
 Tour  
 draaibank  
 Drehbank  
 Dreiebank  
 Torno  
 Tornio

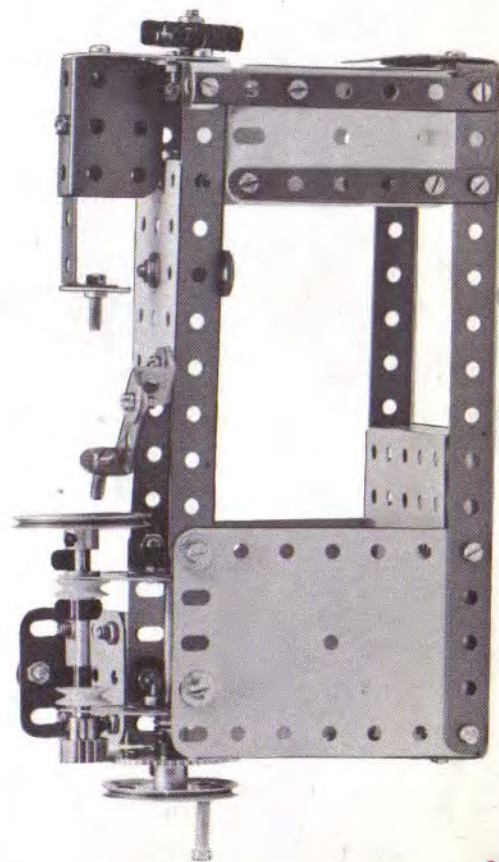
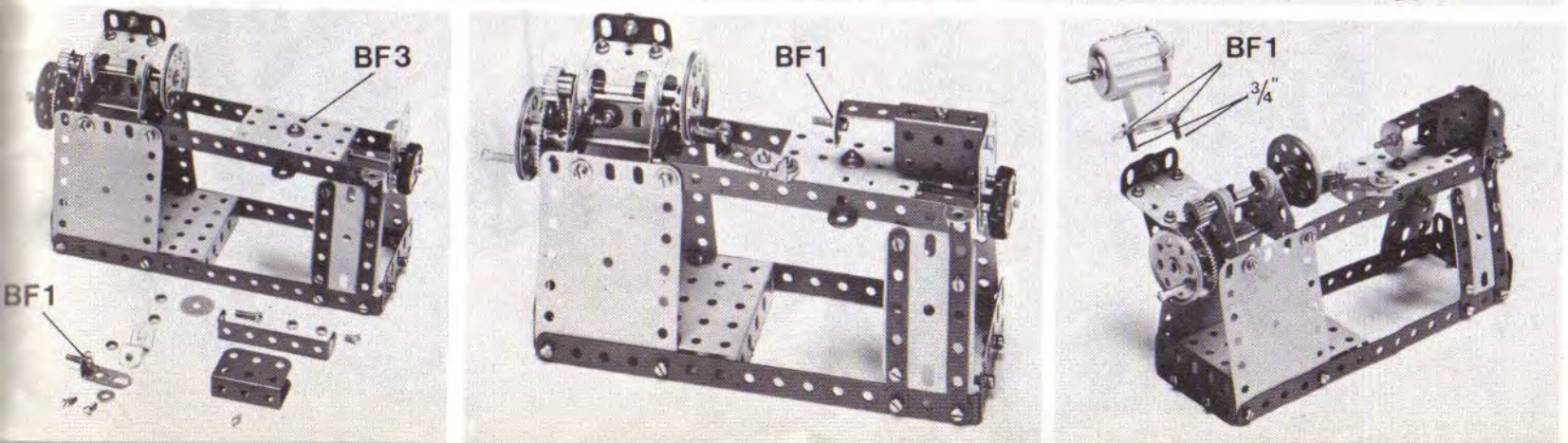
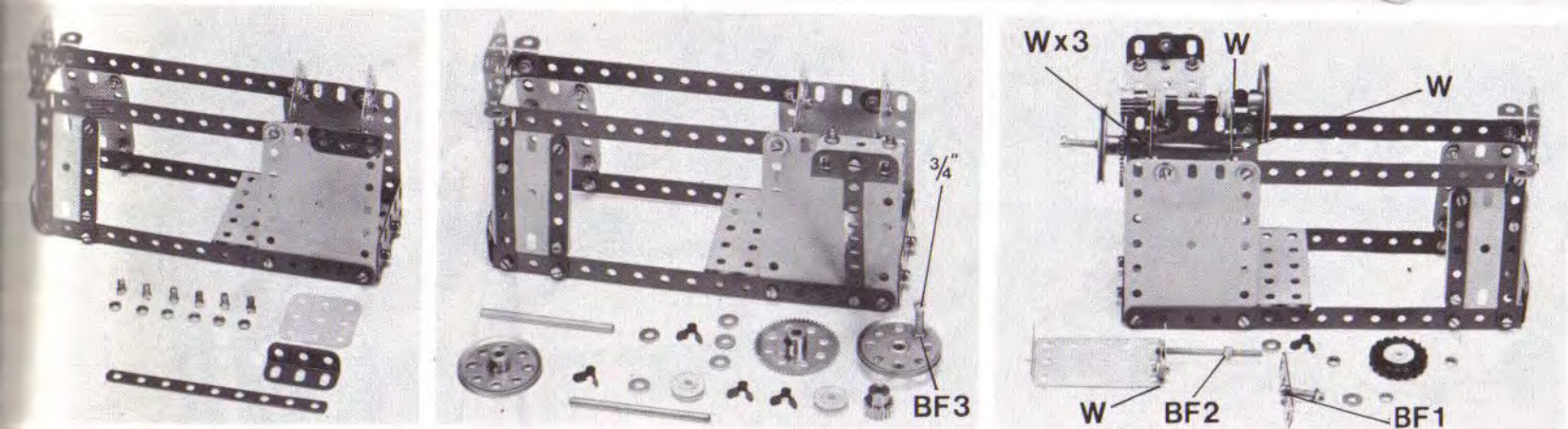
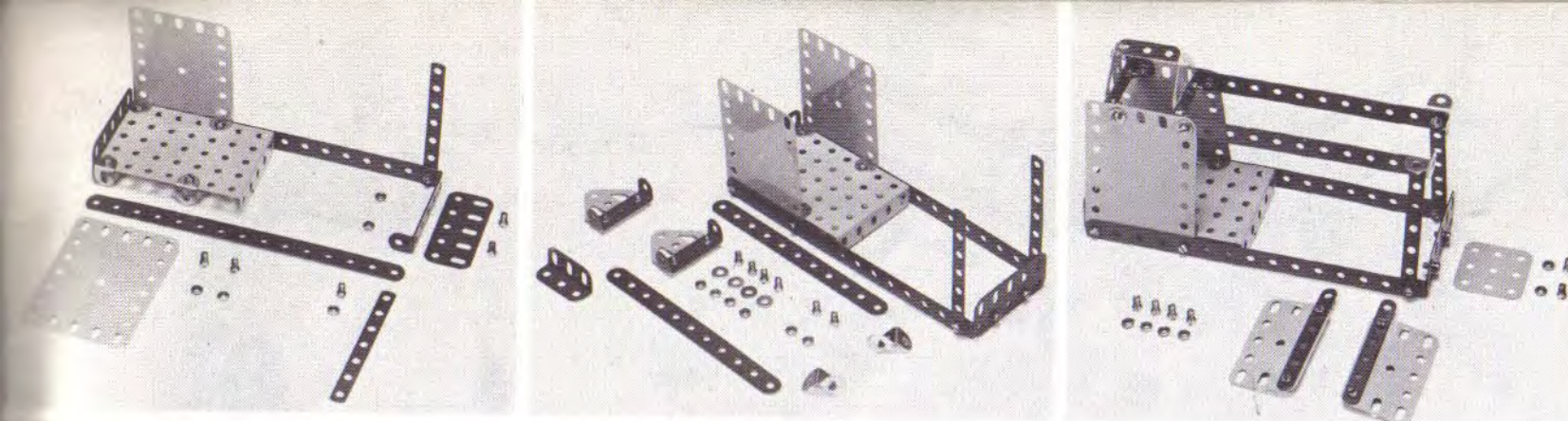

**Steam Engine**

Machine à vapeur  
 stoomachine  
 Dampfmaschine  
 Dampmaskin  
 Motor a Vapor  
 Motrice a vapore

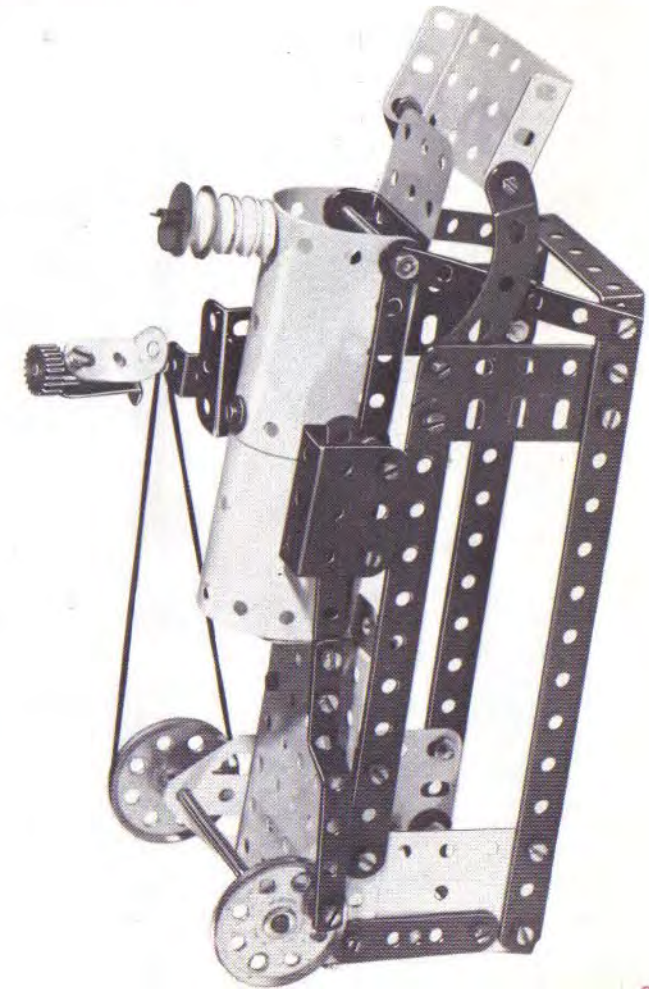
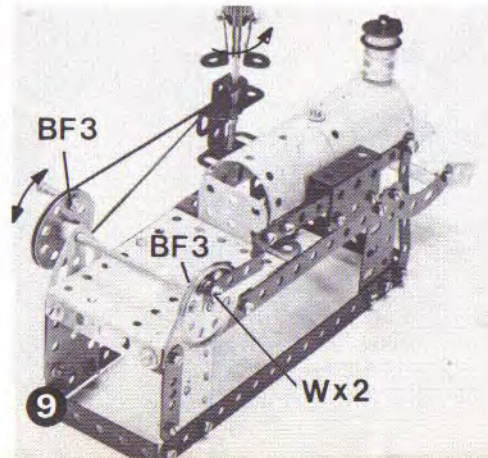
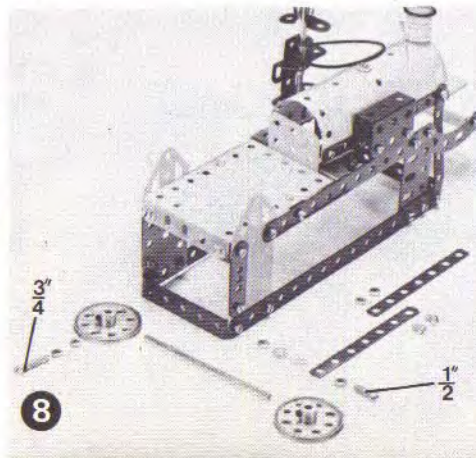
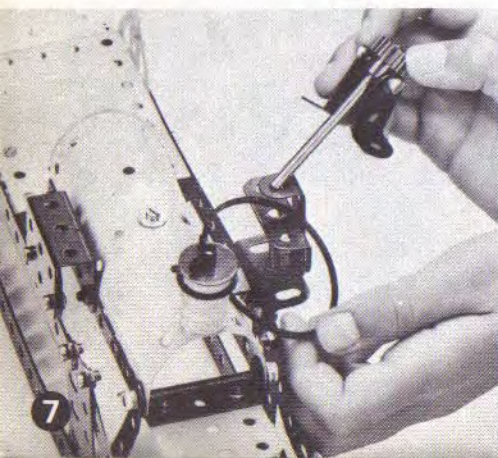
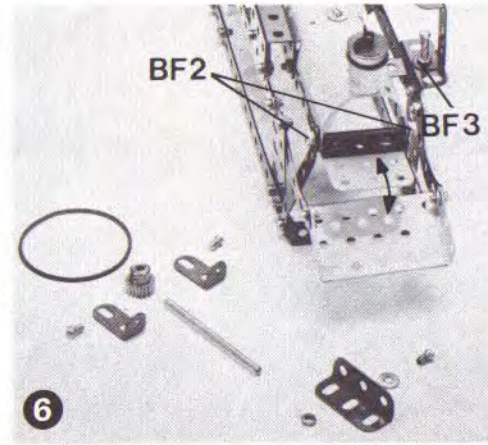
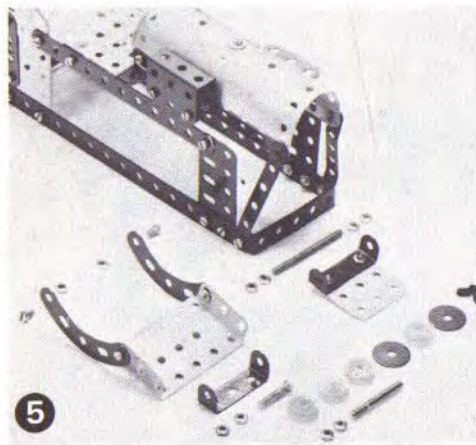
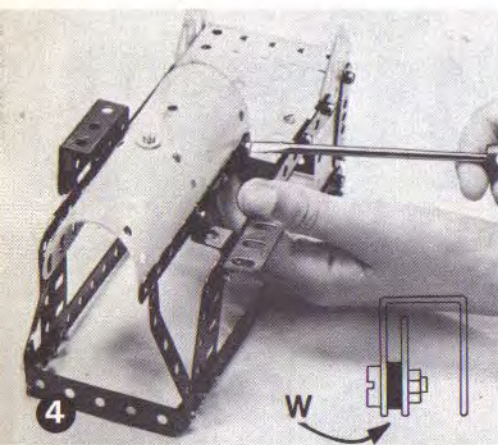
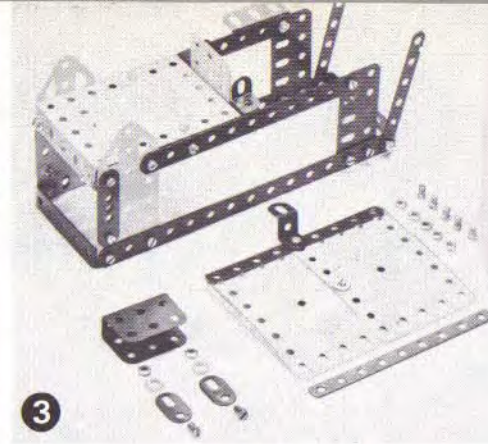
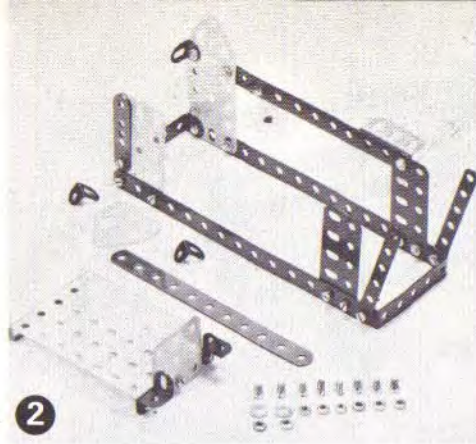
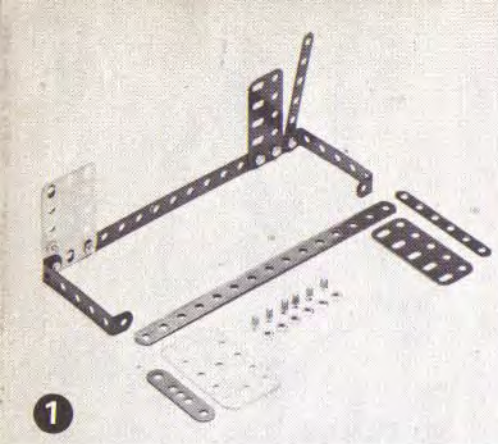

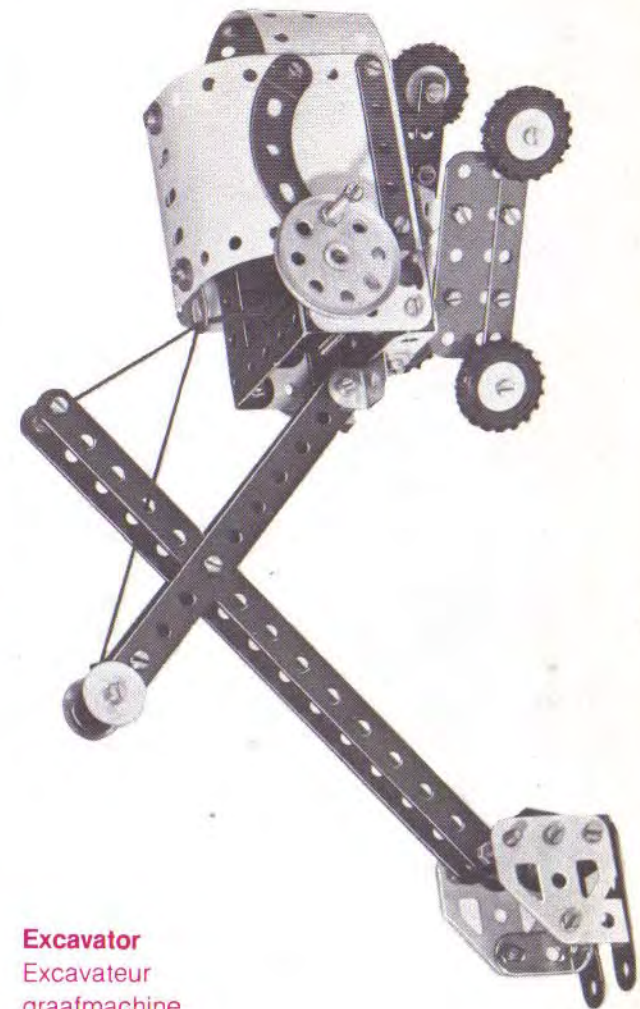
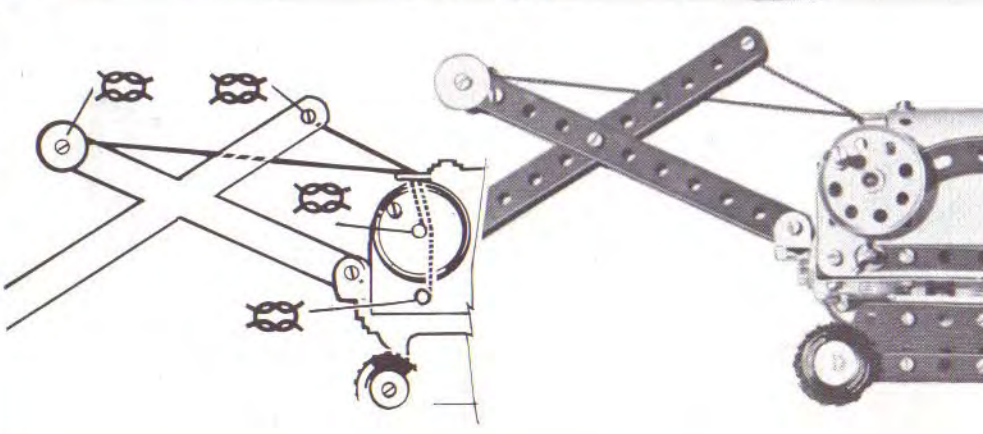
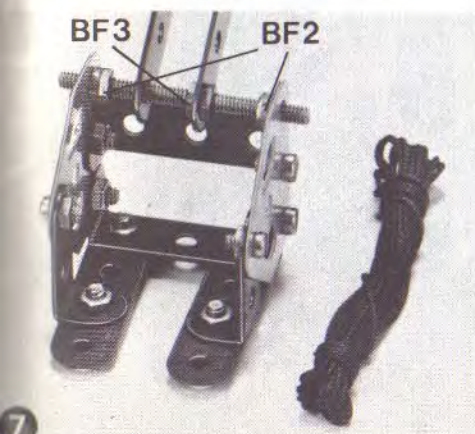
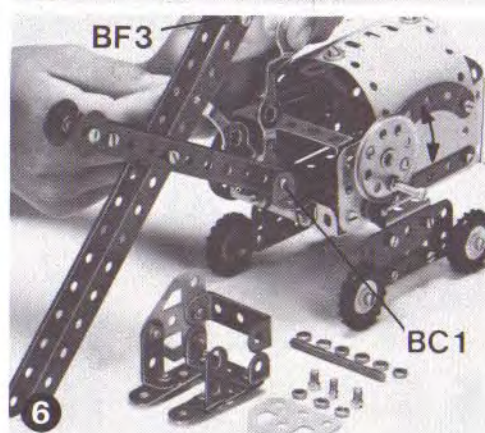
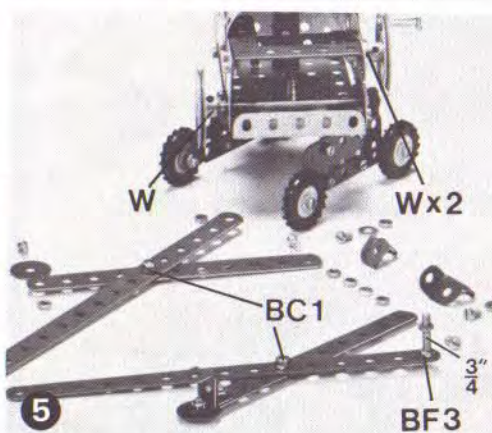
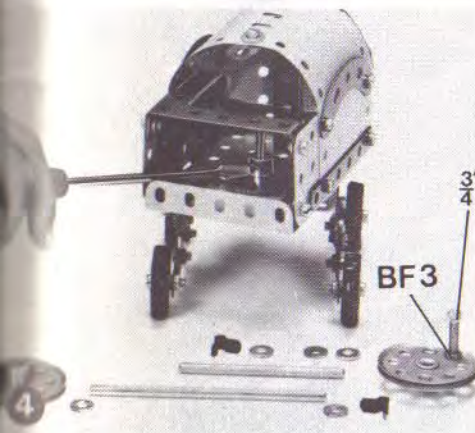
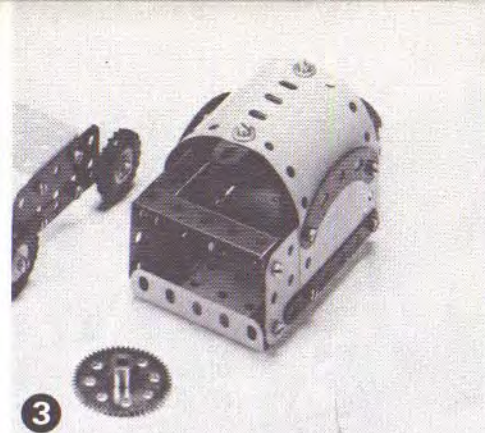
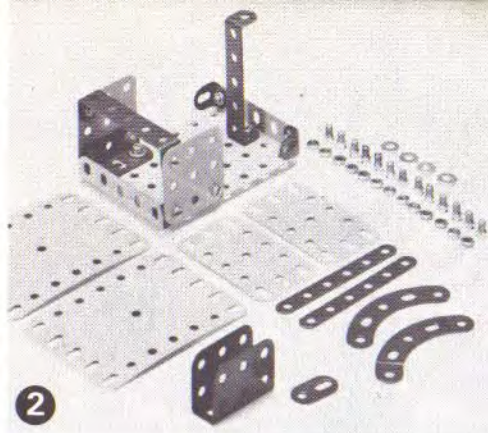
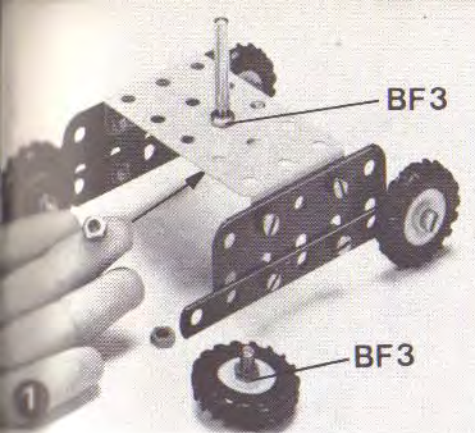

**Excavator**  
 Excavateur  
 graafmachine  
 Bagger  
 Gravemaskin  
 Escavadora  
 Scavatore

**Stamping Mill**  
 Moulin à bocard  
 stempelmachine  
 Stanze  
 Presse  
 Bocarte  
 Stampatrice

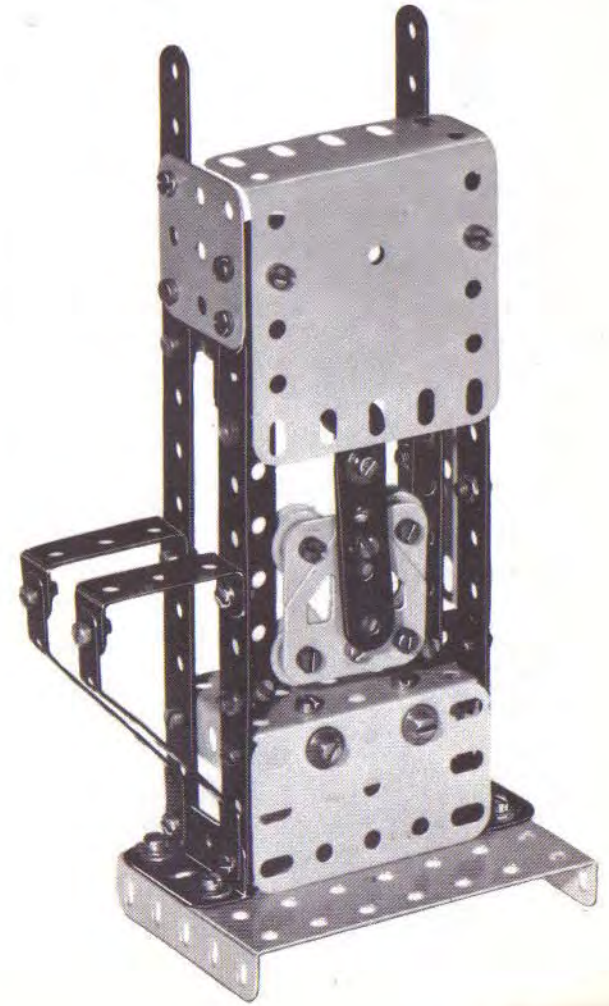
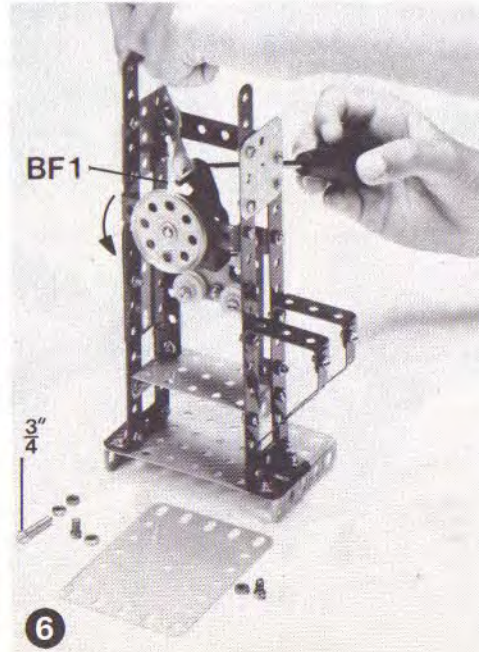
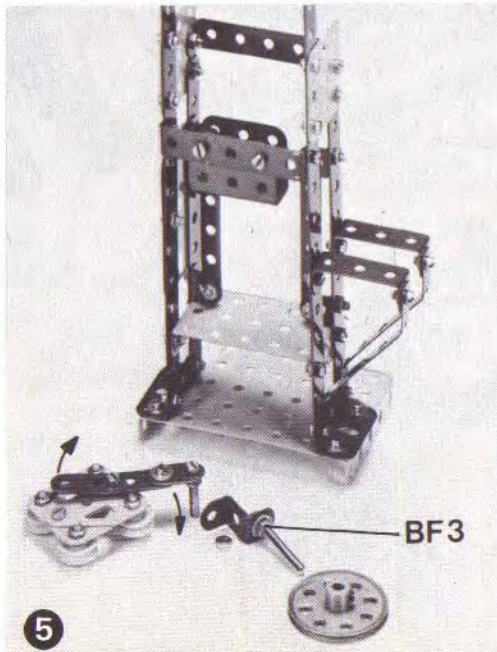
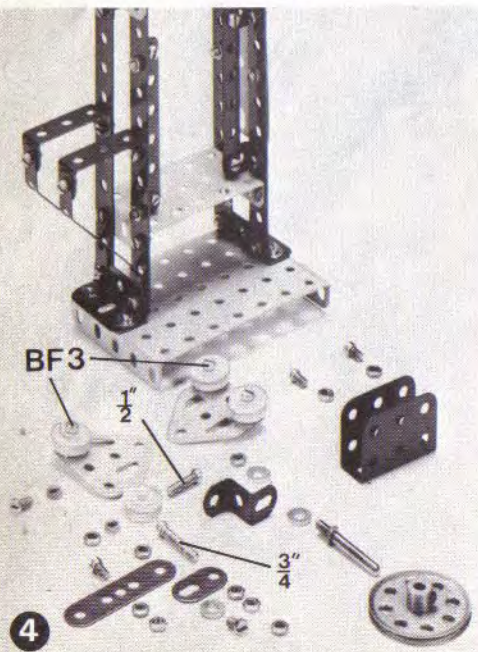
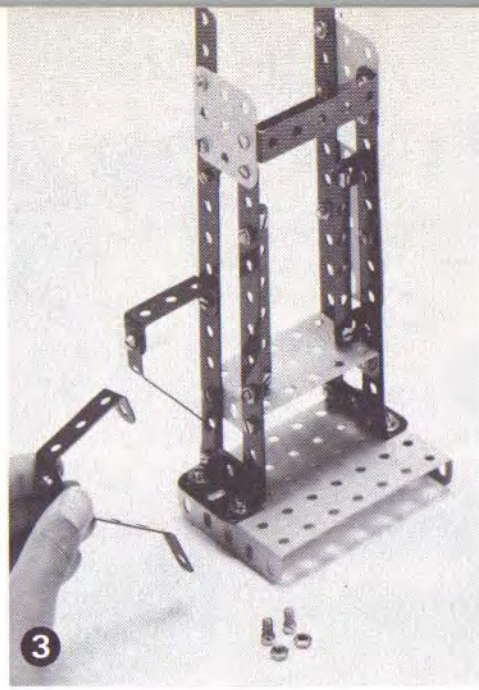
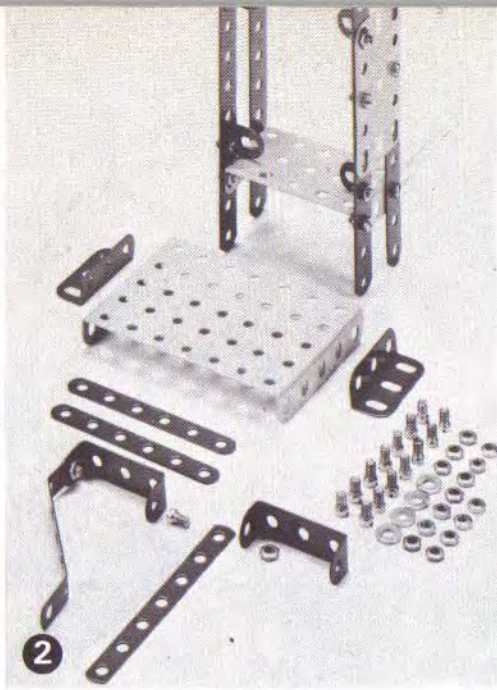
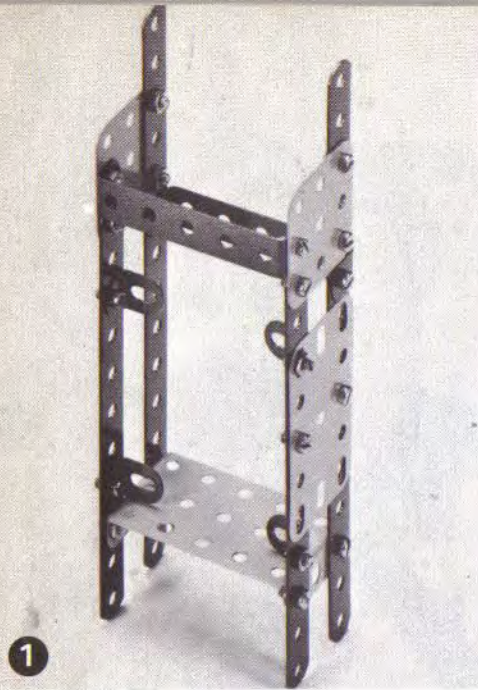



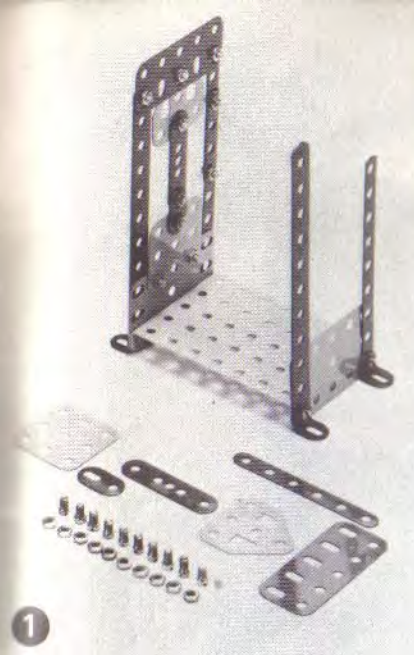

1

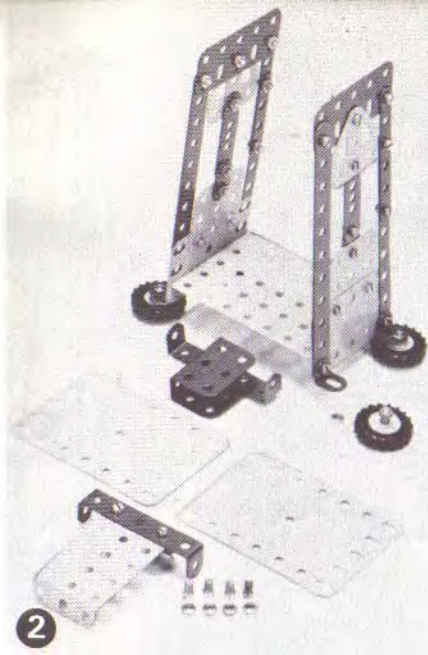

2

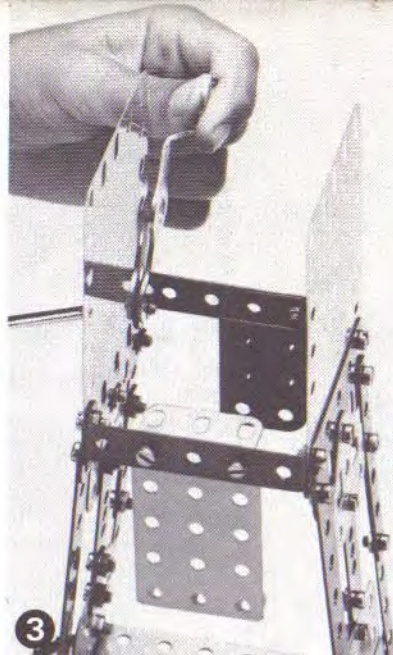

3

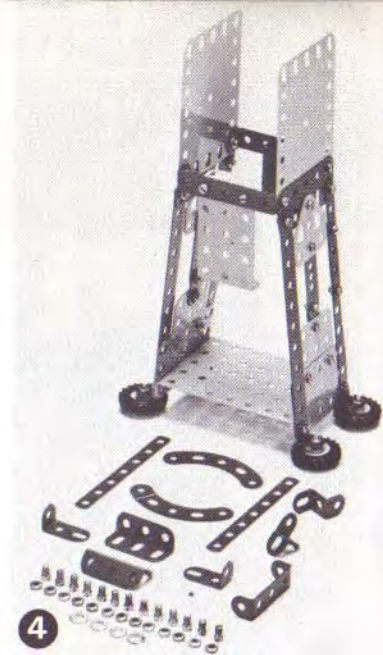

4

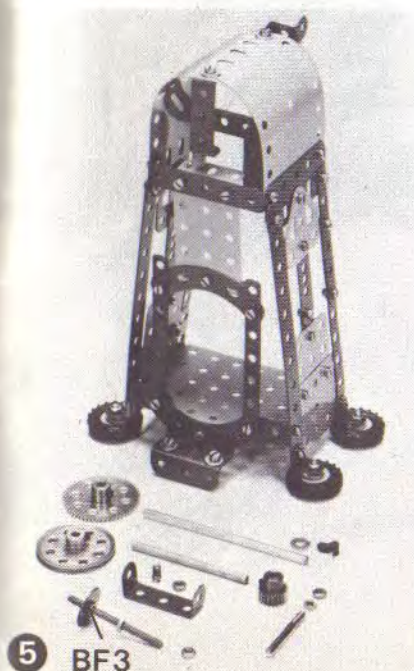
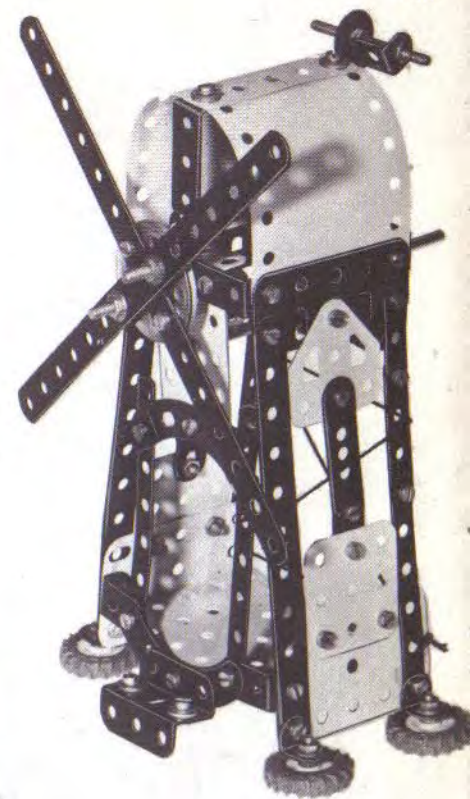

5

BF3



6

BF3

BF1

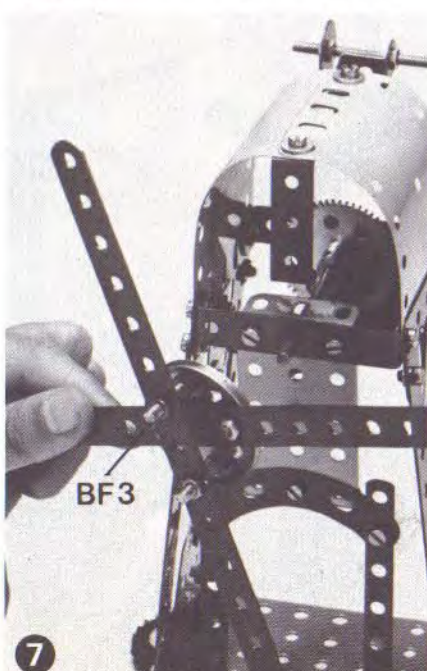

7

BF3

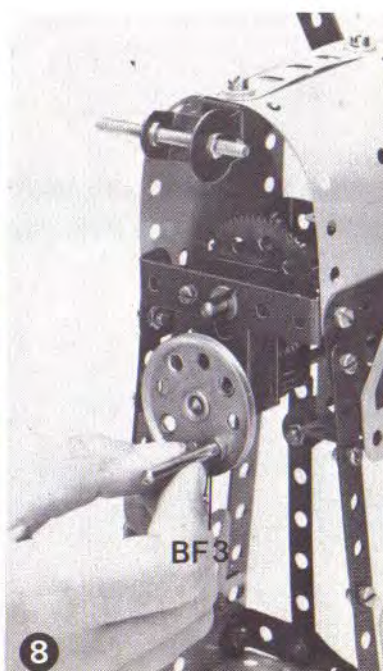

8

BF3

### Windmill

Moulin a vent

windmolen

Windmühle

Vindmølle

Molino de Viento

Molino a vento

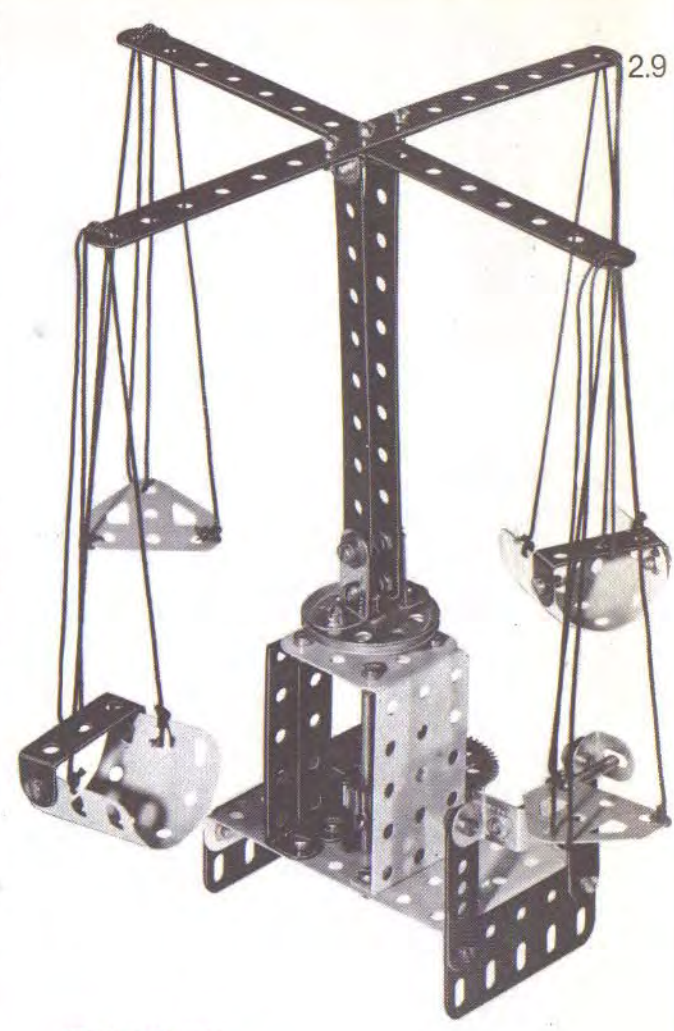
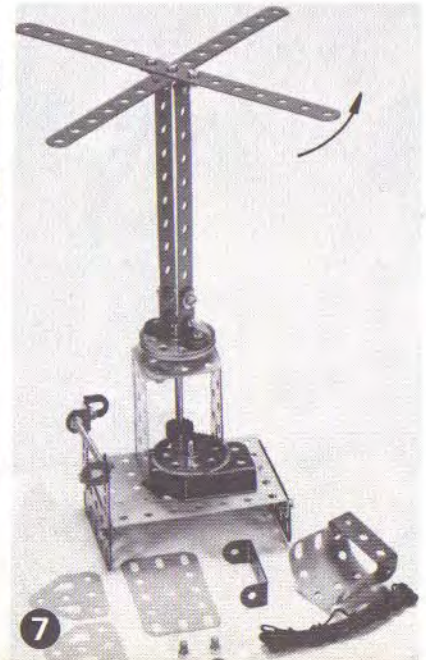
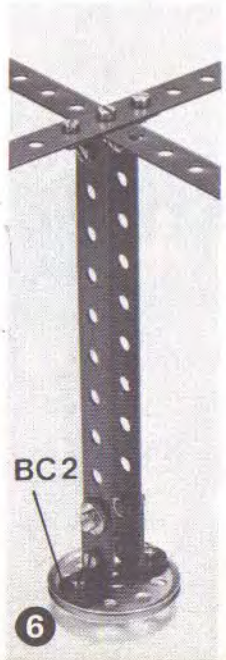
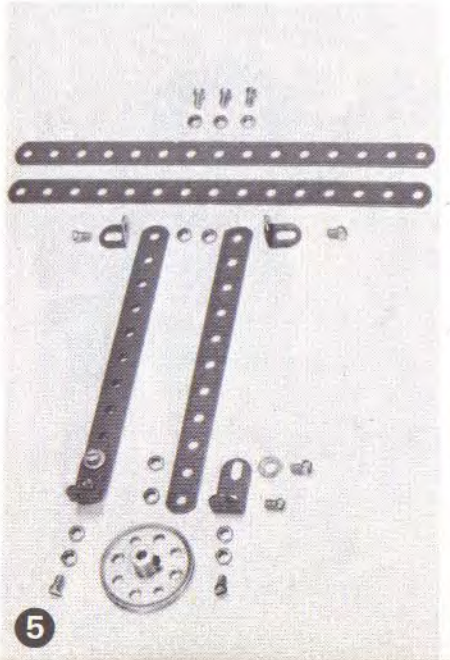
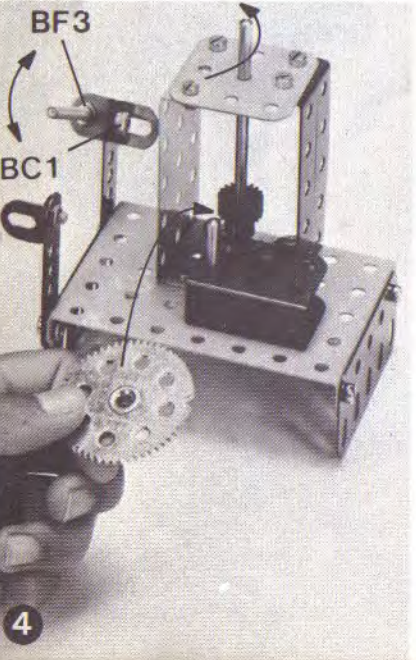
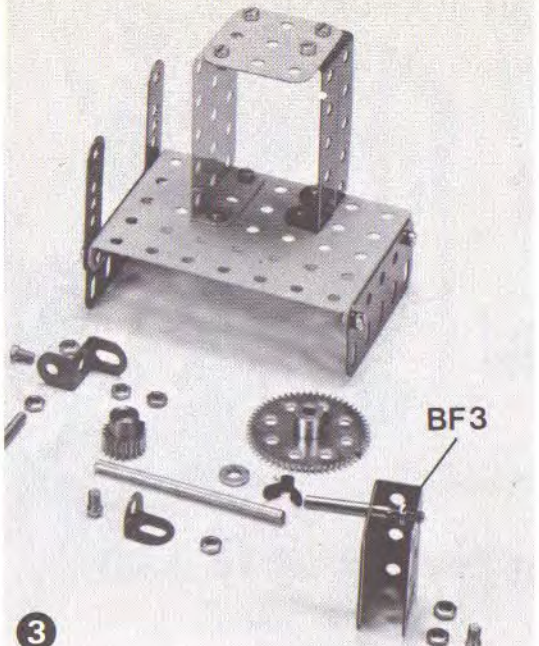
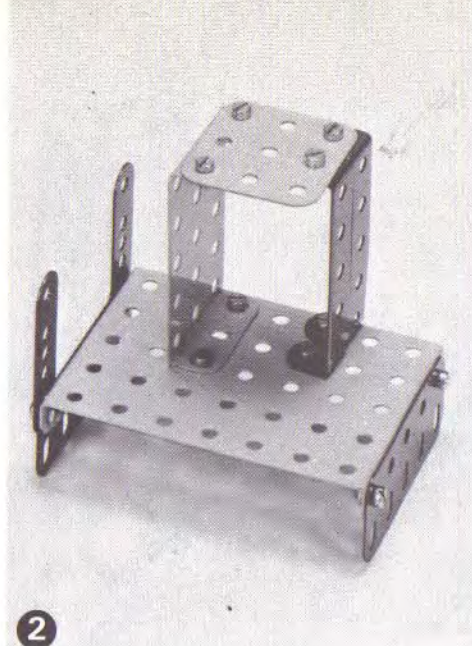
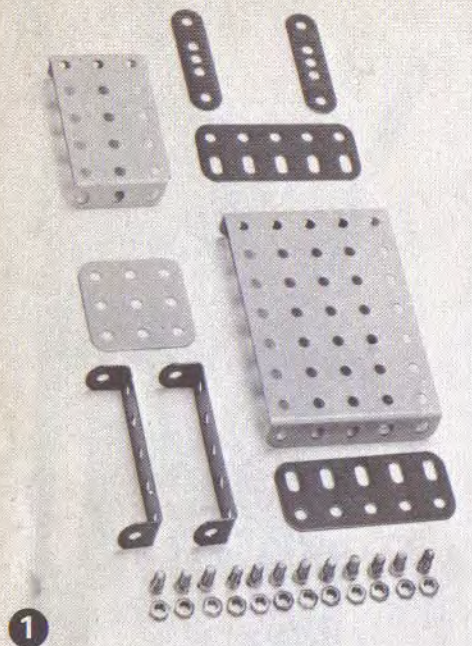

**Flying Chairs**  
 Carrousel  
 zweefmolen  
 Kettenflieger  
 Karusell  
 Sillas voladoras  
 Giostra a sedici volanti

**Fire Truck**  
 Voiture de pompier  
 brandweerauto  
 Feuerwehr  
 Brannbil  
 Camión de Bomberos  
 Autoscala da incendio

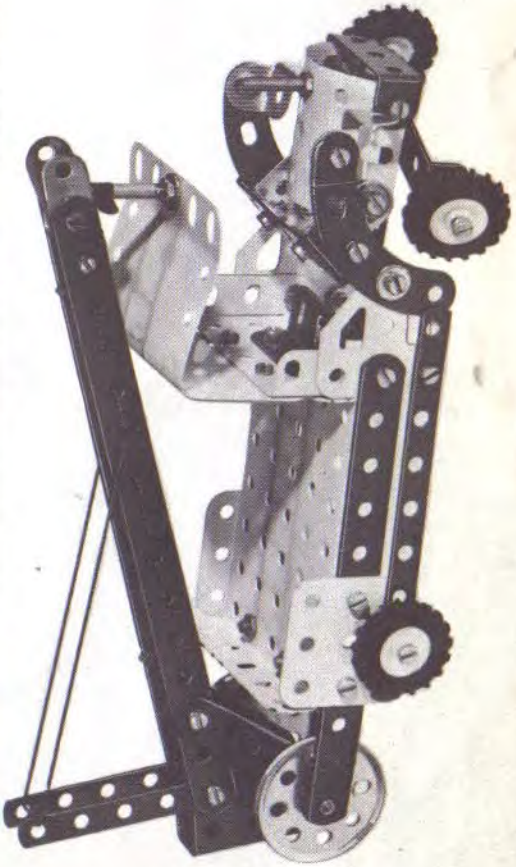
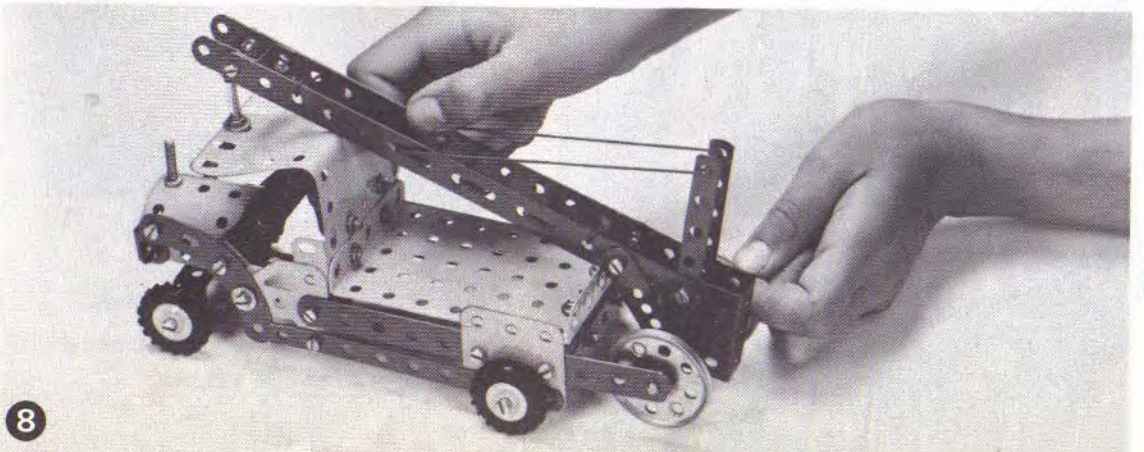
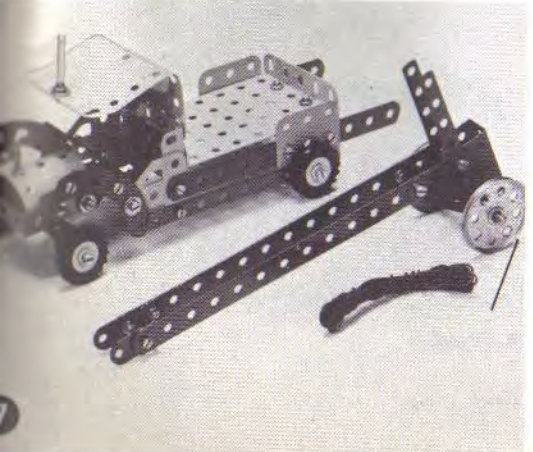
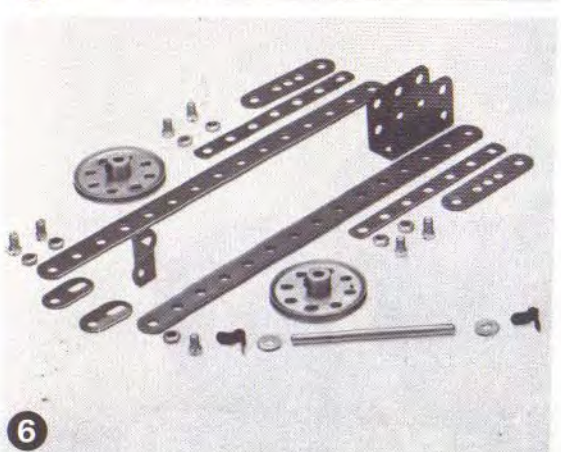
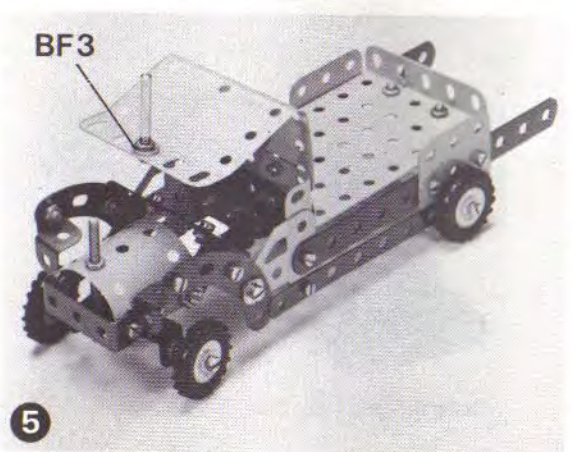
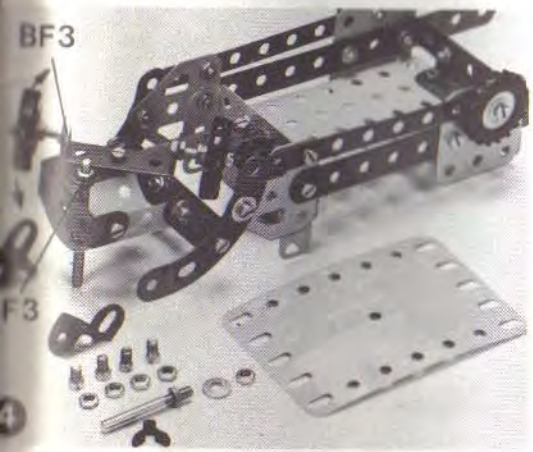
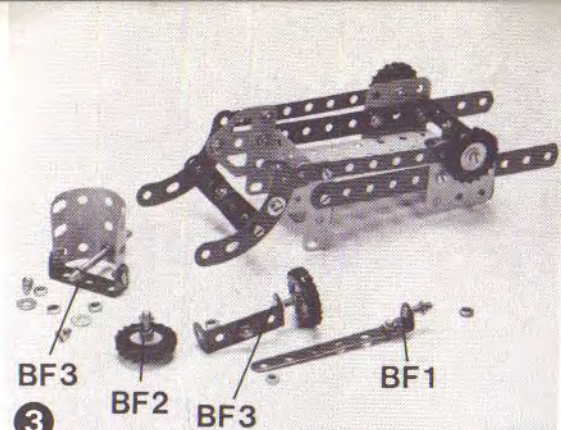
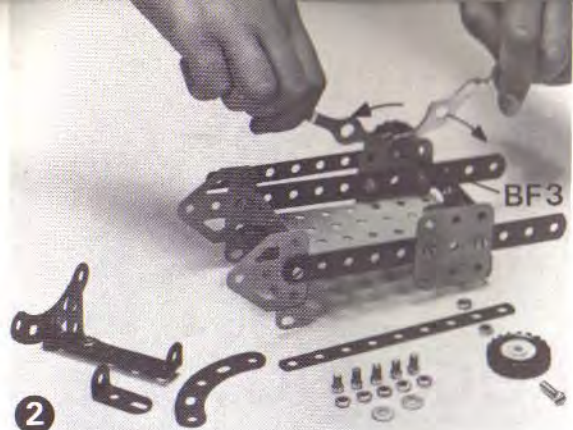
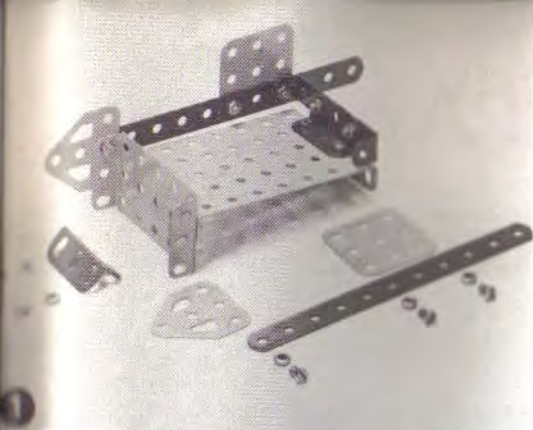

# The Combat, Crane, Highway and Army sets. They're a little bit special, but every bit Meccano!



Three models from the "Army" set.

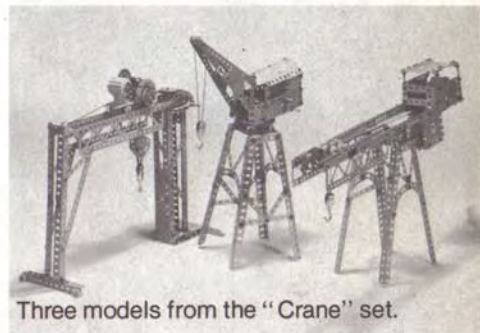

Three models from the "Crane" set.



Three models from the "Highway" set.



Three models from the "Combat" set.

© 1978 Meccano Ltd. Binns Road, Liverpool L13 1DA, England

MADE BY **MECCANO** ENGLAND



PRINTED IN  
ENGLAND  
160045