

1

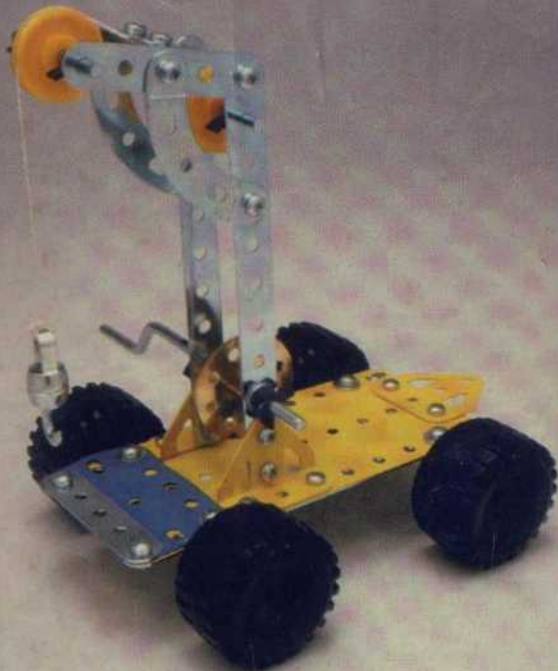

MECCANO

Introduction book
Manuel d'introduction
Handleiding
Einleitungsbuch
Manuale d'istruzioni
Manual de introducción

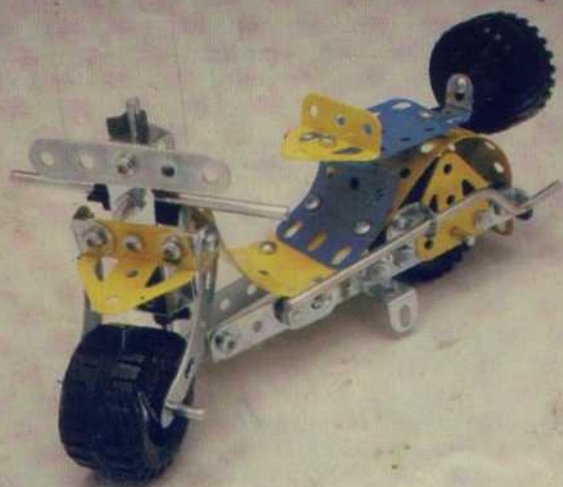



How to succeed with MECCANO...

- A - Discover the "MECCANO SYSTEM" by constructing your first model.**
- To help you:
 - Page I: how to use the instruction booklets.
 - Page IV: close-ups of some of the main models.
 - Choose your first detailed model from box number 1.
 - Construct this model by following the simple computer generated instructions.
 - Your model is now complete: WELL DONE.
 - Choose another model...
- B - Create your own models without the help of the computer.**
- Choose from amongst the models pictured in pages 6 to 20 of instruction book 1.
 - You want to build more complicated models?
 - Progress with the MECCANO range of boxes see pages 18 & 19 of instruction book 1.
- C - Create your own models.**
- The spare parts necessary to complete your "MECCANO SYSTEM" can be found on pages V, VI, VII and VIII.



Zo lukt het met MECCANO...

- A - Ontdek het "MECCANO-SYSTEM" door je eerste model te bouwen.**
- Om je te helpen:
 - blz. I: hoe de bouwaanwijzingen te lezen.
 - blz. IV: grote tekeningen van een paar belangrijke bouw-elementen.
 - Kies je eerste lesmodel uit doos nr. 1.
 - Monteer dit model in de volgorde zoals door de computer is aangegeven.
 - Je model is gereed: MOOI ZO.
 - Kies het volgende model...
- B - Zet je eigen modellen in elkaar zonder hulp van de computer.**
- Kies uit de gefotografeerde modellen: blz. 6 en 20, aanwijzing 1.
 - Wil je wat meer ingewikkelde modellen bouwen?
 - Breid je MECCANO-assortiment uit blz. 18 en 19, aanwijzing 1.
- C - Ontwerp je eigen modellen.**
- Je kunt je materiaal aanvullen met de gewenste "MECCANO-SYSTEM" onderdelen, blz. V, VI, VII, VIII.



Comment réussir en MECCANO...

- A - Découvre le "MECCANO SYSTEM" en construisant ton premier modèle.**
- Pour t'aider:
 - Page I: comment utiliser les notices d'assemblages.
 - Page IV: gros plans sur quelques assemblages essentiels.
 - Choisis ton premier modèle détaillé de la boîte numéro 1.
 - Monte ce modèle en suivant les étapes simples suggérées par l'ordinateur.
 - Ton modèle est monté: BRAVO.
 - Choisis un autre modèle...
- B - Réalise tes constructions personnelles sans l'aide de l'ordinateur.**
- Choisis parmi les photos des modèles proposés: pages 6 à 20, notice 1.
 - Tu veux réaliser des modèles plus complexes?
 - Progresse avec la gamme de boîtes MECCANO pages 18 et 19, notice 1.
- C - Crée tes propres modèles.**
- Tu peux compléter ton jeu en te procurant les pièces détachées nécessaires "MECCANO SYSTEM" pages V, VI, VII et VIII.



Come avere successo col MECCANO...

- A - Scopri il "SISTEMA MECCANO" costruendo il tuo primo modello.**
- Per aiutarti:
 - Pagina I: come utilizzare i manuali d'istruzioni MECCANO.
 - Pagina IV: grandi piani di montaggio su alcuni assemblaggi essenziali.
 - Scegli il tuo primo modello dettagliato della scatola numero 1.
 - Costruisci questo modello seguendo le semplici fasi suggerite dal computer.
 - Il tuo modello è costruito: BRAVISSIMO.
 - Scegli un altro modello...
- B - Costruisci i tuoi modelli personali senza l'aiuto del computer.**
- Scegli tra le illustrazioni dei modelli proposti: pagine 6 - 20, manuale d'istruzioni 1.
 - Desideri costruire dei modelli più complicati?
 - Progredisci con la gamma delle scatole MECCANO, pagine 18 - 19, manuale d'istruzioni 1.
- C - Realizza modelli di tua invenzione.**
- Puoi ingrandire e completare il tuo gioco procurandoti i pezzi staccati necessari "SISTEMA MECCANO" pagine V, VI, VII, VIII.



Wie man MECCANO einsetzt...

- A - Entdecke das "MECCANO-SYSTEM" beim Bauen deines ersten Modelles.**
- Um dir zu helfen:
 - Seite I: wie die Gebrauchsanweisungen zu befolgen sind.
 - Seite IV: grosser Bauplan für einige wichtige Konstruktionen.
 - Wähle dein erstes detailliertes Modell aus der Schachtel Nr. 1.
 - Montiere dieses Modell gemäss den einfachen Etappen, die der Computer vorschlägt.
 - Dein Modell ist fertig: BRAVO.
 - Wähle ein anderes Modell.
- B - Verwirkliche deine persönlichen Konstruktionen ohne Hilfe des Computers.**
- Wähle aus den Fotos der vorgeschlagenen Modelle: Seite 6 + 20, Notiz 1.
 - Willst Du schwierigere Modelle bauen?
 - Folge der Reihe der MECCANO-SCHACHTELN, Seite 18 + 19, Notiz 1.
- C - Erfinde deine eigenen Modelle.**
- Du kannst deine Möglichkeiten erweitern, wenn du dir die notwendigen Einzelteile beschaffst. "MECCANO SYSTEM", Seiten V, VI, VII, VIII.



Cómo salir airoso con MECCANO...

- A - Descubre el "MECCANO-SYSTEM" construyendo tu primer modelo.**
- Para ayudarte:
 - Página I: cómo utilizar las instrucciones o folletos para armar.
 - Página IV: primeros planos de algunos montajes esenciales.
 - Escoge tu primer modelo detallado de la caja Número 1.
 - Monta este modelo siguiendo las etapas sencillas sugeridas por el ordenador.
 - Tu Modelo está montado: ¡BRAVO!
 - Escoge otro modelo...
- B - Realiza tus propias construcciones o montajes sin la ayuda del ordenador.**
- Escoge entre las fotos de modelos propuestos: pag. 6 y 20, folleto 1.
 - ¿Quieres realizar modelos mas complejos?
 - Sigue progresando con la gama de cajas MECCANO pag. 18 y 19, folleto 1.
- C - Crea tus propios modelos.**
- Puedes completar tu juego haciendote con las piezas sueltas necesarias "MECCANO SYSTEM", pag. V, VI, VII, VIII.

 Suggestions for models to build yourself.

 Propositions de modèles pour constructions personnelles.

 Vorschläge für Modelle zum Selberbauen.

 Ideeën voor zelfbouw-modellen.

 Proposte di modelli per costruzioni personali.

 Propuestas de modelos para construcciones personales.

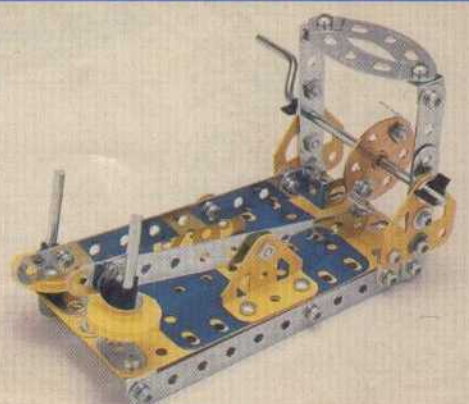
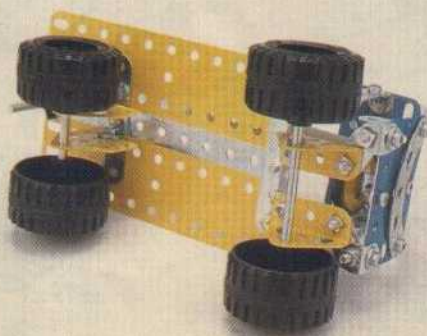
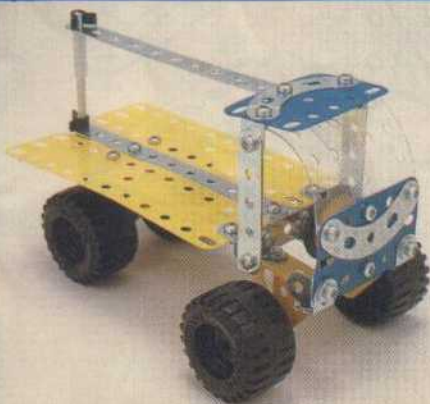
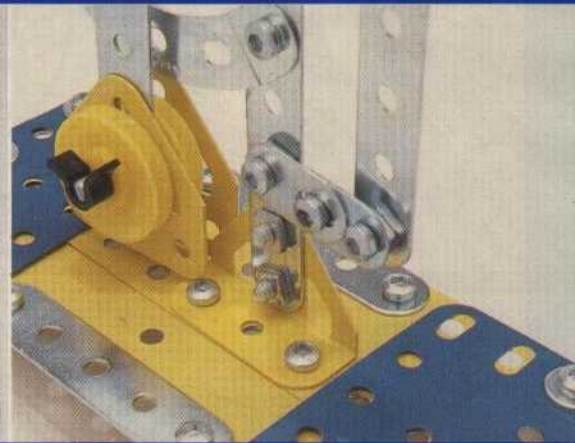
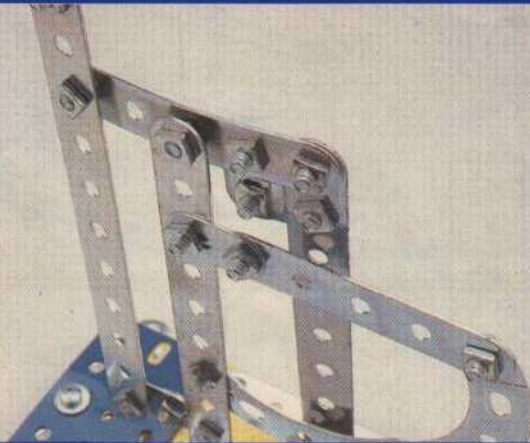
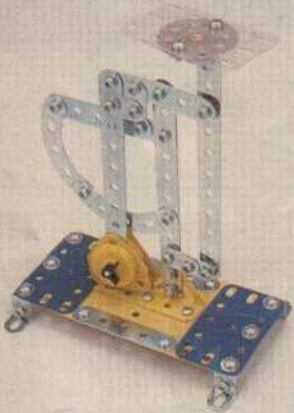
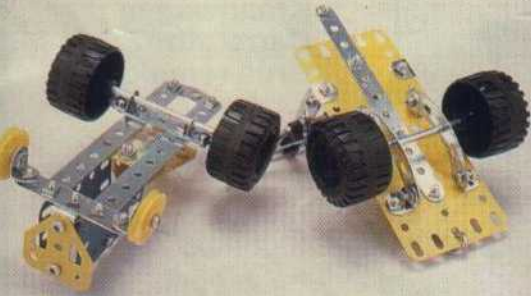
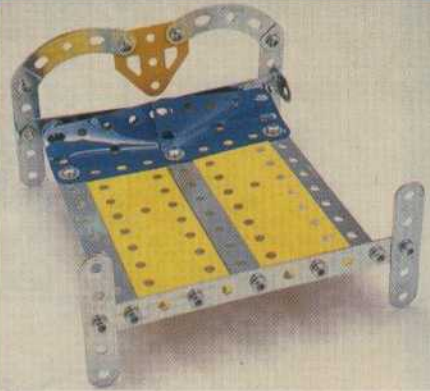

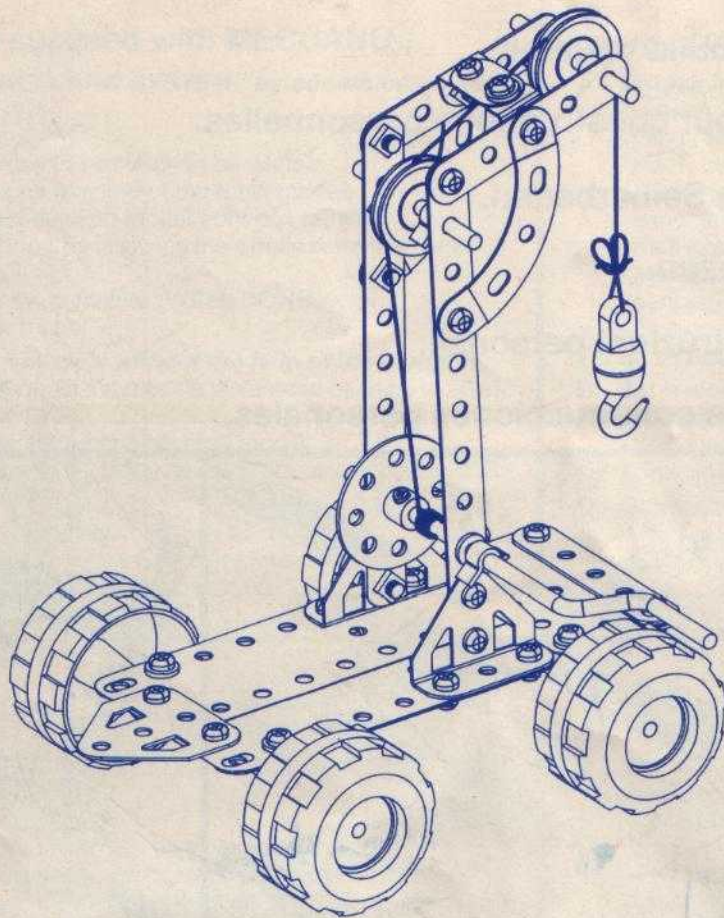

Breakdown lorry
 Dépanneuse
 Abschleppwagen
 Kraanwagen
 Carro attrezzi
 Grúa remolque

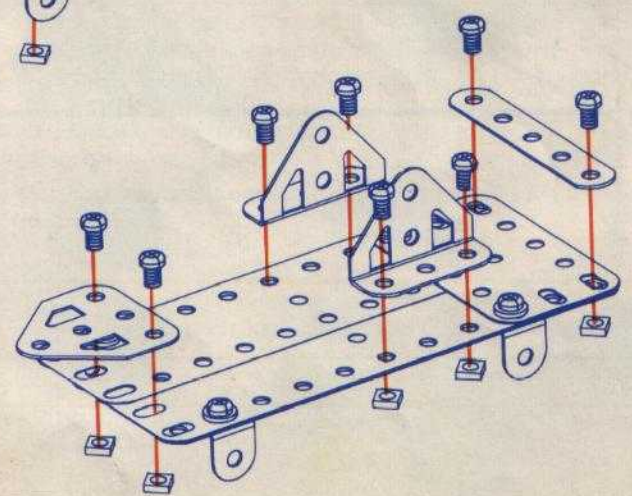
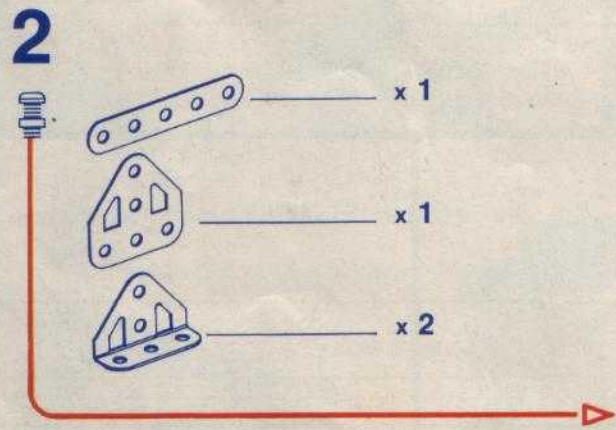
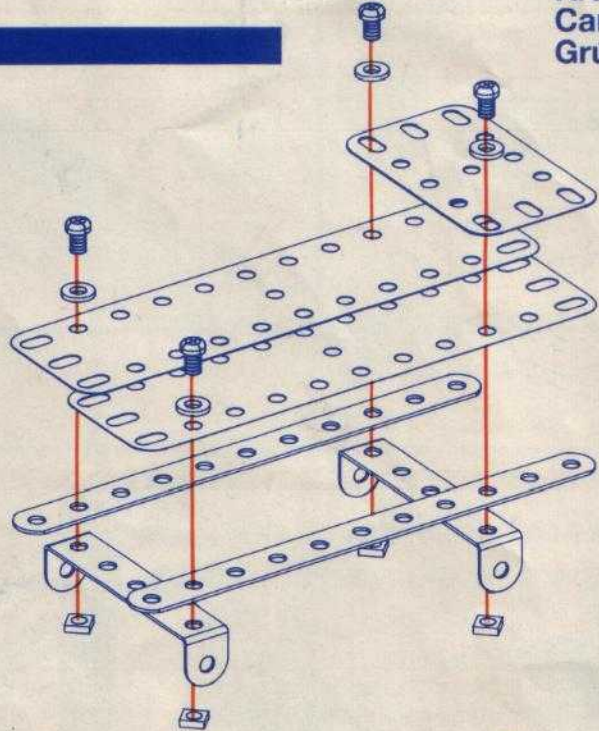
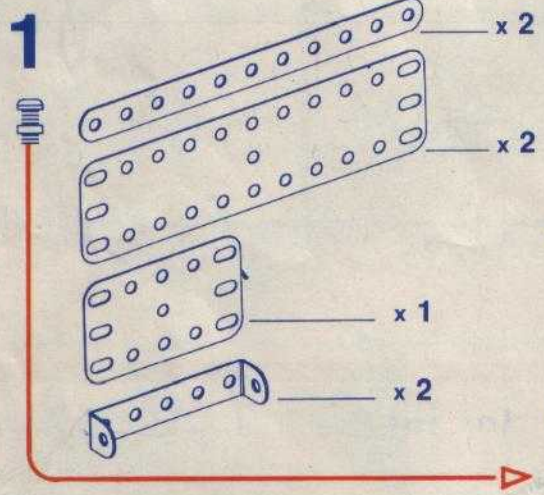

3

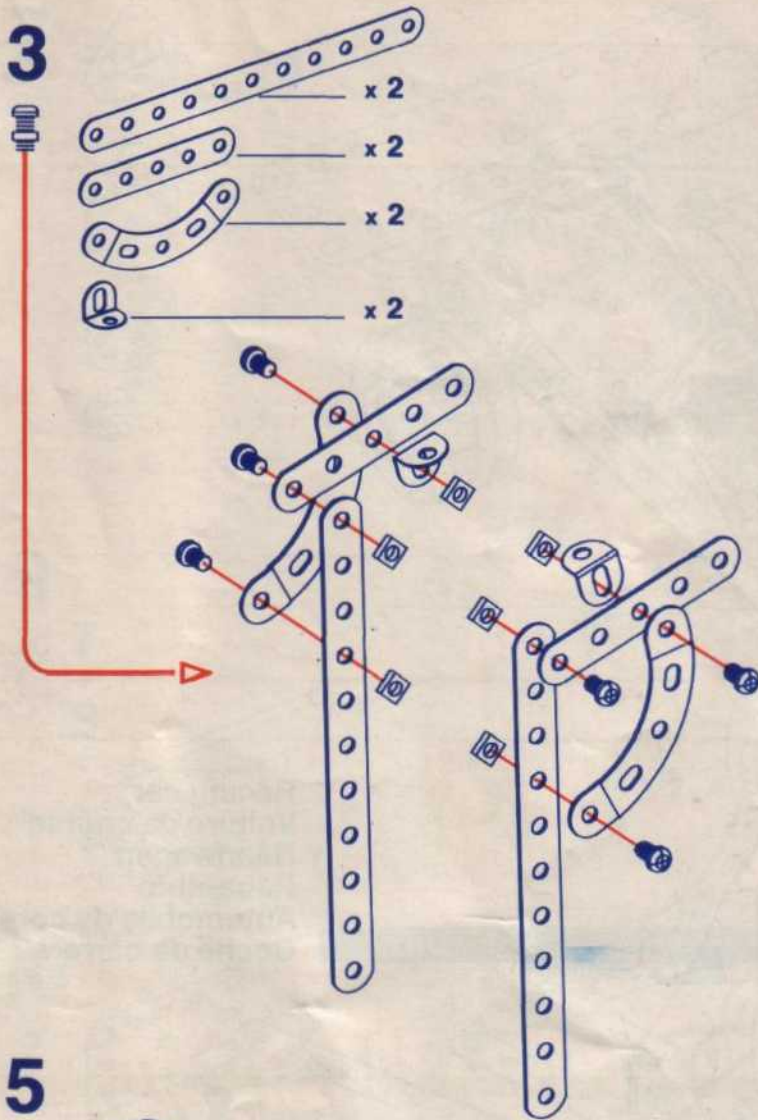

4

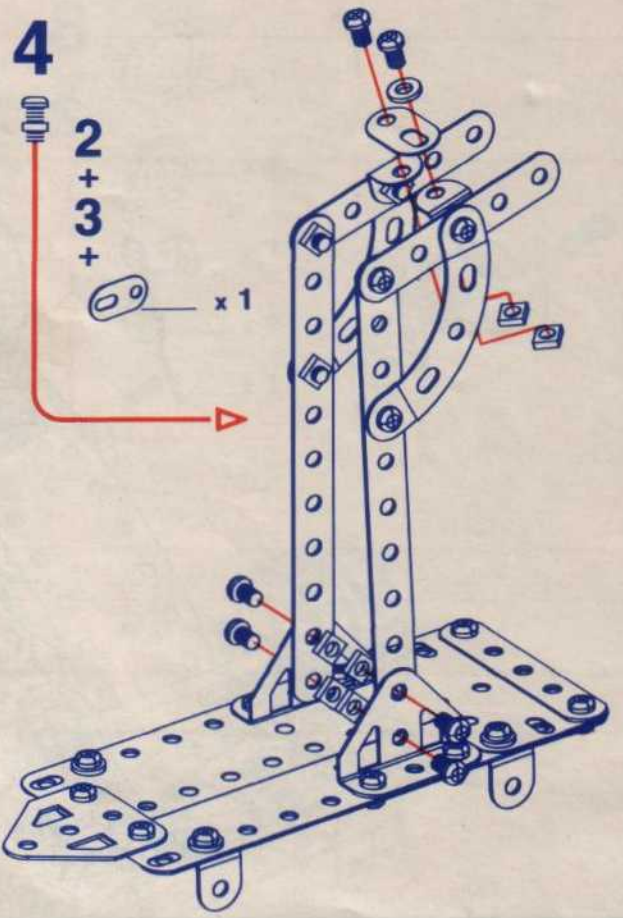

5

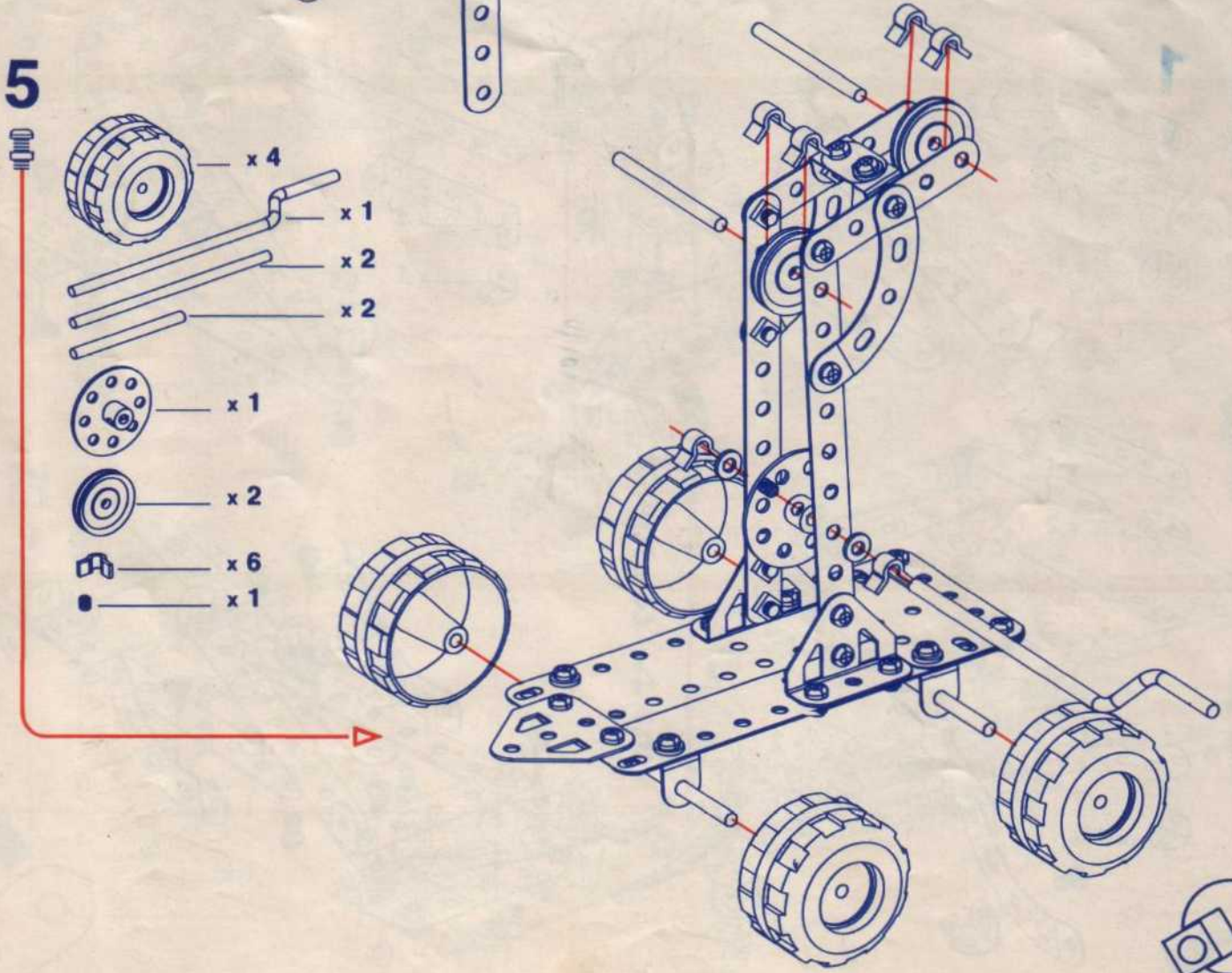

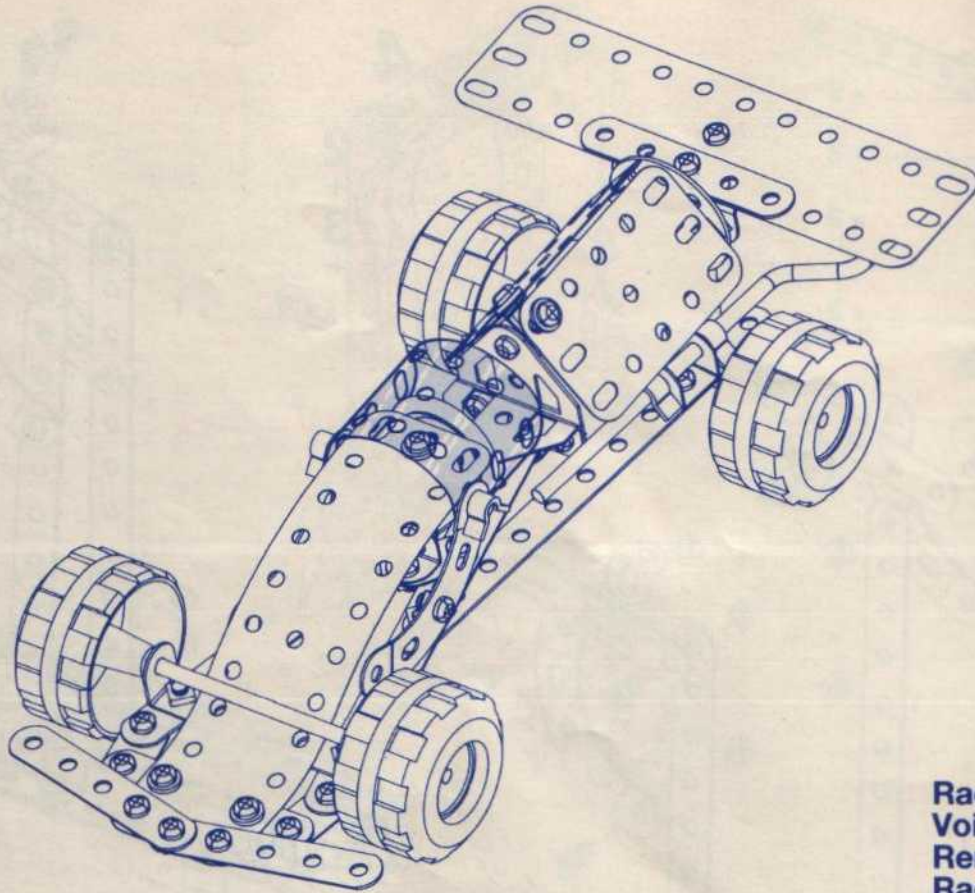

Racing car
Voiture de course
Rennwagen
Race-auto
Automobile da corsa
Coche de carreras

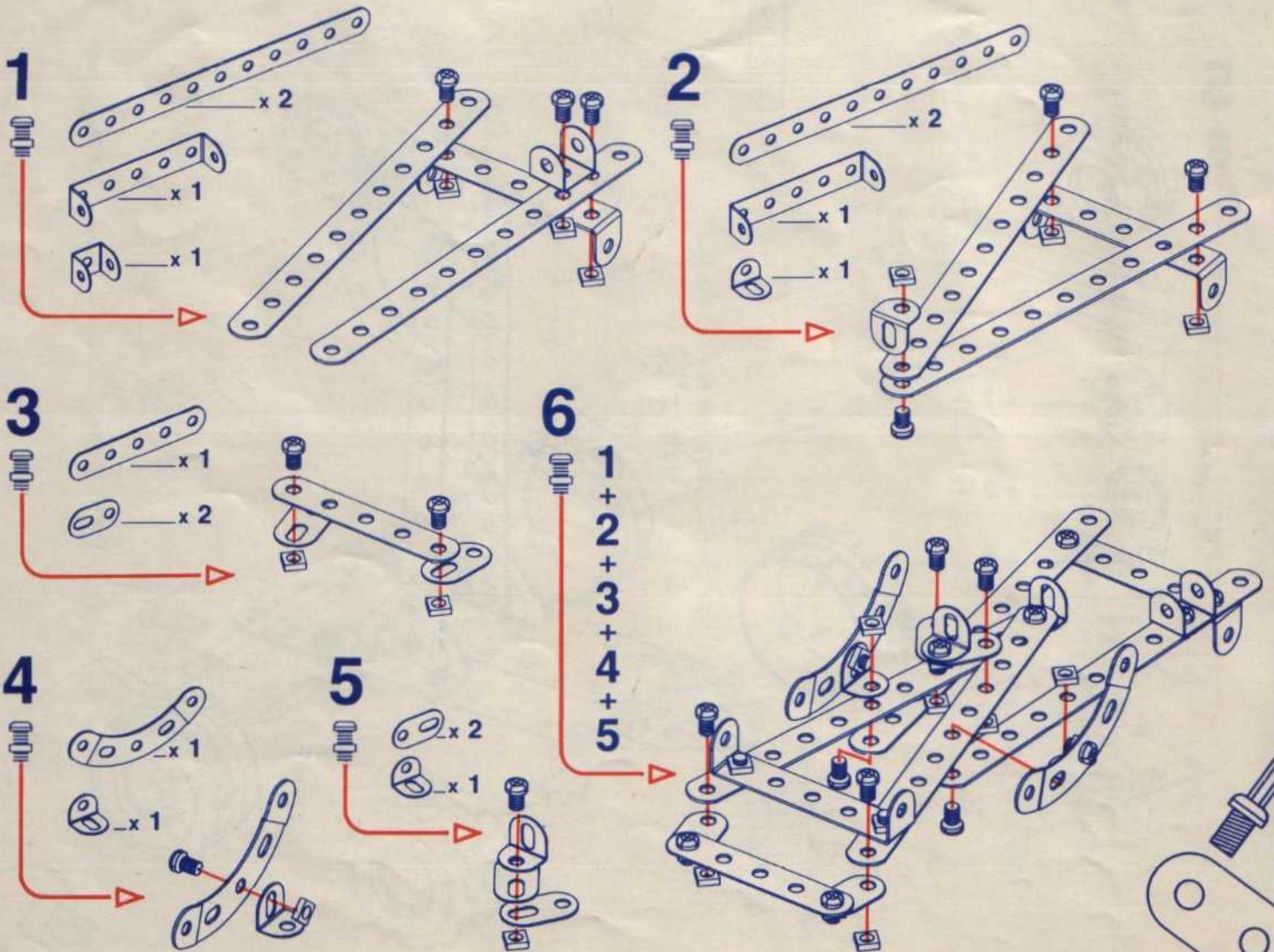

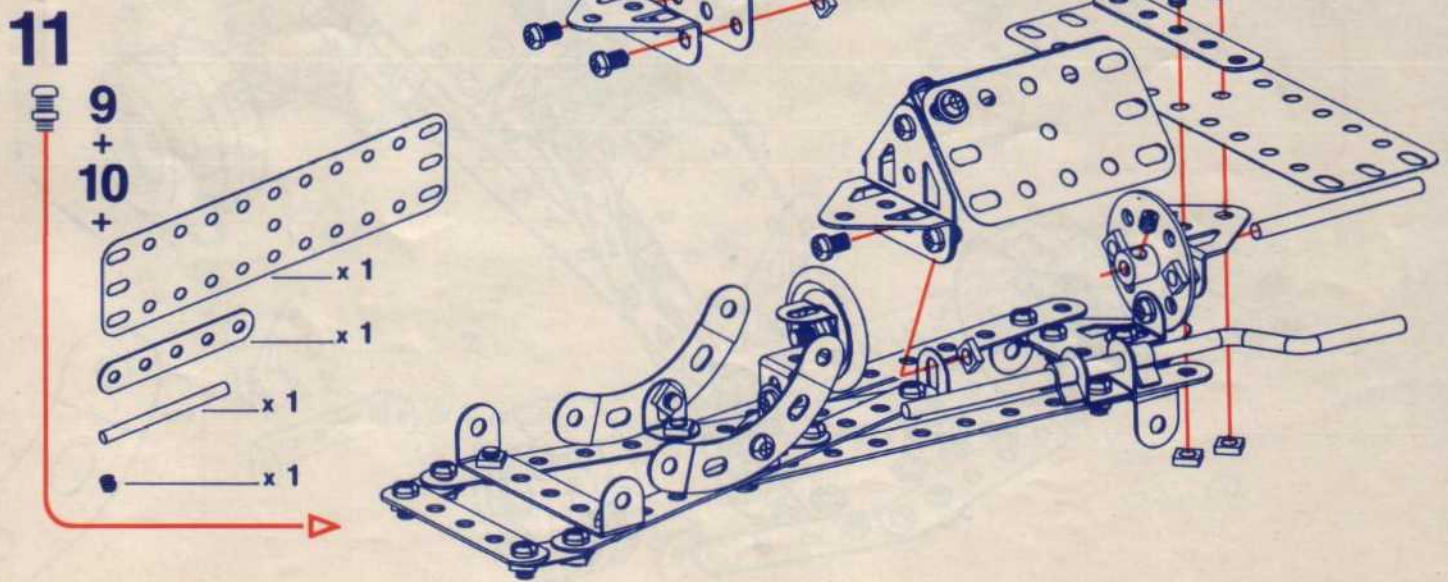
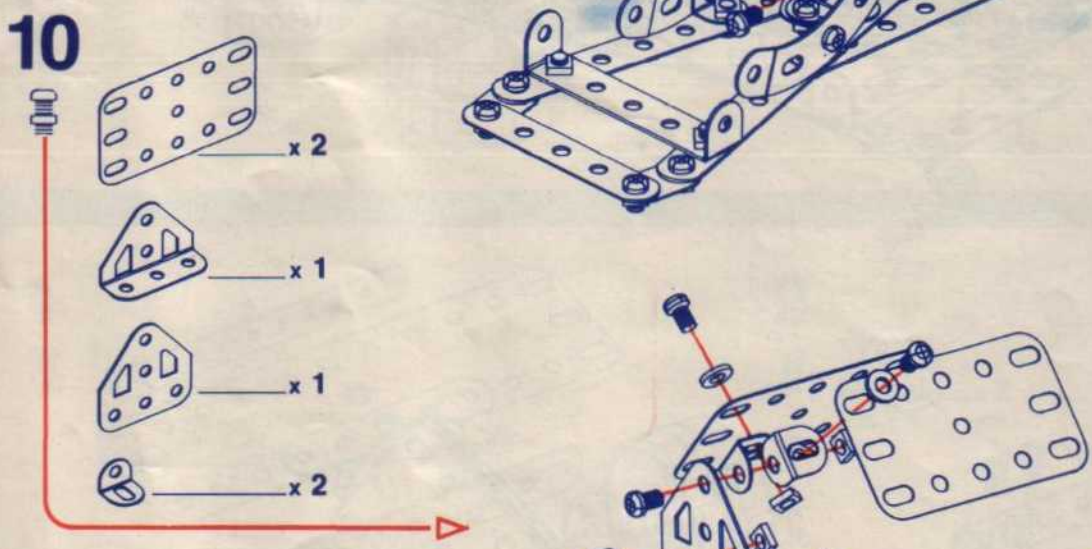
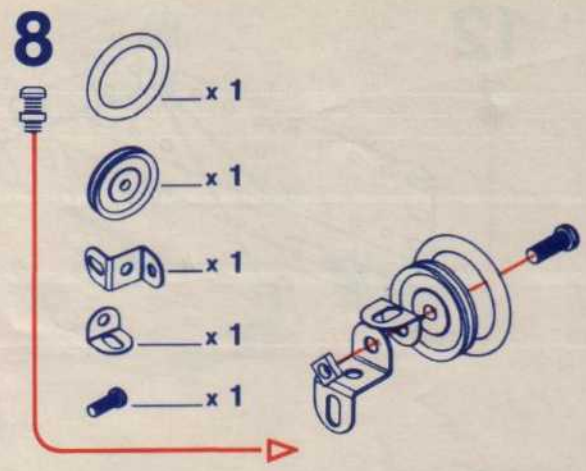
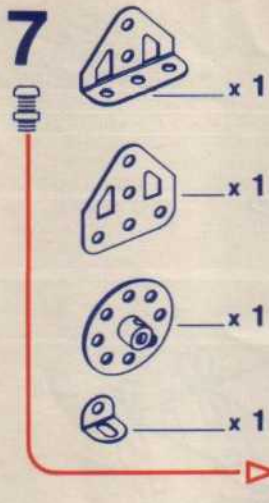

8
12

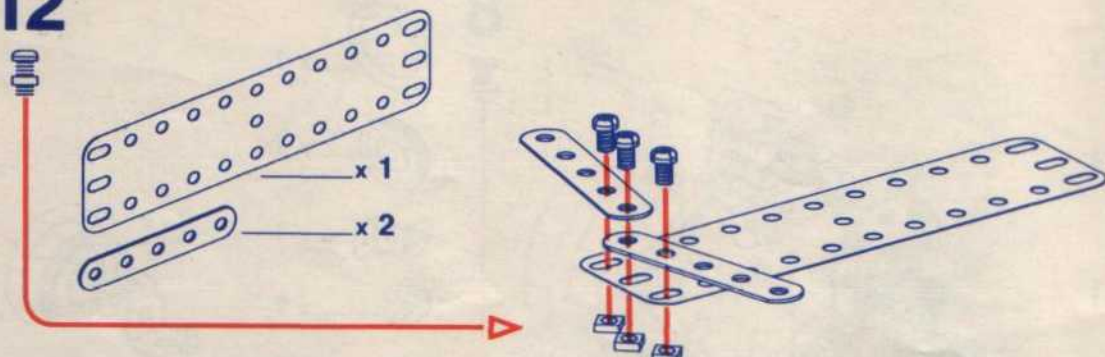

13

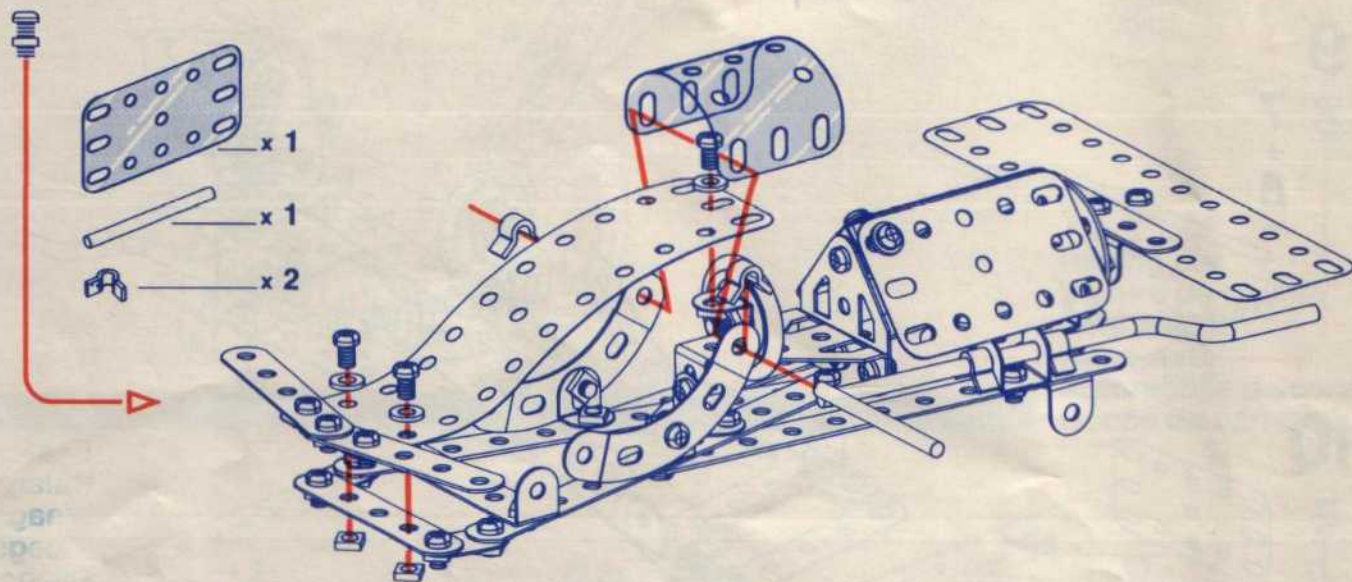

14

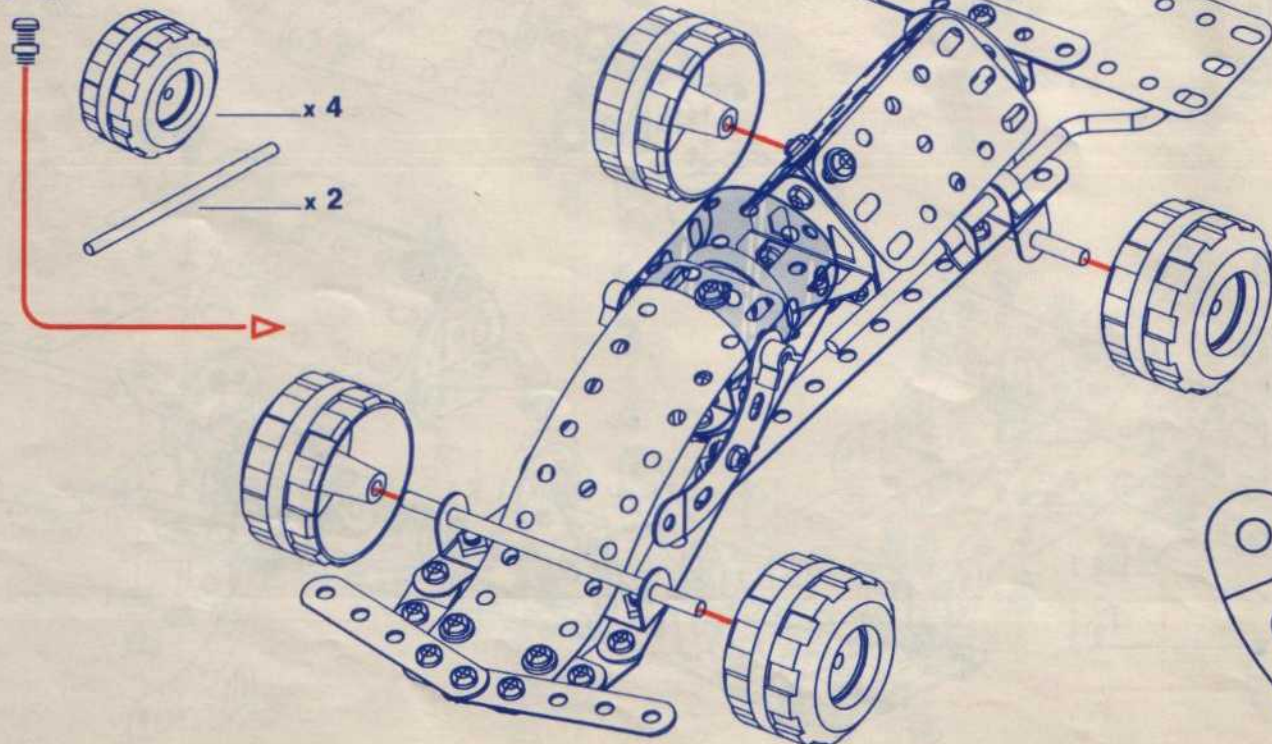

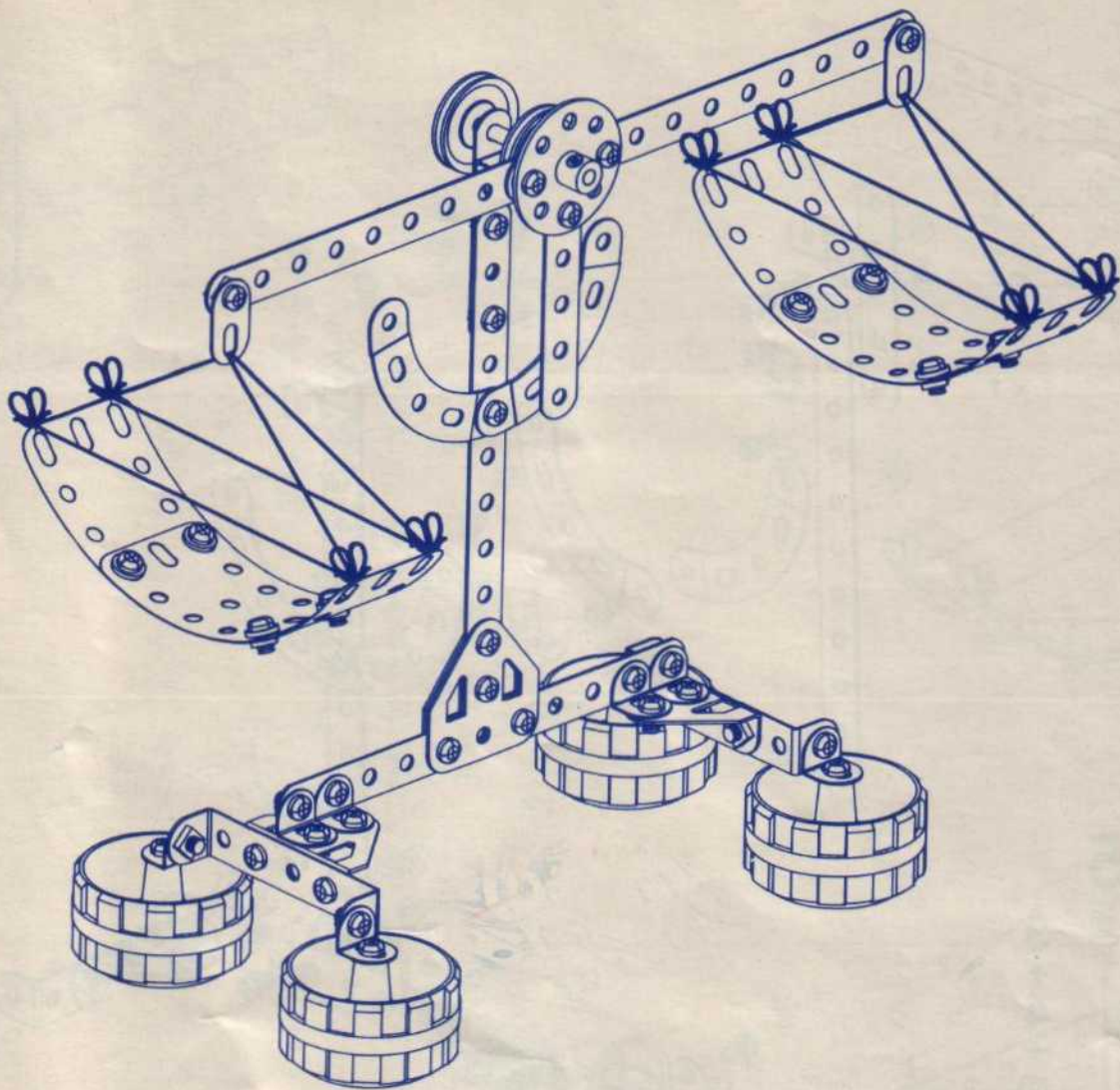



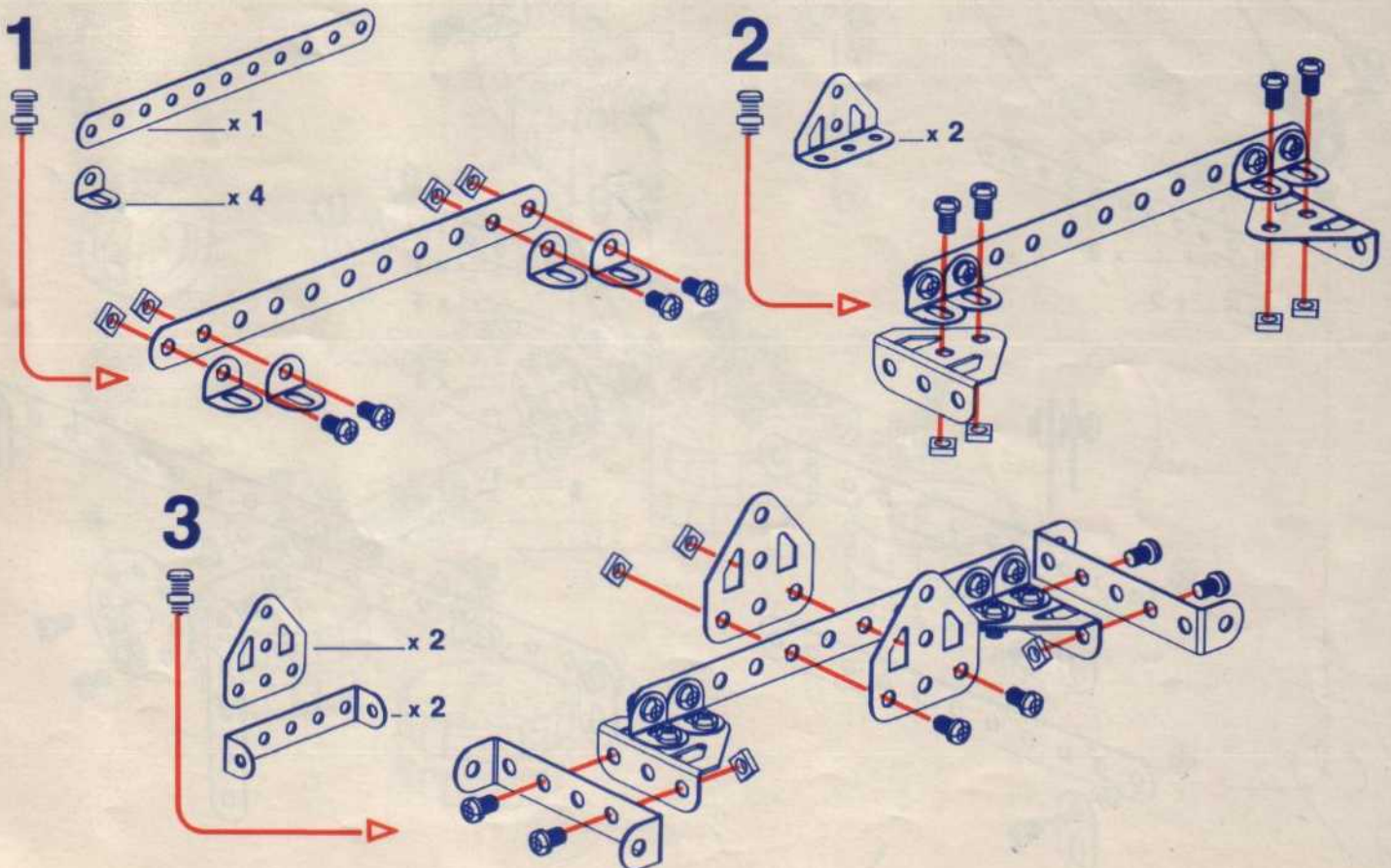

Scales
 Balance
 Waage
 Weegschaal
 Bilancia
 Bilanza

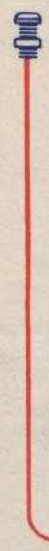

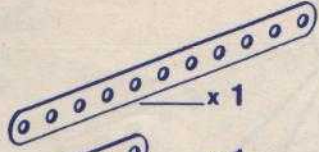
4



-  x 1
-  x 1
-  x 2
-  x 1

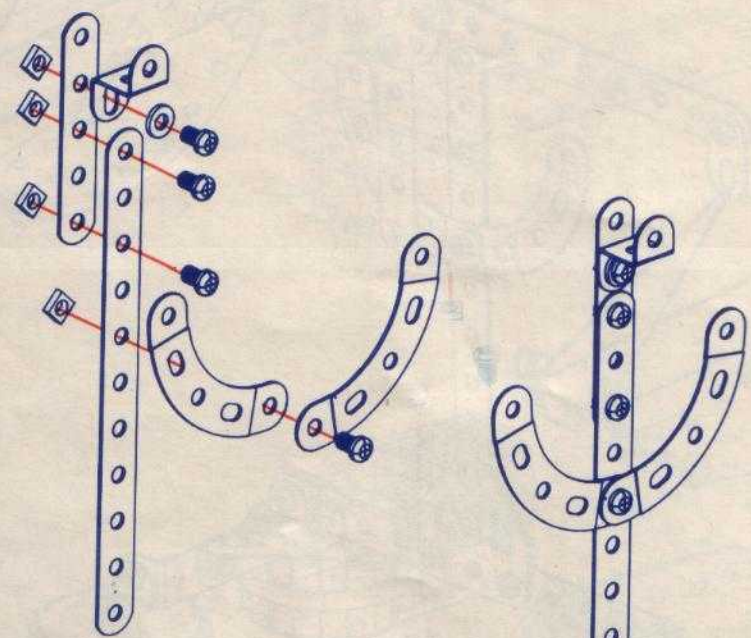

5



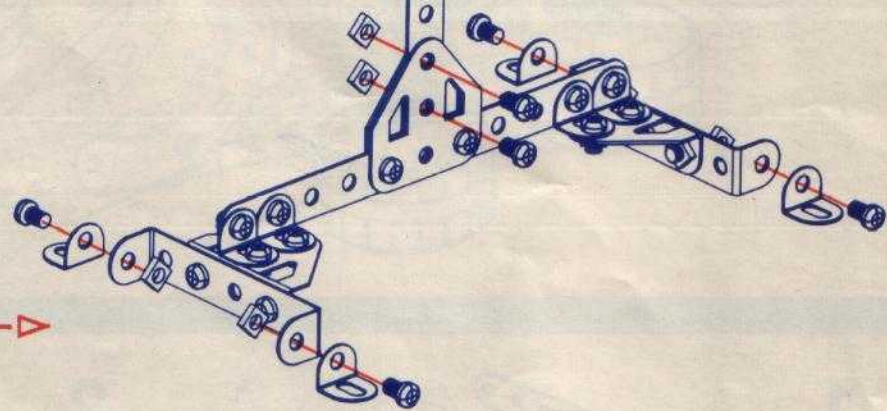

- 3
- +
- 4
- +
-  x 4



6

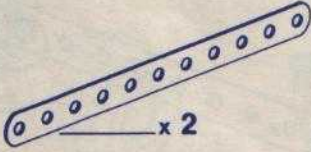



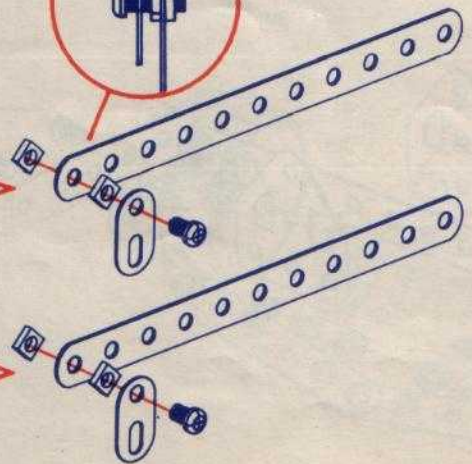
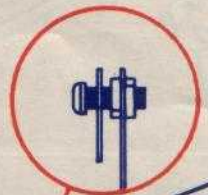

-  x 2
-  x 2

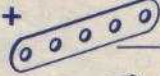

7



- 6
- +
-  x 1
-  x 1
-  x 1
-  x 1

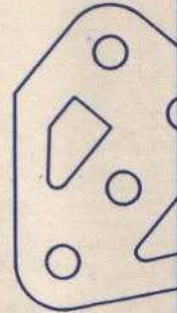
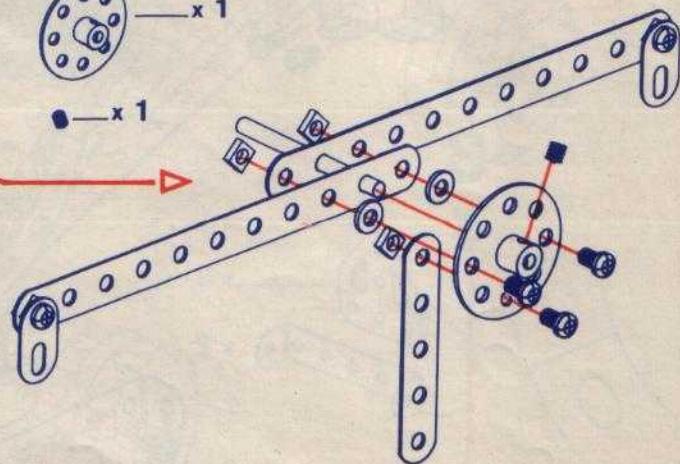

8

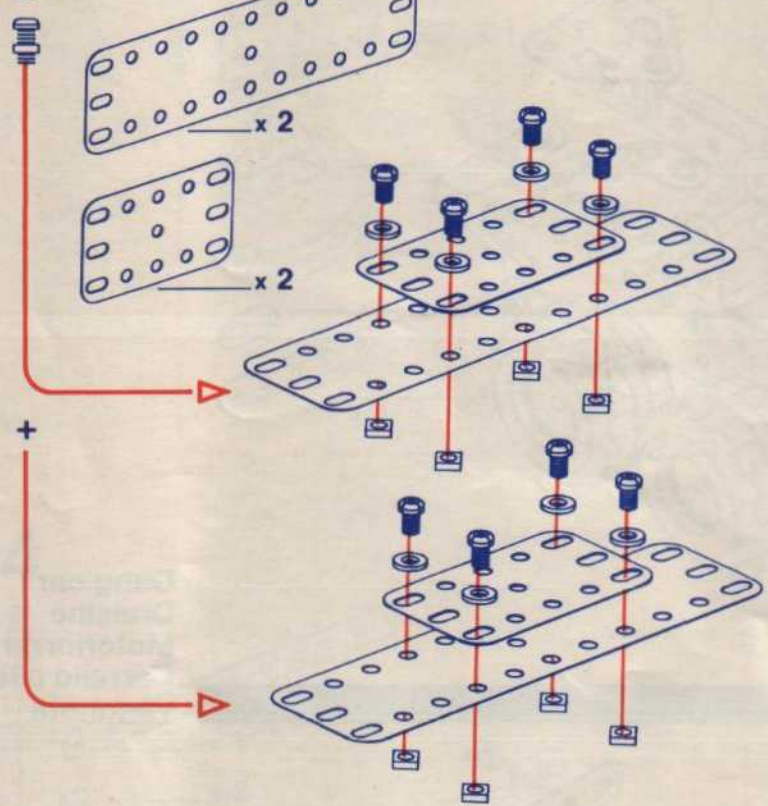

9

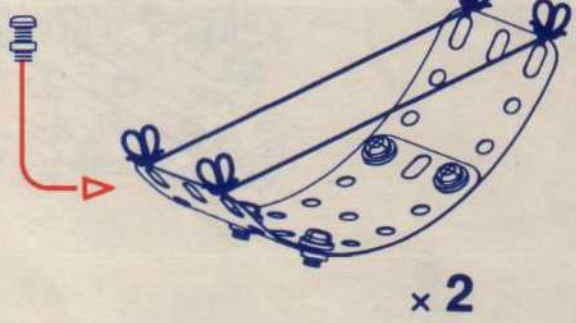

10

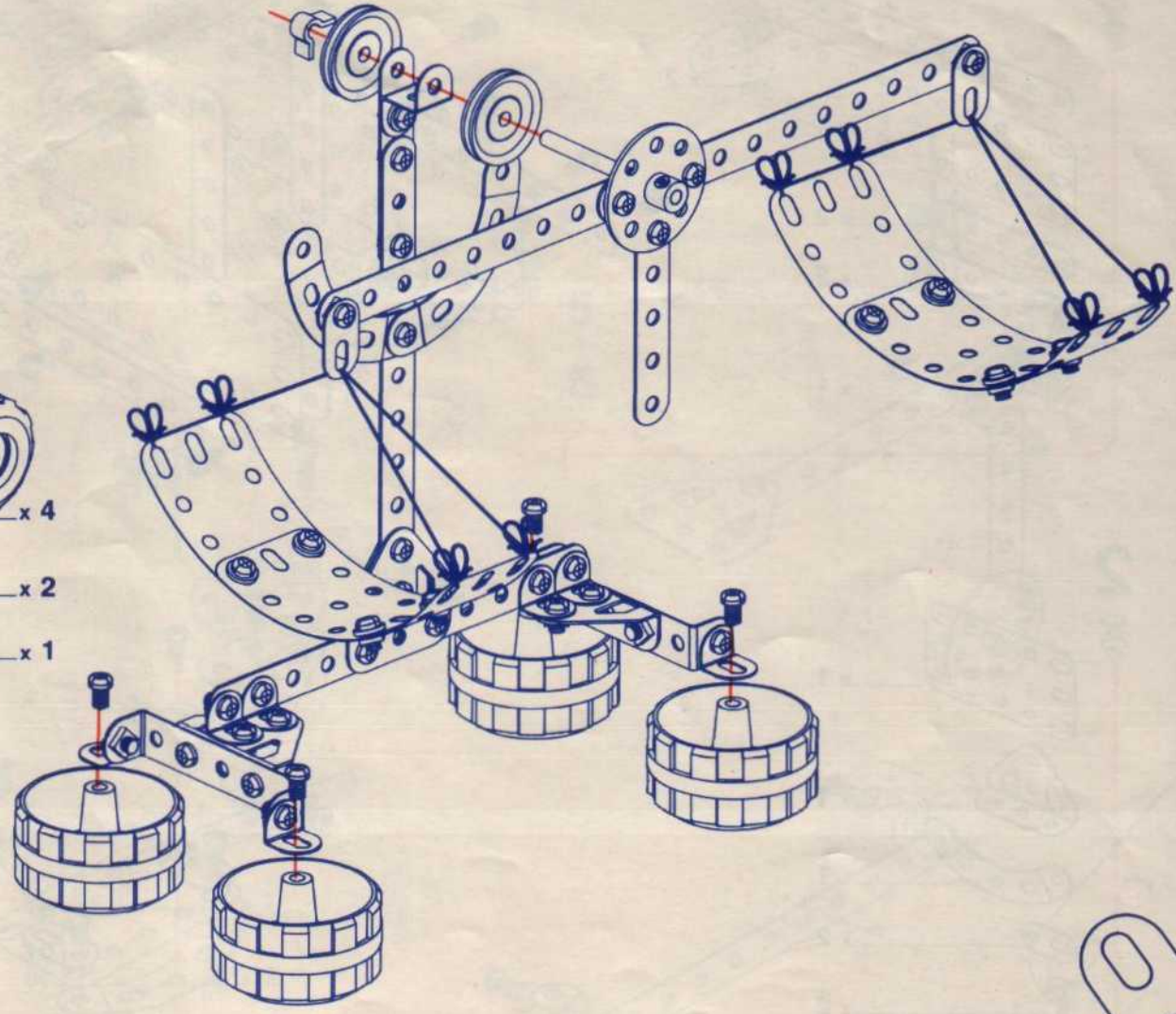
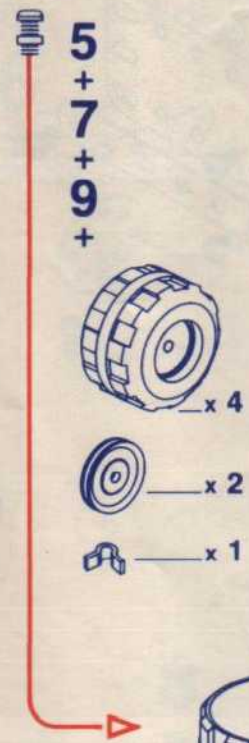

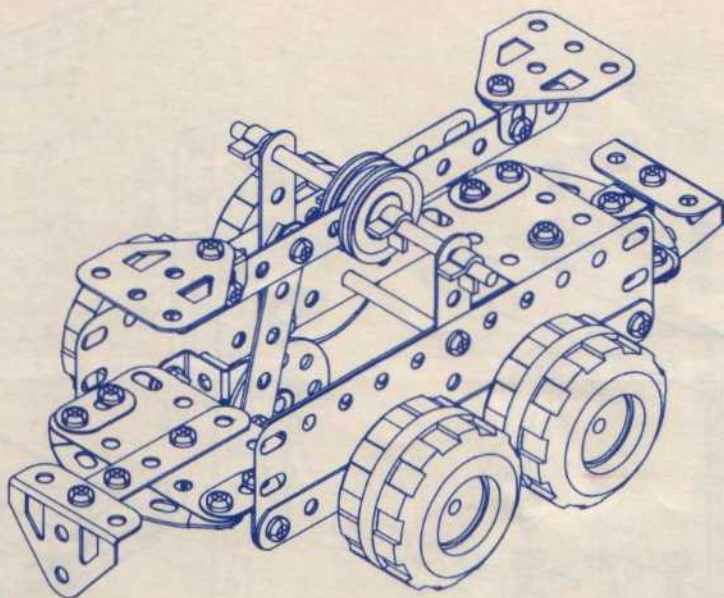



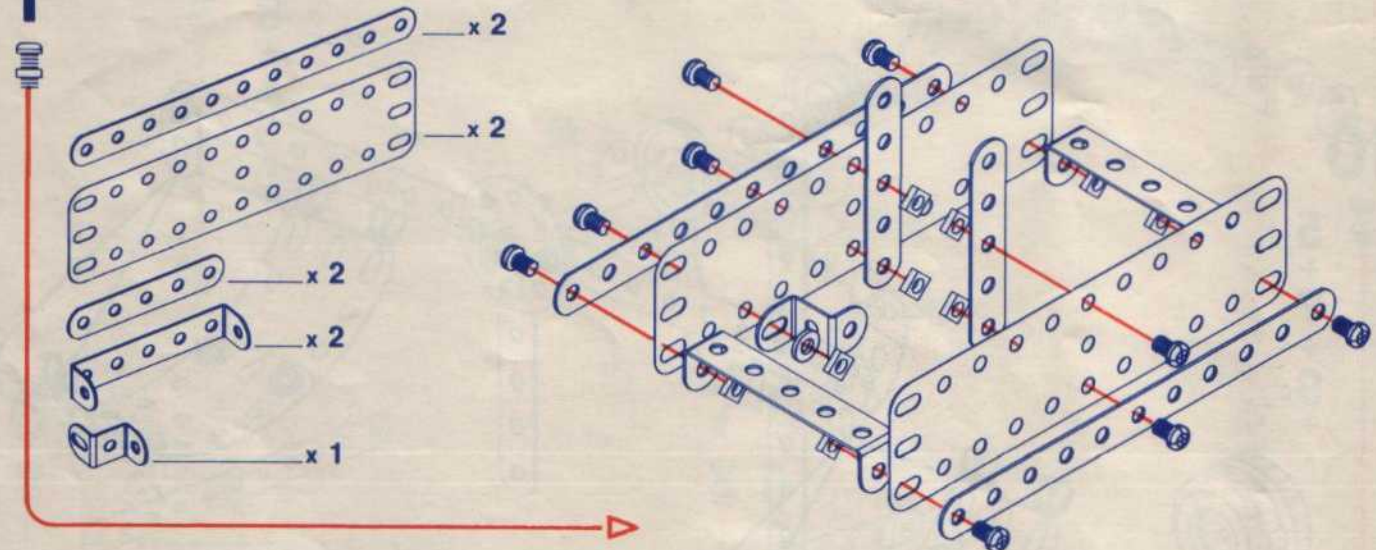

Gang car
 Draisine
 Motorlorrie
 Carrello a leva
 Vagoneta

1

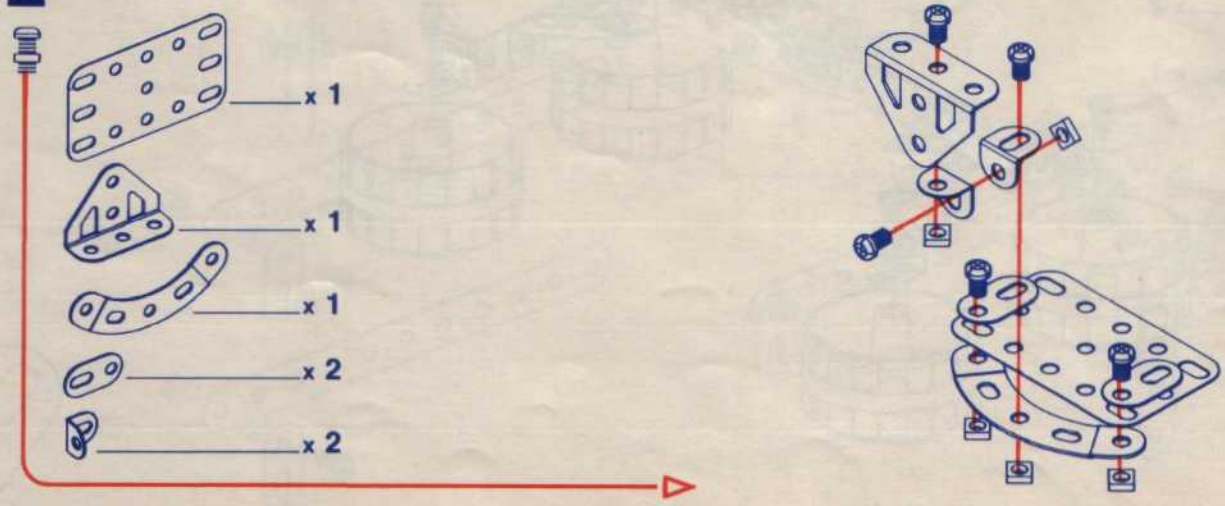

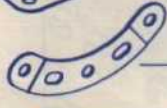

2



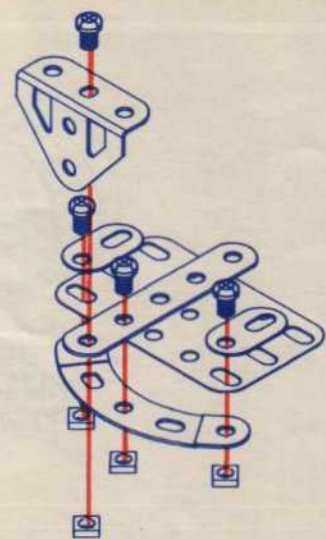

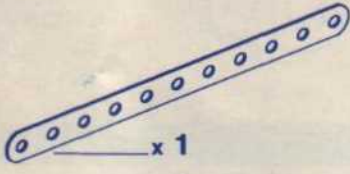
- 3**
-  x 1
 -  x 1
 -  x 1
 -  x 2
 -  x 1

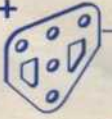

- 4**
-  x 1
 -  x 2

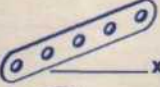
- 5**
- 4** +  x 2

- 6**
-  x 1
 -  x 1
 -  x 1

- 7**
- 5** + **6**

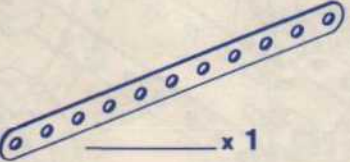
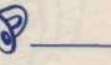
- 8**
-  x 1
 -  x 2

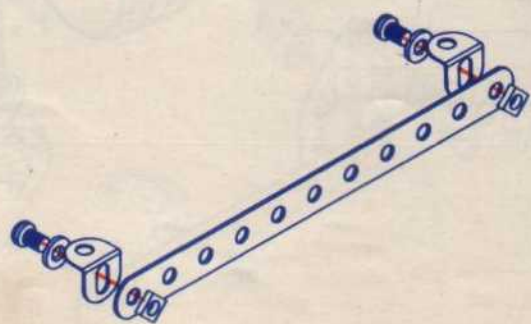

9



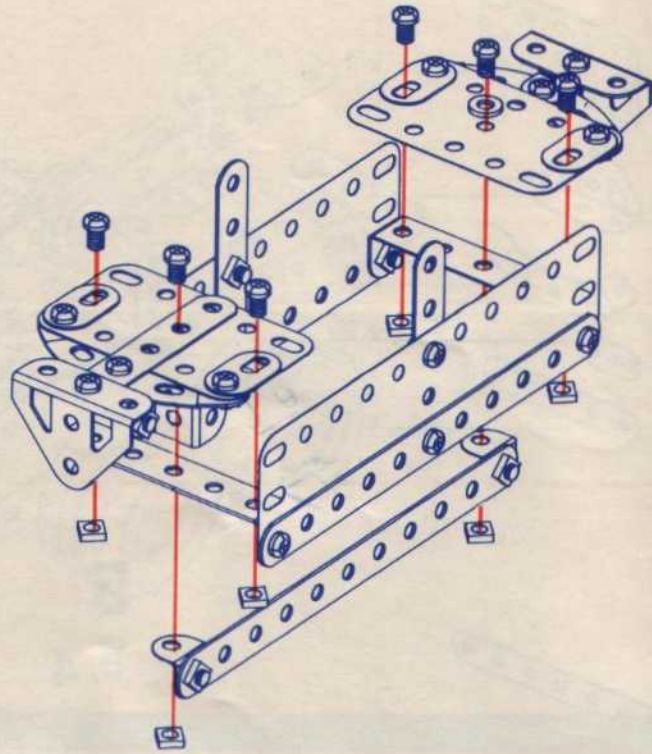
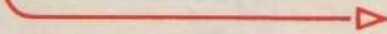

1
+
2
+
3
+
8



10



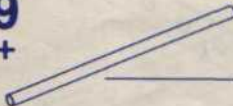

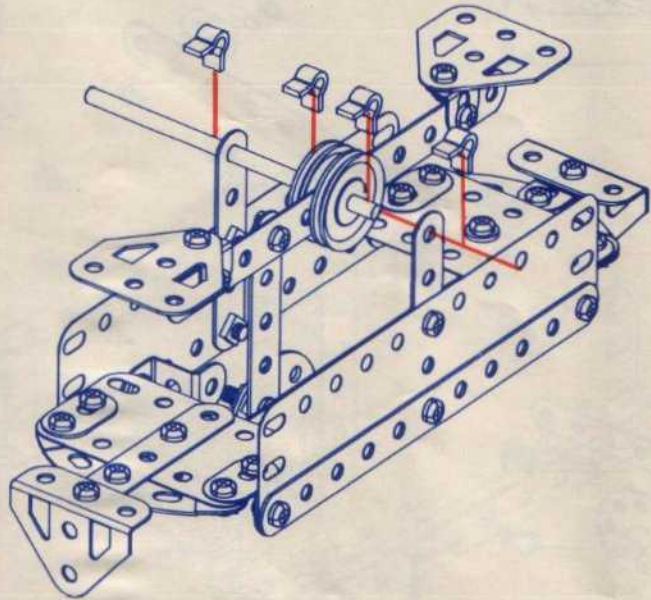
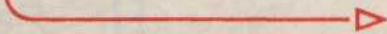

7
+
9
+

-  x 1
-  x 4
-  x 2



11



-  x 4
-  x 1
-  x 2
-  x 1
-  x 1

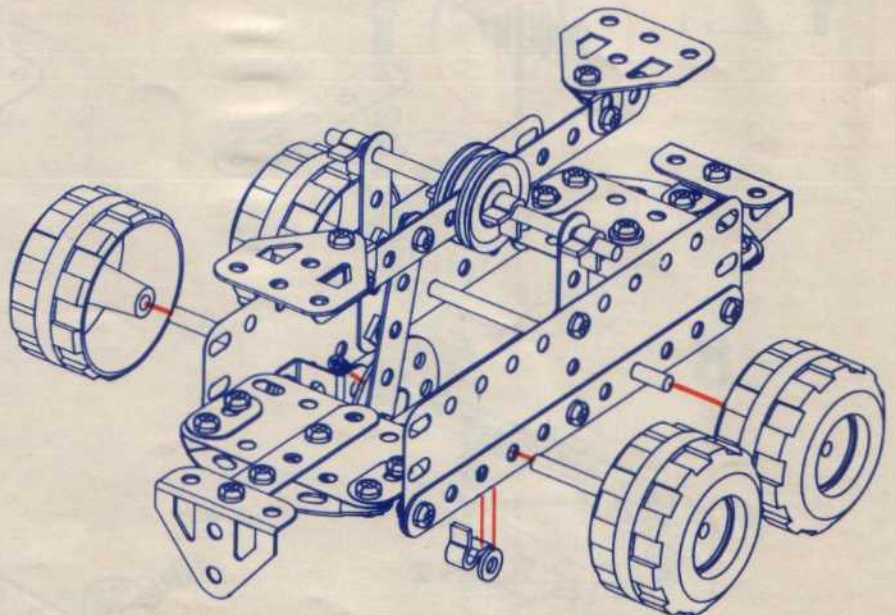

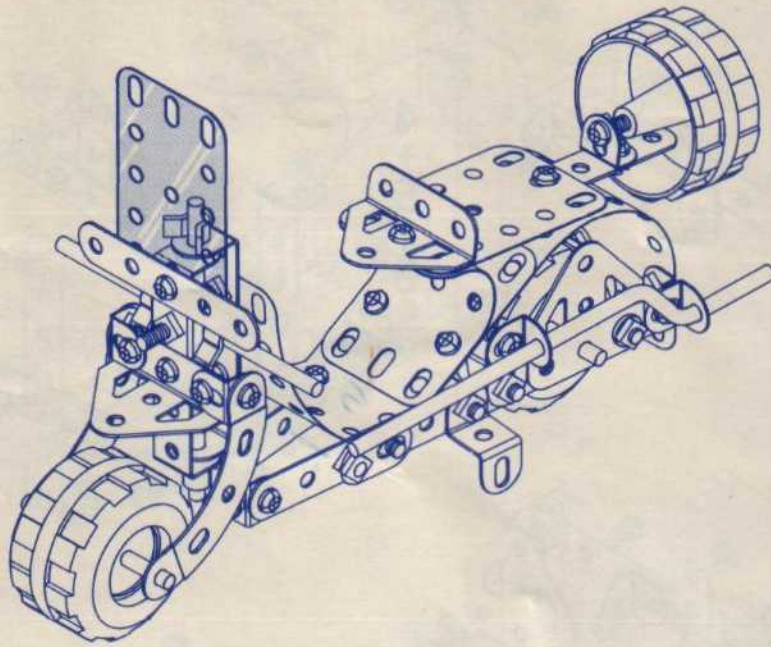

Scooter

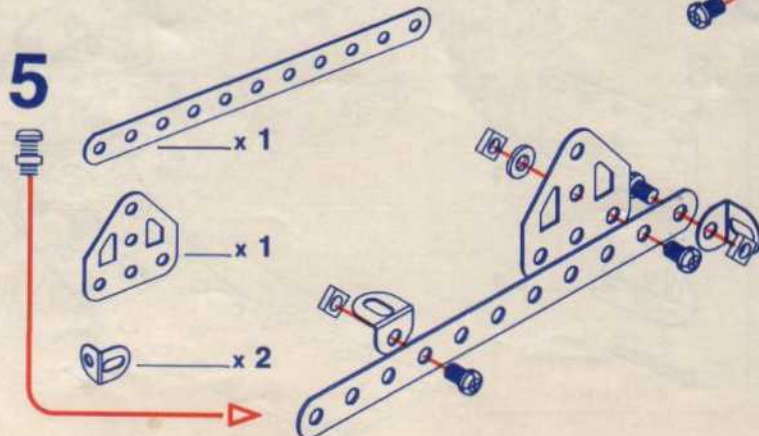
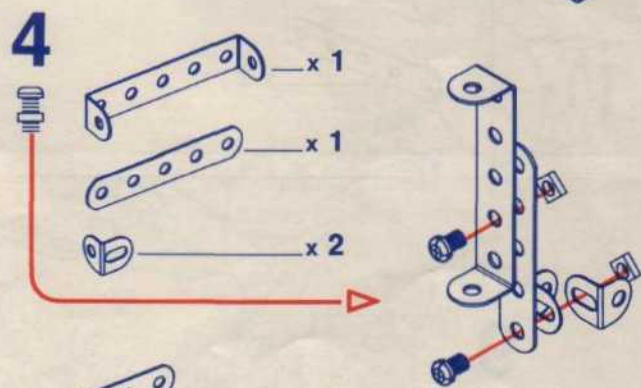
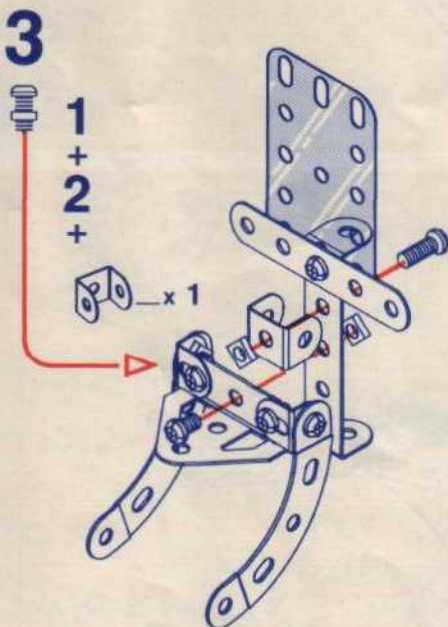
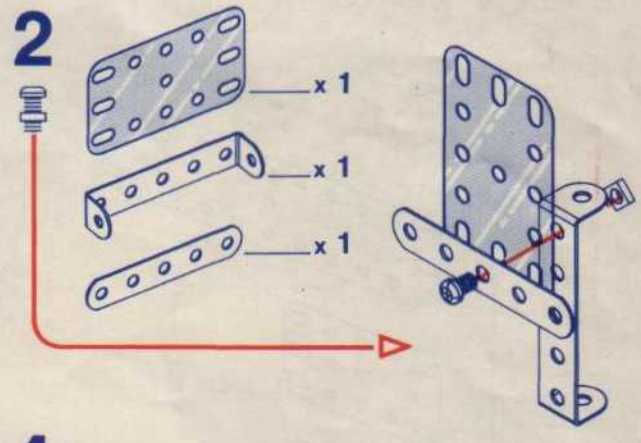
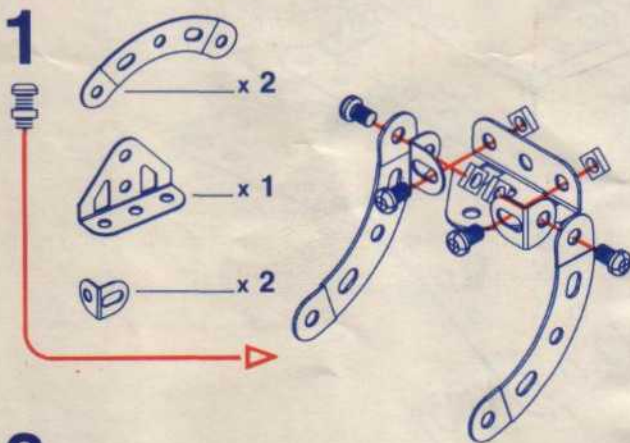

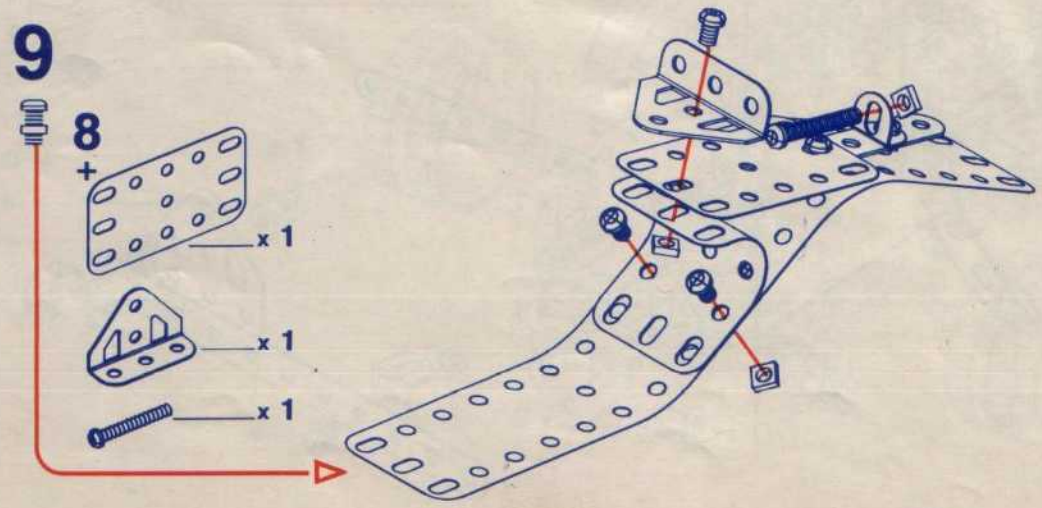
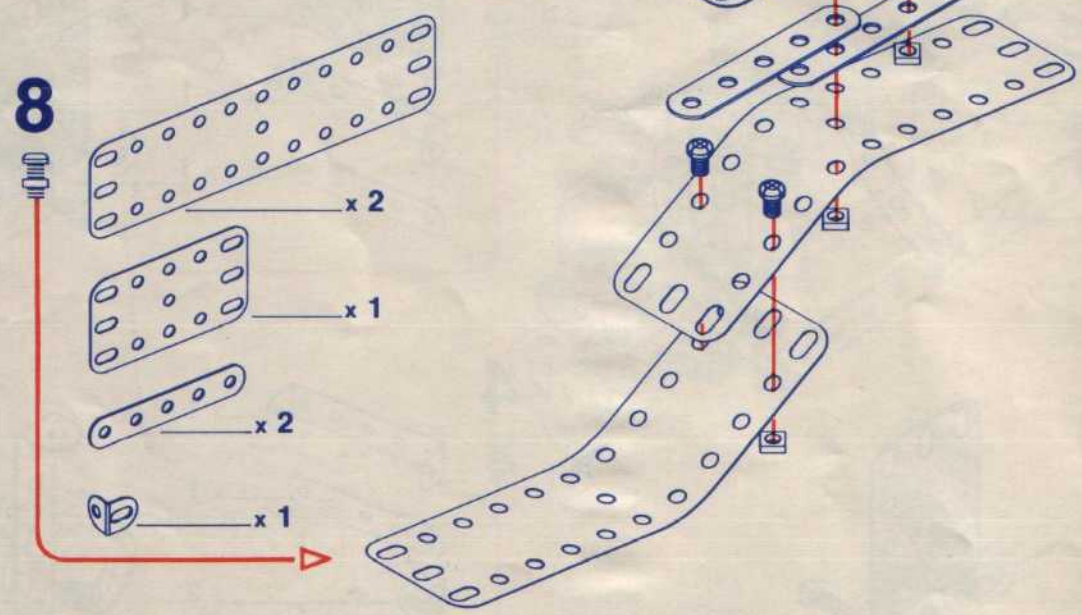
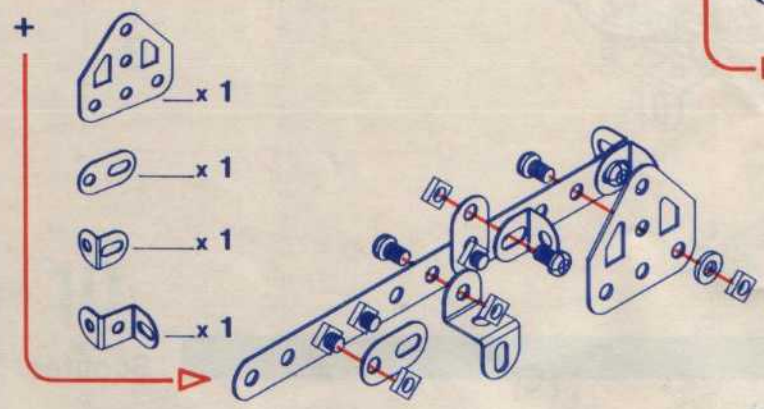
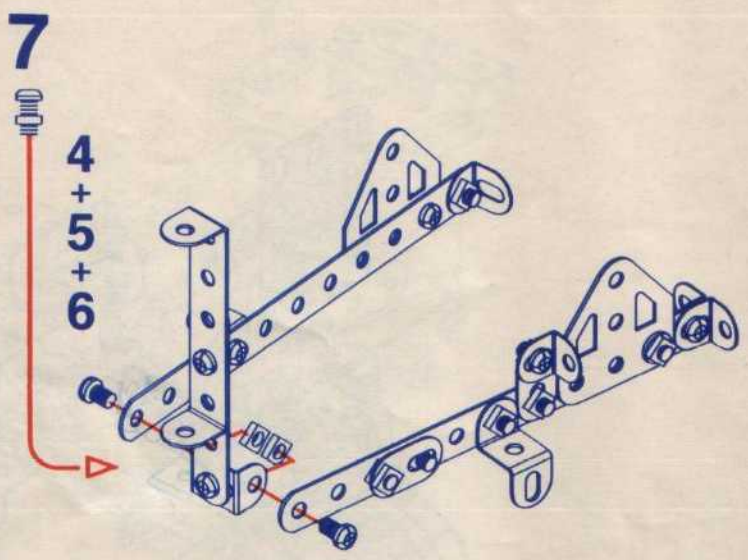
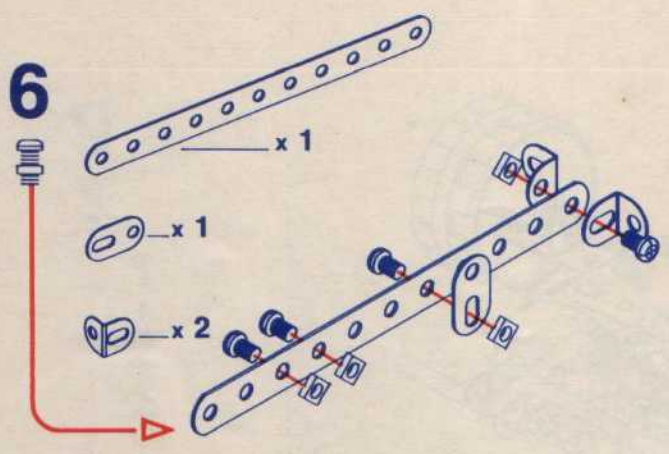

10

- 7 + 9

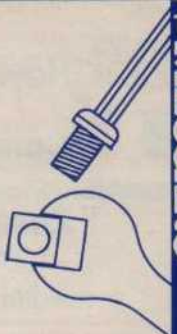
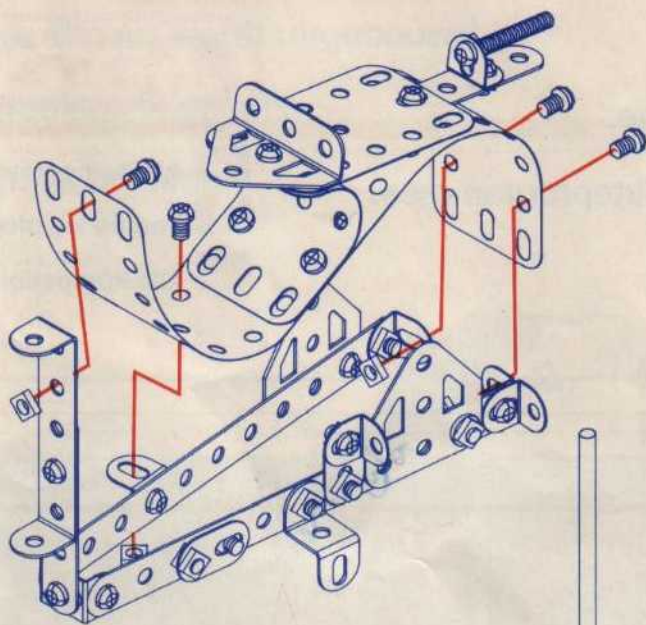

11

- 10 + 3 +
- x 1 (Wheel)
- x 1 (Long axle)
- x 1 (Short axle)
- x 2 (Pin)

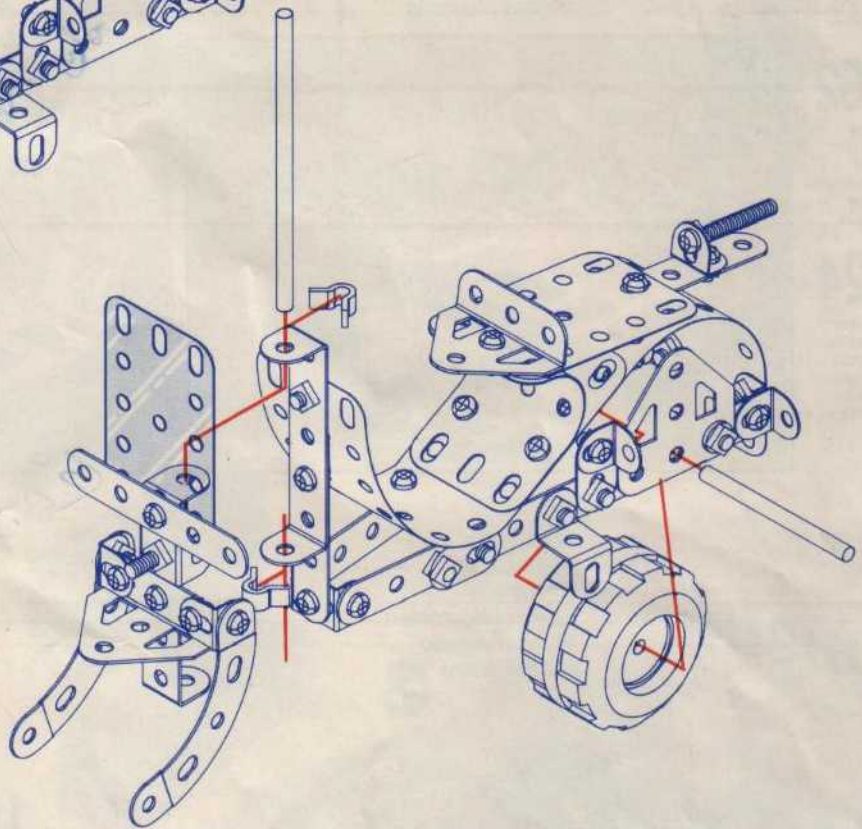

12

- x 2 (Wheel)
- x 1 (Bent axle)
- x 1 (Long axle)
- x 1 (Short axle)
- x 2 (Pin)

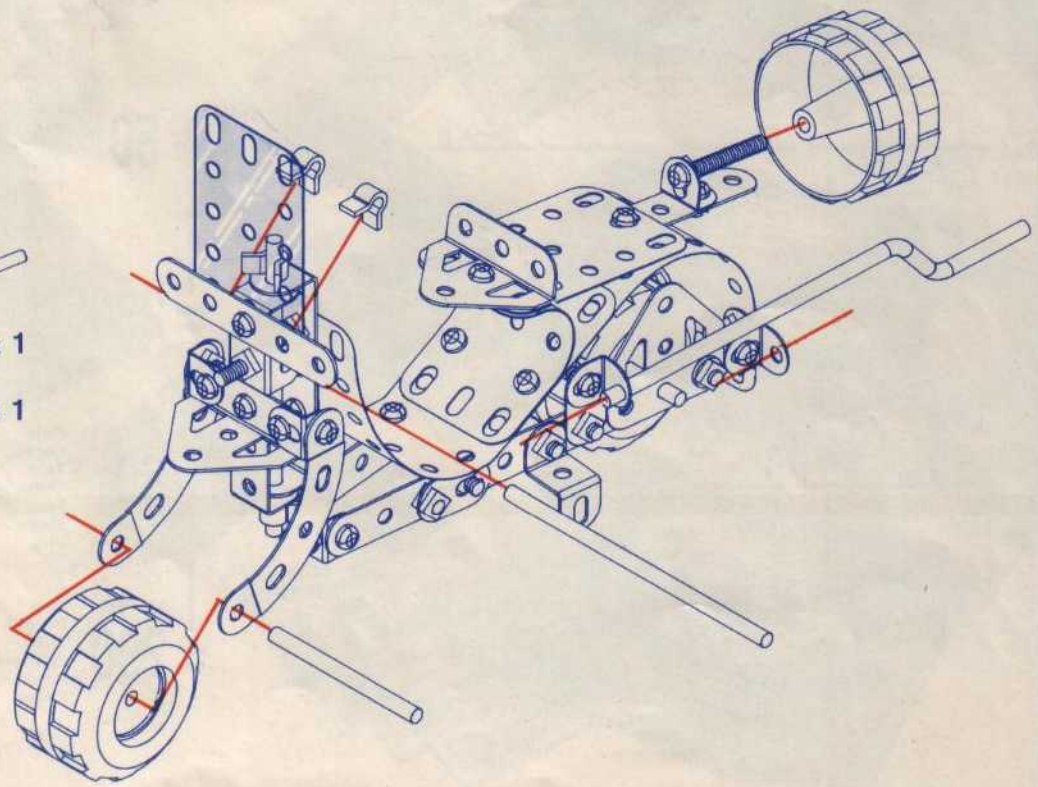



How the range progresses.



Comment progresse la gamme.



Zusammensetzung des Produkteprogrammes.

MECCANO



All the compatible pieces.



Toutes les pièces compatibles.



Alle kompatiblen Teile.

MECCANO junior

Plastic parts
Pièces plastiques
Plastikteile
Plastic onderdelen
Pezzi di plastica
Piezas plasticas

From ages
Ages
Alter
Leeftijd
Eta'
De
4/6
Ans
Jahre
Jaar
Anni
Años de edad

62

Parts
Pièces
Teile
Onderdelen
Pezzi
Piezas

24

Models
Modèles
Modelle
Modellen
Modelli
Modelos



112

Parts
Pièces
Teile
Onderdelen
Pezzi
Piezas

42

Models
Modèles
Modelle
Modellen
Modelli
Modelos

MECCANO metal

Steel parts
Pièces acier
Metallteile
Stalen onderdelen
Pezzi d'acciaio
Piezas acero

Ages
A partir de
Ab
Vanaf
Da
A partir de
6
And over
Ans
Jahren
Jaar
Anni in su
Años

1



180

Parts
Pièces
Teile
Onderdelen
Pezzi
Piezas

15

Models
Modèles
Modelle
Modellen
Modelli
Modelos



+ 1x

2



+ 50

Parts
Pièces
Teile
Onderdelen
Pezzi
Piezas

= 230

27

Models
Modèles
Modelle
Modellen
Modelli
Modelos



+ 2x

3



+ 50

Parts
Pièces
Teile
Onderdelen
Pezzi
Piezas

= 290

39

Models
Modèles
Modelle
Modellen
Modelli
Modelos

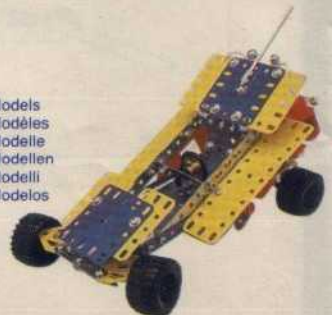

 Hoe het assortiment wordt uitgebouwd.

 Come progredisce la gamma.

 Cómo progresa la gama.

MECCANO

 Alle op elkaar passende onderdelen.

 Tutti pezzi componibili.

 Todas las piezas compatibles.

+3x



+ 90

Parts
Pièces
Teile
Onderdelen
Pezzi
Piezas



= 380

Parts
Pièces
Teile
Onderdelen
Pezzi
Piezas

51

Models
Modèles
Modelle
Modellen
Modelli
Modelos

+4x



+ 50

Parts
Pièces
Teile
Onderdelen
Pezzi
Piezas

9

+9x

10





 Models to build yourself.

 Modèles pour constructions personnelles.

 Modelle zum Selberbauen.

 Zelfbouw-modellen.

 Modelli per costruzioni personali.

 Modelos para construcciones personales.

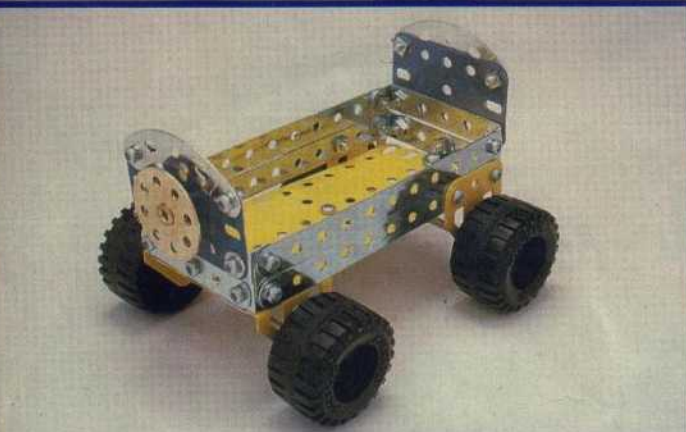
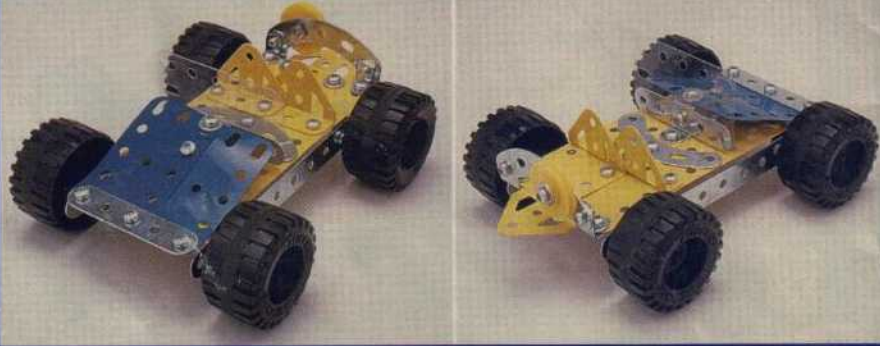
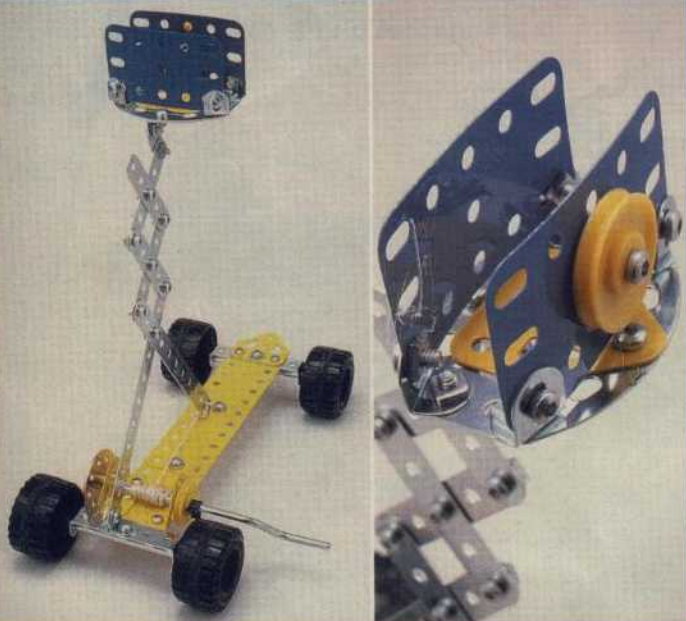

$$n^{\circ} 1 + n^{\circ} 1x = n^{\circ} 2$$



model box n° 2
modèle boîte n° 2



model box n° 2
modèle boîte n° 2