

Ersatzteile
Parti di ricambio
Reservdelar
Reservevedele
Varaosat

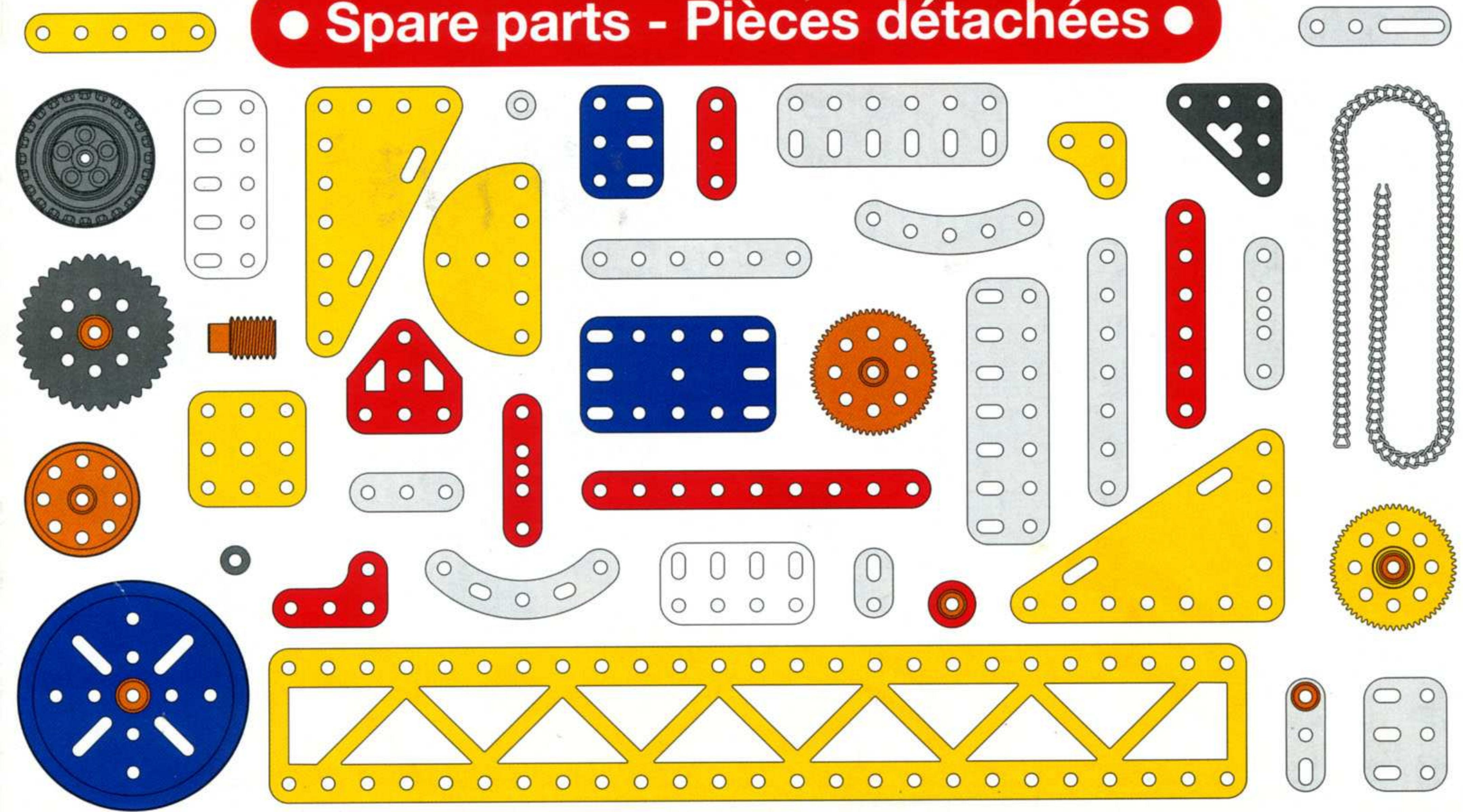

Piezas sueltas
Onderdelen
Peças Soltas
Ανταλλακτικά
部品

● Spare parts - Pièces détachées ●



MECCANO JUNIOR

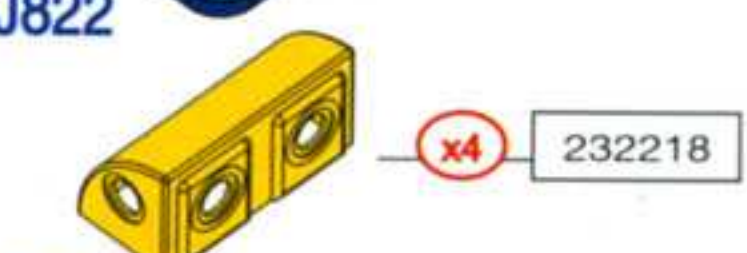
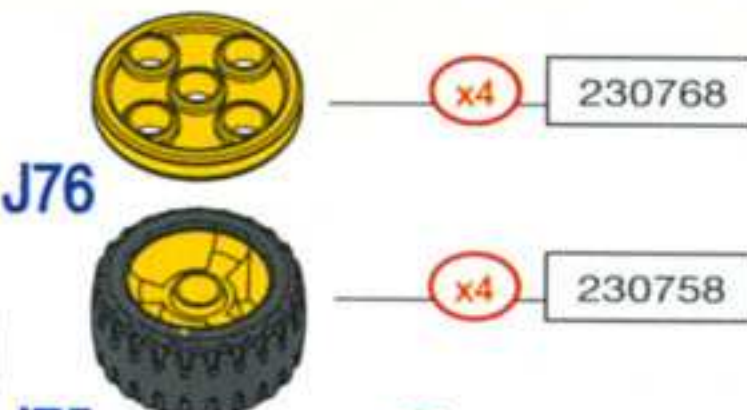
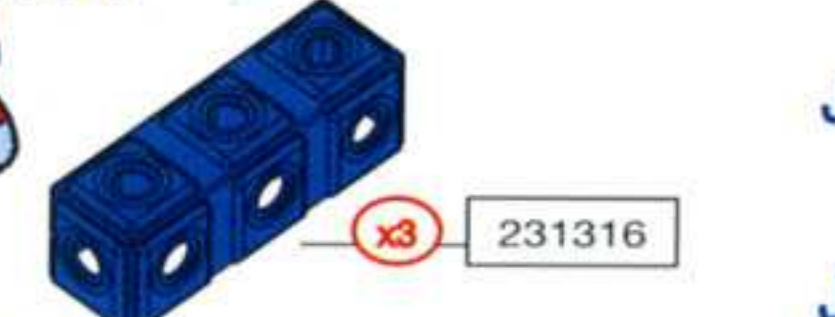
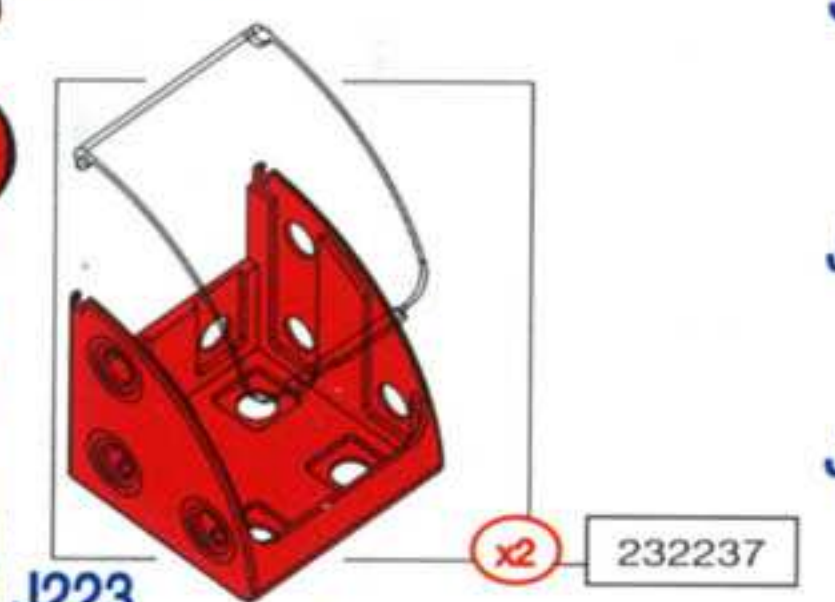
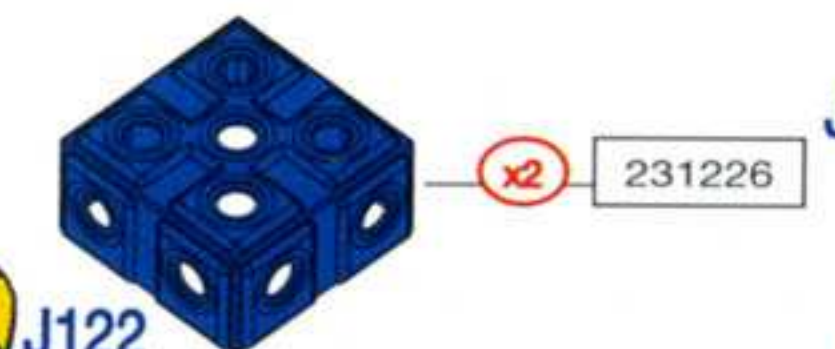
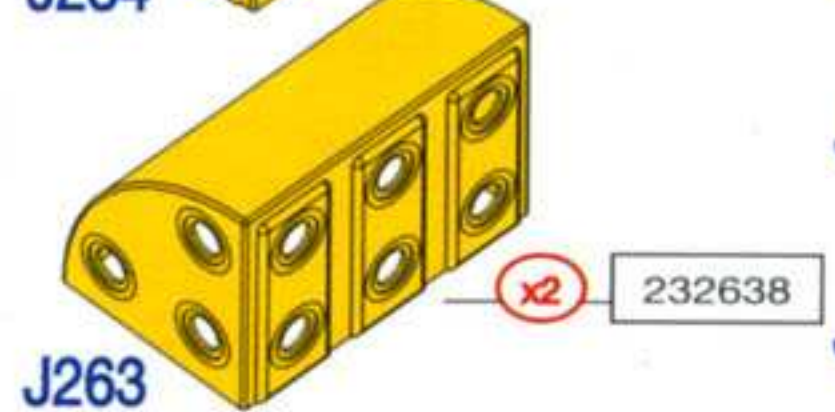
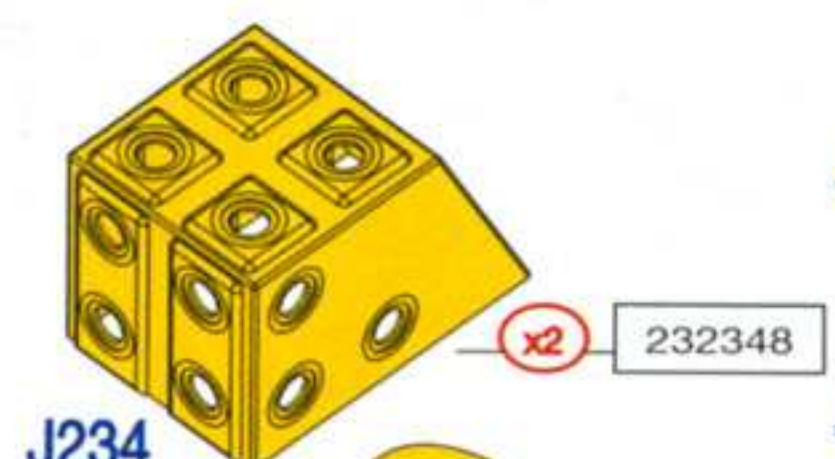
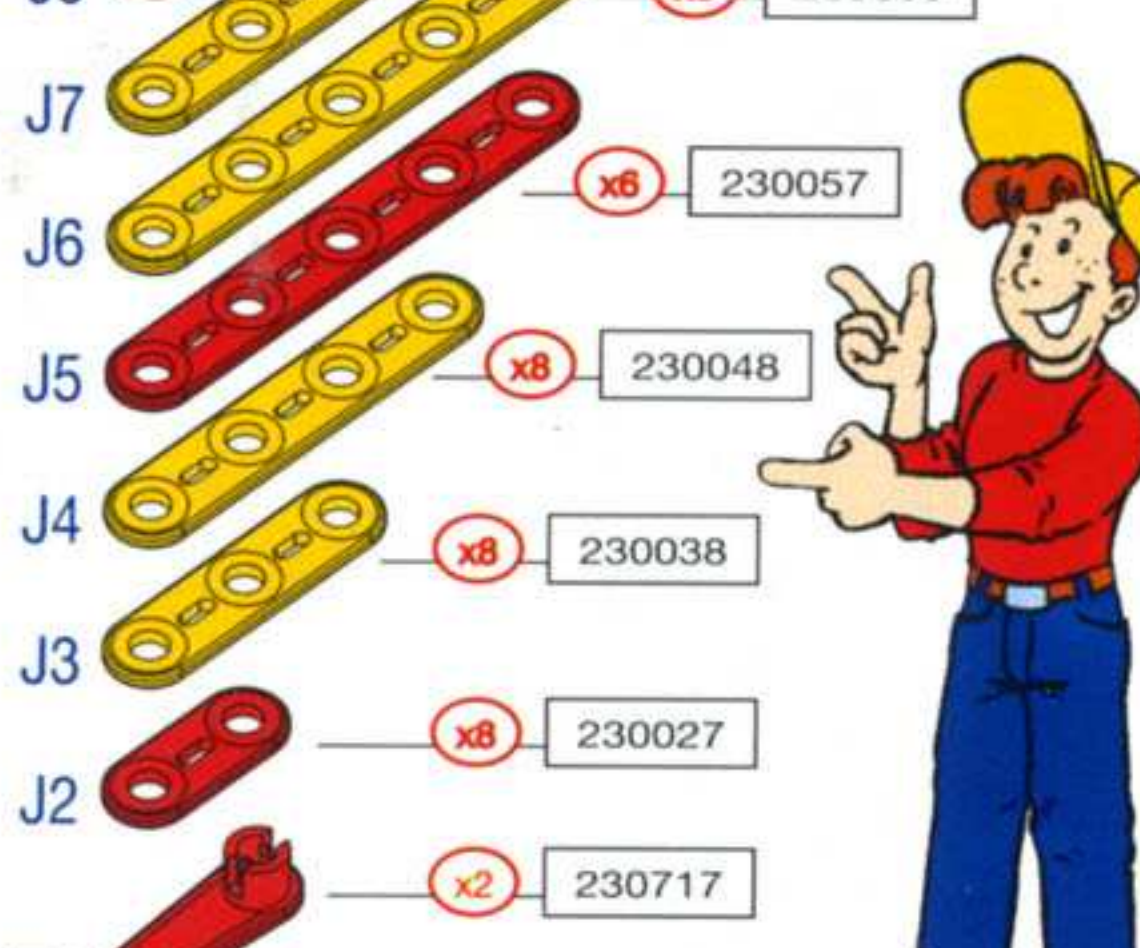
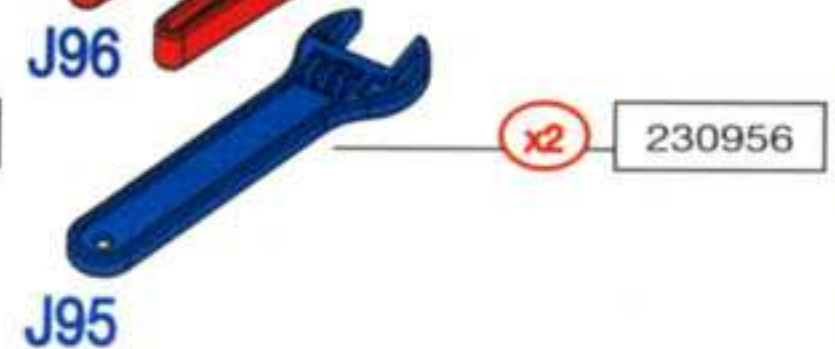
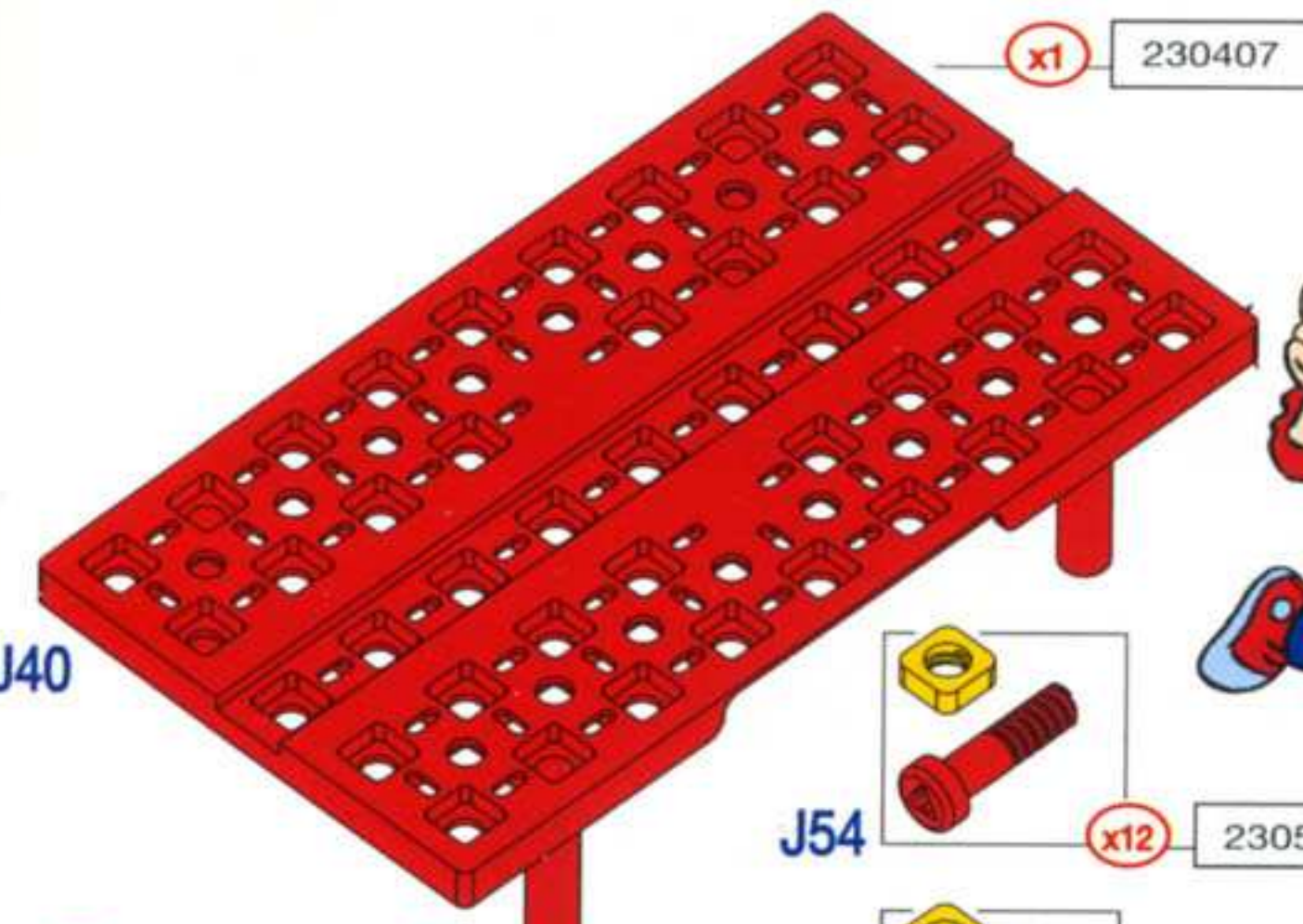
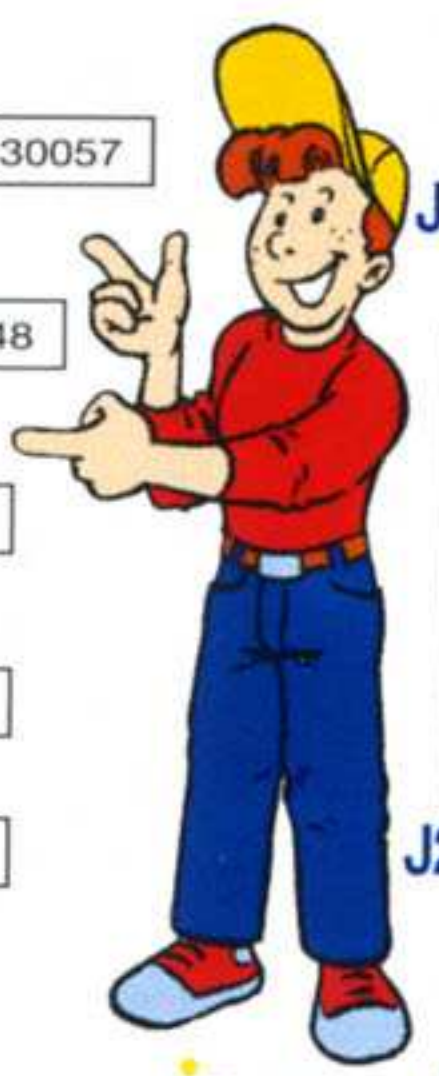

MECCANO®



1 x3 036001
 x4 036002
 x4 036581
 x4 036003
 x6 036004
 x6 036582
 x6 036457
 x6 036005
 x6 036583
 x6 036456
 x6 036006
 x6 036458
 x6 036459
 x6 036584
 x6 036007
 x6 036460
 x6 036461
 x6 036462
 x8 036008
 x8 036463
 x8 036464
 x8 036466
 x8 036465

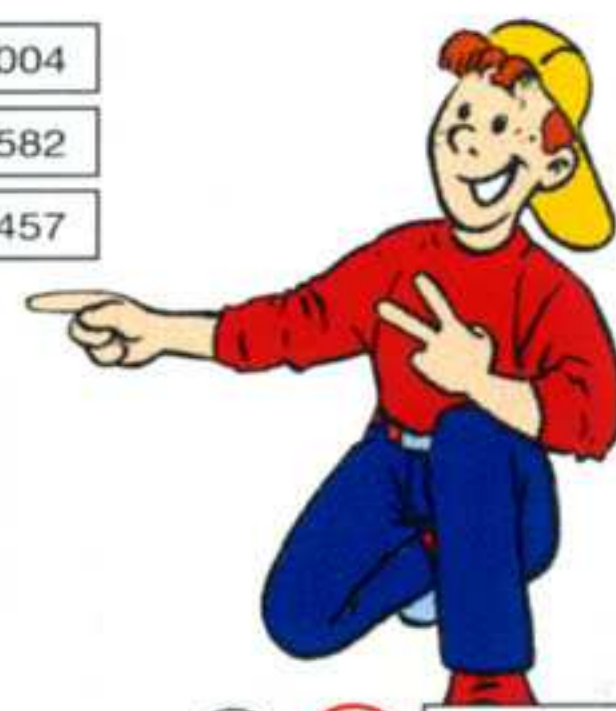

6 x6 036009
 x6 036467
 x6 036609
 x6 036610
 x6 036468
 x10 036010
 x10 036469
 x10 036585
 x10 036470

235d x6 036522
 x6 036521
 x6 036249
 x6 036520
 x6 036248
 x6 036519
 235 x6 036430
 x6 036603
 x6 036604
 235h

235g x6 036523
 806b x6 036601
 x6 036602
 x6 036560

x4 036011
 x4 036012
 x6 036016
 x6 036017
 x6 036018
 x6 036019
 x6 036020
 x6 036021
 x6 036022
 x6 036535
 x2 036013
 x2 036014
 x6 036015

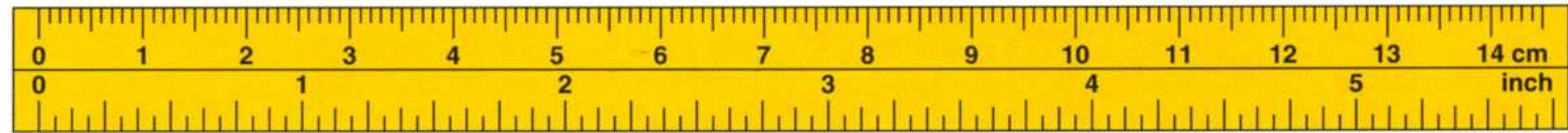

F De nombreux modèles et pièces comprennent des créations originales propriétés de MECCANO S.A. De nombreux modèles et pièces sont protégés par les législations en vigueur sur les dessins et modèles, marques ou droits d'auteur. La marque MECCANO est une marque déposée propriété de MECCANO S.A. et ne peut être utilisée sans l'autorisation de MECCANO S.A. Pour toute information complémentaire, merci de contacter : MECCANO S.A. 363, avenue de Saint-Exupéry - 62100 CALAIS - FRANCE Tél. (33) 21.46.37.37 - Fax : (33) 21.46.37.49

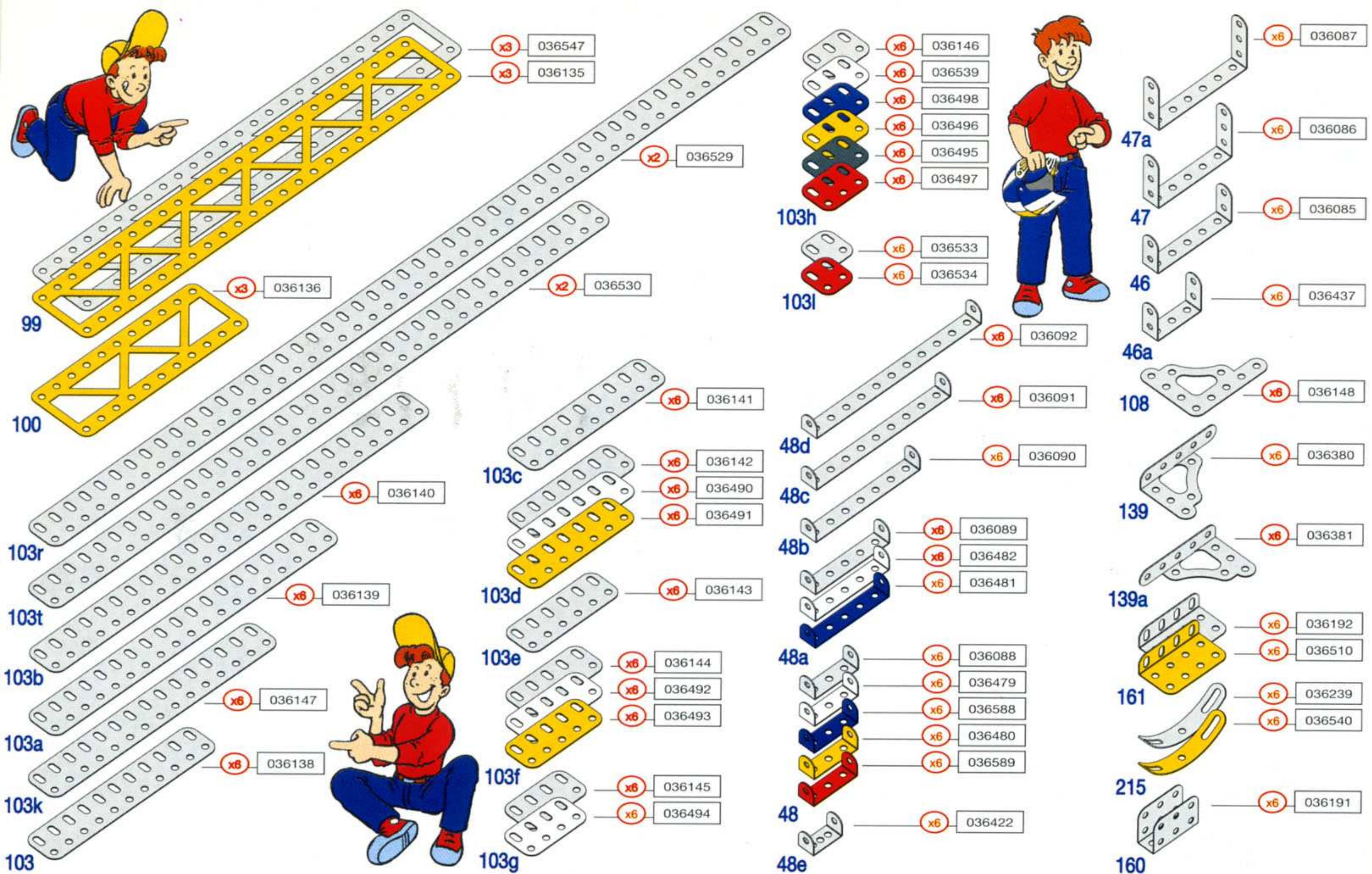

D Viele Modelle und Zubehörteile vereinen die Einzigartigkeit und das Originaldesign von MECCANO S.A. Industriedesign, Warenzeichen und/oder Copyrights für viele Modelle und Zubehörteile sind in zahlreichen Ländern gesetzlich geschützt. MECCANO ist ein eingetragenes Warenzeichen von MECCANO S.A. und kann nicht ohne Genehmigung genutzt werden. MECCANO S.A. steht Ihnen für nähere Informationen zur Verfügung. MECCANO S.A. 363, avenue de Saint-Exupéry - 62100 CALAIS - FRANCE Tél. (33) 21.46.37.37 - Fax : (33) 21.46.37.49

I Molti modelli e componenti sono realizzati secondo disegni unici e originali di proprietà della MECCANO S.A. Molti di questi modelli e componenti sono protetti dalla legislatura come disegni industriali, marchi e/o copyright in numerosi paesi. Il marchio MECCANO e' registrato come marchio della MECCANO S.A. e può essere utilizzato solo previa autorizzazione. Per ulteriori informazioni rivolgersi alla MECCANO S.A. MECCANO S.A. 363, avenue de Saint-Exupéry - 62100 CALAIS - FRANCE Tél. (33) 21.46.37.37 - Fax : (33) 21.46.37.49

Grey Beams:
 19h (x3) 036043
 19s (x3) 036044
 134 (x3) 036247 L= 100 mm 4"
 230 (x3) 036341
 231 (x3) 036341
 036030 L= 290 mm 11 1/2"
 036031 L= 200 mm 8"
 036032 L= 165 mm 6 1/2"
 036033 L= 130 mm 5"
 036034 L= 115 mm 4 1/2"
 036035 L= 100 mm 4"
 036036 L= 90 mm 3 1/2"
 036038 L= 75 mm 3"
 036037 L= 60 mm 2 1/2"
 036039 L= 50 mm 2"
 036040 L= 40 mm 1 1/2"
 036550 L= 32 mm 1 1/4"
 036041 L= 25 mm 1"
Curved Strips:
 89 (x6) 036124
 (x6) 036611
 (x6) 036612
 (x6) 036613
 89b (x6) 036126
 90 (x6) 036127
 (x6) 036125
 89a (x6) 036128
 90a (x6) 036128
Grey Beams (continued):
 13 (x6) 036032 L= 165 mm 6 1/2"
 13a (x6) 036033 L= 130 mm 5"
 14 (x6) 036034 L= 115 mm 4 1/2"
 15 (x6) 036035 L= 100 mm 4"
 15a (x6) 036036 L= 90 mm 3 1/2"
 15b (x6) 036038 L= 75 mm 3"
 16 (x6) 036037 L= 60 mm 2 1/2"
 16b (x6) 036039 L= 50 mm 2"
 17 (x6) 036040 L= 40 mm 1 1/2"
 18a (x6) 036550 L= 32 mm 1 1/4"
 18c (x6) 036041 L= 25 mm 1"
 18b (x6) 036041 L= 25 mm 1"
Brown Beams:
 78 (x3) 036267 L= 115 mm 4 1/2"
 79a (x3) 036268 L= 90 mm 3 1/2"
 80a (x3) 036123 L= 75 mm 3"
 80c (x3) 036269 L= 50 mm 2"
 81 (x3) 036270 L= 25 mm 1"
 82 (x3) 036270 L= 25 mm 1"
Grey Connectors:
 846a (x6) 036567
 812d (x6) 036564
 812b (x6) 036563
 825 (x6) 036565
 825a (x6) 036566
 811a (x6) 036562
 811 (x8) 036561
Grey Connectors (continued):
 55 (x1) 036348
 55a (x3) 036100
 11b (x4) 036549
 10 (x10) 036023
 12 (x10) 036026
 12c (x6) 036029
 212a (x6) 036236
 114 (x2) 036155
 212 (x6) 036235
Grey Connectors (continued):
 124 (x6) 036162
 125 (x6) 036163
 (x6) 036500
 12a (x6) 036027
 12b (x6) 036028
 (x6) 036475
 12d (x6) 036568
Grey Connectors (continued):
 11a (x6) 036025
 (x6) 036472
 (x6) 036471
 11 (x8) 036024
 (x8) 036473
 (x8) 036586
 (x8) 036474
 102 (x3) 036137
 44 (x4) 036083
 45 (x6) 036084
 154a (x6) 036188
 154b (x6) 036189
Red Connectors:
 45a (x4) 036438
 12b (x6) 036028
 (x6) 036475
 11a (x6) 036025
 (x6) 036472
 (x6) 036471
 11 (x8) 036024
 (x8) 036473
 (x8) 036586
 (x8) 036474
 45 (x6) 036084
 154a (x6) 036188
 154b (x6) 036189

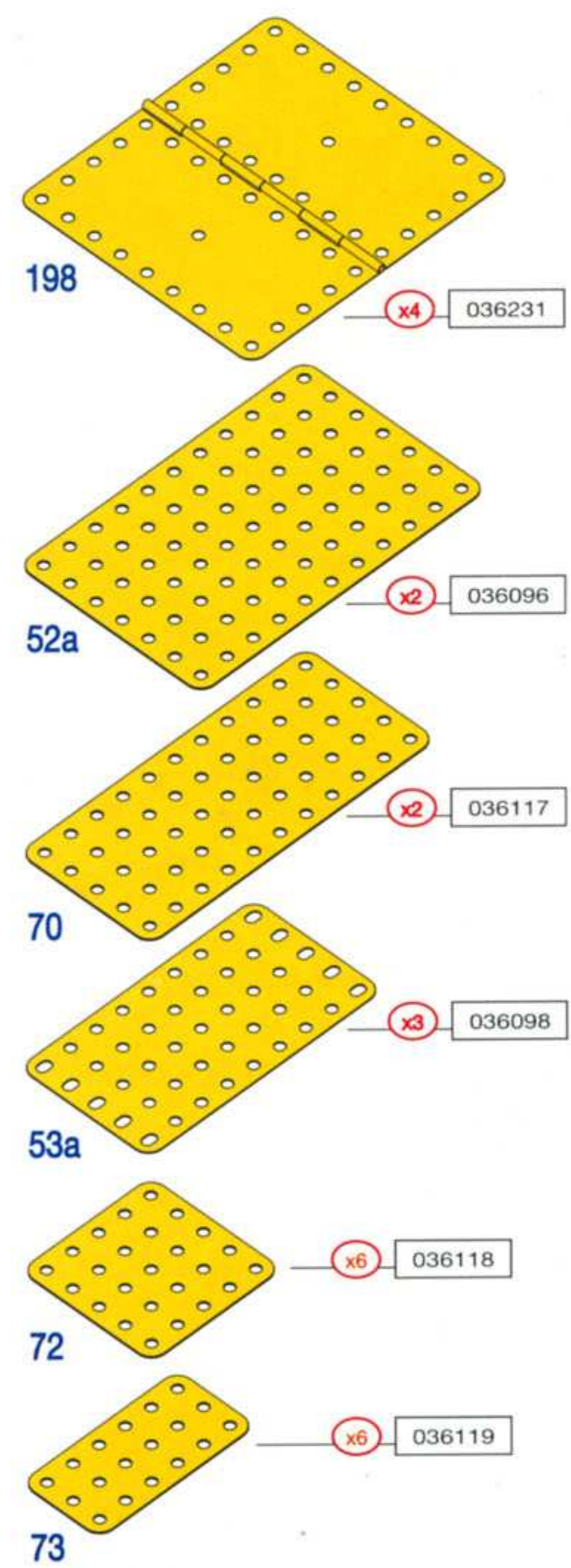
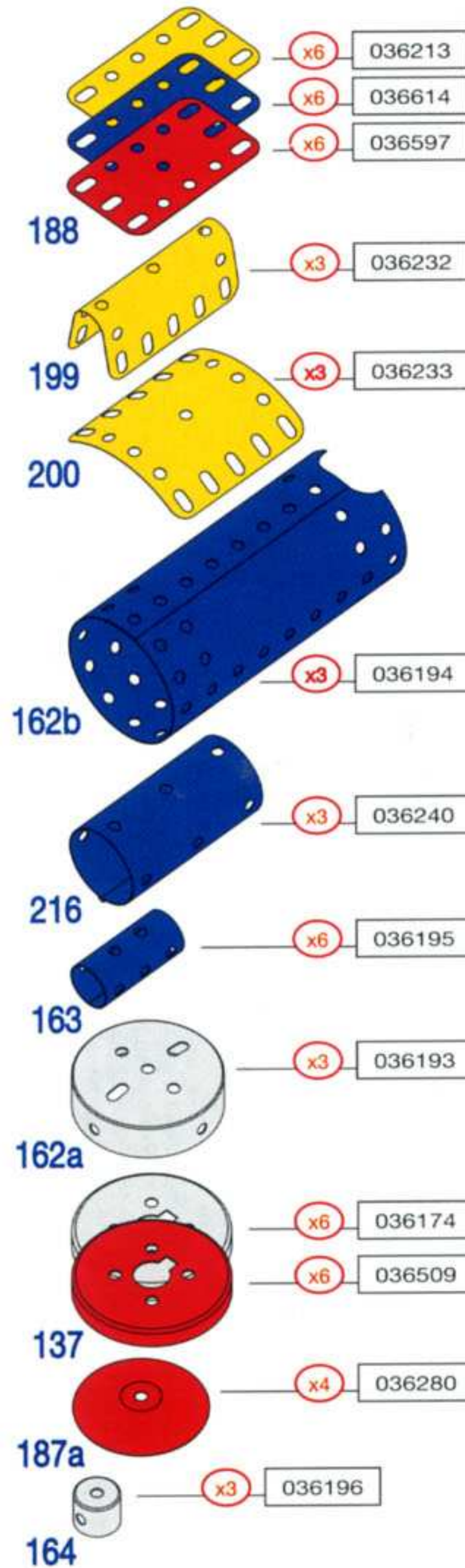
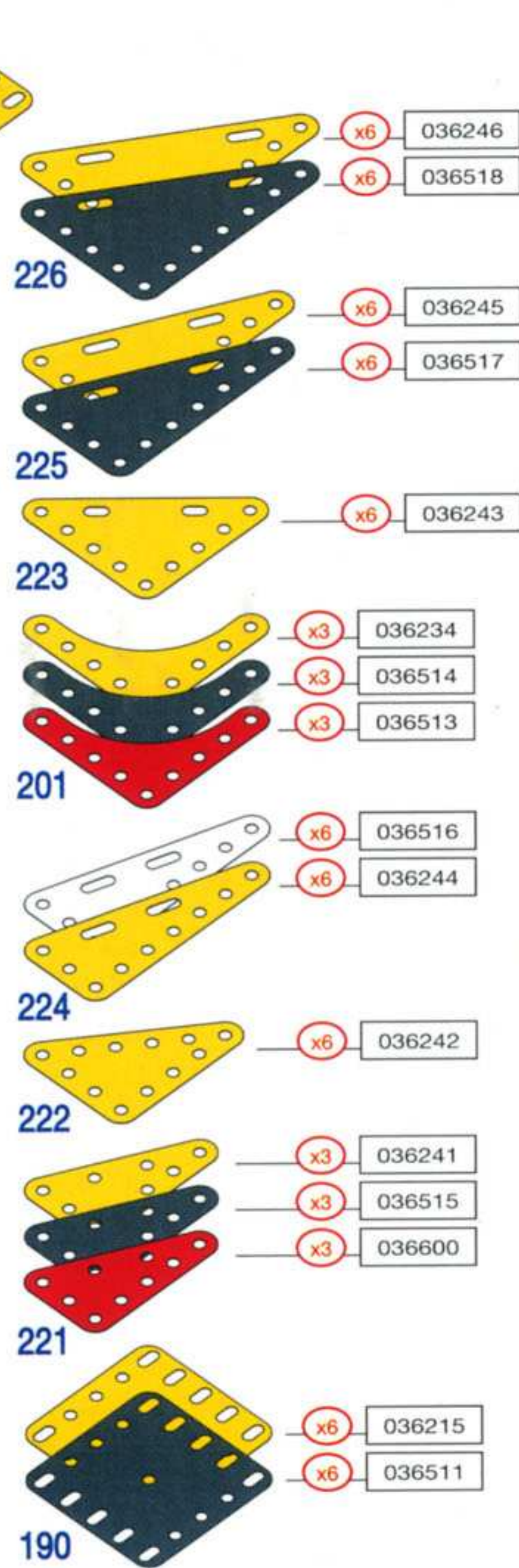
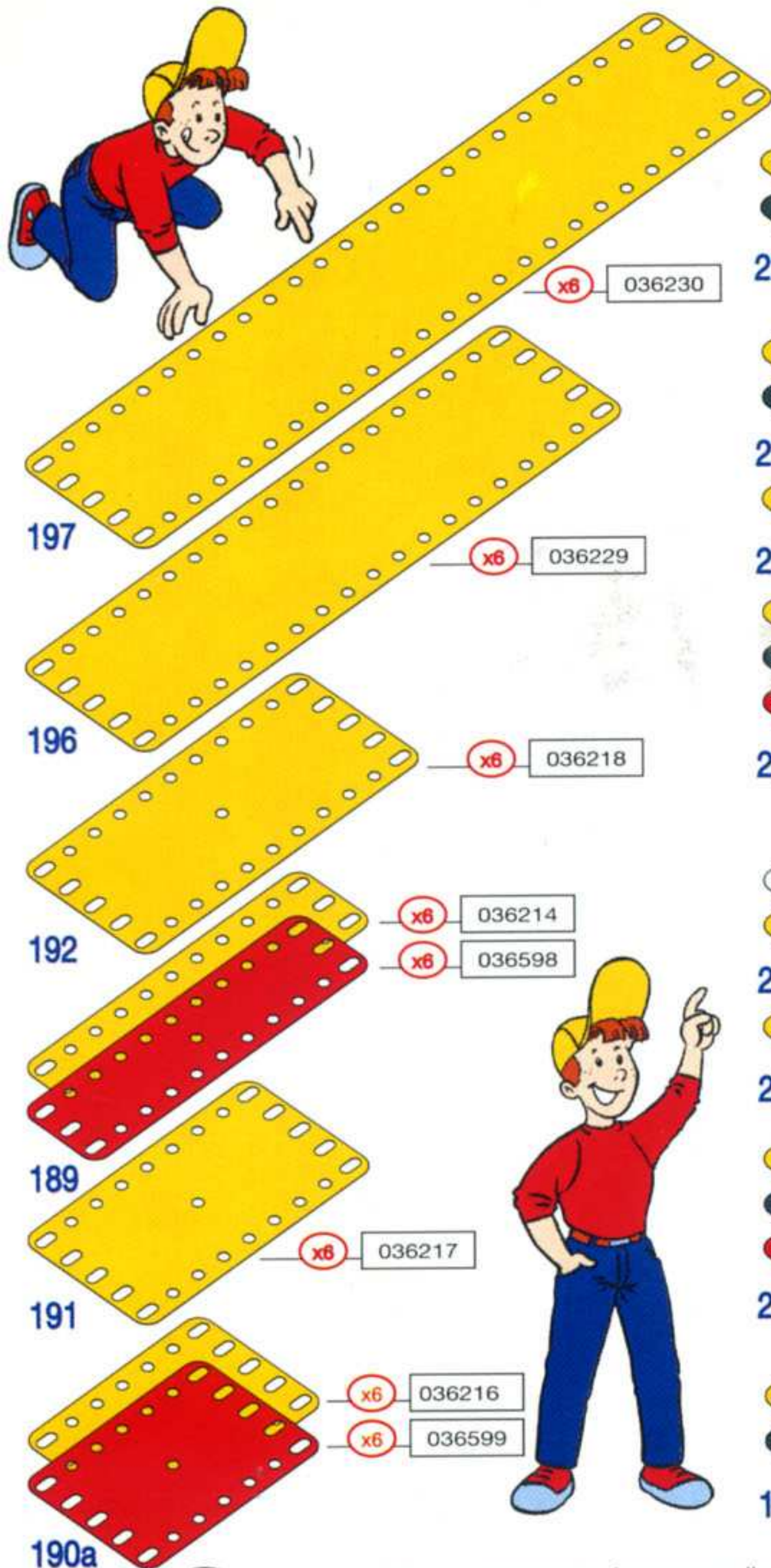

E Muchos modelos y componentes incorporan diseños únicos y originales, que son propiedad de MECCANO S.A. Muchos de estos modelos y componentes están protegidos por la legislación como diseños industriales, marcas y/o copyrights en numerosos países. La marca MECCANO es la marca registrada de MECCANO S.A. y no puede ser utilizada sin su permiso. Para información más detallada, contactar por favor con MECCANO S.A. 363, avenue de Saint-Exupéry - 62100 CALAIS - FRANCE Tél. (33) 21.46.37.37 - Fax : (33) 21.46.37.49

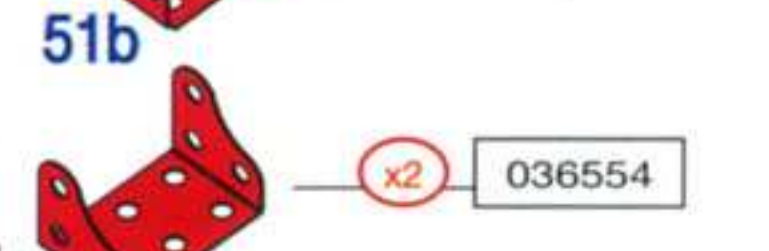
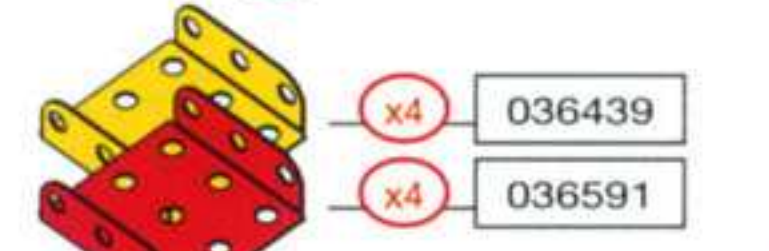
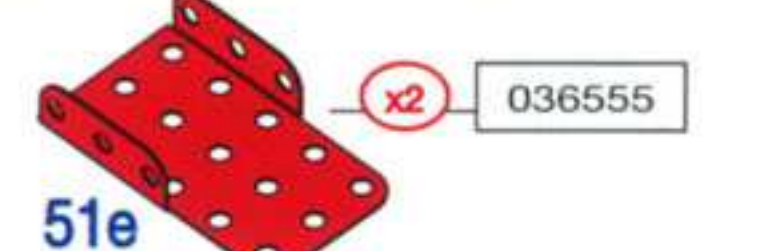
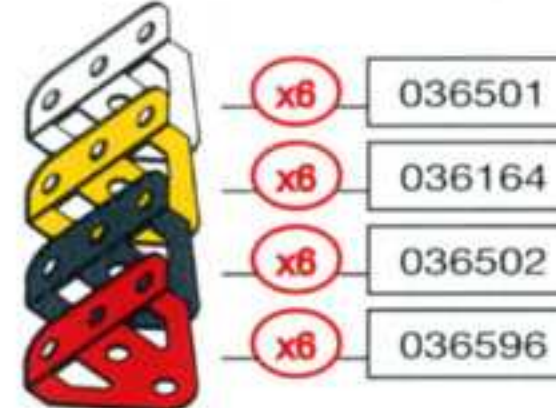
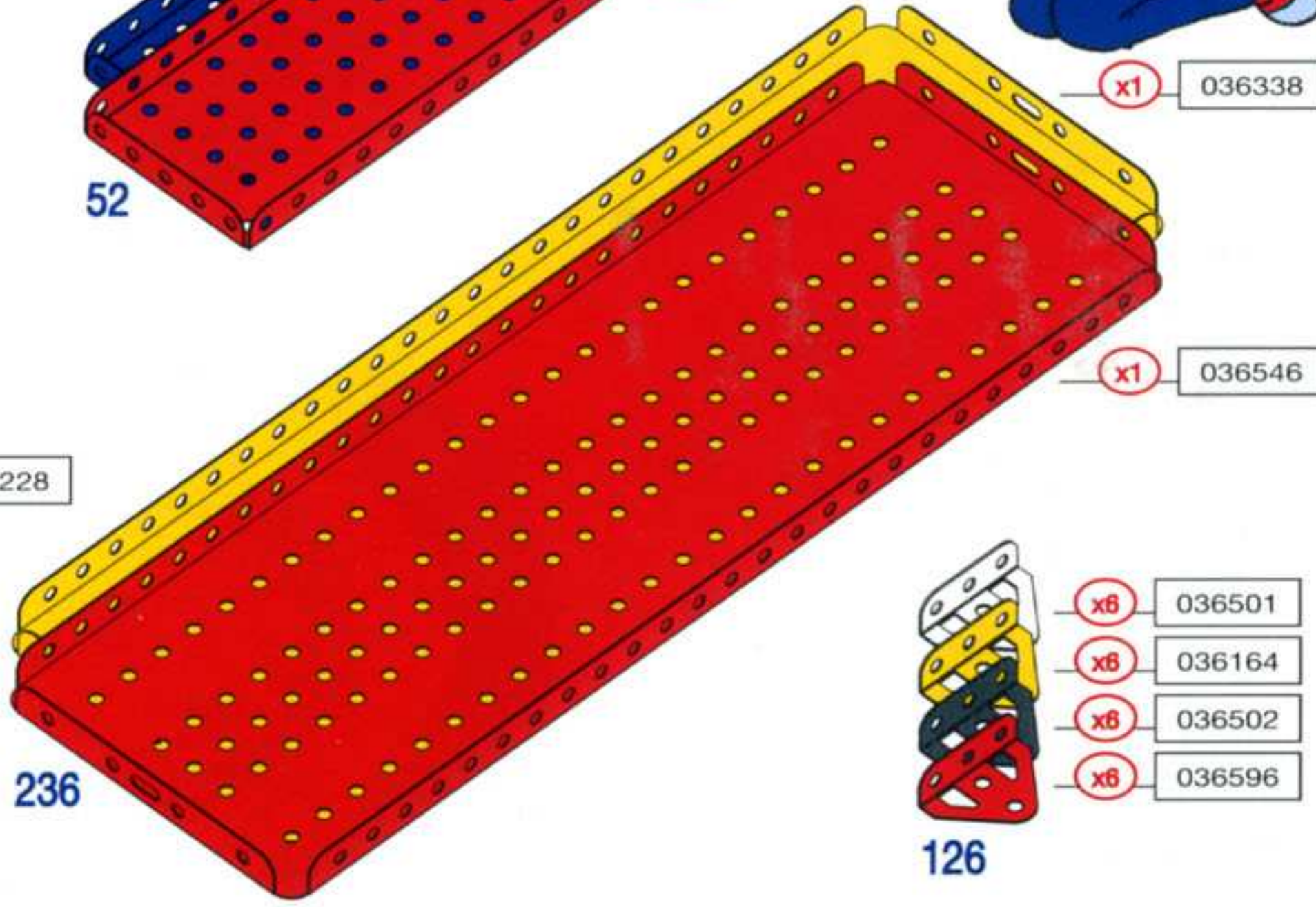
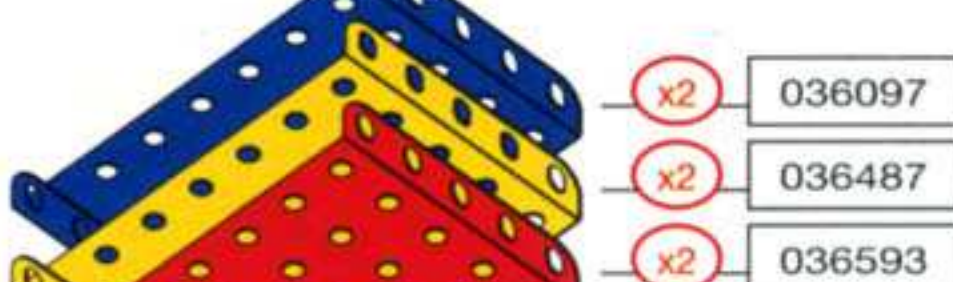
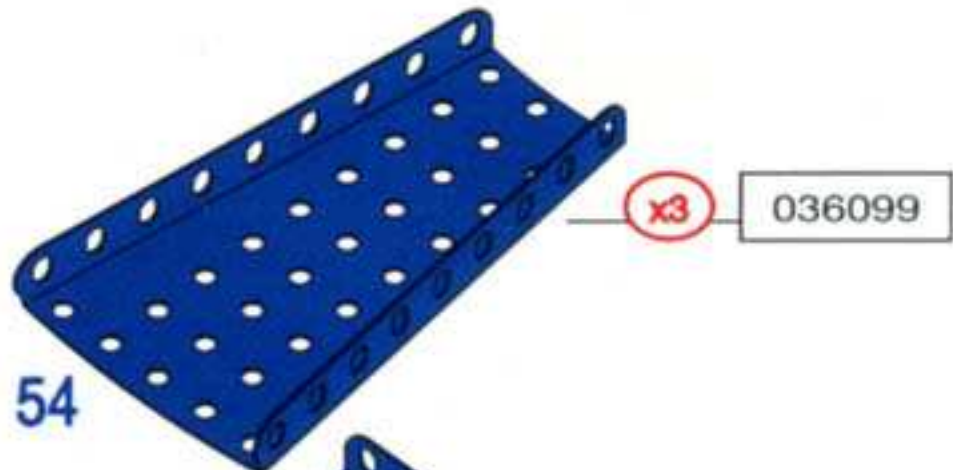
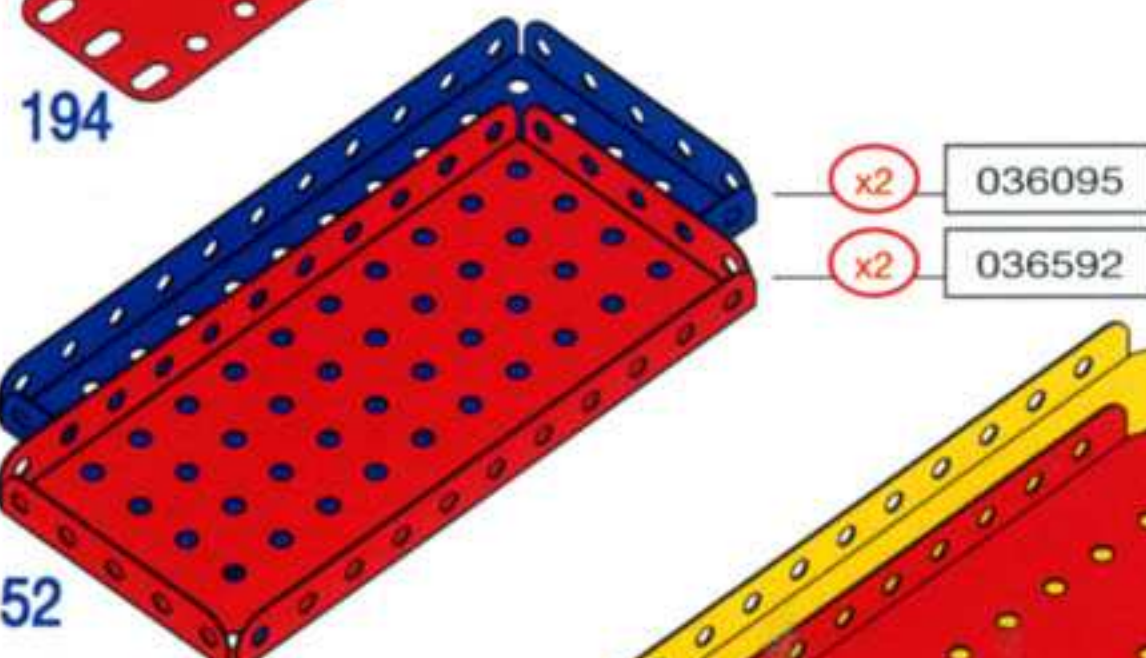
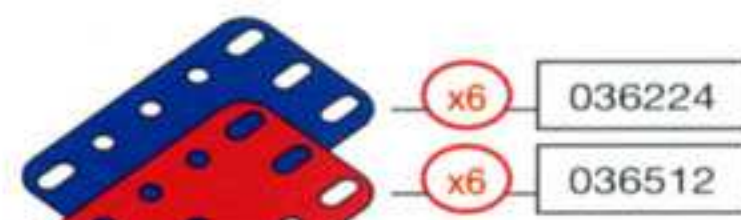
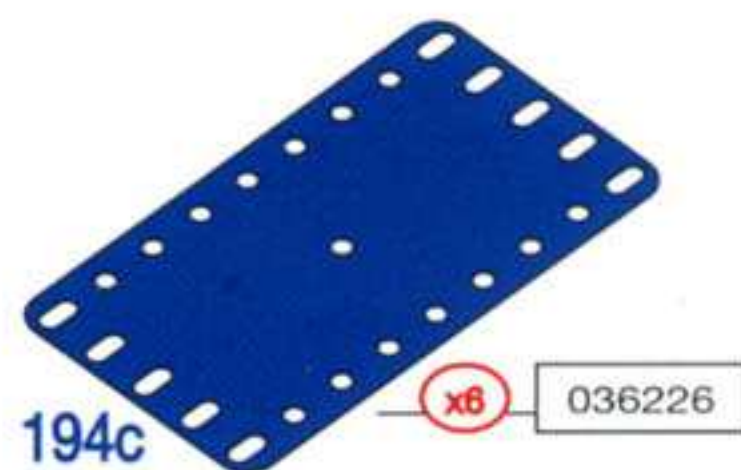
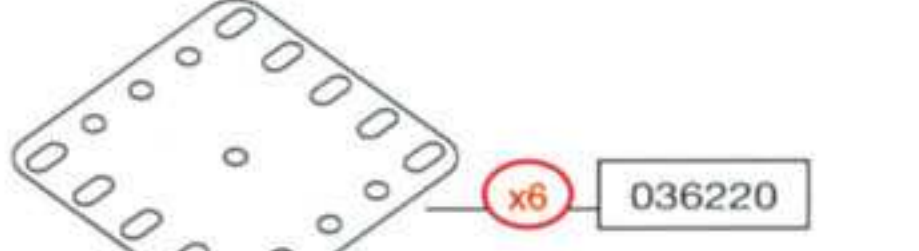
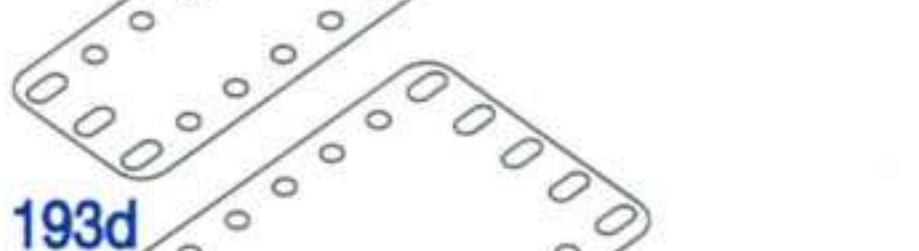
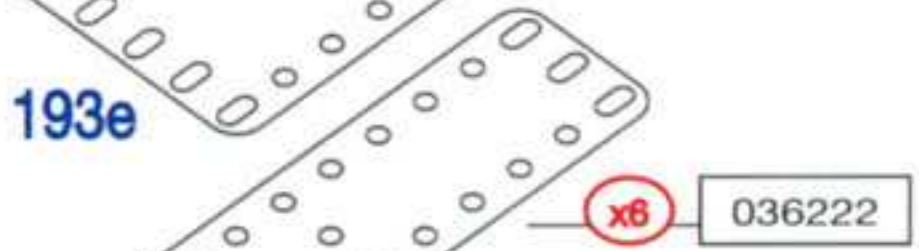
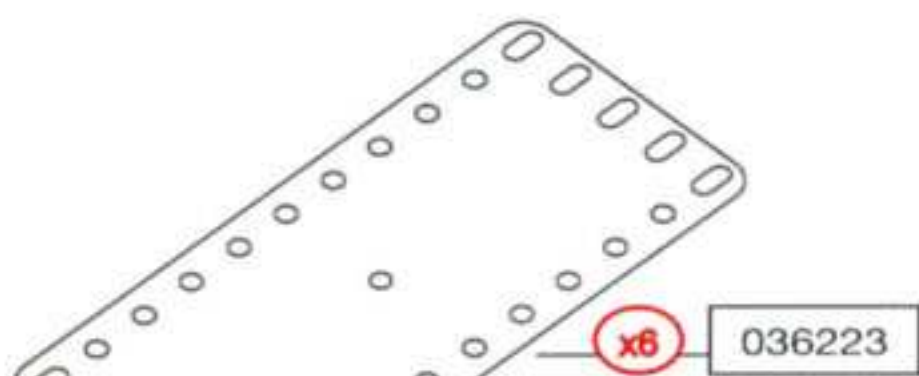
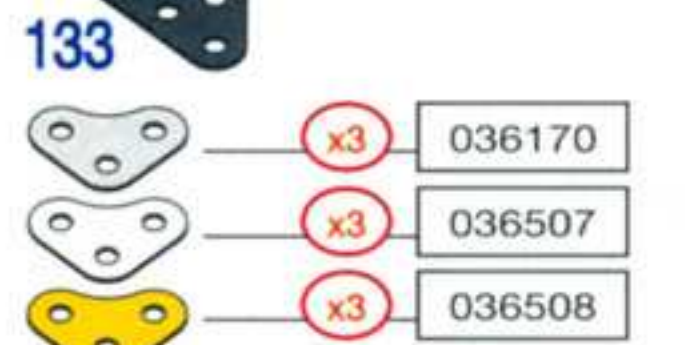
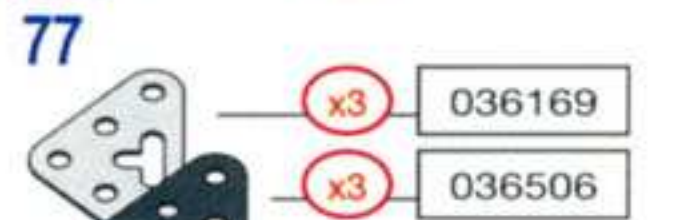
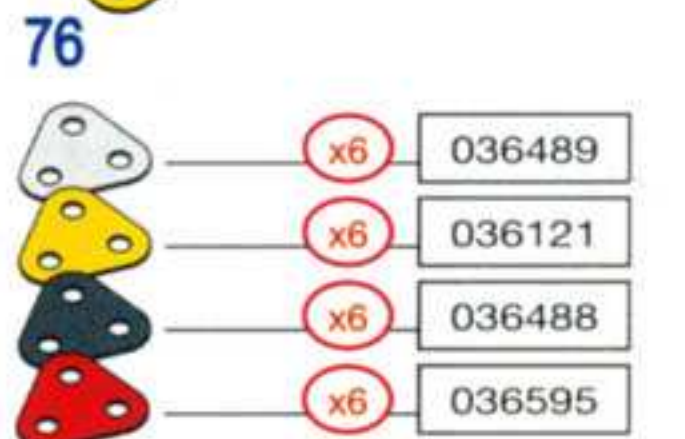
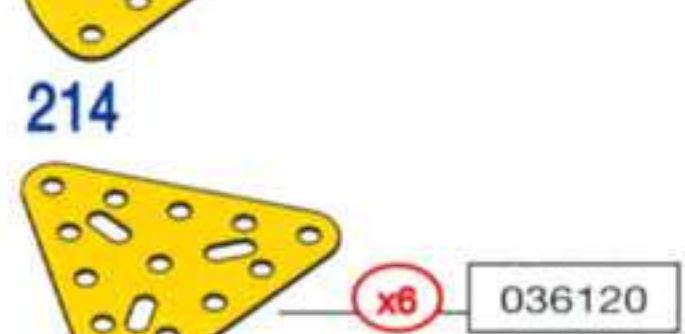
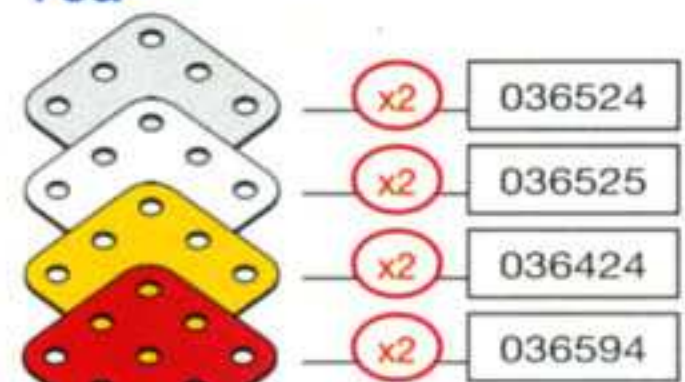
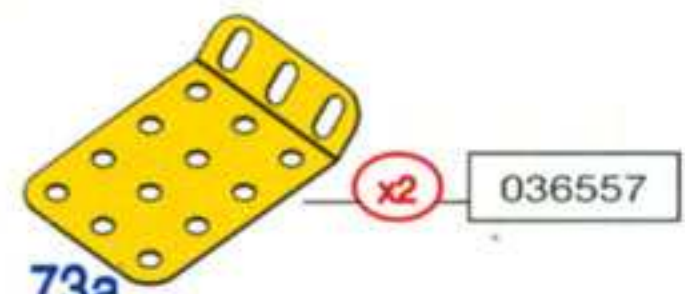

(SF) Useat mallit ja osat ovat MECCANO S.A.:n omaisuutta olevaa suunnittelua. Useat mallit ja osat ovat lailla suojattua teollista muotoilua, tavaramerkki ja/tai kopiontioikeuksia useissa maissa. Tuotemerkki MECCANO on MECCANO S.A.:n omaisuutta oleva rekisteröity tavaramerkki, jonka käyttö ilman lupaa on kielletty. Lisätietoja varten, ottakaa yhteyttä MECCANO S.A.:han MECCANO S.A. 363, avenue de Saint-Exupéry - 62100 CALAIS - FRANCE Tél. (33) 21.46.37.37 - Fax : (33) 21.46.37.49

(DK) Mange modeller og komponentdele rummer unikt og originalt design, der er MECCANO S.A.'s ejendom. Mange af disse modeller og komponenter er beskyttet af lovgivning, såsom industrielt design, varemærker og/eller copyright i adskillige lande. Varemærket MECCANO er registreret varemærke tilhørende MECCANO S.A. og kan ikke anvendes uden tilladelse. For nærmere oplysninger, kontakt MECCANO S.A.

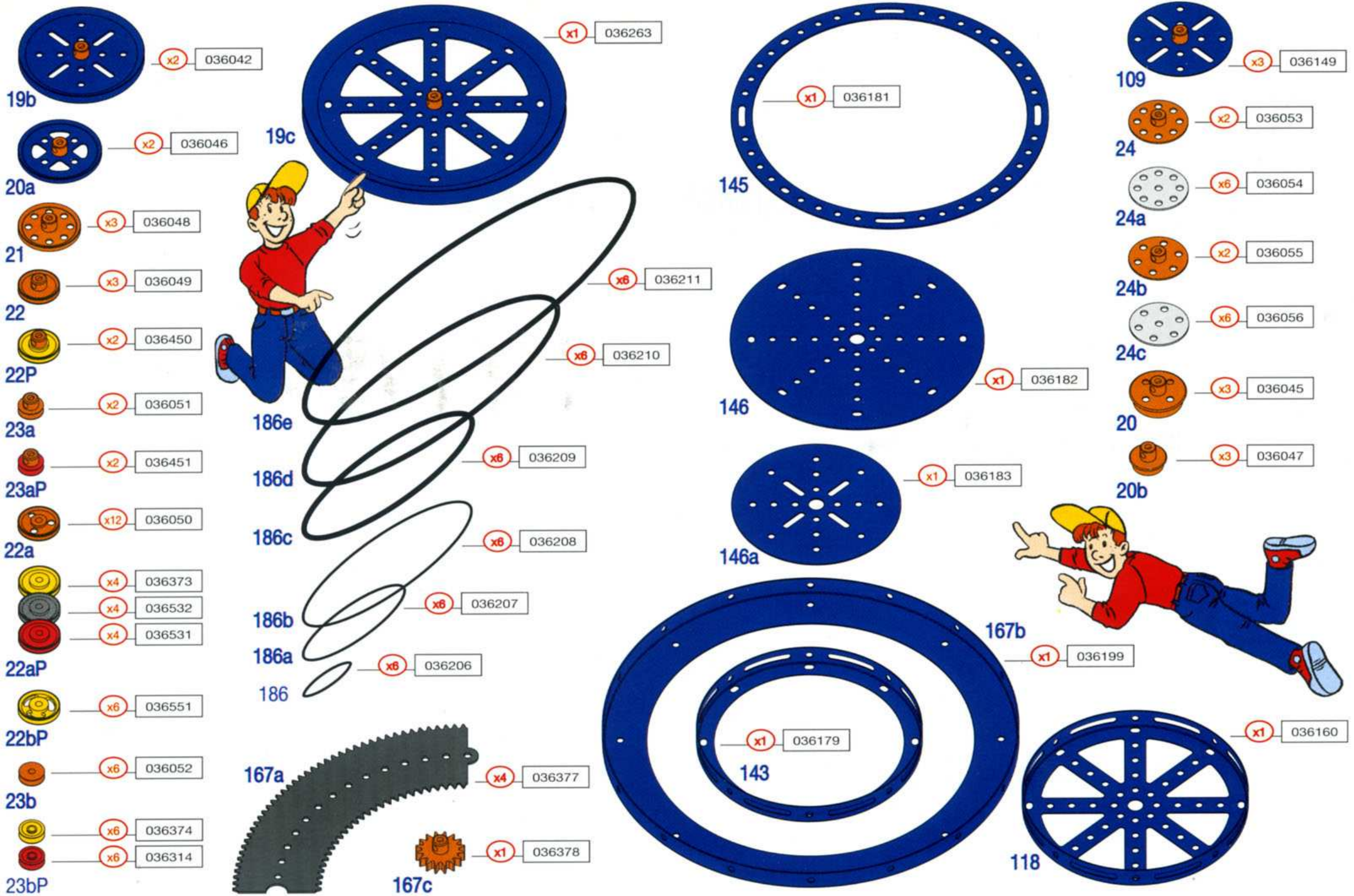

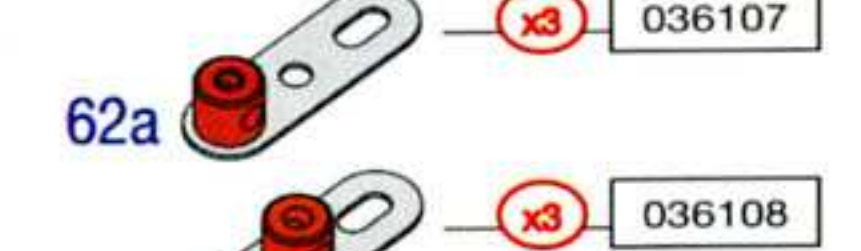
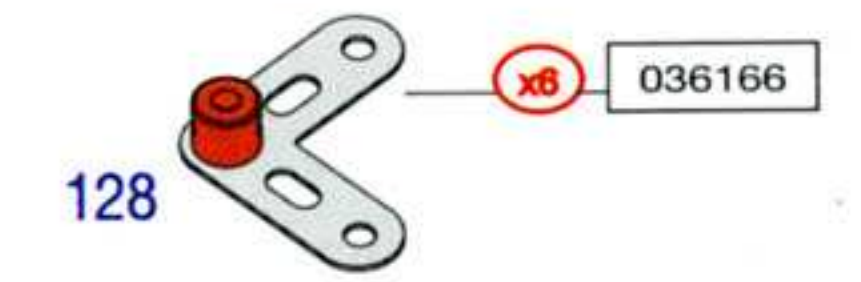
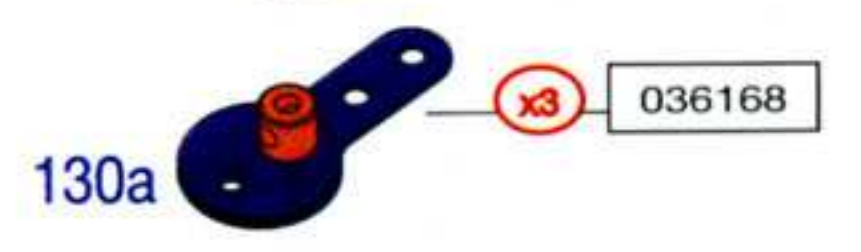
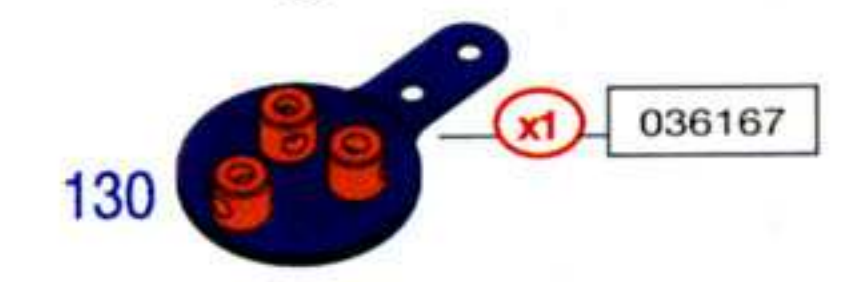
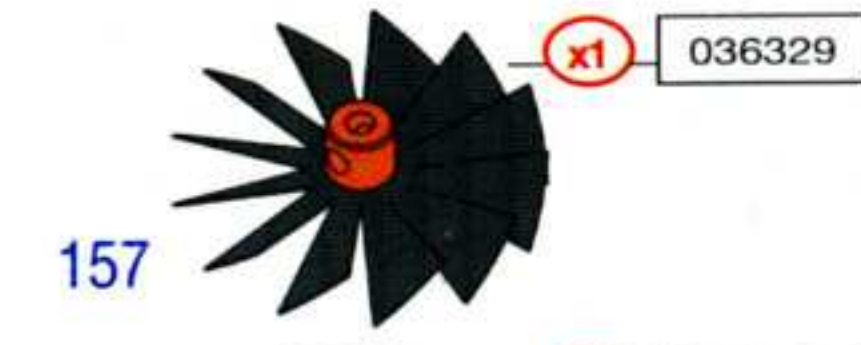
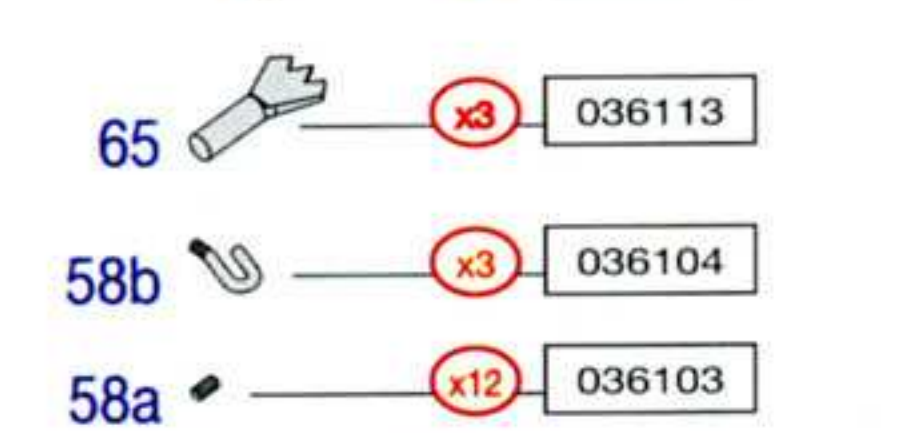
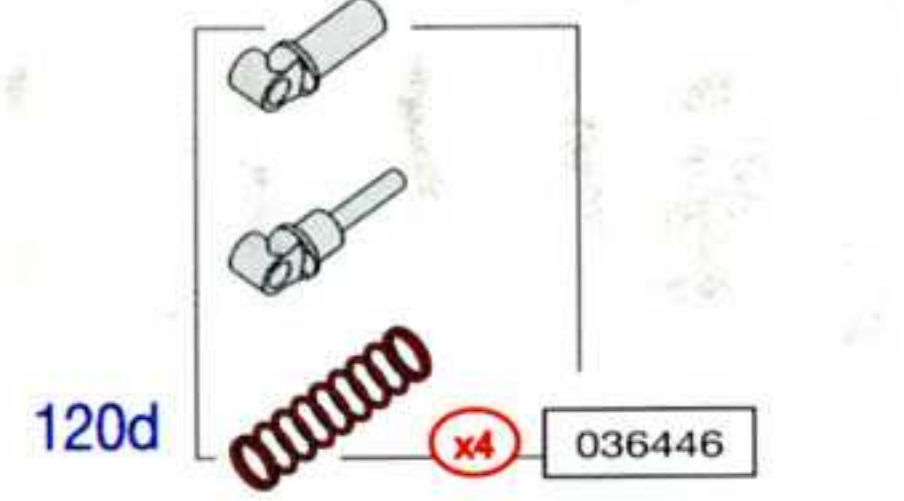
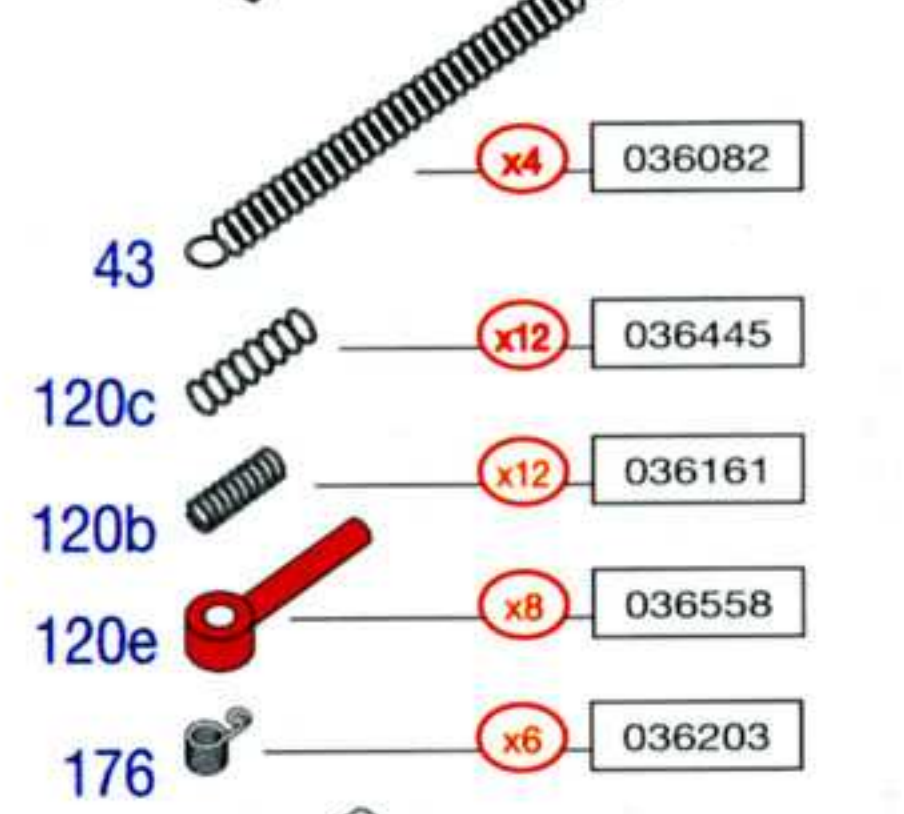
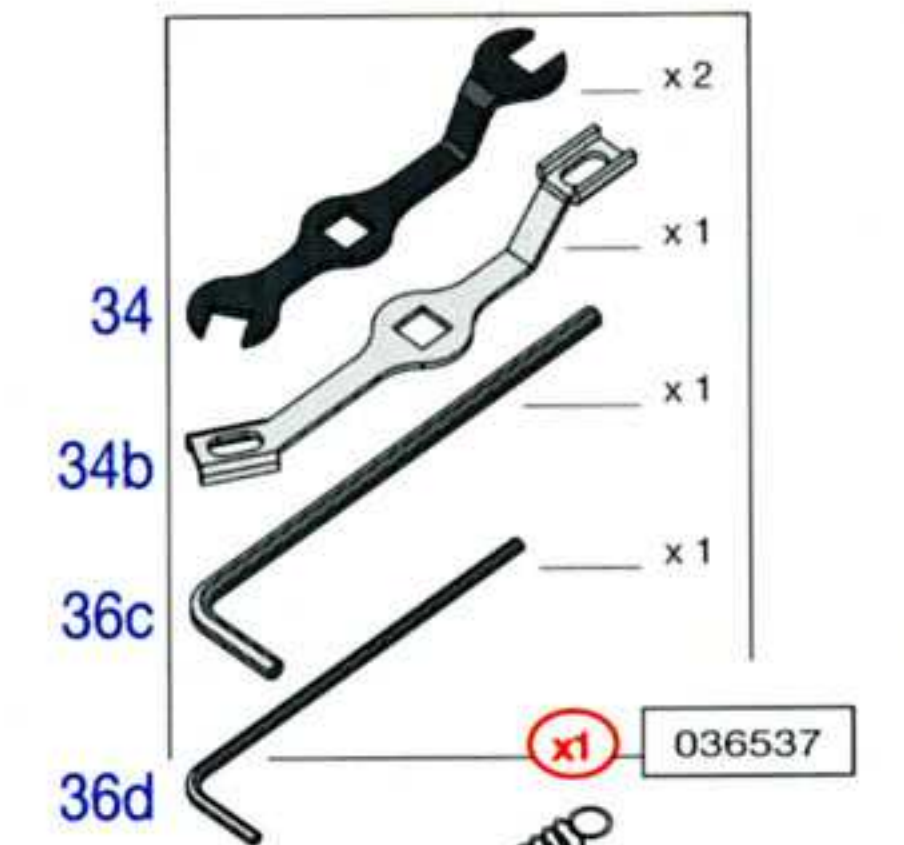
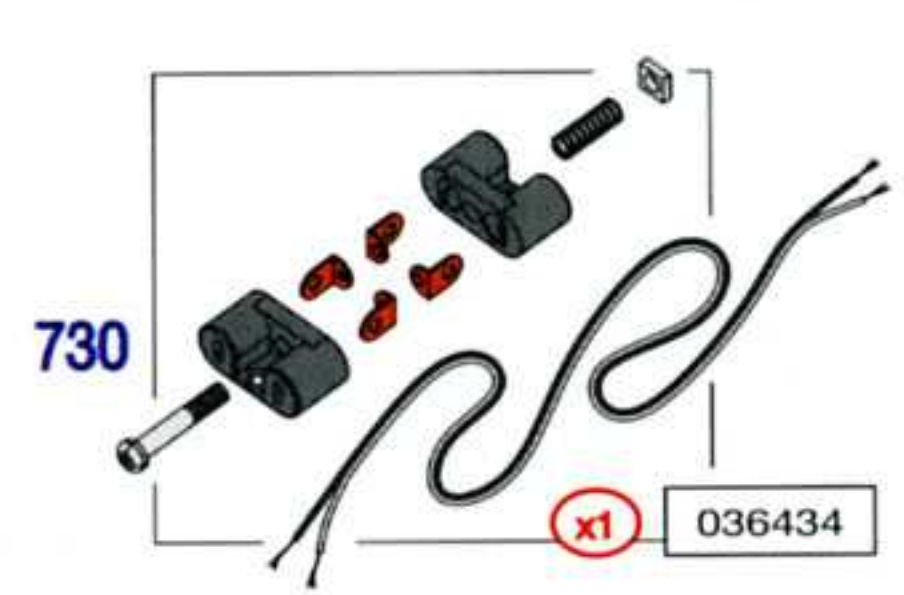
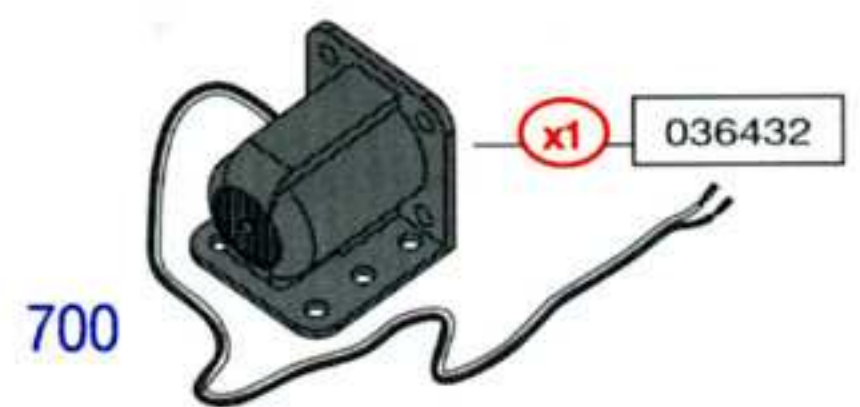



27c x2 036066 95 * Ø 63,5 mm 2 1/2"

27b x2 036065 133 * Ø 90 mm 3 9/16"

27cP x2 036316 95 * Ø 63,5 mm 2 1/2"



27 x2 036063 50 * Ø 33,5 mm 1 3/16"



27a x2 036064 57 * Ø 38 mm 1 1/2"

27d x2 036067 60 * Ø 40 mm 1 9/16"



27aP x2 036607 57 * Ø 38 mm 1 1/2"

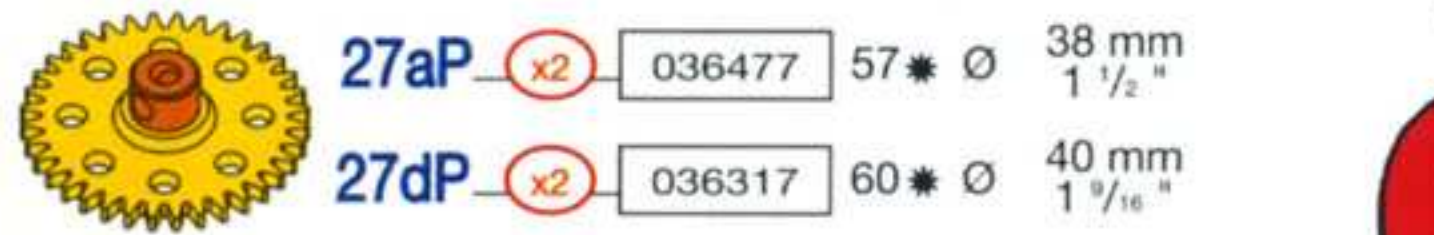

27aP x2 036477 57 * Ø 38 mm 1 1/2"

27dP x2 036317 60 * Ø 40 mm 1 9/16"

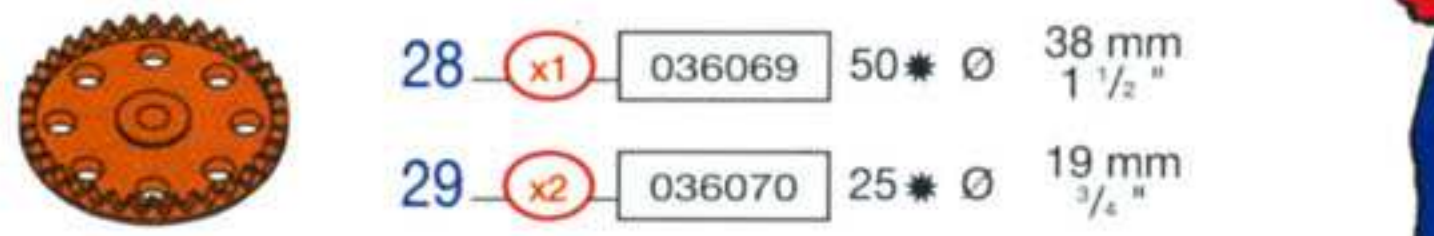

28 x1 036069 50 * Ø 38 mm 1 1/2"

29 x2 036070 25 * Ø 19 mm 3/4"

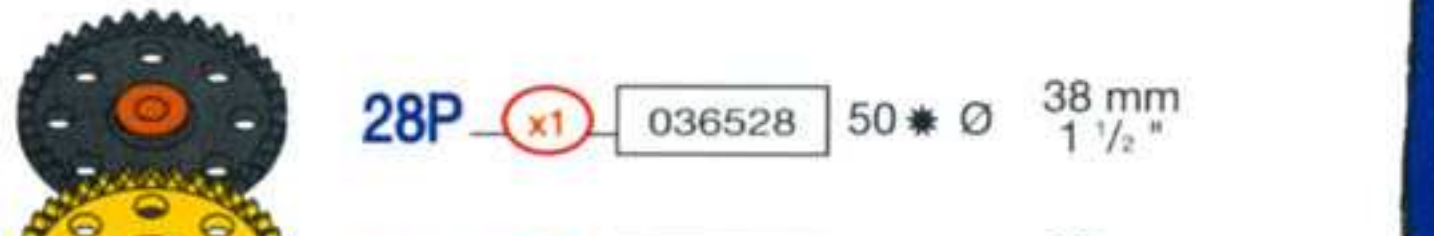

28P x1 036528 50 * Ø 38 mm 1 1/2"

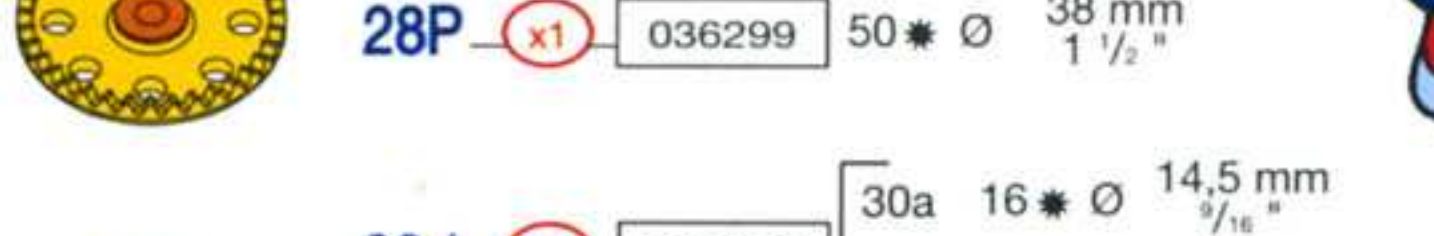

28P x1 036299 50 * Ø 38 mm 1 1/2"

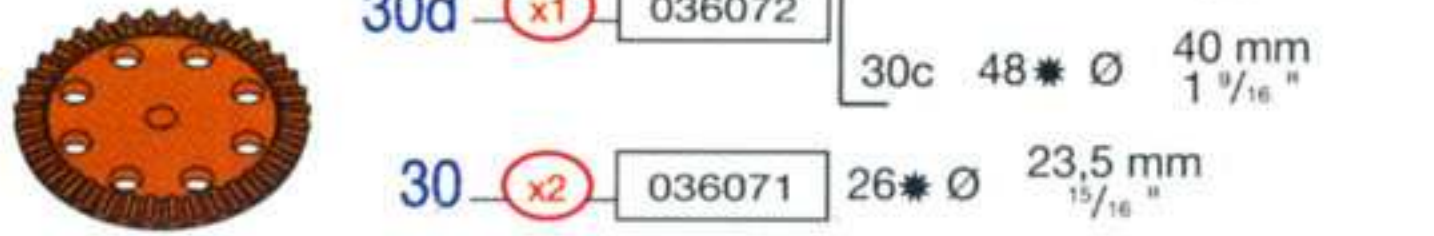

30d x1 036072

- 30a 16 * Ø 14,5 mm 9/16"
- 30c 48 * Ø 40 mm 1 9/16"



30 x2 036071 26 * Ø 23,5 mm 15/16"

Teeth	Dents	Zähne	Dentelli
Tänder	Taender	Hampaat	Dientes
Tanden	Dentes	Δόντια	齒

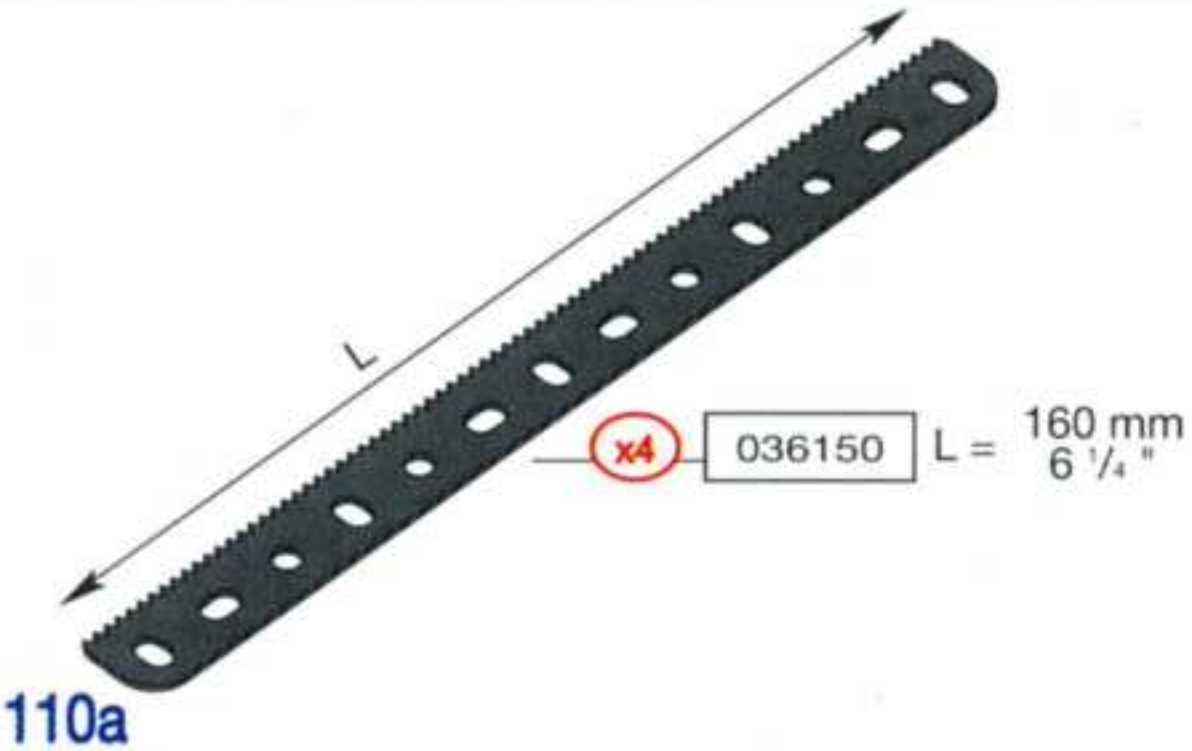

110a x4 036150 L = 160 mm 6 1/4"



25 x2 036057 25 * Ø 19 mm 3/4" L = 6 mm 1/4"

25a x3 036058 25 * Ø 19 mm 3/4" L = 13 mm 1/2"

26 x2 036059 19 * Ø 13 mm 1/2" L = 6 mm 1/4"

26a x3 036060 19 * Ø 13 mm 1/2" L = 13 mm 1/2"

26b x3 036061 19 * Ø 13 mm 1/2" L = 19 mm 3/4"

26c x3 036062 15 * Ø 11 mm 7/16" L = 6 mm 1/4"

31 x2 036073 38 * Ø 25 mm 1" L = 6 mm 1/4"



26P x2 036545 19 * Ø 13 mm 1/2" L = 6 mm 1/4"



26P x2 036616 19 * Ø 13 mm 1/2" L = 6 mm 1/4"



26n x2 036448 11 * Ø 8,7 mm 11/32" L = 6 mm 1/4"



27f x3 036068 14 * Ø 25,4 mm 1"

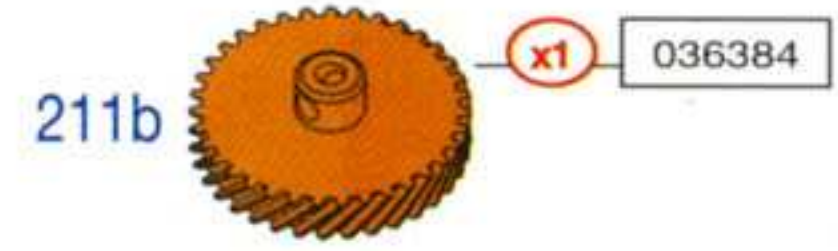

211b x1 036384



211a x1 036383



32 x1 036074



32P x1 036615



32P x1 036419



148 x1 036187



147a x3 036184



147c x3 036186



131 x3 036368



171 x3 036201



140 x2 036175















165 x3 036197



116 x4 036158

GR Πολλά από τα μοντέλα και τα εξαρτήματα είναι μοναδικά και πρωτότυπα σχέδια και αποτελούν ιδιοκτησία της MECCANO A.E. Πολλά από αυτά τα μοντέλα και τα εξαρτήματα προστατεύονται σε πολλές χώρες από το νόμο ως βιομηχανικά σχέδια, εμπορικά σήματα ή/και πνευματική ιδιοκτησία. Το σήμα MECCANO αποτελεί κατοχυρωμένο εμπορικό σήμα της MECCANO A.E. και δεν μπορεί να χρησιμοποιηθεί χωρίς άδεια. Για περισσότερες πληροφορίες, επικοινωνήστε με τη MECCANO S.A.: Διεύθυνση...

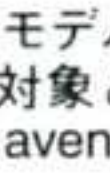
- 116a  x4 036159
- 166  x3 036198
- 63b  x3 036110
- 63  x3 036109
- 63c  x3 036111
- 63d  x2 036447
- 64  x3 036112
- 59  x4 036105
- 144  x1 036180
- 136  x6 036172
- 136a  x6 036173
- 50  x3 036093
- 179  x3 036204
- 173a  x3 036202

- 115a  x6 036388 L= 34 mm 1 5/16"
- 115  x6 036387 L= 15 mm 9/16"
- 147g  x6 036429 L= 23 mm 29/32"
- 147f  x6 036428 L= 19 mm 3/4"
- 147d  x6 036427 L= 14,7 mm 9/10"
- 147b  x12 036185 L= 14,7 mm 9/16"
- 111d  x30 036544 L= 28 mm 1 1/8"
- 111  x30 036541 L= 19 mm 3/4"
- 111a  x30 036542 L= 12 mm 1/2"
- 111c  x30 036543 L= 9,5 mm 3/8"
- 37ab  x50 036536 L= 5,8 mm 15/64"
- 38  x50 036079
- 38a  x25 036420
- 38b  x25 036552
- 38d  x12 036080
-  x12 036478
- 35  x12 036076
- 69a  x12 036115 L= 4 mm 1/32"

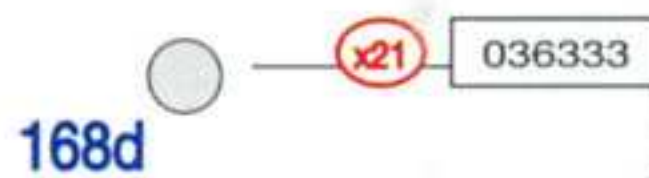
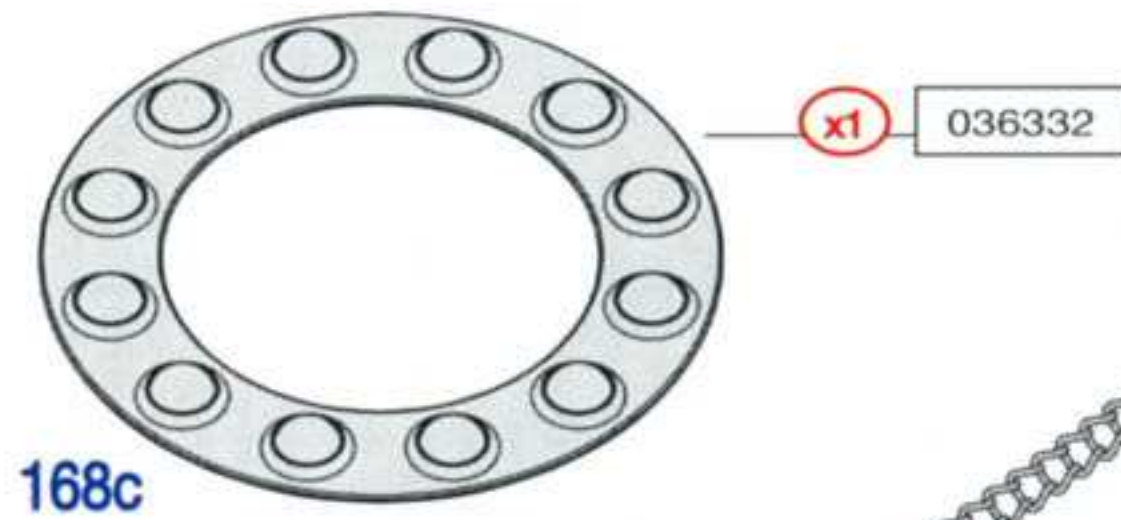
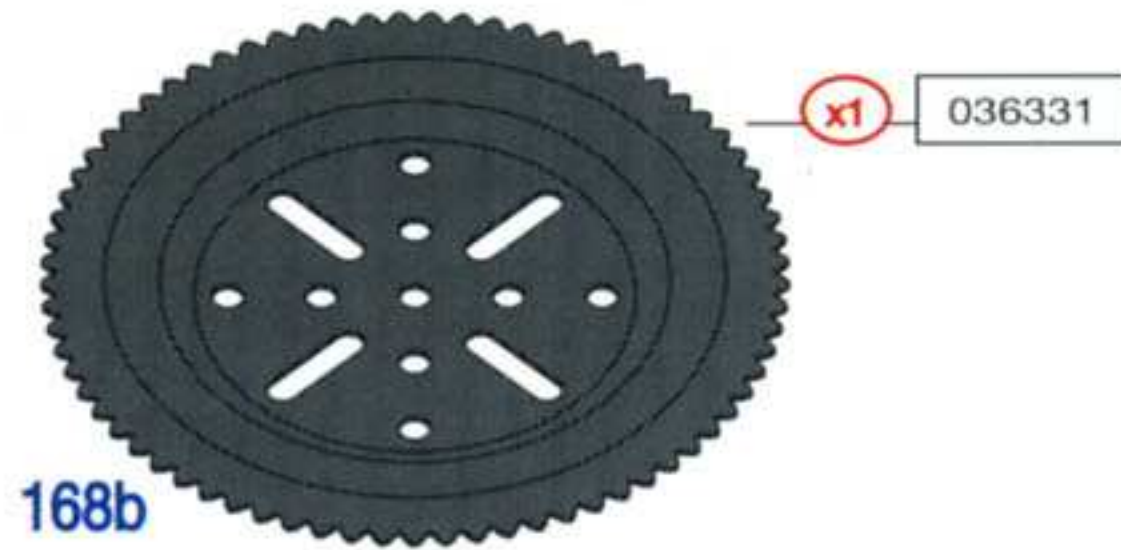
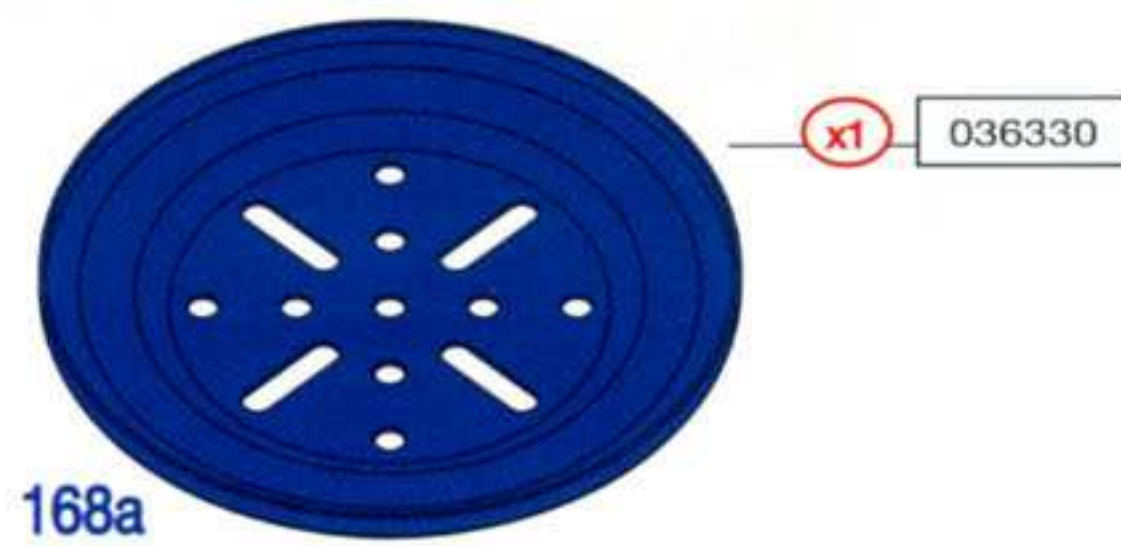

- 213  x6 036237
- 213c  x6 036441
- 23c  x12 036444
- 59a  x12 036556

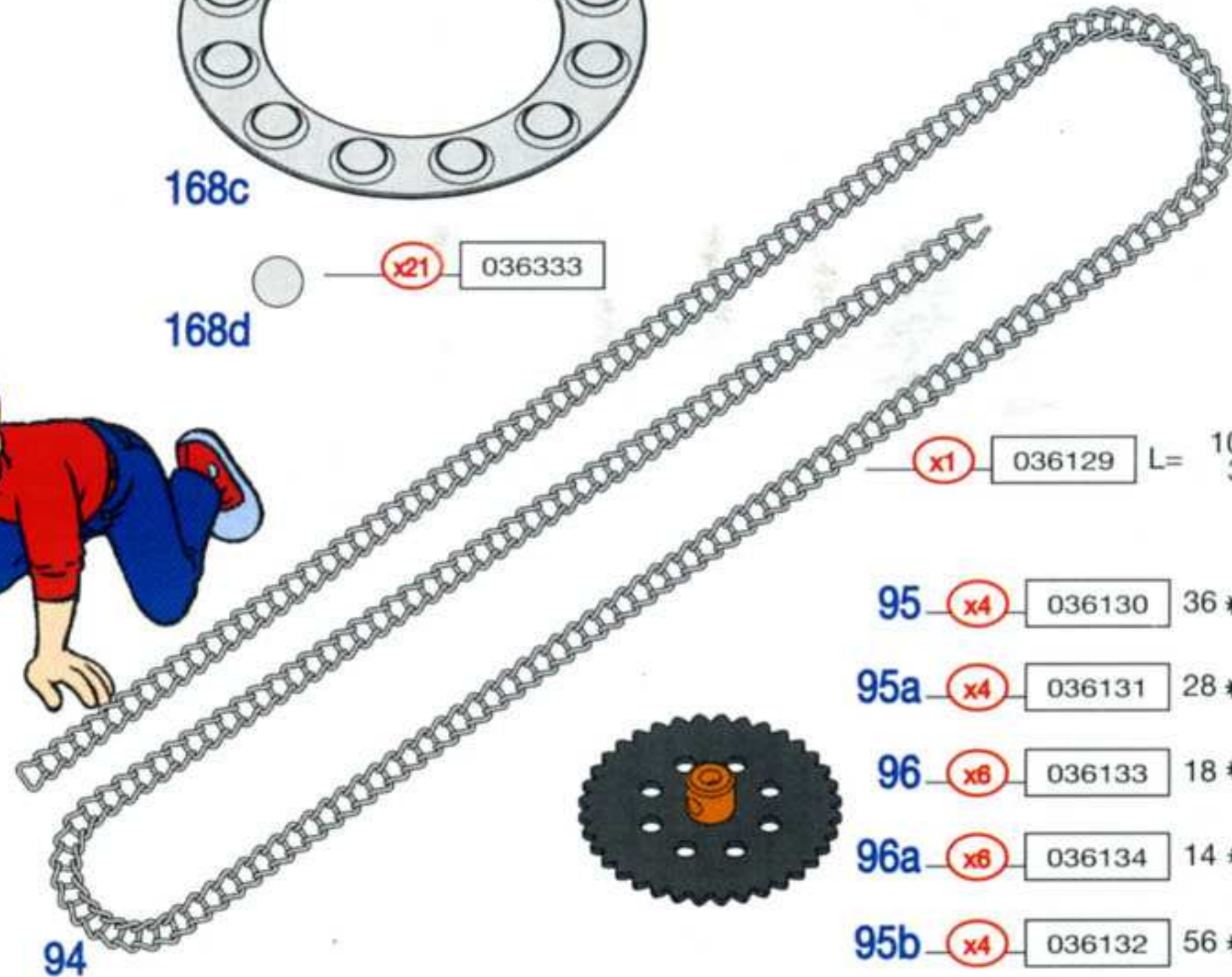

- 95  x4 036130 36 * Ø 50 mm 2"
- 95a  x4 036131 28 * Ø 38 mm 1 1/2"
- 96  x6 036133 18 * Ø 25 mm 1"
- 96a  x6 036134 14 * Ø 19 mm 3/4"
- 95b  x4 036132 56 * Ø 75 mm 3"



C1

x1 031401



C2

x1 031402



C3

x1 031403



C4

x1 031404



C5

x1 031405

(GB) Complementary sets :

Complementary set C2 make a Basic set 2 into a Basic set 3 and so on.

(F) Boite de conversion :

Une boite de conversion C2 , en complément d' un coffret Basic 2 , permet d' obtenir le contenu donc les modèles du coffret Basic 3.

(D) Ergänzungssets :

Das Ergänzungsset C2 erweitert das Basic Set 2 in den Standard des Basic Sets 3 usw.

(I) Set complementari :

Un set complementare C2 permette di trasformare un set Basic 2 in un set Basic 3 e così via.

(S) Kompletteringsatser :

Kompletteringsatser C2 gör ett Basic 2 till ett Basic 3 o.s.v.

(SF) Täydennyssarjat :

Täydennyssarjan C2:n avulla Basic set 2:sta saa Basic set 3:n jne.

(DK) Supplements-æske :

Som supplement til æsken Basic 2 - tilsammen giver de mulighed for at samle modellerne i æsken Basic 3.

(E) Cajas Complementarias :

Uniendo la caja Complementaria C2 con la caja Básica N° 2, se obtiene la caja N° 3 y así sucesivamente.

(NL) Aanvuldozen :

Aanvuldoos C2 maakt samen met basisdoos 2 : basisdoos 3 etc.

(P) Caixas Complementares :

A caixa complementar C2 transforma a Básica N° 2 na Básica N° 3 e assim sucessivamente.

(GR) Σετ μετατροπής :

Σε συνδυασμό με ένα σετ Basic 2, μπορεί το παιδί να αποκτήσει ότι χρειάζεται για την κατασκευή των μοντέλων του σετ Basic 3.

(JPN) レベルアップボックス :

レベルアップボックスで、ベーシックキット2に新たな部品を追加し、ベーシックキット3と同じモデルが作れます。



MO

x1 032231

(GB) Motor set MO allows children to motorise their models.

(F) Coffret MO permettant de motoriser des modèles imaginés par l' enfant.

(D) Das Motor MO Set ermöglicht die Motorisierung des Modelle.

(I) Il set motore MO permette al bambino di motorizzare i modelli realizzati.

(S) Motorsats MO gör det möjligt för barnen att motorisera sina modeller.

(SF) Moottorisarja MO:n avulla rakentaja voi moottoroida mallinsa.

(DK) Med æsken MO kan man motorisere de modeller, barnet har samlet.

(E) El Motor MO permite al niño dar movimiento a sus modelos.

(NL) Met Motor Set MO kunnen Kinderen hun modellen van een motor voorzien.

(P) O Motor MO permite a criança motorizar os seus modelos.

(GR) Το σετ MO περιέχει τους μικρές κινητήρες που επιτρέπουν στο παιδί να δώσει κίνηση σε όποιο μοντέλο φανταστεί.

(JPN) モーターキット MOで、お子さんがイメージしたモデルがモーターで動くようになります。